



# **COM-120C Communications Service Monitor Operation Manual**

**1002-0601-2P0**

# **OPERATION MANUAL**

## **COMMUNICATIONS SERVICE MONITOR**

### **COM-120C**

PUBLISHED BY  
IFR

**COPYRIGHT © IFR 2002**

All rights reserved. No part of this publication may be reproduced, stored in a retrieval system, or transmitted in any form or by any means, electronic, mechanical, photocopying, recording or otherwise without the prior permission of the publisher.

10200 West York / Wichita, Kansas 67215 U.S.A. / (316) 522-4981 / FAX (316) 524-2623

## **CABLE STATEMENT**

Double shielded and properly terminated external interface cables must be used with this equipment when interfacing with the RS-232 and IEEE-488.

For continued EMC compliance, all external cables must be 3 meters or less in length.

## **NOMENCLATURE STATEMENT**

The COM-120C Communications Service Monitor is the official nomenclature for the EMC and Safety compliant COM-120C Communications Service Monitor. In this manual the COM-120C refers to the COM-120C Communications Service Monitor. The generic terms unit and Test Set also refer to the COM-120C Communications Service Monitor.

## **BATTERY STATEMENT**

For continued EMC compliance with EN61000-3-2:1995/A14:2000, always allow a discharged battery to recharge in Stand-by Mode.

## **SAFETY FIRST: TO ALL OPERATIONS PERSONNEL**

**REFER ALL SERVICING OF UNIT TO QUALIFIED TECHNICAL PERSONNEL. THIS UNIT CONTAINS NO OPERATOR SERVICEABLE PARTS.**

### **CASE, COVER OR PANEL REMOVAL**

Removing protective covers, casings or panels from this unit exposes the operator to electrical hazards that can result in electrical shock or equipment damage. Do not operate this unit with the case, cover or panels removed.

### **SAFETY IDENTIFICATION IN TECHNICAL MANUAL**

This manual uses the following terms to draw attention to possible safety hazards, that may exist when operating or servicing this equipment.

**CAUTION:** THIS TERM IDENTIFIES CONDITIONS OR ACTIVITIES THAT, IF IGNORED, CAN RESULT IN EQUIPMENT OR PROPERTY DAMAGE (E.G., FIRE).

**WARNING:** THIS TERM IDENTIFIES CONDITIONS OR ACTIVITIES THAT, IF IGNORED, CAN RESULT IN PERSONAL INJURY OR DEATH.

### **SAFETY SYMBOLS IN MANUALS AND ON UNITS**



**CAUTION:** Refer to accompanying documents.



**AC OR DC TERMINAL:** Terminal that may supply or be supplied with ac or dc voltage.



**DC TERMINAL:** Terminal that may supply or be supplied with dc voltage.



**AC TERMINAL:** Terminal that may supply or be supplied with ac or alternating voltage.



**SWITCH OFF:** AC line power to the device is OFF.



**SWITCH ON:** AC line power to the device is ON.



**DANGEROUS VOLTAGE:** Indicates electrical shock hazard due to high voltage levels.

**CAT II INSTALLATION CATEGORY II:** Denotes impulse withstand voltage of 2500 V.

### **EQUIPMENT GROUNDING PRECAUTION**

Improper grounding of equipment can result in electrical shock.

### **USE OF PROBES**

Check the specifications for the maximum voltage, current and power ratings of any connector on the unit before connecting it with a probe from a terminal device. Be sure the terminal device performs within these specifications before using it for measurement, to prevent electrical shock or damage to the equipment.

### **AC POWER CORD**

AC power cord must not be frayed or broken nor expose bare wiring when operating this equipment.

### **DC POWER CORD**

DC power cord is non-terminated. Care should be taken when connecting to external dc source.

### **USE RECOMMENDED FUSES ONLY**

Use only fuses specifically recommended for the equipment at the specified current and voltage ratings.

### **INTERNAL BATTERY**

This unit contains a Sealed Lead-Acid Battery, see Battery Instructions for servicing.

**CAUTION:** SIGNAL GENERATORS CAN BE A SOURCE OF ELECTROMAGNETIC INTERFERENCE (EMI) TO COMMUNICATION RECEIVERS. SOME TRANSMITTED SIGNALS CAN CAUSE DISRUPTION AND INTERFERENCE TO COMMUNICATION SERVICES OUT TO A DISTANCE OF SEVERAL MILES. USERS OF THIS EQUIPMENT SHOULD SCRUTINIZE ANY OPERATION THAT RESULTS IN RADIATION OF A SIGNAL (DIRECTLY OR INDIRECTLY) AND SHOULD TAKE NECESSARY PRECAUTIONS TO AVOID POTENTIAL COMMUNICATION INTERFERENCE PROBLEMS.

# LIST OF EFFECTIVE PAGES

The manual pages listed below that are affected by a current change or revision, are so identified by a revision number.

Date of Issue for original and changed pages are:

Original ..... 0 ..... Feb 2002

**TOTAL NUMBER OF PAGES IN THIS MANUAL IS 326 CONSISTING OF THE FOLLOWING**

Pg. No.	Rev. No.	Pg. No.	Rev. No.
Title and Copyright.....	0	6-1 through 6-116.....	0
Cable Statement .....	0	A-1 through A-4 .....	0
Safety .....	0	B-1 through B-4 .....	0
A through B .....	0	C-1 through C-2 .....	0
i through x.....	0	D-1 through D-12.....	0
1-1 through 1-24 .....	0	Index-1 through Index-4 .....	0
2-1 through 2-4 .....	0	Battery Title Page.....	0
3-1 through 3-28 .....	0	High Voltage Warning .....	0
4-1 through 4-72 .....	0	ESD Caution Page .....	0
5-1 through 5-30 .....	0	Page 1 through Page 4.....	0

THIS PAGE INTENTIONALLY LEFT BLANK.

## SCOPE

This manual contains instructions for operating the COM-120C Communications Service Monitor. The instruction level is relatively basic and presupposes no previous experience on the part of the operator with a communication service monitor of this type. A basic understanding of communication electronics and practical troubleshooting methods is helpful. It is strongly recommended that the operator be thoroughly familiar with this manual before attempting to operate the unit.

## ORGANIZATION

The COM-120C Operation Manual is composed of the following sections:

### SECTION 1 - INTRODUCTION

Provides an introduction to the unit and a brief overview of unit functions. Specifications are also included in this section.

### SECTION 2 - INSTALLATION

Provides a step-by-step procedure for placing the COM-120C into operation.

### SECTION 3 - CONTROLS, CONNECTORS AND INDICATORS

Identifies and functionally describes all COM-120C controls, connectors and indicators. All Operation Screens and Menus are identified and available parameters listed and explained.

### SECTION 4 - OPERATION

Provides instructions for operating the COM-120C Mode Operating Screens and Menus. In addition, this section contains a selection of basic operating procedures pertaining to all major functions of the Test Set.

### SECTION 5 - COMMON PRACTICES

Identifies and presents some examples of common practices the operator can use to help become familiar with the COM-120C operation.

### SECTION 6 - OPTIONS

Identifies and provides instructions for operating the options available with the COM-120C.



# TABLE OF CONTENTS

## SECTION 1 - INTRODUCTION

Paragraph	Title	Page
1-1	General.....	1-1
1-2	RF Generate Operation.....	1-2
1-3	RF Receive Operation.....	1-3
1-4	Duplex Operation .....	1-4
1-5	Audio Function Generators.....	1-5
1-6	Oscilloscope .....	1-6
1-7	Spectrum Analyzer .....	1-7
1-8	Meters .....	1-9
1-9	Options .....	1-10
1-10	COM-120C Product Specifications.....	1-11

## SECTION 2 - INSTALLATION

Paragraph	Title	Page
2-1	General.....	2-1
2-2	Precautions .....	2-1
2-3	Power Up Procedures .....	2-3
2-3-1	Applying AC Power.....	2-3
2-3-2	Applying External DC Power.....	2-3
2-3-3	Battery Power Operation (Option 01).....	2-3

## SECTION 3 - COMPOSITE

Paragraph	Title	Page
3-1	Front Panel Controls.....	3-1
3-2	Rear Panel Controls .....	3-7
3-3	Screens, Soft Function Keys and Menus .....	3-9

## SECTION 3 – COMPOSITE (CONT)

Paragraph	Title	Page
3-3-1	Soft Function Keys .....	3-9
3-3-2	Cursor Movement .....	3-9
3-3-3	Editing Fields Using Data Scroll Keys and Spinner.....	3-9
3-3-4	Editing Numeric Data Fields .....	3-11
3-3-5	Making Selections From Menus.....	3-11
3-3-6	Escaping From Edit Without Change.....	3-11
3-3-7	RF Generate Screen .....	3-12
3-3-8	RF Receive Screen.....	3-14
3-3-9	Duplex Screen.....	3-17
3-3-10	Oscilloscope Screen .....	3-20
3-3-11	Spectrum Analyzer Screen .....	3-22
3-3-12	Audio/Data/Signaling Generators Screen .....	3-24
3-3-13	Meter Screens.....	3-25
3-3-14	Memory Lists and Storage of Parameters .....	3-26
3-3-15	Utility Function Screens .....	3-27

## SECTION 4 - OPERATION

Paragraph	Title	Page
4-1	RF Generate Operation .....	4-1
4-1-1	General RF Generate Operation.....	4-1
4-1-2	SINAD Meter Operation.....	4-13
4-1-3	Distortion Meter Operation .....	4-16
4-1-4	Audio Frequency Level Meter Operation .....	4-18
4-1-5	Oscilloscope Operation Screen .....	4-20
4-1-6	Spectrum Analyzer Operation Screen .....	4-25
4-1-7	Store And Recall Operation .....	4-29

## SECTION 4 - OPERATION (CONT)

Paragraph	Title	Page
4-2	RF Receive Operation.....	4-31
4-2-1	General RF Receive Operation .....	4-31
4-2-2	SINAD Meter Operation.....	4-38
4-2-3	Distortion Meter Operation .....	4-38
4-2-4	FM Deviation Meter Operation .....	4-39
4-2-5	AM Modulation Meter Operation.....	4-41
4-2-6	Phase Modulation Meter Operation.....	4-43
4-2-7	RF Power Meter Operation .....	4-45
4-2-8	Received Level Meter Operation .....	4-47
4-2-9	RF Frequency Error Meter Operation.....	4-49
4-2-10	Audio Frequency Counter.....	4-51
4-2-11	Oscilloscope Operation Screen .....	4-53
4-2-12	Distortion Meter .....	4-53
4-2-13	Store And Recall Operation .....	4-53
4-3	Duplex Operation .....	4-54
4-3-1	General Duplex Generate Operation.....	4-54
4-3-2	General Duplex Receive Operation.....	4-59
4-4	Independent Oscilloscope Operation Screen .....	4-62
4-5	Independent Spectrum Analyzer Operation Screen.....	4-62
4-6	Independent Audio/Data/Signaling Generators.....	4-63
4-6-1	Audio Generator-1 Operation.....	4-63
4-6-2	Audio Generator-2 Operation.....	4-66
4-6-3	Data Generator Operation .....	4-67
4-6-4	DTMF Generator Operation .....	4-68

## SECTION 4 - OPERATION (CONT)

Paragraph	Title	Page
4-7	Meters Operation.....	4-69
4-7-1	Digital Voltmeter Operation .....	4-69

## SECTION 5 - COMMON PRACTICES

Paragraph	Title	Page
5-1	RF Generate .....	5-1
5-1-1	Generating FM Modulated RF Signal .....	5-2
5-1-2	Generating AM Modulated RF Signal .....	5-4
5-1-3	Generating PM Modulated RF Signal .....	5-6
5-1-4	Generating DCS Coded RF Signal.....	5-8
5-1-5	Generating DTMF Coded RF Signal.....	5-10
5-1-6	Generating RF Signal Using External Modulation .....	5-12
5-1-7	Generating Microphone Modulated RF Signal .....	5-14
5-1-8	Encoding 2-Tone Sequential Format.....	5-16
5-2	RF Receive.....	5-19
5-2-1	Receiving FM Modulated RF Signal .....	5-20
5-2-2	Receiving AM Modulated RF Signal .....	5-22
5-2-3	Receiving PM Modulated RF Signal .....	5-24
5-2-4	Decoding 2-Tone Sequential Format.....	5-26
5-3	Duplex.....	5-28

## SECTION 6 - OPTIONS

Paragraph	Title	Page
6-1	Internal Battery (Option 01).....	6-1
6-2	Oven Crystal Oscillator Frequency Standard (Option 02).....	6-1
6-3	30 kHz IF Filter (Option 03).....	6-1
6-4	Variable Audio Generator 2 (Option 04).....	6-1
6-5	Generate Amplifier (Option 05).....	6-1
6-6	Data Generator/Bit Error Rate (BER) Meter (Option 07).....	6-2
6-6-1	BER Meter Configuration Section.....	6-4
6-6-2	Receive Data Configuration Section.....	6-6
6-6-3	Send Data Configuration Section.....	6-8
6-7	Single Sideband Receive Filter (Option 08).....	6-9
6-7-1	General.....	6-9
6-7-2	Description of Receive Function.....	6-9
6-8	RCC Signaling Formats (Option 09).....	6-10
6-9	Audio/Digital Signaling Formats (Option 11).....	6-10
6-9-1	Modulating RF Signals with Digital Signaling Formats.....	6-13
6-9-2	Encoding Digital Signaling Formats For Audio Signal.....	6-15
6-9-3	Decoding Digital Signaling Formats.....	6-16
6-9-4	Testing A Receiver Using Digital Signaling Formats.....	6-17
6-9-5	Testing A Transmitter Using Digital Signaling Formats.....	6-18
6-10	Spectrum Analyzer Tracking Generator (Option 12).....	6-19
6-11	IEEE-488 (GPIB) Interface (Option 13).....	6-20
6-11-1	General.....	6-20
6-11-2	Configuring For Remote Operations Using GPIB.....	6-20
6-12	Clearchannel LTR® (Option 14).....	6-21

## SECTION 6 - OPTIONS (CONT)

Paragraph	Title	Page
6-12-1	General .....	6-21
6-12-2	Accessing The Clearchannel LTR® Trunking Test System .....	6-22
6-12-3	LTR Trunking Repeater Simulation .....	6-23
6-12-4	Transmit Trunking Data Block .....	6-27
6-12-5	Receive Trunking Data Block .....	6-28
6-12-6	LTR Trunking Radio Simulation .....	6-29
6-12-7	Transmit Trunking Data Block .....	6-33
6-12-8	Receive Trunking Data Block .....	6-34
6-12-9	LTR Trunking Auxiliary Setup Screen .....	6-35
6-12-10	Auxiliary Setup Screen Configuration.....	6-37
6-12-11	Repeater Simulator Operation.....	6-38
6-12-12	LTR Radio Handshake Test .....	6-40
6-12-13	LTR Radio Handoff Test.....	6-41
6-12-14	LTR Radio Receive Test.....	6-42
6-12-15	Radio Simulator Operation .....	6-43
6-12-16	LTR Repeater Handshake Test .....	6-45
6-13	AMPS Cellular Testing (Option 15) .....	6-46
6-13-1	AMPS Cell Site Simulator Setup.....	6-46
6-13-2	AMPS Cell Site Simulator Main and Setup Menus .....	6-47
6-13-3	AMPS Cell Site Simulator Automatic Tests .....	6-52
6-13-4	Registration Test.....	6-53
6-13-5	Handoff Test .....	6-57
6-13-6	Audio Test .....	6-58
6-13-7	Mobile Init Test .....	6-59

## SECTION 6 - OPTIONS (CONT)

Paragraph	Title	Page
6-13-8	Cell Init Test.....	6-60
6-13-9	Automatic Test Printout.....	6-61
6-13-10	AMPS Cell Site Simulator Manual Tests.....	6-62
6-13-11	Registration Test.....	6-63
6-13-12	Mobile Init Test.....	6-64
6-13-13	Cell Init Test.....	6-67
6-14	EDACS Trunking (Option 16).....	6-70
6-14-1	EDACS Trunking Setup Screen.....	6-71
6-14-2	EDACS Trunking Channel Assignments.....	6-72
6-14-3	EDACS Trunking Automatic Test.....	6-73
6-14-4	EDACS Trunking Automatic Test Execution.....	6-74
6-14-5	EDACS Trunking Automatic Test Results.....	6-76
6-14-6	EDACS Trunking Manual Test.....	6-82
6-14-7	EDACS Trunking Manual Test-Repeater Simulator.....	6-83
6-14-8	EDACS Trunking Manual Test-Radio Simulator.....	6-88
6-14-9	EDACS High-Speed Data Capture (Scope).....	6-93
6-14-10	EDACS Store and Recall.....	6-94
6-14-11	EDACS Trunking Operational Notes.....	6-95
6-15	MPT 1327 Trunking (Option 17).....	6-96
6-15-1	Setup Network Definition.....	6-97
6-15-2	Syscode Calculation.....	6-99
6-15-3	Channel Numbering.....	6-100
6-15-4	Base Frequencies.....	6-101
6-15-5	Trunking Simulator Screens.....	6-102

## SECTION 6 - OPTIONS (CONT)

Paragraph	Title	Page
6-15-6	Repeater Simulator.....	6-104
6-15-7	Testing Radio Units .....	6-105
6-15-8	MPT 1327/ MPT 1343 Numbering Schemes .....	6-106
6-15-9	Radio Simulator.....	6-107
6-15-10	Automatic Test Mode, Test Selection .....	6-108
6-15-11	Parametric Limits .....	6-110
6-15-12	Test Execution .....	6-112
6-15-13	Parametric Results .....	6-113
6-15-14	Off-Air Monitor .....	6-114

## APPENDICES

Appendix	Title	Page
Appendix A	User I/O Connectors and Pin-Out Table .....	A-1
Appendix B	Abbreviations .....	B-1
Appendix C	Repacking For Shipping .....	C-1
Appendix D	Soft Function Keys .....	D-1

## INDEX

### BATTERY/ VOLTAGE/ FUSE INSTRUCTIONS

Title	Page
Power Source Requirement.....	Page-1
AC Fuse Replacement .....	Page-1
DC Fuse Replacement.....	Page-2
Battery Replacement .....	Page-2
Battery Fuse Replacement.....	Page-4



THIS PAGE INTENTIONALLY LEFT BLANK.

# SECTION 1

## INTRODUCTION

---

### 1-1 GENERAL

The COM-120C is a microprocessor controlled, digitally synthesized communication service monitor, which combines the operations of many different test instruments into a single, compact unit. The COM-120C is capable of performing these functions:

RF Generator	RF Receiver
Full Duplex Operation	Spectrum Analyzer
Audio/Data/Signaling Generators	Oscilloscope
DVM	Deviation Meter
Distortion Meter	SINAD Meter
Audio Frequency Meter	Frequency Error Meter
RF Power Meter	Modulation Meter
Received Level Meter	

The COM-120C utilizes an alphanumeric keypad, dedicated function keys, multitask "Soft" Function Keys and a high resolution, monochrome flat panel display. Perform tests remotely or manually. Microprocessor controlled memory allows parameter storage and recall. For instance, store and recall Oscilloscope and Spectrum Analyzer traces for signal comparison.

The COM-120C performs a multitude of important functions simultaneously. The three basic modes of operation are: RF Generate Operation, RF Receive Operation and Duplex Operation. These modes allow generate and receive functions in duplex and simplex mode, while testing other aspects of the Unit Under Test like Modulation Level, Power, Sensitivity and Frequency Error.

Additionally, the COM-120C provides these independent test instruments:

Audio/Data/Signaling Generators
Oscilloscope
Spectrum Analyzer
Meters

# SECTION 1

## INTRODUCTION

---

### 1-2 RF GENERATE OPERATION

#### Generating

The COM-120C is capable of generating CW or modulated signals from 250 kHz to 1000 MHz.

The output level is variable from -130 to -13 dBm.

Modulation types include AM, FM and PM (Phase Modulation) or apply an external modulation source. Generate DTMF, User Defined Tone Codes or Digital Codes.

#### Meters

Metering functions include SINAD, Distortion and Audio Frequency Level.

Full Oscilloscope and Spectrum Analyzer operation is available.

#### Testing

Testing in RF Generate Operation includes Receiver Sensitivity, Receiver Selectivity, and Audio Frequency Level measurements.



Use the decode capability for defined DCS and POCSAG protocols using the Tone and Digital Coding functions.

### 1-3 RF RECEIVE OPERATION

#### Receiving

The COM-120C receives CW and modulated signals ranging from 250 kHz to 1000 MHz.

In addition to single frequency operation, the COM-120C demodulates and detects AM, FM and PM modulated signals and executes defined frequency sweep operations by scanning a range of predetermined Frequency List settings.

The COM-120C receives “off-the-air” signals via the Antenna Connector or connects directly to the Unit Under Test via the T/R Connector.

#### Meters

Receive Operation Metering functions include RF Power, AM Modulation, FM Deviation, Phase Modulation, Distortion, Frequency Error, AF Frequency, Received Level and SINAD.

Full Oscilloscope and Spectrum Analyzer operation is available.

#### Testing

Testing in RF Receive Operation includes measuring Carrier Power, Modulation, Distortion, SINAD and RF Frequency Error.



Use the independent Audio/Data/Signaling Generators to modulate the Unit Under Test when performing RF Receive Operation.

# SECTION 1

## INTRODUCTION

---

### 1-4 DUPLEX OPERATION

The COM-120C Duplex Operation feature ranges from 250 kHz to 1000 MHz.

The RF Generator and RF Receiver both work in Duplex Operation Mode with the added capacity of using offset frequencies up to  $\pm 999.7500$  MHz. Testing capabilities mirror those found in RF Generate and RF Receive Operations.

Duplex Operation is composed of three Operation Screens.

- The Duplex Operation Screen contains both Receive and Generate information.
- The Duplex Receive Operation Screen is provided to test the Transmit section of the Unit Under Test.
- The Duplex Generate Operation Screen is provided to test the Receive section of the Unit Under Test.

### 1-5 AUDIO FUNCTION GENERATORS

#### **Audio/Tone Coding**

The COM-120C has two Audio Generators. One generator has a range of 10 Hz through 20 kHz and the second generator has a fixed 1 kHz tone. The waveforms are sine, square, triangle and ramp.

#### **DATA**

The DATA Generator generates in DCS, DCS Inverted, POCSAG and POCSAG Inverted formats.

#### **DTMF**

The DTMF Generator generates DTMF coding, up to 16 characters long, in Burst, Continuous Mode or configures the DATA ENTRY Keypad as a DTMF Keypad. The DTMF Mark and Space timing and the time between string transmissions are programmable.

# SECTION 1

## INTRODUCTION

---

### 1-6 OSCILLOSCOPE

The COM-120C has a 50 kHz single trace Oscilloscope. The Oscilloscope can operate as a dependent or independent function in each of the Operation Modes. Both functions give the choice of operation modes, live, store, recall, compare and average. The Trigger type choices are Normalized, Auto and One Shot.

#### **Dependent**

The dependent Oscilloscope is available with meters and shares space in all Operation Modes with the dependent Spectrum Analyzer. In Generate Operation, sources available for the Oscilloscope are through front panel input connectors, Notch Filter Residual and internal modulation sources. In Receive Operation, sources available for the Oscilloscope are through the front panel input connectors, Audio/Data/Signaling Generators, decode lines, meter lines and the demodulated signal, both filtered and unfiltered. Sweep and scale values differ with each input type.

#### **Independent**

The independent Oscilloscope only accepts signals from the SCOPE/DVM Connector. The coupling choices are AC, DC and Ground.

### 1-7 SPECTRUM ANALYZER

The Spectrum Analyzer monitors internal and external signals ranging from 250 kHz to 1000 MHz. The Scan width range is editable from 1 kHz to 100 MHz per/div. The Sweep rate and Resolution Band Width (RBW) are editable with a menu or manual edit. An UNCAL indication appears on the screen when settings cause an analyzer "uncal" situation.

The log scales are 2 and 10 dB per division. Amplitude scale units of dBm, dB $\mu$ V, dBmV, dBV, dB $\mu$ W and dBW are available in the Independent Spectrum Analyzer and with the Receive Operation. The Generate Spectrum Analyzer is a relative measuring device only. Available units are limited to dB.

Memory functions for the Spectrum Analyzer include store and recall of a trace, compare a stored trace to a live trace and peak hold. The Slot number is editable.

External signals can be "off the air" through the Antenna Connector or connected directly to the T/R Connector.

The Independent and Receive Function Spectrum Analyzer have attenuation of 0 and 30 dB through both connectors. The Spectrum Analyzer is available for display alone or with all RF Generate and Receive functions except where the Duplex Transmit and Receive functions are shown simultaneously.



# SECTION 1

## INTRODUCTION

---

### **Generate Operation**

The Generate Operation Spectrum Analyzer is a relative measuring device only and available units are limited to dB. Scan widths range from 1 kHz to 100 MHz per/div and zero scan. Available log scales are 2 and 10 dB per division. Memory functions for the Spectrum Analyzer include store and recall of a trace, compare a stored trace to a live trace and peak hold.

### **Receive Operation**

The Receive Operation Spectrum Analyzer receives signals ranging from 250 kHz to 1000 MHz. Scan widths range from 1 kHz to 100 MHz per/div and zero scan. Available log scales are 2 and 10 dB per division. Amplitude scale units are dBm, dB $\mu$ V, dBmV, dBV, dB $\mu$ W and dBW. Memory functions for the Spectrum Analyzer include store and recall of a trace, compare a stored trace to a live trace and peak hold. Input signals can be "off the air" through the Antenna Connector or connected directly to the T/R Connector. The Spectrum Analyzer has 0 and 30 dB attenuation available through both connectors.

### **Independent**

The Independent Spectrum Analyzer receives signals ranging from 250 kHz to 1000 MHz. Scan widths range from 1 kHz to 100 MHz per/div and zero scan. The log scales are 2 and 10 dB per division. Amplitude scale units are dBm, dB $\mu$ V, dBmV, dBV, dB $\mu$ W and dBW are available. Memory functions for the Spectrum Analyzer include store and recall of a trace, compare a stored trace to a live trace and peak hold.

Input signals can be "off the air" through the Antenna Connector or connected directly to the T/R Connector. The Spectrum Analyzer has 0 and 30 dB attenuation available through both connectors. Additional Functions available with the Independent Spectrum Analyzer include a Find function for finding signals above a certain level and split screen displaying two Spectrum Analyzer screens.

# SECTION 1

## INTRODUCTION

---

### 1-8 METERS

#### Dependent

The COM-120C provides metering capability in all three Operation Modes. The meters are in Receive Operation, Generate Operation or both. The meters are available for Simplex and Duplex Operation. The meters are represented directly on the Mode Operation Screen as numeric readout or as a bar meter and numeric readout. Although a meter is available in both Receive and Generate Operation, available inputs may differ. Dependent Meters for each Operation Mode are identified below:

RECEIVE OPERATION	GENERATE OPERATION
SINAD	SINAD
FM Deviation	Distortion
Phase Modulation	Audio Level
Received Level	
Audio Counter	

#### Independent

The COM-120C provides metering capability independent of the Operation Modes. These meters include:

SINAD	Audio Counter
Distortion	Digital Voltmeter

# SECTION 1

## INTRODUCTION

---

### 1-9 OPTIONS

<b>Option 01 – Internal Battery</b>	Provides self-contained dc power when external ac or dc power is unavailable.
<b>Option 02 – 0.01 OCXO</b>	Replaces the standard TCXO as system time base. Provides $0.01 \times 10^6$ accuracy.
<b>Option 03 – 30 kHz IF Filter</b>	This option provides additional band limiting between 15 kHz and 300 kHz offered in a standard set.
<b>Option 04 – Variable Audio Generator 2</b>	Replaces standard fixed 1 kHz Audio Generator with variable frequency Audio Generator.
<b>Option 05 – Generate Amplifier</b>	Internal RF Amplifier providing 26 dB gain for additional RF output.
<b>Option 07 – Data Generator/Bit Error Rate (BER) Meter</b>	This option provides testing for digital characteristics of transceivers.
<b>Option 08 – SSB Receive Filter</b>	This option provides ability to monitor SSB signals.
<b>Option 09 – RCC Signaling</b>	This option provides 10 PS, 20 PS, MTS, IMTS and Tone Remote Control signaling.
<b>Option 11 – Audio/Digital Signaling</b>	This option provides encode/ decode capabilities for the formats: CCIR, CCIRH, CCIRH4, EEA, EIA, NATEL, ZVEI, DZVEI, DDZVEI, EURO, 5/6 Tone and POCSAG.
<b>Option 12 - Tracking Generator</b>	This option provides internal Tracking Generator for use with Spectrum Analyzer.
<b>Option 13 - IEEE 488 (GPIB) Interface</b>	This option provides parallel GPIB interface for remote operation.
<b>Option 14 - CLEARCHANNEL LTR<sup>®</sup></b>	Simulates the CLEARCHANNEL LTR <sup>®</sup> repeater system. CLEARCHANNEL LTR <sup>®</sup> is a Registered Trademark of E. F. Johnson.
<b>Option 15 - AMPS Mobile Station Test</b>	Auto and manual test to verify operation of AMPS mobiles, transportables and portables.
<b>Option 16 - EDACS</b>	Provides test capability for EDACS repeaters and mobiles

# SECTION 1

## INTRODUCTION

### 1-10 COM-120C PRODUCT SPECIFICATIONS

A warm-up time of 5 minutes is required for the following performance requirements.

RF measurements are referenced to 50  $\Omega$ .

Accuracy and Resolution stated in percent are referenced to measured or selected value unless otherwise stated.

Where resolution exceeds accuracy, resolution takes precedence.

Specifications and features are subject to change without notice.

<b>RF SIGNAL GENERATOR</b>	
<b>Frequency</b>	
Range:	250 kHz to 1 GHz
Resolution:	100 Hz
Accuracy:	<i>Same as Master Oscillator.</i>
<b>Output (T/R and AUX RF Connectors)</b>	
Range (T/R):	-130 to -20 dBm (Simplex Mode) -130 to -40 dBm (Duplex Mode)
Range (AUX):	-130 to +13 dBm
Resolution:	0.1 dB
Accuracy:	$\pm 2$ dB (>-90.1 dBm, <400 MHz) $\pm 2.5$ dB otherwise
VSWR:	<1.15:1 (0.25 to $\leq$ 100 MHz) <1.23:1 (100 to $\leq$ 400 MHz) <1.38:1 (400 MHz to 1 GHz)
<b>Spectral Purity</b>	
Residual FM:	<20 Hz RMS (0.3 to 3 kHz BW)
Residual AM:	<0.5% RMS (0.3 to 3 kHz BW)
Harmonics:	<-26 dBc
Non Harmonics:	<-45 dBc (below 1 GHz) <-40 dBc (above 1 GHz)
<b>Input Protection</b>	
(T/R):	50 W CW continuous 100 W CW (90 sec to 3 min) 150 W CW (30 sec to 3 min) 200 W CW (15 sec to 3 min)

# SECTION 1

## INTRODUCTION

<b>MODULATION</b>	
<b>Frequency Modulation</b>	
RF Frequency Range:	250 Hz to 1 GHz
Deviation Range:	100 Hz to 100 kHz
Deviation Resolution:	10 Hz (0.01 to 2.55 kHz) 50 Hz (2.60 to 12.75 kHz) 100 Hz (12.8 to 25.5 kHz) 500 Hz (26.0 to 100.0 kHz)
Rate:	10 Hz to 20 kHz (FSK rates up to 40 kbps)
Accuracy:	±5% + Residual FM + Resolution (1 kHz rate, GEN1, GEN 2, EXT MOD) ±10% + Residual FM + Resolution (DATA GEN) ±15% + Residual FM + Resolution (DTMF GEN)
Distortion:	<2% (1 kHz sine wave, 10 kHz deviation, 0.3 to 3 kHz BW)
EXT MOD Sensitivity:	2 kHz/Vpk ±15% (FM Narrow)
<b>Amplitude Modulation</b>	
RF Frequency Range:	250 kHz to 1 GHz
AM Depth Range:	30% to 90%
Resolution:	0.5%
Rate:	100 Hz to 10 kHz
Accuracy:	±5% + Residual AM + Resolution (1 kHz rate, RF Level <0 dBm) ±15% + Residual AM + Resolution (RF Level <0 dBm)
Distortion:	<2% (30% to 90% modulation, 1 kHz rate, 0.3 to 3 kHz BW)
EXT MOD Sensitivity:	5% to 15% per Vpk

# SECTION 1

## INTRODUCTION

Phase Modulation	
RF Frequency Range:	250 kHz to 1 GHz
Modulation Range:	0.1 to 10 rad peak
Resolution:	0.01 rad (<2.55 rad)
Rate:	100 Hz to 6 kHz
Accuracy:	±5% + Residual PM + Resolution (1 kHz rate) ±15% + Residual PM + Resolution (DTMF GEN)
EXT MOD Sensitivity:	2 rad/Vpk, ±15%
AUDIO/DATA GENERATORS	
AF GENERATOR	
Frequency Range:	5 Hz to 20 kHz (sinewave only) 5 Hz to 10 kHz (other wave shapes)
Frequency Resolution:	0.1 Hz
Frequency Accuracy:	<i>Same as Master Oscillator, ±0.1 Hz</i>
Output Range:	
High Level:	0.01 to 2.5 Vpk (into 150 Ω)
Low Level:	1 to 250 mVpk (into 150 Ω)
Output Resolution:	
High Level:	0.01 Vpk
Low Level:	0.1 mV
Output Accuracy:	
High Level:	±3% full range ±5 mVpk (≤10 kHz, ≥0.03 Vpk) ±7% full range ±5 mVpk (>10 kHz, ≥0.03 Vpk)
Low Level:	±4% full range ±0.25 mVpk (≤10 kHz, 0.03 Vpk) < level, ≥1 mVpk ±7% full range ±0.25 mVpk (>10 kHz, 0.03 Vpk < level, ≥1 mVpk)
THD:	<0.7% (1 kHz sinewave, 2.5 Vpk, 150 Ω Load) <1% sinewave (all other frequencies/ levels)
Wave Shapes:	Sine, Ramp, Square, Triangl

# SECTION 1

## INTRODUCTION

---

A.F. GENERATOR #2	
Frequency Range:	1 kHz (sine wave)
Frequency Accuracy:	±0.2 Hz
Output Range (High Lvl):	0.01 to 2.5 Vpk (into 150 Ω)
Output Resolution (High Lvl):	0.01 Vpk
Output Accuracy (High Lvl):	±3% full range ±5 mVpk (≥0.03 Vpk)
Output Range (Low Lvl):	1 to 250 mVpk (into 150 Ω)
Output Resolution (Low Lvl):	1 mV
Output Accuracy (Low Lvl):	±4% full range ±0.25 mVpk (0.03 Vpk <level 1 mVpk)
DTMF GENERATOR	
Output Range:	
High Level:	0.01 to 2.5 Vpk (into 150 Ω)
Low Level:	0.1 to 25 mVpk (into 150 Ω)
Output Resolution:	
High Level:	0.01 Vpk
Low Level:	1 mVpk
Output Accuracy	
High Level:	±10% full range ±5 mVpk (1 to 30 mV)
Low Level:	±10% full range ±0.25 mVpk (≥30 mV)
Modes:	Continuous, Single Shot
Digits:	16 (0-9, *, #, A, B, C, D)
Mark/Space Timing:	25 to 999 ms
Resolution:	1 ms
Accuracy:	±20%

# SECTION 1

## INTRODUCTION

<b>RECEIVER</b>									
<b>Frequency</b>									
Range:	250 kHz to 1 GHz								
Resolution:	100 Hz								
Tunable Range:	Tunable from 100 Hz to 1.0 GHz (characteristics below 250 kHz are not specified)								
Sensitivity:	2 $\mu$ V (10 dB SINAD, >2 MHz, 1 kHz tone, 3.3 kHz deviation, 15 kHz IF BW, C-Message weighted filter, 10 kHz FM deviation meter range, 15° to 35°C), $\leq$ 2.5 $\mu$ V otherwise								
Antenna Input Protection:	10 W CW (5 sec with alarm)								
Selectivity:	300 kHz, 15 kHz, 30 kHz								
Adjacent Channel Rejection:	<table border="1" style="width: 100%; border-collapse: collapse;"> <thead> <tr> <th style="text-align: left;">IF BW</th> <th style="text-align: left;">Selectivity</th> </tr> </thead> <tbody> <tr> <td>(3 dB)</td> <td>&gt;30.0 dB Down</td> </tr> <tr> <td>300 kHz</td> <td><math>\pm</math>485 kHz</td> </tr> <tr> <td>15 kHz</td> <td><math>\pm</math>15 kHz</td> </tr> </tbody> </table>	IF BW	Selectivity	(3 dB)	>30.0 dB Down	300 kHz	$\pm$ 485 kHz	15 kHz	$\pm$ 15 kHz
IF BW	Selectivity								
(3 dB)	>30.0 dB Down								
300 kHz	$\pm$ 485 kHz								
15 kHz	$\pm$ 15 kHz								
<b>Demodulation Output</b>									
FM:	0.20 Vpk/kHz, $\pm$ 10% (10 kHz range) 0.10 Vpk/kHz, $\pm$ 10% (20 kHz range) 0.04 Vpk/kHz, $\pm$ 10% (50 kHz range) 0.02 Vpk/kHz, $\pm$ 10% (100 kHz range)								
AM:	1.13 Vrms ( $\pm$ 0.06 Vrms) (80% modulation)								
$\emptyset$ M:	0.2 Vpk/Rad, $\pm$ 10%								



# SECTION 1

## INTRODUCTION

<b>SELECTIVE RF COUNTER</b>	
Frequency Range:	250 kHz to 1 GHz (The received frequency must be within the IF bandpass of the COM-120C.)
Tunable Range:	0 Hz to 1 GHz (characteristics below 250 kHz are not specified)
Resolution:	1 Hz (10 sec gate time) 10 Hz (1 sec gate time)
Accuracy:	<i>Same as Master Oscillator, <math>\pm 2</math> Hz</i>
RF Level:	
T/R Connector:	0 to +53 dBm
ANT Connector:	-60 to 0 dBm
<b>RF FREQUENCY ERROR METER</b>	
Meter Range:	0 Hz to 100 kHz
Meter Accuracy:	<i>Same as Master Oscillator, <math>\pm 2</math> counts.</i>
Meter Resolution:	1 Hz (10 sec gate time) 10 Hz (1 sec gate time)
RF Frequency Range:	250 kHz to 1 GHz (The received frequency must be within the IF bandpass of the COM-120C.)
RF Level:	
T/R Connector:	0 to 53 dBm
ANT Connector:	-60 to 0 dBm
<b>AF FREQUENCY COUNTER</b>	
Frequency	
Range:	10 Hz to 20 kHz
Accuracy:	<i>Same as Master Oscillator, <math>\pm 1</math> count.</i>
Resolution:	0.1 Hz (1 sec gate time, 10 to 500 Hz) 1 Hz (1 sec gate time, 500 Hz to 20 kHz) 0.1 Hz (10 sec gate time)
Input Signal Level	
SCOPE/DVM Input:	90 mVpp (50 mV range, any waveform)
AUDIO/DATA Input:	450 mVpp (any waveform)

# SECTION 1

## INTRODUCTION

<b>FREQUENCY MODULATION METER</b>	
Range:	2, 5, 10, 20, 50, 100 kHz full scale
Resolution:	10 Hz (2, 5 and 10 kHz range) 100 Hz (20, 50 and 100 kHz ranges)
Accuracy:	±5% full scale, ±50 Hz, ±1 digit + source residual FM (300 kHz IF BW, 1 kHz tone, 5 kHz deviation, C-Message weighted filter)
Modulation Rate:	0 to 20 kHz
Carrier Range:	250 kHz to 1 GHz (The received frequency must be within the IF bandpass of the COM-120C.)
Carrier Level:	
T/R Connector:	0 to +53 dBm
ANT Connector:	-60 to 0 dBm
<b>ØM METER</b>	
Range:	1, 2, 5, 10 rad peak full scale
Resolution:	0.01 rad (1 and 2 rad scales) 0.1 rad (5 and 10 rad scales)
Accuracy:	±5% of full scale ±0.1 rad, ±1 count + source residual PM (300 kHz IF BW, 1 kHz tone, 1.0 rad deviation, C-Message weighted filter)
Modulation Rate:	100 Hz to 6 kHz
Carrier Range:	250 kHz to 1 GHz (The received frequency must be within the IF bandpass of the COM-120C.)
Carrier Level:	
T/R Connector:	0 to +53 dBm
ANT Connector:	-60 to 0 dBm

# SECTION 1

## INTRODUCTION

<b>AM MODULATION METER</b>	
Range:	1% to 100%
Resolution:	0.1%
Accuracy:	±5% of full scale, ±1 count + source residual AM (300 kHz IF BW, 1 kHz tone, 50% AM depth, C-Message weighted filter)
Modulation Rate:	50 Hz to 10 kHz
Carrier Range:	250 kHz to 1 GHz (The received frequency must be within the IF bandpass of the COM-120C.)
Carrier Level:	
T/R Connector:	0 to +53 dBm
ANT Connector:	-60 to 0 dBm
AGC Attack Time:	50 ms maximum
<b>RF POWER METER</b>	
Meter Ranges:	2 mW to 200 W in a 1-2-5 sequence
Resolution:	1% of full scale or 0.1 mW, whichever is greater
Accuracy:	±10%, ±0.1 mW, ±1 digit (>200 mW, 15°C to 36°C) ±15%, ±0.1 mW, ±1 digit (<200 mW below 15°C and above 35°C)
Frequency Range:	1.5 MHz to 1 GHz
RF Level Range:	2 mW to 200 W average power
Usable Level:	0.2 mW to 200 W average power (characteristics below 2 mW not specified)
Operating Conditions:	50 W CW continuous (50°C) 100 W CW (90 sec/3 min, 50°C) 150 W CW (30 sec/3 min, 50°C) 200 W CW (15 sec/3 min, 50°C)
VSWR:	1.15:1 (0.25 to 100 MHz) 1.23:1 (100 to 400 MHz) 1.38:1 (400 MHz to 1 GHz)
Alarms:	Audible and visual (if applied power exceeds 200 W in the 200 W range or the COM-120C's Power Termination Assembly temperature exceeds 105°C)

# SECTION 1

## INTRODUCTION

---

<b>RECEIVE LEVEL METER</b>	
Range:	-101 to -30 dBm (15 kHz IF BW) -80 to -30 dBm (300 kHz IF BW)
Accuracy:	±3 dB
Frequency Range:	250 kHz to 1 GHz (The received frequency must be within the IF bandpass of the COM-120C.)
<b>DISTORTION METER</b>	
Range:	1% to 20%
Resolution:	0.1%
Accuracy:	±0.5% distortion, ±1 digit (1% to 10%) ±2% distortion, ±1 digit (>10 to 20%)
Signal Frequency:	1 kHz sinewave
Signal Level:	
SCOPE/DVM Input:	0.03 to 200 Vrms
AUDIO/DATA Input:	0.15 to 15 Vrms
<b>SINAD METER</b>	
Range:	3 to 30 dB
Resolution:	0.1 dB
Accuracy:	±1 dB, ±1 count (at 12 dB SINAD)
Signal Frequency:	1 kHz sinewave
Signal Level:	
SCOPE/DVM Input:	0.03 to 200 Vrms
AUDIO/DATA Input:	0.15 to 15 Vrms

# SECTION 1

## INTRODUCTION

<b>DIGITAL VOLTMETER</b>	
Ranges:	50 mV to 200 V in a 1-2-5 sequence
Range:	
DC:	10 mV to 200 Vdc (SCOPE/DVM input)
AC:	10 mV to 200 Vrms (SCOPE/DVM input) 150 mV to 15 Vrms (AUDIO/ DATA input)
Resolution:	3.5 digit
Accuracy:	±5% full scale, ±5 mV ±1 digit (SCOPE/DVM input) ±7% full scale, ±5 mV ±1 digit (AUDIO/DATA input)
Frequency:	DC, 50 Hz to 20 kHz
Input Impedance:	1 MΩ unbalanced (SCOPE/DVM/SINAD input) 100 kΩ, unbalanced (AUDIO/DATA input)
<b>OSCILLOSCOPE</b>	
Bandwidth (3 dB):	50 kHz
Vertical	
Ranges:	10 mV to 50 V/div in a 1-2-5 sequence
Maximum Input:	200 rms
Accuracy:	5% full scale
Resolution:	1% full scale, 256 data points, 8 major divisions
Coupling:	DC, AC and GND
Horizontal	
Ranges:	100 μs to 200 ms/div in a 1-2-5 sequence
Resolution:	1% full scale, 500 data points, 10 major divisions
Accuracy:	1% full scale
Input Impedance:	1 MΩ, unbalanced (nominal)

# SECTION 1

## INTRODUCTION

<b>SPECTRUM ANALYZER</b>																																					
Center Frequency:	250 kHz to 1 GHz																																				
Tunable Range:	0 Hz to 1 GHz (characteristics below 250 kHz are not specified)																																				
Resolution:	100 Hz																																				
<b>Frequency Span</b>																																					
Ranges:	1 kHz to 100 MHz/div in a 1-2-5 sequence and zero span																																				
Accuracy:	±5% of span width																																				
Operational Modes:	Normal, Split Screen																																				
Modes:	<table style="width: 100%; border: none;"> <thead> <tr> <th style="text-align: left;"><u>Scan Width</u></th> <th style="text-align: left;"><u>Resolution BW</u></th> </tr> </thead> <tbody> <tr><td>100 MHz/div</td><td>3 MHz</td></tr> <tr><td>50 MHz</td><td>3 MHz</td></tr> <tr><td>20 MHz</td><td>3 MHz</td></tr> <tr><td>10 MHz</td><td>3 MHz</td></tr> <tr><td>5 MHz</td><td>300 kHz</td></tr> <tr><td>2 MHz</td><td>300 kHz</td></tr> <tr><td>1 MHz</td><td>300 kHz</td></tr> <tr><td>500 kHz</td><td>30 kHz</td></tr> <tr><td>200 kHz</td><td>30 kHz</td></tr> <tr><td>100 kHz</td><td>30 kHz</td></tr> <tr><td>50 kHz</td><td>30 kHz</td></tr> <tr><td>20 kHz</td><td>3 kHz</td></tr> <tr><td>10 kHz</td><td>3 kHz</td></tr> <tr><td>5 kHz</td><td>3 kHz</td></tr> <tr><td>2 kHz</td><td>300 Hz</td></tr> <tr><td>1 kHz</td><td>300 Hz</td></tr> <tr><td>0 kHz</td><td>30 kHz</td></tr> </tbody> </table>	<u>Scan Width</u>	<u>Resolution BW</u>	100 MHz/div	3 MHz	50 MHz	3 MHz	20 MHz	3 MHz	10 MHz	3 MHz	5 MHz	300 kHz	2 MHz	300 kHz	1 MHz	300 kHz	500 kHz	30 kHz	200 kHz	30 kHz	100 kHz	30 kHz	50 kHz	30 kHz	20 kHz	3 kHz	10 kHz	3 kHz	5 kHz	3 kHz	2 kHz	300 Hz	1 kHz	300 Hz	0 kHz	30 kHz
<u>Scan Width</u>	<u>Resolution BW</u>																																				
100 MHz/div	3 MHz																																				
50 MHz	3 MHz																																				
20 MHz	3 MHz																																				
10 MHz	3 MHz																																				
5 MHz	300 kHz																																				
2 MHz	300 kHz																																				
1 MHz	300 kHz																																				
500 kHz	30 kHz																																				
200 kHz	30 kHz																																				
100 kHz	30 kHz																																				
50 kHz	30 kHz																																				
20 kHz	3 kHz																																				
10 kHz	3 kHz																																				
5 kHz	3 kHz																																				
2 kHz	300 Hz																																				
1 kHz	300 Hz																																				
0 kHz	30 kHz																																				

# SECTION 1

## INTRODUCTION

Level	
Display:	Log, 2 and 10 dB/div
Vertical Resolution:	1 dB
Range (Dynamic):	60 dB
Bandwidth Switching Error:	<3 dB
Log Linearity:	±2 dB (referenced to -40 dBm, 15° to 35°C) ±3 dB (referenced to -40 dBm, 0° to 15°C and 35° to 50°C)
Input Attenuator:	0, 30 dB (ANT Connector)
INPUT/OUTPUT CONNECTORS	
RS-232 Connector	
Operations Mode:	Off, PC (Input/Output)
Baud Rates:	100, 150, 300, 600, 1200, 2400, 4800, 9600, 19200, 38400
Stop Bits:	1, 2
Parity:	Odd, Even, None
Handshake:	None, Xon/Xoff, CTS/RTS
MASTER OSCILLATOR	
TCXO	
Frequency:	10 MHz
Uncertainty:	±0.1 ppm
Temperature Stability:	±0.2 ppm (0° to 50°C)
Aging Rate:	±0.5 ppm/year
POWER REQUIREMENTS	
Line Voltage:	100 to 120 VAC at 60 Hz 220 to 240 VAC at 50 Hz
DC Input:	12 Vdc, 24-30 Vdc
Power Consumption	
AC:	110 VAC, 150 W maximum, 110 W typical 230 VAC, 150 W maximum, 95 W typical
DC:	150 W maximum, 90 W typical

# SECTION 1

## INTRODUCTION

<b>FUSE REQUIREMENTS</b>	
<b>AC Fuses:</b> 100 to 120 VAC: 220 to 240 VAC: <b>DC Fuse:</b> <b>Battery Fuse:</b>	3.0 A, 250 V, Type F (5 x 20 mm) 3.0 A, 250 V, Type F (5 x 20 mm) 10 A, 32 V, Type F (AGC) 10 A, 32 V, Type F (AGC)
<b>SAFETY CONDITIONS</b>	
<b>Use:</b> <b>Altitude:</b> <b>Operating Temperatures:</b> <b>Relative Humidity:</b> <b>Mains Supply Voltage Fluctuations:</b> <b>Transient Overvoltages:</b> <b>Pollution Degree:</b>	Non-conductive pollution only ≤4000 meters (13,124 feet) 0° to 50°C ≤80% for temperatures up to 31°C decreasing linearly to 50% at 40°C ≤±10% of the nominal voltage According to Installation Category II 2
<b>GENERAL CHARACTERISTICS</b>	
<b>Dimensions:</b>         <b>Weight:</b>	40.0 cm (15.75") wide, 19.0 cm (7.5") high, 42.9 cm (16.875") deep (without bail handle and front panel cover)  44.0 cm (17.32") wide, 19.0 cm (7.5") high, 53.7 cm (21.125") deep (with bail handle and front panel cover)  17.3 kg (38.5 lbs.) (without options, lid, accessories)



# SECTION 1

## INTRODUCTION

---

THIS PAGE INTENTIONALLY LEFT BLANK.

# SECTION 2

## INSTALLATION

### 2-1 GENERAL

This section contains information on preparing the COM-120C for use. Also listed are installation and operating precautions for safe use of the Unit.

### 2-2 PRECAUTIONS

Before operating this instrument, the operator should be thoroughly familiar with all aspects of this manual.

For operator safety and to prevent damage to this instrument, the following operating precautions should be observed at all times.

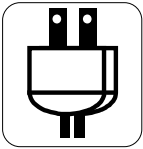

**WARNING:**

**DO NOT USE A THREE-PRONG TO TWO-PRONG ADAPTER PLUG. DOING SO CREATES A SHOCK HAZARD BETWEEN THE CHASSIS AND ELECTRICAL GROUND.**



**CAUTION:**

THE T/R CONNECTOR ACCEPTS NO MORE THAN 200 W. MAXIMUM OPERATION TIME FOR MEASUREMENT USING THE T/R CONNECTOR:

CONTINUOUS ON AT 50 W AND 50°C AMBIENT.
30 SEC ON AND 3 MIN OFF AT 100 W AND 50°C AMBIENT.
15 SEC ON AND 3 MIN OFF AT 200 W AND 50°C AMBIENT.

<b>MAXIMUM CONTINUOUS INPUT INTO THIS CONNECTOR...</b>	<b>...MUST NOT EXCEED THIS MAXIMUM OR DAMAGE TO THE COM-120C MAY RESULT</b>
ANTENNA	0.25 W MAX
DEMODO	20 V MAX
EXT MOD	20 V MAX
SCOPE/DVM	200 V MAX
AUX RF OUT	0.25 W MAX
MIC/ACC	20 V MAX
AUDIO/DATA IN	30 V MAX

This Equipment Contains Parts Sensitive To Damage By Electrostatic Discharge (ESD).

# SECTION 2

## INSTALLATION

---

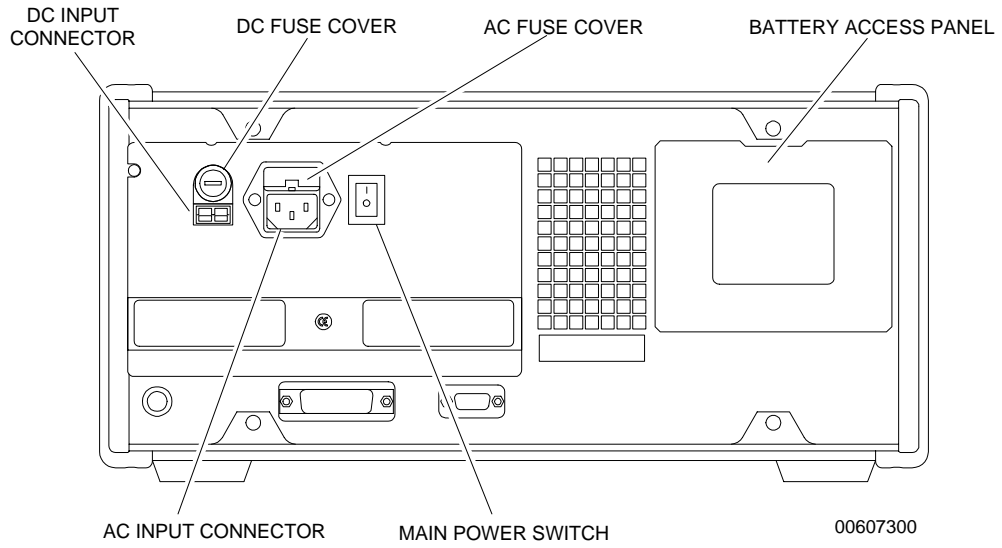

**COM-120C Rear Panel**

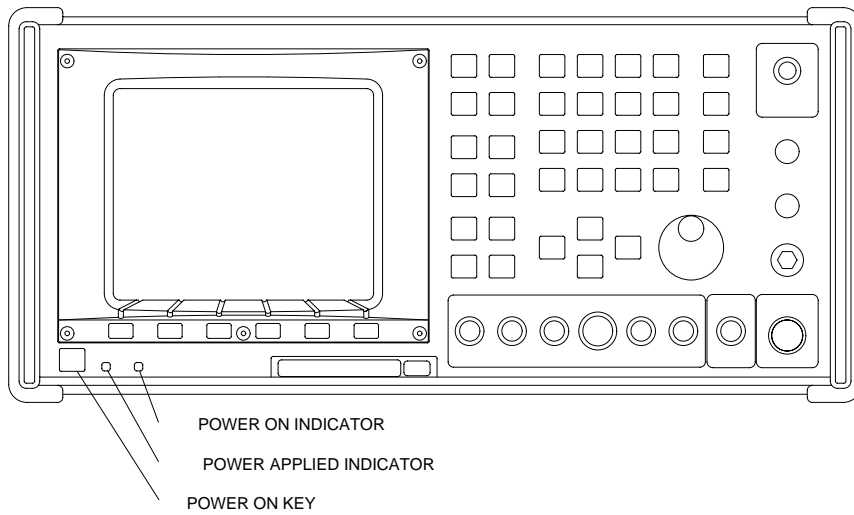

**COM-120C Front Panel**

### 2-3 POWER UP PROCEDURES

The Internal Battery, if installed, charges automatically when the COM-120C is connected to a power source and the Main Power Switch is set to ON.

The Power Supply is designed to sense applied ac voltage and compensate automatically with no further action required.

.....

#### 2-3-1 APPLYING AC POWER

- Connect ac power cord to AC Input Connector.
- Plug ac power cord into power source. Insure proper grounding.
- Set Main Power Switch to ON ("I" on switch).  
Power APPLIED Indicator lights when power is available.
- Press COM-120C Front Panel Power ON Key to activate Unit. Power ON Indicator lights.

#### 2-3-2 APPLYING EXTERNAL DC POWER

- Connect dc power cord to DC Input Connector.
- Properly connect non-terminated ends of dc power cord to a 10A current limited dc power source.  
Power APPLIED Indicator lights when power is available.
- Press COM-120C Front Panel Power ON Key to activate Unit. Power ON Indicator lights.



Before operating unit with 12 V supply, verify voltage level at connector is 12 V or greater.

#### 2-3-3 BATTERY POWER OPERATION (OPTION 01)

- Press COM-120C Front Panel Power ON Key.
- Power ON Indicator lights.

Option 01 required for battery operation.

Power cycles off after approximately 20 to 25 minutes of continuous operation.

*Flashing Power ON Indicator denotes low battery charge.*

# SECTION 2

## INSTALLATION

---

THIS PAGE INTENTIONALLY LEFT BLANK.

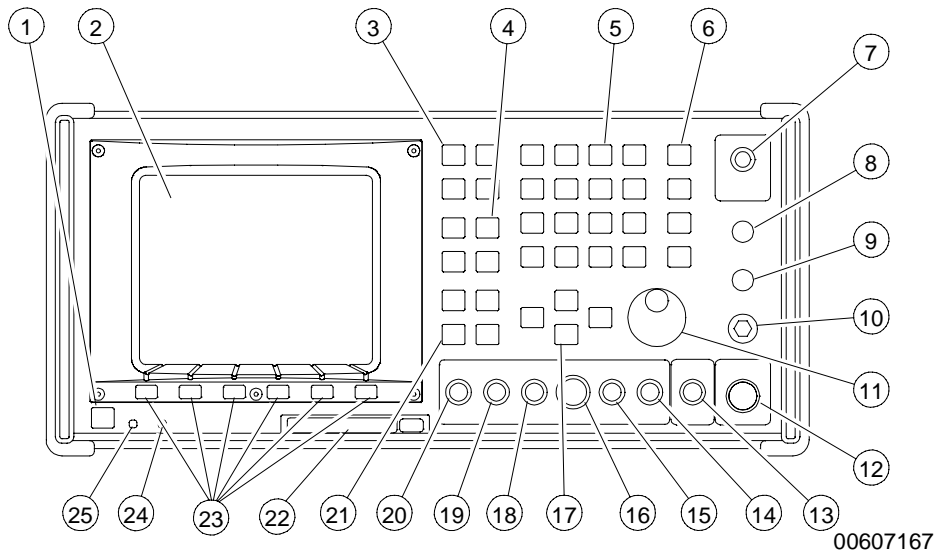

COM-120C Front Panel Controls

### 3-1 FRONT PANEL CONTROLS

1. Power ON Key

Selection toggles between Power APPLIED and Power ON states.

2. Display

Provides video information of current test operation.

3. Test Mode Keys



Accesses Generate Mode Operation Screen.



Accesses DUPLEX Mode Operation Screen.



Accesses Receive Mode Operation Screen.



Accesses Special Optional Operation Modes.

4. Instrument Keys



Accesses Independent Oscilloscope Operation Screen.



Accesses Independent Meter Functions.



Accesses Independent Spectrum Analyzer Operation Screen.



Accesses Independent Audio/Data Generators Functions.

# SECTION 3

## COMPOSITE

---

### 5. DATA ENTRY Keys



Use to enter numeric (0-9) values.



Use to enter decimal point in numeric values.



Use for DTMF functions.



Accesses alphabetic function of Front Panel Keys. See Shift Character Table.



Use for DTMF functions.



Selects a data field for edit or completes an editing procedure.



Use to set sign of entered value.

### 6. CONTROL Keys



Use to escape an editing procedure without change to parameters.



Moves cursor to predetermined areas to simplify editing.



Use to freeze current screen to observe data or print the screen. Press HOLD SCRN Key again to return Test Set to normal operation.



Deletes the character the cursor is on when editing.



Use to start and stop the Reset One Shot in Oscilloscope Operation, Bit Error Rate Meter (Option 07) and LTR<sup>®</sup> Trunking (Option 14)

# SECTION 3

## COMPOSITE

FRONT PANEL KEY	SHIFT CHARACTER
GEN	A
REC	B
1	C
2	D
3	E
+/-	F
DPLX	G
SPCL	H
4	I
5	J
6	K
•	L
SCOPE	M
ANLYZ	N
7	O
8	P
9	Q
MTRS	R
AUDIO GEN	S
*	T
0	U
#	V
STORE	W
RCL	X
SHOW LIST	Y
SETUP	Z
TAB	[space]
SHIFT + ESC	Deletes Character

Shift Character Table



# SECTION 3

## COMPOSITE

---

7. ANTENNA Connector

Input connector to monitor "off-the-air" signals. Also used as a connection for low power (0.25 W maximum) signals.



**CAUTION:**

DO NOT EXCEED 0.25 W MAXIMUM CONTINUOUS INPUT OR DAMAGE TO THE COM-120C MAY RESULT.

8. SQUELCH Control

Adjusts squelch level of received signal.

9. VOLUME Control

Controls volume of speaker.

10. PHONES Connector

Provides access for using Headphones when audio signal is provided to speaker.

11. DATA SCROLL Spinner

Allows operator to scroll through current test mode operation screen, scroll through lists of parameter selections and actively increase and decrease one digit of numeric parameters. Current test mode operation screen changes with entered data; changed parameter becomes current default unless ENTER Key is pressed. Pressing ESC Soft Function Key returns changed parameter to previous setting.

12. T/R Connector

50  $\Omega$  Connector for high power input or output signals.



**CAUTION:**

DO NOT EXCEED 200 W MAXIMUM CONTINUOUS INPUT OR DAMAGE TO THE COM-120C MAY RESULT.

13. AUX RF OUT Connector

50  $\Omega$  Auxiliary output connector for RF Signals.



**CAUTION:**

DO NOT EXCEED 0.25 W MAXIMUM CONTINUOUS INPUT OR DAMAGE TO THE COM-120C MAY RESULT.

### 14. AUDIO/DATA GEN Connector

600  $\Omega$  connector for output of audio and data generators. Access is selectable from individual generator setup screens.



**CAUTION:**

DO NOT EXCEED 20 V MAXIMUM CONTINUOUS INPUT OR DAMAGE TO THE COM-120C MAY RESULT.

### 15. DEMODO Connector

600  $\Omega$  connector for output of demodulated signals. Access is selectable from individual generator setup screens.



**CAUTION:**

DO NOT EXCEED 20 V MAXIMUM CONTINUOUS INPUT OR DAMAGE TO THE COM-120C MAY RESULT.

### 16. MIC/ACC Connector

Provides access for microphone or accessory equipment both generate and receive lines are available.



**CAUTION:**

DO NOT EXCEED 20 V MAXIMUM CONTINUOUS INPUT OR DAMAGE TO THE COM-120C MAY RESULT.

### 17. DATA SCROLL Keys

Allows operator to scroll through current test mode operation screen, scroll through list of parameter selections and actively increase and decrease one digit of numeric parameters.

Increasing and decreasing digits affects higher digits in parameter.

Current test mode operation screen changes with changed data; changed parameter becomes current default unless ENTER Key is pressed.

Pressing ESC (Escape) Soft Function Key returns changed parameter to previous setting.

### 18. EXT MOD

100 k $\Omega$  connector allows input for external modulation source.



**CAUTION:**

DO NOT EXCEED 20 V MAXIMUM CONTINUOUS INPUT OR DAMAGE TO THE COM-120C MAY RESULT.

# SECTION 3

## COMPOSITE

---

19. AUDIO/DATA IN Connector

100 k $\Omega$  connector allows input of external audio and data signals.



**CAUTION:**

DO NOT EXCEED 20 V MAXIMUM CONTINUOUS INPUT OR DAMAGE TO THE COM-120C MAY RESULT.

20. SCOPE/DVM Connector

1 M $\Omega$  input to Oscilloscope and Digital Voltmeter. CAT II.



**CAUTION:**

DO NOT EXCEED 200 V MAXIMUM CONTINUOUS INPUT OR DAMAGE TO THE COM-120C MAY RESULT.

21. MEMORY Keys



Selection allows operator to store current Operation Screen and all current parameters for future access.



Selection allows operator to recall previously stored Operation Screens.



Provides access to menu of all storage lists.



Provides access to setup menu for system information and system configuration.

22. PCMCIA Card Slot

Provides access to enhance software capability.

23. Soft Function Keys

Provide access to defined function.

24. Power ON Indicator

Denotes system is on when lit.

25. Power APPLIED Indicator

Denotes power is provided to the system when lit.

# SECTION 3

## COMPOSITE

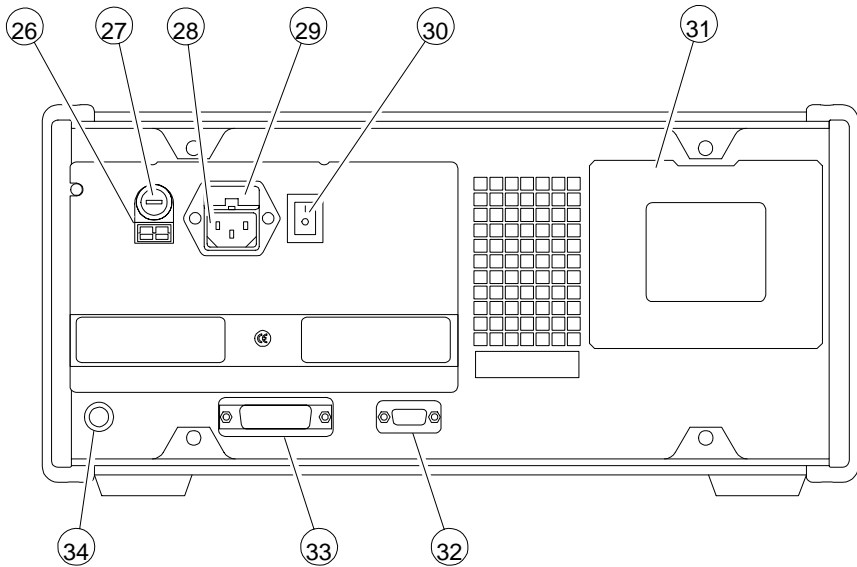

00607261

COM-120C Rear Panel Controls

### 3-2 REAR PANEL CONTROLS

26. DC Input Connector 

Accepts dc power cord to supply dc power (12, 24 to 30 Vdc) to COM-120C.



**CAUTION:**  
DO NOT EXCEED 30 Vdc OR DAMAGE TO THE COM-120C MAY RESULT.

27. DC Fuse 

10 A, 32 V, Type F, AGC Fuse is provided for dc operation.



**CAUTION:**  
ONLY USE 10 A, 32 V TYPE F FUSE OR DAMAGE TO THE COM-120C MAY RESULT.

28. AC Input Connector 

Accepts ac power cord to supply ac power to COM-120C.



**CAUTION:**  
DO NOT EXCEED 265 VAC OR DAMAGE TO THE COM-120C MAY RESULT.

# SECTION 3

## COMPOSITE

---

29. AC Fuse 

Two 3.0 A, 250 V, Type F, 5 x 20 mm fuses are provided for ac operation.



**CAUTION:**

ONLY USE 3 A FUSE OR DAMAGE TO THE COM-120C MAY RESULT.

30. Main Power Switch 

Switches power applied ON an OFF.

31. Battery Access Panel

Provides access to battery.

32. RS-232 Connector

Provides serial interface for remote operations with COM-120C.

33. GPIB Connector (Option)

IEEE-488 Connector provides parallel interface for remote operations with COM-120C.

34. Reference Connector

Provides connection for input of external 10 MHz Reference Signal.

### 3-3 SCREENS, SOFT FUNCTION KEYS AND MENUS

The following comments apply to all Operation Screens within the COM-120C. Reading and understanding these notes is the responsibility of the operator.

Due to the level of detail required to fully describe all facets of the COM-120C, only surface information is provided to help educate the operator.

#### 3-3-1 SOFT FUNCTION KEYS

Soft Function Keys are alphabetically defined in Appendix D.

#### 3-3-2 CURSOR MOVEMENT

A cursor, in the shape of a box, is used to identify what is currently editable. There are two methods to move the Cursor around the active screen.

Use DATA SCROLL Keys as long as the current Cursor location is not being edited.

Or use TAB Function as follows:

- Press TAB Key.
- Enter value in desired screen location using DATA ENTRY Key(s).
- Press ENTER Key to complete the operation.

#### 3-3-3 EDITING FIELDS USING DATA SCROLL KEYS AND SPINNER

All fields can be edited using DATA SCROLL Keys and/or DATA SCROLL Spinner. Editing Numeric Data Fields is a special case and is covered in para 4-1-3. Edit the remainder of the fields using DATA SCROLL Keys and/or DATA SCROLL Spinner as follows:

- Position cursor on field selected for edit using DATA SCROLL Keys or TAB Function.
- Press ENTER Key to highlight field.
- Press DATA SCROLL Key (↑) to move up through search field and DATA SCROLL Key (↓) to move down through search field. Alternate method is to use DATA SCROLL Spinner. Turning DATA SCROLL Spinner clockwise performs same operation as pressing DATA SCROLL Key (↑).
- Press ENTER Key to complete operation.

# SECTION 3

## COMPOSITE

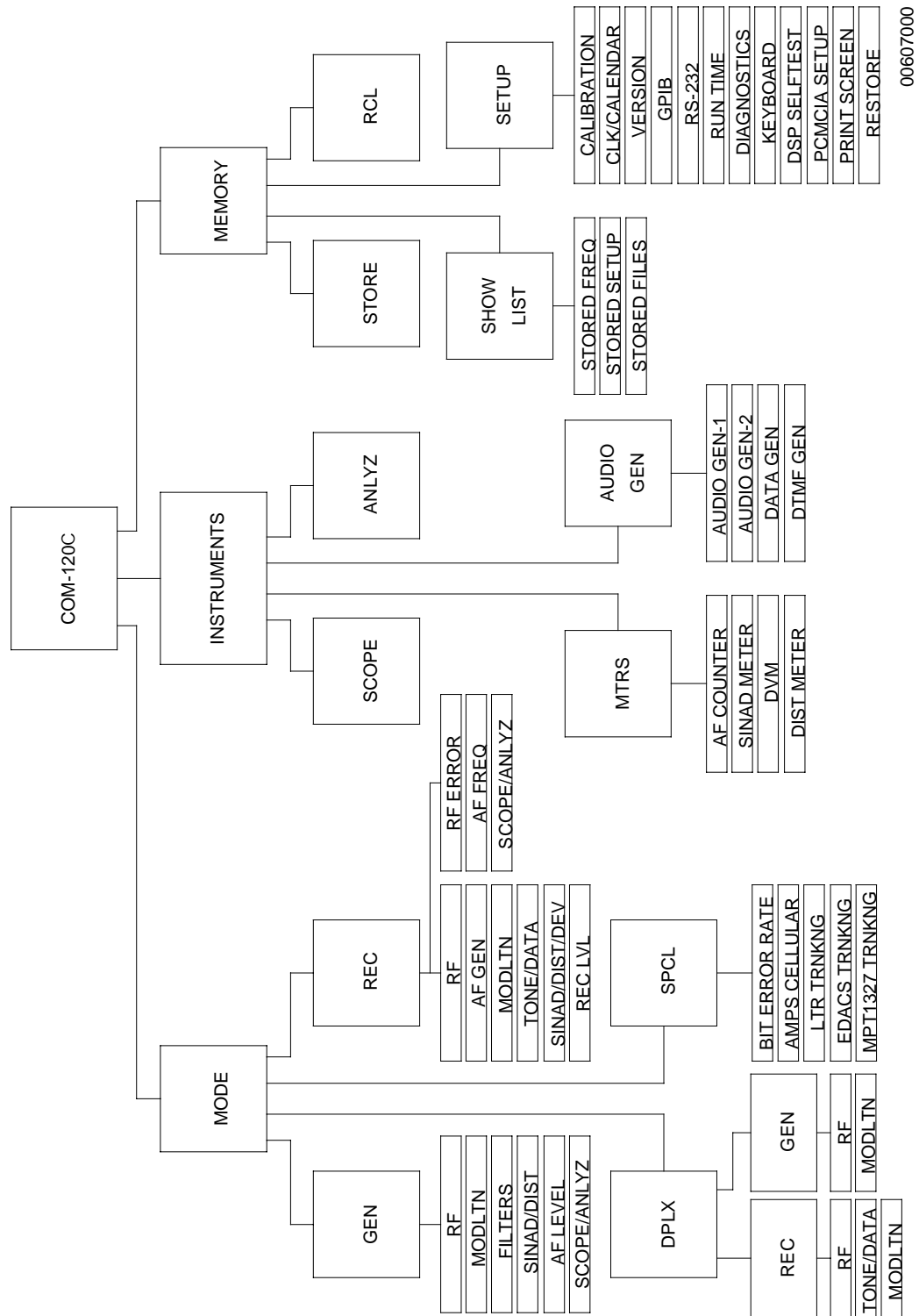

COM-120C Composite Hierarchy

00607000

### 3-3-4 EDITING NUMERIC DATA FIELDS

The primary method of editing data in numeric data fields such as frequencies and levels is to use DATA ENTRY Keys. The step-by-step procedure for this method is as follows:

- Position cursor on field selected for data entry using DATA SCROLL Keys or TAB Function.
- Enter numeric value using DATA ENTRY Keys.
- Press ENTER Key to complete operation.

A second method to change current numeric values in small amounts is to use the DATA SCROLL Keys and/or DATA SCROLL Spinner. This method changes one digit of the value directly, but more significant digits are affected indirectly as the edited digit passes zero in either direction. The step-by-step procedure for this method is as follows:

- Position cursor on field selected for data entry using DATA SCROLL Keys or TAB Key.
- Press ENTER Key to highlight field.
- Digit in field to be edited is not highlighted. Pressing DATA SCROLL Key (→) moves highlight to less significant digit. Pressing DATA SCROLL Key (←) moves highlight to more significant digit.
- Once digit to be edited is selected, press DATA SCROLL Key (↑) to increase digit value and DATA SCROLL Key (↓) to decrease digit value. Alternate method is to use DATA SCROLL Spinner. Turning DATA SCROLL Spinner clockwise increases value and counterclockwise decreases value.
- Press ENTER Key to complete operation.

### 3-3-5 MAKING SELECTIONS FROM MENUS

Whenever the number of selections for the position being edited exceeds the number of available Soft Function Keys, a MENU Soft Function Key is used. Pressing the MENU Soft Function Key opens a window of selections for the current cursor location. The window cursor is located at the currently active selection. To choose a different selection, move the cursor using the DATA SCROLL Keys or DATA SCROLL Spinner to the selection. Press the ENTER Key to complete the operation.

### 3-3-6 ESCAPING FROM EDIT WITHOUT CHANGE

An edit procedure can be exited at any time, without change, by pressing the ESC Key.



# SECTION 3

## COMPOSITE

### 3-3-7 RF GENERATE SCREEN

The RF Generate Operation Screen defines and activates the COM-120C RF Generator and is accessed by pressing the GEN Test Mode Key.

The RF Generate Operation Screen displays in the configuration last used.



1. Header Bar  
Displays current operation mode.
2. RF Field  
Displays current RF Generate Frequency from 0.0000 to 1000.0000 MHz.  
Set Reference and Sweep Functions are not active simultaneously.

3. FL (Frequency List) Setting  
Displays selected Frequency List number (FL-00 to FL-99) when active. Blank if inactive. RF Field (2) echoes frequency of selected Frequency List setting. Editing RF Field (2) deactivates Frequency List Function.

4. Frequency List Label  
Displays optional Frequency List Label. Blank if Frequency List Label is not used.

5. Output Level  
Displays Output Level in selected units. If T/R Connector is selected for Output (6), range is -130 to -20 dBm, 0.07 to 22360.6  $\mu$ V, 0.0000 to 22.3606 mV and 0.000000 to 0.022360 V. If AUX RF Connector is selected for Output (6), range is -130 to -13 dBm, 0.07 to 50059.3  $\mu$ V, 0.0000 to 50.0593 mV and 0.000000 to 0.050059 V.

6. Output  
Displays connector selected for output. Displays T/R, T/R Gate, AUX or AUX Gate. If Gate Output is selected, output is active only when microphone attached to MIC/ACC Connector is keyed. Default output connector is T/R Connector.

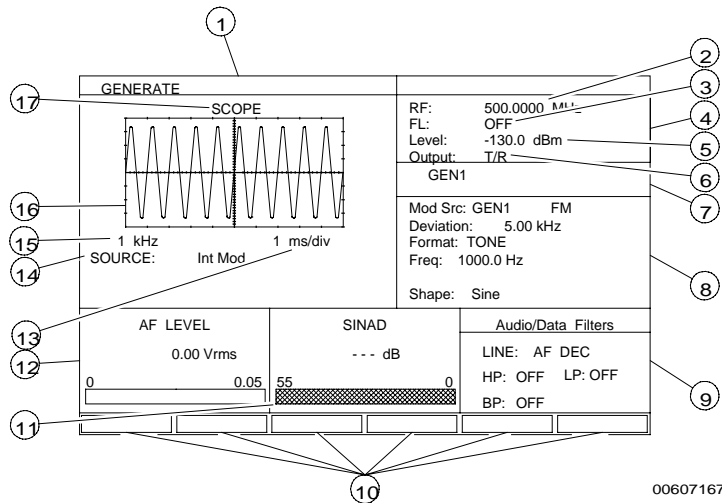

RF Generate Screen

00607167

# SECTION 3

## COMPOSITE

---

### 7. Modulation Source Window

Displays active Modulation Sources. Inactive Modulation Sources are not shown. If two (or more) sections of the RF Modulator are set in conflict (e.g. GEN1 set for PM and GEN2 set for FM, or GEN1 set for 0.01 kHz deviation and GEN2 set for 2.60 kHz deviation) the screen displays the invalid source grayed out.

### 8. Modulation Source Block

Displays selected Modulation Source and appropriate data. Selections include GEN1 (Audio Generator 1), GEN2 (Audio Generator 2), DTMF (DTMF Tone Generator), DATA (DATA Generator), EXT (External Modulation) and MIC (Microphone Modulation).

### 9. Audio/Data Filters Block

Displays current filter information for selected analog signal. Selections include AF Decode Line, Data Decode Line and Speaker/Headphones Line.

### 10. Soft Function Key Definitions

Functions are redefined with each field of the current operation screen.

### 11. SINAD/Distortion Meters

Displays selected Meter Operation. Selections are SINAD or Distortion Meters.

### 12. AF Level Meter

Displays AF LEVEL METER Operation.

### 13. Oscilloscope Sweep

Displays editable Oscilloscope Sweep.

### 14. Source

Displays editable Oscilloscope Source.

### 15. Oscilloscope Scale

Displays editable Oscilloscope Vertical Scale. Vertical Scale value and range selections is dependent on Source.

### 16. Scope/Analyzer Screen

Displays digitized trace of specified signal as Oscilloscope or Spectrum Analyzer.

### 17. Scope/Analyzer Prompt

Displays current operation function. Used to toggle between two functions.

# SECTION 3

## COMPOSITE

### 3-3-8 RF RECEIVE SCREEN

The RF Receive Operation Screen is used to define and activate the COM-120C RF Receiver and is accessed by pressing the REC Test Mode Key.

The RF Receive Operation Screen displays in the configuration last used.



1. Header Bar

Displays current operation mode.

2. RF Field

Displays current RF Receive Frequency. Range is from 0.0000 to 1000.0000 MHz.

Scan Function searches a specified Frequency List (3) range, stopping for a selected time period or when squelch is broken.

Sweep Function sweeps a set range of frequencies, increasing or decreasing frequency at set rate and stopping for a set time or when squelch is broken.

Δ Function allows change of frequency in selected increment (Δ).

3. FL (Frequency List) Setting

Displays selected Frequency List number (FL-00 through FL-99) when active and OFF when inactive. RF Field (2) echoes frequency of selected Frequency List setting. Directly editing RF Field (2) inactivates FL Setting. Displays optional Frequency List Label if used.

4. Input Connector

Displays connector selected for input. Displays either T/R or ANT.

5. Demodulation Type

Displays selected Demodulation Type. Selections include FM, AM or PM.

6. Attenuation

Displays selected attenuation of input signal. Displays either 0 or 30.

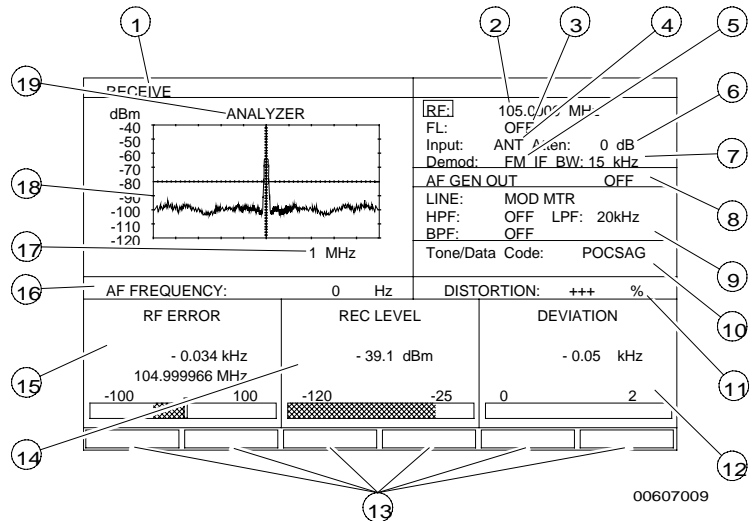

RF Receive Screen

# SECTION 3

## COMPOSITE

---

### 7. IF Bandwidth

Displays selected IF Bandwidth. Selections include 15 and 300 kHz.

### 8. AF Gen Out Field

Pressing ENTER, when cursor is on this field, accesses setup menu for AF Generator sources. Menu displays each source individually. Sources available include GEN1 (Audio Generator 1), GEN2 (Audio Generator 2), DTMF (DTMF Tone Generator) and DATA (DATA Generator).

### 9. Audio/Data Filters Block

Displays current filter information for selected analog signal. Selections include Modulation Meters Line, DTMF/SINAD Line, AF Counter Line, Data Decode Line and Speaker/ Headphones Line.

### 10. Tone/Data Code Field

Displays selected Tone/Data Type and decoded data.

### 11. Distortion/SINAD/Modulation Reading

Displays distortion reading of received signal if Distortion is selected.

Displays SINAD reading of received signal if SINAD is selected.

Displays modulation reading in units of selected DEMOD Type (5) if Modulation is selected.

This field is interactive with Distortion/SINAD/Modulation Meter (12) and displays reading when Distortion/SINAD/Modulation Meter (12) displays meter.

The same reading cannot be displayed twice. Selection of a specific reading changes source of nonedited field to another source

### 12. Distortion/SINAD/Modulation Meter

Displays distortion reading of received signal if Distortion is selected.

Displays SINAD reading of received signal if SINAD is selected.

Displays modulation reading in units of selected DEMOD Type (5) if Modulation is selected.

This field is interactive with Distortion/SINAD/Modulation Reading (11) and field displays complete meter when Distortion/ SINAD/Modulation Reading (11) displays reading only.

The same reading cannot be displayed twice. Selection of a specific reading changes source of nonedited field to another source. One source must always be Modulation.

### 13. Soft Function Key Definitions

Functions are redefined with each field of the current operation screen.

# SECTION 3

## COMPOSITE

---

14. Power/Received Level Meter

Power Meter displays power level of signal received through T/R Connector only in dB and Watts. RECEIVED LEVEL Meter displays referenced Power Level of signal received through ANTENNA Connector only in dBm and  $\mu$ V.

15. RF Error Meter

Displays difference in RF Field (2) and frequency of received signal.

16. AF Frequency Counter

Displays Audio Frequency of received signal.

17. Scan Width

Displays current Scan Width. This field is editable.

18. Scope/Analyzer Screen

Displays digitized trace of specified signal as Oscilloscope or Spectrum Analyzer.

19. Scope/Analyzer Prompt

Displays current operation function. Used to toggle between two functions.

# SECTION 3

## COMPOSITE

### 3-3-9 DUPLEX SCREEN

The Duplex Operation Screen is used to define and activate the COM-120C RF Generator and RF Receiver simultaneously at the same frequency or offset frequencies and is accessed by pressing the DPLX Test Mode Key.

The Duplex Operation Screen displays in the configuration last used.



1. Header Bar

Displays current operation mode.

2. Duplex Generate Prompt

Accesses Duplex Generate Operation Screen.

3. Duplex Generate RF Field

Displays current Duplex Generate Frequency. Range is 0.0000 to 1000.0000 MHz.

4. Frequency Offset

Displays frequency difference between Duplex Generate RF Field (3) and Duplex Receive RF Field (20). Range is from -999.7500 to 999.750 MHz.

5. Output Level

Displays Output Level. If T/R Connector is selected for Output (6), range is -130 to -40 dBm, 0 to .002236 V, 0 to 2.2360 mV or 0.07 to 2236.0 μV. If AUX RF Connector is selected for Output (6), range is -130 to -13 dBm, 0 to 0.050059 V, 0 to 50.0593 mV or 0.07 to 50059.3 μV.

6. Output

Displays Output Connector. Displays T/R, T/R Gate, AUX or AUX Gate. Gated Output is active only when microphone, attached to MIC/ACC Connector, is keyed.

7. Modulation Source Window

Displays active Modulation Sources. Inactive Modulation Sources are not shown. If two (or more) sections of the RF Modulator are set in conflict (e.g. GEN1 set for PM and GEN2 set for FM, or GEN1 set for 0.01 kHz deviation and GEN2 set for 2.60 kHz deviation) the screen displays the invalid source grayed out.

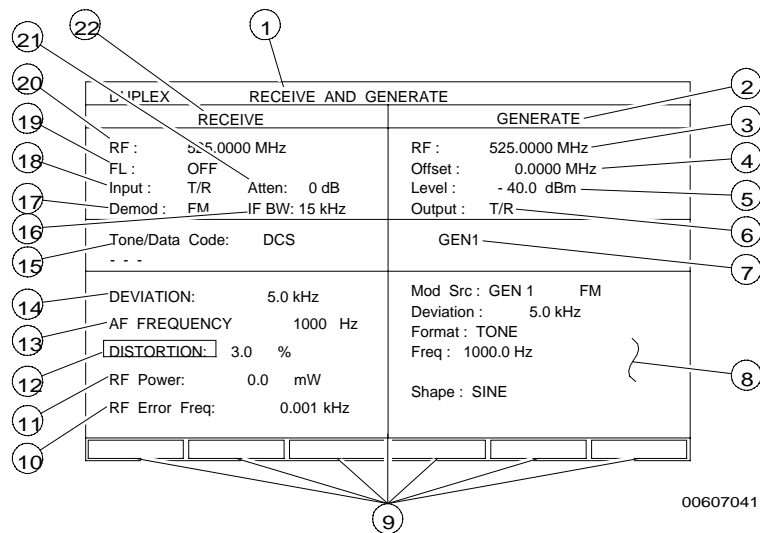

Duplex Screen

# SECTION 3

## COMPOSITE

---

8. Modulation Source Block  
Displays selected Modulation Source. Selections include GEN1 (Audio Generator 1), GEN2 (Audio Generator 2), DTMF (DTMF Tone Generator), DATA (DATA Generator), EXT (External Modulation) and MIC (Microphone Modulation).
9. Soft Function Key Definitions  
Functions are redefined with each field of the current operation screen.
10. RF Error Frequency  
Displays difference in Duplex Receive RF Field (20) and received signal frequency.
11. Power/Received Level Reading  
Power Meter displays power level of signal received through T/R Connector in W. RECEIVED LEVEL Meter displays referenced Power Level of signal received through ANTENNA Connector in dBm.
12. SINAD/Distortion Reading  
Displays selected measurement. Selections include SINAD or Distortion Readings.
13. AF Frequency Reading  
Displays Audio Frequency of demodulated signal.
14. Modulation Reading  
Displays modulation reading in units of selected Demodulation Type (17).  
With FM selected, Field displays DEVIATION and has reading in units of kHz.  
With AM selected, Field displays MODULATION and has reading in units of % Modulation.  
With PM selected, Field displays PHASE and has reading in units of radians.
15. Tone/Data Code Field  
Displays selected Tone/Data Type and decoded data.
16. IF Bandwidth  
Displays selected IF Bandwidth. Selections include 15 and 300 kHz.
17. Demodulation Type  
Displays selected Demodulation Type. Selections include FM, AM or PM.
18. Input Connector  
Displays connector selected for input. Displays either T/R or ANT.

# SECTION 3

## COMPOSITE

---

19. FL (Frequency List) Setting

Displays selected Frequency List number (FL-00 through FL-99) when active and OFF when inactive.

Duplex Receive RF Field (20) echoes frequency of selected Frequency List setting.

Directly editing Duplex Receive RF Field (20) inactivates FL Setting.

Displays optional Frequency List Label if used. Blank if unused.

20. Duplex Receive RF Field

Displays current Duplex Receive Frequency. Range is 0.0000 to 1000.0000 MHz.

21. Attenuation

Displays selected attenuation of input signal. Displays either 0 or 30.

22. Duplex Receive Prompt

Accesses Duplex Receive Operation Screen.



# SECTION 3

## COMPOSITE

---

### 3-3-10 OSCILLOSCOPE SCREEN

The Independent Oscilloscope Operation Screen operates as an independent piece of test equipment and is accessed by pressing the SCOPE Instruments Key. Input for Oscilloscope Operation is through the SCOPE/DVM Connector. The Oscilloscope Operation Screen

The Oscilloscope Operation Screen displays in the configuration last used.



1. Sweep  
Displays selected Oscilloscope Sweep.
2. Oscilloscope Screen  
Displays digitized trace of specified signal.
3. Marker Position  
Displays current Marker Position if Marker (10) is active or OFF if inactive. Value for Marker Position is in same units as Sweep (1) with Trigger point as reference.

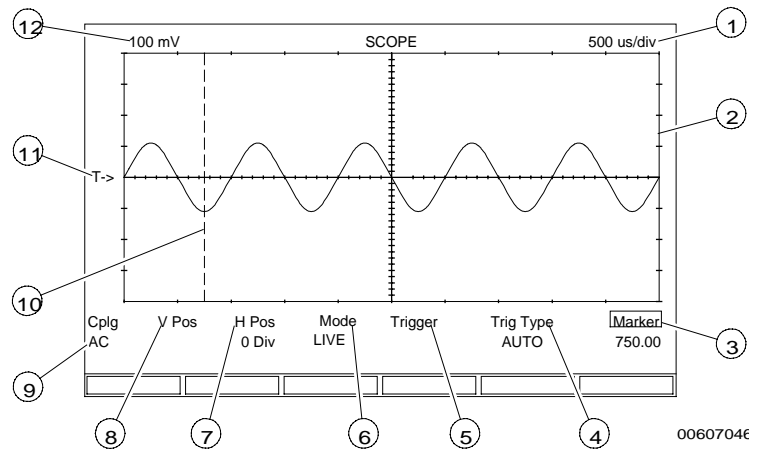

Oscilloscope Screen

4. Trigger Type  
Displays selected Trigger Type.
5. Trigger  
Adjusts trigger level as indicated by Trigger Level Indicator (11) when accessed.
6. Mode  
Displays selected Operation Mode. Selections include Menu, Average, Pk Hold, Min Hold and Store.  
Menu displays a menu window with selections Live, Recall, Compare, Live-Ref and Ref-Live.  
Live displays current signal without modification.  
Recall displays Stored trace only.  
Compare displays Stored trace and live trace simultaneously.  
In Live-Ref, the value of each point of the reference trace is subtracted from the current reading and the result is displayed.

# SECTION 3

## COMPOSITE

---

### 6. Mode (cont)

In Ref-Live, the value of current reading is subtracted from the stored value and the result is displayed.

Both Live-Ref and Ref-Live require a previously stored trace.

Average displays average of last four traces.

Pk Hold displays and holds the trace peak.

Min Hold displays and holds minimum trace.

Store places copy of current trace in memory.

### 7. H Pos

Displays selected horizontal offset in major divisions. Selections range from -10 to +10 Divisions.

### 8. V Pos

Accesses vertical position of trace. Trace above or below screen is indicated by straight line trace at top or bottom graticule.

### 9. Coupling

Displays selected Oscilloscope Coupling. Selections include AC, DC and GND (Ground).

### 10. Marker

User editable Marker controlled using MARKER Position (3). Movable through extent of visible screen.

### 11. Trigger Level Indicator

Indicates approximate level of Oscilloscope Trigger Level. Editable using TRIGGER (5).

### 12. Oscilloscope Scale

Displays selected Oscilloscope Vertical Scale.

# SECTION 3

## COMPOSITE

### 3-3-11 SPECTRUM ANALYZER SCREEN

The Independent Spectrum Analyzer Operation Screen operates independent of the Test Modes and is accessed by pressing the ANLYZ Instruments Key.

The Spectrum Analyzer Operation Screen displays in the configuration last used.



1. Logarithmic Function  
Displays Logarithmic Function for referencing Vertical Scale (1). Selections include dBm, dBμV, dBmV, dBV, dBμW and dBW.

2. Scan Width  
Displays selected Scan Width per division.

3. Zero Scan Sweep  
Displays selected Sweep per division.

4. Marker  
Marker controlled using Marker Position (8). Movable through extent of visible screen.

5. Center Frequency  
Displays Center Frequency. Selections range from 0.0000 to 1000.0000 MHz. For Scan Widths 32 MHz/div, start and stop frequencies must be above 0 MHz and below 1000 MHz.

6. Resolution Bandwidth  
Displays editable Resolution Bandwidth field for selected Scan Width (2).

7. UNCAL  
Displays UNCAL for settings that cause an uncalibrated condition.

8. Marker Position  
Displays Marker Position if Marker (4) is active or OFF if inactive.

9. Marker Level  
Displays current Marker Level if Marker (4) is active. Displays Blank if Marker (4) is OFF.

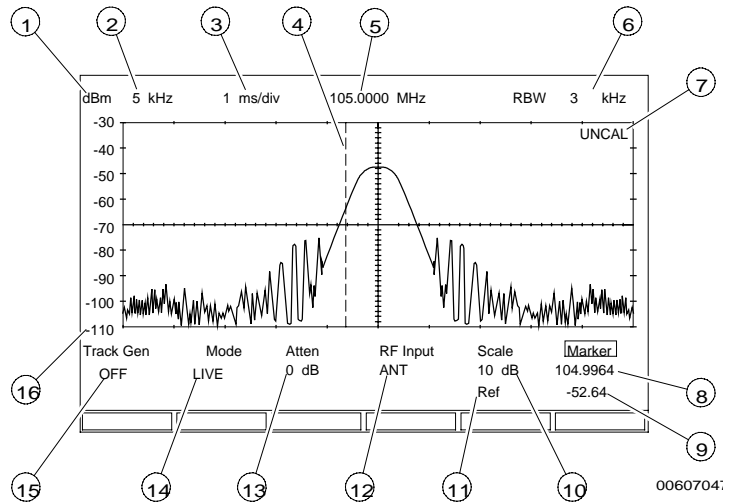

Spectrum Analyzer Screen

# SECTION 3

## COMPOSITE

---

10. Scale

Displays Logarithmic Scale for Vertical Scale (10). Selections are 2 and 10 dB.

11. Reference

Adjusts Spectrum Analyzer Vertical Scale (16)  $\pm 10$  dB when Scale (10) is set to 10 dB. When Scale (10) is set to 2 dB, adjusts Spectrum Analyzer Vertical Scale (10) through full range, displaying 16 dB window and incrementing in 1 dB steps.

12. RF Input

Displays RF Input. Selections are ANT (ANTENNA Connector) and T/R (T/R Connector).

13. Attenuation

Displays selected Attenuation for RF Input (12). Selections include 0 and 30 dB.

14. Mode

Displays selected Operation Mode. Selections include Menu, Average, Peak Hold, Minimum Hold and Store.

Menu displays a menu window with selections Live, Recall, Compare, Live-Ref and Ref-Live.

Live displays current signal without modification.

Recall displays Stored trace only.

Compare displays Stored trace and live trace simultaneously.

In Live-Ref, the value of each point of the reference trace is subtracted from the current reading and the result is displayed.

In Ref-Live, the value of current reading is subtracted from the stored value and the result is displayed.

Both Live-Ref and Ref-Live require a previously stored trace.

Average displays average of last four traces.

Pk Hold displays and holds the trace peak.

Min Hold displays and holds minimum trace.

Store places copy of current trace in memory.

15. Tracking Generator (Option 12)

Displays Tracking Generator Signal level available at AUX RF OUT Connector when active and OFF when inactive. Displayed only with Option 12 installed.

16. Vertical Scale

Provides logarithmic scale for trace. Position is controlled by Reference (11).

# SECTION 3

## COMPOSITE

### 3-3-12 AUDIO/DATA/SIGNALING GENERATORS SCREEN

The Audio/Data/Signaling Generators Operation Screen operates as an independent piece of test equipment.

Press the AUDIO GEN Instruments Key to access the Audio/Data/Signaling Generators Operation Screen. The screen displays in the configuration last used.

Four different generator screens, Audio Generator 1, Audio Generator 2, DTMF Generator and DATA Generator, display simultaneously. Any or all of the screens may be active at once.

The AUDIO/DATA GEN Connector is the output.



1. Audio Generator 1 Section

Defines and activates Audio Generator 1.

2. Active Source Block

Displays all active sources. Sources include GEN1 (Audio Generator 1), GEN2 (Audio Generator 2), DTMF (DTMF Tone Generator) and DATA (DATA Generator). Displays 'MAX LEVEL EXCEEDED' excessive level notification.

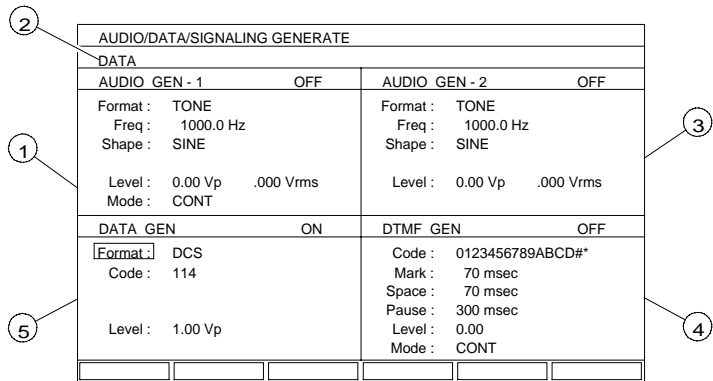

0060719f

Audio/ Data/ Signaling Generate Screen

3. Audio Generator 2 Section

Defines and activates Audio Generator 2.

4. DTMF Generator Section

Defines and activates DTMF Generator.

5. DATA Generator Section

Defines and activates DATA Generator

# SECTION 3

## COMPOSITE

### 3-3-13 METER SCREENS

The COM-120C provides meters that operate independently.

Pressing MTRS Instruments Key accesses a Meters Menu for accessing independent Meters. To access a meter, cursor to desired selection and press ENTER Key or press corresponding Soft Function Key.



1. Audio Frequency Counter

The Audio Frequency (AF) Counter counts the audio signal supplied at the indicated source.

2. SINAD Meter

The SINAD Meter determines SINAD for a 1 kHz tone passed to the COM-120C through the specified Source.

3. Digital Voltmeter

The Digital Voltmeter (DVM) measures voltage at the indicated Source. The units are dependent on the Source.

4. Distortion Meter

The Distortion Meter determines Distortion for a 1 kHz tone passed to the COM-120C through the specified Source.

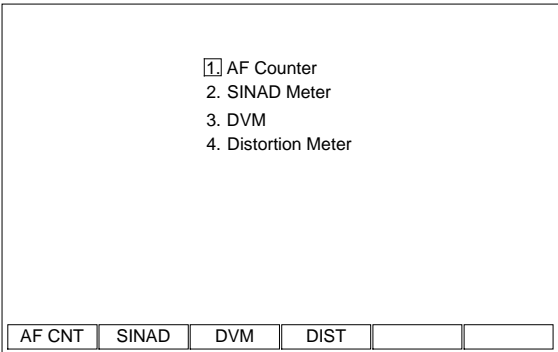

8717017

Meters Menu Screen

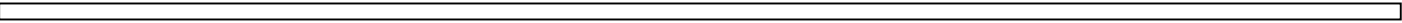

# SECTION 3

## COMPOSITE

---

### 3-3-14 MEMORY LISTS AND STORAGE OF PARAMETERS

The COM-120C offers two ways to use memory to store parameters.

Make a Frequency List specifying a frequency for Generating, a frequency for Receiving and an Offset for Duplex.

Or, store all parameters of RF Generate, RF Receive and Duplex Operation Screens, including supporting meters and operation screens in a Setup List. The Lists are accessible from a List Setup Screen and is accessed by pressing the SHOW LIST Memory Key.



#### 1. Stored Frequency List

Accessing the Stored Frequency List displays a screen for editing the Frequency List.

Move the cursor to any frequency or label field. Up to 100 Frequency List entries (0-99) are used for entering a Generate frequency, a Receive frequency and a Duplex Offset.

Accessing a Frequency List Parameter from the RF Generate Operation Screen affects only that screen. The same is true for the RF Receive Operation Screen.

Accessing a Frequency List Parameter from any Duplex Operation Screen activates the Generate Frequency, the Receive Frequency and Duplex Offset.

Whenever used, the Label is also activated for any Operation Screen.

#### 2. Stored Setup List

Accessing the Stored Setup List displays a screen for editing the Stored Setup List.

The Stored Setup List displays Stored Setups by List Number Setup Type and an optional Label. Store up to 50 Setups of RF Generate, RF Receive or Duplex Operation Screens.

The parameters of the screens and all selected meters are stored for future recall.

#### 3. Stored Files

Accessing Stored Files displays a File List Screen for editing Stored Files. Files are displayed by Name, Type, Size, Date, Time and Attr (Attributes).

The DRIVE field selections are INTERNAL (COM-120C's Flash) and PCMCIA. The PATH field allows a path entry as a string.

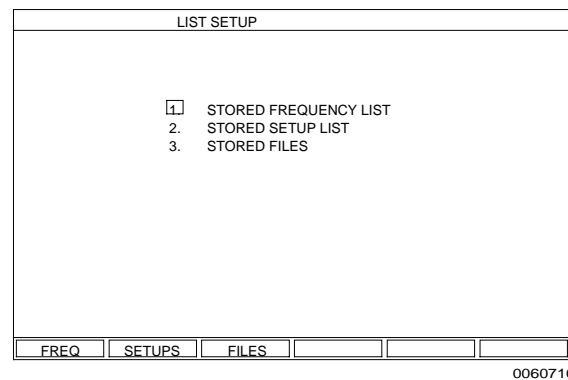

List Setup Screen

# SECTION 3 COMPOSITE

## 3-3-15 UTILITY FUNCTION SCREENS

The Setup Screen allows access to system configuration and provides information on system status and is accessed by pressing SETUP Memory Key.

Place cursor on desired utility number and press ENTER Key.

Each Setup Screen selection accesses another screen for performing the desired function.



1. Calibration

The Calibration selection is under password security and is not covered in this manual.

2. Clock/Calendar

The Clock/Calendar Screen is used to set the COM-120C internal clock.

3. Version

This screen reports the current Software Version of the COM-120C programmed devices and displays the installed options.

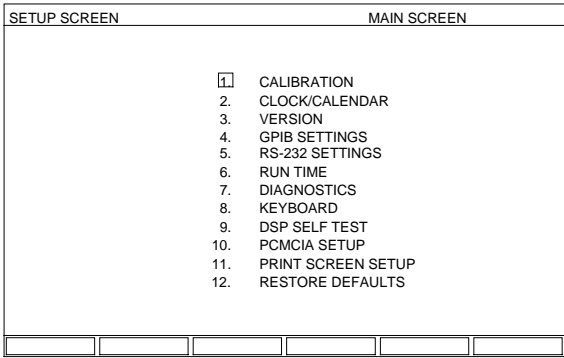

Utility Setup Screen

4. GPIB Settings

The GPIB Setup Screen is used to configure the COM-120C GPIB Protocol.

5. RS-232 Settings

The RS-232 Setup Screen is used to configure the COM-120C RS-232 Protocol.

6. Run Time

The System Run Time Screen displays COM-120C cumulative time spent in operation. Time is displayed in Hours and Minutes.

7. Diagnostics

The System Diagnostics Screen displays a menu to access specific Diagnostic Screens.

<b>Diagnostic</b>	<b>Description</b>	<b>Diagnostic</b>	<b>Description</b>
Battery and Temperature	Displays Battery Voltage and Power Term Temperature.	Synthesizers Lock Test	Displays current status of synthesizers in the Test Set.
Synthesizer Response Test	Used to test Synthesizer Response.	Self Test	Used for performing Self Test and reading results.



# SECTION 3

## COMPOSITE

---

8. Keyboard

The Keyboard Setup Screen accesses specific operation parameters.

9. DSP Selftest

The DSP Selftest screen is for performing selftests and reading results. Use the Soft Function Keys to activate the desired test. Each performed test receives a PASS/FAIL indication.

10. PCMCIA Setup

A variety of screens appear under this setup entry depending on the type of PCMCIA card installed.

The COM-120C PCMCIA card slot is another Input/Output Source when a PCMCIA card is inserted.

11. Print Screen Setup

The Print Screen Setup allows the COM-120C to print to a File, RS-232, PCMCIA card or GPIB. Drive, File, Type, Print Mode and Format are all configurable.

12. Restore Defaults

When selected, the COM-120C immediately restores the Receiver, Generator, Duplex, screens, etc. to the original factory defaults.

# SECTION 4 OPERATION

## 4-1 RF GENERATE OPERATION

This section provides information on configuring the COM-120C to perform tests on the receiver.

Press the GEN MODE Key to access the RF Generate Operation Screen. In this mode, the COM-120C acts as a transmitter to test a receiver.

The intention is to provide sufficient information to allow the operator to effectively use the COM-120C to perform specific operator defined tests.

### 4-1-1 GENERAL RF GENERATE OPERATION

- Enter desired frequency in RF Field.

Frequency range is 0.0000 to 1000.0000 MHz.

Activate additional functions as desired.

To operate with  $\Delta$  Function active:

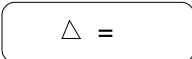

Activates window to increment RF Field. Range is 0 to 500 MHz.

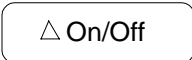
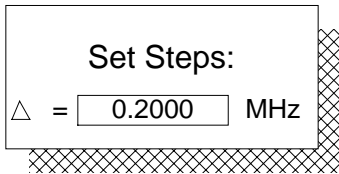

Activate/deactivate  $\Delta$  Function. Prompt displays by RF Field.

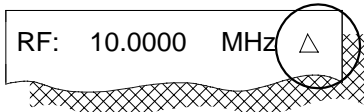

To Operate with Set Reference Function:



**R** appears beside RF Field. When active, RF Field is set to 0 MHz and changes made to RF Field display offset from Reference Frequency. To deactivate Set Reference Function, press SET REF until **R** is not visible.

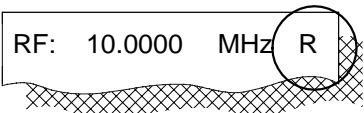

To Operate with Sweep Operation:



Opens Sweep Configuration Window. Once Sweep Configuration Window is opened, enter start frequency, stop frequency, increment for sweep operation and pause time at each frequency. Press F1 to start continuous sweep, F2 to stop the sweep, F3 for single sweep and F5 to resume a halted sweep. Press F6 to exit.

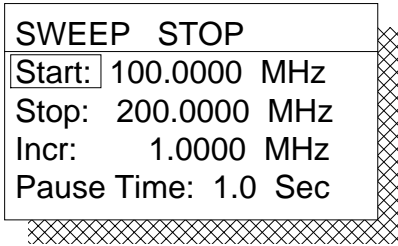

# SECTION 4

## OPERATION

---



Set Reference and Sweep Function work independently, never simultaneously.

LOCK

UNLOCK

To Operate with RF Generate, RF Receive and Spectrum Analyzer RF Frequencies locked, press F5 until L is displayed beside RF Field. Press F5 again to unlock.

RF: 10.0000 MHz L

- If Frequency List Operation is desired instead of entering frequency in RF Field, select Frequency List Setting as follows:

On/Off

Activates Frequency List Setting.

T-Fwd

Selects Trunking Forward Channel List.

T-Rvs

Selects Trunking Reverse Channel List.

C-Fwd

Selects Cellular Forward Channel List.

C-Rvs

Select Cellular Reverse Channel List.

FL

Select User Defined Frequency List.

RF: 10.0000 MHz  
FL: OFF  
Level: -30.0 dBm  
Output: T/R

If Cellular Channel List or User Defined Frequency List is selected, enter channel/frequency number. Range of cellular channels is 1 to 1023. Range of Frequency List is 0 to 99.

If Trunking Channel List is selected, select channel number. Select Frequency Band. Select desired Frequency Band using DATA SCROLL Keys or DATA SCROLL Spinner. Press ENTER Key.

# SECTION 4 OPERATION

❑ Set Output Level Units as follows:

dBm	Selects dBm as Output Level Units.
uV	Selects $\mu$ V as Output Level Units.
mV	Selects mV as Output Level Units.
V	Selects V as Output Level Units.
SINAD=	Accesses SINAD Search Function.
S=On/Off	Activates/deactivates SINAD Search Function.

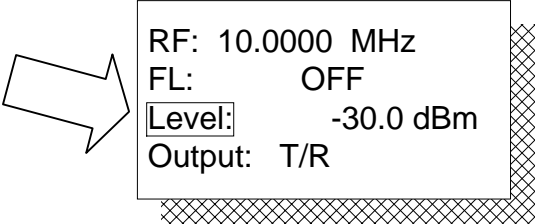

To operate with SINAD Search Function:	
SINAD=	Accesses field to set SINAD Search Function value. Range of SINAD= is 6 to 55 dB.
S=On/Off	<b>S=</b> is displayed beside Output Level Field to activate SINAD Search Function. Press F6 again to deactivate.

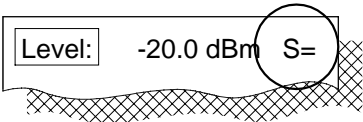
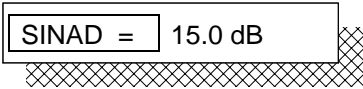

# SECTION 4

## OPERATION

---

Select Output as follows:

T/R

Selects T/R Connector as output connector.

AUX

Selects AUX RF Connector as output connector.

T/R Gate

Selects T/R Connector as gated output connector.

AUX Gate

Selects AUX RF Connector as gated output connector.

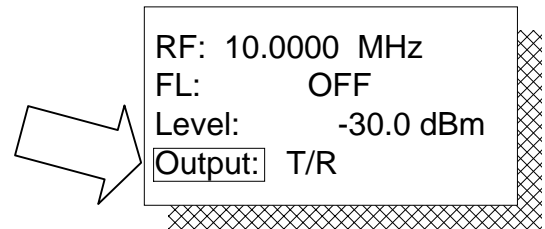

- ❑ Modulation Source Window displays all active Function Generators. To activate or deactivate Function Generators, each Function Generator must be edited separately.



If two (or more) sections of the RF Modulator are set in conflict (e.g. GEN1 set for PM and GEN2 set for FM, or GEN1 set for 0.001 kHz deviation and GEN2 set for 2.60 kHz deviation) the screen displays the invalid source grayed out.

Set Modulation Source Block as follows:

GEN1

If Audio Generator 1 Operation is desired.

GEN2

If Audio Generator 2 Operation is desired.

DATA

If DATA Generator Operation is desired.

DTMF

If DTMF Generator Operation is desired.

MIC

If Microphone Modulation Operation is desired.

EXT

If External Modulation Operation is desired.

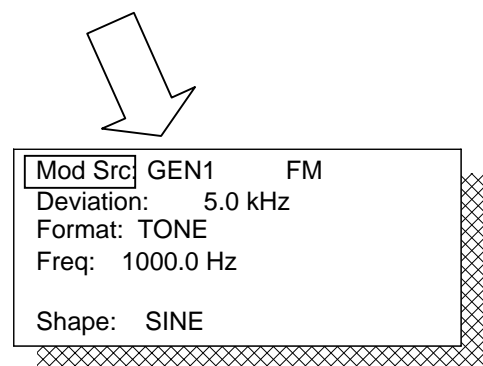

# SECTION 4 OPERATION

- ❑ If Audio Generator 1 or 2 Operation is desired, press F1 or F2 to select GEN1 or GEN2 for Modulation Source and cursor to OFF.

Select the desired Modulation Type:

OFF

Modulation OFF.

AM

Range is 0.0% to 100.0% for AM Modulation.

FM

Range is 0.00 to 100 kHz for FM Modulation.

PM

Range is 0.00 to 10 Radians for PM Modulation.

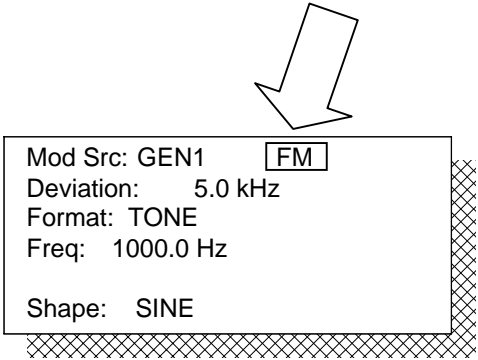

- ❑ Enter Deviation/Modulation Level.

Select the desired Format.

MENU

Accesses a menu with available format selections.

Select transmission type:

CONT

Selects continuous transmission of signal.

BURST

For single transmission of selected signal.

TIME

Accesses Burst Time Window if TONE is the selected format.

CONFIG

Accesses Configuration Window if USER is the selected format.

Used to configure User Selectable Frequency and Duration for codes 0 through 9 and A through T.

Enter desired frequencies and durations for codes. Range of frequencies are 0 to 9999.9 Hz. Range of durations are 0 to 99.999 seconds.

Use F1 and F2 to scroll up or down through Configuration Window. Use F3 to fill remainder of current column with value of current cursor position.

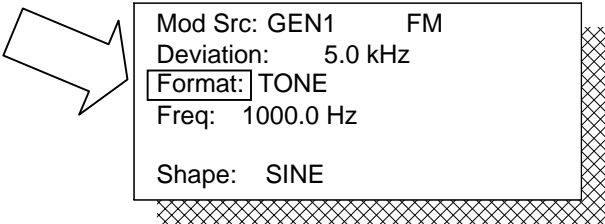

# SECTION 4

## OPERATION

---

- ❑ If TONE is selected as Format, enter Audio Tone Frequency.
- ❑ If TONE is selected as Format, enter Shape.

Range is 5 to 20000 Hz with Shape set to SINE. Range is 5 to 10000 Hz otherwise.

Select Shape of Wave as follows:

SINE

Selects SINE Wave Shape.

RAMP

Selects RAMP Wave Shape.

TRIANGLE

Selects TRIANGLE Wave Shape.

SQUARE

Selects SQUARE Wave Shape.

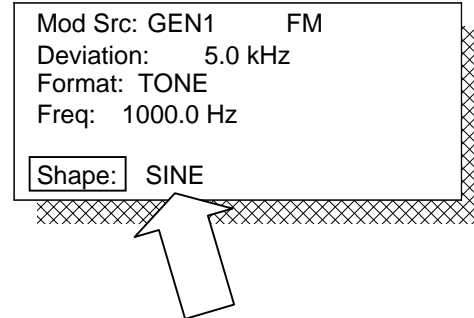

Mod Src: GEN1 FM  
Deviation: 5.0 kHz  
Format: TONE  
Freq: 1000.0 Hz

Shape: SINE

- ❑ If TONE is not selected Format, enter Code.

CLEAR

Clears current code entry.

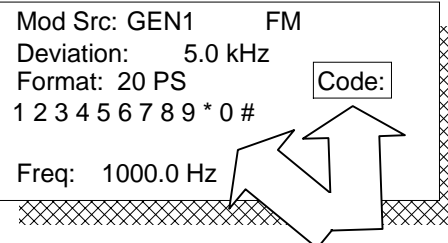

Mod Src: GEN1 FM  
Deviation: 5.0 kHz  
Format: 20 PS  
1 2 3 4 5 6 7 8 9 \* 0 #

Code: Freq: 1000.0 Hz

# SECTION 4 OPERATION

- If DTMF Generator Operation is desired, press F3 to select DTMF for Modulation Source and cursor to OFF.

Select the desired Modulation Type:

OFF

Modulation OFF.

AM

Range is 0.0% to 100.0% for AM Modulation.

FM

Range is 0.00 to 100 kHz for FM Modulation.

PM

Range is 0.00 to 10 Radians for PM Modulation.

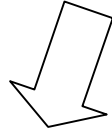

```
Mod Src: DTMF  FM
Deviation: 1.0 kHz
Code: 0123456789#*
Mark: 70 msec
Space: 70 msec
Pause: 300 msec
```

- Enter Deviation/Modulation Level.
- Enter DTMF Code.

Select the desired Operation:

CLEAR

Clears code field of current data.

CONT

Activates DTMF Code in repeating loop.

BURST

Activates DTMF Code for one tone sequence.

KEY

Sets DATA ENTRY Keys as DTMF keypad.

```
Mod Src: DTMF  FM
Deviation: 1.0 kHz
Code: 0123456789#*
Mark: 70 msec
Space: 70 msec
Pause: 300 msec
```

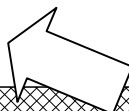

- Enter selected Mark Time for DTMF tones. Range is 10 to 999 ms.
- Enter selected Space Time for DTMF tones. Range is 1 to 999 ms.
- Enter selected Pause Time for DTMF tones Range is 1 to 999 ms.



# SECTION 4

## OPERATION

---

- ❑ If DATA Generator Operation is desired, press F4 to select DTMF for Modulation Source and cursor to OFF.

Select the desired Modulation Type:

OFF

Modulation OFF.

AM

Range is 0.0% to 100.0% for AM Modulation.

FM

Range is 0.00 to 100 kHz for FM Modulation.

PM

Range is 0.00 to 10 Radians for PM Modulation.

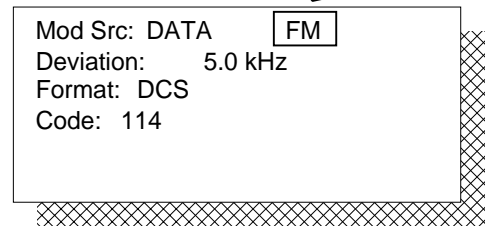
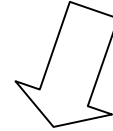

- ❑ Enter Deviation/Modulation Level.

Select the desired Format.

MENU

Accesses a menu with available format selections.  
Cursor to DCS, DCS INV, POCSAG or POCSAG INV  
Format and press ENTER.

- ❑ Enter desired Code. Range is 000 (Octal) to 777 (Octal).

# SECTION 4 OPERATION

- ❑ If Microphone Modulation Operation is desired, press F5 to set MIC for Modulation Source and cursor to OFF.

Select the desired Modulation Type:

OFF

Modulation OFF.

AM

For AM Modulation.

FM

For FM Modulation.

PM

For PM Modulation.

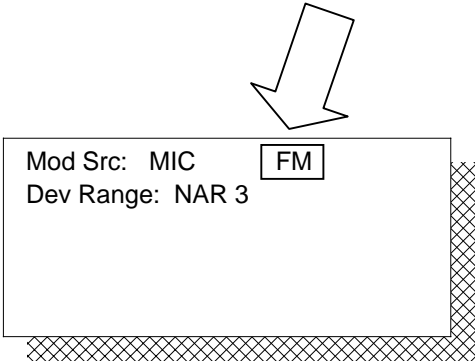

If FM Modulation is selected, set Deviation Range as follows:

NAR 3

For Deviation Range setting for deviation <2 kHz.

NAR 2

For Deviation Range setting for deviation 2 kHz to 12.75 kHz.

NAR 1

For Deviation Range setting for deviation 12.75 kHz to 25 kHz.

WIDE

For Deviation Range setting for deviation >25 kHz.

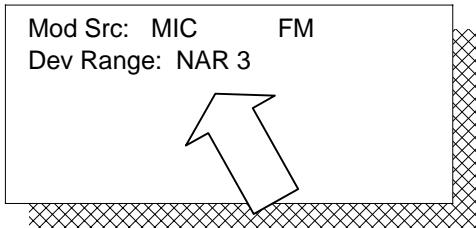

# SECTION 4

## OPERATION

---

- ❑ If External Modulation Operation is desired, press F6 to select EXT Modulation Source and cursor to OFF.

Select the desired Modulation Type:

OFF

Modulation OFF.

AM

For AM Modulation.

FM

For FM Modulation.

PM

For PM Modulation.

SET

Preserves settings.



Mod Src: EXT FM  
Dev Range: NAR 3  
Deviation: 1.00 kHz

If FM Modulation is selected, set Deviation Range as follows:

NAR 3

For Deviation Range setting for deviation <2 kHz.

NAR 2

For Deviation Range setting for deviation 2 kHz to 12.75 kHz.

NAR 1

For Deviation Range setting for deviation 12.75 kHz to 25 kHz.

WIDE

For Deviation Range setting for deviation >25 kHz. Deviation Range automatically sets to WIDE if total deviation of FM sources exceeds 20 kHz.

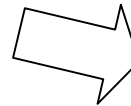

Mod Src: EXT FM  
Dev Range: NAR 3  
Deviation: 1.00 kHz

# SECTION 4 OPERATION

- ❑ If Audio/Data Filters are required for operation of Meters or Speaker, configure and activate required filters.



High-Pass Filter/Low-Pass Filter combination and Bandpass Filter never operate simultaneously on same Filter Line.

**CONFIG**

Accesses RF Generator Filters Menu when cursor is on the Filter Line.

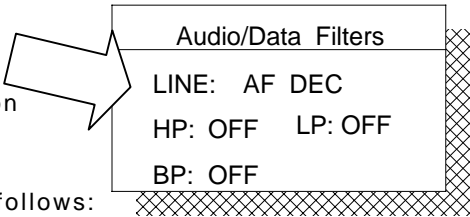

Select DTMF/SINAD Bandpass Filter Field setting as follows:

**OFF**

Sets Filter to OFF.

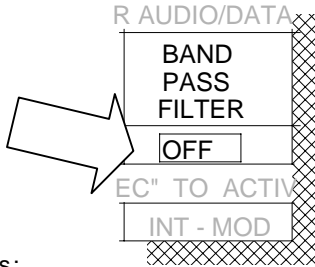

**C-MSG**

Selects C-Message Weighted Filter.

Select DTMF/SINAD High-Pass Filter Field setting as follows:

**OFF**

Sets Filter to OFF.

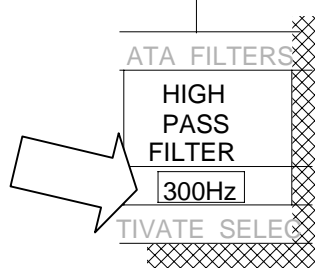

**300Hz**

Activates 300 Hz High-Pass Filter.

Select DTMF/SINAD Low-Pass Filter Field setting as follows:

**OFF**

Press OFF Soft Function Key F1 to set Filter to OFF.

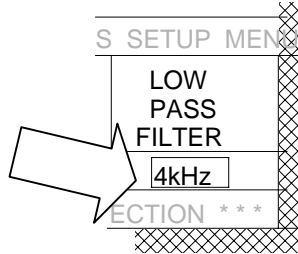

**4kHz**

Activates 4 kHz Low-Pass Filter.

**20kHz**

Activates 20 kHz Low-Pass Filter.

**EXEC**

Executes all edits made to the screen.

# SECTION 4

## OPERATION

---

Select Speaker/Headphones Filter Field setting as follows:

OFF

Press OFF Soft Function Key F1 to set Filter to OFF.

C-MSG

Selects C-Message Weighted Filter.

W.B.

Selects no filtering.

INT-MOD

Routes from Internal Modulation Sources to Speaker.

RETURN

Returns to RF Generate Operation Screen.

To display different Filter Line settings:

AF-DEC

Displays DTMF/SINAD Filter Settings.

SPKR

Displays Speaker/ Headphones Filter Settings.

❑ Select desired Meter Operation as follows:

SINAD

Selects SINAD Meter as active meter. Not displayed if meter is currently active.

DIST

Selects Distortion Meter as active meter. Not displayed if meter is currently active.

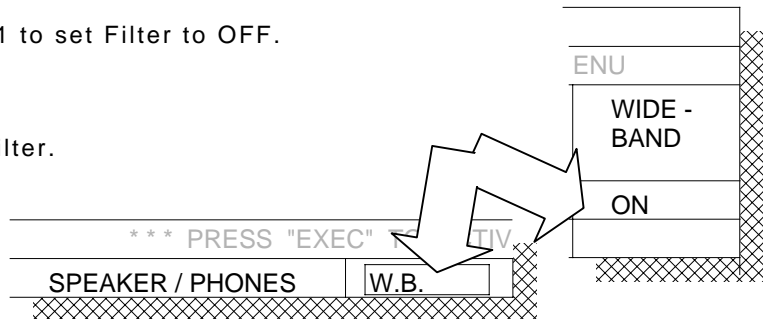

# SECTION 4 OPERATION

## 4-1-2 SINAD METER OPERATION

The SINAD Meter for the RF Generate Operation Screen measures SINAD for an audio signal passed through the AUDIO/DATA IN Connector. Filtering for the signal passed to the SINAD Meter is provided by the Audio/Data Filters.

Configure and operate the SINAD Meter as follows:

**ZOOM**

Displays full screen SINAD Meter.

- Enter RF Gen Level as required.

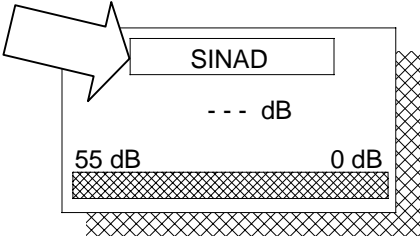

Editing RF field affects level on RF Generate Operation Screen.

To operate with SINAD Search Function:

**dBm**

Selects dBm as RF Level Units.

**uV**

Selects uV as RF Level Units.

**mV**

Selects mV as RF Level Units.

**V**

Selects V as RF Level Units.

**SINAD=**

Accesses field to set SINAD Search Function value. Range of SINAD= is 6 to 55 dB.

**S=On/Off**

**S=** is displayed beside RF Level Field to activate SINAD Search Function. Press F6 again to deactivate.

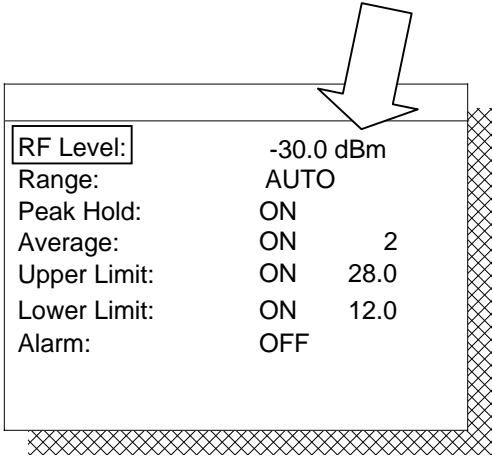

# SECTION 4

## OPERATION

---

Select Range as follows:

15 dB

Selects 15 dB Range.

55 dB

Selects 55 dB Range.

AUTO

Selects Autorange for Range.

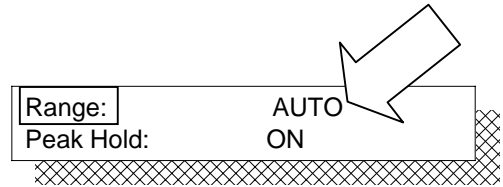

If Peak Hold Function is desired, take meter out of Autorange and configure as follows:

OFF/ON

Toggles Peak Hold Function ON or OFF.

RST PK

Resets Peak Hold Function.

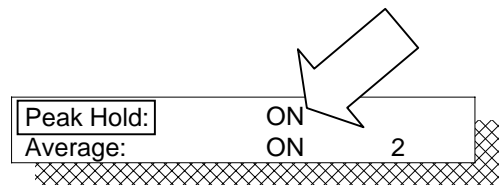

If Average Function is desired, configure as follows:

OFF/ON

Toggles Average Function ON or OFF. Cursor to Sample Number to enter desired value. Range is 2 to 10.

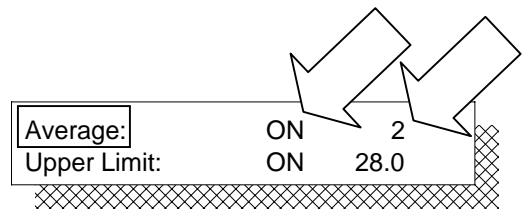

If Upper Limit Function is desired, configure as follows:

OFF/ON

Toggles Upper Limit Function ON or OFF. Enter Limit Value. Range is 0 to 55 dB.

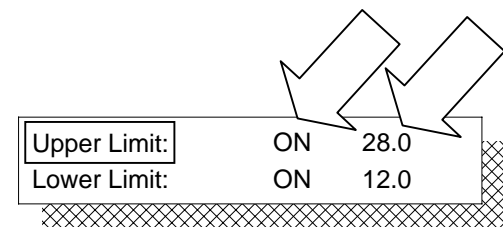

If Lower Limit Function is desired, configure as follows:

OFF/ON

Toggles Lower Limit Function ON or OFF. Enter Limit Value. Range is 0 to 55 dB.

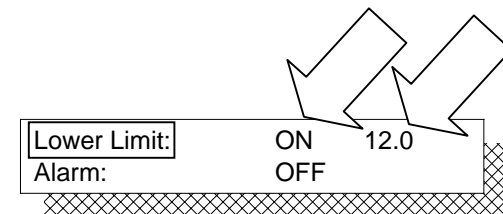

# SECTION 4 OPERATION

---

If Alarm Function is desired, configure as follows:

OFF/ON

Toggles Alarm Function ON or OFF. When activated, alarm alerts over range condition.

RETURN

Returns to RF Generate Operation Screen.

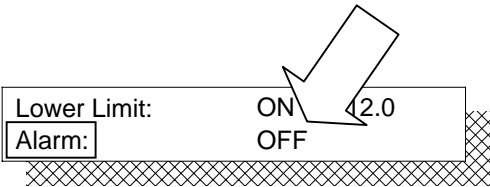



# SECTION 4

## OPERATION

### 4-1-3 DISTORTION METER OPERATION

The Distortion Meter for the RF Generate Operation Screen measures Distortion for an audio signal passed through the AUDIO/DATA IN Connector. Filtering for the signal passed to the Distortion Meter is provided by the Audio/Data Filters.

Configure and operate the Distortion Meter as follows:

ZOOM

Displays full screen Distortion Meter.

- Enter RF Gen Level as required.

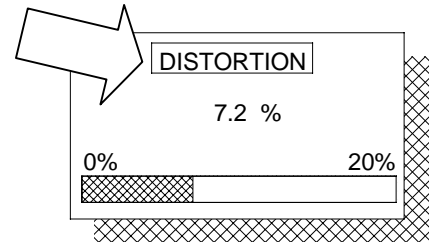

Editing RF field affects level on RF Generate Operation Screen.

dBm

Selects dBm as RF Level Units.

uV

Selects uV as RF Level Units.

mV

Selects mV as RF Level Units.

V

Selects V as RF Level Units.

Select Range as follows:

20%

Selects 20% Range.

100%

Selects 100% Range.

AUTO

Selects Autorange for Range.

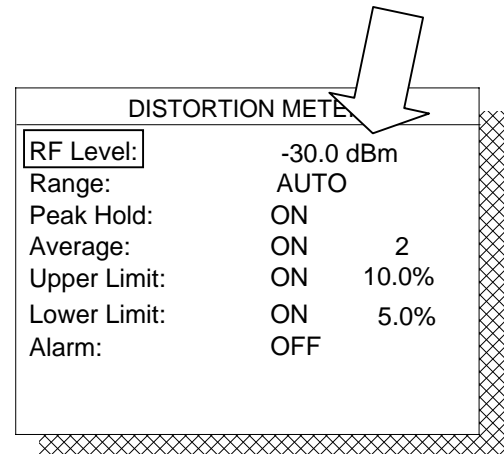

# SECTION 4 OPERATION

If Peak Hold Function is desired, take meter out of Autorange and configure as follows:

OFF/ON

Toggles Peak Hold Function ON or OFF.

RST PK

Resets Peak Hold Function.

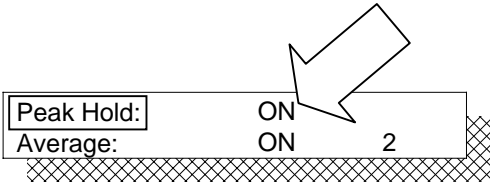

If Average Function is desired, configure as follows:

OFF/ON

Toggles Average Function ON or OFF. Cursor to Sample Number to enter desired value. Range is 2 to 10.

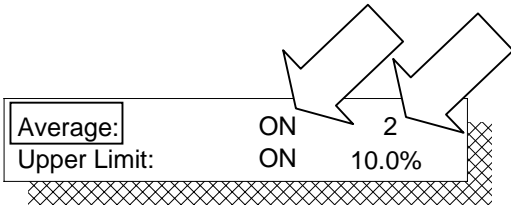

If Upper Limit Function is desired, configure as follows:

OFF/ON

Toggles Upper Limit Function ON or OFF. Enter Limit Value. Range is 0.0 to 100.0%.

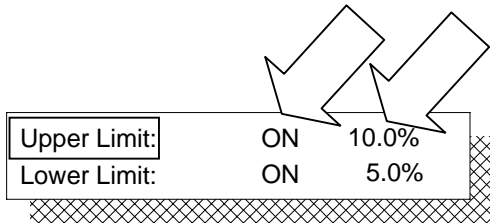

If Lower Limit Function is desired, configure as follows:

OFF/ON

Toggles Lower Limit Function ON or OFF. Enter Limit Value. Range is 0.0 to 100.0%.

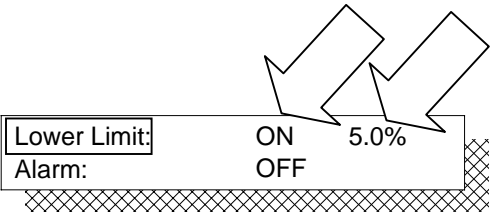

If Alarm Function is desired, configure as follows:

OFF/ON

Toggles Alarm Function ON or OFF. When activated, alarm alerts over range condition.

RETURN

Returns to RF Generate Operation Screen.

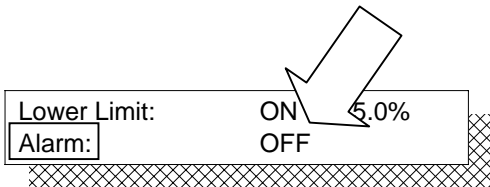

# SECTION 4

## OPERATION

---

### 4-1-4 AUDIO FREQUENCY LEVEL METER OPERATION

The Audio Frequency Level Meter for the RF Generate measures the level of an audio signal passed through the AUDIO/DATA IN Connector. Measurements made are in Vrms, dBm (referenced to Impedance [16]) or dB as selected.

Configure and operate the AF Level Meter as follows:

ZOOM

Displays full screen AF Level Meter.

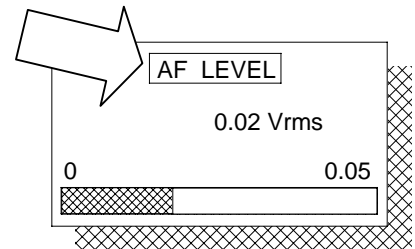

If measuring Vrms, select desired Range:

MENU

Displays Range selections including Autorange.



Selecting units of dBm or dB sets Range to AUTO (Autorange).

If Peak Hold Function is desired, take meter out of Autorange and configure as follows:

OFF/ON

Toggles Peak Hold Function ON or OFF. Displays Peak High and Peak Low digital readout when ON.

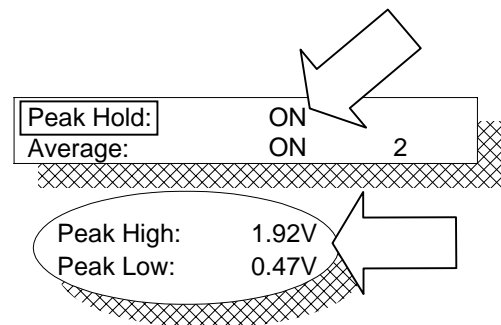

RST PK

Resets Peak Hold Function.

If Average Function is desired, configure as follows:

OFF/ON

Toggles Average Function ON or OFF. Cursor to Sample Number to enter desired value. Range is 2 to 10.

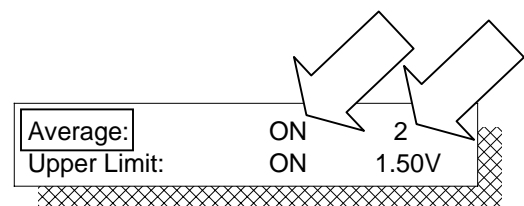

# SECTION 4 OPERATION

If Upper Limit Function is desired, configure as follows:

**OFF/ON**

Toggles Upper Limit Function ON or OFF. Enter Limit Value. Range is 0.00 to 50.00 Vrms.

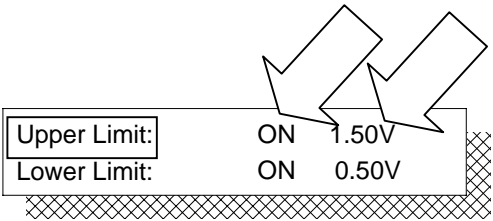

If Lower Limit Function is desired, configure as follows:

**OFF/ON**

Toggles Lower Limit Function ON or OFF. Enter Limit Value. Range is 0.00 to 50.00 Vrms.

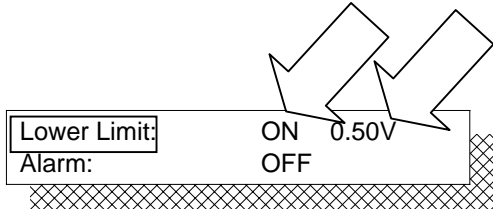

If Alarm Function is desired, configure as follows:

**OFF/ON**

Toggles Alarm Function ON or OFF. When activated, alarm alerts over range condition.

**RETURN**

Returns to RF Generate Operation Screen.

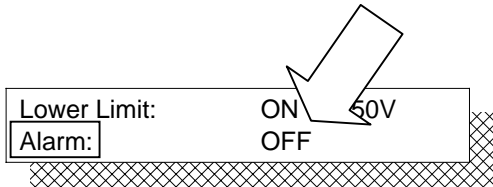

Select desired units for digital readout as follows:

**Vrms**

Select Vrms as units.

**dBm**

Select dBm as units. Range is 0 to 1000 Ω.

**dB**

Select dB as units. Press F3 as needed to set current reading as Reference.

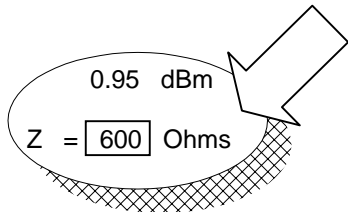

# SECTION 4

## OPERATION

### 4-1-5 OSCILLOSCOPE OPERATION SCREEN

The RF Generator Oscilloscope is usable as an abbreviated or full screen Oscilloscope.

The abbreviated Oscilloscope is visible from the RF Generate Operation Screen and the SINAD, Distortion and Audio Frequency Level Meters.

The zoomed, or full screen, Oscilloscope maintains the configuration of the abbreviated Oscilloscope and vice versa.

Oscilloscope parameters set on any of the Operation Screens remain constant on all screens.



Configuring the abbreviated Oscilloscope is as follows:

**MENU**

Accesses a list of sweep settings.

**ROLL**

To view the scope trace in a roll mode. The selected sweep rate must be 100 ms/div or higher.

**SLOW**

To return to normal mode of operation.

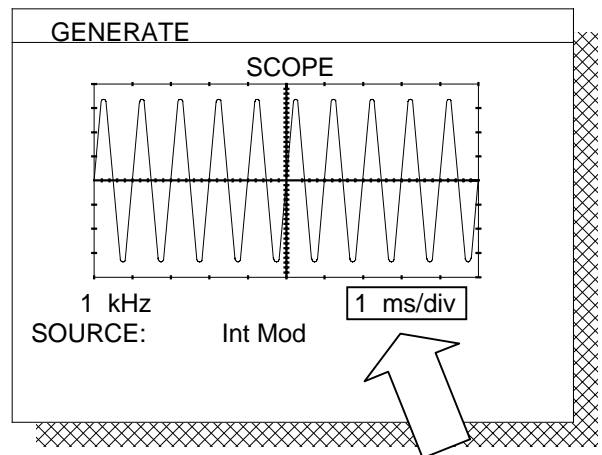

Select Scope Source. Refer to this selection table.

Source	Signal Input	Signal Type
Scope/DVM-GND	SCOPE/ DVM Connector	External GND-Coupled Signal
Scope/DVM-AC	SCOPE/DVM Connector	External AC-Coupled Signal
Scope/DVM-DC	SCOPE/DVM Connector	External DC-Coupled Signal
Ext Mod	EXT MOD IN Connector	External Modulation

Source	Signal Input	Signal Type
Notch Residual	Internal Filtered Signal	Notch Filtered Signal passed to SINAD and Distortion Meters. Reading is relative with no units applied.
Audio/Data In	AUDIO/DATA IN Connector	External Audio or Data Signal
Int Mod	Internal Modulation	Composite Modulation Signal generated by Internal Audio/Data Generators

# SECTION 4

## OPERATION

Select Oscilloscope Scale. Refer to this selection table.

Scope Source	Available Scales
Scope/DVM-GND	10, 20, 50, 100, 200, 500 mV/Div 1, 2, 5, 10, 20, 50 V/Div
Scope/DVM-AC	10, 20, 50, 100, 200, 500 mV/Div 1, 2, 5, 10, 20, 50 V/Div
Scope/DVM-DC	10, 20, 50, 100, 200, 500 mV 1, 2, 5, 10, 20, 50 V
Ext Mod	100, 200, 500 mV/Div 1, 2, 5 V/Div

Scope Source	Available Scales
Notch Residual	0.20, 0.04, 0.10, 0.20, 0.40, 1.00
Audio/Data In	100, 200, 500 mV/Div 1, 2, 5 V/Div
<u>Int Mod</u>	
GEN1 FM >25 kHz:	1, 2, 5, 10, 20, 50 kHz/Div
GEN1 FM 2.5 to 12.75 kHz:	1, 2, 5, 10, 20, 50 kHz/Div
GEN1 FM 12.75 to 25 kHz:	0.2, 0.4, 1, 2, 4, 10 kHz/Div
GEN1 FM <2.5 kHz:	0.2, 0.4, 1, 2, 4, 10 kHz/Div
GEN1 PM <2.55 RAD:	0.2, 0.4, 1, 2, 4, 10 RAD
GEN1 PM >2.55 RAD:	1, 2, 5, 10, 20, 50 RAD
GEN1 AM:	All Settings 20%

# SECTION 4

## OPERATION

---

Press F1 to access full screen Oscilloscope when cursor is on SCOPE.



Select Scope Source *before* accessing full screen Oscilloscope.

---

Configure full screen Oscilloscope as follows:

MENU

Accesses a list of sweep settings.

ROLL

To view the scope trace in a roll mode. The selected sweep rate must be 100 ms/div or higher.

SLOW

To return to normal mode of operation.

Configure full screen Oscilloscope as follows:

NORM

Selects Normalized Trigger.

AUTO

Selects Auto Trigger.

1 SHOT

Selects and resets One Shot Trigger.

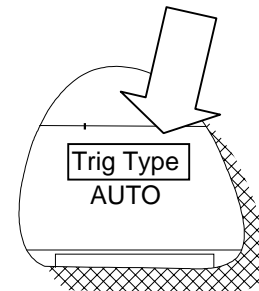
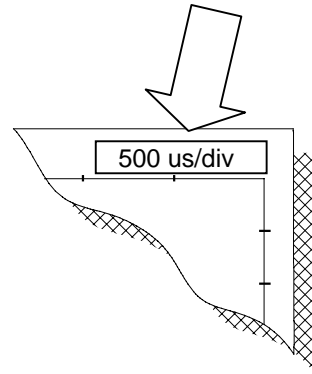

# SECTION 4

## OPERATION

---

Select Operation Mode as follows:

MENU

Accesses Operation Mode menu selections.

LIVE

Selects Live Operation Mode.

RECALL

Selects Recall Operation Mode.

COMPARE

Selects Compare Operation Mode.

LIVE-REF

Selects Live-Ref Operation Mode.

REF-LIVE

Selects Ref-Live Operation Mode.

RETURN

Exits to Generate Scope.

AVG

Selects Average Operation Mode.

PK HOLD

Selects Peak Hold Operation Mode.

MIN HOLD

Selects Minimum Hold Operation Mode.

STORE

Stores the current trace.

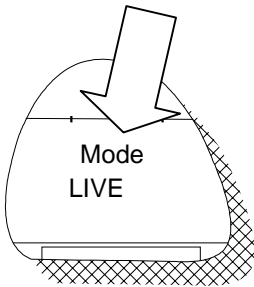



# SECTION 4

## OPERATION

- Select H Pos Offset as needed. Range is -10 to 10 Divisions.
- Set Vertical Position of trace as needed by accessing V Pos and editing with DATA SCROLL Keys or DATA SCROLL Spinner.
- Select Oscilloscope Scale.  
Selections available are dependent on Scope Source.

Scope Source	Available Scales
Scope/DVM-GND	10, 20, 50, 100, 200, 500 mV/Div 1, 2, 5, 10, 20, 50 V/Div
Scope/DVM-AC	10, 20, 50, 100, 200, 500 mV/Div 1, 2, 5, 10, 20, 50 V/Div
Scope/DVM-DC	10, 20, 50, 100, 200, 500 mV 1, 2, 5, 10, 20, 50 V
Ext Mod	100, 200, 500 mV/Div 1, 2, 5 V/Div

Scope Source	Available Scales
Notch Residual	0.20, 0.04, 0.10, 0.20, 0.40, 1.00
Audio/Data In	100, 200, 500 mV/Div 1, 2, 5 V/Div
<u>Int Mod</u>	
GEN1 FM >25 kHz:	1, 2, 5, 10, 20, 50 kHz/Div
GEN1 FM 2.5 to 12.75 kHz:	1, 2, 5, 10, 20, 50 kHz/Div
GEN1 FM 12.75 to 25 kHz:	0.2, 0.4, 1, 2, 4, 10 kHz/Div
GEN1 FM <2.5 kHz:	0.2, 0.4, 1, 2, 4, 10 kHz/Div
GEN1 PM <2.55 RAD:	0.2, 0.4, 1, 2, 4, 10 RAD
GEN1 PM >2.55 RAD:	1, 2, 5, 10, 20, 50 RAD
GEN1 AM:	All Settings 20%

- Activate Marker as required.

On/Off

Activates Marker. Entered desired Marker position using DATA ENTRY keys or DATA SCROLL Keys and/or DATA SCROLL Spinner.

# SECTION 4 OPERATION

## 4-1-6 SPECTRUM ANALYZER OPERATION SCREEN

The RF Generator Spectrum Analyzer is usable as an abbreviated or full screen Spectrum Analyzer.

The abbreviated Spectrum Analyzer is visible from the RF Generate Operation Screen and the SINAD Meter, Distortion Meter and Audio Frequency Level Meters.

The zoomed, or full screen, Spectrum Analyzer maintains the configuration of the abbreviated Spectrum Analyzer and vice versa.

Spectrum Analyzer parameters set on any of the Operation Screens remain constant on all screens.



Configuring the abbreviated Spectrum Analyzer is as follows:

MENU

Accesses a list of Scan Width settings.

CONFIG

Accesses a pop up screen to configure Scan Width, Resolution Bandwidth (RBW) and Sweep rate.

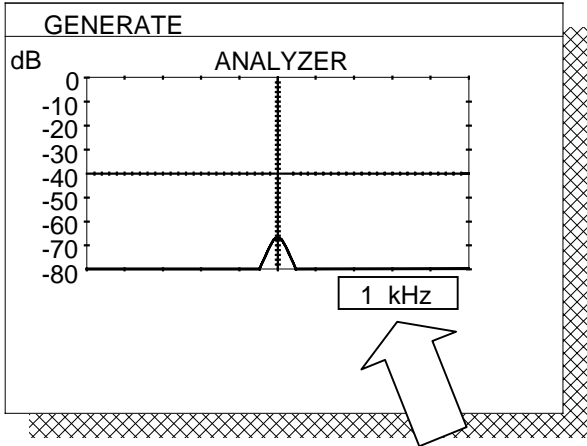

# SECTION 4

## OPERATION

---

Press F1 to access full screen Spectrum Analyzer when cursor is on ANALYZER.

Configure full screen Spectrum Analyzer as follows:

SET REF

Sets current Center Frequency as Reference Frequency.

Select Scan Width as follows:

MENU

Accesses Scan Width selections including zero scan.

COUPLE

Sets the sweep and RBW to factory default state for current scan width.

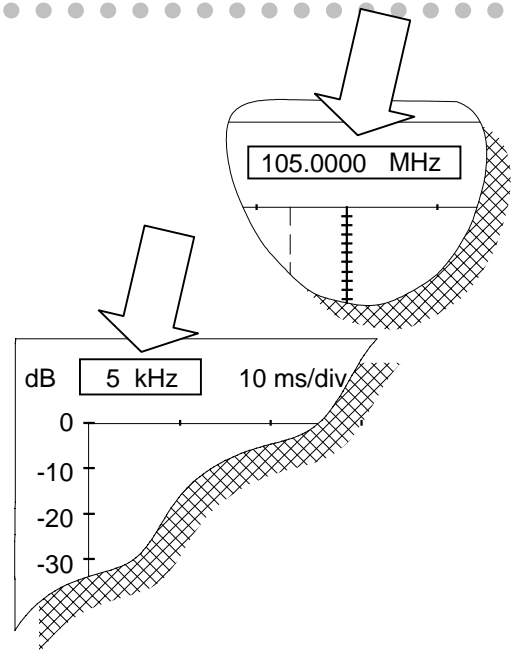

“UNCAL” appears in the display when combinations of RBW, frequency span and sweep rate for which the analyzer is not calibrated are used.

Set Scale as follows:

10 dB

Selects 10 dB Vertical Scale.

2 dB

Selects 2 dB Vertical Scale.

# SECTION 4

## OPERATION

---

Select Operation Mode as follows:

MENU

Accesses Operation Mode menu selections.

LIVE

Selects Live Operation Mode.

RECALL

Selects Recall Operation Mode.

COMPARE

Selects Compare Operation Mode.

LIVE-REF

Selects Live-Ref Operation Mode.

REF-LIVE

Selects Ref-Live Operation Mode.

RETURN

Exits to Generate Scope.

AVG

Selects Average Operation Mode.

PK HOLD

Selects Peak Hold Operation Mode.

MIN HOLD

Selects Minimum Hold Operation Mode.

STORE

Stores the current trace.

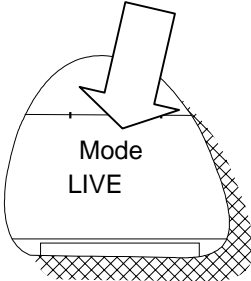

# SECTION 4

## OPERATION

---

- Activate Marker as required.

On/Off

Activates Marker. Entered desired Marker position using DATA ENTRY keys or DATA SCROLL Keys and/or DATA SCROLL Spinner.

- Access Ref Field to adjust Vertical Scale as needed.

If Scan Width is set to zero scan, enter Zero Scan Sweep selection as follows:

MENU

Use to set Zero Scan Sweep.

DEFLT

Sets the current field to factory default.

COUPLE

Use to set sweep and RBW to factory default state for the current scan width.

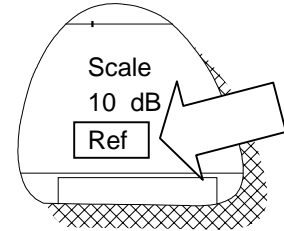

# SECTION 4 OPERATION

## 4-1-7 STORE AND RECALL OPERATION

Press STORE Memory Key to store up to 50 RF Generate Operation Screen configurations.

Storage Locations 0 through 49 are used to store an RF Generate Operation configuration, RF Receive Operation configuration or Duplex Operation configuration (Receive and Generate pair).

STORE Operation for RF Generate Operation is as follows:



- Press STORE MEMORY Key.
- Enter or scroll through Setup # value. Range is 0 to 49. Press ENTER Key.
- If Name is desired, press ENTER Key, with Cursor on Name. Enter Name using DATA ENTRY Keys. Name can be alphabetic and/or numeric characters. Press ENTER Key.
- Type displays the type of data currently saved in the specified setup number. Types saved are: DUPLEX, GENERATOR, RECEIVER, GENERATOR & RECEIVER and EMPTY.
- Press F1 to accept selections and save Setup. Press F6 to escape without saving Setup.

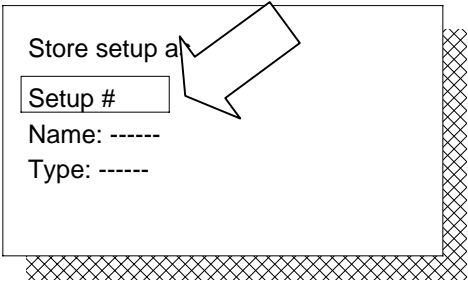

# SECTION 4

## OPERATION

---

Press RCL Memory Key to recall up to 50 previously stored setups.

RF Receive, RF Generate or Duplex Operation Screen configurations can all be accessed from the RF Generate Operation Screen.

Recalling a configuration other than an RF Generate Operation Screen configuration, automatically switches the COM-120C to the selected mode of operation.

RECALL Operation for RF Generate Operation is as follows:



- Press RECALL MEMORY Key.
- Enter Setup # value. Range is 0 to 49. Press ENTER Key.
- Type displays the type of data currently saved in the specified setup number. Types recalled are: DUPLEX, GENERATOR, RECEIVER, GENERATOR & RECEIVER and EMPTY.
- Press F1 to accept selections and recall Setup. Press F6 to escape without recalling Setup.

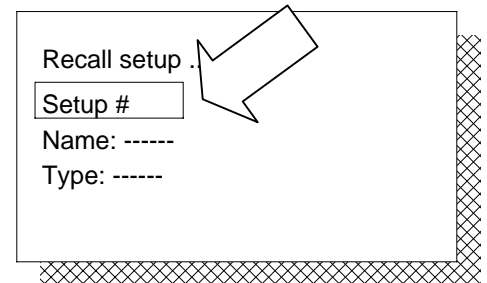

# SECTION 4 OPERATION

## 4-2 RF RECEIVE OPERATION

This section provides information on configuring the COM-120C to perform tests on the transmitter.

Press the REC MODE Key to access the RF Receive Operation Screen. In this mode, the COM-120C to acts as a receiver to test a transmitter.

The intention is to provide sufficient information to allow the operator to effectively use the COM-120C to perform specific operator defined tests.

### 4-2-1 GENERAL RF RECEIVE OPERATION

□ Enter desired frequency in RF Field.

Frequency range is 0.0000 to 1000.0000 MHz.

Activate additional functions as desired.

To operate with  $\Delta$  Function active:

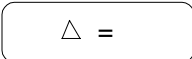

Activates window to increment RF Field. Range is 0 to 500 MHz.

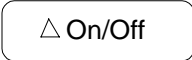

Activate/deactivate  $\Delta$  Function. Prompt displays by RF Field.

To Operate with Scan Function:

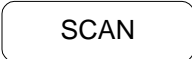

Opens Scan Configuration Window.

Enter start Frequency List number, end Frequency List number and Frequency List number change increment. Enter Pause and Delay Times.

Range is 0 to 9.5 sec with 0.5 sec step. If Pause Time is set to zero, Delay Time is blanked.

Press F1 to start continuous sweep, F2 to stop the sweep, F3 for single sweep and F5 to resume a halted sweep. Press F6 to exit.

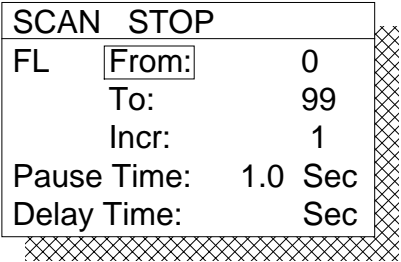
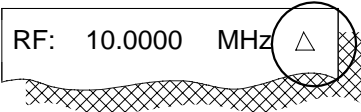
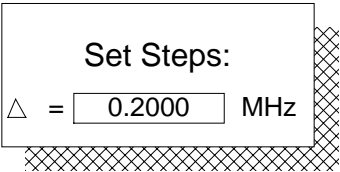



# SECTION 4

## OPERATION

---

To Operate with Sweep Operation:

**SWEEP**

Opens Sweep Configuration Window.

Enter start frequency, stop frequency, increment for sweep operation and pause/delay times at each frequency. Enter Pause and Delay Times.

Range is 0 to 9.5 sec with 0.5 sec step. If Pause Time is set to zero, Delay Time is blanked.

Press F1 to start continuous sweep, F2 to stop the sweep, F3 for single sweep and F5 to resume a halted sweep. Press F6 to exit.

**SWEEP STOP**

Start: 100.0000 MHz  
Stop: 200.0000 MHz  
Incr: 1.0000 MHz  
Pause Time: 1.0 Sec  
Delay Time: Sec

**LOCK**

**UNLOCK**

To Operate with RF Generate, RF Receive and Spectrum Analyzer RF Frequencies locked, press F5 until L is displayed beside RF Field. Press F5 again to unlock.

RF: 10.0000 MHz **L**

- ❑ If Frequency List Operation is desired instead of entering frequency in RF Field, select Frequency List Setting as follows:

**On/Off**

Activates Frequency List Setting.

**T-Fwd**

Selects Trunking Forward Channel List.

**T-Rvs**

Selects Trunking Reverse Channel List.

**C-Fwd**

Selects Cellular Forward Channel List.

**C-Rvs**

Select Cellular Reverse Channel List.

**FL**

Select User Defined Frequency List.

RF: 10.0000 MHz  
**FL:** OFF  
Input: ANT Atten: 30 dB  
Demod: FM IF BW: 15 kHz

# SECTION 4 OPERATION

If Cellular Channel List or User Defined Frequency List is selected, enter channel/frequency number. Range of cellular channels is 1 to 1023. Range of Frequency List is 0 to 99.

If Trunking Channel List is selected, select channel number. Select Frequency Band. Select desired Frequency Band using DATA SCROLL Keys or DATA SCROLL Spinner. Press ENTER Key.

Set Input Level Units as follows:

T/R

Selects T/R as input connector.

ANT

Selects Antenna as input connector.

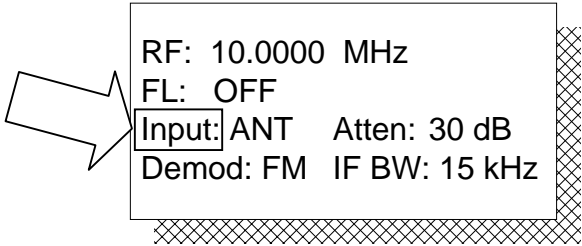

Set Attenuation as follows:

30 dB

Selects 30 dB attenuation for input signal.

0 dB

Selects 0 dB attenuation for input signal.

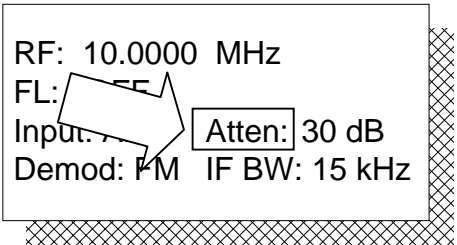

Set Demodulation Type as follows:

AM

Selects AM Demodulation.

FM

Selects FM Demodulation.

PM

Selects PM Demodulation.

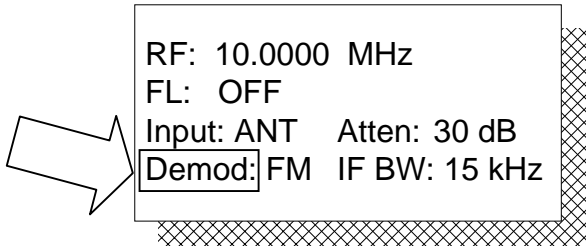

# SECTION 4

## OPERATION

---

300 kHz

Selects 300 kHz IF Bandwidth Filter.

15 kHz

Selects 15 kHz IF Bandwidth Filter.

30 kHz

Selects 30 kHz IF Bandwidth Filter.

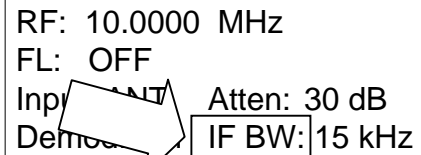

RF: 10.0000 MHz  
FL: OFF  
Input: ANT  
Demod: FM  
Atten: 30 dB  
IF BW: 15 kHz



For following guidelines,  $\Delta F$  is Frequency Deviation in Hz,  $\Phi$  is Phase Deviation in Radians,  $F_m$  is the Tone Modulation Frequency in Hz and IF is Minimum IF Filter Bandwidth. General Guidelines for IF Filter Selection are as follows:

For FM Modulated Signals:

$$IF = 4(\Delta F + F_m)$$

For PM Modulated Signals:

$$IF = 4F_m(\Phi + 1)$$

For AM Modulated Signals:

$$IF = 15 \text{ kHz, for } F_m \leq 1 \text{ kHz}$$

- Edit AF Generator sources as required:

GEN1

Selects GEN1 as source.

GEN2

Selects GEN2 as source.

DATA

Selects DATA as source.

DTMF

Selects DTMF as source.

RETURN

Exits source window.

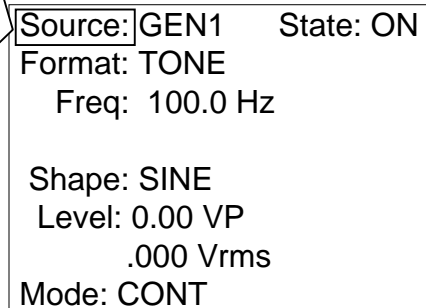

Source: GEN1 State: ON  
Format: TONE  
Freq: 100.0 Hz  
Shape: SINE  
Level: 0.00 VP  
.000 Vrms  
Mode: CONT

# SECTION 4 OPERATION

**MENU**

Opens menu with available formats.

**RETURN**

Exits source window.

Set Frequency, Shape, Level and Mode as desired.

If Audio/Data Filters are required for operation of Meters or Speaker, configure and activate required filters.

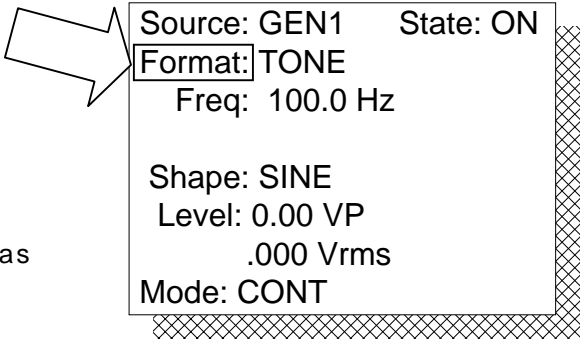

High-Pass Filter/Low-Pass Filter combination and Bandpass Filter never operate simultaneously on same Filter Line.

**CONFIG**

Accesses RF Generator Filters Menu when cursor is on the Filter Line.

Select MOD METERS Bandpass Filter Field setting as follows:

**OFF**

Sets Filter to OFF.

**C-MSG**

Selects C-Message Weighted Filter.

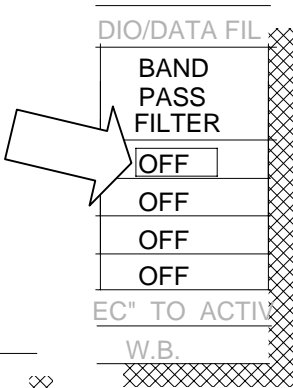

Select MOD METERS High-Pass Filter Field setting as follows:

**OFF**

Sets Filter to OFF.

**300Hz**

Activates 300 Hz High-Pass Filter.

**4kHz**

Activates 4 kHz Low-Pass Filter.

**EXEC**

Executes all edits made to the screen.

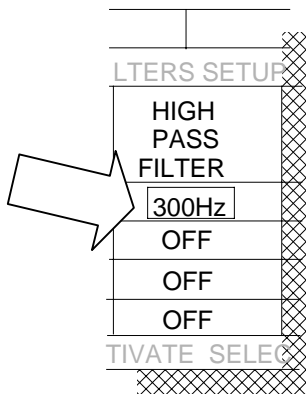

# SECTION 4

## OPERATION

---

Select MOD METERS Low-Pass Filter Field setting as follows:

OFF

Sets Filter to OFF.

300Hz

Activates 300 Hz High-Pass Filter.

4kHz

Activates 4 kHz Low-Pass Filter.

20kHz

Activates 20 kHz Low-Pass Filter.

EXEC

Executes all edits made to the screen.

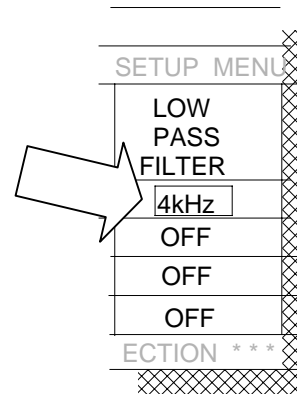

Select Speaker/Headphones Filter Field setting as follows:

OFF

Sets Filter to OFF.

C-MSG

Selects C-Message Weighted Filter.

W.B.

Selects no filtering.

AUD-GEN

Routes Audio Signal Internal Modulation sources to Speaker.

RETURN

Returns to RF Receive Operation Screen.

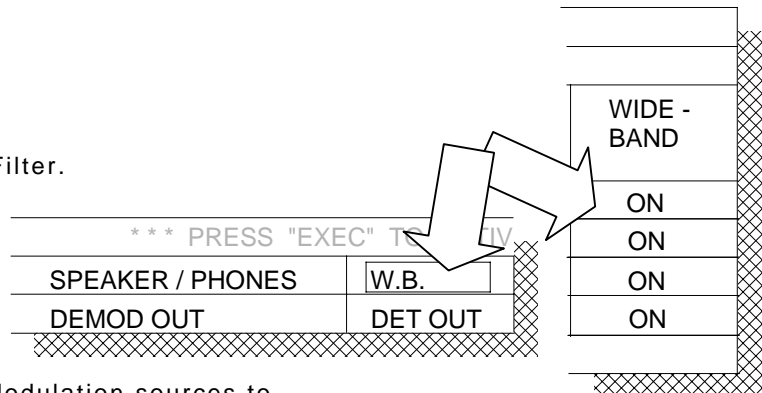

# SECTION 4

## OPERATION

Select DEMOD OUT Field setting as follows:

AF CNT

Accesses AF Counter Signal.

DET OUT

Accesses Detector Signal.

C-MSG

Selects Detector Signal through C-Message Weighted Filter.

DAT DEC

Accesses Data Decoder Signal.

AF DECD

Accesses AF Decoder/SINAD Signal.

MOD MTR

Accesses Modulation Meters Signal.

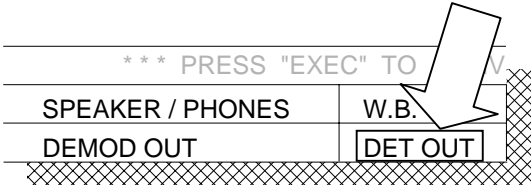

- ❑ Select MOD METERS, DTMT/SINAD, AF CNTR/DECODE, DATA DECODER, SPEAKER/PHONES or DEMOD OUT Filter settings as desired and execute.

# SECTION 4

## OPERATION

---

### 4-2-2 SINAD METER OPERATION

- The SINAD Meter for the RF Receiver measures SINAD for a 1 kHz tone demodulated from an RF Signal. Filtering, for the signal passed to the SINAD Meter, is provided by the Audio/Data Filters.
- For SINAD Meter Operation, see page 4-13.

### 4-2-3 DISTORTION METER OPERATION

- The Distortion Meter for the RF Receiver measures Distortion for a 1 kHz tone demodulated from an RF Signal. Filtering, for the signal passed to the Distortion Meter, is provided by the Audio/Data Filters.
- For Distortion Meter Operation, see page 4-16.

# SECTION 4 OPERATION

## 4-2-4 FM DEVIATION METER OPERATION

The FM Deviation Meter for the RF Receiver measures FM Deviation for an RF Signal. Filtering, for the signal passed to the FM Deviation Meter, is provided by the Audio/Data Filters.

Configure and operate the FM Deviation Meter as follows:

**ZOOM**

Displays full screen FM Deviation Meter.

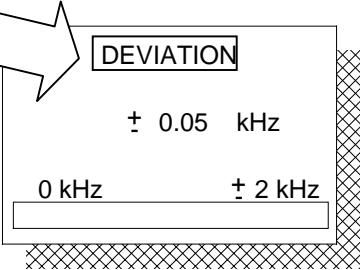

Enter RF as required.



Editing RF field affects level on RF Receive Operation Screen.

**AC**

Selects AC Coupling.

**DC**

Selects DC Coupling.

**FM-Z**

Automatically calibrates FM-Zero with no signal applied.

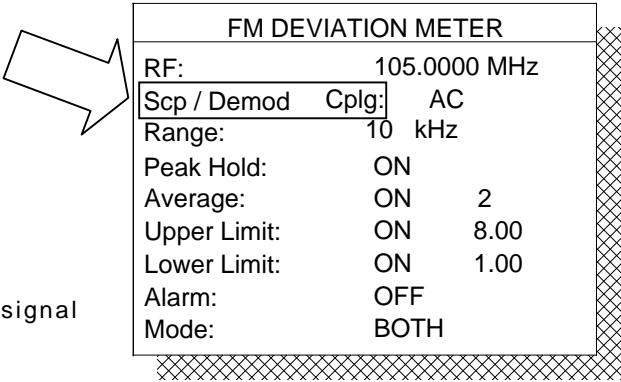

Select Range as follows:

**MENU**

Accesses menu of range selections.

**AUTO**

Selects Autorange for Range.

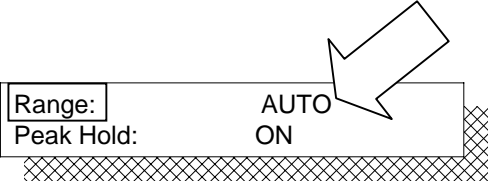

If Peak Hold Function is desired, take meter out of Autorange and configure as follows:

**OFF/ON**

Toggles Peak Hold Function ON or OFF.

**RST PK**

Resets Peak Hold Function.

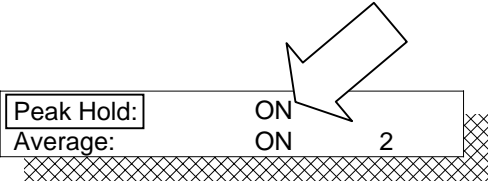



# SECTION 4

## OPERATION

---

If Average Function is desired, configure as follows:

OFF/ON

Toggles Average Function ON or OFF. Cursor to Sample Number to enter desired value. Range is 2 to 10.

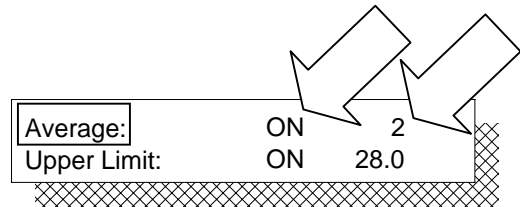

If Upper Limit Function is desired, configure as follows:

OFF/ON

Toggles Upper Limit Function ON or OFF. Enter Limit Value. Range is 0 to 55 dB.

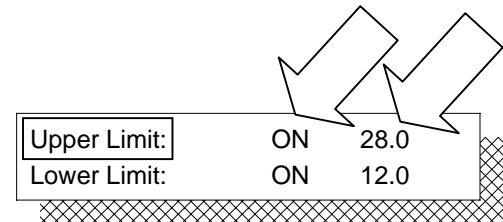

If Lower Limit Function is desired, configure as follows:

OFF/ON

Toggles Lower Limit Function ON or OFF. Enter Limit Value. Range is 0 to 55 dB.

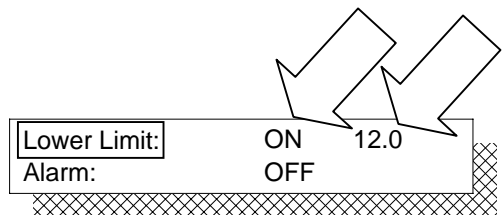

If Alarm Function is desired, configure as follows:

OFF/ON

Toggles Alarm Function ON or OFF. When activated, alarm alerts over range condition.

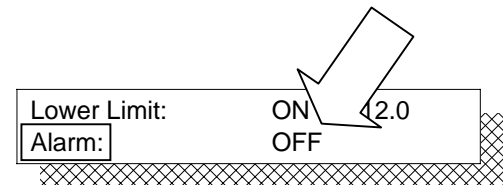

RETURN

Returns to RF Generate Operation Screen.

If Mode Function is desired, configure as follows:

NORM

Displays normal status bar.

BOTH

Displays negative to positive status bar.

RETURN

Returns to RF Receive Operation Screen.

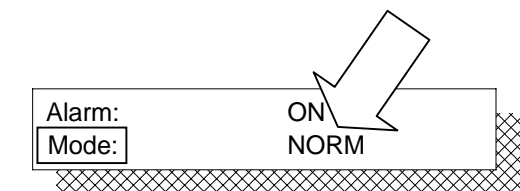

# SECTION 4 OPERATION

## 4-2-5 AM MODULATION METER OPERATION

The AM Modulation Meter for the RF Receiver measures AM Modulation for an RF Signal. Filtering, for the signal passed to the AM Modulation Meter, is provided by the Audio/Data Filters.



Configure and operate the AM Modulation Meter as follows:

**ZOOM**

Displays full screen AM Modulation Meter.

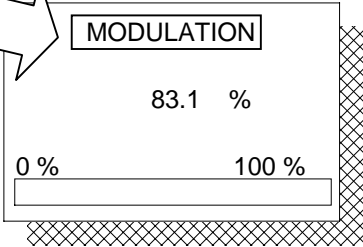

Enter RF as required.



Editing RF field affects level on RF Receive Operation Screen.

Select Range as follows:

**40%**

Selects 40% range.

**100%**

Selects 100% range.

**AUTO**

Selects Autorange for Range.

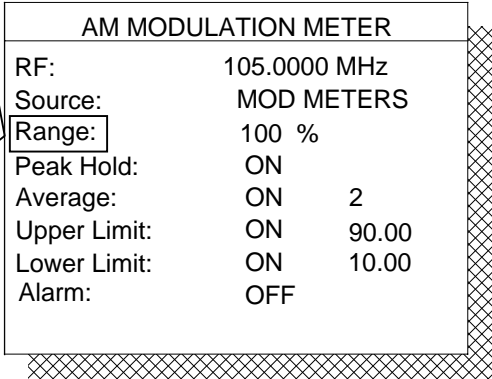

If Peak Hold Function is desired, take meter out of Autorange and configure as follows:

**OFF/ON**

Toggles Peak Hold Function ON or OFF.

**RST PK**

Resets Peak Hold Function.

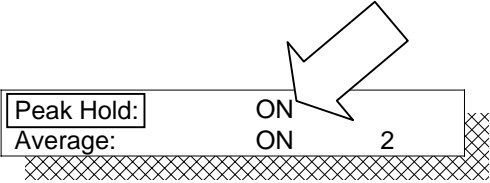

If Average Function is desired, configure as follows:

**OFF/ON**

Toggles Average Function ON or OFF. Cursor to Sample Number to enter desired value. Range is 2 to 10.

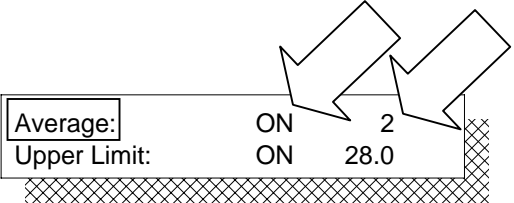

# SECTION 4

## OPERATION

---

If Upper Limit Function is desired, configure as follows:

OFF/ON

Toggles Upper Limit Function ON or OFF. Enter Limit Value. Range is 0 to 99.9%.

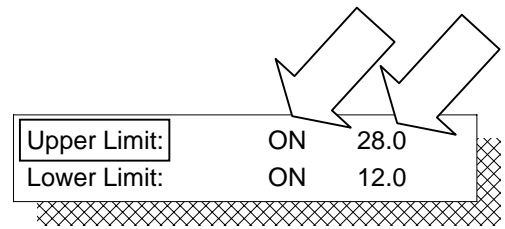

If Lower Limit Function is desired, configure as follows:

OFF/ON

Toggles Lower Limit Function ON or OFF. Enter Limit Value. Range is 0 to 99.9%.

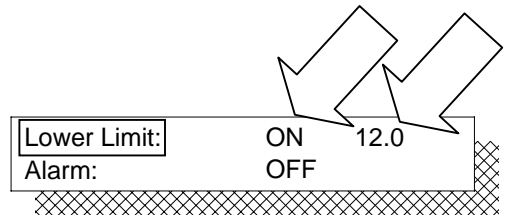

If Alarm Function is desired, configure as follows:

OFF/ON

Toggles Alarm Function ON or OFF. When activated, alarm alerts over range condition.

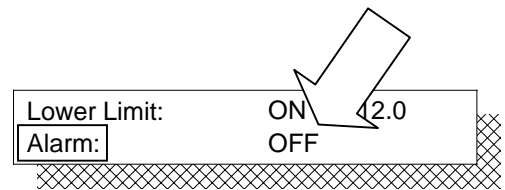

RETURN

Returns to RF Receive Operation Screen.

If Mode Function is desired, configure as follows:

NORM

Displays normal status bar.

BOTH

Displays negative to positive status bar.

RETURN

Returns to RF Receive Operation Screen.

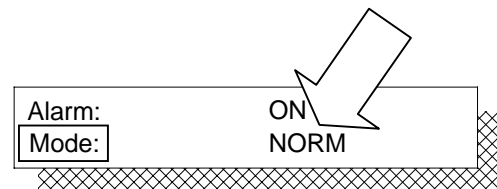

# SECTION 4 OPERATION

## 4-2-6 PHASE MODULATION METER OPERATION

The Phase Modulation Meter for the RF Receiver measures Phase Deviation for an RF Signal. Filtering, for the signal passed to the Phase Modulation Meter, is provided by the Audio/Data Filters.



Configure and operate the Phase Modulation Meter as follows:

**ZOOM**

Displays full screen Phase Modulation Meter.

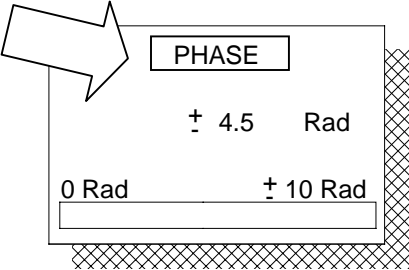

Enter RF as required.



Editing RF field affects level on RF Receive Operation Screen.

Select Range as follows:

**1 RAD**

Selects 1 Rad range.

**2 RAD**

Selects 2 Rad range.

**5 RAD**

Selects 5 Rad range.

**10 RAD**

Selects 10 Rad range.

**AUTO**

Selects Autorange for Range.

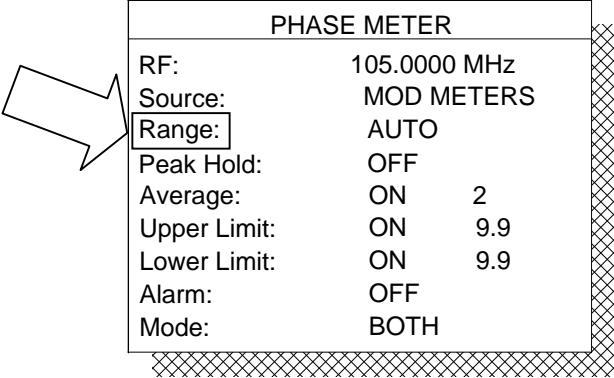

If Peak Hold Function is desired, take meter out of Autorange and configure as follows:

**OFF/ON**

Toggles Peak Hold Function ON or OFF.

**RST PK**

Resets Peak Hold Function.

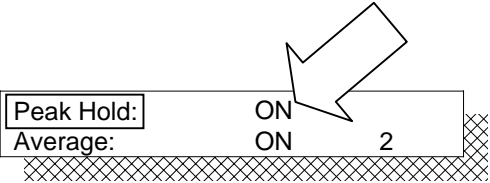

# SECTION 4

## OPERATION

---

If Average Function is desired, configure as follows:

OFF/ON

Toggles Average Function ON or OFF. Cursor to Sample Number to enter desired value. Range is 2 to 10.

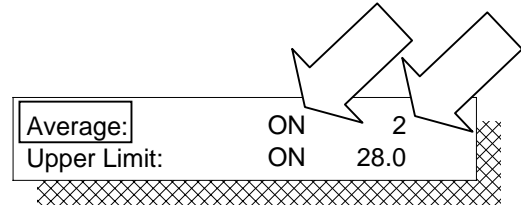

If Upper Limit Function is desired, configure as follows:

OFF/ON

Toggles Upper Limit Function ON or OFF. Enter Limit Value. Range is 0 to 9.99 Radians.

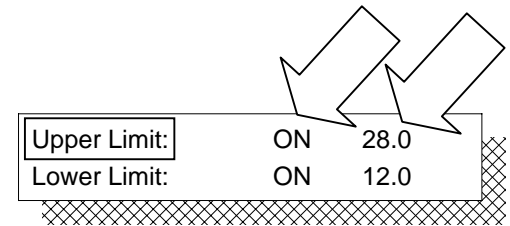

If Lower Limit Function is desired, configure as follows:

OFF/ON

Toggles Lower Limit Function ON or OFF. Enter Limit Value. Range is 0 to 9.99 Radians.

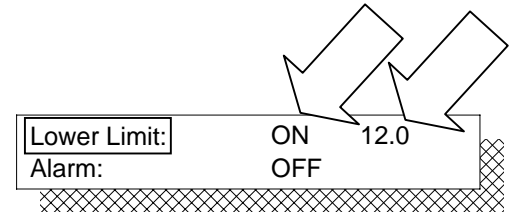

If Alarm Function is desired, configure as follows:

OFF/ON

Toggles Alarm Function ON or OFF. When activated, alarm alerts over range condition.

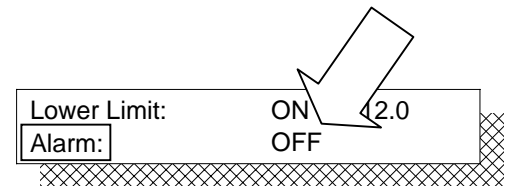

RETURN

Returns to RF Receive Operation Screen.

If Mode Function is desired, configure as follows:

NORM

Displays normal status bar.

BOTH

Displays negative to positive status bar.

RETURN

Returns to RF Receive Operation Screen.

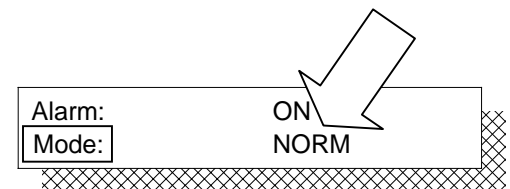

# SECTION 4 OPERATION

## 4-2-7 RF POWER METER OPERATION

The RF Power Meter for the RF Receiver measures power of an RF Signal.



Configure and operate the RF Power Meter as follows:

**ZOOM**

Displays full screen RF Power Meter.

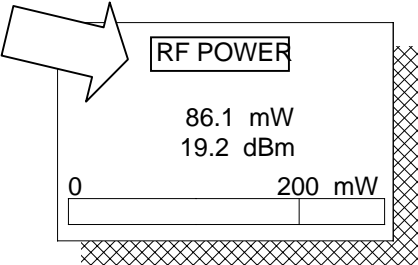

Enter RF as required.



Editing RF field affects level on RF Receive Operation Screen.

Select Cable Loss as follows:

**RE-ZERO**

Re-zeroes Cable Loss.

**RST PK**

Resets Peak Hold Function.

Select Range as follows:

**MENU**

Accesses menu of range selections.

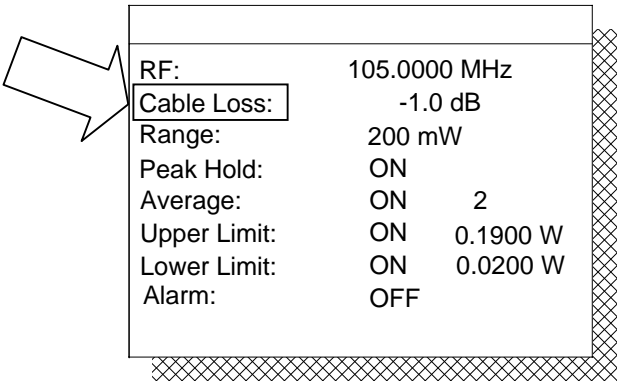

If Peak Hold Function is desired, take meter out of Autorange and configure as follows:

**OFF/ON**

Toggles Peak Hold Function ON or OFF.

**RST PK**

Resets Peak Hold Function.

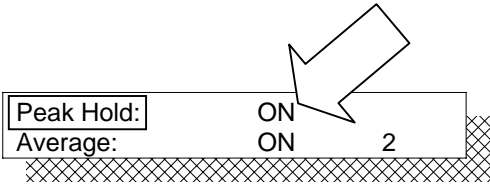

If Average Function is desired, configure as follows:

**OFF/ON**

Toggles Average Function ON or OFF. Cursor to Sample Number to enter desired value. Range is 2 to 10.

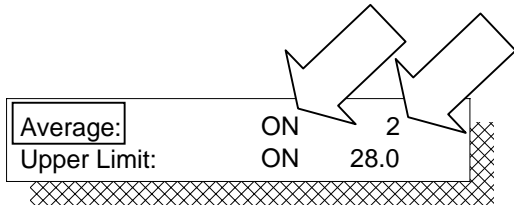

# SECTION 4

## OPERATION

---

If Upper Limit Function is desired, configure as follows:

OFF/ON

Toggles Upper Limit Function ON or OFF. Enter Limit Value. Range is 0 to 200 W.

Upper Limit:	ON	28.0
Lower Limit:	ON	12.0

If Lower Limit Function is desired, configure as follows:

OFF/ON

Toggles Lower Limit Function ON or OFF. Enter Limit Value. Range is 0 to 200 W.

Lower Limit:	ON	12.0
Alarm:	OFF	

If Alarm Function is desired, configure as follows:

OFF/ON

Toggles Alarm Function ON or OFF. When activated, alarm alerts over range condition.

RETURN

Returns to RF Receive Operation Screen.

Lower Limit:	ON	12.0
Alarm:	OFF	

# SECTION 4 OPERATION

## 4-2-8 RECEIVED LEVEL METER OPERATION

The Received Level Meter for the RF Receiver measures referenced power of an RF Signal.



Configure and operate the Received Level Meter as follows:

**ZOOM**

Displays full screen RF Power Meter.

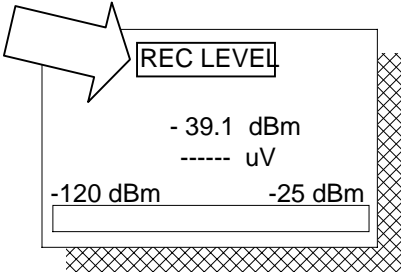

Enter RF as required.



Editing RF field affects level on RF Receive Operation Screen.

Select Cable Loss as follows:

**30 dB**

Selects 30 dB attenuation for Input Signal.

**0 dB**

Selects 0 dB attenuation for Input Signal.

Select Range as follows:

**300 kHz**

Selects 300 kHz IF Bandwidth Filter.

**15 kHz**

Selects 15 kHz IF Bandwidth Filter.

**30 kHz**

Selects 30 kHz IF Bandwidth Filter.

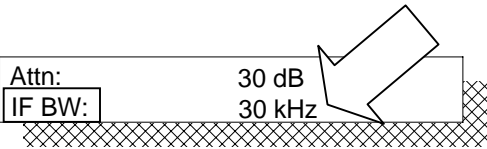
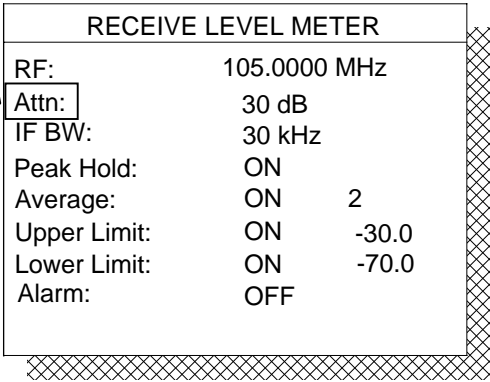

If Peak Hold Function is desired, take meter out of Autorange and configure as follows:

**OFF/ON**

Toggles Peak Hold Function ON or OFF.

**RST PK**

Resets Peak Hold Function.

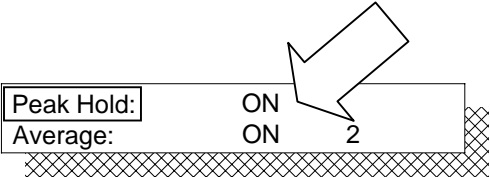



# SECTION 4

## OPERATION

---

SET LVL

Once meter is configured, set reference for meter. For greatest accuracy, perform Set Level Function for each new frequency.

EXEC

Used to set reference level.

ESCAPE

Exits without edit.

If Average Function is desired, configure as follows:

OFF/ON

Toggles Average Function ON or OFF. Cursor to Sample Number to enter desired value. Range is 2 to 10.

If Upper Limit Function is desired, configure as follows:

OFF/ON

Toggles Upper Limit Function ON or OFF. Enter Limit Value. Range is 0 to 200 W.

If Lower Limit Function is desired, configure as follows:

OFF/ON

Toggles Lower Limit Function ON or OFF. Enter Limit Value. Range is 0 to 200 W.

If Alarm Function is desired, configure as follows:

OFF/ON

Toggles Alarm Function ON or OFF. When activated, alarm alerts over range condition.

RETURN

Returns to RF Receive Operation Screen.

Connect a coax cable from T/R connector to ANT connector.

WORKING...  
RF level -30.0 dBm  
ADC value 408

Peak Hold: ON  
Average: ON 2

Upper Limit: ON -30.0  
Lower Limit: ON -70.0

Upper Limit: ON -30.0  
Lower Limit: ON -70.0

Lower Limit: ON 12.0  
Alarm: OFF

# SECTION 4 OPERATION

## 4-2-9 RF FREQUENCY ERROR METER OPERATION

The RF Frequency Error Meter for the RF Receiver measures the frequency of the received RF Signal and reports the error.

Configure and operate the RF Frequency Error Meter as follows:

ZOOM

Displays full screen RF Frequency Error Meter.

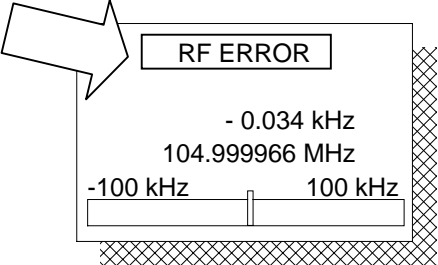

- Enter RF as required.



Editing RF field affects level on RF Receive Operation Screen.

Select IF Bandwidth as follows:

300 kHz

Selects 300 kHz IF Bandwidth Filter.

15 kHz

Selects 15 kHz IF Bandwidth Filter.

30 kHz

Selects 30 kHz IF Bandwidth Filter.

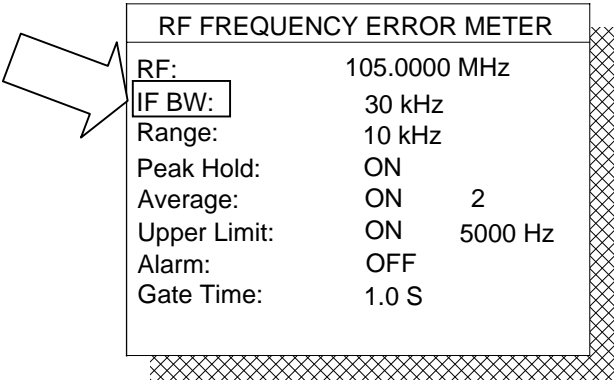

Select Range as follows:

100 Hz

Selects 100 Hz range.

1 kHz

Selects 1 Hz range.

10 kHz

Selects 10 kHz range.

100 kHz

Selects 100 kHz range.

AUTO

Selects Autorange.

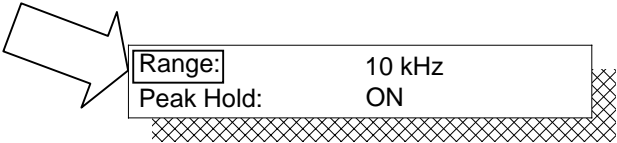

# SECTION 4

## OPERATION

---

If Peak Hold Function is desired, take meter out of Autorange and configure as follows:

OFF/ON

Toggles Peak Hold Function ON or OFF.

RST PK

Resets Peak Hold Function.

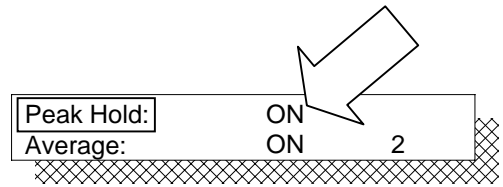

If Average Function is desired, configure as follows:

OFF/ON

Toggles Average Function ON or OFF. Cursor to Sample Number to enter desired value. Range is 2 to 75.

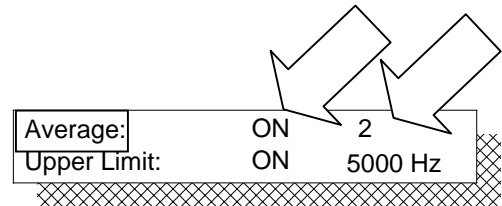

If Upper Limit Function is desired, configure as follows:

OFF/ON

Toggles Upper Limit Function ON or OFF. Enter Limit Value. Range is -110 to -30 dBm.

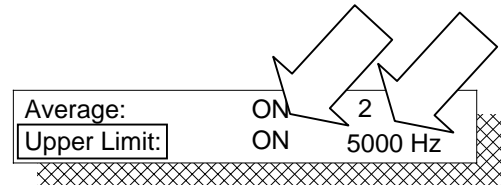

If Alarm Function is desired, configure as follows:

OFF/ON

Toggles Alarm Function ON or OFF. When activated, alarm alerts over range condition.

RETURN

Returns to RF Receive Operation Screen.

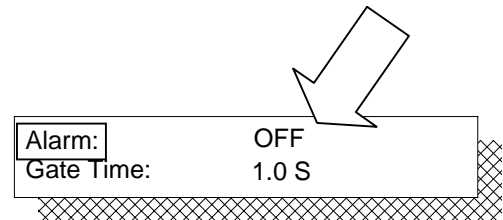

Configure Gate Time as follows:

0.1 S

Selects 0.1 Second as Gate Time.

1.0 S

Selects 1.0 Second as Gate Time.

RETURN

Returns to RF Receive Operation Screen.

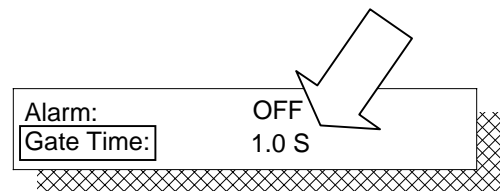

# SECTION 4 OPERATION

## 4-2-10 AUDIO FREQUENCY COUNTER

The Audio Frequency Counter for the RF Receiver counts the audio frequency when the received RF Signal is modulating. Filtering for the signal passed to the Audio Frequency Counter is provided by the Audio/Data Filters.



Configure and operate the Audio Frequency Counter follows:

ZOOM

Displays full screen Audio Frequency Counter.

Select Range as follows:

200 Hz

Selects 200 Hz range.

2000 Hz

Selects 2000 Hz range.

20 kHz

Selects 20 kHz range.

AUTO

Selects Autorange.

Source:	DEMOD
Range:	2000 Hz
Peak Hold:	ON
Average:	ON 2
Upper Limit:	ON 1900 Hz
Lower Limit:	ON 100 Hz
Alarm:	OFF
Gate Time:	1 S

If Peak Hold Function is desired, take meter out of Autorange and configure as follows:

OFF/ON

Toggles Peak Hold Function ON or OFF.

RST PK

Resets Peak Hold Function.

Peak Hold:	ON
Average:	ON 2

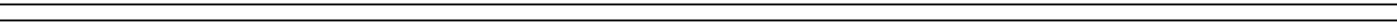

# SECTION 4

## OPERATION

---

If Average Function is desired, configure as follows:

OFF/ON

Toggles Average Function ON or OFF. Cursor to Sample Number to enter desired value. Range is 2 to 10.

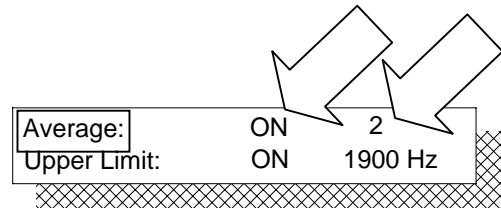

If Upper Limit Function is desired, configure as follows:

OFF/ON

Toggles Upper Limit Function ON or OFF. Enter Limit Value. Range is 0 to 20000 Hz.

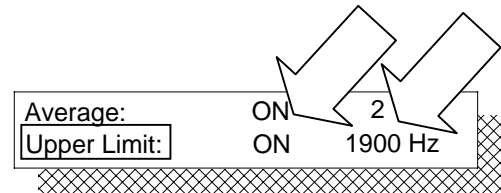

If Lower Limit Function is desired, configure as follows:

OFF/ON

Toggles Lower Limit Function ON or OFF. Enter Limit Value. Range is 0 to 20000 Hz.

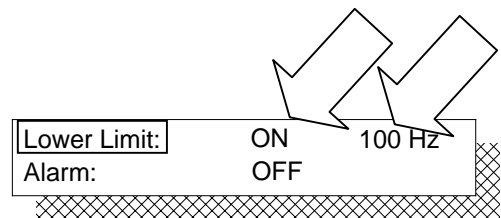

If Alarm Function is desired, configure as follows:

OFF/ON

Toggles Alarm Function ON or OFF. When activated, alarm alerts over range condition.

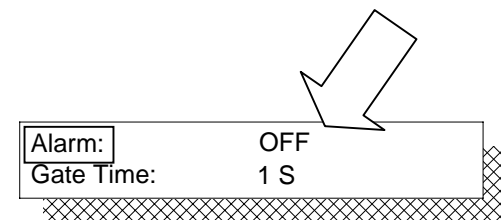

RETURN

Returns to RF Receive Operation Screen.

Configure Gate Time as follows:

1 S

Selects 1 Second as Gate Time.

10 S

Selects 10 Seconds as Gate Time.

RETURN

Returns to RF Receive Operation Screen.

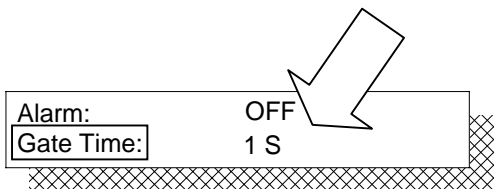

### 4-2-11 OSCILLOSCOPE OPERATION SCREEN

- The RF Receive Oscilloscope is usable as an abbreviated Oscilloscope or as a Full Screen Oscilloscope. The configuration of one is reflected in the other.
- Pressing F1 when the cursor is on the abbreviated Oscilloscope SCOPE/ANALYZER field accesses the Full Screen Oscilloscope. Determine Scope Source before accessing the Full Screen Oscilloscope.
- For Oscilloscope Operation Screen, see page 4-22.

### 4-2-12 DISTORTION METER

- The RF Receive Spectrum Analyzer is usable as an abbreviated Spectrum Analyzer or as a Full Screen Spectrum Analyzer. The configuration of one is reflected in the other.
- Pressing F1 when the cursor is on the abbreviated Spectrum Analyzer SCOPE/ANALYZER field accesses the Full Screen Spectrum Analyzer.
- For Spectrum Analyzer Operation Screen, see page 4-27.

### 4-2-13 STORE AND RECALL OPERATION

- Pressing STORE Memory Key allows the operator to store up to 100 RF Receive Operation Screen configurations. Storage Locations 0 through 49 can be used to store an RF Generate Operation configuration, an RF Receive Operation configuration or a Duplex Operation configuration (Receive and Generate pair).
- For Store and Recall Operation, see page 4-31.

# SECTION 4

## OPERATION

---

### 4-3 DUPLEX OPERATION

Pressing the DPLX MODE Key accesses the Duplex Operation Screen. The Duplex Mode allows the COM-120C to act as a transmitter *and* receiver and test a transceiver that may or may not have a frequency offset.

The Duplex Receive and Duplex Generate Operation Screens are similar in configuration and operation to the RF Receive and RF Generate Screens. Specific tests and configurations discussed in those two sections are applicable within the Duplex System.

The intention is to provide sufficient information to allow the operator to effectively use the COM-120C to perform specific operator defined tests.

.....

#### 4-3-1 GENERAL DUPLEX GENERATE OPERATION

- ❑ Enter desired frequency in Duplex Generate RF Field.

Frequency range is 0.0000 to 1000.0000 MHz.

Activate additional functions as desired.

To operate with  $\Delta$  Function active:

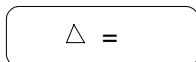

Activates window to increment RF Field. Range is 0 to 500 MHz.

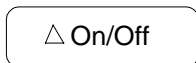

Activate/deactivate  $\Delta$  Function. Prompt displays by RF Field.

To Operate with Set Reference Function:



**R** appears beside RF Field. When active, RF Field is set to 0 MHz and changes made to RF Field display offset from Reference Frequency. To deactivate Set Reference Function, press SET REF until **R** is not visible.

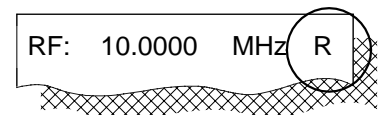
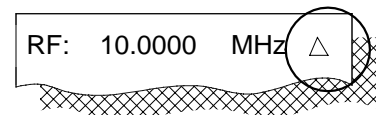
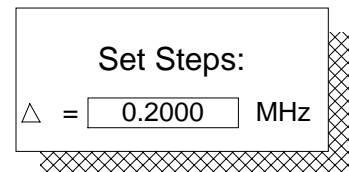
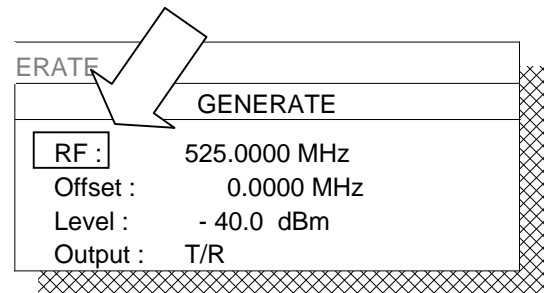

# SECTION 4 OPERATION

PAIR

Pairs Generate and Receive RF operation.

UNPAIR

Unpairs Generate and Receive RF operation.

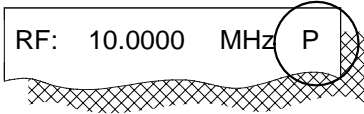

RF: 10.0000 MHz P

- ❑ Set Frequency Offset to desired value.  
Range is from -999.750 to 999.750 MHz.



To activate/ deactivate Pair/ Unpair Function, press F5.

Set Level as follows:

dBm

Selects dBm as Output Level Units.

uV

Selects  $\mu$ V as Output Level Units.

mV

Selects mV as Output Level Units.

V

Selects V as Output Level Units.

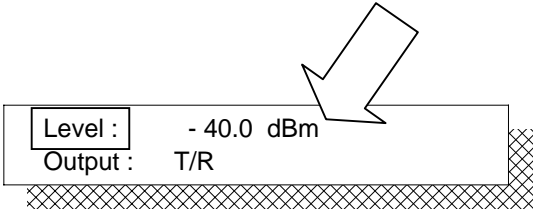

Level : -40.0 dBm  
Output : T/R

Select Output as follows:

T/R

Selects T/R Connector as output connector.

AUX

Selects AUX RF Connector as output connector.

T/R Gate

Selects T/R Connector as gated output connector.

AUX Gate

Selects AUX RF Connector as gated output connector.

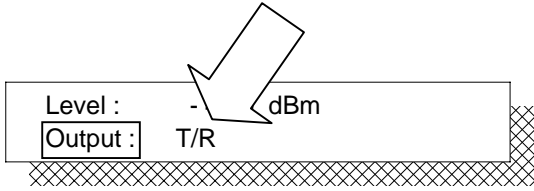

Level : - dBm  
Output : T/R



# SECTION 4

## OPERATION

---

Set Modulation Source Block as follows:

GEN1

If Audio Generator 1 Operation is desired.

GEN2

If Audio Generator 2 Operation is desired.

DATA

If DATA Generator Operation is desired.

DTMF

If DTMF Generator Operation is desired.

MIC

If Microphone Modulation Operation is desired.

EXT

If External Modulation Operation is desired.

Select the desired Modulation Type:

OFF

Modulation OFF.

AM

Range is 0.0% to 100.0% for AM Modulation.

FM

Range is 0.00 to 100 kHz for FM Modulation.

PM

Range is 0.00 to 10 Radians for PM Modulation.

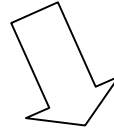

Mod Src:	GEN1	FM
Deviation:	5.0 kHz	
Format:	TONE	
Freq:	1000.0 Hz	
Shape:	SINE	

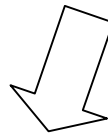

Mod Src:	GEN1	FM
Deviation:	5.0 kHz	
Format:	TONE	
Freq:	1000.0 Hz	
Shape:	SINE	

# SECTION 4 OPERATION

❑ Enter Deviation/Modulation Level.

Select the desired Format.

MENU

Accesses a menu with available format selections.

Select transmission type:

CONT

Selects continuous transmission of signal.

BURST

For single transmission of selected signal.

TIME

Accesses Burst Time Window if TONE is the selected format.

CONFIG

Accesses Configuration Window if USER is the selected format.

Used to configure User Selectable Frequency and Duration for codes 0 through 9 and A through T.

Enter desired frequencies and durations for codes. Range of frequencies are 0 to 9999.9 Hz. Range of durations are 0 to 99.999 seconds.

Use F1 and F2 to scroll up or down through Configuration Window. Use F3 to fill remainder of current column with value of current cursor position.

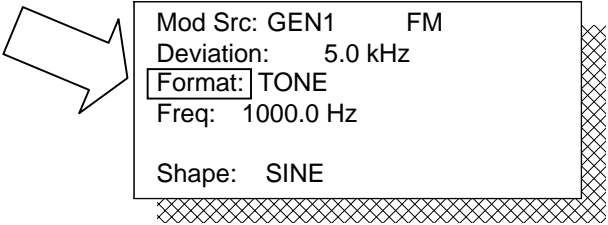

# SECTION 4

## OPERATION

---

- ❑ If TONE is selected as Format, enter Audio Tone Frequency.
- ❑ If TONE is selected as Format, enter Shape.

Range is 5 to 20000 Hz with Shape set to SINE. Range is 5 to 10000 Hz otherwise.

Select Shape of Wave as follows:

SINE

Selects SINE Wave Shape.

RAMP

Selects RAMP Wave Shape.

TRIANGLE

Selects TRIANGLE Wave Shape.

SQUARE

Selects SQUARE Wave Shape.

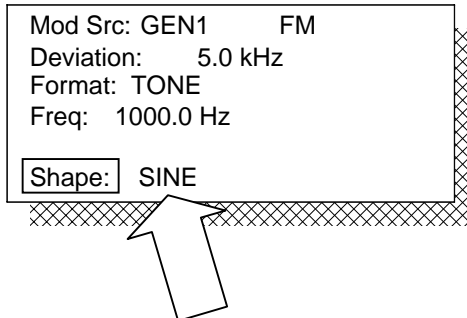

Mod Src: GEN1    FM  
Deviation:    5.0 kHz  
Format: TONE  
Freq: 1000.0 Hz  
Shape: SINE

# SECTION 4 OPERATION

## 4-3-2 GENERAL DUPLEX RECEIVE OPERATION

- Enter desired frequency in RF Field.  
Frequency range is 0.0000 to 1000.0000 MHz.  
Activate additional functions as desired.

To operate with  $\Delta$  Function active:

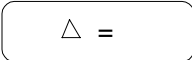

Activates window to increment RF Field.  
Range is 0 to 500 MHz.

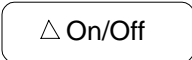

Activate/deactivate  $\Delta$  Function. Prompt displays by RF Field.



Pairs Generate and Receive RF operation.



Unpairs Generate and Receive RF operation.

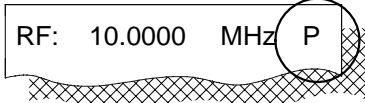
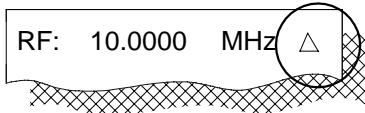
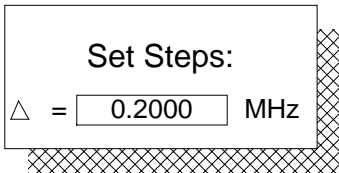
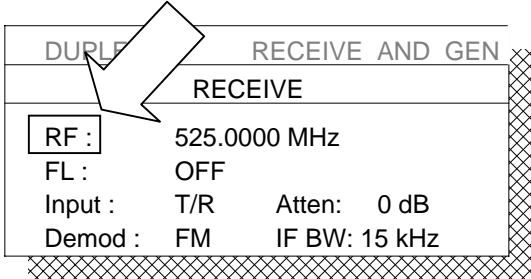

- If Frequency List Operation is desired instead of entering frequency in RF Field, select Frequency List Setting as follows:

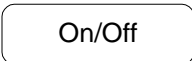

Activates Frequency List Setting.

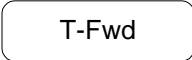

Selects Trunking Forward Channel List.

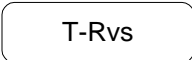

Selects Trunking Reverse Channel List.

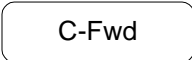

Selects Cellular Forward Channel List.

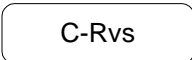

Select Cellular Reverse Channel List.



Select User Defined Frequency List.

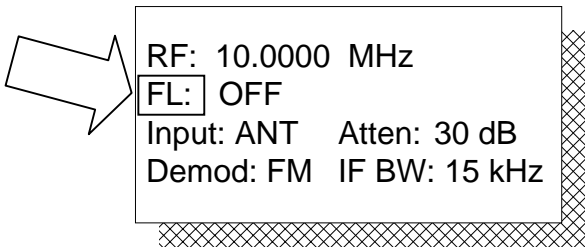

# SECTION 4

## OPERATION

---

If Cellular Channel List or User Defined Frequency List is selected, enter channel/frequency number. Range of cellular channels is 1 to 1023. Range of Frequency List is 0 to 99.

If Trunking Channel List is selected, select channel number. Select Frequency Band. Select desired Frequency Band using DATA SCROLL Keys or DATA SCROLL Spinner. Press ENTER Key.

- ❑ Set Input Level Units as follows:

T/R

Selects T/R as input connector.

ANT

Selects Antenna as input connector.

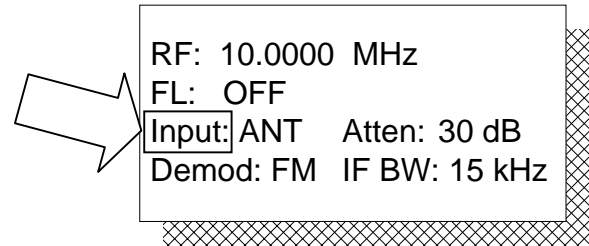

- ❑ Set Attenuation as follows:

30 dB

Selects 30 dB attenuation for input signal.

0 dB

Selects 0 dB attenuation for input signal.

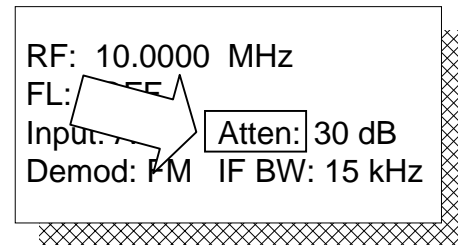

- ❑ Set Demodulation Type as follows:

AM

Selects AM Demodulation.

FM

Selects FM Demodulation.

PM

Selects PM Demodulation.

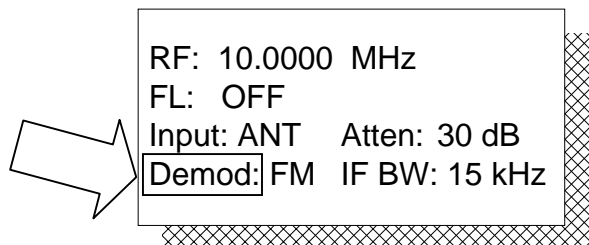

# SECTION 4

## OPERATION

300 kHz

Selects 300 kHz IF Bandwidth Filter.

15 kHz

Selects 15 kHz IF Bandwidth Filter.

30 kHz

Selects 30 kHz IF Bandwidth Filter.

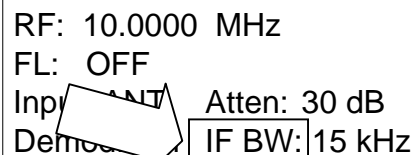

RF: 10.0000 MHz  
FL: OFF  
Input ANT  
Demod  
Atten: 30 dB  
IF BW: 15 kHz



For following guidelines,  $\Delta F$  is Frequency Deviation in Hz,  $\Phi$  is Phase Deviation in Radians,  $F_m$  is the Tone Modulation Frequency in Hz and IF is Minimum IF Filter Bandwidth. General Guidelines for IF Filter Selection are as follows:

For FM Modulated Signals:

$$IF = 4(\Delta F + F_m)$$

For PM Modulated Signals:

$$IF = 4F_m(\Phi + 1)$$

For AM Modulated Signals:

$$IF = 15 \text{ kHz, for } F_m \leq 1 \text{ kHz}$$

- Select Tone/Data Type for TONE/DATA CODE Field as required. Press F2 to activate decoding.
- Select desired DISTORTION/SINAD Reading.  
Press F2 to select SINAD Reading.  
Press F3 to select DISTORTION Reading.

# SECTION 4

## OPERATION

---

### **4-4 INDEPENDENT OSCILLOSCOPE OPERATION SCREEN**

Press the SCOPE INSTRUMENTS Key to access an independent Oscilloscope Operation Screen.

This Oscilloscope Test Instrument is independent of all other Operation Modes.

For Oscilloscope operation, see page 4-20.

### **4-5 INDEPENDENT SPECTRUM ANALYZER OPERATION SCREEN**

Press the ANALYZ INSTRUMENTS Key to access the Spectrum Analyzer Operation Screen.

This Spectrum Analyzer Test Instrument is independent of all other Operation Modes.

For Spectrum Analyzer operation, see page 4-25.

# SECTION 4 OPERATION

## 4-6 INDEPENDENT AUDIO/DATA/SIGNALING GENERATORS

Press the AUDIO GEN INSTRUMENTS Key to access the Audio/Data/Signaling Generators Operation Screen. The Independent Audio/Data/ Signaling Generators provide baseband signal generators that are independent of other Operation Modes.

The Audio/Data/Signaling Generators Operation Screen is composed of four sections. Each section of the screen represents a different generator. The generators are addressed separately in this documentation. Restrictions that apply to the generators are primarily related to the output level.

The sum of the generators output level should not exceed 2.5 volts in X1 mode and 25 mV in /10 (divide by 10) mode. If /10 mode is selected, ALL signal generators are affected.

The intention is to provide sufficient information to allow the operator to effectively use the COM-120C to perform specific operator defined tests.

.....

### 4-6-1 AUDIO GENERATOR-1 OPERATION

Configure and operate Audio Generator-1 as follows:



Toggles Audio Generator-1 ON and OFF.

- Cursor to Format and select from the menu.

- If TONE is selected as Format:

Enter Audio Tone Frequency. Range is 5.0 to 20000 Hz.

Select Shape of Wave as follows:

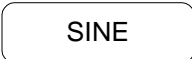

Selects Sine wave.



Selects Ramp wave.



Selects Triangle wave.

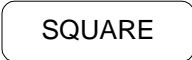

Selects Square wave.

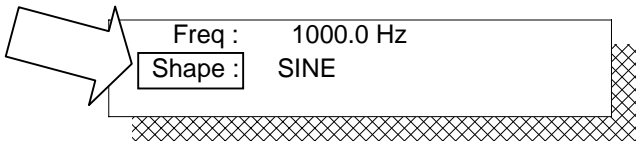
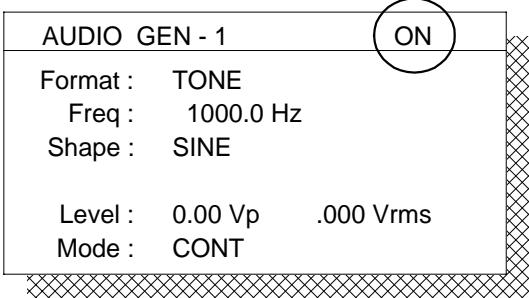



# SECTION 4

## OPERATION

---

- Enter Level as desired.
- Enter Mode as desired.



USER Format is configurable.

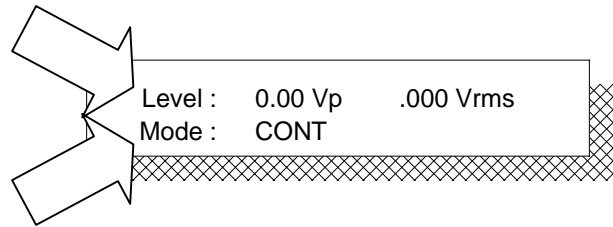

Configure USER Format as follows:

**CONFIG**

Accesses Configuration Window.

- Configure User Selectable Frequency and Duration for codes 0 through 9 and A through T.

Enter desired frequencies and duration for codes.

Range of frequency is 0 to 9999.9 Hz.

Range of duration is 20 to 9999 ms.

USER SIGNALING PROGRAM		
CHAR	FREQ (Hz)	DUR (ms)
0	0.0	20
1	0.0	20
2	0.0	20
3	0.0	20
4	0.0	20
5	0.0	20
6	0.0	20
7	0.0	20
8	0.0	20
9	0.0	20

**PG UP**

Scrolls UP through configuration window.

**PG DN**

Scrolls DOWN through configuration window.

**FILL**

Fills remainder of current column with value of current cursor position.

**RETURN**

Exits configuration window.

- Enter code. Press F1 to clear current code entry.
- Enter Level.

Selections range from 0 to 2.5 Vp in X1 (times 1) Mode and 0 to 25.0 mVp in /10 (divide by 10) Mode.

# SECTION 4 OPERATION

Set Level attenuation as follows:

X1

Selects X1 (times 1) level attenuation.

/10

Selects /10 (divide by 10) level attenuation.

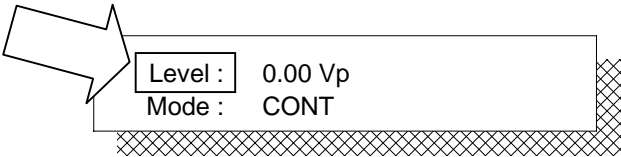

Level selections range from 0 to 2.5 Vp in X1 (times 1) mode and 0 to 25.0 mVp in /10 (divide by 10) mode.

Select Mode as follows:

CONT

Selects continuous transmission of a signal.

BURST

Executes a single transmission of selected signal.

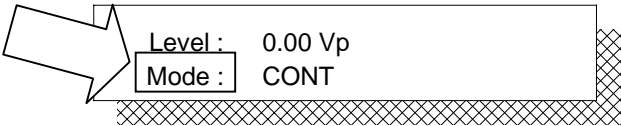

If TONE is selected as Format, enter duration time for TONE Burst in T= field. Time duration ranges from 0 to 30 seconds.

# SECTION 4

## OPERATION

---

### 4-6-2 AUDIO GENERATOR-2 OPERATION

Configure and operate Audio Generator-2 as follows:

GEN2

Toggles Audio Generator-2 ON and OFF.

- Enter Audio Tone Frequency. Range is 5.0 to 20000 Hz.

Select Shape of Wave as follows:

SINE

Selects Sine wave.

RAMP

Selects Ramp wave.

TRIANGLE

Selects Triangle wave.

SQUARE

Selects Square wave.

Set Level attenuation as follows:

X1

Selects X1 (times 1) level attenuation.

/10

Selects /10 (divide by 10) level attenuation.

AUDIO GEN - 2 **ON**

Format : TONE  
Freq : 1000.0 Hz  
Shape : SINE  
Level : 0.00 Vp .000 Vrms

Freq : 1000.0 Hz  
Shape : SINE

Level : 0.00 Vp .000 Vrms



Level selections range from 0 to 2.5 Vp in X1 (times 1) mode and 0 to 25.0 mVp in /10 (divide by 10) mode.

# SECTION 4 OPERATION

## 4-6-3 DATA GENERATOR OPERATION

Configure and operate Data Generator as follows:

DATA

Toggles Data Generator ON and OFF.

DATA GEN	ON
Format :	DCS
Code :	114
Level :	1.00 Vp

Select Format as follows:

DCS

Selects DCS format.

DCS/

Selects DCS Inverted format.

POCSAG

Selects POCSAG format.

POCSAG/

Selects POCSAG Inverted format.

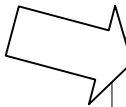

Format :	DCS
Code :	114

- Enter desired code.  
Range is 000 (Octal) to 777 (Octal).

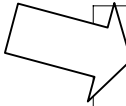

Format :	DCS
Code :	114

Set Level attenuation as follows:

X1

Selects X1 (times 1) level attenuation.

/10

Selects /10 (divide by 10) level attenuation.

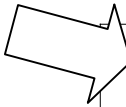

Level :	1.00 Vp
---------	---------



Level selections range from 0 to 2.5 Vp in X1 (times 1) mode and 0 to 25.0 mVp in /10 (divide by 10) mode.

# SECTION 4

## OPERATION

---

### 4-6-4 DTMF GENERATOR OPERATION

Configure and operate Data Generator as follows:

DTMF

Toggles DTMF Generator ON and OFF.

- Press F1 to clear code field of current data.
- Enter desired Mark Time for DTMF tones.  
Range is 25 to 99 msec.
- Enter desired Space Time for DTMF tones.  
Range is 25 to 99 msec.
- Enter desired Pause Time for DTMF tones.  
Range is 25 to 99 msec.

DTMF GEN	
Code :	0123456789ABCD#*
Mark :	70 msec
Space :	70 msec
Pause :	300 msec
Level :	0.00
Mode :	CONT

ON

Set Level attenuation as follows:

X1

Selects X1 (times 1) level attenuation.

/10

Selects /10 (divide by 10) level attenuation.

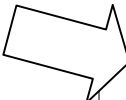

Level :	0.00
Mode :	CONT



Level selections range from 0 to 2.5 Vp in X1 (times 1) mode and 0 to 25.0 mVp in /10 (divide by 10) mode.

Select Mode as follows:

CONT

Activates DTMF Code in a repeating loop.

BURST

Activates DTMF Code for one tone sequence.

KEY

Sets DATA ENTRY Keys active as DTMF keypad.

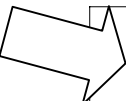

Level :	0.00 Vp
Mode :	CONT

# SECTION 4 OPERATION

## 4-7 METERS OPERATION

The Independent Meters are independent of all other Operation Modes.  
Pressing the MTRS INSTRUMENTS Key accesses the Independent Meters Menu.  
From the Meters Menu, cursor to the number of the desired meter and press ENTER.

- For Audio Frequency Counter Operation, see page 4-51.
- For SINAD Meter Operation, see page 4-13.
- For Digital Voltmeter Operation, see page 4-69.
- For Distortion Meter Operation, see page 4-16.

The intention is to provide sufficient information to allow the operator to effectively use the COM-120C to perform specific operator defined tests.

### 4-7-1 DIGITAL VOLTMETER OPERATION

Select Source as follows:

MENU

Accesses a menu of available selections.

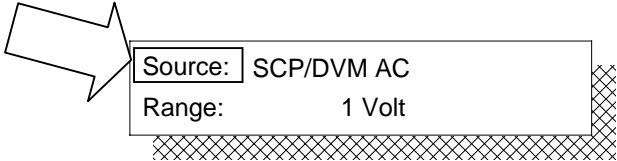

DC ZERO

Performs DC Zero when source is SCP/ DVM DC.

Select Range as follows:

MENU

Accesses a menu of available selections.

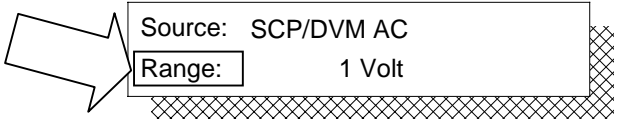

Select Peak Hold Function as follows:

OFF/ON

Toggles Peak Hold Function ON or OFF.

RST PK

Resets Peak Hold Function.

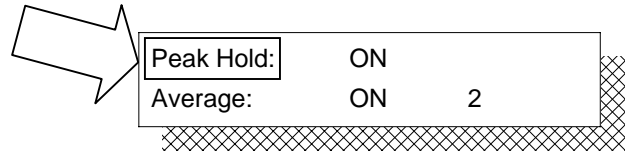

# SECTION 4

## OPERATION

---

Select Average Function as follows:

OFF/ON

Toggles Average Function ON or OFF. Cursor to Sample Number to enter desired value. Range is 2 to 10.

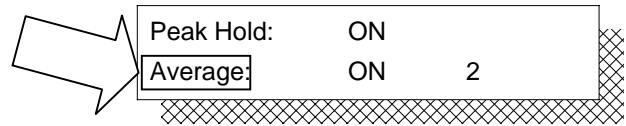

Select Upper Limit Function as follows:

OFF/ON

Toggles Upper Limit Function ON or OFF. Enter Limit Value. Range is 0 to 200 V.

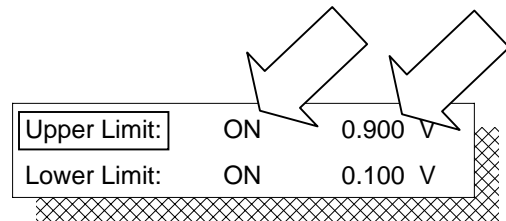

Select Lower Limit Function as follows:

OFF/ON

Toggles Lower Limit Function ON or OFF. Enter Limit Value. Range is 0 to 200 V.

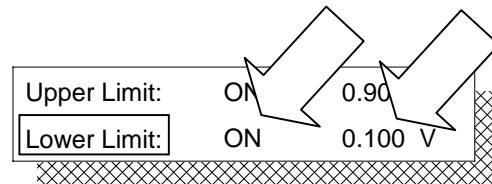

Select Alarm Function as follows:

OFF/ON

Toggles Alarm Function ON or OFF. When activated, alarm alerts over range condition.

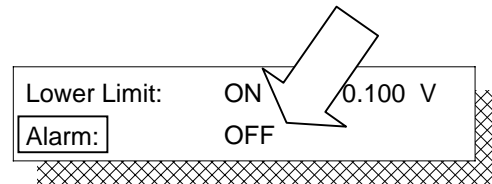

RETURN

Returns to RF Receive Operation Screen.

# SECTION 4 OPERATION

IF Source is SCP/ DVM AC, AUDIO/ DATA IN or EXT MOD IN, configure as follows:

Vrms

Converts reading units to Vrms.

dBm

Converts reading units to dBm. Set Impedance for desired load. Place required load on connector specified by Source.

dB

Converts reading units to dB.

Set Scope Sweep as follows:

MENU

Accesses a menu of available selections.

ROLL

To view the scope trace in a roll mode when selected sweep rate is 100 ms/div or higher.

SLOW

Exits roll and returns to normal mode of operation.

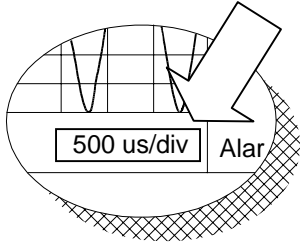
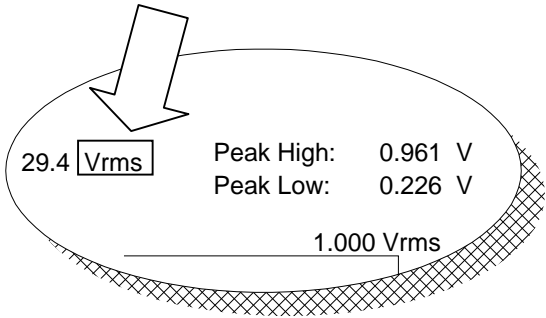



# SECTION 4

## OPERATION

---

THIS PAGE INTENTIONALLY LEFT BLANK.

# SECTION 5

## COMMON PRACTICES

---

### 5-1 RF GENERATE

This section offers suggestions for equipment and screen setups for some common RF Generate practices.

- 5-1-1 Generating FM Modulated RF Signal
- 5-1-2 Generating AM Modulated RF Signal
- 5-1-3 Generating PM Modulated RF Signal
- 5-1-4 Generating DCS Coded RF Signal
- 5-1-5 Generating DTMF Coded RF Signal
- 5-1-6 Generating RF Signal using External Modulation
- 5-1-7 Generating Microphone Modulated RF Signal
- 5-1-8 Encoding 2 Tone Sequential Format

# SECTION 5

## COMMON PRACTICES

---

### 5-1-1 GENERATING FM MODULATED RF SIGNAL

This procedure configures the RF Generate Operation Screen to transmit an FM Modulated RF Signal at the T/R Connector.

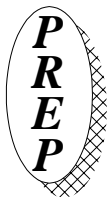

The audio portion of the signal is a 1 kHz sine wave from Audio Generator 1.

The deviation is set at 5 kHz.

The Output Level is -50 dBm.

The speaker is configured to play the internal modulated signal.

- 
- o Set RF Field to **Rcvr Center Frequency**.
  - o Set Output Level to **-50 dBm**.
  - o Set Output to **T/R**.
  - o Select Audio Generator 1 (**GEN1**) for Modulation Source.
  - o Set Modulation Type to **FM**.
  - o Set Deviation Level to **5.00 kHz**.
  - o Set Format to **TONE**.
  - o Set Tone Freq to **1000.0 Hz**.
  - o Set Shape to **SINE**.
  - o Access Filters Setup Menu.
  - o Set Speaker/Headphones Field to **INT-MOD**.
  - o Return to RF Generate Operation Screen.
  - o Set VOLUME Control for desired audio level.

# SECTION 5 COMMON PRACTICES

RF:	100.0000 MHz
FL:	OFF
Level:	-50.0 dBm
Output:	T/R
GEN1	
Mod Src:	GEN1 FM
Deviation:	5.00 kHz
Format:	TONE
Freq:	1000.0 Hz
Shape:	Sine

RF GEN AUDIO / DATA FILTERS		SETUP MENU		
LINE	BAND PASS FILTER	HIGH PASS FILTER	LOW PASS FILTER	WIDE - BAND
DTMF / SINAD	OFF	OFF	OFF	ON
*** PRESS "EXEC" TO ACTIVATE SELECTION ***				
SPEAKER / PHONES	INT - MOD			

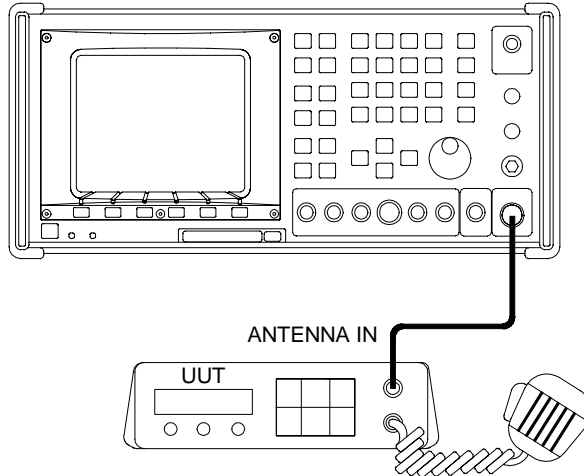

00607219

Generating FM Modulated RF Signal

# SECTION 5

## COMMON PRACTICES

---

### 5-1-2 GENERATING AM MODULATED RF SIGNAL

This procedure configures the RF Generate Operation Screen to transmit an AM Modulated RF Signal at the T/R Connector.

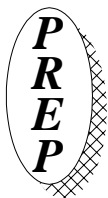

The audio portion of the signal is a 1 kHz sine wave from Audio Generator 1.  
The Modulation is set at 50%.  
The Output Level is -50 dBm.  
The speaker is configured to play the internal modulated signal.

- 
- o Set RF Field to **Rcvr Center Frequency**.
  - o Set Output Level to **-50 dBm**.
  - o Set Output to **T/R**.
  - o Select Audio Generator 1 (**GEN1**) for Modulation Source.
  - o Set Modulation Type to **AM**.
  - o Set Modulation Level to **50.0%**.
  - o Set Format to **TONE**.
  - o Set Tone Freq to **1000.0 Hz**.
  - o Set Shape to **SINE**.
  - o Access Filters Setup Menu.
  - o Set Speaker/Headphones Field to **INT-MOD**.
  - o Return to RF Generate Operation Screen.
  - o Set VOLUME Control for desired audio level.

# SECTION 5 COMMON PRACTICES

RF GEN AUDIO / DATA FILTERS SETUP MENU				
LINE	BAND PASS FILTER	HIGH PASS FILTER	LOW PASS FILTER	WIDE - BAND
DTMF / SINAD	OFF	OFF	OFF	ON
*** PRESS "EXEC" TO ACTIVATE SELECTION ***				
SPEAKER / PHONES	INT - MOD			

RF:	(Rcvr Center Frequency)
FL:	OFF
Level:	-50.0 dBm
Output:	T/R
GEN1	
Mod Src:	GEN1 AM
Mdulation:	50.0%
Format:	TONE
Freq:	1000.0 Hz
Shape:	Sine

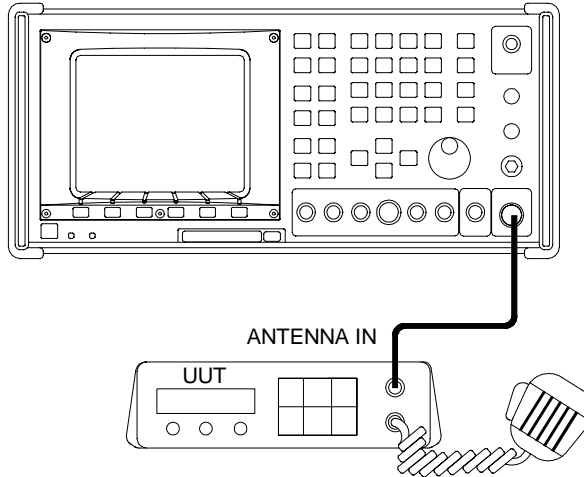

00607220

Generating AM Modulated RF Signal

# SECTION 5

## COMMON PRACTICES

---

### 5-1-3 GENERATING PM MODULATED RF SIGNAL

This procedure configures the RF Generate Operation Screen to transmit a PM Modulated RF Signal at the T/R Connector.

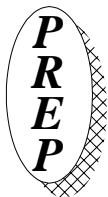

The audio portion of the signal is a 1 kHz sine wave from Audio Generator 1.

The deviation is set at 5 Radians.

The Output Level is -50 dBm.

- 
- o Set RF Field to **Rcvr Center Frequency**.
  - o Set Output Level to **-50 dBm**.
  - o Set Output to T/R.
  - o Select Audio Generator 1 (**GEN1**) for Modulation Source.
  - o Set Modulation Type to **PM**.
  - o Set Deviation Level to **5.00 Rad**.
  - o Set Format to **TONE**.
  - o Set Tone Freq to **1000.0 Hz**.
  - o Set Shape to **SINE**.
  - o Access Filters Setup Menu.
  - o Set Speaker/Headphones Field to **INT-MOD**.
  - o Return to RF Generate Operation Screen.
  - o Set VOLUME Control for desired audio level.

# SECTION 5 COMMON PRACTICES

RF GEN AUDIO / DATA FILTERS		SETUP MENU		
LINE	BAND PASS FILTER	HIGH PASS FILTER	LOW PASS FILTER	WIDE - BAND
DTMF / SINAD	OFF	OFF	OFF	ON
*** PRESS "EXEC" TO ACTIVATE SELECTION ***				
SPEAKER / PHONES	INT - MOD			

RF:	(Rcvr Center Frequency)
FL:	OFF
Level:	-50.0 dBm
Output:	T/R
GEN1	
Mod Src:	GEN1 PM
Mdulation:	5.0 Rad
Format:	TONE
Freq:	1000.0 Hz
Shape:	Sine

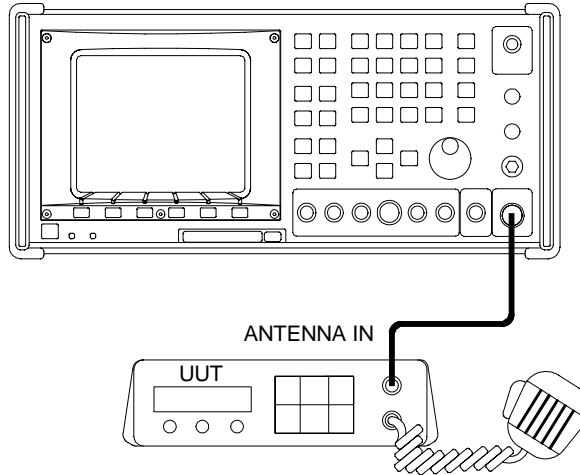

00607221

Generating PM Modulated RF Signal



# SECTION 5

## COMMON PRACTICES

---

### 5-1-4 GENERATING DCS CODED RF SIGNAL

This procedure configures the RF Generate Operation Screen to transmit an RF Signal FM Modulated with a DCS Code at the T/R Connector.

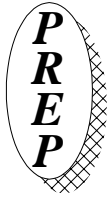

The deviation is set at 0.50 kHz.

The Output Level is -50 dBm.



- o Set RF Field to **Radio Center Frequency**.
- o Set Output Level to **-50 dBm**.
- o Set Output to **T/R**.
- o Select DATA Generator (**DATA**) for Modulation Source.
- o Set Modulation Type to **FM**.
- o Set Deviation Level to **0.50 kHz**.
- o Set Format to **DCS**.
- o Set Code to **114**.
- o Verify radio unsquelches.
- o Turn DATA generator off.
- o Verify radio squelches.

# SECTION 5

## COMMON PRACTICES

---

RF: (Radio Center Frequency)
FL: OFF
Level: -50.0 dBm
Output: T/R
DATA
Mod Src: DATA FM
Deviation: 0.50 kHz
Format: DCS
Code: 114

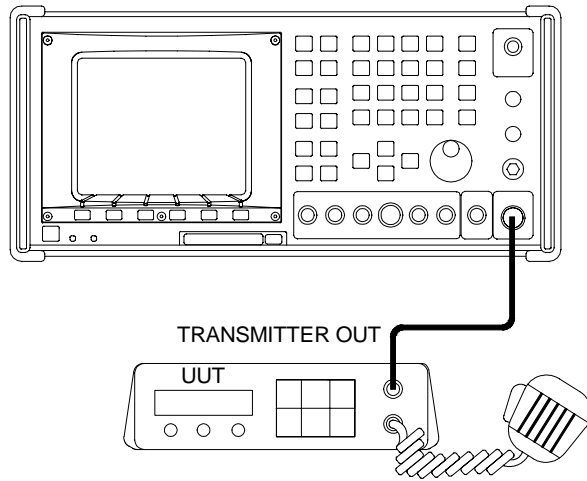

00607222

Generating DCS Coded RF Signal

# SECTION 5

## COMMON PRACTICES

---

### 5-1-5 GENERATING DTMF CODED RF SIGNAL

This procedure configures the RF Generate Operation Screen to transmit an RF Signal FM Modulated with DTMF Code at the T/R Connector.

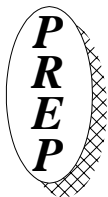

The deviation is set at 5 kHz.

The Output Level is -50 dBm.

The signal is set to run in a continuous loop.



- Set RF Field to ***Rcvr Center Frequency.***
- Set Output Level to ***-50 dBm.***
- Set Output to ***T/R.***
- Select DTMF Generator 1 (***DTMF***) for Modulation Source.
- Set Modulation Type to ***FM.***
- Set Deviation Level to ***3.50 kHz.***
- Enter desired DTMF Code.
- Set Mark Time to ***70 msec.***
- Set Space Time to ***70 msec.***
- Set Pause Time to ***70 msec.***
- Cursor to Code field.
- Press F2 ***CONT.***

# SECTION 5

## COMMON PRACTICES

---

RF:
FL: OFF
Level: -50.0 dBm
Output: T/R
DTMF
Mod Src: DTMF FM
Deviation: 3.50 kHz
Code: 123456789*0#
Mark: 70 msec
Space: 70 msec
Pause: 70 msec

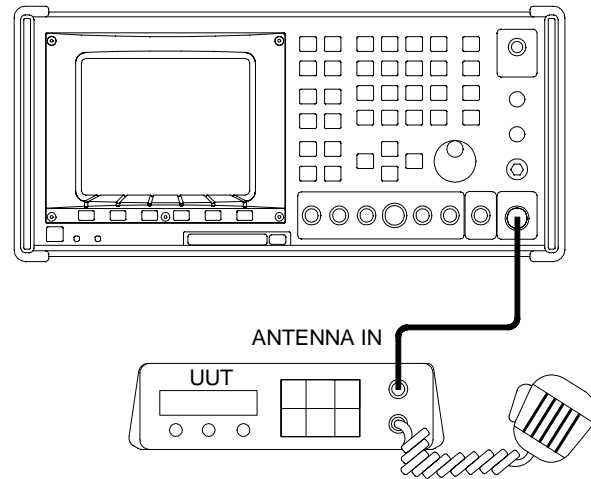

00607223

Generating DTMF Coded RF Signal

# SECTION 5

## COMMON PRACTICES

---

### 5-1-6 GENERATING RF SIGNAL USING EXTERNAL MODULATION

This procedure configures the RF Generate Operation Screen to transmit an RF Signal FM Modulated with 1 kHz External Modulation Source.



The deviation is set at 5 kHz by adjusting the input level of the Modulation Signal.

The Output Level is -50 dBm.

- 
- Set RF Field to **Rcvr Center Frequency**.
  - Set Output Level to **-50 dBm**.
  - Set Output to **T/R**.
  - Select External Modulation (**EXT**) for Modulation Source.
  - Set Modulation Type to **FM**.
  - Set Deviation Range to **NAR 3**.
  - Configure RF Generate Operation Screen for active **SCOPE**.
  - Set Oscilloscope Sweep for **1 ms/div**.
  - Set Oscilloscope Source for **Scope/DVM-AC**.
  - Connect External Modulation Source to SCOPE/DVM IN Connector.
  - Set External Modulation Source for 2.5 Vp. This setting produces 5 kHz Deviation independent of signal shape.
  - Connect External Modulation Source to EXT MOD IN Connector.

# SECTION 5

## COMMON PRACTICES

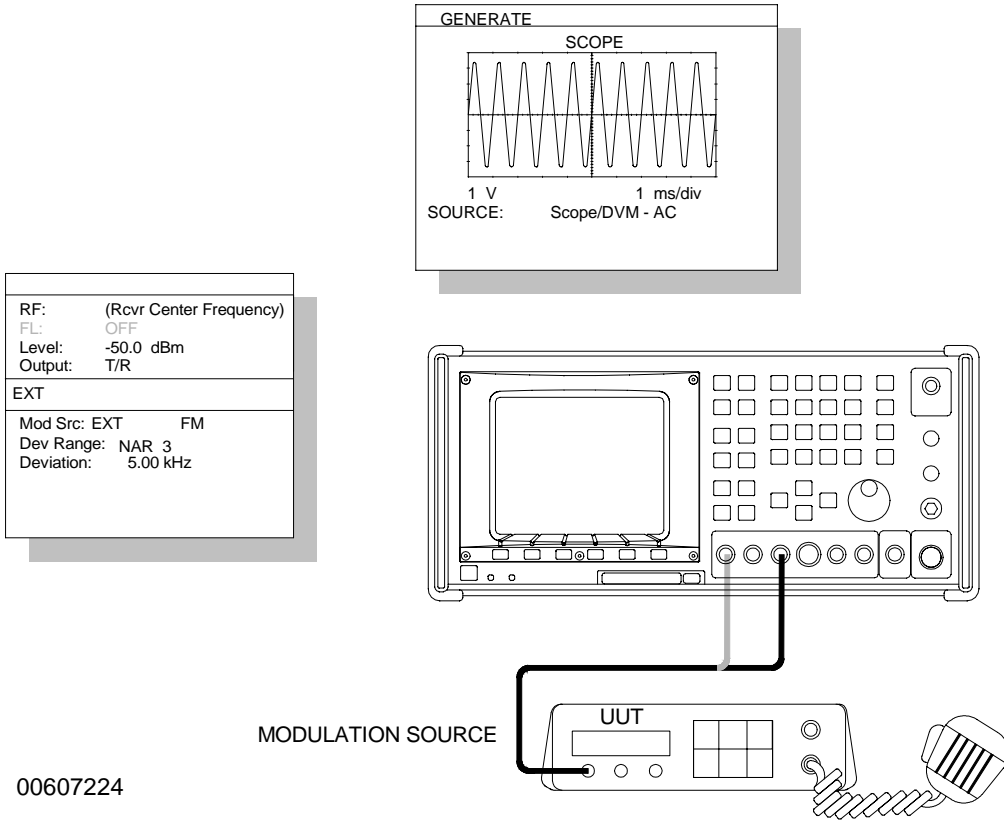

00607224

Generating RF Signal Using External Modulation

# SECTION 5

## COMMON PRACTICES

---

### 5-1-7 GENERATING MICROPHONE MODULATED RF SIGNAL

This procedure configures the RF Generate Operation Screen to transmit a Microphone Modulated RF Signal at the T/R Connector.

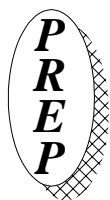

The Microphone is connected to the MIC/ACC Connector.

The Output Level is -50 dBm.

- 
- Set RF Field to ***Rcvr Center Frequency***.
  - Set Output Level to ***-50 dBm***.
  - Set Output to ***T/R***.
  - Select Microphone (***MIC***) for Modulation Source.
  - Set Modulation Type to ***FM***.
  - Set Deviation Range to ***NAR 3***.

# SECTION 5 COMMON PRACTICES

---

RF: (Rcvr Center Frequency)
FL: OFF
Level: -50.0 dBm
Output: T/R
MIC
Mod Src: MIC FM
Dev Range: NAR 3

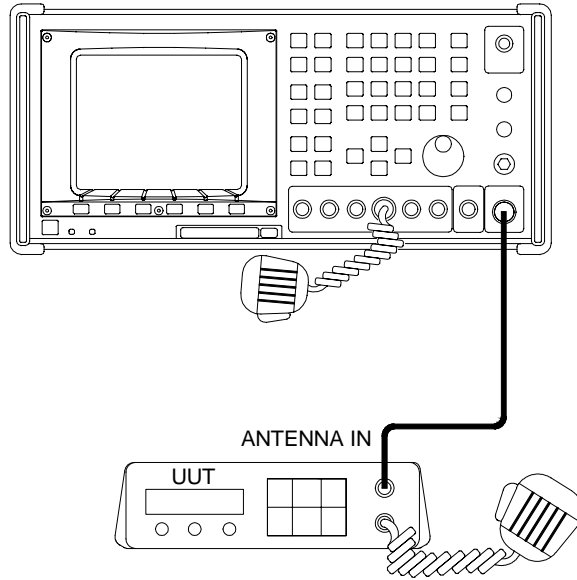

00607225

Generating Microphone Modulated RF Signal



# SECTION 5

## COMMON PRACTICES

---

### 5-1-8 ENCODING 2-TONE SEQUENTIAL FORMAT

This procedure configures the RF Generate Operation Screen to encode using the 2-Tone Sequential format.

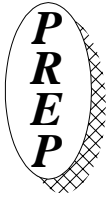

This example assumes an FM pager requires a first tone of 650 Hz for 500 ms and a second tone of 850 Hz for 1.5 sec. with a 0.25 sec. gap.



- Set RF Field to **Pager Center Frequency**.
- Set Output Level to **-30 dBm**.
- Set Output to **T/R**.
- Select **GEN1** for Modulation Source.
- Set Modulation Type to **FM**.
- Set Deviation to **5.0 kHz**.
- Set Format to **USER**.
- Cursor to Format Field and press F4 **CONFIG**.
- Edit the USER SIGNALING PROGRAM pop-up window to read:

USER SIGNALING PROGRAM		
<u>CHAR</u>	<u>FREQ (Hz)</u>	<u>DUR (ms)</u>
0	0.0	250
1	650.0	500
2	850.0	1500

- Press F6 **RETURN**.
- Cursor to Code Field and press F1 **CLEAR**.
- Attach an antenna to the T/R Connector.
- Enter **102**.
- Cursor to Format Field and Press F3 **BURST** or F2 **CONT** to set off the pager.

# SECTION 5

## COMMON PRACTICES

---

RF: (Pager Center Frequency)
FL: OFF
Level: -30.0 dBm
Output: T/R
GEN1
Mod Src: GEN1 FM
Deviation: 5.0 kHz
Format: USER
Code: 102

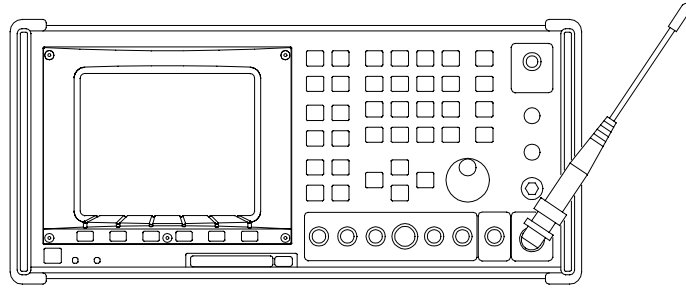

00607247

Encoding 2-Tone Sequential Format

# SECTION 5

## COMMON PRACTICES

---

THIS PAGE INTENTIONALLY LEFT BLANK.

# SECTION 5

## COMMON PRACTICES

---

### 5-2 RF RECEIVE

This section offers suggestions for equipment and screen setups for some common RF Receive practices.

- 5-2-1 Receiving FM Modulated RF Signal
- 5-2-2 Receiving AM Modulated RF Signal
- 5-2-3 Receiving PM Modulated RF Signal
- 5-2-4 Decoding 2 Tone Sequential Format

# SECTION 5

## COMMON PRACTICES

---

### 5-2-1 RECEIVING FM MODULATED RF SIGNAL

This procedure configures the RF Receive Operation Screen to receive a Frequency Modulated RF Signal at the ANTENNA Connector.



The transmitted signal is 5 kHz deviation of a 1 kHz sine wave at -60 dBm level.

The speaker is configured to play the demodulated signal.

- 
- Set *RF Field to Radio Center Frequency*.
  - Set Input to *ANT*.
  - Set Attenuation to *0 dB*.
  - Set Demodulation Type to *FM*.
  - Set IF Bandwidth to *300 kHz*.
  - Cursor to Line Field and press F6 *CONFIG*.
  - Set Mod Meter Filter Line Low-Pass Filter to *20 kHz*.
  - Set AF Counter Filter Line Low-Pass Filter to *4 kHz*.
  - Set Speaker/Headphones Filter Line to *W.B.* (Wideband).
  - Execute and return to RF Receive Operation Screen.
  - Adjust VOLUME Control for desired audio level.

# SECTION 5 COMMON PRACTICES

RECEIVER AUDIO / DATA FILTERS SETUP MENU				
LINE	BAND PASS FILTER	HIGH PASS FILTER	LOW PASS FILTER	WIDE - BAND
MOD METERS	<input type="checkbox"/> OFF	OFF	20 kHz	OFF
DTMF / SINAD	OFF	OFF	OFF	ON
AF CNTR/DECODE	OFF	OFF	4 kHz	OFF
DATA DECODER	OFF	OFF	OFF	ON
*** PRESS "EXEC" TO ACTIVATE SELECTION ***				
SPEAKER / PHONES	W.B.			
DEMOD OUT	AF CNT			

RF:	(Radio Center Frequency)
FL:	OFF
Input:	ANT Atten: 0 dB
Demod:	FM IF BW: 300 kHz
AF GEN OUT	OFF
LINE:	MOD MTR
HPF:	OFF LPF: 20kHz
BPF:	OFF

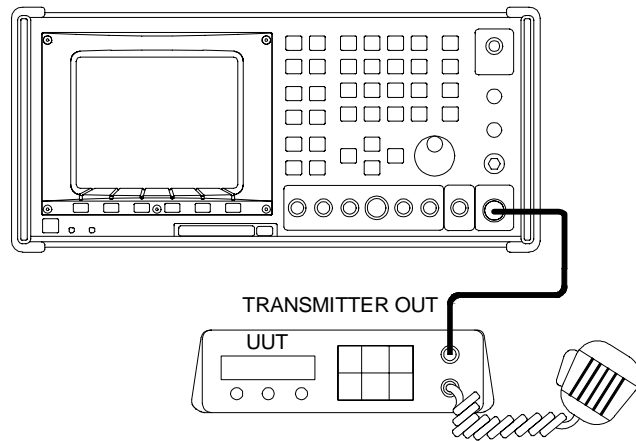

00607226

Receiving FM Modulated RF Signal

# SECTION 5

## COMMON PRACTICES

---

### 5-2-2 RECEIVING AM MODULATED RF SIGNAL

This procedure configures the RF Receive Operation Screen to receive an Amplitude Modulated RF Signal at the ANTENNA Connector.

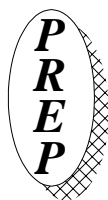

The transmitted signal has 40% Modulation Rate of a 1 kHz sine wave at -60 dBm level.

The speaker is configured to play the demodulated signal.



- Set RF Field to **Radio Center Frequency**.
- Set Input to **ANT**.
- Set Attenuation to **0 dB**.
- Set Demodulation Type to **AM**.
- Set IF Bandwidth to **300 kHz**.
- Cursor to Line Field and press F6 **CONFIG**.
- Set Mod Meter Filter Line Low-Pass Filter to **20 kHz**.
- Set AF Counter Filter Line Low-Pass Filter to **4 kHz**.
- Set Speaker/Headphones Filter Line to **W.B.** (Wideband).
- Execute and return to RF Receive Operation Screen.
- Adjust VOLUME Control for desired audio level.

# SECTION 5 COMMON PRACTICES

RECEIVER AUDIO / DATA FILTERS SETUP MENU				
LINE	BAND PASS FILTER	HIGH PASS FILTER	LOW PASS FILTER	WIDE - BAND
MOD METERS	<input type="checkbox"/> OFF	OFF	20 kHz	OFF
DTMF / SINAD	OFF	OFF	OFF	ON
AF CNTR/DECODE	OFF	OFF	4 kHz	OFF
DATA DECODER	OFF	OFF	OFF	ON
*** PRESS "EXEC" TO ACTIVATE SELECTION ***				
SPEAKER / PHONES	W.B.			
DEMOD OUT	AF CNT			

RF:	(Radio Center Frequency)
FL:	OFF
Input:	ANT Atten: 0 dB
Demod:	AM IF BW: 300 kHz
AF GEN OUT	OFF
LINE:	MOD MTR
HPF:	OFF LPF: 20kHz
BPF:	OFF

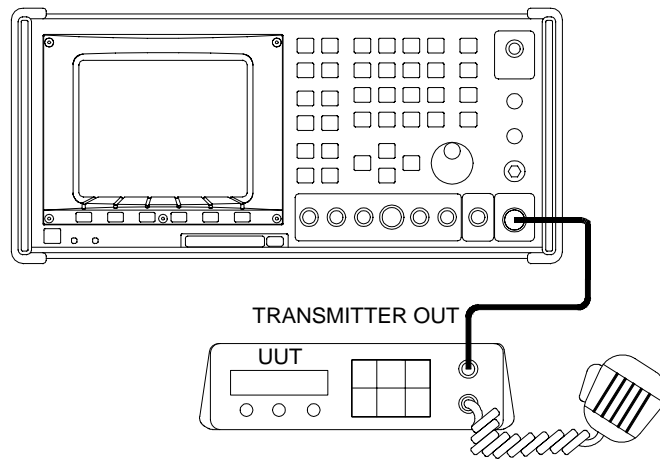

00607227

Receiving AM Modulated RF Signal



# SECTION 5

## COMMON PRACTICES

---

### 5-2-3 RECEIVING PM MODULATED RF SIGNAL

This procedure configures the RF Receive Operation Screen to receive a Phase Modulated RF Signal at the ANTENNA Connector.

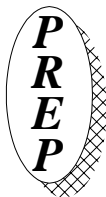

The transmitted signal has 5 Radians deviation of a 1 kHz sine wave at -60 dBm level.

The speaker is configured to play the demodulated signal.

- 
- Set RF Field to **Radio Center Frequency**.
  - Set Input to **ANT**.
  - Set Attenuation to **0 dB**.
  - Set Demodulation Type to **PM**.
  - Set IF Bandwidth to **300 kHz**.
  - Cursor to Line Field and press F6 **CONFIG**.
  - Set Mod Meter Filter Line Low-Pass Filter to **20 kHz**.
  - Set AF Counter Filter Line Low-Pass Filter to **4 kHz**.
  - Set Speaker/Headphones Filter Line to **W.B.** (Wideband).
  - Execute and return to RF Receive Operation Screen.
  - Adjust VOLUME Control for desired audio level.

# SECTION 5 COMMON PRACTICES

RECEIVER AUDIO / DATA FILTERS SETUP MENU				
LINE	BAND PASS FILTER	HIGH PASS FILTER	LOW PASS FILTER	WIDE - BAND
MOD METERS	<input type="checkbox"/> OFF	OFF	20 kHz	OFF
DTMF / SINAD	OFF	OFF	OFF	ON
AF CNTR/DECODE	OFF	OFF	4 kHz	OFF
DATA DECODER	OFF	OFF	OFF	ON
*** PRESS "EXEC" TO ACTIVATE SELECTION ***				
SPEAKER / PHONES	W.B.			
DEMOD OUT	AF CNT			

RF:	(Radio Center Frequency)
FL:	OFF
Input:	ANT Atten: 0 dB
Demod:	PM IF BW: 300 kHz
AF GEN OUT	OFF
LINE:	MOD MTR
HPF:	OFF LPF: 20kHz
BPF:	OFF

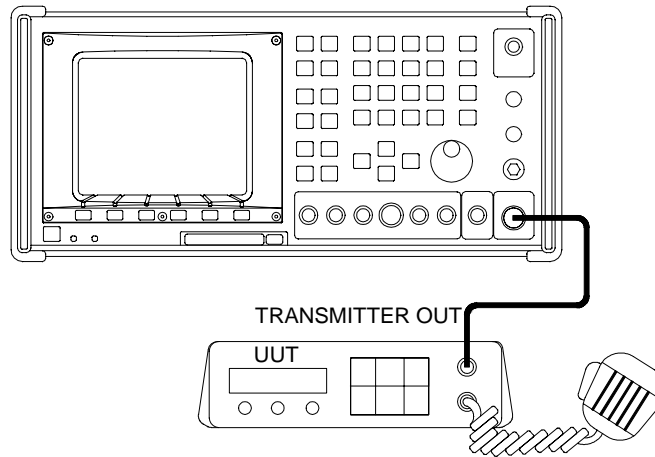

00607228

Receiving ± Modulated RF Signal

# SECTION 5

## COMMON PRACTICES

---

### 5-2-4 DECODING 2-TONE SEQUENTIAL FORMAT

This procedure configures the RF Receive Operation Screen to decode using the 2-Tone Sequential format.

- 
- Set RF Field to **Pager Center Frequency**.
  - Set Input to **T/R**.
  - Set Attenuation to **30 dB**.
  - Set Demodulation Type to **FM**.
  - Cursor to Line Field and press F6 **CONFIG**.
  - Set AF CNTR/DECODE High-Pass Filter to **OFF**.
  - Set AF CNTR/DECODE Low-Pass Filter to **4 kHz**.
  - Press F5 **EXEC**.
  - Press F6 **RETURN**.
  - Cursor to Deviation Meter and press F1 **ZOOM**.
  - Set Scp/Demod Cplg: to **AC**.
  - Set Range to **AUTO**.
  - Press F6 **RETURN**.
  - Set Tone/Data Code to **USER**.
  - Press F2 **DECODE**.
  - Observe the frequency and duration of tones received on the RECEIVED TONE DECODING Screen.

# SECTION 5 COMMON PRACTICES

RECEIVER AUDIO / DATA FILTERS SETUP MENU				
LINE	BAND PASS FILTER	HIGH PASS FILTER	LOW PASS FILTER	WIDE - BAND
MOD METERS	<input type="checkbox"/> OFF	OFF	OFF	OFF
DTMF / SINAD	OFF	OFF	OFF	ON
AF CNTR/DECODE	OFF	OFF	4 kHz	OFF
DATA DECODER	OFF	OFF	OFF	ON
*** PRESS "EXEC" TO ACTIVATE SELECTION ***				
SPEAKER / PHONES	W.B.			
DEMOD OUT	AF CNT			

FM DEVIATION METER	
RF:	(Pager Center Frequency)
Scp / Demod	Cplg: AC
Range:	AUTO
Peak Hold:	ON
Average:	ON 2
Upper Limit:	ON 8.00
Lower Limit:	ON 1.00
Alarm:	OFF
Mode:	NORMAL

<input type="checkbox"/> RE:	(Pager Center Frequency)
FL:	OFF
Input:	T/R Atten: 30 dB
Demod:	FM IF BW: 300 kHz
AF GEN OUT	OFF
LINE:	MOD MTR
HPF:	OFF LPF: OFF
BPF:	OFF
Tone/Data Code: USER	

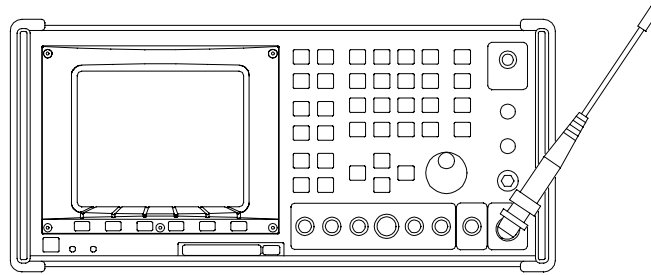

00607248

Decoding 2-Tone Sequential Format



# SECTION 5

## COMMON PRACTICES

---

- Press F5 **EXEC**.
- Press F6 **RETURN**.
- Press REC Mode Key.
- Repeat steps 8 through 16 for Receive Operation Screen.
- Press DPLX Mode Key.
- Cursor to RECEIVE field and press F1 **ZOOM**.
- Verify these readings:

Analyzer Level	-40 dBm ( $\pm 4$ dB)
AF Frequency	1000 Hz ( $\pm 1$ Hz)
RF Error	0.0 MHz ( $\pm 30$ Hz)
Deviation	3.30 kHz ( $\pm .5$ kHz)
Distortion	<3%
- Press DPLX Mode Key.
- Cursor to GENERATE field and press F1 **ZOOM**.
- Cursor to LINE field and press F6 **CONFIG**.
- Set filters:

DTMF/SINAD	BPF, <b>C-MSG</b>
SPEAKER/PHONES	<b>WB</b>
- Press F5 **EXEC**.
- Press F6 **RETURN**.
- Cursor to Level field and press F5, SINAD=.
- Set SINAD= field to **12.0 dB**.
- Press F6 **RETURN**.
- Press F6 **S=On/Off**.
- Verify RF Level settles to <-101 dBm.
- Press F6 **S=On/Off**.
- Disconnect everything.

# SECTION 5

## COMMON PRACTICES

---

THIS PAGE INTENTIONALLY LEFT BLANK.

# SECTION 6

## OPTIONS

---

### 6-1 INTERNAL BATTERY (OPTION 01)

Provides self-contained dc power when external ac or dc power is unavailable.

### 6-2 OVEN CRYSTAL OSCILLATOR FREQUENCY STANDARD (OPTION 02)

OCXO replaces the standard TCXO as system time base. Provides  $0.01 \times 10^{-6}$  accuracy.

### 6-3 30 kHz IF FILTER (OPTION 03)

Provides additional band limiting between 15 kHz and 300 kHz offered in standard set.

### 6-4 VARIABLE AUDIO GENERATOR-2 (OPTION 04)

---

NOW A STANDARD OPTION

The Variable Frequency Audio Generator has a frequency range of 5 to 20000 Hz with sine wave shape and 5 to 10000 Hz with ramp, triangle and square wave shapes.

Audio Generator-2 is available for use on the RF Generate, Duplex and Duplex Generate Operation Screens as a modulation source *and* as baseband output from the Audio/Data/Signaling Generators Operation Screen.

### 6-5 GENERATE AMPLIFIER (OPTION 05)

---

NOW A STANDARD OPTION

The Generate Amplifier is an internal RF Amplifier providing 26 dB gain for AUX RF OUT Connector. With Option 05 installed, RF AUX OUT Connector output range is -130 to +13 dBm for all Operation Modes.



# SECTION 6

## OPTIONS

---

### 6-6 DATA GENERATOR/BIT ERROR RATE (BER) METER (OPTION 07)

To access the BER Meter, press SPCL TEST MODE Key and select the Bit Error Rate. The BER Meter is designed for Baseband, RF Generate, RF Receive or Duplex Mode. The complexity of the BER Meter is best described in four separate sections.

BER Meter General Operation Screen

BER Meter Configuration Section

Receive Data Configuration Section

Send Data Configuration Section

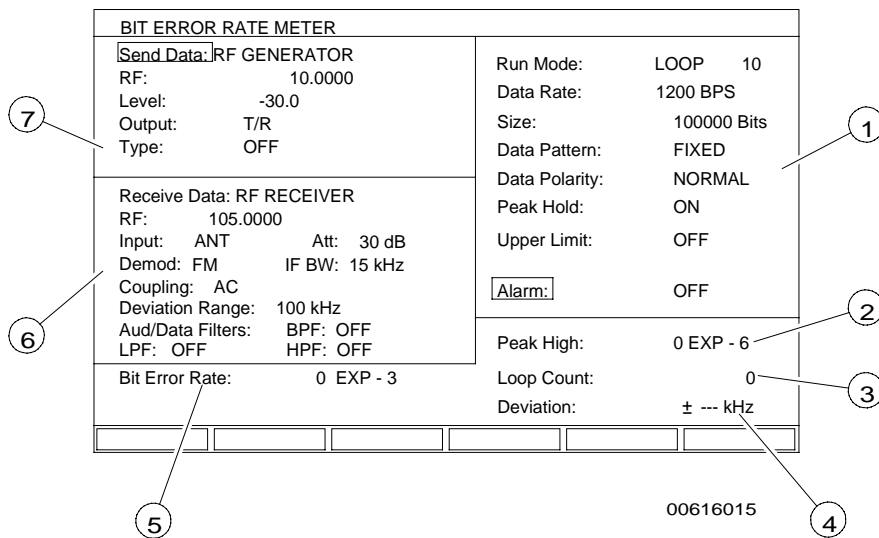

BER Meter Operation Screen

1. BER Meter Configuration Section  
Contains configuration data for signal.
2. Peak Reading  
Displays highest Bit Error Rate for current test.
3. Loop Count  
Displays number of times Data has been sent.

# SECTION 6

## OPTIONS

---

### 4. Input Level Indicator

Displays the modulation or voltage level of the Receive Data input source. The level indicator displays an AF Level Meter reading when the field is set for AUDIO/DATA IN.

When the field is set for RF RECEIVER, the Demod field determines the display (i.e., FM-Deviation Meter in kHz, AM-Modulation Meter in % or PM-Phase Meter in Rad).

### 5. Bit Error Rate

Displays Bit Error Rate. Exponent changes depending on Data Pattern Size (11).

### 6. Receive Data Configuration Section

Contains configuration data for Receive.

### 7. Send Data Configuration Section

Contains configuration data for Generate Section.

# SECTION 6

## OPTIONS

---

### 6-6-1 BER METER CONFIGURATION SECTION

This section contains the parameters for setting the message size, rate and pattern as well as information on configuring the BER Meter.

Functions and parameters for the BER Meter Configuration Section are as follows:



8. Run Mode

Displays selected Operation Mode. Selections include Continuous (CONTIN) and LOOP. When LOOP Mode is selected, LOOP Number (9) is displayed.

9. LOOP Number

Displays selected number of Data Patterns to be Generated. Displayed only with LOOP selected for Run Mode (8). Range is 1 to 100000.

10. Data Rate

Displays selected Data Rate in Bits Per Second (BPS). Selections include:

75 BPS	150 BPS	300 BPS
600 BPS	1200 BPS	2400 BPS
4800 BPS	9600 BPS	

11. Data Pattern Size

Displays selected Data Pattern Size. Selections range from 128 to 100000 bits.

12. Data Pattern Type

Displays selected Data Pattern Type. Selections are RANDOM and FIXED. FIXED is an 8 bit hexadecimal pattern that is repeated. RANDOM is based on a pseudo-random seed.

13. Data Polarity

Displays selected Data Polarity Type. Displays NORMAL or INVERTED. INVERTED is the opposite code of NORMAL.

Operation Mode. Selections include Continuous (CONTIN.) and LOOP. When LOOP Mode is selected, LOOP Number (2) is displayed.

14. Peak Hold

Displays selected Peak Hold Function Status. Status is OFF or ON. When ON, Peak Reading (2) is displayed.

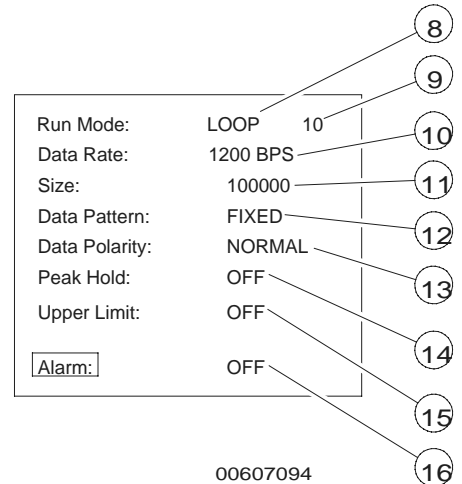

# SECTION 6

## OPTIONS

---

15. Upper Limit

Displays selected Upper Limit. Status is OFF or ON. When ON Upper Limit Value is displayed. Range of Upper Limit Value is  $0 \times 10^{-6}$  to  $999 \times 10^{-3}$ .

16. Alarm

Displays Alarm status. Status is OFF or ON. Alarm sounds when Upper Limit (15) is exceeded.

# SECTION 6

## OPTIONS

---

### 6-6-2 RECEIVE DATA CONFIGURATION SECTION

This section contains the parameters for setting the Receiver Portion of the BER Meter. Functions and parameters for the Receiver portion of the BER Meter are as follows:



#### 17. Receive Data Input

Displays selected Input for BER Meter. Selections include RF RECEIVER and AUDIO DATA IN. Selecting RF RECEIVER means an RF Carrier is demodulated to receive the Data Signal. Selecting AUDIO DATA IN means Data Signal is received directly through the AUDIO/DATA IN Connector.

The following items are displayed only when RF RECEIVER is selected as Receive Data Input (17):

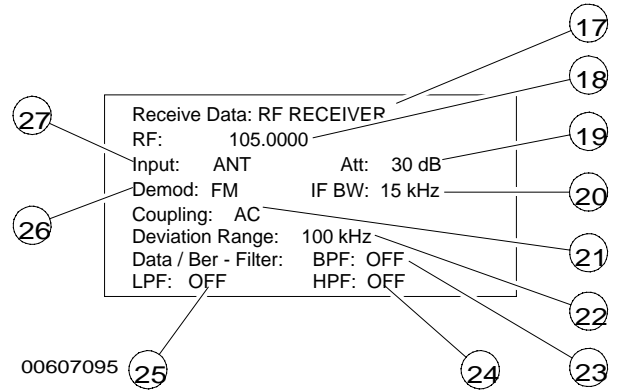

#### 18. RF Field

Displays RF Receive Frequency. Selections range from 0.0000 to 1000.0000 MHz.

#### 19. Attenuation

Displays Input Attenuation. Selections are 0 or 30 dB.

#### 20. IF Bandwidth

Displays IF Filter Bandwidth. Selections are 300 and 15 kHz.

#### 21. Coupling

Displays Coupling Type for RF Receiver. Displayed only with FM selected for Demod Type (26). Selections are AC or DC.

#### 22. Deviation Range

Displays FM Deviation Range. Displayed only with FM selected for Demod Type (26). Selections are 10, 20, 50 and 100 kHz.

#### 23. Bandpass Filter

Displays Bandpass Filter setting for demodulated signal. Selections include OFF and C-MSG (C-Message Weighted Filter).

High-Pass Filter/Low-Pass Filter combination and Bandpass Filter cannot be active simultaneously.

# SECTION 6

## OPTIONS

### 24. High-Pass Filter

Displays current High-Pass Filter setting for demodulated signal. Selections include OFF, 300 Hz and 4 kHz.

High-Pass Filter/Low-Pass Filter combination and Bandpass Filter cannot be active simultaneously.

### 25. Low-Pass Filter

Displays current Low-Pass Filter setting for demodulated signal. Selections include OFF, 300 Hz, 4 kHz and 20 kHz.

High-Pass Filter/Low-Pass Filter combination and Bandpass Filter cannot be active simultaneously.

### 26. Demod Type

Displays Demodulation Type. Selections include FM, AM and PM. Selection of FM activates Coupling (21) and Deviation Range (22) Fields.

### 27. Input

Displays signal Input Connector. Selections include T/R (T/R Connector) and ANT (ANTENNA Connector).

The following items are displayed only when AUDIO DATA IN is selected as Receive Data Input (17):

### 28. Bandpass Filter

Displays current Bandpass Filter setting for signal passed through AUDIO/DATA IN Connector. Selections include OFF and C-MSG (C-Message Weighted Filter).

High-Pass Filter/Low-Pass Filter combination and Bandpass Filter cannot be active simultaneously.

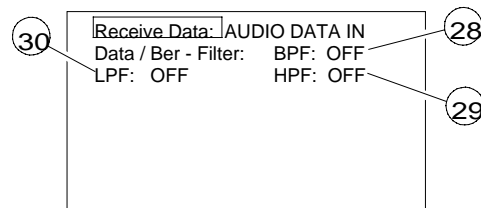

00607096

### 29. High-Pass Filter

Displays current High-Pass Filter setting for signal passed through AUDIO/DATA IN Connector. Selections include OFF, 300 Hz and 4 kHz.

High-Pass Filter/Low-Pass Filter combination and Bandpass Filter cannot be active simultaneously.

### 30. Low-Pass Filter

Displays current Low-Pass Filter setting for signal passed through AUDIO/DATA IN Connector. Selections include OFF, 300 Hz, 4 kHz and 20 kHz.

High-Pass Filter/Low-Pass Filter combination and Bandpass Filter cannot be active simultaneously.

# SECTION 6

## OPTIONS

---

### 6-6-3 SEND DATA CONFIGURATION SECTION

This section contains the parameters for setting the Transmitter Portion of the BER Meter.

Functions and parameters for the Transmitter portion of the BER Meter are as follows:



#### 31. Send Data Output

Displays selected Output for BER Meter. Selections include RF GENERATOR and AUD/DATA GEN OUT. Selecting RF GENERATOR means an RF Carrier is modulated with the Data Signal before transmission. Selecting AUD/DATA GEN OUT means Data Signal is transmitted directly through the AUDIO/DATA GEN Connector.

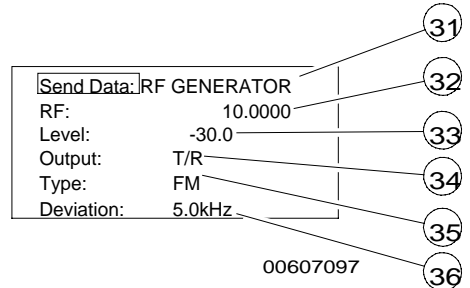

#### 32. RF Field

Displays RF Generator Frequency. Selections range from 0.0000 to 1000.0000 MHz.

#### 33. Level

Displays RF Generator output Level. Selections range from -130 to -30 dBm with T/R Connector selected as Output (34). Selections range from -130 to -13 dBm with AUX RF OUT Connector selected as Output (34).

#### 34. Output

Displays Output Connector. Selections include AUX (AUX RF OUT Connector) and T/R (T/R Connector).

#### 35. Modulation Type

Displays Modulation Type. Selections include OFF, AM, FM and PM.

#### 36. Modulation/Deviation Level

Displays Modulation Level. Selections range from 0.0% to 100% for AM Modulation Type (35), 0.00 to 100 kHz for FM Modulation Type (35) and 0.00 to 10 Rad for PM Modulation Type.

#### 37. Output Level

Displays Output Level of Data Signal. Selections range from 0.0 to 2.5 Vp in x1 (times 1) Mode or 0 to 25 mVp in /10 (divide by 10) Mode.

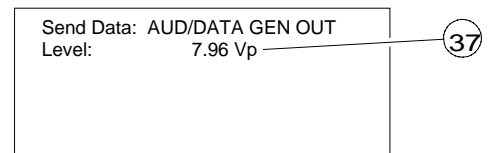

00607098

### 6-7 SINGLE SIDEBAND RECEIVE FILTER (OPTION 08)

#### 6-7-1 GENERAL

Installation of the Single Sideband Receive IF Filter provides the ability to monitor SSB signals. When Filter is installed, 3 kHz Selection is available for IF Bandwidth Filter.

The Single Sideband and 30 kHz IF Filters are mutually exclusive. Only one additional IF Filter can be installed.

#### 6-7-2 DESCRIPTION OF RECEIVE FUNCTION

RF Receive Operation is changed as follows:

- Analyzer Center Frequency is offset from center graticule  $\pm 1800$  Hz, depending on whether Upper Sideband (UB) or Lower Sideband (LB) is selected as Demodulation Type.
- No Modulation Meter is provided for Single Sideband. Either Modulation Reading or Modulation Meter, whichever was last selected, is blanked from the screen.
- RF Error Meter is not provided for Single Sideband. RF Error Meter is blanked from the screen.

Additions and Redefinitions of parameters on the RF Receiver Operation Screen are as follows:

1. Demodulation Type

Includes two additional settings: UB (Upper Sideband) and LB (Lower Sideband).

2. IF Bandwidth

Includes additional 3 kHz setting.

3. BFO Frequency

Tone/Data Code Field is renamed when UB or LB is selected as Demodulation Type (1). Displays selected adjustment for BFO Frequency. Adjustment range is  $\pm 4.0$  kHz. No Soft Function Keys are defined when BFO Frequency is displayed.

4. AGC Setting

Displays current AGC Setting, AUTO or MANUAL. AUTO provides automatic gain control while MANUAL sets feedback level for automatic gain control to defined level. Selection of MANUAL accesses Feedback Level Data Field. Range is 0 to 1023.



# SECTION 6

## OPTIONS

---

### 6-8 RCC SIGNALING FORMATS (OPTION 09)

Activates encode capabilities for 10 PS, 20 PS, MTS, IMTS and Tone Remote Control Signaling Formats. These formats appear as selections for GEN1 RF Generate Modulation Source, GEN1 Duplex Generate Modulation Source and Audio Function Generator-1. While these selections appear whether or not Option 9 is installed, they are not active. Accessing these selections is discussed in Section 3-3, Screens, Softkeys and Menus.

### 6-9 AUDIO/DIGITAL SIGNALING FORMATS (OPTION 11)

Provides encode/decode capabilities for both analog and digital signaling formats. Analog formats supported by Option 11 include:

CCIR	CCIRH	CCIRH4
EEA	EIA	NATEL
ZVEI	DZVEI	DDZVEI
EURO	5/6 Tone	

Listed below are the Frequencies and duration for each of the Audio Signaling Formats:

# SECTION 6 OPTIONS

Tone Number	C o d e D i g i t	C C I R	C C I R H	C C I R H 4	E E A	E I A	N A T E L	Z V E I	D Z V E I	D D Z V E I	E U R O	5 / 6 T o n e
<b>Tone 0</b>	0	19 81	19 81	19 81	19 81	60 0	16 33	24 00	22 00	24 00	97 9.8	60 0
<b>Tone 1</b>	1	11 24	11 24	11 24	11 24	741	631	10 60	970	10 60	90 3.1	741
<b>Tone 2</b>	2	11 97	11 97	11 97	11 97	882	697	11 60	10 60	11 60	83 2.5	882
<b>Tone 3</b>	3	12 75	12 75	12 75	12 75	10 23	770	12 70	11 60	12 70	76 7.4	10 23
<b>Tone 4</b>	4	13 58	13 58	13 58	13 58	11 64	852	14 00	12 70	14 00	70 7.4	11 64
<b>Tone 5</b>	5	14 46	14 46	14 46	14 46	13 05	941	15 30	14 00	15 30	65 2.0	13 05
<b>Tone 6</b>	6	15 40	15 40	15 40	15 40	14 46	10 40	16 70	15 30	16 70	60 1.0	14 46
<b>Tone 7</b>	7	16 40	16 40	16 40	16 40	15 87	12 09	18 30	16 70	18 30	55 4.0	15 87
<b>Tone 8</b>	8	17 47	17 47	17 47	17 47	17 28	13 36	20 00	18 30	20 00	51 0.7	17 28
<b>Tone 9</b>	9	18 60	18 60	18 60	18 60	18 69	14 77	22 00	20 00	22 00	47 0.8	18 69
<b>Repeat Tone</b>	R	21 10	21 10	21 10	21 10	459	18 05	26 00	24 00	970	10 62.9	459
<b>Group Tone</b>	G	24 00	24 00	24 00	10 55	20 10	19 95	28 00	885	885		20 10
<b>Alarm Tone</b>	A				24 00							
<b>Tone Width (ms)</b>		100	20	40	40	33	70	70	70	70	100	33/ 52

Digital formats supported by Option 11 include:

- POCSAG
- POCSAG/ (POCSAG INVERTED)

# SECTION 6

## OPTIONS

---

Encoding of the analog formats is available in RF Generate, Duplex Generate and Audio/Data/Signaling Generators Operation Screens. In the RF Generate and Duplex Generate Operation Screens, these formats are accessed by selecting GEN1 (Audio Generator-1) as a modulation source.

In the Audio/Data/Signaling Generators Operation Screen, these formats are accessed through Audio Generator-1. Refer to Section 3-3, Screens, Softkeys and Menus for information on selecting these formats.

Decoding of the analog formats is available in RF Receive and Duplex Receive Operation Screens. Select the desired signaling format for decoding at the Tone/Data Code Field. Refer to Section 3-3, Screens, Softkeys and Menus for information on selecting these formats.

For information on Digital Signaling Formats refer to the following:

- 6-9-1 Modulating RF Signals With Digital Signaling Formats
- 6-9-2 Encoding Digital Signaling Formats for Audio Signal
- 6-9-3 Decoding Digital Signaling Formats
- 6-9-4 Testing A Receiver using Digital Signaling Formats
- 6-9-5 Testing A Transmitter using Digital Signaling Formats

# SECTION 6

## OPTIONS

### 6-9-1 MODULATING RF SIGNALS WITH DIGITAL SIGNALING FORMATS

Digital Signaling Formats can be used as a modulation source in both RF Generate and Duplex Generate Operation. With Option 11 installed, optional Digital Signaling Formats are accessed by selecting the DATA Generator as the Modulation Source.

Additional Formats available with this option include POCSAG and POCSAG Inverted (POCSAG/).

DATA Modulation Source Block is defined as follows:



#### 1. Modulation Source

Displays selected Modulation Source. Selections include GEN1 (Audio Generator-1), GEN2 (Audio Generator-2), DTMF (DTMF Tone Generator), DATA (DATA Generator), EXT (External Modulation) and MIC (Microphone Modulation).

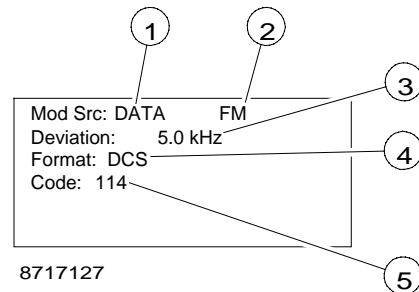

#### 2. Modulation Type

Displays selected Modulation Type. Selections include OFF, AM, FM and PM.

#### 3. Deviation/Modulation Level

Displays selected Deviation in kHz if current Modulation Type (2) is FM with range from 0.0 to 100 kHz. Displays selected Percent Modulation if current Modulation Type (2) is AM with range from 0% to 100%. Displays selected Deviation in radians if current Modulation Type (2) is PM with range from 0 to 10 Radians. Field is not displayed if Modulation Type (2) is OFF.

#### 4. Format

Displays Format type for Modulation Source (1). Selections available with DATA include DCS, DCS INV (DCS Inverted), POCSAG and POCSAG INV (POCSAG Inverted).

Access CONFIG for selecting POCSAG Function, Capcode Range and Data Rate.

Capcode Range values are 1 to 9999999. Start and Stop Capcode are selected. Activated, the system generates Start Capcode message. Capcode increases by one and message is sent until Stop Capcode message is generated.

# SECTION 6

## OPTIONS

---

Data Rates 512, 1200 and 2400 bps are only displayed with cursor at Data Rate field.  
POCSAG Functions include:

Function	Description
1 BEEP	Causes pager to beep one time.
2 BEEP	Causes pager to beep two times.
3 BEEP	Causes pager to beep three times.
4 BEEP	Causes pager to beep four times.
ALPHA_NUM	Transmits 0123456789
ALPHA_NUM UC	Transmits ABCDEFGHIJKLMOPQU RSTUVWXYZ.
ALPHA_NUM LC	Transmits abcdefghijklmnopqrstuv wxyz.
ALPHA_NUM SPEC	Transmits !"#\$%()*+,- ./:;<=>?
NUMERIC	Transmits 0123456789-[]
NUMERIC SEQ	Transmits following messages in sequence: 00000, 11111, 22222, 33333, 44444, 55555, 66666, and 77777.
NUMERIC CUSTOM	Transmits numbers.
ALPHA-NUM CUSTOM	Transmits data.

### 5. Code

Displays selected code for DATA Modulation Source. Not displayed with POCSAG or POCSAG/ selected as Format (4).

# SECTION 6

## OPTIONS

---

### 6-9-2 ENCODING DIGITAL SIGNALING FORMATS FOR AUDIO SIGNAL

With Option 11 installed, the DATA Generator in the Audio/Data/Signaling Generators Operation Screen has POCSAG and POCSAG Inverted (POCSAG/) Formats in addition to the DCS and DCS Inverted (DCS/) Formats contained in the standard set. Output for the DATA Generator is through the AUDIO/DATA GEN Connector. Editing the DATA Generator can be performed from the Audio/Data/Signaling Operation Screen, from the RF Receive Operation Screen, or from the Duplex Receive Operation Screen.

Functions and parameters for the DATA Generator with Option 11 installed are as follows:



1. DATA Generator Prompt

Activates selected Generator Source. Selections include GEN1 (Audio Generator-1), GEN2 (Audio Generator-2), DTMF (DTMF Tone Generator) and DATA (DATA Generator).

2. Format

Displays Format type for DATA Generator. Selections include DCS, DCS/ (DCS Inverted), POCSAG and POCSAG/ (POCSAG Inverted).

See Format under 6-9-1.

3. Code

Displays selected code for DATA Generator. Not displayed with POCSAG or POCSAG/ selected as Format (2).

4. Level

Displays selected Level of DATA Generator. Selections range from 0 to 2.5 Vp in X1 (times 1) Mode and 0 to 25.0 mVp in /100 (divide by 100) Mode.

# SECTION 6

## OPTIONS

---

### 6-9-3 DECODING DIGITAL SIGNALING FORMATS

With Option 11 installed, the RF Receive Operation Screen and the Duplex Receive Operation Screen are configurable to decode POCSAG and Inverted POCSAG signals.

A specific decode screen is provided for each Digital Signaling format type

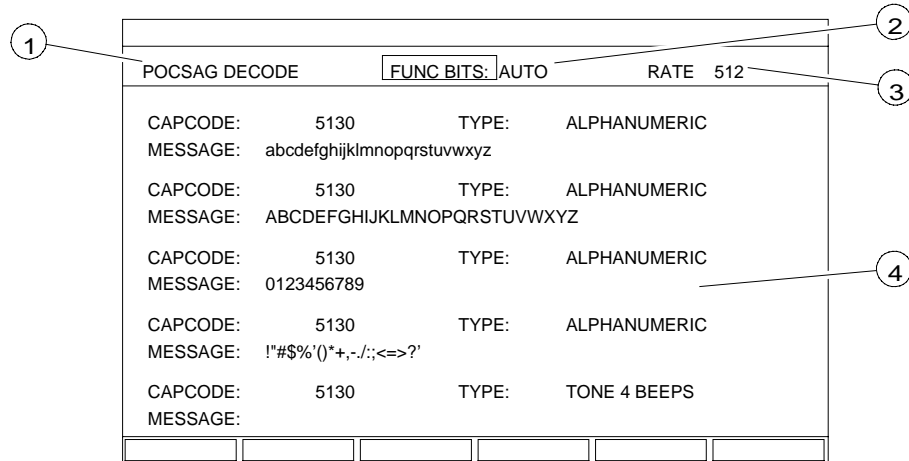

8717038

1. Decode Screen Label

Identifies whether Decode Screen format is POCSAG or POCSAG INV (Inverted POCSAG).

2. Function

Allows user to set Message Type to ALPHANO (ALPHANUMERIC), NUMERIC or AUTO. ALPHANO and NUMERIC settings force Decode Function to decode message as specified type. AUTO setting allows Decode Function to determine Message Type from received data.

3. Data Rate

Displays selected Data Rate for decoding messages. Selections include 512 and 1200 bps.

4. Data Screen

Displays up to five decoded messages. Information displayed includes Capcode, Message Type and Message for each received transmission.

# SECTION 6

## OPTIONS

---

### 6-9-4 TESTING A RECEIVER USING DIGITAL SIGNALING FORMATS

This procedure is an example for testing a Receiver using Digital Signaling Formats. In this procedure, an RF signal is modulated with a POCSAG message.

- 
- Press GEN Test Mode Key to access RF Generate Operation Screen.
  - Enter Receiver frequency in RF Field.
  - Select desired Output Connector for output of signal. If Receiver is tested with direct connection, connect Receiver Input Connector to selected Output Connector. Otherwise, connect antennas to selected Output Connector and Receiver Input Connector.
  - Set Output Level to desired level.
  - Select DATA Generator for Modulation Source.
  - Set Modulation Type to FM.
  - Set Deviation Level for 4.0 kHz or as required.
  - Set DATA Generator Format for POCSAG or POCSAG/.
  - Press F4 Config.
  - Set Data Rate to required setting for Receiver.
  - Set Capcode Range to Receiver Capcode.
  - Set POCSAG Function for desired test function.
  - Press F6 RETURN.
  - Press F5 BURST.
  - Verify Receiver receives signal and decodes POCSAG Message correctly.



# SECTION 6

## OPTIONS

---

### 6-9-5 TESTING A TRANSMITTER USING DIGITAL SIGNALING FORMATS

This procedure is an example for testing a Transmitter using Digital Signaling Formats. In this procedure, an RF signal is received and demodulated for the POCSAG message.



- Press REC Test Mode Key to access RF Receive Operation Screen.
- Enter Transmitter frequency in RF Field.
- Select desired Input Connector for input of signal. If Transmitter is tested with direct connection, connect Transmitter Output Connector to T/R Connector. Otherwise, connect antennas to ANTENNA Connector and Transmitter Output Connector.
- Set Demodulation Type to FM.
- Set IF Bandwidth to 15 kHz.
- Select DATA DEC as Audio Filter. Set Filter for 20 kHz Low-Pass.
- Select POCSAG or POCSAG/ for Tone/Data Type.
- With cursor on Tone/Data Code Field, press F2 DECODE to access Decode Screen.
- Set Decode Function to ALPHANO for Alphanumeric decode only, NUMERIC for Numeric decode only or AUTO for automatic selection based on POCSAG Message.
- Set Data Rate to required setting for Transmitter.
- If use of Scroll Function is required, press F5 SCROLL until highlighted.
- Press DECODE Soft Function Key F1 to start Decode Function.
- Verify transmitted message is decoded properly on Decode Screen. Press F2 STOP any time to stop decoding.

# SECTION 6

## OPTIONS

### 6-10 SPECTRUM ANALYZER TRACKING GENERATOR (OPTION 12)

Option 12 provides internal Tracking Generator for use with Spectrum Analyzer. A new field is displayed for turning on the Tracking Generator. Field displays OFF or Tracking Generator Level. When active, an RF signal is available at the AUX RF OUT Connector at the specified level.

The Tracking Generator function is independent of the analyzer center frequency and is programmable to sweep at a frequency different from the analyzer center frequency.

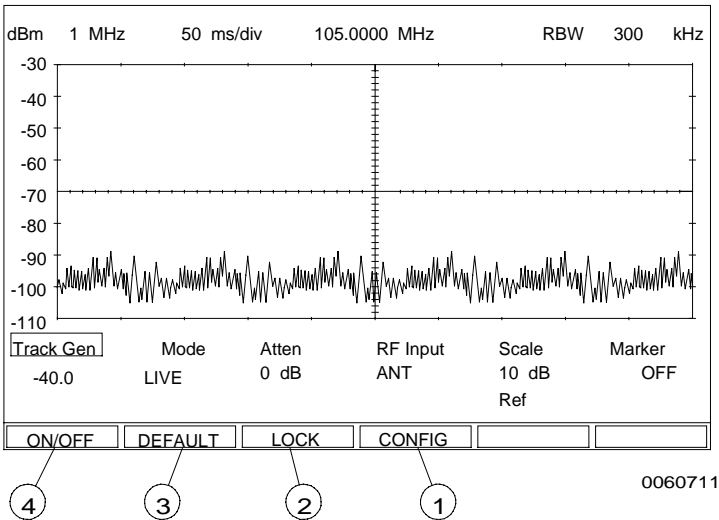

1. CONFIG Soft Function Key F4

Opens the Tracking Generator Configuration window. The two Tracking Generator fields are Center Frequency and Offset. Changing one field changes the other field appropriately.

There are separate Tracking Generator Configuration windows for Left Hand and Right Hand Analyzer when the analyzer is in split screen mode.

2. LOCK Soft Function Key F3

Locks the Tracking Generator center frequency at a constant offset from the analyzer center frequency. Changing the analyzer center frequency changes the tracking generator center frequency by a like amount.

3. DEFAULT Soft Function Key F2

Normal operation mode.

4. ON/OFF Soft Function Key F1

Activates the Tracking Generator ON or OFF. Range is -130.0 to 13.0 dB.

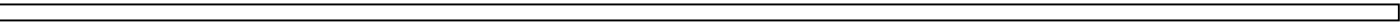

# SECTION 6

## OPTIONS

---

### 6-11 IEEE 488 (GPIB) INTERFACE (OPTION 13)

#### 6-11-1 GENERAL

Provides parallel GPIB interface for remote operation. Refer to COM-120C TMAC Manual for additional information on COM-120C Remote Operation and Commands.

#### 6-11-2 CONFIGURING FOR REMOTE OPERATIONS USING GPIB

To access GPIB Setup Screen, Press SETUP MEMORY Key (21) and access "4. GPIB SETTINGS." Configure for GPIB Operation as follows:

- Select Operations Mode (1). Available selections include TALK/LISTEN, TALK ONLY and LISTEN ONLY.
- Select GPIB Address (2). Selections range from 1 to 30.
- Set RCI Control to **ON**.

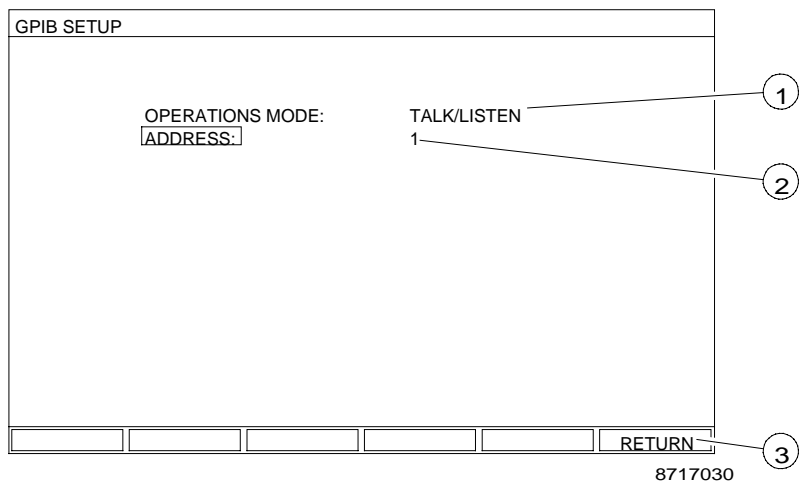

# SECTION 6

## OPTIONS

---

### 6-12 CLEARCHANNEL LTR<sup>®</sup> (OPTION 14)

#### 6-12-1 GENERAL

The CLEARCHANNEL LTR<sup>®</sup> Option allows the testing of Trunked Repeaters and Radios. The COM-120C tests encode/decode, Repeater access and Handoff functions of Trunked Radio mobile units. The COM-120C tests Handshake and Handoff functions of Repeaters.

# SECTION 6

## OPTIONS

---

### 6-12-2 ACCESSING THE CLEARCHANNEL LTR® TRUNKING TEST SYSTEM

CLEARCHANNEL LTR® testing is accessed by pressing the SPCL Test Mode Key and accessing “3. LTR Trunking.” When accessed, the LTR Trunking Menu is displayed.

The LTR Trunking Functions are as follows:

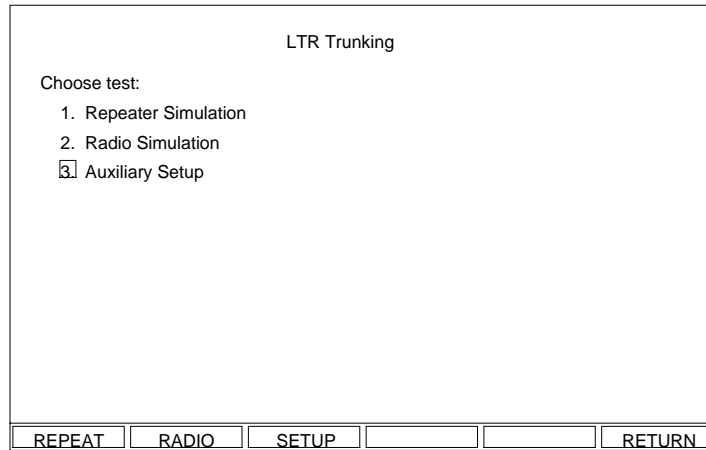

0060707

1. Repeater Simulation

Configures COM-120C to simulate Repeater to test Mobile Radios. Refer to paragraph 6-12-3 for description and paragraph 6-12-6 for operation.

2. Radio Simulation

Configures COM-120C to simulate a Mobile Radio to test Repeaters. Refer to paragraph 6-12-4 for description and paragraph 6-12-7 for operation.

3. Auxiliary Setup

Provides additional configuration for testing. Refer to paragraph 6-12-5 for description.

# SECTION 6

## OPTIONS

### 6-12-3 LTR TRUNKING REPEATER SIMULATION

The LTR Repeater Simulator is designed to test mobile phones. Once the LTR System is properly configured, continuous paging of the mobile phone is possible.

Go to the Duplex Operation Screen and set DATA Generator to LTR. Features of the LTR Trunking Repeater Simulator Operation Screen are as follows:

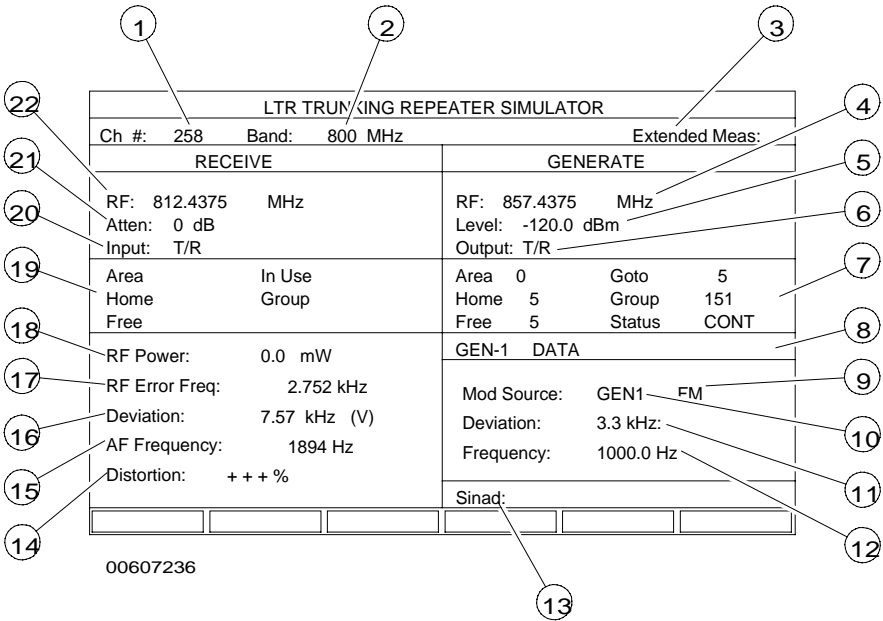

1. Channel Number  
Displays Channel Number. Selections are 1 to 760. Selection of Channel Number and Band Selection (2) set Generate RF Field (4) and Receive RF Field (22).
2. Band Selection  
Displays Trunking Band selection, 800 or 900 MHz.
3. Extended Meas:  
Allows for Extended Measurements.

# SECTION 6

## OPTIONS

---

### 4. Generate RF Field

Displays RF Generate Frequency of COM-120C. Value is dependent on Channel Number (1) and Band Selection (2). Field is for display only. Formula for figuring value is as follows where Channel # is Channel Number (1):

800 MHz Band Selection (2)

$$\text{Frequency (MHz)} = 806.0125 + [0.025 \times (\text{Channel \#} - 1)]$$

900 MHz Band Selection (2)

$$\text{Frequency (MHz)} = 896.0125 + [0.0125 \times \text{Channel \#} - 1]$$



Radios operating in 800 MHz Band within range of Canada or Mexico must use a 12.5 kHz offset.

### 5. Level

Displays Output Level. Range is dependent on Output (6). Range for Output (6) set to T/R is -130 to -20 dBm. Range for Output (6) set to AUX is -130 to -13 dBm.

### 6. Output

Displays Output Connector. Selections are T/R (T/R Connector) and AUX (AUX RF OUT Connector).

### 7. Transmit Trunking Data Block

Displays current data being passed to mobile radio. Refer to 6-12-3 for additional information.

### 8. Modulation Source Window

Displays active Modulation Sources (10). Inactive Modulation Sources (10) are not shown. If two (or more) sections of the RF Modulator are set in conflict (e.g. GEN1 set for PM and GEN2 set for FM, or GEN1 set for 0.01 kHz deviation and GEN2 set for 2.60 kHz deviation) then the screen shows the invalid source grayed out.

### 9. Modulation Source

Displays selected Modulation Source. Selections include GEN1 (Audio Generator-1), GEN2 (Audio Generator-2), DTMF (DTMF Tone Generator) and DATA (DATA Generator).

### 10. Modulation Type

Displays selected Modulation Type. Selections include OFF, AM, FM and PM.

# SECTION 6

## OPTIONS

---

### 11. Deviation/Modulation Level

Displays selected Deviation in kHz if current Modulation Type (9) is FM with range from 0.00 to 100 kHz. Displays selected Percent Modulation if current Modulation Type (9) is AM with range from 0.0% to 100%. Displays selected Deviation in Radians if current Modulation Type (9) is PM with range from 0.00 to 10 Radians. Field is not displayed if Modulation Type (9) is OFF.

### 12. Frequency/Code Field

If Modulation Source (8) is set for GEN1 or GEN2, displays Tone Frequency. GEN2 Frequency is not an editable field unless Option Generator 2 is installed. Range for GEN1 is 0.0 to 20000 Hz. If Modulation Source (8) is set for DTMF, displays DTMF Code. Any DTMF code can be entered up to 16 characters and other softkeys become available. If Modulation Source (8) is set for DATA, field is blank.

### 13. AUDIO/DATA IN Meters

Displays selected meter for measuring audio input to AUDIO/DATA IN Connector. Selections include Distortion, SINAD and AF LEVEL Meters. If one of these meters is active, Deviation Meter (16), AF Frequency Meter (15), Distortion/DTMF Meter (14) and LTR decoding are deactivated.

### 14. Distortion/DTMF Meters

Displays Distortion or DTMF. If Distortion is displayed as meter, distortion of demodulated signal is measured. If DTMF is displayed as meter, displays decoded DTMF Code from demodulated signal.

### 15. AF Frequency Counter

Displays AF Frequency of demodulated signal. Field is for display only.

### 16. Deviation Meter

Displays Deviation for data or audio (voice) as selected by operator. If Voice is Deviation Measurement is selected, (V) appears beside meter reading. If Data is selected, (D) appears beside meter reading.

### 17. RF Error Meter

Displays frequency error of LTR Transmitter referenced to Receive RF Field (22). Field is for display only.

### 18. RF Power Meter/RF Level Meter

Displays RF Power, in Watts, applied to T/R Connector. If ANT is selected for Input (20), RF Level Meter appears. Field is for display only.

### 19. Receive Trunking Data Block

Displays data being passed from mobile radio. Refer to 6-12-3(C) for additional information.



# SECTION 6

## OPTIONS

---

20. Input

Displays selected Input Connector. Selections are ANT (ANTENNA Connector) or T/R (T/R Connector).

21. Attenuation

Displays selected Input Attenuation. Selections are 0 or 30 dB.

Trunking Data Block is used to set the Repeater parameters that are passed to the Mobile Radios. This information, as well as the Channel Number (1) and

22. Receive RF Field

Displays RF Receive Frequency of COM-120C. Value is dependent on Channel Number (1) and Band Selection (2). Field is for display only. Formula for figuring value is as follows where Channel # is Channel Number (1):



Radios operating in 800 MHz Band within range of Canada or Mexico must use a -12.5 kHz offset.

800 MHz Band Selection (2)

$$\text{Frequency (MHz)} = 851.0125 + [.025 \times (\text{Channel \#} - 1)]$$

900 MHz Band Selection (2)

$$\text{Frequency (MHz)} = 935.0125 + [.0125 \times \text{Channel \#} - 1)]$$



Band Selection is required to test a Mobile Radio.

# SECTION 6

## OPTIONS

### 6-12-4 TRANSMIT TRUNKING DATA BLOCK

23. Goto

Displays Repeater Number to use for Status (25) set to Continuous. Must match Home (27) for Mobile Radio to unswelch. Range is 1 to 31.

24. Group

Displays ID Code for Mobile Radio to Test. Range is 1 to 255. Information is passed when Repeater transmits to access selected Mobile Radio.

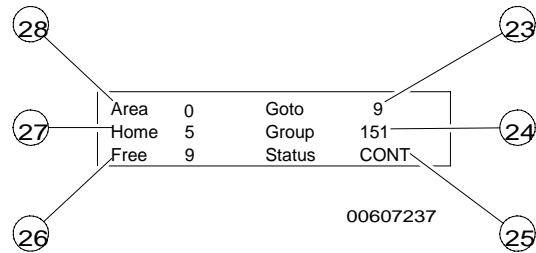

25. Status

Displays Status for Repeater for testing Mobile Radio. Set to FREE (Free Home Repeater), BUSY (Busy Home Repeater), CONT (Continuous transmit by Home Repeater) and DISCN (Disconnect Repeater-Mobile link). If CONT is desired, Goto (23) must match Home (27).

26. Free

Displays Repeater Number used for Mobile transmission with Status (25) set to BUSY. Free Repeater Channel on LTR Trunking Auxiliary Setup Screen (paragraph 6-12-4) must also be set for proper operation. Range is 1 to 31.

27. Home

Displays Home Repeater Number used for testing Mobile Radios. Range is 1 to 31.

28. Area

Displays Proximity Switch setting. Range is 1 or 0.

# SECTION 6

## OPTIONS

---

### 6-12-5 RECEIVE TRUNKING DATA BLOCK

The Receive Trunking Data Block is used to display the Mobile Radio parameters that are passed to the Repeater.

This information is for display only and cannot be edited.



29. In Use

Displays Repeater Number used by Mobile Radio. Displays 31 at message end to signify end of transmission.

30. Group

Displays ID Code for Mobile Radio.

31. Radio Status

Displays Mobile Radio Status. If CONNECT-DSP is displayed, Radio is currently linked to COM-120C in Dispatch Mode.

If CONNECT-RIC is displayed, Radio is currently linked to COM-120C in Radio Interconnect Mode.

If RELEASE is displayed, indicates COM-120C has received disconnect code from Mobile Radio.

If DISCONNECT is displayed, indicates Mobile Radio and Repeater are no longer connected due to manual disconnect or COM-120C disconnect due to elapsed time.

32. Free

Displays Free Field Data received from data. Displays 31 during normal operation.

33. Home

Displays Home Repeater Number for Mobile Radio. Range is 1 to 31.

34. Area

Displays Proximity Switch setting. Displays 1 or 0.

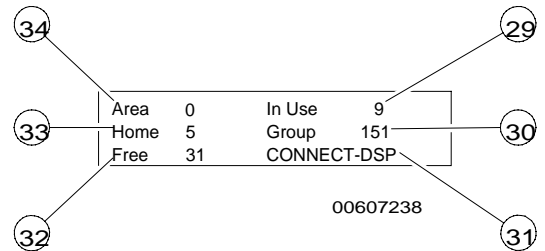

# SECTION 6

## OPTIONS

### 6-12-6 LTR TRUNKING RADIO SIMULATION

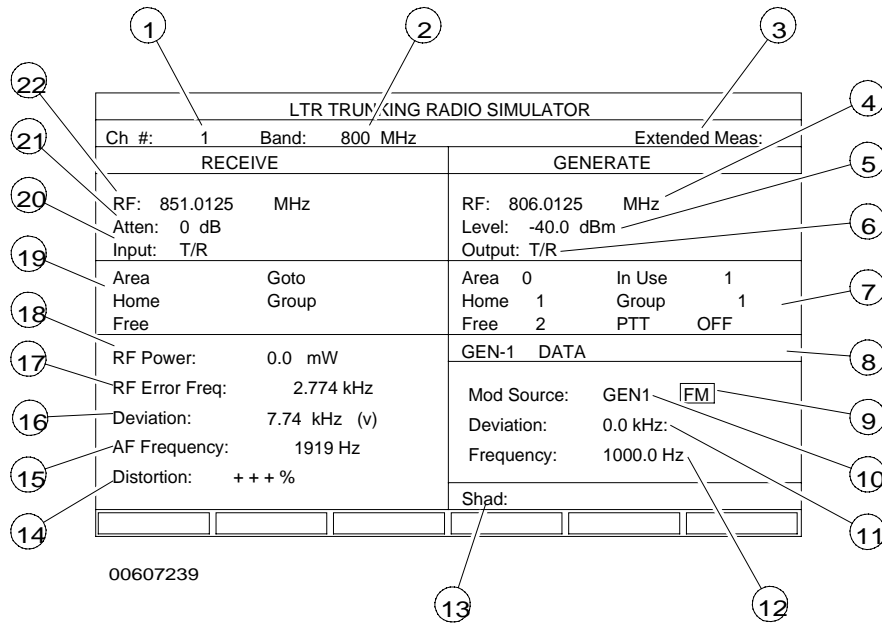

1. Channel Number

Displays Trunking Channel Number. Selections range from 1 to 760. Selection of Channel Number and Band Selection (2) is used to set Generate RF Field (4) and Receive RF Field (22).

2. Band Selection

Displays Trunking Band Selection. Displays 800 or 900 MHz.

3. Extended Meas:

Allows for Extended Measurements.

4. Generate RF Field

Displays RF Generate Frequency of COM-120C. Value is dependent on Channel Number (1) and Band Selection (2). Band automatically changes to USER if this field is edited. Formula for figuring value is as follows where Ch # is Channel Number (1):

800 MHz Band Selection (2)

$$\text{Frequency (MHz)} = 806.0125 + [.025 \times (\text{Channel \#} - 1)]$$

900 MHz Band Selection (2)

$$\text{Frequency (MHz)} = 896.0125 + [.0125 \times (\text{Channel \#} - 1)]$$

# SECTION 6

## OPTIONS

---



Radios operating in 800 MHz Band within range of Canada or Mexico must use a 12.5 kHz offset.

5. Level

Displays Output Level. Range is dependent on Output (6). Output set to T/R is -130 to -20 dBm. Output set to AUX is -130 to -13 dBm.

6. Output

Displays Output Connector. Selections are T/R (T/R Connector) and AUX (AUX RF OUT Connector).

7. Transmit Trunking Data Block

Displays current data being passed to Repeater. Refer to paragraph 6-12-4(B) for additional information.

8. Modulation Source Window

Displays active Modulation Sources (10). Inactive Modulation Sources are not shown. Two (or more) sections of the RF Modulator set in conflict shows the invalid source grayed out (e.g. GEN1 set for PM and GEN2 set for FM, or GEN1 set for 0.01 kHz deviation and GEN2 set for 2.60 kHz deviation).

9. Modulation Source

Displays selected Modulation Source. Selections include GEN1 (Audio Generator-1), GEN2 (Audio Generator-2), DTMF (DTMF Tone Generator) and DATA (DATA Generator).

10. Modulation Type

Displays selected Modulation Type. Selections include OFF, AM, FM and PM.

11. Deviation/Modulation Level

Displays selected Deviation in kHz if current Modulation Type (9) is FM with range from 0.00 to 100 kHz. Displays selected Percent Modulation if current Modulation Type (9) is AM with range from 0.0% to 100%. Displays selected Deviation in Radians if current Modulation Type (9) is PM with range from 0.0 to 10 Radians. Field is not displayed if Modulation Type (9) is OFF.

12. Frequency/Code Field

If Modulation Source (8) is set for GEN1 or GEN2, displays Tone Frequency. GEN2 Frequency is not an editable field unless Option Generator 2 is installed. Range for GEN1 is 0.0 to 20000 Hz. If Modulation Source (8) is set for DTMF, displays DTMF Code. Any DTMF code can be entered up to 16 characters and other softkeys become available. If Modulation Source (8) is set for DATA, field is blank.

# SECTION 6

## OPTIONS

---

13. AUDIO/DATA IN Meters

Displays selected meter for measuring audio input to AUDIO/DATA IN Connector. Selections include Distortion, SINAD and AF LEVEL Meters. If one of these meters is active, Deviation Meter (16), AF Frequency Meter (15), Distortion/DTMF Meter (14) and LTR Trunking are deactivated.

14. Distortion Meter

Displays distortion of demodulated signal.

15. AF Frequency Counter

Displays AF Frequency of demodulated signal. Field is for display only.

16. Deviation Meter

Displays Deviation for data or audio (voice) as selected by operator. If Voice is selected, Deviation Measurement is selected, (V) appears beside meter reading. If Data is selected, (D) appears beside meter reading.

17. RF Error Meter

Displays frequency error of Repeater referenced to Receive RF Field (21). Field is for display only.

18. RF Power Meter/RF Level Meter

Displays RF Power, in Watts, applied to T/R Connector. If ANT is selected for Input (20), RF Level Meter appears. Field is for display only.

19. Receive Trunking Data Block

Displays data being passed from Repeater. Refer to paragraph 6-12-4(C) for additional information.

20. Input

Displays selected Input Connector. Selections are ANT (ANTENNA Connector) or T/R (T/R Connector).

21. Attenuation

Displays selected Input Attenuation. Selections are 0 or 30 dB.

# SECTION 6

## OPTIONS

---

### 22. Receive RF Field

Displays RF Receive Frequency of COM-120C. Value is dependent on Channel Number (1) and Band Selection (2). Band automatically changes to USER if this field is edited. Formula for figuring value is as follows where Ch # is Channel Number (1):

800 MHz Band Selection (2)

$$\text{Frequency (MHz)} = 851.0125 + [.025 \times (\text{Channel \#} - 1)]$$

900 MHz Band Selection (2)

$$\text{Frequency (MHz)} = 935.0125 + [.0125 \times (\text{Channel \#} - 1)]$$



Radios operating in 800 MHz Band within range of Canada or Mexico must use a 12.5 kHz offset.

# SECTION 6

## OPTIONS

### 6-12-7 TRANSMIT TRUNKING DATA BLOCK

The Transmit Trunking Data Block is used to set the Mobile Radio parameters that are passed to the Repeater.

This information, as well as the Channel Number (1) and Band Selection are required to test a Repeater.

.....

23. In Use

Displays Repeater Number used by Mobile Radio. Displays 31 at message end to signify end of transmission. Range is 1 to 31.

24. Group

Displays ID Code for Mobile Radio serviced by Repeater. Range is 1 to 255.

25. PTT

Displays Push-To-Talk Status passed to Repeater. Displays ON or OFF. Push-To-Talk Status is toggled by pressing START/STOP CONTROL Key or use the MIC Accessory PTT.

26. Free

Not used by Mobile Radios. Field is editable, but should contain 31 for normal operation. Range is 1 to 31.

27. Home

Displays Home Repeater Number for Mobile Radio. Range is 1 to 31.

28. Area

Displays Proximity Switch setting. Range is 1 or 0.

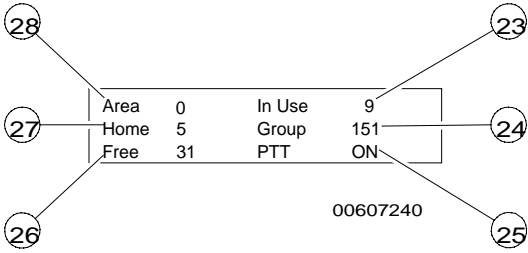



# SECTION 6

## OPTIONS

---

### 6-12-8 RECEIVE TRUNKING DATA BLOCK

The Receive Trunking Data Block is used to display the Repeater parameters that are passed to the Mobile Radio.

This information is for display only and cannot be edited.



29. Goto

Displays number of Repeater being tested. Display of 31 indicates end of transmission for Repeater.

30. Group

Displays ID Code specified by Group (24).

31. Repeater Status

Displays Repeater-Mobile Radio Connection Status. CONNECT is displayed if Repeater is receiving COM-120C signal. Blank if no signal.

32. Free

Displays Free Repeater data sent to COM-120C.

33. Home

Displays Home Repeater data sent by Repeater to COM-120C. Range is 1 to 31.

34. Area

Displays Proximity Switch setting. Displays 1 or 0.

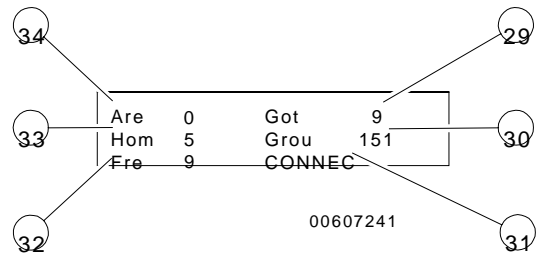

# SECTION 6

## OPTIONS

### 6-12-9 LTR TRUNKING AUXILIARY SETUP SCREEN

The LTR Trunking Auxiliary Setup Screen is provided to setup additional system parameters. This screen must be configured before operating the LTR Trunking Repeater

Simulator or the LTR Trunking Radio Simulator. Configure the LTR Trunking Auxiliary Setup Screen as follows:



1. Radio Ric ID

Displays Mobile Radio Interconnect Channel Number. Range is 1 to 250.

2. Free Rep Chan

Displays Free Repeater Channel Number for Free Repeater specified on LTR Trunking Repeater Simulator Operation Screen. Range is 1 to 760. If desired, the Repeater Receive and Transmit frequencies are editable to 1 GHz.

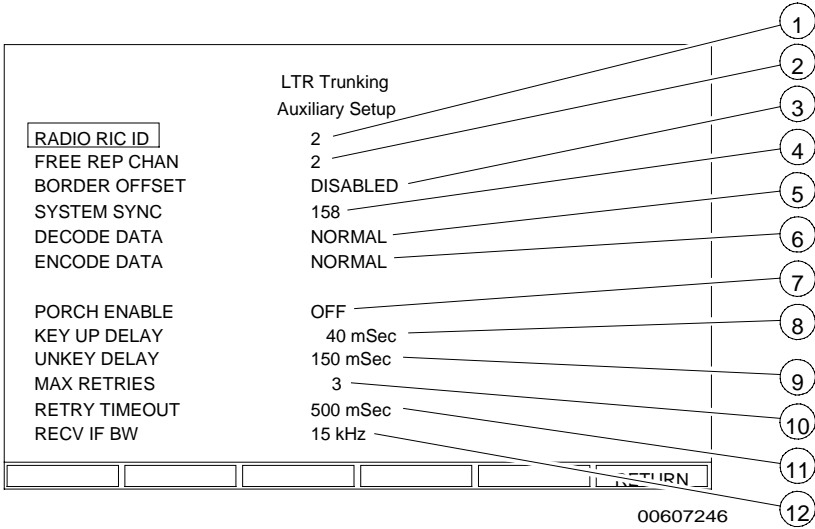

3. Border Offset

Displays status of Border Offset to RF due to proximity to Canadian or Mexican Border. Displays ENABLED or DISABLED.

4. System Sync

Displays hexadecimal code used for System Sync Code in Data Word. Default value is 158 (Hexadecimal). Range of value is 0 to 1FF (Hexadecimal).

5. Decode Data

Displays the polarity of Decoded Data. This feature enables the LTR option to work in any frequency band up to 1 GHz regardless of polarity.

6. Encode Data

Displays the polarity of Encoded Data. This feature enables the LTR option to work in any frequency band up to 1 GHz regardless of polarity.

# SECTION 6

## OPTIONS

---

7. Porch Enable

Toggles the Data Back Porch ON/OFF in the Radio Simulator. The LTR specification requires the radio to generate the back porch, but, some repeaters fail to function with this field enabled. Therefore, the factory default is OFF.

8. Key Up Delay

Sets the time data is sent after the COM-120C begins transmitting. Factory default is 40 ms. Shorter values connect more quickly. Use longer values if the repeater is having trouble locking onto the signal. (Example, a repeater that is seriously off frequency may exhibit this problem.)

9. Unkey Delay

Sets the time the RF carrier is turned off after the COM-120C stops sending data. Factory default is 150 mSec. The noise burst after the COM-120C unkeys and before the repeater squelch closes may confuse the repeater. Increase the time to help the repeater.

10. Max Retries

Sets the number of times the COM-120C tries to connect to the repeater. Factory default is 3.

11. Retry Timeout

Tells the COM-120C how long to wait for the repeater response. Factory default is 500 ms.

12. Recv IF BW

Set the COM-120C IF Bandwidth filter to use during operation. Factory default is 15 kHz.

# SECTION 6

## OPTIONS

---

### 6-12-10 AUXILIARY SETUP SCREEN CONFIGURATION

- From LTR Trunking Menu, select “3. Auxiliary Setup.”
- If Mobile Radio RIC Test is required, set RADIO RIC ID (1) to Radio Interconnect Channel (RIC). IF RIC Operation is not required, set to value with no Dispatch Operation interference.
- If Mobile Radio Busy Home Repeater Test is desired, enter Free Repeater Channel for FREE REP CHAN (2).
- If testing devices set for Border Offset, set BORDER OFFSET (3) to ENABLED. If Border Offset is not required, set BORDER OFFSET (3) to DISABLED.
- Set SYSTEM SYNC (4) to 158 unless nonstandard system is tested.
- Set DECODE DATA (5) to NORMAL or INVERT. Invert enables the LTR option to work in any frequency band up to 1 GHz regardless of polarity.
- Set ENCODE DATA (6) to NORMAL or INVERT. Invert enables the LTR option to work in any frequency band up to 1 GHz regardless of polarity.
- Press RETURN Soft Function Key F6 to return to LTR Trunking Menu.

# SECTION 6

## OPTIONS

### 6-12-11 REPEATER SIMULATOR OPERATION

The Repeater Simulator is used to test LTR Mobile Radios. To test LTR Mobile Radios, knowledge of the Radio Configuration Data, for the Radio under test, is required.

This section is divided into paragraphs. The first paragraph is General Configuration and the remaining paragraphs are different tests. Perform the General Configuration before each test.

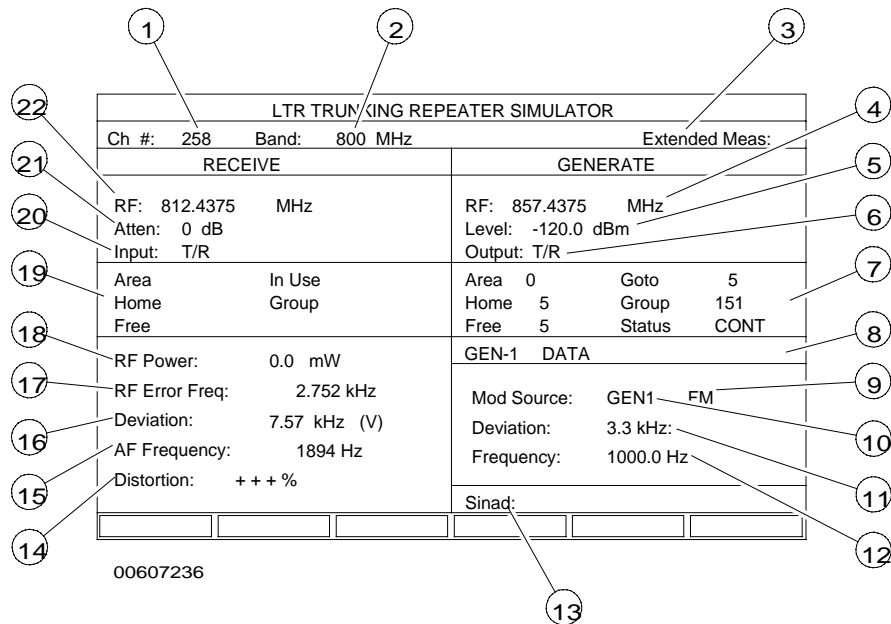

- Configure Auxiliary Setup Screen.
- From LTR Trunking Menu, select "1. Repeater Simulation."
- Enter Channel Number (1) of Mobile Radio. Range is 1 to 760.
- Choose Band Selection (2). Selections are 800 MHz, 900 MHz or USER.
- Select Output (6) for COM-120C Generator. Selections are T/R (T/R Connector) or AUX (AUX RF OUT Connector).
- Set Level (5) to desired Output Level. Range for Output (6) set to T/R is -130 to -40 dBm. Range for Output (6) set to AUX is -130 to -13 dBm.
- Activate Modulation Source (10) as required. If two (or more) sections of the RF Modulator are set in conflict (e.g. GEN1 set for PM and GEN2 set for FM, or GEN1 set for 0.01 kHz deviation and GEN2 set for 2.60 kHz deviation) then the screen shows the invalid source grayed out.
- If AUDIO/DATA IN Meter Operation is required, select desired Meter.  
If AUDIO/DATA IN Meter Operation is selected, Deviation Meter (16), AF Frequency Meter (15), and Distortion/ DTMF Meter are deactivated.

# SECTION 6

## OPTIONS

---

- If Distortion/DTMF Meter Operation is required, select desired Meter.
- Configure Deviation Meter (16).
- Select Input (20) for desired Input Connector. Selections include T/R (T/R Connector) and ANT (ANTENNA Connector).  
If Mobile Radio output is >0 dBm, select T/R. If ANT Input (20) is selected and Mobile Radio Output is >30 dBm, set Attenuation (21) for 30 dB.
- Set Attenuation (21). Selections include 0 dB and 30 dB. If ANT Input (20) is selected and Mobile Radio Output is >30 dBm, set Attenuation (21) for 30 dB.

# SECTION 6

## OPTIONS

---

### 6-12-12 LTR RADIO HANDSHAKE TEST

This test verifies the COM-120C is able to link with the Mobile Radio and a proper encode/decode sequence is performed. Perform these additional tests simultaneously:

RF Power, RF Error, Voice FM Deviation, Data FM Deviation, Distortion and AF Frequency Measurements.



- Set Deviation Meter (16) to measure Voice or Data FM Deviation as needed.
- Set Group (24) for ID Code of Mobile Radio.
- Set Status (25) to **FREE**.
- Set Home (27) to Mobile Radio Home Repeater Number.
- Set Area (28) for Mobile Radio Area switch setting.
- Connect Mobile Radio RF Output to connector specified by Input (20).
- Connect Mobile Radio RF Input to connector specified by Output (6).
- Key Mobile Radio. Verify **CONNECT-DSP** or **CONNECT-RIC** is displayed for Radio Status (31).
- Verify Group (30) matches Group (24).
- Verify Home (33) and In Use (29) match Home (27).
- Verify Area (34) matches Area (28).
- Verify Free (32) displays **31**.
- Unkey Mobile Radio. Verify Release is displayed for Radio Status (31). Verify In Use (29) displays **31**.

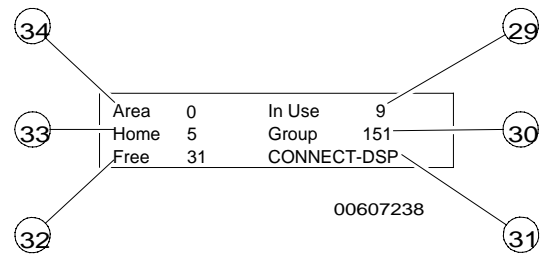
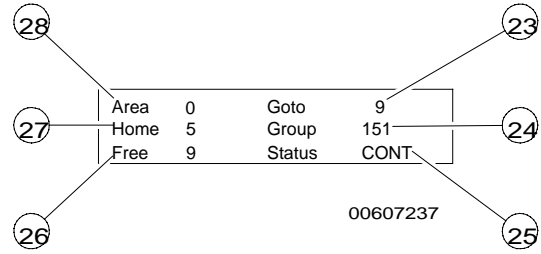

# SECTION 6

## OPTIONS

### 6-12-13 LTR RADIO HANDOFF TEST

This test verifies that the COM-120C is able to link with the Mobile Radio and a proper Handoff to a free repeater is performed. Perform these additional tests simultaneously:

RF Power, RF Error, Voice FM Deviation, Data FM Deviation, Distortion and AF Frequency Measurements.



- Set Deviation Meter (16) to measure Voice or Data FM Deviation as needed.
- Set Group (24) for ID Code of Mobile Radio.
- Set Status (25) to **BUSY**.
- Set Free (26) for Mobile Radio Free Repeater Number.
- Set Home (27) to Mobile Radio Home Repeater Number.
- Set Area (28) for Mobile Radio Area switch setting.
- Connect Mobile Radio RF Output to connector specified by Input (20).
- Connect Mobile Radio RF Input to connector specified by Output (6).
- Key Mobile Radio. Verify **CONNECT-DSP** or **CONNECT-RIC** is displayed for Radio Status (30).
- Verify Group (30) matches Group (24).
- Verify Home (33) matches Home (27).
- Verify In Use (29) matches Free (26).
- Verify Area (34) matches Area (28).
- Verify Free (32) displays **31**.
- Unkey Mobile Radio. Verify Release is displayed for Radio Status (31). Verify In Use (29) displays **31**.

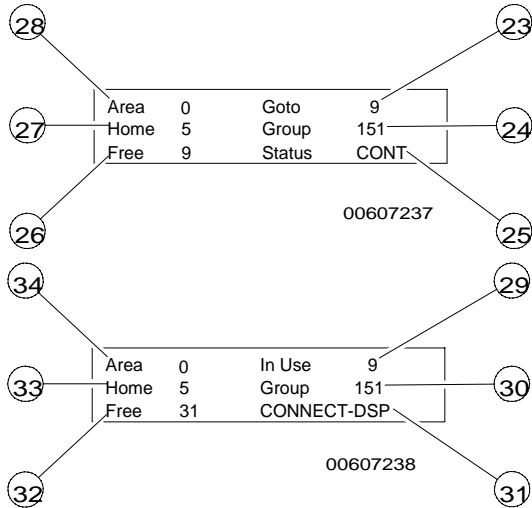



# SECTION 6

## OPTIONS

---

### 6-12-14 LTR RADIO RECEIVE TEST

This test verifies that the COM-120C is able to link with the Mobile Radio and an audio modulated RF Signal transmitted by the COM-120C is received by the Mobile Radio.

Perform these additional tests simultaneously: AUDIO/DATA IN Meters to measure Distortion, SINAD and AF Level of the signal demodulated by the Mobile Radio.

- If AUDIO/DATA IN Meters (13) are required, set following parameters:

Modulation Source for **GEN1**.

Modulation Type (10) to **FM**.

Deviation/Modulation Level for **3.30 kHz**.

Frequency/Code Field for **1000.0 Hz**.

- Set Goto (23) to Home Repeater Number for Mobile Radio.
- Set Group (24) for ID Code of Mobile Radio.
- Set Status (25) to **CONT**.
- Set Home (27) to Mobile Radio Home Repeater Number.
- Set Area (28) for Mobile Radio Area switch setting.
- Connect Mobile Radio RF Output to connector specified by Input (20).
- Connect Mobile Radio RF Input to connector specified by Output (6).
- Connect Mobile Radio Audio Output to AUDIO/DATA IN Connector.
- Verify 1000 kHz audio tone is audible.
- Verify AUDIO/DATA IN Meter Measurement, if required.

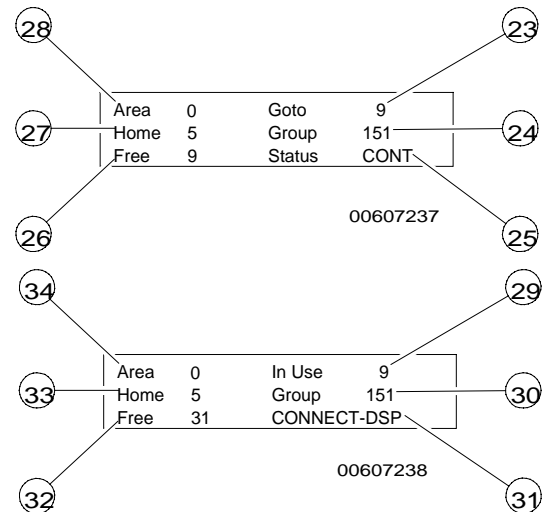

# SECTION 6

## OPTIONS

### 6-12-15 RADIO SIMULATOR OPERATION

The Radio Simulator is used to test LTR Repeaters. To test LTR Repeaters, knowledge of the Radio Configuration Data is required for the Mobile Radios that are serviced by the Repeater being tested.

This section is divided into paragraphs with the first paragraph being General Configuration and the remaining paragraphs being different tests. Perform the General Configuration before each test.

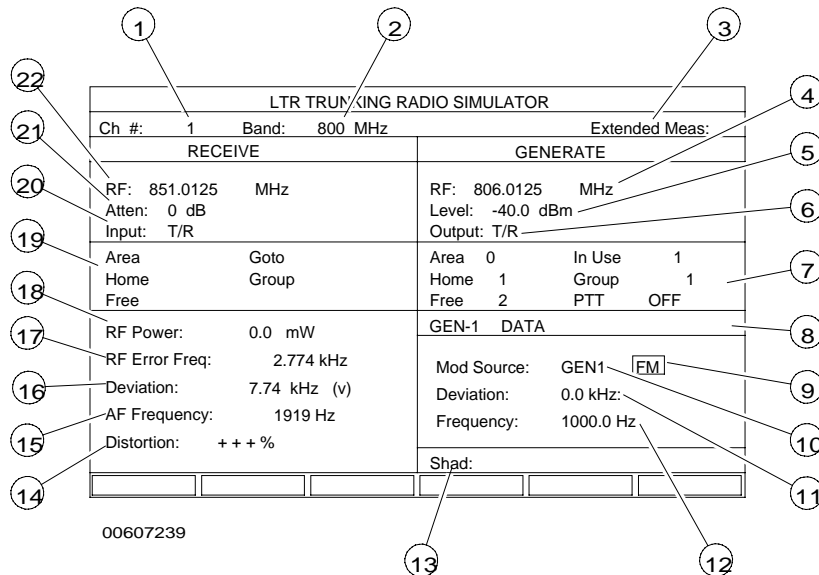

- Configure Auxiliary Setup Screen
- From LTR Trunking Menu, select "1. Radio Simulation."
- Enter Channel Number (1). Range is 1 to 760.
- Choose Band Selection (2). Selections are 800 MHz, 900 MHz or USER.
- Select Output (6) for COM-120C Generator. Selections are T/R (T/R Connector) or AUX (AUX RF OUT Connector).
- Set Level (5) to desired Output Level. Range for Output (6) set to T/R is -130 to -40 dBm. Range for Output (6) set to AUX is -130 to -13 dBm.
- Activate Modulation Source (10) as required. If two (or more) sections of the RF Modulator are set in conflict (e.g. GEN1 set for PM and GEN2 set for FM, or GEN1 set for 0.01 kHz deviation and GEN2 set for 2.60 kHz deviation) then the screen shows the invalid source grayed out.
- If AUDIO/DATA IN Meter Operation is required, select desired meter.
- If AUDIO/DATA IN Meter Operation is selected, Deviation Meter (16), AF Frequency Meter (15) and Distortion/ DTMF Meter are deactivated.
- If Distortion Meter Operation is required, select desired meter.

# SECTION 6

## OPTIONS

---

- Configure Deviation Meter (16).
- Select Input (20) for desired Input Connector. Selections include T/R (T/R Connector) and ANT (ANTENNA Connector). If Repeater output is >0 dBm, select T/R. If ANT Input (20) is selected and Repeater Output is >30 dBm, set Attenuation (21) for 30 dB.
- Set Attenuation (21). Selections include 0 dB and 30 dB. If ANT Input (20) is selected and Repeater Output is >30 dBm, set Attenuation (21) for 30 dB.

# SECTION 6

## OPTIONS

### 6-12-16 LTR REPEATER HANDSHAKE TEST

This test verifies that the COM-120C is able to link with the Repeater and a proper encode/decode sequence is performed. Perform these additional tests simultaneously:

RF Power, RF Error, Voice FM Deviation, Data FM Deviation, Distortion and AF Frequency Measurement.



- Perform paragraph 6-12-6. AUDIO/DATA IN Meters (13) are not used with this test. Set Deviation Meter (16) to measure Voice or Data FM Deviation as needed.
- Set Group (24) for ID Code of Mobile Radio being simulated.
- Set In Use (23) and Home (27) to Repeater Number.
- Set Area (28) for simulated Mobile Radio Area switch setting.
- Connect Repeater RF Output to connector specified by Input (20).
- Connect Mobile Radio RF Input to connector specified by Output (6).
- Press START/STOP CONTROL Key. Verify CONNECT is displayed for Repeater Status (31).

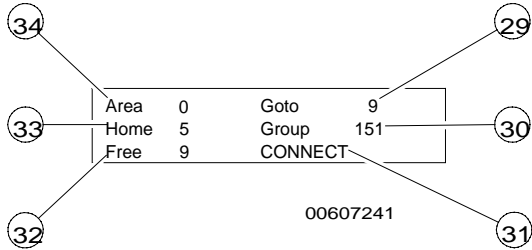
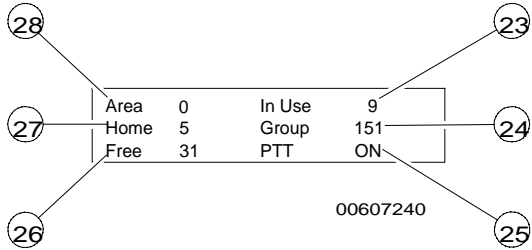

# SECTION 6

## OPTIONS

---

### 6-13 AMPS CELLULAR TESTING (OPTION 15)

The AMPS Cell Site Simulator is Option 15 of the COM-120C and is used to test AMPS Mobile Telephone Equipment. This option is accessed by pressing SPCL Test Mode Key and selecting "2. Cellular."

#### 6-13-1 AMPS CELL SITE SIMULATOR SETUP

The COM-120C is set up for AMPS Mobile Phone testing by the following procedure:



- Press SPCL Mode Key. Select "2. Cellular" from the Options Menu.
- Rotate SQUELCH Control ccw until squelch is set to minimum.
- Rotate VOLUME Control fully ccw and then cw, until static becomes audible.
- Rotate SQUELCH Control cw, slowly, until static is no longer audible.



*If "data parity error" message is displayed during test operation, squelch setting may be too low.*

- Squelch levels higher than necessary can prevent AMPS testing from functioning.
- Turn Mobile Phone power on.
- To perform Audio Test, connect demodulated audio output connector of Mobile Phone to AUDIO/DATA IN Connector.

# SECTION 6

## OPTIONS

---

### 6-13-2 AMPS CELL SITE SIMULATOR MAIN AND SETUP MENUS

Press the SPCL Mode Key. Choose "2. Cellular" to access the AMPS Cellular Menu.

The Automatic and Manual Tests and Setup Screens are selected from this Menu.

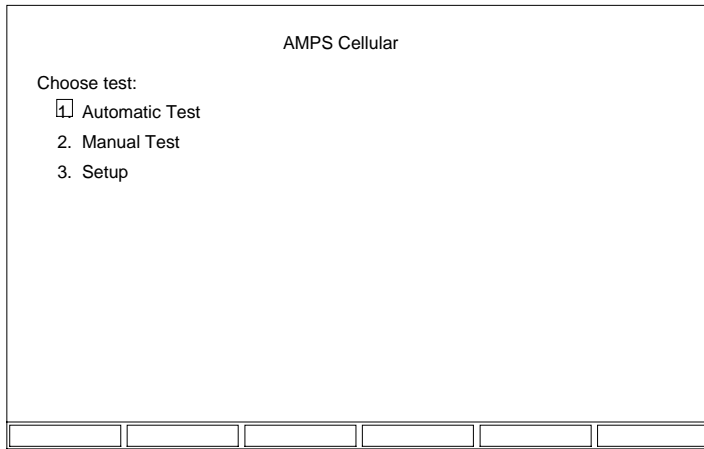

871709

The parameters used for the Automatic and Manual Tests are selected through the AMPS Setup Screen. The AMPS Setup Menu is divided into 2 screens: Pages 1 and 2.

Access "3. Setup" from the AMPS Cellular Menu to display Page 1 of the AMPS Setup Screen. Following is a listing of the AMPS Setup parameters, uses and ranges.

# SECTION 6

## OPTIONS

---

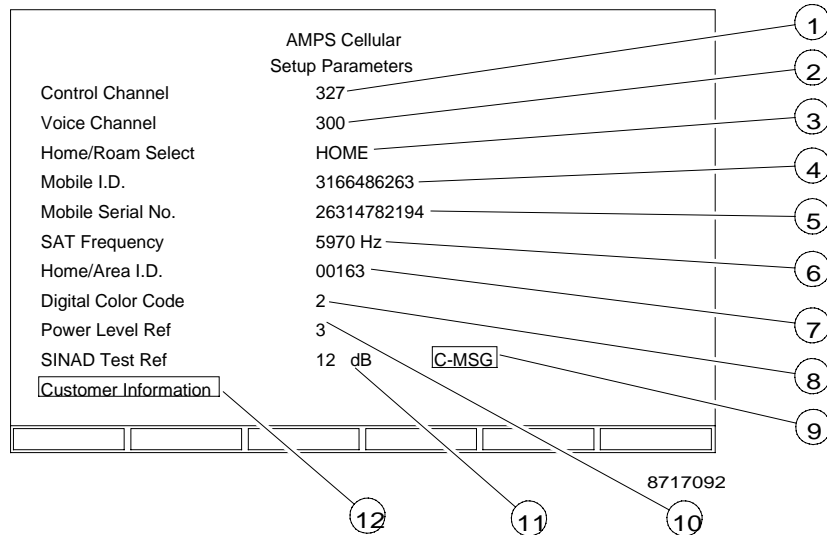

1. Control Channel

Selects simulated Control Channel. Range is 1 to 1023. Select using DATA ENTRY Keys. Press ENTER Key to complete edit.

2. Voice Channel

Selects simulated Voice Channel. Range is 1 to 1023. Select using DATA ENTRY Keys. Press ENTER Key to complete edit.

3. Home/Roam Select

Selects simulated Home or Roaming Registration. Selections are Home or Roam.

4. Mobile I.D.

Selects the Mobile Identification Number (MIN) used to identify Mobile Phone. Maximum length is 10 characters using A to D, 0 to 9, and # character. Select using DATA ENTRY Keys. Press ENTER Key to complete edit.

Performing Registration Test automatically enters MIN of Mobile Phone.

5. Mobile Serial No.

Selects Electronic Serial Number (ESN) used to identify Mobile Phone. Length is 11 digits. Select using DATA ENTRY Keys. Press ENTER Key to complete edit.

6. SAT Frequency

Selects SAT Frequency simulated. Selections include 5970, 6000 or 6030 Hz.

# SECTION 6

## OPTIONS

---

7. Home/Area I.D.

Selects System Identification Number (SID) used to test Home System Identification of Mobile Phone. Length is 5 digits. Select using DATA ENTRY Keys. Press ENTER Key to complete edit.

8. Digital Color Code

Selects Digital Color Code (DCC) simulated. Range is 0 to 3. Select using DATA ENTRY Keys. Press ENTER Key to complete edit.

9. Audio Test Filter

Displays Audio Filter setting for SINAD Test. Selections include C-MSG (C-Message Weighted Bandpass Filter) and 20 kHz Low-Pass Filter.

10. Power Level Ref

Mobile Phone Power Level used when Mobile Phone power readings are taken. Range is 0 to 7. Select using DATA ENTRY Keys. Press ENTER Key to complete edit.

11. SINAD Test Ref

Selects Pass/Fail SINAD Test Reference. Range is 3 to 40 dB. Select using DATA ENTRY Keys. Press ENTER Key to complete edit.

12. Customer Information

Displays Customer Information Menu. Edit Customer Information using DATA ENTRY Keys. Press ENTER Key to complete edit. Customer Information is printed out on Automatic Test Printout. Submenu Fields are as follows:

Customer Name	Customer I.D.
Manufacturer	Model
Serial Number	Type Approval
Certificate	

Pressing F1 "Page 2" displays Page 2 of the AMPS Setup Menu.



# SECTION 6

## OPTIONS

---

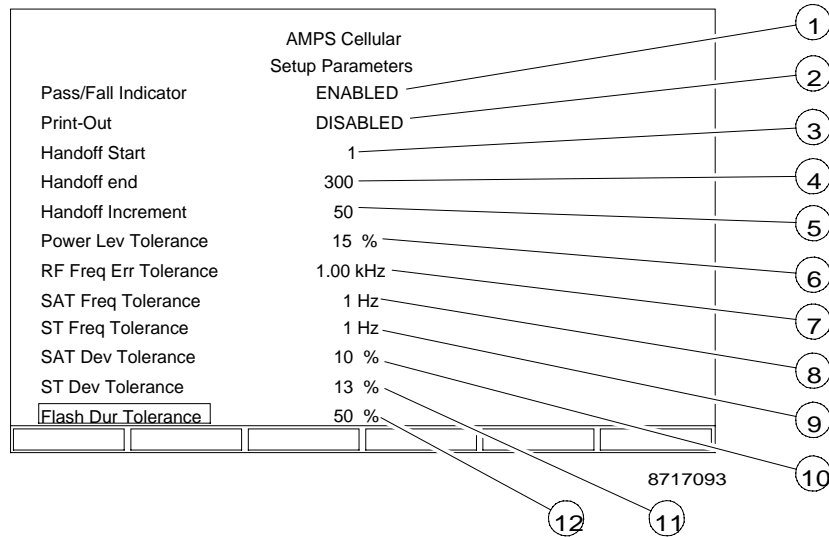

1. Pass/Fail Indicator

Displays status of Pass/Fail Indicator on Automatic Test Printout. Displays ENABLED or DISABLED.

2. Print-Out

Enables or disables print-out of Automatic Test Output. Requires printer connection to RS-232 Connector. Refer to Section 5 for configuring RS-232 Connector.

3. Handoff Start

First channel of Handoff Test sequence. Handoff Test starts with Handoff Start channel, increases by Handoff Increment (5), performing Handoff Test at each channel and ends with Handoff End (4) channel. Range is 1 to 1023. Select using DATA ENTRY Keys. Press ENTER Key to complete edit.

4. Handoff End

Last channel of Handoff Test sequence. Handoff Test starts with Handoff Start (3) channel, increments by the Handoff Increment (5) performing Handoff Test at each channel and ends with Handoff End channel. Range is 1 to 1023. Select using DATA ENTRY Keys. Press ENTER Key to complete edit.

5. Handoff Increment

Increment Number for Handoff Test. Handoff Test starts with Handoff Start (3) channel, increments by Handoff Increment, performing Handoff Test at each channel and ends with the Handoff End (4) channel. Range is 1 to 1023. Select using DATA ENTRY Keys. Press ENTER Key to complete edit.

---

# SECTION 6

## OPTIONS

---

### 6. Power Lev Tolerance

Selects tolerance used for Power Level Test. Consists of two editable fields: Positive Tolerance and Negative Tolerance. Range for both fields is from 0% to 99% or 0 to 99 dB. For each field, select using DATA ENTRY Keys. Press ENTER Key to complete edit.

### 7. RF Freq Err Tolerance

Selects tolerance for RF Frequency Error measurements. Range is 0.00 to 9.99 kHz. Select using DATA ENTRY Keys. Press ENTER Key to complete edit.

### 8. SAT Freq Tolerance

Selects tolerance for SAT Frequency measurements. Range is 0 to 99 Hz. Select using DATA ENTRY Keys. Press ENTER Key to complete edit.

### 9. ST Freq Tolerance

Selects tolerance for Signal Tone (ST) Frequency Test. Range is 0 to 999 Hz. Select using DATA ENTRY Keys. Press ENTER Key to complete edit.

### 10. SAT Dev Tolerance

Selects tolerance for SAT Deviation measurements. Range is 0% to 99%. Select using DATA ENTRY Keys. Press ENTER Key to complete edit.

### 11. ST Dev Tolerance

Selects the tolerance used to determine if the Signal Tone (ST) Deviation Test passes or fails. Range is from 0% to 99%. To set, move cursor to "11. ST Dev Tolerance" and press ENTER Key. Use DATA ENTRY Keypad (29) to enter a tolerance and press ENTER Key.

### 12. Flash Dur Tolerance

Selects the tolerance used to determine if the Flash Hook Duration Test passes or fails. Range is from 0% to 99%. To set, move cursor to "12. Flash Dur Tolerance" and press ENTER Key. Use DATA ENTRY Keypad (29) to enter a tolerance and press ENTER Key.

# SECTION 6

## OPTIONS

---

### 6-13-3 AMPS CELL SITE SIMULATOR AUTOMATIC TESTS

The AMPS Automatic Test Screen is accessed by selecting "1. Automatic Test" from the AMPS Cellular Menu.

Tests listed on the AMPS Automatic Test Screen are performed individually or in any combination *except* Mobile Init and Cell Init Tests must be performed if Handoff Test or Audio Test is desired.

Tests listed as ENABLED are performed. Tests listed as DISABLED are not performed. Each of the AMPS Automatic Test Screens are listed in the following paragraphs. The descriptions of the tests and results assume the mobile test was performed with all tests ENABLED.

AMPS Automatic Test Screen pretest softkeys are:

1. Disabled  
Sets test at current cursor location to DISABLED.
2. Enabled  
Sets test at current cursor location to ENABLED.
3. Start  
Starts tests that are ENABLED.
4. Return/Abort  
RETURN returns operation to AMPS Cellular Menu. ABORT stops current test and reports test as FAILED.

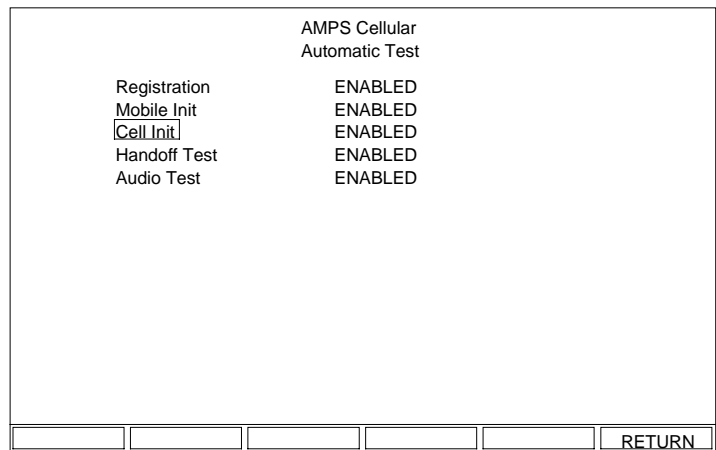

871712:

AMPS Automatic Test Screen post test softkeys are:

1. Reset  
Resets AMPS Automatic Test to initial conditions.
2. Results  
Pages through AMPS Automatic Test results.
3. Start  
Starts tests that are ENABLED.
4. Return  
Returns operation to AMPS Cellular Menu.

# SECTION 6

## OPTIONS

### 6-13-4 REGISTRATION TEST

The Registration Test sends a Registration order to the Mobile Phone. The registration parameters of the Mobile Phone tested and displayed.

To perform the Registration Test, verify the Registration Field is ENABLED. Registration Test results appear following test completion.



- 1. SCM  
Displays 4 least significant Station Class Mark bits.

- 2. Power Class  
Displays Power Class of Mobile Phone under test.

- 3. Transmission State

Displays Transmission State, Continuous or Discontinuous, of Mobile Phone under test.

- 4. Bandwidth

Displays bandwidth of Mobile Phone under test. 20 MHz allows channels 1 to 666. 25 MHz allows channels 1 to 1023.

- 5. DCC

Displays Digital Color Code last received by Mobile Phone under test.

- 6. ESN

Displays Electronic Serial Number of Mobile Phone under test in Hexadecimal, Decimal and Octal.

- 7. MIN

Displays Mobile Identification Number of Mobile Phone under test.

- 8. V Chan

Displays Voice Channel designated to Mobile Phone by Test Set.

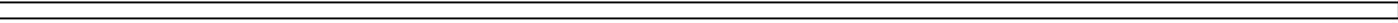
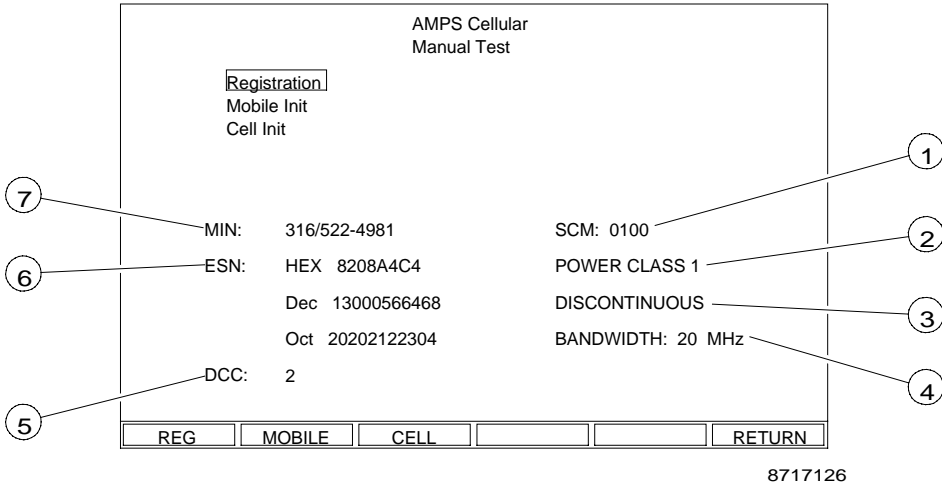

# SECTION 6

## OPTIONS

---

9. DTMF  
Displays DTMF digits transmitted after "ENTER DIGITS" prompt.
10. Flash Dur  
Displays Flash Hook signal time duration transmitted by Mobile Phone under test.
11. ST Freq  
Displays Signal Tone frequency transmitted by Mobile Phone under test.
12. Hangup Dev  
Displays deviation of hang up signal of Mobile Phone under test.
13. TX Pwr  
Displays Mobile Phone Output Power. Mobile Phone is set to Power Level Reference in AMPS Setup Menu.
14. SAT Dev  
Displays deviation of SAT transmitted by Mobile Phone under test.
15. Freq Err  
Displays error of Reverse Voice Channel Frequency received from Mobile Phone.
16. SAT Freq  
Displays SAT frequency transmitted by Mobile Phone under test.
17. Called Adr  
Displays phone number transmitted by Mobile Phone under test.  
The Power Level Test sends the VMAC values 0 to 7 to the Mobile Phone and the output power is measured.
18. Level  
Displays power levels of Mobile Phone.
19. Reading  
Displays power readings of Mobile Phone for each power level.

# SECTION 6 OPTIONS

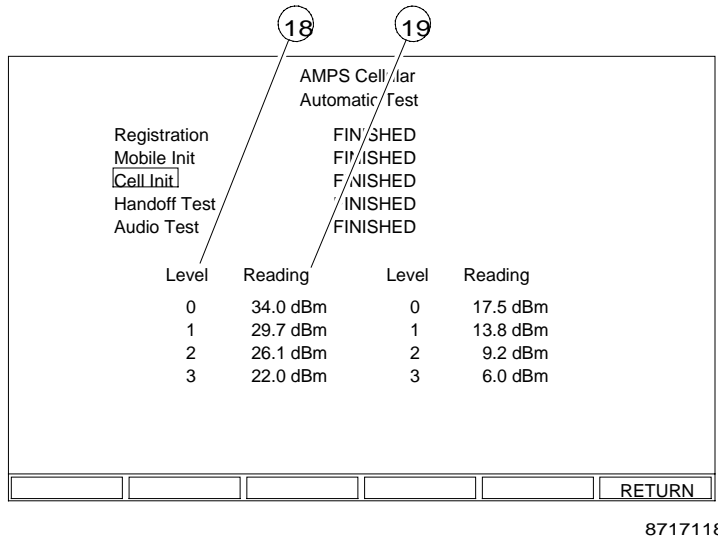
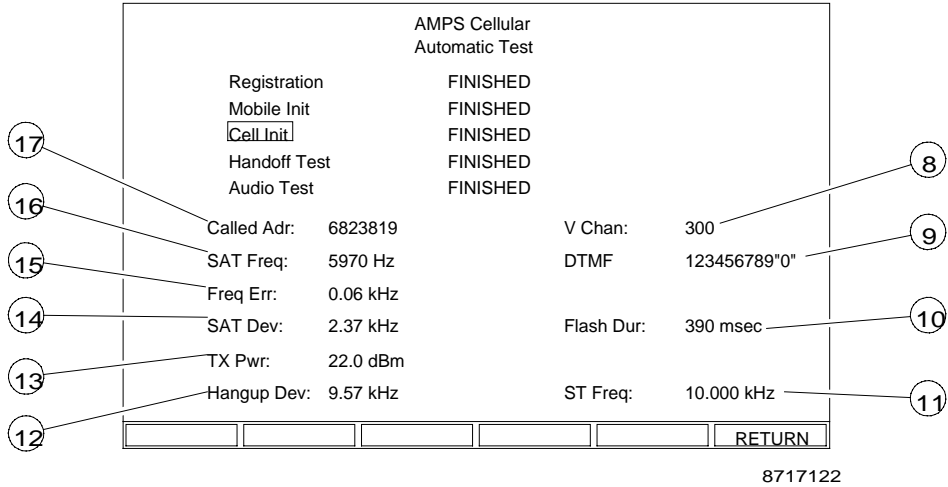

20. SAT Dev

Displays SAT Deviation received from Mobile Phone.

21. ST Freq

Displays Signal Tone (Hang Up) Frequency received from Mobile Phone.

22. Hangup Dev

Displays Signal Tone (Hang Up) Deviation received from Mobile Phone.

23. TX Pwr

Displays Mobile Phone Output Power. Mobile Phone is set to Power Level selected as Power Level Reference in AMPS Setup Menu.

24. SAT Freq

Displays SAT Frequency received from Mobile Phone.

# SECTION 6

## OPTIONS

---

25. RF Freq Err

Displays error of Reverse Voice Channel Frequency received from Mobile Phone.

26. Ring Dev

Displays Signal Tone Deviation received from Mobile Phone in response to Page order.

27. Voice Chan

Displays Voice Channel designated to Mobile Phone by Test Set.

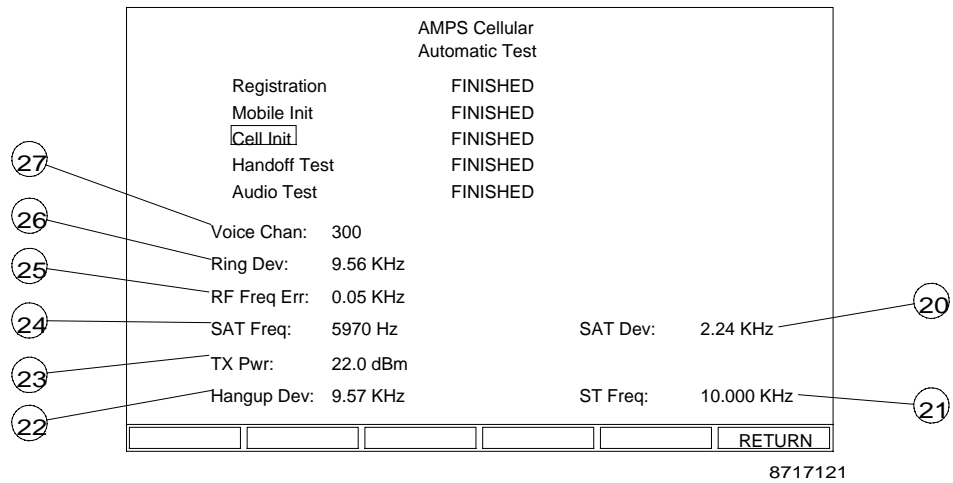

# SECTION 6

## OPTIONS

### 6-13-5 HANDOFF TEST

The Handoff Test performs a series of handoffs to different Channels. The first handoff is to the Handoff Start Channel. All other handoffs go to the next channel by adding the Handoff Increment to the current Channel until the Handoff End Channel receives a handoff.

To perform this test, press F2 ENABLED with cursor on Handoff Test.

Press F3 to start test. The Handoff Test cannot be selected unless the Mobile Init Test or the Cell Init Test is selected.



28. Chan

Displays Voice Channel which the handoff was made.

29. Pwr

Displays Mobile Phone Output Power. Mobile Phone is set to Power Level selected as Power Level Reference in AMPS Setup Menu.

Chan	Pwr	SAT	SAT Dev	Err
1	22.1 dBm	5970 Hz	2.27 KHz	0.05 KHz
51	22.1 dBm	5970 Hz	2.30 KHz	0.05 KHz
101	21.9 dBm	5970 Hz	2.28 KHz	0.05 KHz
151	22.0 dBm	5970 Hz	2.49 KHz	0.05 KHz
201	22.1 dBm	5970 Hz	2.28 KHz	0.05 KHz

					RETURN
--	--	--	--	--	--------

AMPS Cellular  
Automatic Test

Registration FINISHED  
 Mobile Init FINISHED  
 Cell Init FINISHED  
 Handoff Test FINISHED  
 Audio Test FINISHED

30. SAT

Displays SAT Frequency received from Mobile Phone.

31. SAT Dev

Displays SAT Deviation received from Mobile Phone.

32. Err

Displays RF Frequency Error of Reverse Voice Channel.



# SECTION 6

## OPTIONS

### 6-13-6 AUDIO TEST

The Audio Test measures Audio Distortion, Audio Power and RF Input Power required to maintain a SINAD Level. Connect the Phone Audio Out to the COM-120C AUDIO/DATA IN Connector. The SINAD Test Reference is set from the AMPS Setup Menu.

To test, press F2 ENABLED while cursor is on Audio Test. Press F3 START. Press FX SKIP to skip a test when prompted by Test Set. The Audio Test works when the Mobile Init Test or the Cell Init Test is also performed.



#### 33. RF Level

Displays RF Input Level, in dBm and volts, which produces SINAD reading equal to SINAD Test Reference.

#### 34. Audio Pwr

Displays Mobile Phone Audio Power.

#### 35. Audio Dist

Displays Mobile Phone Audio Distortion.

#### 36. REF LOAD

Displays Load Reference for Audio Test.

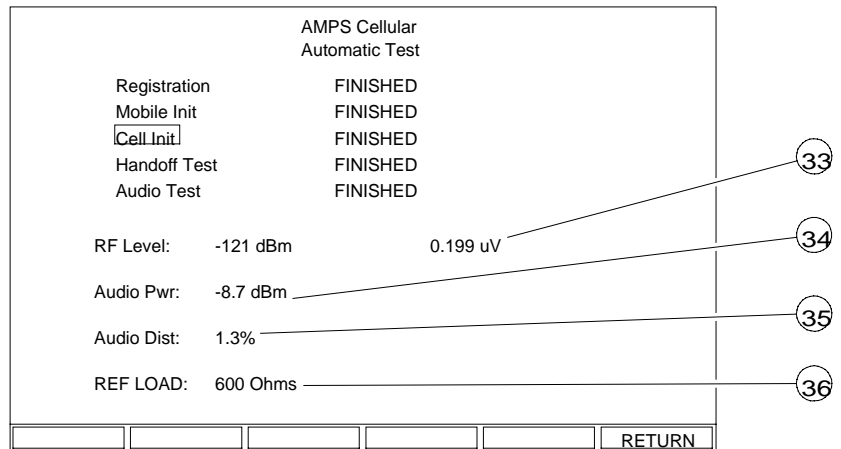

8717120

# SECTION 6

## OPTIONS

---

### 6-13-7 MOBILE INIT TEST

The Mobile Init (Initiated) Test requires a call to be initiated from the Mobile Phone. The following procedure performs the Mobile Init (Initiated) Test:

- 
- With cursor on Mobile Init, press F2 ENABLED=. Press F3 START to start test.
  - "Place Call" prompt appears. Place call using Mobile Phone under test.
  - "Enter Digits" prompt appears. Enter up to 16 digits using Mobile Phone to test DTMF transmission. Pressing F1 Cont continues Mobile Init Test with or without digits entered.
  - "Press Flash Hook" prompt appears. Send Flash Hook signal using Mobile Phone. Pressing F1 Cont continues Mobile Init Test without testing Flash Hook message.
  - "Measuring Frequency" message appears indicating Maintenance Order is sent to the Mobile Phone for measuring Signal Tone frequency.
  - "Press Flash Hook" prompt appears. Send Flash Hook signal using Mobile Phone. "Hangup Phone" prompt appears. Hang up Mobile Phone or press F5 Release for release order to be sent to Mobile Phone. When "Hangup Phone" prompt disappears, Mobile Init Test is finished.
  - Power Level Test is performed with the Mobile Init Test. After testing is finished, press F2 Results to page through results. Mobile Init Test results resemble the example.

# SECTION 6

## OPTIONS

---

### 6-13-8 CELL INIT TEST

The Cell Init (Cell Site Initiated) Test simulates a call from the Cell Site. The following procedure performs the Cell Init Test:



- With cursor on Cell Init, press F2 ENABLED. Press F3 START to start test.
- "Paging Mobile", "Page Answered" and "Ringing Mobile" messages appear as Test Set performs test.
- "Answer Phone" prompt appears. Answer call placed to Mobile Phone.
- "Measuring Frequency" message appears indicating Maintenance Order is sent to the Mobile Phone for measuring Signal Tone frequency.
- If Maintenance Order does not fail, "Press Flash Hook" prompt appears. Press Flash Hook on Mobile Phone. "Hangup Phone" prompt appears. Hanging up Mobile Phone completes Cell Init Test.

A Power Level Test is also performed with the Cell Init Test. Refer to paragraph 6-13-3B for Power Level Test information. After the Cell Init Test is finished, press F2. Results to page through the Cell Init Test results.

# SECTION 6

## OPTIONS

### 6-13-9 AUTOMATIC TEST PRINTOUT

If "2. Print-Out" is enabled on Page 2 of the AMPS Setup Menu, the performed test results are printed on a device connected to the RS-232 Connector.

A Printout for all Automatic Tests is shown here. Test readings are followed by P (Pass) or F (Fail) to indicate the test passed or failed.

```
*****
*****IFR COM-120C AMPS CELLULAR MOBILE AUTO TEST*****
DATE: FEB-24-1997
CUST: CUST ID: 5438
MANUFACTURER: IFR ENGINEERING
MODEL: TYPE 2 SERIAL #: 1234567890
TYPE APPROVAL: 0987654321 CERTIFICATE: 123ABC456DEF
*****
MOBILE ID NUMBER (MIN): 316/522-4981
ELECTRONIC SERIAL NUMBER (ESN): HEX: 820A4CA
DEC: 13000566468
OCT: 20202122304
MOBILE STATION CLASS: 0100
POWER: POWER CLASS I
TRANSMISSION: DISCONTINUOUS
BANDWIDTH: 20 MHZ
DIGITAL COLOR CODE: 3
HOME ID (SID): 00163 HOME
SAT: 5970 HZ
*****MOBILE INITIATED CALL*****
CALLED ADDRESS: 6955895452
VOICE CHANNEL: 300 FREQ FWD/FREQ RVS: 879.0000/834.0000
FREQ ERROR: 0.026 KHZ P
SAT FREQ: 5970 HZ P SAT DEV: 2.26 KHZ F
MOBILE TX POWER: 5.9 DBM P
DTMF RESPONSE: 123456789*0#
FLASH HOOK DURATION: 100 MS F
*****POWER LEVEL TEST*****
LEVEL READING
0 33.8 DBM P
1 29.4 DBM P
2 25.8 DBM P
3 21.8 DBM P
4 17.2 DBM P
5 13.5 DBM P
6 9.1 DBM P
7 5.9 DBM P
*****HAND-OFF TEST*****
VOICE RF SAT SAT RF FREQ
CHANNEL PWR FREQ DEVIATION ERROR
51 6.0 DBM 5970 HZ *2.24 KHZ 0.020 KHZ F
101 5.5 DBM 5970 HZ *2.22 KHZ 0.020 KHZ F
151 5.7 DBM 5970 HZ *2.24 KHZ 0.020 KHZ F
201 6.0 DBM 5970 HZ *2.23 KHZ 0.019 KHZ F
251 6.0 DBM 5970 HZ *2.24 KHZ 0.016 KHZ F
*****SINAD TEST AT REF 12 DB*****
RF LEVEL: -119 DBM 0.250 UV
AUDIO POWER: -54.0 DBM REF LOAD: 600 OHMS
AUDIO DISTORTION: 1.0 %
*****CELL INITIATED CALL*****
VOICE CHANNEL: 300
RING PLUS SAT DEVIATION: 9.48 KHZ P
RF FREQ ERROR: 0.006 KHZ P
SAT FREQ: 5970 HZ P
SAT DEV: 2.24 KHZ F
TX POWER: 5.7 dBm P
HANGUP (ST) PLUS SAT DEVIATION: 9.56 kHz P
ST FREQUENCY: 10.000 kHz P
```

# SECTION 6

## OPTIONS

---

### 6-13-10 AMPS CELL SITE SIMULATOR MANUAL TESTS

The AMPS Manual Test Screen is accessed by selecting "2. Manual Test" from the AMPS Cellular Menu.



1. Reg  
Initiates Manual Registration Test.
2. Mobile  
Initiates Manual Mobile Initiated Call Test.
3. Cell  
Initiates Manual Cell Site Initiated Call Test.
4. Return  
Returns Operation to AMPS Cellular Menu.

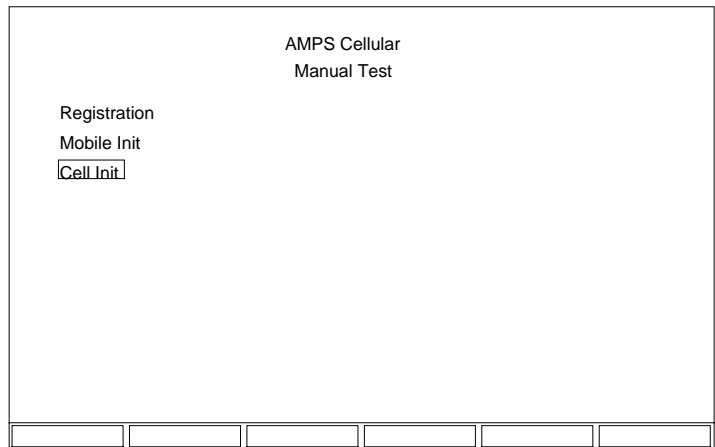

871709

# SECTION 6

## OPTIONS

### 6-13-11 REGISTRATION TEST

The Registration Test simulates a Registration order from the Cell Site and tests the Mobile Phone's response.

To perform the Registration Test, press F1 REG. After the Registration Tests are completed, results are displayed.



- 1. SCM  
Displays 4 least significant Station Class Mark bits.

- 2. Power Class  
Displays Power Class of Mobile Phone under test.

- 3. Transmission State

Displays Transmission State, Continuous or Discontinuous, of Mobile Phone under test.

- 4. Bandwidth

Displays bandwidth of Mobile Phone under test. 20 MHz allows channels 1 to 666. 25 MHz allows channels 1 to 1023.

- 5. DCC

Displays Digital Color Code last received by Mobile Phone under test.

- 6. ESN

Displays Electronic Serial Number of Mobile Phone under test in Hexadecimal, Decimal and Octal.

- 7. MIN

Displays Mobile Identification Number of Mobile Phone under test.

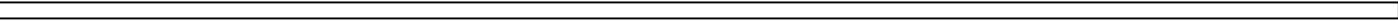
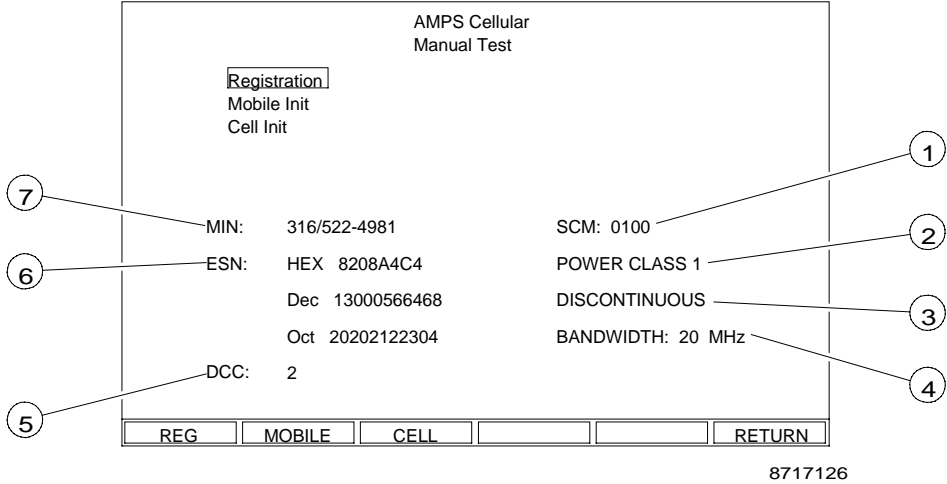

# SECTION 6

## OPTIONS

### 6-13-12 MOBILE INIT TEST

The Mobile Init (Initiated) Test requires a call to be initiated from the Mobile Phone. To perform the Mobile Init Test, press F2 MOBILE from AMPS Manual Test Menu. "Place Call" prompt appears.

Place call using Mobile Phone under test.

Once a connection is made, the Mobile Init Screen appears containing data.



8. Freq Err

Displays Reverse Voice Channel Frequency and Frequency Error received from Mobile Phone.

23

22

21

20

19

18

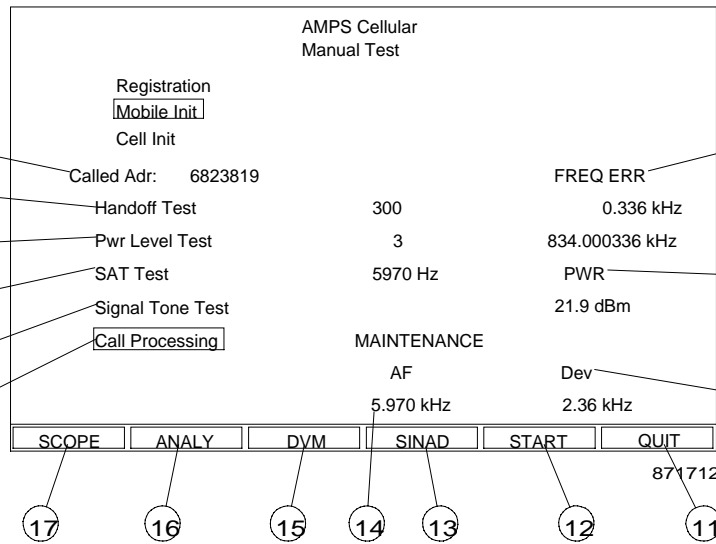

9. PWR

Displays output power received from Mobile Phone.

10. Dev

Displays the SAT Deviation or Audio Deviation received from the Mobile Phone.

11. Quit

Press F6 QUIT to exit Manual Mobile Init Screen.

12. Start

Initiates test at cursor location.

13. SINAD

Accesses SINAD Meter for use with Cellular Testing.

14. AF

Displays SAT Frequency received from the Mobile Phone.

15. DVM

Accesses SINAD Meter for use with Cellular Testing.

# SECTION 6

## OPTIONS

---

### 16. Analy

Accesses Spectrum Analyzer for use with Cellular Testing. Additional Field with Cellular Spectrum Analyzer is Return Cellular Field for returning to Manual Mobile Init Test Screen.

### 17. Scope

Accesses Oscilloscope for use with Cellular Testing. Additions for Cellular Oscilloscope include allowing Demod Audio for input Source and Return Cellular Field for returning to Manual Mobile Init Test Screen.

### 18. Call Processing

Prompt for accessing Call Processing Tests. Call Processing Tests include ALERT, SEND CALLED ADDRESS, DTMF TEST, AUDIT and MAINTENANCE. Selected test is started by pressing F5 START.

ALERT Test is provided to observe AF (14) and Dev (10). Press F5 START to initiate test. "Press Send to Clear" message is displayed. Observe AF (14) and Dev (10). Press Mobile Phone Send Key to terminate test.

SEND CALLED ADDRESS Test requires Mobile Phone to have placed phone call. Place call on Mobile Phone. Press F5 START.

DTMF TEST allows testing of Mobile Phone DTMF Transmission. Press F5 START to initiate test. Window is displayed to enter DTMF Digits. Press keys on Mobile Phone and verify echo appears in Window. Press F5 CLR WND to terminate test.

AUDIT Test exercises Audit Function of Mobile Phone. Press F5 START to initiate test. Once Audit Test is complete, "Confirmation: Audit" Window is displayed.

MAINTENANCE Test is provided to observe AF (14) and Dev (10). Press F5 START to initiate test. "Press Send to Clear" message is displayed. Observe AF (14) and Dev (10). Press Mobile Phone Send Key to terminate test.

### 19. Signal Tone Test

Signal Tone Test measures Signal Tone Frequency. Press F5 START to initiate test. "Measuring Frequency" message appears indicating Maintenance Order is sent to the Mobile Phone for measuring Signal Tone frequency. Once test is complete, "Press Flash Hook" message is displayed. Press Flash Hook on Mobile Phone. "Flash Hook Detected" message is displayed. Press F5 CLR WND to terminate test.

### 20. SAT Test

SAT Test allows change of SAT Frequency. To change SAT Frequency, press ENTER Key with cursor on SAT Test. Use DATA SCROLL Keys to select new SAT Frequency. Press ENTER Key. Verify AF (14) displays selected SAT Frequency.



# SECTION 6

## OPTIONS

---

21. Power Level Test

Each time a power level is entered, a VMAC message is sent to change the power level of the Mobile Phone to the level entered. To enter a power level, use DATA ENTRY Keys to enter a power level and press ENTER Key.

22. Handoff Test

Handoff Test hands off Mobile Phone to another Cellular Channel. With cursor on Handoff Test, use DATA ENTRY Keys to select new Channel. Press ENTER Key. Verify FREQ ERR (8) changes to match new Channel.

23. Called Adr

Displays the address called by the Mobile Phone.

# SECTION 6

## OPTIONS

### 6-13-13 CELL INIT TEST

The Cell Init (Initiated) Test places a call to the Mobile Phone. To perform the Cell Init Test, press F3 CELL from AMPS Manual Test Menu. "Paging Mobile", "Page Answered" and "Answer Phone" messages appear in order.

Once "Answer Phone" message appears, answer Mobile Phone. Once a connection is made, the Cell Init Screen appears containing data:

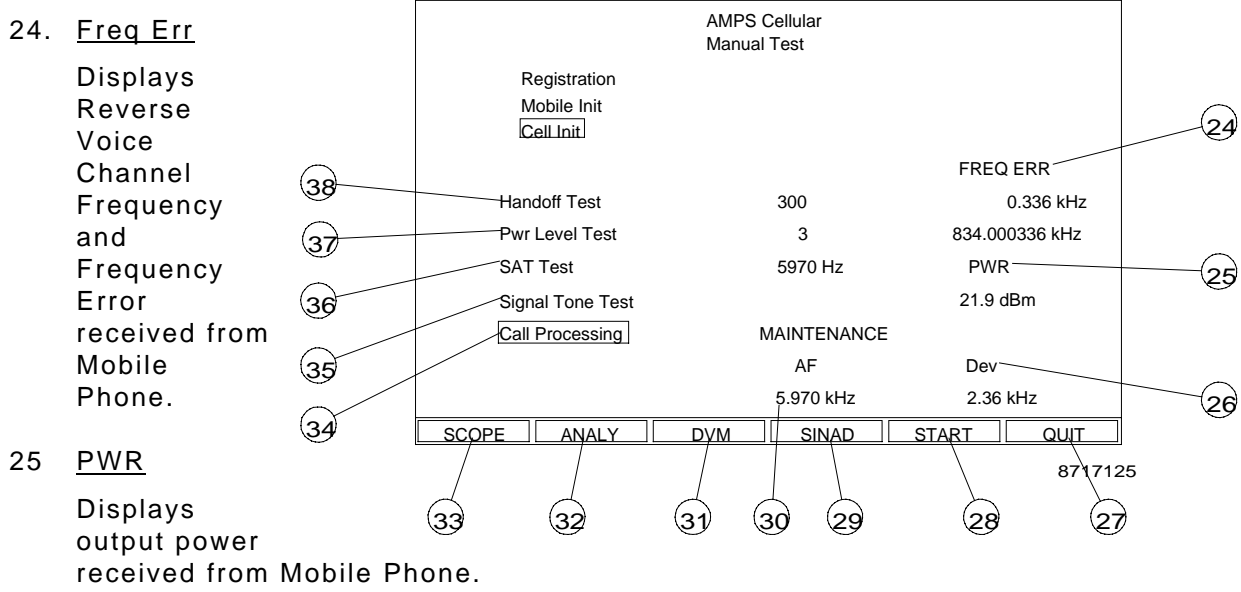

24. Freq Err  
 Displays Reverse Voice Channel Frequency and Frequency Error received from Mobile Phone.

25. PWR  
 Displays output power received from Mobile Phone.

26. Dev  
 Displays the SAT Deviation or Audio Deviation received from the Mobile Phone.

27. Quit  
 Press F6 QUIT to exit Manual Cell Init Screen.

28. Start  
 Initiates test at cursor location.

29. SINAD  
 Accesses SINAD Meter for use with Cellular Testing.

30. AF  
 Displays the SAT Frequency received from the Mobile Phone.

31. DVM  
 Accesses SINAD Meter for use with Cellular Testing.

# SECTION 6

## OPTIONS

---

### 32. Analy

Accesses Spectrum Analyzer for use with Cellular Testing. Additional Field with Cellular Spectrum Analyzer is Return Cellular Field for returning to Manual Mobile Init Test Screen.

### 33. Scope

Accesses Oscilloscope for use with Cellular Testing. Additions for Cellular Oscilloscope is allowing Demod Audio for input Source and Return Cellular Field for returning to Manual Mobile Init Test Screen.

### 34. Call Processing

Prompt for accessing Call Processing Tests. Call Processing Tests include ALERT, SEND CALLED ADDRESS, DTMF TEST, AUDIT and MAINTENANCE. Selected test is started by pressing F5 START.

ALERT Test is provided to observe AF (14) and Dev (10). Press F5 START to initiate test. "Press Send to Clear" message is displayed. Observe AF (14) and Dev (10). Press Mobile Phone Send Key to terminate test.

SEND CALLED ADDRESS Test requires Mobile Phone to have placed phone call. Place call on Mobile Phone. Press F5 START.

DTMF TEST allows testing of Mobile Phone DTMF Transmission. Press F5 START to initiate test. Window is displayed to enter DTMF Digits. Press keys on Mobile Phone and verify echo appears in Window. Press F5 CLR WND to terminate test.

AUDIT Test exercises Audit Function of Mobile Phone. Press F5 START to initiate test. Once Audit Test is complete, "Confirmation: Audit" Window is displayed.

MAINTENANCE Test is provided to observe AF (14) and Dev (10). Press F5 START to initiate test. "Press Send to Clear" message is displayed. Observe AF (14) and Dev (10). Press Mobile Phone Send Key to terminate test.

### 35. Signal Tone Test

Signal Tone Test measures Signal Tone Frequency. Press F5 START to initiate test. "Measuring Frequency" message appears indicating Maintenance Order is sent to the Mobile Phone for measuring Signal Tone frequency. Once test is complete, "Press Flash Hook" message is displayed. Press Flash Hook on Mobile Phone. "Flash Hook Detected" message is displayed. Press F5 CLR WND to terminate test.

### 36. SAT Test

SAT Test allows change of SAT Frequency. To change SAT Frequency, press ENTER Key with cursor on SAT Test. Use DATA SCROLL Keys to select new SAT Frequency. Press ENTER Key. Verify AF (14) displays selected SAT Frequency.

# SECTION 6

## OPTIONS

---

### 37. Power Level Test

Each time a power level is entered, a VMAC message is sent to change the power level of the Mobile Phone to the level entered. To enter a power level, use DATA ENTRY Keys to enter a power level and press ENTER Key.

### 38. Handoff Test

Handoff Test hands off Mobile Phone to another Cellular Channel. With cursor on Handoff Test, use DATA ENTRY Keys to select new Channel. Press ENTER Key. Verify FREQ ERR (8) changes to match new Channel.

# SECTION 6

## OPTIONS

---

### 6-14 EDACS TRUNKING (OPTION 16)

The EDACS Trunking Option is used to test radios and repeaters of the EDACS trunked-radio signaling type. EDACS Trunked Radio System is a product of GE/Ericsson. The COM-120C EDACS Option runs in manual and automatic modes for radio and repeater testing.

To execute EDACS Trunking Option, the selection is made from the Special Test screen. Press the SPCL Mode Key on the front panel for this selection screen:

Press F4 EDACS or cursor to selection "4. EDACS Trunking" and press the ENTER Hard Key to access the EDACS Trunking screen.



1. Auto  
Accesses the Automatic Test screen.
2. Manual  
Accesses the Manual Test screen.
3. Setup  
Accesses the Setup Screen.
4. Return  
Returns to Specials Screen.

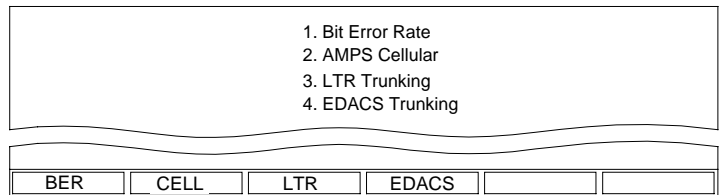

0061601

# SECTION 6

## OPTIONS

### 6-14-1 EDACS TRUNKING SETUP SCREEN

EDACS Trunking Setup Screen.



1. Control Chan

This field is used to select a logical channel for use as a control channel. The actual RF Frequencies display to the right of the channel number, in relationship to a mobile radio. The logical channels (1-20) are programmed under the CHANNEL ASSIGNMENTS Menu selection. The control channel set here is used as the control channel for establishing connections (call processing) with the radio in the Automatic Test (Radio) and the Manual Test (Repeater Simulator).

EDACS Trunking Setup Parameters			
		Mobile Rx	Mobile Tx
CONTROL CHAN	1	856.2125	811.2125
WORKING CHAN	2	857.2125	812.2125
SITE ID	1		
SYSTEM BAND	NARROW (900 MHz)		
CHANNEL ASSIGNMENTS			

0061601

WIDE NARROW [ ] [ ] [ ] RETURN

2. Working Chan

This field is used to select a logical channel for use as a working channel. The actual RF Frequencies display to the right of the channel number, in relationship to a mobile radio. The logical channels (1-20) are programmed under the CHANNEL ASSIGNMENTS Menu selection. The working channel set here is used as the working channel for the Automatic Test (Radio) and as the Gen/Rec Frequencies for the Automatic Test (Repeater).

3. Site ID

This field is used to select the Site ID to use in the overhead messages in the Automatic Test and the Manual Test (Repeater Simulator). The value range is 0 to 31.

4. System Band

This field is used to set the EDACS Trunking System Band to Wide (800 MHz) or Narrow (900 MHz).

5. Channel Assignments

This field is used to program the 20 logical channels for the EDACS Trunking tests. These programmed frequencies are used for all channels referenced in the Automatic and Manual Tests.

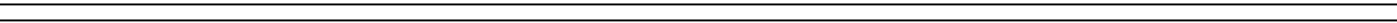

# SECTION 6

## OPTIONS

### 6-14-2 EDACS TRUNKING CHANNEL ASSIGNMENTS

This field is used to program the 20 logical channels for the EDACS Trunking tests. These programmed frequencies are used for all channels referenced in the Automatic and Manual Tests.

There are a total of 20 logical channels available for programming. Two pages of 10 per page. Each logical channel is capable of being an (FCC) 800 MHz or 900 MHz Standard Channel No. or a user defined RF Frequency pair ranging from 0 to 1000.0000 MHz.

There is no correlation between the logical channel number and an FCC number. The logical channel numbers are programmed to work with the system under test's channel numbers. The ability to assign an FCC Standard Channel No. to a logical channel is only for ease of programming.

Setting a channel format to 800 or 900 MHz *does not* set the system band to wide or narrow. Set wide or narrow with the 'SYSTEM BAND' field in the EDACS Trunking Setup Parameters screen.



#### 1. Format

Designates the format used.

800 MHz Selects FCC 800 MHz format. If 800 MHz is the current format when an edit is started, (ENTER pressed), the value under the No. column is edited to set the Rx/Tx Frequencies to an FCC standard channel (1-760).

900 MHz Selects FCC 900 MHz format. If 900 MHz is the current format when an edit is started, (ENTER pressed), the value under the No. column is edited to set the Rx/Tx Frequencies to an FCC standard channel (1-760).

EDACS Trunking Setup Parameters					Mobile Tx
EDACS CHANNEL ASSIGNMENTS					811.2125
C	Chan.	Format	No.	Mobile Rx	812.2125
W	1	800 MHz	100	853.4875	
S	2	800 MHz	33	851.8125	
S	3	900 MHz	201	937.5125	
C	4	User		465.8125	425.8125
	5	800 MHz	5	851.1125	806.1125
	6	800 MHz	6	851.1375	806.1375
	7	800 MHz	7	851.1625	806.1625
	8	User		432.8125	412.8125
	9	800 MHz	9	851.2125	806.2125
	10	800 MHz	10	851.2375	806.2375

800 MHz | 900 MHz | USER | PG UP | PG DN | RETURN

0060724:

#### 2. Mobile Rx

Manually enter the Mobile Receiver frequency. If the Format field is not set to USER, it is forced to user and the No. Field is set to null.

EDACS Trunking Automatic Test	
Registration	DISABLED
Radio Test	ENABLED
Repeater Test	DISABLED
Audio Test	ENABLED

DISABLED | ENABLED | START | FMZ | RETURN

0061601

#### 3. Mobile Tx

Manually enter the Mobile Transmitter frequency. If the Format field is not set to USER, it is forced to user and the No. Field is set to null.

### 6-14-3 EDACS TRUNKING AUTOMATIC TEST

EDACS Trunking Automatic Test Screen consists of 4 main parts. Registration, Radio Test, Repeater Test and Audio Test. Each Test is either ENABLED or DISABLED. This state of the Automatic Test is referred to as the 'Idle' state. All Automatic Tests are run with the UUT connected to the T/R port for both transmit and receive operations.



1. Registration

If ENABLED, Registration is the first test executed for the Automatic Test which simply captures a login message from the radio and displays the Radio's Group and Logical ID's along with the Control/Working channel frequencies.

2. Radio Test

If ENABLED, Radio Test executes and completes a Group Call sequence with a radio and measures the Radio's Transmitter Frequency Error, Transmitter RF Power, High-Speed Data Deviation, Subaudible Data Deviation and Voice Peak Deviation.

3. Repeater Test

If ENABLED, the Repeater Test measures the Repeater's Transmitter Frequency Error and Transmitter RF Power.



# SECTION 6

## OPTIONS

---

### 6-14-4 EDACS TRUNKING AUTOMATIC TEST EXECUTION

Press F3 START to execute the Automatic Test. At least one of these tests must be ENABLED: Registration, Radio Test or Repeater Test. If one or more of these tests is not ENABLED, the screen displays, "INVALID SELECTS" and the test does not execute. The Audio Test only applies to the Radio Simulator and Repeater Simulator.



#### A. REGISTRATION

When ENABLED, Registration executes first. The field status changes from ENABLED to RUNNING. The Control Channel programmed from the Setup screen is used for the RF Frequencies and the COM-120C begins generating Site ID messages (overhead). The screen prompts to, "Turn on Power to Radio."

The COM-120C then looks for the login message (data) from the Radio. The Radio must be programmed to do automatic login. When the login message is found, the COM-120C acknowledges the login back to the Radio and captures the Radio's Group and Logical ID which displays along with the Control/Working channel frequencies used. The field status changes to COMPLETE when the test is finished and proceeds to the next ENABLED part of the Automatic Test.

#### B. RADIO TEST

If ENABLED, Radio Test executes next. The field status changes from ENABLED to RUNNING. The Control Channel programmed from the Setup screen is used for the RF Frequencies and the COM-120C begins generating Site ID messages (overhead). The Radio locks onto the COM-120C. If the Push-to-Talk cable is properly connected, the Radio performs a hands-free PTT (Group Call). If not, the screen prompts to manually press the PTT button, "Press PTT now (Group Call)".

The Radio should connect with the COM-120C at this point. If a successful Group Call was achieved, the Control/Working channels and the Radio's Group/Logical ID's are displayed and the test measurements begin with the message: "Taking Measurements..."

The PTT button must remain depressed during the measurements (if doing manual PTT). If not, the Radio Test terminates and the field status changes to DROPPED. The message, "CALL DROP" is briefly displayed.

When the Voice Peak Deviation Test begins, the screen prompts to whistle (or blow) into microphone and updates the deviation accordingly. The PTT button must remain depressed during Voice Peak Deviation measurement.

If Audio Tests are planned, skip this test. The Radio's microphone is disabled if Audio Connectors are in place.

If the CONT or SKIP softkey is pressed, the Radio test finishes and the field status changes to COMPLETE.

Results of the test are shown and the screen prompts to release the PTT button.

If the Radio has the Push-to-Talk cable connected, the PTT is automatically released.

# SECTION 6

## OPTIONS

---

If the Audio Test is ENABLED, it is performed next on the Radio. The field status changes to RUNNING and the screen prompts to, "Install Audio Connectors. Press CONT when ready". It is extremely important that audio connections to the Radio are installed correctly. Press F4 CONT to continue the test.

The COM-120C establishes a Group Call identical to the Group Call used in the Radio Test.

If the PTT cable is properly connected, the Radio is instructed to automatically engage the PTT button. Otherwise, manually depress the PTT button.

Once the Radio is connected via Group Call, the screen displays the message: "Taking Measurements...". The PTT button must remain depressed (if manually doing PTT) during measurements or the Audio Test terminates. The field status indicates DROPPED. The message, "CALL DROP" is briefly displayed.

After the Transmitter Audio Tests are complete, the COM-120C prompts to release PTT (if manual PTT) and calls the Radio to do Receiver Audio Tests. When the call to the Radio is complete, the screen prompts to, "Set Radio Volume to Maximum. Press CONT when ready". Check the Radio for a busy ('BSY') light indicator and/or a Group Call (GR) light indicator with the caller's Logical ID which indicates a successful call to the Radio. If the call is not successful, ABORT the test.

If the F4 CONT is pressed, the screen displays the message: "Taking Measurements". The field status changes to COMPLETE when the test is finished and goes to the next ENABLED part in the Automatic Test.

### C. REPEATER TEST

If ENABLED, Repeater Test executes next. The field status changes from ENABLED to RUNNING. The Working Channel programmed from the Setup screen is used for the RF Frequencies. The Repeater Test is a conventional-mode test.

Manually control the Repeater Transmitter/Receiver as instructed by the COM-120C. When the test begins, the screen prompts, "Turn on Repeater transmitter now". The screen displays the message: "Taking Measurements.." when the transmitter is on,.

The Repeater Transmitter must remain on during measurements. If not, the test terminates and the field status indicates DROPPED. The message, "REPEATER DROP" is briefly displayed.

If the Audio Test is ENABLED, it is performed next on the Repeater. The field status changes to RUNNING and the screen prompts to, "Install Audio Connectors. Press CONT when ready".

It is extremely important that audio connections to the Repeater are installed correctly.

Press F4 CONT to continue the test. If the Repeater's Transmitter is not on, the screen prompts for it to be turned on. Once the Repeater is transmitting, the screen displays the message: "Taking Measurements...".

The Repeater Transmitter must remain on during measurements. If not, the test terminates and the field status indicates DROPPED. The message, "REPEATER DROP" is briefly displayed. The field status changes to COMPLETE after the test.

# SECTION 6

## OPTIONS

---

### 6-14-5 EDACS TRUNKING AUTOMATIC TEST RESULTS

After Automatic Testing is complete, use the softkeys to display or print the results.

Press F2 to show the first page of results. Results appear in the lower half of the EDACS Trunking Automatic Test screen.

The following text describes the test results and their significance in order of appearance on the screen.

If only Registration was ENABLED, only the first three rows of results are shown.



*Results: Radio Test*

**CONTROL CHANNEL**  
Shows the Mobile Radio's Receive/ Generate RF Frequencies used for the test as the EDACS Control Channel.

	[Radio]	
	Mobile Rx	Mobile Tx
CONTROL CHANNEL	856.2125	811.2125
WORKING CHANNEL	857.2125	812.2125
LOGICAL/GROUP ID	1002/100	
TX FREQ ERROR:	-0.199 kHz	
TX RF POWER:	827.4 mW	
TX DATA DEV:	3.20 kHz	
SUB-AUDIBLE DEV:	0.68 kHz	
VOICE AUDIO DEV:	4.14 kHz	

**WORKING CHANNEL**  
Shows the Mobile Radio's Receive/ Generate RF Frequencies used for the test as the EDACS Working Channel.

0061600

**LOGICAL/GROUP ID**  
Shows the Mobile Radio's Logical ID and Group ID which was acquired from the Group Call (or Login message if Registration only) performed during the Radio Test.

**TX FREQ ERROR**  
Shows the RF Frequency Error of the radio transmitter kHz.

**TX RF POWER**  
Shows the RF Power of the radio transmitter in mW (if less than 1 Watt) or Watts.

**TX DATA DEV**  
Shows the Deviation of the Radio's high-speed data in kHz.

**SUB-AUDIBLE DEV**  
Shows the Deviation of the Radio sub-audible data during transmission of a Group Call in kHz.

**VOICE AUDIO DEV**  
Shows the Peak Deviation of transmitted microphone audio from the Radio in kHz.

# SECTION 6

## OPTIONS

These are all the test results available for the Audio Test-Radio except for the Tx Audio Response results. Some of these results are based on the Rated Output of the radio. This is acquired by injecting a 1 kHz sine wave via the Data Gen output jack and raising the level until 3 kHz (1.5 kHz for narrow band) of deviation is transmitted by the radio.

.....

### Results: Audio Test (Radio)

#### TX DEVIATION @ 15 mVrms

This result is the deviation reading (in kHz) of the Radio transmitter modulating a 1 kHz sine wave injected into the Radio's audio-in path from the COM-120C Data Gen output baseband jack at 15 mVrms level.

	[Radio]
TX DEVIATION @ 15 m Vrms:	3.73 kHz
TX MOD LIMITING @ 300 Hz:	4.15 kHz      110m Vp
TX MOD LIMITING @ 3 kHz:	2.89 kHz      110m Vp
TX MOD LIMITING (Burst):	3.68 kHz      110m Vp
TX AUDIO DISTORTION:	2.8%
RX AUDIO SESITIVITY:	878.4m Vp_p    0.30 Vrms
RX SINAD @ 12dB:	-121.8 dBm

0061600

Does not include any deviation from the Radio's sub-audible data.

#### TX MODULATION LIMITING @ 300 Hz

This result is the deviation reading (in kHz) of the Radio transmitter modulation with a 300 Hz sine wave injected into the Radio's audio-in path from the COM-120C Data Gen output baseband jack at a level which is 20 dB higher than 60% of the Radio's Rated Output. The result in the right column is the actual level in mVp which was used to make the deviation measurement.

#### TX MODULATION LIMITING @ 3 kHz

This result is the deviation reading (in kHz) of the Radio transmitter modulation with a 3 kHz sine wave injected into the Radio's audio-in path from the COM-120C Data Gen output baseband jack at a level which is 20 dB higher than 60% of the Radio's Rated Output. The result in the right column is the actual level in mVp which was used to make the deviation measurement.

#### TX MODULATION LIMITING (Burst)

This result is the peak deviation reading (in kHz) of the Radio transmitter modulation with a burst of 1 kHz sine wave injected into the Radio's audio-in path from the COM-120C Data Gen output baseband jack at a level which is 20 dB higher than 60% of the Radio's Rated Output. The result in the right column is the actual level in mVp which was used to make the deviation measurement.

#### TX AUDIO DISTORTION

This result is the Distortion measurement in % of the Radio's transmitter with a 1 kHz sine wave injected into the Radio's audio-in path from the COM-120C Data Gen output baseband jack at the level of the Radio's Rated Output. The Radio's sub-audible data is not included in this measurement.

# SECTION 6

## OPTIONS

---

### RX AUDIO SENSITIVITY

This result is the AF Level read back from the Radio's audio output path with a 1 kHz sine wave FM-generated at 3 kHz (1.5 kHz for narrow band) deviation, -50.0 dBm level, from the COM-120C to the Radio's antenna input (Radio must have receiver unsquelched). The AF Level voltage is then measured using wideband (no) filtering from the Audio/Data/SINAD Input baseband jack. The radio must be set at full volume to make this measurement. The result is the AF Level voltage shown in Vrms and mV peak to peak.

### RX SINAD @ 12 dB

This result is the SINAD reading from the Radio's audio output path with a 1 kHz sine wave FM-generated at 3 kHz (1.5 kHz for narrow band) deviation from the COM-120C to the Radio's antenna input (Radio must have receiver unsquelched). The COM-120C Generator RF Level starts at -105.0 dBm and lowered until a SINAD reading of 12 dB is acquired. Then the RF Level is recorded as the result of the test in dBm.

If the Radio squelches because of sub-audible drop out before the 12 dB SINAD is reached, the last good reading taken before the Radio squelched is recorded and shown along with the RF Level at that reading.

### Results: Audio Test (Radio Tx Audio Response)

### TX AUDIO RESPONSE

This shows the results of the measured deviation from the Radio's transmitter with a series of tone frequencies (sine wave) injected into the Radio's audio input path from the COM-120C Data Gen output

baseband jack at 20% of the Radio's **Rated Output**. Measurements do not include the Radio's sub-audible data deviation.

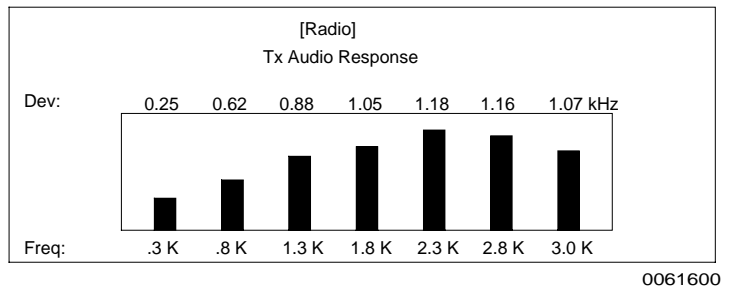

The series of tone frequencies used are: 300 Hz, 800 Hz, 1300 Hz, 1800 Hz, 2300 Hz, 2800 Hz and 3000 Hz.

The following text describes the test results and their significance in order of appearance on the screen.

If only Registration was ENABLED, only the first three rows of results are shown.

# SECTION 6

## OPTIONS

### Results: Repeater Test

#### WORKING CHANNEL

Shows the Repeater's Receive/Generate RF Frequencies used for the test.

	[Reptr]	
	Repeater Rx	Repeater Tx
WORKING CHANNEL	857.2125	812.2125
TX FREQ ERROR:	-0.199 kHz	
TX RF POWER:	827.4 mW	

0061600

#### TX FREQ ERROR

Shows the RF Frequency Error of the Repeater transmitter in kHz.

#### TX RF POWER

Shows the RF Power of the Repeater transmitter in mW (if less than 1 Watt) or Watts.

### Results: Audio Test (Repeater)

These are all the test results available for the Audio Test-Repeater except for the Tx Audio Response results. Some of these results are based on the Rated Output of the Repeater. This is acquired by injecting a 1 kHz sine wave via the Data Gen output jack and raising the level until 3 kHz (1.5 kHz for narrow band) of deviation is transmitted by the Repeater.

	[Reptr]	
TX DEVIATION @ 15 m Vrms:	0.73 kHz	
TX MOD LIMITING @ 300 Hz:	4.15 kHz	110m Vp
TX MOD LIMITING @ 3 kHz:	2.89 kHz	110m Vp
TX MOD LIMITING (Burst):	3.68 kHz	110m Vp
TX AUDIO DISTORTION:	1.8%	
RX AUDIO SESITIVITY:	878.4m Vp_p	0.30 Vrms
RX SINAD @ 12dB:	-121.8 dBm	

0061600

#### TX DEVIATION @ 15 mVrms

This result is the deviation reading (in kHz) of the Repeater transmitter modulating a 1 kHz sine wave injected into the Repeater's audio-in path from the COM-120C Data Gen output baseband jack at 15 mVrms level.

#### TX MODULATION LIMITING @ 300 Hz

This result is the deviation reading (in kHz) of the Repeater transmitter modulation with a 300 Hz sine wave injected into the Repeater's audio-in path from the COM-120C Data Gen output baseband jack at a level which is 20 dB higher than 60% of the Repeater's Rated Output. The result in the right column is the actual level in mVp which was used to make the deviation measurement.

#### TX MODULATION LIMITING @ 3 kHz

This result is the deviation reading (in kHz) of the Repeater transmitter modulation with a 3 kHz sine wave injected into the Repeater's audio-in path from the COM-120C Data Gen output baseband jack at a level which is 20 dB higher than 60% of the Repeater's Rated Output. The result in the right column is the actual level in mVp which was used to make the deviation measurement.

# SECTION 6

## OPTIONS

---

### TX MODULATION LIMITING (Burst)

This result is the peak deviation reading (in kHz) of the Repeater transmitter modulation with a burst of 1 kHz sine wave injected into the Repeater's audio-in path from the COM-120C Data Gen output baseband jack at a level which is 20 dB higher than 60% of the Repeater's Rated Output. The result in the right column is the actual level in mVp which was used to make the deviation measurement.

### TX AUDIO DISTORTION

This result is the Distortion measurement in % of the Repeater's transmitter with a 1 kHz sine wave injected into the Repeater's audio-in path from the COM-120C Data Gen output baseband jack at the level of the Repeater's Rated Output.

### RX AUDIO SENSITIVITY

This result is the AF Level read back from the Repeater's audio output path with a 1 kHz sine wave FM-generated at 3 kHz (1.5 kHz for narrow band) deviation, -50.0 dBm level, from the COM-120C to the Repeater's RF input (Repeater must have receiver unscelched). The AF Level voltage is then measured using wideband (no) filtering from the Audio/Data/SINAD Input baseband jack. The result is the AF Level voltage shown in Vrms and mV peak to peak.

### RX SINAD @ 12 dB

This result is the SINAD reading from the Repeater's audio output path with a 1 kHz sine wave FM-generated at 3 kHz (1.5 kHz for narrow band) deviation from the COM-120C to the Repeater RF input (Repeater must have receiver unscelched). The COM-120C Generator RF Level starts at -105.0 dBm and lowered until a SINAD reading of 12 dB is acquired. Then the RF Level is recorded as the result of the test in dBm.

*Results: Audio Test (Repeater Tx Audio Response)*

### TX AUDIO RESPONSE

This shows the results of the measured deviation from the Repeater's transmitter with a series of tone frequencies (sine wave) injected into the Repeater's audio input path from the COM-120C Data Gen output baseband jack at 20% of the Repeater's **Rated Output**.

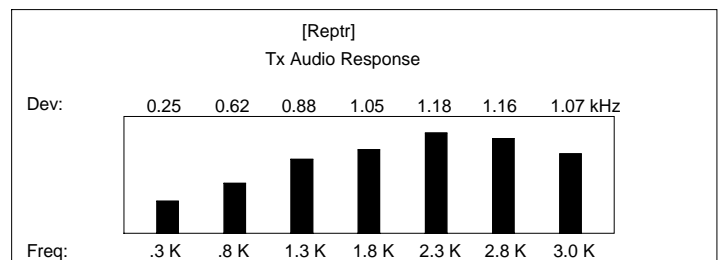

0061600

The measurements do not include the Radio's sub-audible data deviation. The series of tone frequencies used are: 300 Hz, 800 Hz, 1300 Hz, 1800 Hz, 2300 Hz, 2800 Hz and 3000 Hz.

# SECTION 6

## OPTIONS

### Automatic Test Results (Printout)

Printouts of the Automatic Tests are acquired by pressing F4 PRINT after an automatic test has completed. Results are printed out the serial (RS-232) port on the COM-120C rear panel. The RS-232 line settings are set in the COM-120C Setup Screen, selection 5. Here is an example of a printout.

```
*****IFR COM-120C EDACS AUTOMATIC TEST RESULTS*****
DATE: Apr-6-1997                                     TIME: 16:07:34
```

```
*****RADIO TEST*****
```

	MOBILE RX	MOBILE TX
CONTROL CHANNEL:	856.2125	811.2125
WORKING CHANNEL:	857.2125	812.2125
RADIO LOGICAL ID:	1002	
RADIO GROUP ID:	100	
TX FREQ ERROR:	-0.199 kHz	
TX RF POWER:	827.4 mW	
TX DATA DEV:	3.24 kHz	
SUB-AUDIBLE DEV:	0.68 kHz	
VOICE AUDIO DEV:	4.14 kHz	

[AUDIO TEST]

TX DEVIATION @ 15 mVrms:	4.02 kHz	
TX MOD LIMITING @ 300 Hz:	4.15 kHz	110 mVp input
TX MOD LIMITING @ 3 kHz:	4.45 kHz	110 mVp input
TX MOD LIMITING @ (BURST):	4.22 kHz	110 mVp input
TX AUDIO DISTORTION:	2.2%	
TX AUDIO RESPONSE @ 300 Hz:	0.25 kHz	
TX AUDIO RESPONSE @ 800 Hz:	0.85 kHz	
TX AUDIO RESPONSE @ 1300 Hz:	1.25 kHz	
TX AUDIO RESPONSE @ 1800 Hz:	1.35 kHz	
TX AUDIO RESPONSE @ 2300 Hz:	1.55 kHz	
TX AUDIO RESPONSE @ 2800 Hz:	1.55 kHz	
TX AUDIO RESPONSE @ 3000 Hz:	1.35 kHz	
RX AUDIO SENSITIVITY:	1003. mVp-p	0.30 Vrms
RX SINAD @ 12 dB:	-118.8 dBm	15.5 dB

```
*****REPEATER TEST*****
```

	REPTR RX	REPTR TX
WORKING CHANNEL:	857.2125	812.2125
TX FREQ ERROR:	-0.199 kHz	
TX RF POWER:	827.4 mW	

[AUDIO TEST]

TX DEVIATION @ 15 mVrms:	4.02 kHz	
TX MOD LIMITING @ 300 Hz:	4.15 kHz	110 mVp input
TX MOD LIMITING @ 3 kHz:	4.45 kHz	110 mVp input
TX MOD LIMITING @ (BURST):	4.22 kHz	110 mVp input
TX AUDIO DISTORTION:	2.2%	
TX AUDIO RESPONSE @ 300 Hz:	0.25 kHz	
TX AUDIO RESPONSE @ 800 Hz:	0.85 kHz	
TX AUDIO RESPONSE @ 1300 Hz:	1.25 kHz	
TX AUDIO RESPONSE @ 1800 Hz:	1.35 kHz	
TX AUDIO RESPONSE @ 2300 Hz:	1.55 kHz	
TX AUDIO RESPONSE @ 2800 Hz:	1.55 kHz	
TX AUDIO RESPONSE @ 3000 Hz:	1.35 kHz	
RX AUDIO SENSITIVITY:	1003. mVp-p	0.30 Vrms
RX SINAD @ 12 dB:	-118.8 dBm	15.5 dB



# SECTION 6

## OPTIONS

---

### 6-14-6 EDACS TRUNKING MANUAL TEST

The EDACS Trunking Manual Test consists of 2 main parts.

A Repeater Simulator for testing EDACS Radios and a Radio Simulator for testing EDACS Repeaters.



1. Rept Sim

Accesses the EDACS Repeater Simulator Screen.

2. Radio Sim

Accesses the EDACS Radio Simulator Screen.

3. Return

Returns to the EDACS Trunking Test screen.

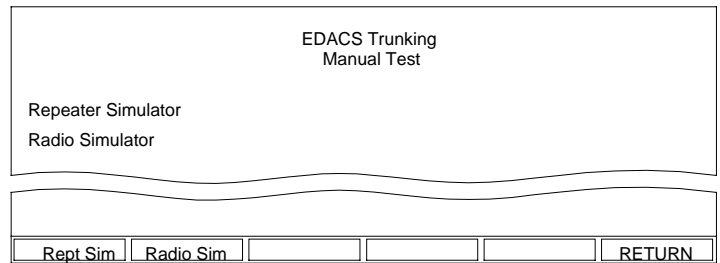

0061602

# SECTION 6

## OPTIONS

### 6-14-7 EDACS TRUNKING MANUAL TEST-REPEATER SIMULATOR

Entering the Repeater Simulator causes the COM-120C to perform an FM-Zero operation to adjust the Receiver's DC offset to zero. The screen displays the message: "Doing FMZ...please wait".

While in the Repeater Simulator and the Radio is not transmitting, or the repeater is not calling the Radio, the Site ID message is continuously transmitting. In this idle mode, the Repeater Simulator is looking for a Call (or Login) request from the Radio. When the request is found, the Repeater Simulator allows the Radio to transmit (until the Radio releases). The Group/Logical ID's are captured (and displayed) when the Group Call is made (and used to call a Radio). A Radio's Login is also decoded by the simulator and the ID's captured. There is also a mode of operation (activated by softkey) where the repeater simulates a Radio calling the Radio Under Test. In this mode, there are softkeys to disconnect and return back to the idle state.



1. CH#:

This field is used to change the EDACS Repeater Simulator Working Channel, as specified by the Channel Number pre-programmed in the Setup Screen. Value range: 1 to 20. The corresponding RF Frequencies are shown in the RF fields as the CH# field is edited. This only sets the Working Channel. The Control Channel is taken from the Setup Screen and must be changed there if necessary.

EDACS REPEATER SIMULATOR			
CH #:	Band:	Extended Meas:	
RECEIVE		GENERATE	
RF: 812.2125 MHz	Atten: 0 dB	RF: 857.2125 MHz	Level: -40.0 dBm
Input: T/R		Output: T/R	
Group ID 273 Logical ID 1 Call Type: SYSTEM ALL		Status: IDLE Message:	
RF Power: 837.8 mW		DATA	
RF Error Freq: 0.210 kHz		Mod Source: DATA FM	
Deviation: 0.78 kHz (D)		Deviation: 3.2 kHz:	
AF Frequency: 300 Hz		Subaud dev: 0.70 kHz	
Distortion: 2.3 %		Sinad:	
CALL	DISC	PRGM	RETURN

0061601

If the Band field is set to 'Manual' there is no channel number to edit. The PRGM Soft Function Key F3 may then be used to return to the channel Band mode.

2. Band:

This field shows the channel format for the Repeater Simulator Working Channel. Valid values are: 800 MHz, 900 MHz, USER or Manual. Display-only field. If 'Manual' is displayed, the RF Frequencies have been set manually in the Repeater Simulator. All other values are taken from the pre-programmed logical channels from the Setup Screen, according to the channel number set in the CH# field.

# SECTION 6

## OPTIONS

---

3. RF: (Receive)

This field shows the current RF Frequency of the EDACS Working Channel for the Receiver side of the Repeater Simulator. This field is editable (which puts the Working Channel in 'Manual' mode). Value range: 0 to 1000.0000 MHz.

4. Atten:

This field is used to set the Receiver Attenuation. Value range: 0 or 30 dB.

5. Input:

This field is used to select the Receiver's RF Input for the Repeater Simulator to the T/R or Antenna connector. Valid values are T/R or ANT.

6. Group ID:

This field shows the Radio's Group ID acquired from a Group Call or Login operation (if performed). This field is also used for the Group ID when making a call to the Radio Under Test. This field is editable. Value range: 0 to 2047.

7. Call Type:

This field handles outgoing call processing selections Group, Individual or System-All calls, for Radio and Repeater-initiated calls.

8. Logical ID:

This field shows the Radio's Logical ID acquired from a Group Call or Login operation (if performed). This field is also used for the Logical ID when making a call to the Radio Under Test. This field is editable. Value range: 0 to 16383.

9. RF Power:

This field shows the Radio's Transmitter RF Power in Watts (or mW). It is a display-only field (meter) with no cursor position. Value range: 0.0 mW to 10.00 W.

10. RF Error Freq:

This field shows the Radio's Transmitter RF Frequency Error in kHz. It is a display-only field (meter) with no cursor position. Value range:  $\pm 0.000$  to 5.000 kHz.

11. Deviation: (Receive)

This field shows the Radio's Transmit Deviation for Voice or Data in kHz. Voice Deviation is designated with a 'V' symbol, and Data Deviation (low-frequency data) is designated with a 'D' symbol. Value range: 0.00 to 10.00 kHz.

12. AF Frequency:

This field shows the Radio's Transmitter Audio Frequency in Hz. It is a display-only field (meter) with no cursor position. Measuring range: 300 to 4500 Hz.

# SECTION 6

## OPTIONS

---

### 13. Distortion: (Receive)

This field shows the Radio's Transmitter Distortion in %. Value range: 0.0 to 20.0%. Also used to show decoded DTMF digits by pressing the DTMF softkey.

### 14. Extended Meas:

This field allows access to one of three external screens: Scope, Analyzer or Digital Voltmeter (DVM). Radio-initiated Group Calls are still performed while in any of the three screens. If a call was made to the Radio and is still in progress, it is possible to access any of the three screens without interrupting the call.

*However, there is no way to call the Radio Under Test or disconnect a made call while in the extended screens. The call must be made before entering an extended screen.*

The *only* way to enter the extended screens is to use the softkeys. The 'Return' field in the extended screen allows a return to the Repeater Simulator.

### 15. RF: (Generate)

This field shows the current RF Frequency of the EDACS Working Channel for the Generator side of the Repeater Simulator. This field is editable (which puts the Working Channel in 'Manual' mode). Value range: 0 to 1000.0000 MHz.

Soft Function Keys available with this function include:

### 16. Level:

This field is used to set the Generator's RF Output Level in dBm. Value range: -40 to -130.0 dBm (T/R), 13.0 to -130.0 dBm (AUX) with AUX option.

### 17. Output:

This field is used to set the Generator's RF Output source to the T/R port or the Auxiliary (AUX) RF port. Valid values: T/R or AUX.

### 18. Status:

This field shows the current status of the Repeater Simulator. It is a display-only field. Valid status values:

#### IDLE

Repeater is in the idle state, generating overhead (Site ID) messages. In this state, the Radio may initiate a Group Call, do a Login or the simulator may initiate another call to another radio.

#### RADIO SETUP

Repeater is in the process of processing a Call from the Radio. *This message is usually very brief and may not be noticeable.*

#### RADIO INIT

Repeater successfully completes a Call from the Radio and call is in progress.

#### REP INIT

Repeater made a Group Call to the Radio.

# SECTION 6

## OPTIONS

---

19. Message:

Briefly shows the last EDACS message received from the Radio. Display-only field.

GROUP CALL

A Group Call message is received from the Radio.

UN-KEYED

An un-keyed message is received from the Radio.

EMER GROUP

An Emergency Group Call message is received from the Radio.

LOGIN

A Login message is received from the Radio.

STATUS

A Status message is received from the Radio.

INDV CALL (*Log ID*)

An Individual Call is received from the radio. The Logical ID of the radio being called is shown in parenthesis.

SYSTEM ALL

A System-All Call is received from the radio.

20. Mod Source:

This field is used to select a Generator source for modulation. GEN1, GEN2 and DTMF are only modulated when a call is made to the Radio. The DATA modulation field is used to modulate the EDACS signaling data. All enabled modulation sources display above the Mod Source field.

In the field to the right of Mod Source, select the modulation type for the selected source.

21. Deviation: (Generate)

This field is active when the selected source is FM or PM modulation type. This controls the deviation of the modulated source. Value range: 0.00 to 100.0 kHz for FM and 0.00 to 10.0 Rad for PM. *For deviation of DATA, 3.2 kHz (1.5 kHz for narrow band) is the recommended default value.*

22. Modulation:

This field is active when the selected source is AM modulation type. This controls the modulation of the selected source. Value range: 0.0% to 100.0%.

23. Frequency:

This field is active when the selected source, GEN1 or GEN2, is modulated. This selects the Audio Frequency of the selected Function Generator source (sine wave). Value range: 0.0 Hz to 20000.0 Hz.

# SECTION 6

## OPTIONS

---

24. Subaud dev:

This field is active when the selected source, DATA, is modulated. This controls the deviation of the sub-audible data used during established call processing with the EDACS Radio. Value range: 0.00 to 100.0 kHz. *Should be  $\leq$  Deviation (20). The recommended default value is 0.70 kHz (0.35 kHz for narrow band).*

25. Code:

This field is active when the selected source, DTMF, is modulated. This allows the entry of desired DTMF digits to use for DTMF source generation.

26. Sinad:

This field is used to select a meter to read signals from the Audio/Data/SINAD input baseband jack. The measurements appear to the right of this field. Valid selections:



*When baseband measurements are made, all receiver measurements including the DSP data decoding are disabled due to hardware limitations. Therefore, an EDACS Radio-initiated call cannot be made with any baseband measurements enabled. The Radio-initiated call must be made first, then the baseband measurements may be enabled during the call. Calling the Radio may be done at any time.*

# SECTION 6

## OPTIONS

### 6-14-8 EDACS TRUNKING MANUAL TEST-RADIO SIMULATOR

Entering the Repeater Simulator causes the COM-120C to perform an FM-Zero operation to adjust the Receiver's DC offset to zero. The screen displays the message: "Doing FMZ...please wait."

While in the Radio Simulator the Control Channel is continually monitored looking for SITE-ID from the controller. If not found, the NC status is shown. When a SITE-ID message is found, the status goes to IDLE.

This allows Group Calls to be made (Push-to-Talk) or calls to be made to the COM-120C from another Radio as dictated by the Repeater. There are 3 main call-processing sequences supported in the Radio Simulator. Perform a Group Call, receive a call in response to a Channel Assignment message from a Repeater and receive a call in response to a Channel Update message from a Repeater (if coming on-line during a call).

Several error conditions can occur during the Radio Simulation. Error messages display briefly under these conditions.



#### LOST CHANNEL

The Radio has lost contact with the Repeater during a Group Call.

#### CHAN OUT OF RANGE

A channel assignment from the Repeater was out of pre-programmed Channel range.

#### INVALID ID

An ID other than what was set in the Logical/Group ID fields was used to call the Radio Simulator.

#### NO UN-MUTE FOUND

The Repeater has transmitted the channel assignment to the Radio Simulator for calling the simulator, but did not send the Un-mute message on the Working Channel.

#### NO CHAN ASSGN FOUND

The Channel Assignment message was not received from the Repeater when a Group Call (PTT) was executed from the Radio Simulator.

EDACS RADIO SIMULATOR					
CH #:	2	Band:	USER	Extended Meas:	
RECEIVE			GENERATE		
RF:	812.2125	MHz	RF:	857.2125	MHz
Atten:	0	dB	Level:	-40.0	dBm
Input:	T/R		Output:	T/R	
Group ID	273		Status:	NC	
Logical ID	1		Message:		
RF Power:	837.8	mW	DATA		
RF Error Freq:	0.210	kHz	Mod Source:	DATA	FM
Deviation:	0.78	kHz (D)	Deviation:	3.2	kHz:
AF Frequency:	300	Hz	Subaud dev:	0.70	kHz
Distortion:	2.3	%	Sinad:		
CALL	DISC	PRGM			RETURN

0061601

# SECTION 6

## OPTIONS

---

1. CH#:

This field is used to change the EDACS Control Channel Number (pre-programmed in the Setup Screen). Value range: 1 to 20. The corresponding RF Frequencies are shown in the RF fields as the CH# field is edited.

If the Band field is set to 'Manual', there is no channel number to edit. The PRGM Soft Function Key F3 may then be used to return to the channel Band mode.

2. Band:

This field shows the channel format for the Radio Simulator Control Channel. Valid values are: 800 MHz, 900 MHz, USER or Manual. Display-only field. If 'Manual' is displayed, the RF Frequencies have been set manually in the Radio Simulator. All other values are taken from the pre-programmed logical channels from the Setup Screen, according to the channel number set in the CH# field.

3. RF: (Receive)

This field shows the current RF Frequency of the EDACS Control Channel for the Receiver side of the Radio Simulator. This field is editable (which puts the Control Channel in 'Manual' mode). Value range: 0 to 1000.0000 MHz.

4. Atten:

This field is used to set the Receiver Attenuation. Value range: 0 or 30 dB.

5. Input:

This field is used to select the Receiver's RF Input for the Radio Simulator to the T/R or the Antenna port. Valid values are T/R or ANT.

6. Group ID:

This field is used to select Radio Simulator's Group ID that is used when simulating a Group Call (PTT) to another Radio. This field is editable. Value range: 0 to 2047.

7. Logical ID:

This field is used to select Radio Simulator's Logical ID that is used when simulating a Group Call (PTT) to another Radio. This field is editable. Value range: 0 to 16383.

8. RF Power:

This field shows the Repeater's Transmitter RF Power in Watts (or mW). A display-only field (meter). Value range: 0.0 mW to 10.00 W.

9. RF Error Freq:

This field shows the Repeater's Transmitter RF Frequency Error in kHz. A display-only field (meter). Value range:  $\pm 0.000$  to 5.000 kHz.



# SECTION 6

## OPTIONS

---

10. Deviation: (Receive)

This field shows the Repeater's Transmit Deviation for Voice or Data in kHz. A 'V' symbol means Voice Deviation. A 'D' symbol means Data Deviation (low-frequency data). Value range: 0.00 to 100.0 kHz.

11. AF Frequency:

This field shows the Repeater's Transmitter Audio Frequency in Hz. It is a display-only field (meter) with no cursor position. Measuring range: 300 to 4500 Hz.

12. Distortion: (Receive)

This field shows the Repeater's Transmitter Distortion in %. Value range: 0.0 to 20.0%. Also used to show decoded DTMF digits by pressing the DTMF softkey.

13. Extended Meas:

This field allows access to one of three external screens: Scope, Analyzer or Digital Voltmeter (DVM). If a Group Call (PTT) was made to another Radio and is still in progress, it is possible to access any of the three screens without interrupting the call. The *only* way to enter the extended screens is to use the softkeys. The 'Return' field in the extended screen allows a return to the Repeater Simulator.

14. RF: (Generate)

This field shows the current RF Frequency of the EDACS Control Channel for the Generator side of the Radio Simulator. This field is editable (which puts the Control Channel in 'Manual' mode). Value range: 0 to 1000.0000 MHz.

15. Level:

This field is used to set the Generator's RF Output Level in dBm. Value range: -40 to -130.0 dBm (T/R), 13.0 to -130.0 dBm (AUX) with AUX option.

16. Output:

This field is used to set the Generator's RF Output source to the T/R port or the Auxiliary (AUX) RF port. Valid values: T/R or AUX.

# SECTION 6

## OPTIONS

---

### 17. Status

This field shows the current status of the Radio Simulator. Display-only field.  
Valid status values:

#### NC

No Control Channel overhead found from the Repeater. No calls accepted in this state.

#### IDLE

Radio is locked into a Repeater Site and is waiting to make a Group Call or accept a Group Call.

#### BEGIN CALL

A Group Call is initiated and call processing with the Repeater is in progress. This message is usually brief.

#### GROUP CALL

Radio Simulator successfully executed a Group Call and is transmitting/receiving on the Working Channel assigned by the Repeater Under Test. The Working Channel is displayed in parenthesis.

#### CALLED

A call is made to the Radio Simulator and is transmitting/receiving on the Working Channel assigned by the Repeater Under Test. The words "EMG" is displayed if an Emergency Group Call was made.

### 18. Message:

Briefly shows the last EDACS message received from the Repeater. Display-only field.

#### GRP CHAN ASSGN

A Group Call Channel Assignment message is received from the Repeater.

#### CH UPDATE

A Channel Update message is received from the Repeater.

#### CALL DROP

A Call Drop message is received from the Repeater.

### 19. Mod Source:

This field is used to select a Generator source for modulation. Sources are only modulated when a call (PTT) is initiated from the Radio Simulator. The DATA modulation field is to modulate the EDACS signaling data. All enabled modulation sources display above the Mod Source field.

To the right of Mod Source, select the modulation type for the selected source.

### 20. Deviation: (Generate)

This field is active when the selected source is FM or PM modulation type. This controls the deviation of the modulated source. Value range: 0.00 to 100.0 kHz for FM and 0.00 to 10.0 Rad for PM. *For deviation of DATA, 3.2 kHz (1.5 kHz for narrow band) is the recommended default value.*

# SECTION 6

## OPTIONS

---

21. Modulation:

This field is active when the selected source is AM modulation type. This controls the modulation of the selected source. Value range: 0.0% to 100.0%.

22. Frequency:

This field is active when the selected source, GEN1 or GEN2, is modulated. This selects the Audio Frequency of the selected Function Generator source (sine wave). Value range: 0.0 Hz to 20000.0 Hz.

23. Subaud dev:

This field is active when the selected source, DATA, is modulated. This controls the deviation of the sub-audible data used during an established call initiated from the Radio Simulator. Value range: 0.00 to 100.0 kHz. *Should be  $\leq$  Deviation (20). The recommended default value is 0.70 kHz (0.35 kHz for narrow band).*

24. Code:

This field is active when the selected source, DTMF, is modulated. This allows the entry of desired DTMF digits to use for DTMF source generation.

25. Sinad:

This field is used to select a meter to read signals from the Audio/Data/SINAD input baseband jack. The measurements appear to the right of this field. Valid selections:



*When baseband measurements are made, all receiver measurements including the DSP data decoding are disabled due to hardware limitations. Therefore an EDACS Call Processing cannot be made with any baseband measurements enabled. The Call Processing must be made first, then the baseband measurements may be enabled during the call.*

# SECTION 6

## OPTIONS

### 6-14-9 EDACS HIGH-SPEED DATA CAPTURE (SCOPE)

Access the EDACS Repeater or Radio Simulator Extended Measure Scope.

Set H Pos negative to view the dotting or barker code before the data. Cursor to Trig Type field. "DATA" acts like 1-SHOT mode

and triggers when High-Speed EDACS data is decoded. Press DATA to re-arm trigger.

*Set the EDACS Trunking Scope trigger level high or low enough to avoid causing a trigger before the EDACS Data Burst occurs.*



1. Trigger  
Displays trigger level set high.
2. Trigger  
Displays trigger level set low.
3. Cplg (Coupling)  
Selects type of coupling preferred.

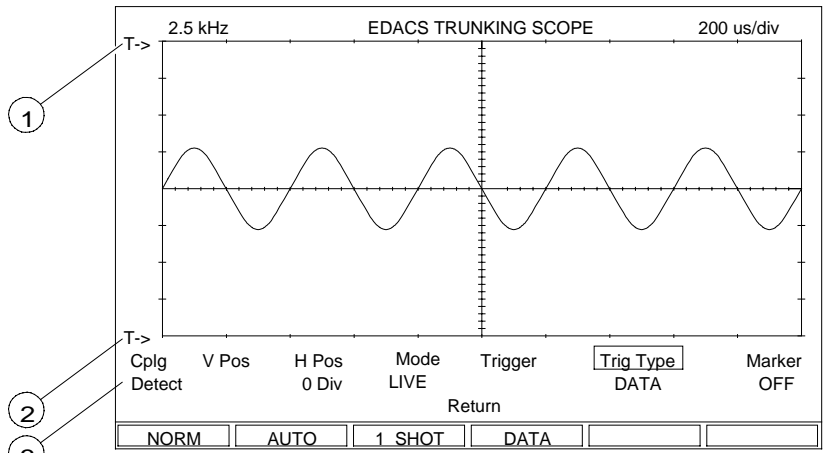

0060712

# SECTION 6

## OPTIONS

---

### 6-14-10 EDACS STORE AND RECALL

The COM-120C provides the ability to store and recall EDACS system configurations. Data is stored to one of 50 standard stored test setups under the *Type* EDACS. Press the STORE Hard Key in any EDACS Option screen for this menu window:



1. Setup #

Displays selected Memory Location for storage of current configuration.

2. Name

Displays optional alphanumeric label for selected Memory Location.

3. Type

Displays the type of data currently saved in the specified setup number. Available types to save and recall are: DUPLEX, GENERATOR, RECEIVER, GENERATOR & RECEIVER and EDACS.



Press the RECALL Hard Key in any EDACS option screen for this menu window:

1. Setup #

Displays selected Memory Location for storage of current configuration.

2. Name

Displays optional alphanumeric label for selected Memory Location.

3. Type

Displays the type of data currently saved in the specified setup number. Available types to save and recall are: DUPLEX, GENERATOR, RECEIVER, GENERATOR & RECEIVER and EDACS.



# SECTION 6

## OPTIONS

---

### 6-14-11 EDACS TRUNKING OPERATIONAL NOTES

This section provides some notes and hints on operating the EDACS Trunking Option of the COM-120C.

#### **Squelch Setting**

The squelch knob setting on the COM-120C unit is very important for all testing.

While in the EDACS Trunking Main Screen with no RF being transmitted into the COM-120C unit, turn the squelch knob full counterclockwise. The green squelch light is ON. Slowly turn the knob clockwise until the green light just goes off (make sure there is no flickering). This setting is valid for all EDACS testing.

#### **Control/Working Channels**

If a radio is having trouble locking onto the Repeater Simulator, completing calls or the Radio Simulator is showing NC, check the programming of the Control and/or Working Channels in the Setup menu. These channels must be valid for the particular system under test.

If the radio is having trouble locking onto the Repeater simulator, check the CH #: field. This must be set to a valid working channel number, it is NOT the Control Channel number.

#### **Data Generation**

If the radio won't lock onto the Repeater Simulator, won't stay up when being called or the Radio Simulator is having trouble completing calls, check the DATA Mod Source. The DATA Mod Source must be set for FM Modulation. The recommended deviation is 3.2 kHz (1.5 kHz for narrow band) with a sub-audible deviation of 0.70 kHz (0.35 kHz for narrow band).

#### **Logical/Group ID**

If a radio can not be called in the Repeater Simulator or can not make a call in the Radio Simulator, check the Group/Logical ID. The Group ID must valid for the system under test.

#### **FM-Zero**

If a radio is having trouble completing a Group Call (maybe works 50% of the time), an FM-Zero (FMZ) operation may be necessary. Do this in the Automatic Test using F4 FMZ while in the idle state, or FMZ in any manual mode simulator by cursoring to the Deviation field in the left column and pressing F3 FMZ.

# SECTION 6

## OPTIONS

---

### 6-15 MPT 1327 TRUNKING (OPTION 17)

The MPT 1327 Trunking Option allows protocol and parametric testing of radio units and trunking system controllers (repeaters) designed for operation on MPT 1327 trunked private land mobile radio systems.

MPT 1327 is an open signaling standard, originally specified by the United Kingdom Ministry of Post and Telecommunications (now under the auspices of the Department of Trade and Industry Radiocommunications Agency), and adopted for use world-wide.

The MPT 1327 Trunking Option 17 provides facilities for both automatic and manual testing of radio units, repeater testing, off-air monitoring and network data configuration/storage.

To access the MPT 1327 Trunking Option, press SPCL Test Mode Key and select the option from the Special Menu. If the MPT 1327 Trunking Main screen is not displayed, press SETUP Hard Key. Select Version information to verify the option is installed.



#### AUTOMATIC TEST MODE

An Automatic Test facility is provided where a Radio Unit (RU) is subjected to a series of predefined tests with minimum intervention.

#### REPEATER SIMULATOR

The COM-120C is configured to simulate a trunked single site repeater to manual test radio units.

#### RADIO UNIT SIMULATOR

The COM-120C is configured to simulate a trunked Radio Unit to enable testing of the trunked infrastructure.

#### OFF-AIR MONITOR

The COM-120C is configured to become an "off-air" monitor and displays the protocol messages on screen from either a repeater or radio unit.

#### SETUP

The SETUP screen allows the network configuration parameters to be entered. These parameters are required by the other test facilities.

MPT 1327 Trunking					
Select Option:					
1. Automatic Test Mode					
2. Repeater Simulator					
3. Radio Unit Simulator					
4. Off-Air Monitor					
5. Setup					
AUTO	REP SIM	RAD SIM	MONITOR	SETUP	RETURN

# SECTION 6

## OPTIONS

### 6-15-1 SETUP NETWORK DEFINITION

The SETUP screen allows the customization of network definitions.

#### NAME

This field allows a network definition to be assigned a descriptive label of up to 19 characters. This parameter is optional and has no effect on the system operation.

#### SYSTEM ID

The SYSCODE is used in the generation of control channel signaling (Repeater Simulator).

See notes on following pages for a description of how to calculate the SYSCODE.

The TSCI (Trunked System Controller Ident) is used as the COM-120C ident in message transactions with a radio unit.

With some Radio Unit's, SDM's from TSCI have a system-dependent meaning, sometimes making it necessary to change this value.

#### CODEWORDS

These parameters are the synchronization codewords for control and traffic channels, used in the generation of control channel signaling and encode of transmitted messages.

The default values for SYNC and SYNT (UK standard) are C4D7 and 3B28 respectively. Do not change these settings for standard MPT 1327/1343 networks.

#### CHANNEL RANGE

The maximum permissible channel range is 1 to 1023. This range may be controlled using the lowest and highest channel fields.

These values are also used in the automatic test mode for the low and high channel handoff tests.

MPT 1327 Network Definition			
<b>Name:</b>	IFR SYSTEMS		
System ID	SYSCODE: 2809	TSCI: 8190	
Codewords	SYNC: C4D7	SYNT: 3B28	
Channel Range	Lowest: 1	Highest: 512	
Control Channel	Initial: 100	Second: 200	
First Traffic Channel:	200		
Base Rec Freq:	157.3500 MHz	Chan Spacing:	12.5 kHz
Base Gen Freq:	149.3500 MHz	FFSK Mod:	1.50 kHz
Channel-Frequency Allocation			
Chan: *	Rx: * MHz	Tx: * MHz	
LOAD	SAVE	DEFAULT	REP SIM
RAD SIM	RETURN		



# SECTION 6

## OPTIONS

---

### DEFAULT CHANNELS

The first control channel is the channel the COM-120C uses on entry to all the test screens. The second control channel is used by the automatic test mode for the MOVE test.

The Radio Unit only goes into service on a channel that is contained within the programmed hunt sequence. See notes on following pages for discussion of UK Band III DTI numbering scheme.

### BASE FREQUENCIES

These are the base Rx and Tx frequencies from which the channel spacing is used as an offset to calculate the frequencies for each channel.

The base frequencies are effectively those of logical channel 0.

### CHANNEL SPACING

The normal values for this parameter are either 12.5 kHz (default) or 25 kHz. If it is set to zero, editing of the channel-frequency allocation plan fields is enabled, otherwise editing is disabled. Other values of channel spacing can be entered as required.

### FFSK MODULATION

The FFSK modulation level is used to determine the deviation applied to the data generator for FFSK modulation.

Usual values are 1.5 kHz for 12.5 kHz channel spacing, 2.5 kHz for 25 kHz channel spacing.

### CHANNEL PLAN

Some networks do not use a fixed channel spacing frequency plan. In order to create such a network definition, set the channel spacing field to zero. Now it is possible to individually edit the Rx and Tx frequencies for each channel.

# SECTION 6

## OPTIONS

### 6-15-2 SYSCODE CALCULATION

The system codeword is used when generating control channel signalling as a system identifier. When testing Radio Units, the correct SYSCODE allows the RU under test to go into service.

The SYSCODE is actually constructed from a number of different fields. The codeword is 15 bits long with the most significant bit (B15) = 0.



B15	B14	B13	B12	B11	B10	B9	B8	B7	B6	B5	B4	B3	B2	B1	B0
0	0	OPID						NDD					LAB		
0	1	OPID			NDD						LAB				

B14 specifies whether the network is termed a National Network (1) or a Regional Network (0). Depending on the setting of the Network type, the length of the OPID field is either 7 bits or 2 bits and the NDD field 4 or 9 bits. The LAB field is normally set to 001 to allow any category radio unit to access the system.

The NDD field generally contains a site identifier number for a multiple site network.

The easiest way to construct the SYSCODE is to convert each field into binary with all leading zeroes to complete the field width, then create a 16 bit hexadecimal number converting each four bits into a hexadecimal character 0-9, A-F.

Example: A Radio Unit is programmed for a regional network, OPID=50, and has access authorization for site area 1.

OPID = 94 decimal = 1011110 binary

NDD = 1 decimal = 0001

LAB = 001 SYSCODE = 2F09

B15	B14	B13	B12	B11	B10	B9	B8	B7	B6	B5	B4	B3	B2	B1	B0
0	0	OPID						NDD					LAB		
0	0	1	0	1	1	1	1	0	0	0	0	1	0	0	1
2				F				0				9			

In many instances where the Radio Unit has unlimited access, authorization NDD may be set to any value.

# SECTION 6

## OPTIONS

---

### 6-15-3 CHANNEL NUMBERING

It is important the first control channel number used here is a channel defined in the Normal Hunt table of the Radio Unit. Although an RU is instructed to MOVE to another control channel, a channel is not acquired unless the channel is in the Normal Hunt table. Otherwise, the RU enters a Comprehensive Hunt. This may take many minutes before acquiring a channel and going into service.

Radio Units operating in the UK Band III sub-bands 1 and 2 use a slightly different channel designation.

.....

#### Sub-band 1

Channel No.	CHAN field binary representation	Radio Unit tx freq
1		184.5000MHz
58	1000000001	185.2125MHz
560	1111110111	191.4875MHz

#### Sub-band 2

Channel No.	CHAN field binary representation	Radio Unit tx freq
1		192.5000MHz
58	0000000001	193.2125MHz
560	0111110111	199.4875MHz



The COM-120C uses the binary channel number (as programmed into the radio).

# SECTION 6

## OPTIONS

---

### 6-15-4 BASE FREQUENCIES

Every network has a channel plan, identifying a channel number with a specific transmit and receive frequency. Generally this plan is referenced back to an initial BASE frequency which is either logical channel 0 or occasionally logical channel 1. Each channel is then related to the channel number and base frequency by the formula  $\text{BASE FREQUENCY} + (\text{channel number} \times \text{channel spacing})$ .

For example if it is known that the frequency of a control channel is 188.8750 MHz and it is channel number 298, the base frequency must be  $188.8750 - (298 \times 0.0125) = 185.025$  MHz assuming the channel spacing is 12.5kHz.

For situations with a non incremental channel plan, usually used when there are different channel spacings (Rx/Tx split) on different channels, it is possible to define each channel number manually by setting the channel spacing to zero.

# SECTION 6

## OPTIONS

### 6-15-5 TRUNKING SIMULATOR SCREENS

In the manual test modes, the COM-120C simulates either a trunked single site repeater (to test radio units) or a trunked radio unit (to test repeaters).

In automatic test mode, the COM-120C simulates a trunked single site repeater controlled by a configurable automated test procedure.



1. CCH#

Displays control channel status. The cursor is highlighted when the COM-120C is in control channel mode.

2. TCH#

Displays traffic channel status. The cursor is highlighted when the COM-120C is in traffic channel mode.

3. Extended Meas

Provides access to extended measurement screens.

MPT 1327 REPEATER SIMULATOR	
CCH#: 100	TCH#: 200 Extended Meas:
RECEIVE	GENERATE
RF: 159.8500 MHz	RF: 151.8500 MHz
Input: T/R Atten: 0 dB	Level: -40.0 dBm
IF: 15 kHz Speaker: WIDE	Output: T/R
Prefix: 1	Repeater: IDLE
Ident: 1001	Call type: SPEECH
ESN: 003/10/054087	RU PTT ON
RF Power: 21.6 WATTS	GEN-1 DATA
RF Error Freq: -0.208 kHz	Mod Source: GEN1 FM
Deviation: ± 0.02 kHz (V)	Deviation: 1.50 kHz
AF Frequency: 0 Hz	Frequency: 1000.0 Hz
Distortion: 79.6%	Baseband level: 0.54
	Sinad:
SPEECH	REGISTN STATUS SDM CONFIG RETURN

4. RF (Receive)

Receiver frequency, value dependent on current channel.

5. Input

Receiver RF source selection. Selections are T/R or ANT.

6. Atten

Receiver input attenuation. Selections are 0 or 30 dB.

7. IF

Receiver IF selections are 300 kHz, 15 kHz or 30 kHz.

8. Speaker

Speaker routing and filters.

9. RF (Generate)

Generator frequency, value dependent on current channel.

# SECTION 6

## OPTIONS

---

10. Level

Generator output level. Range is dependent on output; for T/R output selection range is -130 to -40 dBm, for AUX output selection range is -130 to -13 dBm.

11. Output

Generator RF output selection. Selections are T/R or AUX.

12. RF Power/ RF Level

Displays UUT transmitter RF power in W or mW (T/R input connection) or level in dBm (ANT input connection).

13. RF Error Freq

Displays unit under test's transmitter RF frequency error in kHz.

14. Deviation

Displays selected (voice or data) deviation in kHz. Voice is indicated by a 'V', data by a 'D'.

15. AF Frequency

Displays Unit Under Test transmitter Audio Frequency in Hz.

16. Distortion/ DTMF

This field displays either Distortion or DTMF.

17. Mod Source

Displays selected modulation source. Selections include GEN1 (Audio Generator-1), GEN2 (Audio Generator-2, where fitted), and DTMF (DTMF Tone Generator).

18. Deviation

Displays modulation source Deviation.

19. Frequency

Displays modulation source Frequency.

20. Baseband Level

Displays modulation source baseband level in Vpk and Vrms or mVpk and mVrms.

21. Distortion/ SINAD/ AF Level

This field can be selected to display one of receiver distortion, SINAD or AF level. These functions require direct connection to the unit under test.

# SECTION 6

## OPTIONS

---

### 6-15-6 REPEATER SIMULATOR

In the manual Repeater Simulator mode, all editable fields are available.



1. Prefix  
MPT 1327 prefix of the RU under test. Valid range is 0 to 127.
2. Ident  
MPT 1327 identity of the RU under test. Valid range is 0 to 8191.
3. ESN  
Electronic Serial Number of the RU under test, displayed following a successful registration test.
4. Repeater  
See, Appendix D for softkey definition.
5. Call Type  
This field allows selection of the call types for COM-120C initiated calls to the RU selected by PFIX/IDENT.
6. Status Info  
Displays information messages pertaining to the current status, eg "IN TRAFFIC," "STATUS 27 SENT."

# SECTION 6

## OPTIONS

---

### 6-15-7 TESTING RADIO UNITS

When testing a Radio Unit, the most commonly used mode is the manual REPEATER SIMULATOR. In this mode the COM-120C acts as a single channel MPT 1327 trunked repeater using control/traffic reversion when calls are initiated. The COM-120C allows a radio unit to be sent a GTC and switch into a call mode, making basic functionality and parametric measurements possible.



The quickest route to checking a Radio Unit is to:

- Select the correct Network file from stored files or create a new one
- Enter Repeater Simulator mode
- Ensure correct Antenna connections are selected and RF levels are correct
- Wait until Radio Unit goes into service
- Initiate a Speech Call request from the Radio Unit

If the Radio Unit does not enter service, but appears to be attempting to register on the COM-120C channel, check that the squelch is adjusted correctly and the baseband metering is switched OFF.



# SECTION 6

## OPTIONS

---

### 6-15-8 MPT 1327/MPT 1343 NUMBERING SCHEMES

All signalling over air uses MPT 1327 numbering for the RU identity (7 bit prefix, 13 bit identity). However, most RU's use MPT 1343 numbering schemes to reduce the digits dialed to two or three digits for calls within fleet. The conversion between 1343 numbers and 1327 identities is performed within the RU. It is impossible for the COM-120C to determine the MPT 1343 number; however, the conversion between the two is relatively easy.



To convert MPT 1343 to MPT 1327:

$$\text{MPT 1327 PFIX} = \text{MPT 1343 PFIX} - 200$$

$$\text{MPT 1327 IDENT} = (\text{FLEET ID} - 2000) \times 2 + (\text{FLEET NUMBER} - 20 \text{ or } 200)$$

Example:

$$\text{MPT 1343 ID} = 201\ 2500\ 27$$

$$\text{MPT 1327 PFIX} = 201 - 200 = 001$$

$$\text{MPT 1327 IDENT} = (2500 - 2000) \times 2 + (27 - 20) = 1007$$

# SECTION 6

## OPTIONS

### 6-15-9 RADIO SIMULATOR

In this mode the COM-120C simulates a MPT 1327 Trunked Radio Unit.

The features of the Radio Unit Simulator screen are described in this section.



1. Prefix

This field is the MPT 1327 Prefix of the simulated Radio Unit. Valid range is 0 to 127.

2. Ident

This field is the MPT 1327 Identity of the simulated Radio Unit. Valid range is 0 to 8191.

3. ESN

Electronic Serial Number of the simulated RU under test, derived from the unit serial number of the COM-120C.

MPT 1327 RADIO SIMULATOR	
<b>CH#:</b> 200	<b>TCH#:</b> 300 <span style="float: right;">Extended Meas:</span>
RECEIVE	GENERATE
RF: 151.8500MHz	RF: 159.8500MHz
Input: T/R Atten: 0 dB	Level: -13.0 dBm
IF: 15 kHz Speaker: WIDE	Output: AUX
<b>Prefix:</b> 1	Called ID: 1000
Ident: 1001	
ESN: 252/01/008187	
RF Power: 0.0mW	GEN-1 DATA
RF Error Freq: ---kHz	Mod Source: GEN1 FM
Deviation: ± ---kHz (V)	Deviation: 0.00kHz
AF Frequency: ---Hz	Frequency: 1000.0Hz
Distortion: ---%	Baseband level: 2.00
	Sinad:
CALL	PTT
RETURN	RETURN

4. Called ID

This field allows selection of the called RU ident. Setting this the same as the IDENT field allows testing without an additional RU.

5. Status Info

Displays information messages pertaining to the current status, e.g. "IN SERVICE."

# SECTION 6

## OPTIONS

---

### 6-15-10 AUTOMATIC TEST MODE, TEST SELECTION

An automatic test facility that subjects a Radio Unit to a series of predefined tests.

The test selection screen allows the user to decide which protocol tests are required.



1. Network

Name of the network currently in use (configured in the SETUP screen).

2. RU Type

Name of the Radio Unit type (configured in the parametrics LIMITS screen).

3. RU Prefix

MPT 1327 prefix of the Radio Unit under test. Valid range is 0 to 127.

4. RU Ident

MPT 1327 identity of the Radio Unit under test. Valid range is 0 to 8191.

5. ESN

Electronic Serial Number of the RU under test, displayed following a successful registration test.

6. Registration

This test demands the RU to register and interrogates the ESN.

7. Moving CCH

This test sends the Radio Unit to another control channel (defined in the network definition). An availability check is performed to ensure the RU successfully moved to the new channel. The RU is then moved back to the original control channel.

8. RU Speech Call

This test attempts to set up a speech call from the Radio Unit (only possible with direct connection to the RU under test). If unsuccessful, the COM-120C prompts to press the RU call button to set up the call. The COM-120C prompts to clear the call.

MPT 1327 Auto Test Selection/Results		
Network:	IFR SYSTEMS	
RU Type:	PRM8060	
RU Prefix: 1		
RU Ident: 1001	RU ESN:	003/10/054087
Registration	ENABLE	PASS
Moving CCH	ENABLE	PASS
RU Speech Call	ENABLE	PASS
Speech Call to RU	ENABLE	PASS
<u>Handoff</u>	ENABLE	PASS
Overall result:	PASS	
<input type="button" value="ENABLE"/>	<input type="button" value="DISABLE"/>	<input type="button" value="MEAS-LO"/>
<input type="button" value="MEAS-HI"/>	<input type="button" value="START"/>	<input type="button" value="RETURN"/>

# SECTION 6

## OPTIONS

---

### 9. Speech Call to RU

This test attempts to set up a speech call to the Radio Unit. Transmit and receive parametric measurements are then taken, subject to the correct audio connections between the RU and COM-120C.

If direct audio connection is not available, choose to SKIP the receiver parametrics test when at the prompt.

The call is cleared from the COM-120C.

### 10. Handoff

This test sets up a speech call to the Radio Unit. Once in traffic, the RU is handed off to the lowest channel specified in the network definition. Parametric measurements are performed as per SPEECH CALL TO RU. The call is cleared by the COM-120C, which then calls the RU again and hands it off to the highest channel. The parametric measurements are repeated on this channel. Finally, the COM-120C clears the call and ensures the RU returns to the control channel.

# SECTION 6

## OPTIONS

### 6-15-11 PARAMETRIC LIMITS

The Parametric Limits Screen for the Automated Test Mode allows pass/fail limits settings.



1. RU Type

This field allows a set of limits to be given a descriptive label of up to 19 characters. This parameter is optional and has no effect on the system operation.

2. Tx Freq Error

Maximum permissible frequency error, in kHz.

3. Tx Power

Minimum and maximum permissible transmitter power, in W.

4. Tx Deviation

Minimum and maximum permissible transmitter deviation, in kHz. Since the COM-120C GEN1 is used to generate the test signal, direct audio connections are required to perform this measurement.

5. Tx Limiter

Minimum and maximum permissible transmitter limiting deviation, in kHz. Since the COM-120C GEN1 is used to generate the test signal, direct audio connections are required to perform this measurement.

6. Tx Distortion

Maximum permissible transmitter distortion, as a percentage. Since the COM-120C GEN1 is used to generate the test signal, direct audio connections are required to perform this measurement.

7. Rx Sensitivity

Maximum permissible receiver sensitivity, in dBm or  $\mu$ V. Since the COM-120C GEN1 is used to generate the test signal, direct audio connections are required to perform this measurement.

MPT 1327 Auto Test: Limits			
<b>RU Type:</b>	PRM8060		
Tx Freq Error:		kHz	----
Tx Power:	20.00	W	MIN
Tx Deviation:	1.40	kHz	MIN
Tx Limiter:	2.00	kHz	MIN
Tx Distortion:		%	----
Rx Sensitivity:		dBm	----
Rx SINAD:	120.0	dB	MIN
Rx Distortion:		%	----
Rx AF Level:	0.05	Vrms	MIN
<input type="button" value="LOAD"/>	<input type="button" value="SAVE"/>	<input checked="" type="button" value="MIN"/>	<input type="button" value="MAX"/>
			<input type="button" value="RETURN"/>

# SECTION 6

## OPTIONS

---

8. Rx SINAD

Minimum permissible receiver SINAD, in dB. Since the COM-120C GEN1 is used to generate the test signal, direct audio connections are required to perform this measurement.

9. Rx Distortion

Maximum permissible receiver distortion, as a percentage. Since the COM-120C GEN1 is used to generate the test signal, direct audio connections are required to perform this measurement.

10. Rx AF Level

Minimum and maximum permissible receiver audio level, in Vrms. Since the COM-120C GEN1 is used to generate the test signal, direct audio connections are required to perform this measurement.

# SECTION 6

## OPTIONS

---

### 6-15-12 TEST EXECUTION

During test execution, the Repeater Simulator screen is displayed. Editing of fields is not permitted in this mode. Autotest status and user prompts are displayed in the title bar at the top of the screen, or in pop-up windows.

Note that before the selected tests are executed, a control channel acquisition test is always performed. Pressing any hard-key aborts the autotest.

Once the sequence of tests has been completed, the auto test selection/results screen is re-displayed. This screen indicates the overall result and result for each test: "PASS", "FAIL" or "----" (not tested). These results are based on both protocol and parametric checks.

### 6-15-13 PARAMETRIC RESULTS

The Parametric Measurements Screen for the Automated Test Mode displays the measured values, together with pass/fail results for each measurement based on the limits table. The result for each test is indicated as: "PASS", "FAIL" or "----" (not tested).



1. Tx Freq Error

Measured value of transmitter frequency error, in kHz.

2. Tx Power

Measured value of transmitter power, in W.

3. Tx Deviation

Measured value of transmitter deviation, in kHz.

4. Tx Limiter

Measured value of transmitter limiting deviation, in kHz.

5. Tx Distortion

Measured value of transmitter distortion, as a percentage.

6. Rx Sensitivity

Measured value of Receiver Sensitivity, in dBm or  $\mu$ V.

7. Rx SINAD

Measured value of receiver SINAD, in dB.

8. Rx Distortion

Measured value of receiver distortion, as a percentage.

9. Rx AF Level

Measured value of receiver audio level, in Vrms.



# SECTION 6

## OPTIONS

---

### 6-15-14 OFF-AIR MONITOR

In this mode the COM-120C becomes an off-air monitor and displays the MPT 1327 messages on screen from either a Radio Unit or Trunked Repeater Unit.



1. CCH# / TCH#

Displays control and traffic channel status. The relevant cursor is highlighted when the COM-120C is in control or traffic channel mode. Softkey functions available are dependent upon mode.

2. PFIX/ IDENT

Identity of Radio Unit, for use in FOLLOW mode.

3. GTC/ ACKQ

Displays statistics summary. The cursor is highlighted when the COM-120C is in traffic channel mode.

4. Repeater Monitor Softkeys

See Appendix D.

MPT 1327 OFF-AIR MONITOR					
<b>CCH#:</b>	834	<b>TCH#:</b>	894	<b>GTCs:</b>	0
		<b>ACKQs:</b>		0	
Sysdef:02	Sys:2811	BCAST	Per:1	Ival:0	Pon:0
Pfix:000	Id1:0000	ALH	Chan4:02	Wt:1	Rsvd:0
			M:00	N:02	Tsclim:255
Sysdef:03	Sys:2811	BCAST	NA:1	Reg:0	
Pfix:000	Id1:0000	ALH	Chan4:02	Wt:1	Rsvd:0
			M:00	N:02	Tsclim:255
Sysdef:02	Sys:2811	BCAST	Per:1	Ival:0	Pon:0
Pfix:000	Id1:0000	ALH	Chan4:02	Wt:1	Rsvd:0
			M:00	N:02	Tsclim:255
Sysdef:03	Sys:2811	BCAST	NA:1	Reg:0	
Pfix:000	Id1:0000	ALH	Chan4:02	Wt:1	Rsvd:0
			M:00	N:02	Tsclim:255
Sysdef:02	Sys:2811	BCAST	Per:1	Ival:0	Pon:0
<b>DECODE</b>	<b>FOLLOW</b>	<b>RAD</b>	<b>FILTERS</b>	<b>SUMMARY</b>	<b>RETURN</b>

# SECTION 6

## OPTIONS

1. Monitor Filter Softkeys

See Appendix D.

2. Radio Monitor Softkeys

See Appendix D.

MPT 1327 OFF-AIR MONITOR												
<b>CCH#:</b>	834	<b>TCH#:</b>	894	<b>Pfix:</b>	1	<b>Ident:</b> 1001						
12:08:08	Sysdef:03	Sys:2811	BCAST	8D408C701004		<b>2555</b>						
12:08:08	Sysdef:02	Sys:2811	BCAST	89408C7200FF		8AC6						
12:08:08	Pfix:000	Id1:0000	ACK	800004201456		<b>9AAA</b>						
12:08:08	Sysdef:02	Sys:2811	BCAST	89408C7200FF		8AC6						
12:08:09	Pfix:000	Id1:0000	ALH	800004008802		9156						
12:08:09	Sysdef:03	Sys:2811	BCAST	8D408C701000		D7C6						
12:08:09	Pfix:000	Id1:0000	ALH	800004008802		9156						
12:08:09	Sysdef:02	Sys:2811	BCAST	89408C7200FF		8AC6						
12:08:09	Pfix:000	Id1:0000	ALH	800004008802		9156						
<table border="1" style="width:100%; border-collapse: collapse;"> <tr> <td style="padding: 2px;">NO ALH</td> <td style="padding: 2px;">NO ACKS</td> <td style="padding: 2px;"><b>GTC</b></td> <td style="padding: 2px;">EXT MSG</td> <td style="padding: 2px;"><b>HEX MSG</b></td> <td style="padding: 2px;">RETURN</td> </tr> </table>							NO ALH	NO ACKS	<b>GTC</b>	EXT MSG	<b>HEX MSG</b>	RETURN
NO ALH	NO ACKS	<b>GTC</b>	EXT MSG	<b>HEX MSG</b>	RETURN							

# SECTION 6

## OPTIONS

---

THIS PAGE INTENTIONALLY LEFT BLANK.

# APPENDIX A - USER I/O CONNECTORS AND PIN-OUT TABLE

## A-1 TABLE OF I/O CONNECTORS

CONNECTOR NAME	CONNECTOR TYPE	SIGNAL IN/OUT	SIGNAL TYPE
T/R	"N" TYPE	IN/OUT	RF, 200 W MAX
SCOPE/DVM	BNC	IN	Analog, 200 Vdc MAX CAT II
DEMODO	BNC	OUT	Audio
AUDIO/DATA GEN	BNC	OUT	Audio
AUDIO/DATA IN	BNC	IN	Analog, Digital 20 Vdc MAX
EXT MOD	BNC	IN	Analog, 20 Vdc MAX
MIC/ACC	8 Pin DIN	IN/OUT	See Pin-Out Table
AUX RF OUT	BNC	OUT	RF
ANTENNA	TNC	IN	RF, 0.25 W CW MAX
AC LINE IN	AC Power	IN	120/240 VAC
DC IN		OUT	12 Vdc, 24-30 Vdc
GPIB (IEEE-488)	24 Pin Champ	IN/OUT	See Pin-Out Table
RS-232	9 Pin, D	IN/OUT	See Pin-Out Table
EXTERNAL REFERENCE	BNC	IN	10 MHz >0 dB

Table of I/O Connectors

## A-2 PIN-OUT TABLE FOR MIC/ACC CONNECTOR

PIN NUMBER	SIGNAL NAME	SIGNAL TYPE	I/O
1	PTT-Out	TTL	Programmable Out
2	Mic Audio	Audio	In
3	Demod Audio	Audio	Out
4	NC	NC	
5	+15 Vdc	10-15 Vdc, 1 mA	Out
6	NC	NC	
7	Mic Switch	TTL	Programmable In
8	GND		

Pin-Out for MIC/ACC Connector Table

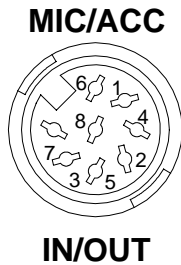

861801:

MIC/ACC Connector Pin Identification

### A-3 PIN-OUT TABLE FOR GPIB CONNECTOR

PIN NUMBER	ASSIGNMENT	PIN NUMBER	ASSIGNMENT
1	DIO 1	10	SRO
2	DIO 2	11	ATN
3	DIO 3	12	Digital GND
4	DIO 4	13	DIO 5
5	EOI	14	DIO 6
6	DAV	15	DIO 7
7	NFRD	16	DIO 8
8	NDAC	17	REN
9	IFC	18-24	Digital GND

Pin-Out for GPIB Connector Table

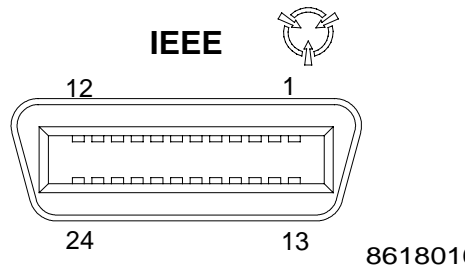

GPIB Pin Identification

Use of the GPIB Connector is in compliance with ANSI/IEEE Standard 488.2-1987.

## A-4 PIN-OUT TABLE FOR RS-232 CONNECTOR

PIN NUMBER	ASSIGNMENT
1	4.7 k $\Omega$ + 15 Vdc
2	TX DATA
3	RX DATA
4	N/C
5	Digital GND
6	4.7 k $\Omega$ + 15 Vdc
7	CTS
8	RTS
9	N/C

Pin-Out for RS-232 Connector Table

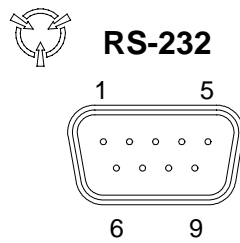

8618017

RS-232 Connector Pin Identification

## APPENDIX B - ABBREVIATIONS

<b>A</b>		<b>D</b>	
A	Ampere	DAC	Digital to Analog Converter
ac	Alternating Current	DCS	Digital Coded Squelch
AF	Audio Frequency	dB	Decibels
A Freq	Audio Frequency	dBm	Decibels relative to 1 milli-watt
AGC	Automatic Gain Control	dc	Direct Current
AM	Amplitude Modulation	DCS	Digital Coded Squelch Codes
amp	Ampere	Demod Audio	Demodulated Audio
ANLZ	Analyzer	Dev	Deviation
ANSI	American National Standards Institute	Disp	Display
ANT	Antenna	Dist	Distortion
AR	Autorange	div	Division(s)
ASCII	American National Standard Code for Information Interchange	DMM	Digital Multimeter
Atten	Attenuation	DPL	Duplex
Auto	Automatic	DPLX	Duplex
AUX	Auxiliary	DTMF	Dual Tone Multi-Frequency
		Dup	Duplex
<b>B</b>		<b>E</b>	
BFO	Beat Frequency Oscillator	ERR	Error
BER	Bit Error Rate	ESC	Escape
bps	Bits per second	ESD	Electrostatic discharge
<b>C</b>		E-TACS	Enhanced Total Access Communications System
Cbl Flt	Cable Fault	EXT MOD	External
CCH	Control Channel		
ccw	Counterclockwise		
Cont	Continued		
CW	Continuous Wave		
C Wt	C-Weight		



	<b>F</b>		<b>L</b>
Fig	Figure	L-lim	Lower Limit
FM	Frequency Modulation	Lmt	Limit
Folw	Follow	LSB	Single Sideband Lower
freq	Frequency	lvl	Level
Func	Function		
Func Gen	Function Generator		
	<b>G</b>		<b>M</b>
		M-Freq	Audio Frequency
		MHz	Megahertz (1000000 Hertz)
G-Scan	RF Generator Scan	MIC	Microphone Source
Gen	Generator	Mkr	Marker
GND	Ground	mod	Modulation
GPIOB	General Purpose Interface Bus	modul	Modulation
		ms	Millisecond
	<b>H</b>	MTRS	Meters
Hz	Hertz	mV	Millivolt
Hex	Hexadecimal	mW	Milliwatt
Horiz	Horizontal		<b>N</b>
	<b>I</b>	Neg	Negative
Id	Identification	NADC	North American Digital Cellular
IF	Intermediate Frequency		<b>O</b>
IEEE	Institute of Electrical and Electronic Engineers		
I/O	Input/Output	OFST	Offset Frequency
	<b>K</b>		<b>P</b>
kbps	Kilobits per second	PH	Peak Hold
kHz	Kilohertz (1000 Hertz)	PM	Phase Modulation
		Pos	Positive
		PROG	Program
		PWR	Power (switch)

**R**

RCL	Recall
Rcvr	Receiver
Recap	Recapture
Ref	Reference
Res	Resolution
Ret	Return
RF	Radio Frequency
RF Pwr Lvl	RF Power Level
R freq	Receiver Frequency
RMS	Root Mean Square
Rx	Duplex Receiver (Transmitting) Frequency

**S**

SCRN	Screen
SCSI	Small Computer System Interface
sec	Second
SGL	Single
SIG	Signal Strength
SQLCH	Squelch
SSB	Single Side Band

**T**

TERM	Terminal
T Freq	Duplex Transmitter Frequency
Tone Rem	Tone Remote
Trig	Trigger
Trk	Tracking
Tx	Duplex Transmitter (Receiving) Frequency

**U**

U-lim	Upper Limit
us	Microsecond
USB	Single Sideband Upper
UUT	Unit Under Test

**V**

V	Volt
VAC	Alternating current voltage
VChan	Voice Channel
Vdc	Direct current voltage
Vert	Vertical
VOL	Volume
VRMS	Voltage Root Mean Square

**W**

W	Watt
---	------

THIS PAGE INTENTIONALLY LEFT BLANK.

# APPENDIX C - REPACKING FOR SHIPPING

## C-1 SHIPPING INFORMATION

IFR Test Sets returned to factory for calibration, service or repair must be repackaged and shipped subject to the following conditions:

### C-1-1 AUTHORIZATION

Do not return any products to factory without authorization from IFR Customer Service Department.

CONTACT: IFR  
Customer Service Dept.  
10200 West York Street  
Wichita, Kansas 67215

Telephone: (800) 835-2350

FAX: (316) 524-2623

### C-1-2 TAGGING TEST SETS

All test sets must be tagged with:

- Owner's identification and address.
- Nature of service or repair required.
- Model No. and Serial No.

### C-1-3 SHIPPING CONTAINERS

Test Sets must be repackaged in original shipping containers using IFR packing materials. If original shipping containers and materials are not available, contact IFR Customer Service Department for shipping instructions.

### C-1-4 FREIGHT COSTS

All freight costs on non-warranty shipments are assumed by the customer. (See "Warranty Packet" for freight charge policy on warranty claims.)

## C-2 REPACKING PROCEDURE

- Make sure bottom packing mold is seated on floor of shipping container.
- Adjust handle to lay unlocked against Test Set as shown.
- Place Elastic Retainer around Test Set to secure handle.
- Carefully wrap Test Set with polyethylene sheeting.
- Place Test Set into shipping container, making sure Test Set is securely seated in bottom packing mold.
- Place top packing mold over top of Test Set and press down until mold rests solidly on bottom packing mold.

- Close shipping container lids and seal with shipping tape or an industrial stapler. Tie all sides of container with break resistant rope, twine or equivalent.

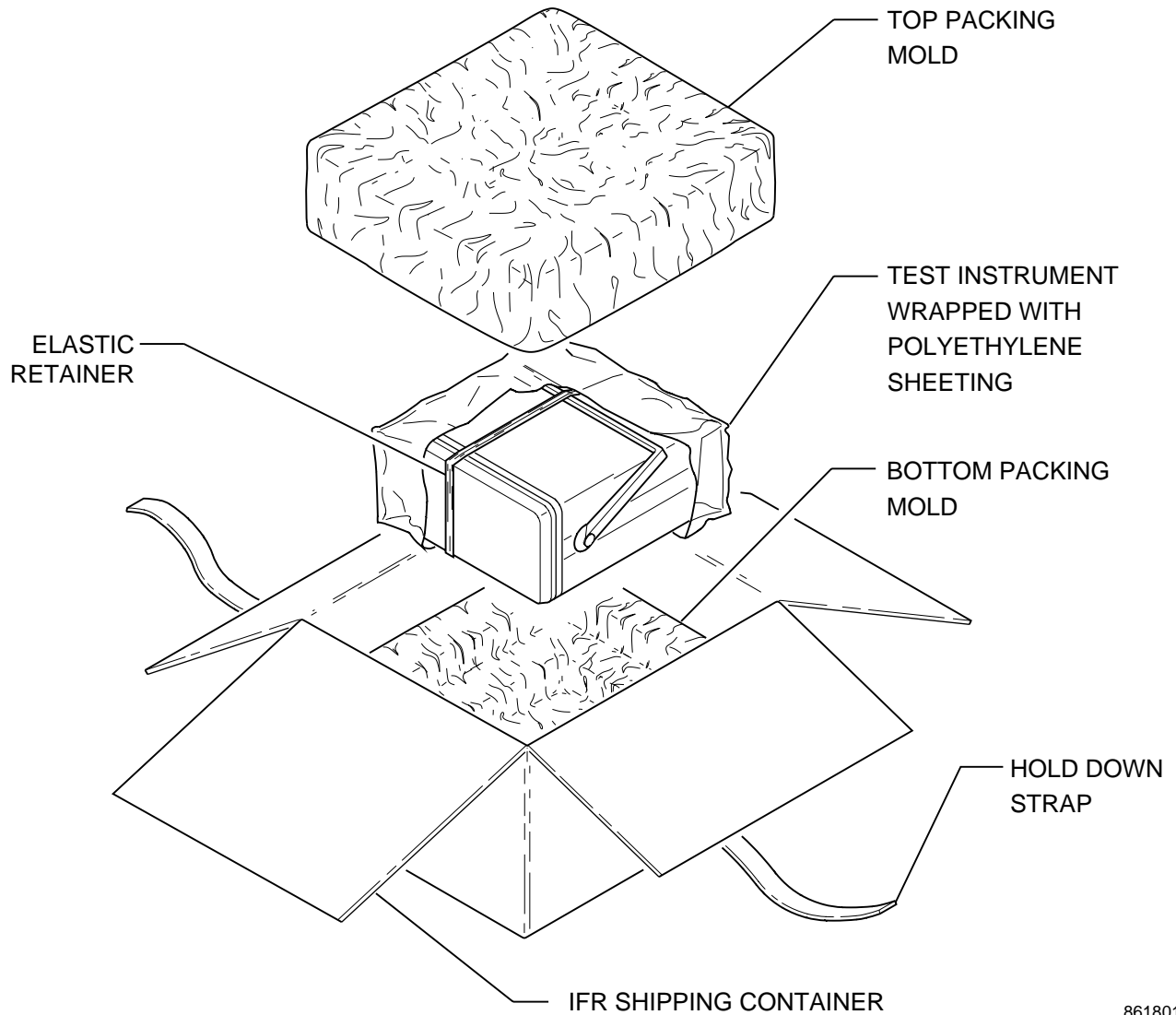

8618018

Repacking for Shipment

# APPENDIX D – SOFT FUNCTION KEYS

## ALPHABETICAL LISTING OF COM-120C SOFT FUNCTION KEYS

FUNCTION	DESCRIPTION		
%	Toggles between dB and % settings. Inactive units displayed on softkey.		
Δ ON/OFF	Toggles Δ Function ON and OFF. Δ displays adjacent to Frequency Readout when active.		
••	Moves up one directory (to the directory's parent.)		
Δ=	Accesses window to set RF Field change increment (Δ Freq).		
/10	Activates /10 Mode for Level.	Alters the scaling factor for the baseband level.	
/100	Activates /100 Mode for Level.		
\	Adds a backslash to the directory.		
0 dB	Selects 0 dB Attenuation.		
0.1 S	Selects 0.1 Second Gate Time.		
1 kHz	Selects 1 kHz Range.		
1 RAD	Selects 1 Radian as active upper range for Phase Modulation Meter.		
1 S	Selects 1 Second Gate Time.		
1 SHOT	Selects and enables One Shot as Trigger type.		
1.0 S	Selects 1.0 Second Gate Time.		
10 dB	Selects 10 dB Logarithmic Scale for Spectrum Analyzer Vertical Scale.		
10 kHz	Selects 10 kHz Range.		
10 RAD	Selects 10 Radians as active upper range for Phase Modulation Meter.		
10 S	Selects 10 Second Gate Time.		
100 Hz	Selects 100 Hz Range.		
100 kHz	Selects 100 kHz Range.		
100 kHz	Selects 100 kHz Range.		
100%	Sets Distortion Meter Upper Range to 100%.	Selects 100% as active upper range for AM Modulation meter.	
1200	Selects 1200 bps Data Rate. Displayed only with cursor at Data Rate Field.		
15 dB	Selects 15 dB as active upper range for SINAD Meter.		
15 kHz	Selects 15 kHz bandpass filter as active filter.	Selects 15 kHz IF Filter in optional BER Meter operation.	
2 dB	Selects 2 dB Logarithmic Scale for Spectrum Analyzer Vertical Scale.		
2 RAD	Selects 2 Radians as active upper range for Phase Modulation Meter.		
20 kHz	Selects 20 kHz Range.	Routes DTMF/SINAD Signal through 20 kHz Low-Pass Filter.	Activates 20 kHz Low-Pass Filter in optional BER Meter operation.

FUNCTION	DESCRIPTION	
20%	Sets Distortion Meter Upper Range to 20%.	
200 Hz	Selects 200 Hz Range.	
2000 Hz	Selects 2 kHz Range.	
24 PIN	Configures printer output for an Epson 24 Pin Printer.	
2400	Selects 2400 bps Data Rate. Displayed only with cursor at Data Rate Field.	
30 dB	Selects 30 dB Attenuation.	
30 kHz	Selects 30 kHz bandpass filter as active filter.	Selects 3 kHz Optional IF Bandwidth Filter in optional BER Meter operation.
300 Hz	Routes DTMF/SINAD Signal through 300 Hz High-Pass Filter.	Activates 300 Hz High/Low-Pass Filter in optional BER Meter operation.
300 kHz	Selects 300 kHz bandpass filter as active filter.	Selects 300 kHz IF Filter in optional BER Meter operation.
4 kHz	Routes DTMF/SINAD Signal through 4 kHz Low-Pass Filter.	Activates 4 kHz High/Low-Pass Filter in optional BER Meter operation.
40%	Selects 40% as active upper range for AM Modulation meter.	
5 RAD	Selects 5 Radians as active upper range for Phase Modulation Meter.	
50 kHz	Selects 50 kHz Range.	
512	Selects 512 bps Data Rate. Displayed only with cursor at Data Rate Field.	
55 dB	Selects 55 dB as active upper range for SINAD Meter.	
5970 Hz	Selects 5970 SAT Frequency in optional AMPS Cellular operation.	
6000 Hz	Selects 6000 SAT Frequency in optional AMPS Cellular operation.	
6030 Hz	Selects 6030 SAT Frequency in optional AMPS Cellular operation.	
800 MHz	Selects 800 MHz Trunking Band.	
9 PIN	Configures printer output for an Epson 9 Pin Printer.	
900 MHz	Selects 900 MHz Trunking Band.	
ABORT	Escapes Storage Operation without performing edit.	Aborts the directory creation or format action and returns to the File List Screen.
AC	Selects AC Coupling for Oscilloscope, DEMOD Connector and optional BER Meter operation..	
AF DEC	Selects AF Decode as current Filter Line.	
AF DECD	Routes AF Decoder/SINAD signal to DEMOD Connector.	
AF LVL	Selects AF Level as active meter.	
AF-CNT	Routes AF Counter signal to DEMOD Connector.	
ALPHANO	Forces Decode Function to decode message as specified type.	
AM	Selects Amplitude Modulation as Modulation type.	Selects Amplitude Modulation as Demodulation type.

FUNCTION	DESCRIPTION				
ANALY	Displays abbreviated Analyzer.				
ANT	Selects ANTENNA Connector as RF input connector.				
APP	Displays when there are stored macro files. A loaded macro application appears as Item Number 4 on the List Setup Screen.				
ARCHIVE	Sets or clears Archive attribute to a file to indicate the file has been changed.				
AUD/DAT	Selects AUDIO/DATA IN Connector as input source for meter.				
Aud-Gen	Routes Audio signal from internal Audio/Data/Signaling Generators, as composite signal, to Speaker and PHONES Connector.				
AUTO	Selects Autorange as active upper range for SINAD and Modulation Meters. Automatically adjusts to a higher or lower range if signal increases or decreases to a specified level of the current setting.	Selects Auto as Trigger type for Oscilloscope.	Allows Decode Function to determine Message Type from received data.	Automatically decodes 1200 or 2400 baud rate incoming POCSAG data.	Accesses Automatic Test screen.
AUX	Selects AUX RF OUT as output connector. Indicator lights up.				
AUX Gate	Selects AUX RF OUT as output connector. Indicator lights up. Only active when microphone is keyed.				
AVG	Activates/deactivates Average Oscilloscope Operation Mode.				
BER	Accesses Bit Error Rate Option.				
BER +	Inserts Bit Errors in the control channel signaling. This function increases the number of bit errors in an erred frame.				
BER INT	Inserts Bit Errors in the control channel signaling. This function decreases the interval at which erred frames are inserted in the control channel.				
BIDIR	Sets Bidirectional Print Mode.				
BMP	Makes the file type a Bitmap format. There is a COLORS field with this selection. (see, NORMAL and INVERT)				
BOTH	Selects + and – peak deviation. The upper limit applies to the largest peak Positive reading and the lower limit applies to the largest Negative reading. For Peak hold readings, Peak Hi applies to the largest Positive peak reading found and Peak Lo applies to the largest Negative reading found.				
BURST	Activates single transmission of selected signal.				
BUSY	Sets Status to BUSY (Busy Home Repeater).				



FUNCTION	DESCRIPTION					
CALL	Makes a Group Call to the Radio, simulating a call from another radio. The ID's used to make the call are taken from the Group/Logical ID fields.			Attempts to set up a Speech Call with RU selected by CALLED ID. Status info display indicates "GO TO CHANNEL" if the call is successful, and the CALL softkey remains highlighted. Press the softkey again, or the start/stop key to clear the call.		
CELL	Accesses AMPS Cellular Option.			Initiates Manual Cell Site Initiated Call Test.		
C-Fwd	Accesses Cellular-Forward Channel List.					
CLEAR	Clears Code Field of current data.	Clears the path to the root path "\."		Clears current entry.		
C-MSG	Routes Detector signal through C-Message Weighted Filter to DEMOD Connector.					
C-MSG	Routes DTMF/SINAD Signal through C-Message Weighted Bandpass Filter.			Activates C-Message Weighted Bandpass Filter.		
COMPARE	Displays stored trace and live trace simultaneously.					
CONFIG	Accesses Configuration Window for configuring User Selectable Frequency and Duration for codes 0 through 9 and A through T.	Accesses RF Generator Filters Setup Menu.	Accesses an Analyzer pop up window to configure Scan Width, RBW and Sweep Rate.	Accesses Tracking Generator Configuration pop up window.	Accesses Configure screen for selecting POCSAG Function, Capcode Range and Data Rate.	Displays a window allowing editing of the default status (SDM1) code and (SDM2) text message.
Config	Accesses pop up window for setting Sweep Width for Find Function. Range of Sweep Width is 0.2000 to 500.0000 MHz.			Accesses pop up window for setting Scan Width, RBW and Sweep Rate.		
CONT	Activates continuous transmission of selected signal.			Continues on with an Automatic Test.		
CONTIN	Selects Continuous Run Mode in optional BER Meter operation..					
COPY	Copies a file without destroying the original. Enter a drive, directory and name of copy destination. Copy the file within the same drive or from one drive to another.					
COUPLE	Sets the Sweep and RBW to factory default state for the current Scan Width.					
CREATE	Creates the directory in the path string.					
C-Rvs	Accesses Cellular-Reverse Channel List.					
DAT DEC	Routes Data Decoder signal to DEMOD Connector.					
DATA	Accesses DATA Generator parameters.			Selects DATA Deviation measurement.		
DATA GEN	Selects Data Signal output through AUDIO/DATA GEN Connector in optional BER Meter operation.					
DATA IN	Selects AUDIO DATA IN as BER Meter input.					

FUNCTION	DESCRIPTION			
dB	Selects dB for Reading Units.		Toggles between dB and % settings. Inactive units displayed on softkey.	
dBm	Sets Output Level Units to dBm.	Selects dBm as Logarithmic Function.	Selects dBm for Reading Units. Activates Impedance field.	Toggles value setting.
dBmV	Selects dBmV as Logarithmic Function.			
dBuV	Selects dB $\mu$ V as Logarithmic Function.			
dBuW	Selects dB $\mu$ W as Logarithmic Function.			
dBV	Selects dBV as Logarithmic Function.			
dBW	Selects dBW as Logarithmic Function.			
DC	Selects DC Coupling for Oscilloscope, DEMOD Connector and optional BER Meter operation.			
DC ZERO	Zeroes reading to indicate 0 Vdc reading when selected Source is SCP/DVM DC.			
DCS	Selects DCS as Format type.			
DCS/	Selects Inverted DCS as Format type.			
DEC CLR	Clears the decoded are manually. Fresh data is now displayed and recognized.			
DECODE	Activates DECODE Function for specified Audio/Data type. Accesses Tone Decode Screen for USER Defined signaling format and initiates decoding function for DCS and DCS Inverted Functions.	Toggles message decoding ON and OFF. Pressing the softkey highlights the "DECODE" softkey. Messages continue to scroll through the screen until DECODE is pressed again.		
DEFAULT	Sets only the current field to factory default state for the current scan width.			
DEFLT	Sets the current Analyzer field to factory default.			
DELETE	Permanently deletes a file from the file system. There is no operation to recover a deleted file.			
Demod	Output to Demod Out Connector.			
Detect	Raw data detected.			
DET-OUT	Routes Detector signal to DEMOD Connector.			
DEV	Selects FM Deviation Meter as active meter.			
DISABLE	Disables Border Offset.	Disables the selected test.		
DISABLED	Disables automatic test condition.			
DISC	Disconnects a call to the Radio which was made previously using the CALL softkey.			
DISCN	Sets Status to DISCN (Disconnect Repeater-Mobile Link).			
DIST	Selects Distortion Meter as active meter.			
DTMF	Accesses DTMF Generator parameters.			
DVM	Accesses LTR Trunking Digital Voltmeter.			
EDACS	Accesses EDACS Trunking Option.			

FUNCTION	DESCRIPTION	
ENABLE	Enables Border Offset.	Enables the selected test.
ENABLED	Enables automatic test condition.	
ESCAPE	Returns to RF Receive Operation Screen without saving edits when Filter field(s) are edited and not executed.	
EXEC	Executes and validates all edits before returning to operation mode.	
EXT	Accesses External Modulation parameters.	
EXT MOD	Selects EXT MOD Connector as input source for meter.	
EXT MSG	When selected, messages are displayed in fully decoded MPT 1327/1343 field format. Messages with bad CRCs are not decoded.	
EXTERNAL	Saves data externally to a PCMCIA memory card.	
FCC	Displays FREE REP CHAN field. Frequencies are entered in terms of the FCC defined channel numbers.	
FILE	Prints to a file.	
FILES	Displays the Stored File List.	
FILL	Fills remainder of selected column with value of current cursor position.	
FILTERS	Displays the selected Filters softkey bar.	
Find	Activates Find Function which searches for first signal with level exceeding reference set by Find Lvl Function. Search band is twice Sweep Width, set by Config Function, centered around Center Frequency.	
Find Lvl	Activates horizontal marker for setting reference level of Find Function. Marker level is controlled by DATA SCROLL Keys or DATA SCROLL Spinner. Press Find Lvl again to exit mode.	
FIX	Repairs damage to the system (CHKDSK operation).	
FIXED	Selects Fixed Data Pattern type in optional BER Meter operation.	
FL	Accesses User Defined Frequency List.	
FM	Selects Frequency Modulation as Modulation type.	Selects Frequency Modulation as Demodulation type.
FM CAL	Offsets FM Detector to compensate for Transmitter Frequency Error in LTR Radio. Offsetting FM Detector "tunes" data decoder that decodes data from LTR Radio.	
FMZ	Calibrates FM Detector when dc coupled.	
FM-Z	Automatically calibrates FM Zero.	
FOLLOW	When selected, the COM-120C follows the RU specified by the PFI/IDENT fields after receiving go to traffic messages and automatically returns to the control channel on a CLEAR, and follow control channel MOVE. Has no effect during monitoring of an RU.	
FORCE	Forces the COM-120C to convert to the repeater even if the repeater does not sent the convert message. Toggles ON and OFF.	
FORMAT	Only available with PCMCIA selected. Formats the file system for use.	
FREE	Sets Status to FREE (Free Home Repeater).	

FUNCTION	DESCRIPTION	
FREQ	Displays the Stored RF Frequency List.	
GEN1	Accesses Audio Generator 1 parameters.	
GEN2	Accesses Audio Generator 2 parameters.	
Gnd	Ground coupled.	
GROUP	Group Call is selected and starts when softkey is pressed.	
GTC	When selected, all messages are filtered except GTCs. Useful for control loading.	
HEX MSG	When selected, messages are displayed with timestamp, basic MPT 1327 fields including message mnemonic, hex content and CRC, Messages with bad CRCs are decoded and may contain erred field values.	
HI CHAN	Displays parametric results for Highest Handoff Channel (HANDOFF test only).	
HOME	Selects simulated Home Registration.	
HP LJ	Configures printer output for an HP LASERJET Printer.	
HP TJ	Configures printer output for an HP THINKJET Printer.	
IDLE	Normal repeater operation for incoming speech/status calls.	
IDLE	Repeater is in the idle state, generating overhead (Site ID) messages. In this state, the Radio may initiate a Group Call, do a Login or the simulator may initiate a call to another radio.	
INDV	Individual Call is selected and starts when softkey is pressed.	
INFO	Accesses Customer Information Menu.	
INTERNAL	Selects internal file system.	Saves data internally in the COM-120C for later retrieval.
INT-MOD	Routes Audio signal from Internal Modulation sources as composite signal to Speaker and PHONES Connector.	
INVERT	The printed screen orientation is white background with black text. (see, BMP and PCX)	Inverts Decode/Encode Data.
INVERTED	Selects Inverted Data Polarity in optional BER Meter operation.	
KEY	Configures DATA ENTRY Keys as DTMF keypad. Code Field displays press key and DTMF Generator produces specified DTMF Code.	
LB	Selects Lower Sideband Demodulation.	
LIMITS	Accesses Parametric Limits screen.	
LIVE	Displays current signal without modification.	
LIVE-REF	The value of each point of the reference trace is subtracted from the current reading and the result is displayed. Requires a previously stored trace.	
LO CHAN	Displays parametric results for Lowest Handoff Channel (HANDOFF test only).	
LOAD	Accesses filing system Load screen.	

FUNCTION	DESCRIPTION		
LOCK	Sets frequency used for Generate, Receive and Spectrum Analyzer operation to same frequency as current RF Field. Change displays in all three operation screens when engaged.	Locks the Tracking Generator center frequency at a constant offset from the analyzer center frequency. Changing the analyzer center frequency changes the Tracking Generator center frequency by a like amount.	
LOOP	Selects Loop Run Mode in optional BER Meter operation.		
LTR	Accesses LTR Trunking Option.		
MANUAL	Accesses Manual Test screen.		
MAX	Displays Maximum Limit values only.		
MEAS-HI	Accesses the Parametric Measurements screen for the High Channel Handoff.		
MEAS-LO	Accesses the Parametric Measurements screen for the Low Channel Handoff.		
MENU	Displays pop up menu with multiple selections.		
MIC	Accesses MIC Modulation parameters.		
MIN	Displays Minimum Limit values only.		
MIN HOLD	Activates/deactivates Minimum Hold Oscilloscope Operation Mode.		
MOBILE	Initiates Manual Mobile Initiated Call Test.		
MOD MTR	Routes Modulation Meter signal to DEMOD Connector.		
MONITOR	Accesses Off-Air Monitor screen.		
MOVE	Moves a file from one directory to another. Enter a drive, directory and name to relocate the file. Move the file within the same drive or from one drive to another.	Moves the control channel to that displayed in the CCH# field and sets the RF frequencies accordingly.	
MPT1327	Accesses MPT1327 Trunking Option.		
mV	Sets Output level Units to mV.		
NAR 1	Selects Deviation Range, 12.75 to 25 kHz.		
NAR 2	Selects Deviation Range, 2 to 12.75 kHz.		
NAR 3	Selects Deviation Range, <2 kHz.		
NARROW	Sets System Band to Narrow (900 MHz).		
NETWORK	Accesses SETUP Network Definition screen.		
NO ACKS	When selected, all acknowledgement messages are filtered. Use in conjunction with NO ALH if required. (see, NO ALH)		
NO ALH	When selected, filter out ALHOA and BCAST messages.		
NORM	Selects Normalized Trigger type.	Selects Normal for +/- peak div by 2.	
NORMAL	The printed screen orientation is black background with white text. (see, BMP and PCX)	Selects Normal Data Polarity in optional BER Meter operation.	Sets Decode/Encode Data to normal.

FUNCTION	DESCRIPTION	
Normal	Sets Spectrum Analyzer to Normal single Center Frequency Operation. (see, Split)	
NUMERIC	Forces Decode Function to decode message as specified type.	
OFF	Deactivates High-Pass Filtering on DTMF/SINAD Line.	Turns Modulation Source OFF.
OFF/ON	Toggles features OFF and ON.	
ON/OFF	Toggles active function ON and OFF.	
OPEN	Opens the file Only files of type SYSTEM, MACRO, SETUP or TRACE may be OPEN'ed.	
PACK	Performs any needed packing on the file system.	
PAIR	Activates Pair Function which ties Duplex Generate and Receive RF Fields together as a pair with specified Frequency Offset. Editing Duplex Generate RF Field changes Duplex Receive Field. Editing Frequency Offset or Duplex Receive RF Field changes Duplex Generate RF Field.	
PCMCIA	Selects external file system.	Prints to a PCMCIA Modem or RS-232 card.
PG DN	Used to scroll down through a window list.	
PG DOWN	Pages down 12 files in the list.	
PG UP	Used to scroll up through a window list.	Pages up 12 files in the list.
PK HOLD	Activates/deactivates Peak Hold Oscilloscope Operation Mode.	
PM	Selects Phase Modulation as Modulation type.	Selects Phase Modulation as Demodulation type.
POCSAG	Selects POCSAG as Format type.	
POCSAG/	Selects Inverted POCSAG as Format type.	
PRGM	Puts the 'Band ' mode back to one of the channel modes: 800 MHz, 900 MHz or USER. The logical channels from the Setup Screen are then active. The simulator is taken out of the pre-programmed channel mode when the RF Frequencies are manually edited.	
PRINT	Saves the screen to a file or prints the screen according to the Print setup configuration.	
PRINTER	Allows printer configuration.	
PTT	Keys the COM-120C during a call. PTT remains highlighted until PTT is released by pressing the softkey again or the call is cleared.	
PTT OUT	Asserts the PTT Out line of the MIC Connector. This is useful for forcing a directly connected RU to key up.	
QUEUED	Simulates call Queuing for incoming speech/status calls.	
RAD	Switch to decoding messages from the RU. The receiver frequency is adjusted automatically.	
RAD SIM	Accesses EDACS or MPT 1327 Radio Unit Simulator screen.	
RADIO	Accesses LTR Trunking Option Radio Simulation.	

FUNCTION	DESCRIPTION	
RAMP	Selects Ramp as active Wave Shape.	
RANDOM	Selects Random Data Pattern type in optional BER Meter operation.	
RD ONLY	Sets or clears Read Only attribute to a file to prevent the file from being deleted or changed.	
RECALL	Displays stored trace only.	
REF-LIVE	The value of current reading is subtracted from the stored value and the result is displayed. Requires a previously stored trace.	
REG	Initiates Manual Registration Test.	
REGISTN	Forces RU selected by PFIX/IDENT to Register and interrogates the ESN.	
REP	Switch to decoding messages from the repeater. The receiver frequency is automatically adjusted.	
REP SIM	Accesses EDACS or MPT 1327 Repeater Simulator screen.	
REPEAT	Accesses LTR Trunking Option Repeater Simulation.	
RESET	Resets the current field to zero.	
RESTORE	Finalizes Recall Operation.	
RESULTS	Pages through automatic test results.	
RESUME	Restarts Sweep Function.	Returns the COM-120C to normal operation.
RETURN	Exits an application or window and returns to normal operation.	
RE-ZERO	Sets RF Power Meter to 0 mW referenced to current input at T/R Connector.	
RF GEN	Selects RF Generator as BER Meter source.	
RF POW	Selects RF Power Meter input line s input source for meter.	
RF REC	Selects RF Receiver (either T/R or ANT) as BER Meter input.	
ROAM	Selects simulated Roam Registration.	
ROLL	Views the scope trace in a roll mode when selected sweep rate is 100 ms/div or higher.	
RS-232	Prints via RS-232 Connector on the COM-120C rear panel.	
RST PK	Resets Peak Readings displayed to 0.	
S=On/Off	Toggles SINAD Function ON and OFF.	
SAVE	Finalizes Storage Operation.	
SCAN	Accesses Scan pop up window for setting Scan Function parameters. Scans specified frequencies on Frequency List.	
SCOPE	Displays abbreviated Scope.	
SCP/DVM	Selects SCOPE/DVM Connector as input source for meter.	
SCROLL	Toggles Scroll Function ON and OFF. Highlighted when SCROLL is active.	
SDM	Sends a textual (SDM2) message to the RU selected by PFIX/IDENT.	

FUNCTION	DESCRIPTION		
SEARCH	Performs SINAD search operation.		
SET LVL	Accesses procedure for setting reference for measuring input level at current frequency.		
Set Ref	Adjusts Spectrum Analyzer to internal reference level at current frequency. Initiate function at each new frequency to achieve maximum accuracy.		
SET REF	Changes frequency in current RF Field to reference frequency. "R" displays when active.		
SETUP	Accesses LTR Trunking Option Auxiliary Setup.	Accesses Setup screen.	Accesses Network Definition Configuration screen.
SETUPS	Displays the Stored Test Setups.		
SINAD	Selects SINAD Meter as active meter.		
SINAD=	Access field to set SINAD Search Function Value.		
SINE	Selects Sine as active Wave Shape.		
SINGLE	Activates Sweep Function for one pass through frequency range.		
SKIP	Skips the current test.		
SLOW	Returns to normal mode of operation following a ROLL execution. (see ROLL)		
SPEECH	Attempts to set up a Speech Call with RU selected by PFIX/IDENT,		
SPKR	Selects Speaker/Headphones as current Filter Line.		
Split	Accesses Split Screen Function. Split Screen Spectrum Analyzer allows two Center Frequencies.		
SQUARE	Selects Square as active Wave Shape.		
START	Activates a function.	Starts an Automatic Test.	
STATUS	Sends a Status (SDM1) message to the RU selected by PFIX/IDENT.		
STOP	Stops an activated function.		
STORE	Stores the current trace.		
SUMMARY	Toggles between PFIX/IDENT display and GTC/ACKQ summary statistics.		
Swap	Interchanges Analyzer displays. (see, Split)		
SWEEP	Accesses menu to configure RF Generator to sweep specified frequency range. Sweep Prompt displays when active.		
SYS ALL	System-All Call is selected and starts when softkey is pressed.		
T/R	Selects T/R as RF output/input Connector. Indicator lights up.		
T/R Gate	Selects T/R as output connector. Indicator lights up. Only active when microphone is keyed.		
T-Fwd	Accesses Trunking-Forward Channel List.		
TIME	Accesses window for setting BURST Function duration. Duration ranges from 0 to 30 seconds.		
TRIANGLE	Selects Triangle as active Wave Shape.		



FUNCTION	DESCRIPTION	
T-Rvs	Accesses Trunking-Reverse Channel List.	
UB	Selects Upper Sideband Demodulation.	
UNIDIR	Sets Unidirectional Print Mode.	
UNLOCK	Disengages LOCK Function. (see LOCK)	
UNPAIR	Deactivates Pair Function. (see, PAIR)	
USER	Allows User Defined frequency.	Displays FREE REP RCV: and GEN: fields. Position the cursor on RCV: or GEN: to edit the frequency. Directly enter frequencies from 0 to 1 GHz.
uV	Sets Output Level Units to $\mu$ V.	Toggles value setting.
V	Sets Output Level Units to V.	
VOICE	Selects Voice Deviation measurement.	
Vrms	Selects Vrms for Reading Units.	
W.B.	Routes Audio signal from AUDIO/DATA IN Connector to Speaker and PHONES Connector without filtering.	
WIDE	Sets System Band to Wide (800 MHz).	
WIDE	Selects Deviation Range, >25 kHz.	
x1	Alters the scaling factor for the baseband level.	
X1	Activates X1 Mode for Level.	
ZOOM	Expands current meter to full size.	

# INDEX

ØM Meter (specifications)	1-17	Data Generator/Bit Error Rate Meter (Option 07)	6-2
30 kHz IF Filter (Option 03)	6-1	Data Generator Operation	4-67
<b>A</b>			
Abbreviations	B-1	DC Fuse Replacement	Page-2
Accessing The Clearchannel LTR Trunking Test System	6-22	Decoding Digital Signaling Formats	6-16
AC Fuse Replacement	Page-1	Decoding 2-Tone Sequential Format	5-26
AF Frequency Counter (specifications)	1-16	Digital Voltmeter Operation	4-69
AM Modulation Meter Operation	4-41	Digital Voltmeter (specifications)	1-20
AM Modulation Meter (specifications)	1-18	Distortion Meter (specifications)	1-19
AMPS Cell Site Simulator Automatic Tests	6-52	Distortion Meter Operation	4-16, 4-38, 4-53
AMPS Cell Site Simulator Main & Setup Menus	6-47	DTMF Generator Operation	4-68
AMPS Cell Site Simulator Manual Tests	6-62	Duplex	5-28
AMPS Cell Site Simulator Setup	6-46	Duplex Operation	1-4, 4-54
AMPS Cellular Testing (Option 15)	6-46	Duplex Screen	3-17
Applying AC Power	2-3	<b>E</b>	
Applying External DC Power	2-3	EDACS High-Speed Data Capture (scope)	6-93
Audio/Data Generators (specifications)	1-13	EDACS Store and Recall	6-94
Audio/Data/Signaling Generators Screen	3-24	EDACS Trunking (Option 16)	6-70
Audio/Digital Signaling Formats (Option 11)	6-10	EDACS Trunking Automatic Test	6-73
Audio Frequency Counter	4-51	EDACS Trunking Automatic Test Execution	6-74
Audio Frequency Level Meter Operation	4-18	Radio Test	6-74
Audio Function Generators	1-5	Registration	6-74
Audio Generator-1 Operation	4-63	Repeater Test	6-75
Audio Generator-2 Operation	4-66	EDACS Trunking Automatic Test Results	6-76
Audio Test	6-58	EDACS Trunking Channel Assignments	6-72
Automatic Test Mode, Test Selection	6-108	EDACS Trunking Manual Test	6-82
Automatic Test Printout	6-61	EDACS Trunking Manual Test- Radio Simulator	6-88
Auxiliary Setup Screen Configuration	6-37	EDACS Trunking Manual Test- Repeater Simulator	6-83
<b>B</b>			
Base Frequencies	6-101	EDACS Trunking Operational Notes	6-95
Battery Fuse Replacement	Page-4	EDACS Trunking Setup Screen	6-71
Battery Power Operation (Option 01)	2-3	Editing Fields Using Data Scroll Keys and Spinner	3-9
Battery Replacement	Page-2	Editing Numeric Data Fields	3-11
BER Meter Configuration Section	6-4	Encoding 2-Tone Sequential Format	5-16
<b>C</b>			
Cell Init Test	6-60, 6-67	Encoding Digital Signaling Formats For Audio Signal	6-15
Channel Numbering	6-100	Escaping From Edit Without Change	3-11
Clearchannel LTR (Option 14)	6-21	<b>F</b>	
General	6-21	FM Deviation Meter Operation	4-39
COM-120C Product Specifications	1-11	Frequency Modulation Meter (specifications)	1-17
Cursor Movement	3-9	Front Panel Controls	3-1
		Fuse Requirements (specifications)	1-23

**G**

General Characteristics (specifications)	1-23
General Duplex Generate Operation	4-54
General Duplex Receive Operation	4-59
General (introduction)	1-1
General (installation)	2-1
General RF Generate Operation	4-1
General RF Receive Operation	4-31
Generate Amplifier (Option 05)	6-1
Generating AM Modulated RF Signal	5-4
Generating DCS Coded RF Signal	5-8
Generating DTMF Coded RF Signal	5-10
Generating FM Modulated RF Signal	5-2
Generating Microphone Modulated RF Signal	5-14
Generating PM Modulated RF Signal	5-6
Generating RF Signal Using External Modulation	5-12

**H**

Handoff Test	6-57
--------------	------

**I**

Independent Audio/Data Signaling Generators	4-63
Independent Oscilloscope Operation	4-62
Independent Spectrum Analyzer Operation	4-62
IEEE 488 (GPIB) Interface (Option 13)	6-20
Configuring For Remote Operations w/GPIB	6-20
General	6-20
Input/Output Connectors (specifications)	1-22
Internal Battery (Option 01)	6-1

**L**

LTR Radio Handoff Test	6-41
LTR Radio Handshake Test	6-40
LTR Radio Receive Test	6-42
LTR Repeater Handshake Test	6-45
LTR Trunking Auxiliary Setup Screen	6-35
LTR Trunking Radio Simulation	6-29
LTR Trunking Repeater Simulation	6-23

**M**

Making Selections From Menus	3-11
Master Oscillator (specifications)	1-22
Memory Lists and Storage of Parameters	3-26
Meters	1-9
Meters Operation	4-69
Meter Screens	3-25
Mobile Init Test	6-59, 6-64
Modulating RF Signals w/Digital	
Signaling Formats	6-13
Modulation (specifications)	1-12
MPT1327/MPT1343 Numbering Schemes	6-106
MPT1327 Trunking (Option 17)	6-96

**O**

Off-Air Monitor	6-114
Options	1-10
Oscilloscope	1-6
Oscilloscope Operation Screen	4-20, 4-53
Oscilloscope (specifications)	1-20
Oscilloscope Screen	3-20
Oven Crystal Oscillator Frequency Standard	
(Option 02)	6-1

**P**

Parametric Limits	6-110
Parametric Results	6-113
Phase Modulation Meter Operation	4-43
Power Requirements (specifications)	1-22
Power Source Requirement	Page-1
Power Up Procedures	2-3
Precautions (installation)	2-1

**R**

Radio Simulator	6-107
Radio Simulator Operation	6-43
RCC Signaling Formats (Option 09)	6-10
Rear Panel Controls	3-7
Receiver (specifications)	1-15
Receive Data Configuration Section	6-6
Received Level Meter Operation	4-47
Receive Level Meter (specifications)	1-19
Receive Trunking Data Block	6-28, 6-34
Receiving AM Modulated RF Signal	5-22
Receiving FM Modulated RF Signal	5-20
Receiving PM Modulated RF Signal	5-24
Registration Test	6-53, 6-63
Repacking For Shipping	C-1
Repeater Simulator	6-104
Repeater Simulator Operation	6-38
RF Frequency Error Meter Operation	4-49
RF Frequency Error Meter (specifications)	1-16
RF Generate	5-1
RF Generate Operation	1-2, 4-1
RF Generate Screen	3-12
RF Power Meter Operation	4-45
RF Power Meter (specifications)	1-18
RF Receive	5-19
RF Receive Operation	1-3, 4-31
RF Receive Screen	3-14
RF Signal Generator (specifications)	1-11

**S**

Safety Conditions (specifications)	1-23
Screens, Soft Function Keys and Menus	3-9
Selective RF Counter (specifications)	1-16
Send Data Configuration Section	6-8
Setup Network Definition	6-97
Single Sideband Receive Filter (Option 08)	6-9
Description	6-9
General	6-9
SINAD Meter (specifications)	1-19
SINAD Meter Operation	4-13, 4-38
Soft Function Keys	3-9, D-1
Spectrum Analyzer	1-7
Spectrum Analyzer Operation Screen	4-25
Spectrum Analyzer Screen	3-22
Spectrum Analyzer (specifications)	1-21
Spectrum Analyzer Tracking	
Generator (Option 12)	6-19
Store and Recall Operation	4-29, 4-53
Syscode Calculation	6-99

**T**

Test Execution	6-112
Testing A Receiver Using Digital	
Signaling Formats	6-17
Testing A Transmitter Using Digital	
Signaling Formats	6-17
Testing Radio Units	6-105
Transmit Trunking Data Block	6-27, 6-33
Trunking Simulator Screens	6-102

**U**

Utility Function Screens	3-27
User I/O Connectors & Pin-Out Table	A-1

**V**

Variable Audio Generator 2 (Option 04)	6-1
--	-----

THIS PAGE INTENTIONALLY LEFT BLANK.

# **USER REPLACEABLE BATTERY AND FUSES**

## **BATTERY/VOLTAGE/FUSE INSTRUCTIONS**

THIS PAGE INTENTIONALLY LEFT BLANK.

# **WARNING:**

## **HIGH VOLTAGE EQUIPMENT**

**THIS EQUIPMENT CONTAINS CERTAIN CIRCUITS AND/OR COMPONENTS OF EXTREMELY HIGH VOLTAGE POTENTIALS, CAPABLE OF CAUSING SERIOUS BODILY INJURY OR DEATH. WHEN PERFORMING ANY OF THE PROCEDURES CONTAINED IN THIS MANUAL, HEED ALL APPLICABLE SAFETY PRECAUTIONS.**

### **SAFETY FIRST: TO ALL SERVICE PERSONNEL**

**REFER ALL SERVICING OF UNIT TO QUALIFIED TECHNICAL PERSONNEL.**

**WARNING: USING THIS EQUIPMENT IN A MANNER NOT SPECIFIED BY THE ACCOMPANYING DOCUMENTATION MAY IMPAIR THE SAFETY PROTECTION PROVIDED BY THE EQUIPMENT.**

#### **CASE, COVER OR PANEL REMOVAL**

Removing the Chassis Assembly from the Case Assembly exposes the technician to electrical hazards that can result in electrical shock or equipment damage.

#### **SAFETY IDENTIFICATION IN TECHNICAL MANUAL**

This manual uses the following terms to draw attention to possible safety hazards, that may exist when operating or servicing this equipment.

**CAUTION:** THIS TERM IDENTIFIES CONDITIONS OR ACTIVITIES THAT, IF IGNORED, CAN RESULT IN EQUIPMENT OR PROPERTY DAMAGE (E.G., FIRE).

**WARNING:** THIS TERM IDENTIFIES CONDITIONS OR ACTIVITIES THAT, IF IGNORED, CAN RESULT IN PERSONAL INJURY OR DEATH.

#### **SAFETY SYMBOLS IN MANUALS AND ON UNITS**



**CAUTION:** Refer to accompanying documents.



**AC OR DC TERMINAL:** Terminal that may supply or be supplied with ac or dc voltage.



**DC TERMINAL:** Terminal that may supply or be supplied with dc voltage.



**AC TERMINAL:** Terminal that may supply or be supplied with ac or alternating voltage.



**SWITCH OFF:** AC line power to the device is OFF.



**SWITCH ON:** AC line power to the device is ON.



**DANGEROUS VOLTAGE:** Indicates electrical shock hazard due to high voltage levels.

#### **EQUIPMENT GROUNDING PRECAUTION**

Improper grounding of equipment can result in electrical shock.

#### **USE OF PROBES**

Check specifications for the maximum voltage, current and power ratings of any connector on the Test Set before connecting it with a probe from a terminal device. Be sure the terminal device performs within these specifications before using it for measurement, to prevent electrical shock or damage to the equipment.

#### **POWER CORDS**

Power cords must not be frayed, broken nor expose bare wiring when operating this equipment.



**USE RECOMMENDED FUSES ONLY**

Use only fuses specifically recommended for the equipment at the specified current and voltage ratings.

**WARNING: THE COM-120C USES A SEALED LEAD-ACID-BATTERY PACK. THE FOLLOWING WARNINGS CONCERNING LEAD-ACID BATTERIES MUST BE HEEDED:**

- **DO NOT RECHARGE OUTSIDE THE COM-120C.**
- **DO NOT CRUSH, INCINERATE OR DISPOSE OF IN NORMAL WASTE.**
- **DO NOT SHORT CIRCUIT OR FORCE DISCHARGE AS THIS MIGHT CAUSE THE BATTERY TO VENT, OVERHEAT OR EXPLODE.**

**CAUTION:** INTEGRATED CIRCUITS AND SOLID STATE DEVICES SUCH AS MOS FETS, ESPECIALLY CMOS TYPES, ARE SUSCEPTIBLE TO DAMAGE BY ELECTROSTATIC DISCHARGES RECEIVED FROM IMPROPER HANDLING, THE USE OF UNGROUNDED TOOLS AND IMPROPER STORAGE AND PACKAGING. ANY MAINTENANCE TO THIS UNIT MUST BE PERFORMED WITH THE FOLLOWING PRECAUTIONS:

- BEFORE USE IN A CIRCUIT, KEEP ALL LEADS SHORTED TOGETHER EITHER BY THE USE OF VENDOR-SUPPLIED SHORTING SPRINGS OR BY INSERTING LEADS INTO A CONDUCTIVE MATERIAL.
- WHEN REMOVING DEVICES FROM THEIR CONTAINERS, GROUND THE HAND BEING USED WITH A CONDUCTIVE WRISTBAND.
- TIPS OF SOLDERING IRONS AND/OR ANY TOOLS USED MUST BE GROUNDED.
- DEVICES MUST NEVER BE INSERTED INTO NOR REMOVED FROM CIRCUITS WITH POWER ON.
- PC BOARDS, WHEN TAKEN OUT OF THE SET, MUST BE LAID ON A GROUNDED CONDUCTIVE MAT OR STORED IN A CONDUCTIVE STORAGE BAG. REMOVE ANY BUILT-IN POWER SOURCE, SUCH AS A BATTERY, BEFORE LAYING PC BOARDS ON A CONDUCTIVE MAT OR STORING IN A CONDUCTIVE BAG.
- PC BOARDS, IF BEING SHIPPED TO THE FACTORY FOR REPAIR, MUST BE PACKAGED IN A CONDUCTIVE BAG AND PLACED IN A WELL-CUSHIONED SHIPPING CONTAINER.

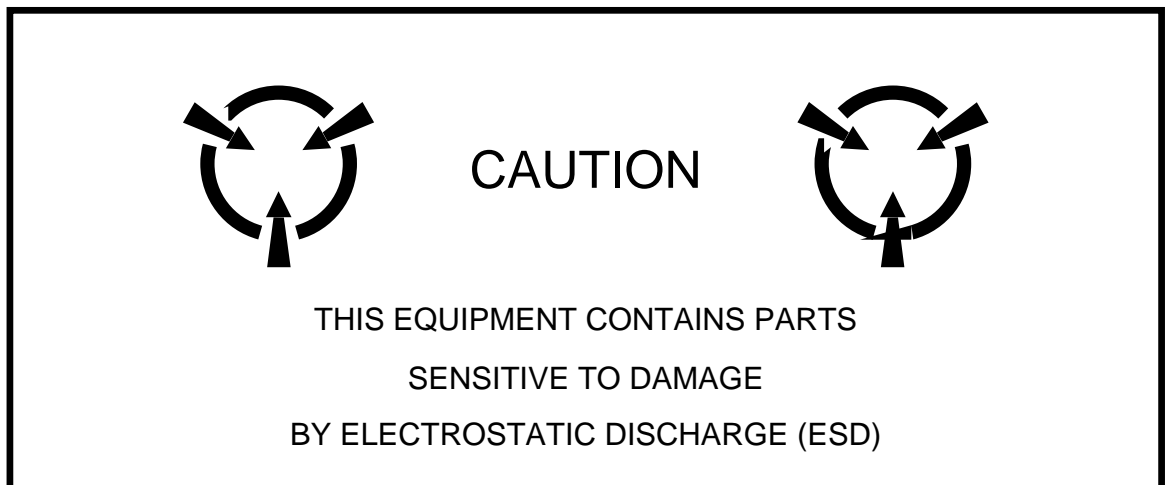

**CAUTION:** SIGNAL GENERATORS CAN BE A SOURCE OF ELECTROMAGNETIC INTERFERENCE (EMI) TO COMMUNICATION RECEIVERS. SOME TRANSMITTED SIGNALS CAN CAUSE DISRUPTION AND INTERFERENCE TO COMMUNICATION SERVICES OUT TO A DISTANCE OF SEVERAL MILES. USERS OF THIS EQUIPMENT SHOULD SCRUTINIZE ANY OPERATION THAT RESULTS IN RADIATION OF A SIGNAL (DIRECTLY OR INDIRECTLY) AND ENSURE COMPLIANCE WITH INSTRUCTIONS IN FAA CIRCULAR AC 170-6C, DATED FEBRUARY 19, 1981.

## POWER SOURCE REQUIREMENT

The Internal Battery, if installed, charges automatically whenever the COM-120C is connected to a power source and the Main Power Switch is set to ON.

The Power Supply is designed to sense applied voltage and automatically compensate with no further actions required.

**NOTE:** Fans may operate when unit is OFF but plugged in or Internal Battery installed.

## AC FUSE REPLACEMENT

- o Disconnect ac power from COM-120C.
- o Depress clip on underside of AC FUSE Holder and pull straight out.
- o Remove AC FUSE Holder and remove fuse.

Insure proper fuse is installed in AC FUSE Holder.

Fuses provided include two 3.0 A, 250 V, Type F, 5 X 20 mm fuses for ac operation.

- o Replace fuse and reinstall AC FUSE Holder.

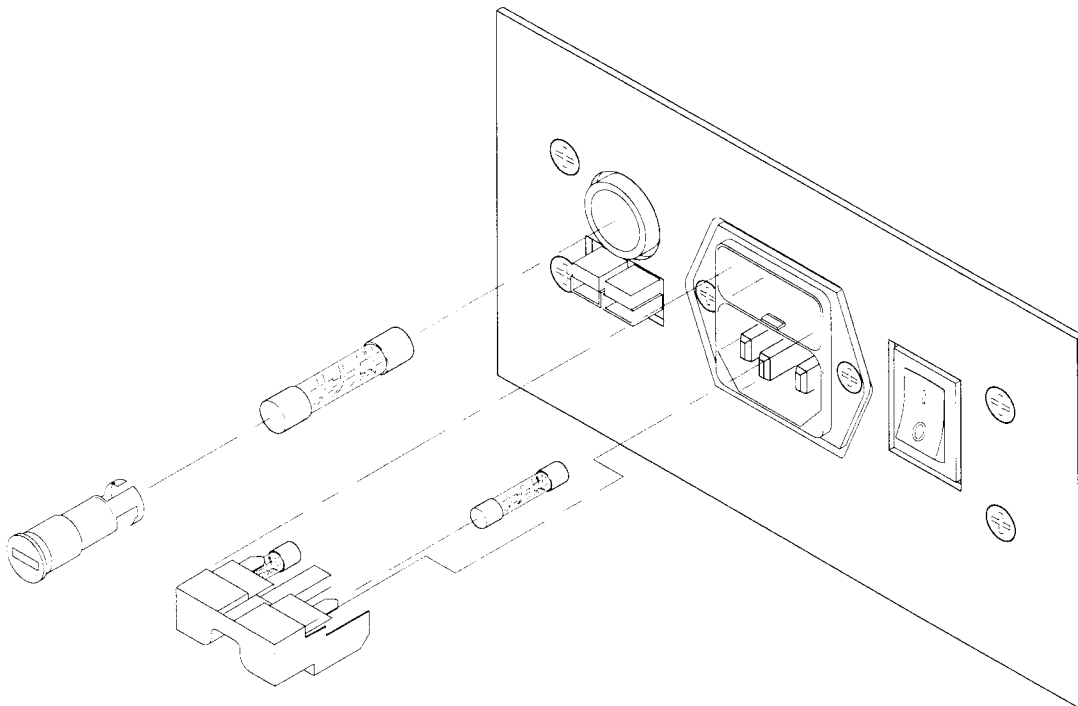

00607264

COM-120C AC & DC Fuse Location

## DC FUSE REPLACEMENT

- o Disconnect all external power connections.
- o Use a slotted tool to depress DC FUSE Holder (1) and turn counter clockwise.
- o Remove DC FUSE Holder and remove fuse.

Insure proper fuse is installed in DC FUSE Holder.

Fuse provided:

10 A, 32 V, Type F, AGC fuse for dc operation.

- o Replace fuse and reinstall DC FUSE Holder.

## BATTERY REPLACEMENT

The following procedure should be followed when replacing the battery.

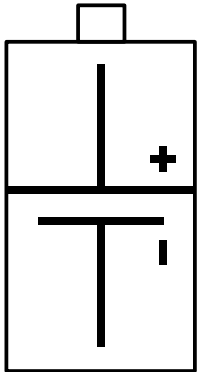

### WARNING:

**THE BATTERY USED IS A SEALED LEAD-ACID BATTERY PACK. THE FOLLOWING WARNINGS CONCERNING LEAD-ACID BATTERIES MUST BE HEEDED.**

**DO NOT CRUSH, INCINERATE OR DISPOSE OF IN NORMAL WASTE. PROPER DISPOSAL FOR DISCARD OF BATTERY IS REQUIRED. REFER TO APPROPRIATE STATE AND LOCAL REGULATIONS FOR INSTRUCTIONS AS TO PROPER DISPOSITION OF DISCARDED BATTERIES.**

**DO NOT RECHARGE OUTSIDE THE COM-120C.**

**DO NOT SHORT CIRCUIT OR FORCE DISCHARGE AS THIS MIGHT CAUSE THE BATTERY TO VENT, OVERHEAT OR EXPLODE.**



**CAUTION:**

REPLACE BATTERY WITH IFR PART NUMBER 4000-0000-011 BATTERY ONLY.



**CAUTION:**

DO NOT USE OR CONNECT A NON-RECHARGEABLE BATTERY TO THE TERMINALS. DANGER OF OVERHEAT OR FIRE.

**NOTE:** Option 01 required for battery operation.

Internal Battery, if installed, charges automatically whenever unit is connected to a power source and Main Power Switch is set to ON.

- o Set COM-120C Main Power Switch to OFF ("0" on switch).
- o Remove all power sources and disconnect all measuring terminals from COM-120C.
- o Loosen 4 Screws on Battery Access Panel. Remove Battery Access Panel.
- o Disconnect Positive (+) and Negative (-) Terminals from battery.
- o Remove Battery from cavity.
- o Install replacement battery in cavity.
- o Connect Positive (+) and Negative (-) Terminals to replacement battery. Install Battery Access Panel.

**NOTE:** For continued EMC compliance with EN61000-3-2:1995/A14:2000, always allow a discharged battery to recharge in Stand-by Mode.

## BATTERY FUSE REPLACEMENT

The following procedure should be followed when replacing the battery fuse.

- o Set COM-120C Main Power Switch to OFF.
- o Remove all power sources from COM-120C.
- o Loosen 4 screws on Battery Access Panel.
- o Remove Battery Access Panel.
- o Disconnect Positive (+) and Negative (-) Terminals from battery.
- o Remove Battery from cavity.
- o Pull Battery cable out of COM-120C until Battery Fuseholder is exposed.
- o Unscrew Battery Cable Fuseholder cap and remove fuse.
- o Replace fuse with 10 A, 32 V, Type F, AGC fuse.
- o Feed Battery Cable into Chassis.
- o Install Battery in cavity.
- o Connect Positive (+) and Negative (-) Terminals to Battery. Install Battery Access Panel.

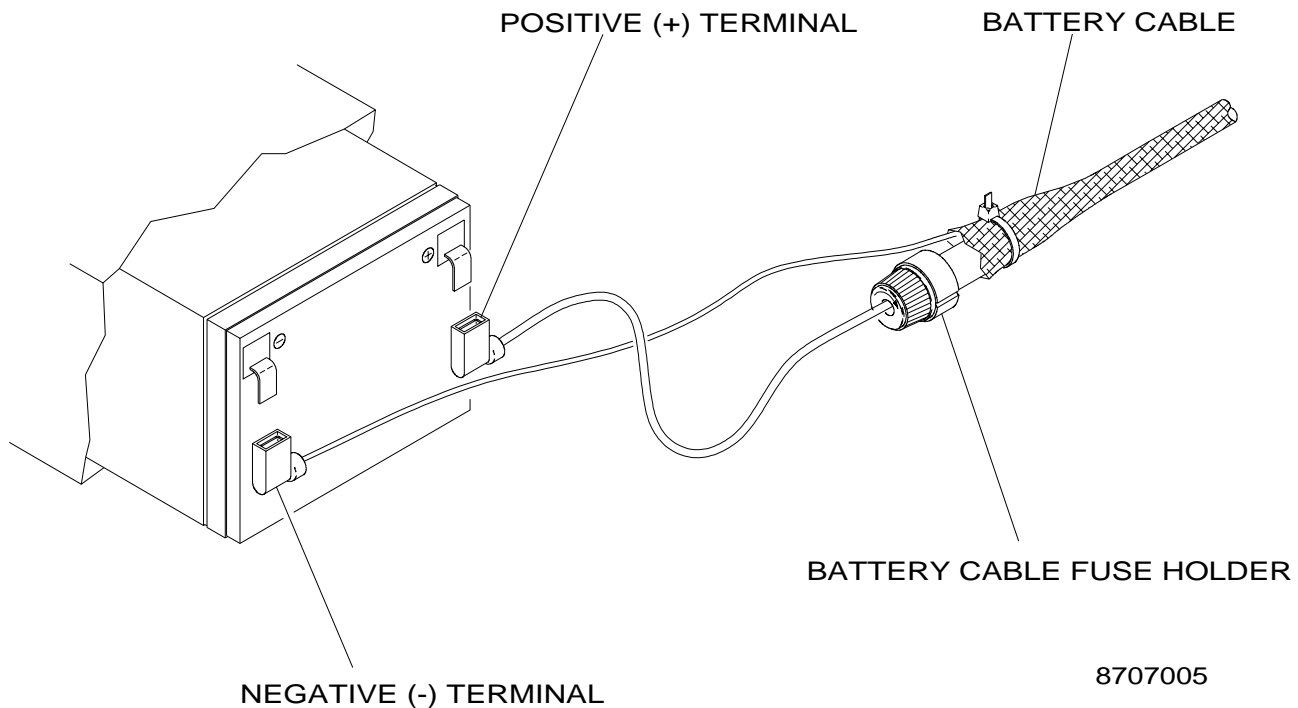

COM-120C Battery and Battery Cable

**CHINA**

Tel: [+86] (10) 6467 2716

Fax: [+86] (10) 6467 2821

**EUROPE NORTH**

Tel: [+44] (1438) 742200

Fax: [+44] (1438) 727601

**EUROPE SOUTH**

Tel: [+44] (1438) 742200

Fax: [+44] (1438) 727601

**FRANCE**

Tel: [+33] 1 60 79 96 00

Fax: [+33] 1 60 77 69 22

**GERMANY**

Tel: [+49] (8131) 29260

Fax: [+49] (8131) 2926130

**HONG KONG**

Tel: [+852] 2832 7988

Fax: [+852] 2834 5364

**LATIN AMERICA**

Tel: [+1] (972) 899 5150

Fax: [+1] (972) 899 5154

**SCANDINAVIA**

Tel: [+45] 9614 0045

Fax: [+45] 9614 0047

**SPAIN**

Tel: [+34] (91) 640 11 34

Fax: [+34] (91) 640 06 40

**UNITED KINGDOM**

Tel: [+44] (1438) 742200 (Stevenage)

[+44] (1703) 273722 (Chandlers Ford)

Freephone: [+44] (0800) 282 388 (UK only)

Fax: [+44] (1438) 727601 (Stevenage)

[+44] (1703) 254015 (Chandlers Ford)

**USA**

Tel: [+1] (316) 522 4981

Toll Free: [+1] (800) 835 2352 (US only)

Fax: [+1] (316) 522 1360

Parent company IFR Systems, Inc. © IFR 2002

*As we are always seeking to improve our products, the information in this document gives only a general indication of the product capacity, performance and suitability, none of which shall form part of any contract. We reserve the right to make design changes without notice.*

Web [www.ifrsys.com](http://www.ifrsys.com)Email [info@ifrsys.com](mailto:info@ifrsys.com)