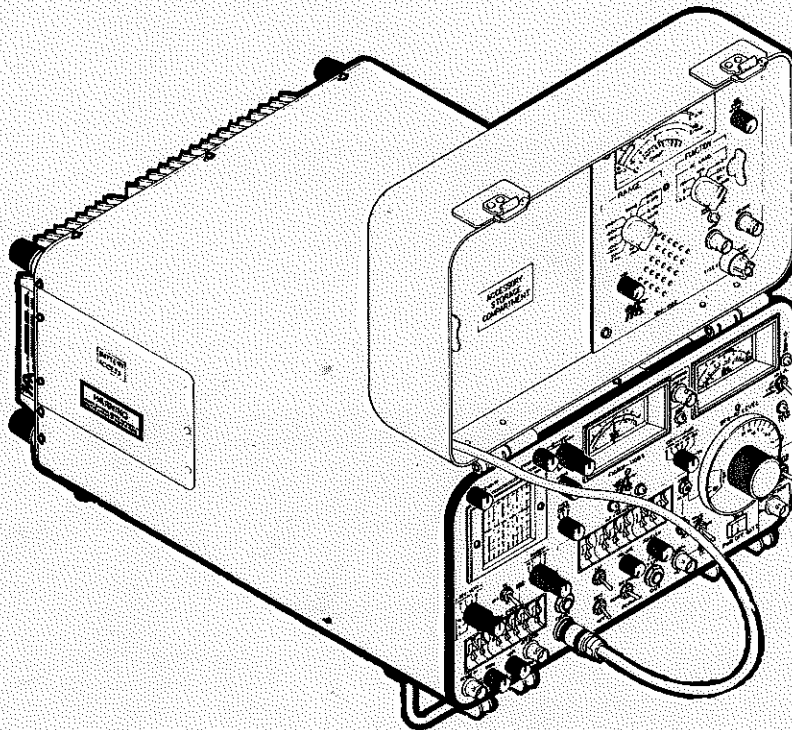


A20

TM-11-6625-3016-10-1

OPERATOR'S MANUAL



RADIO TEST SET AN/GRM-114A

(NSN 6625-01-144-4481)

**HEADQUARTERS, DEPARTMENT OF THE ARMY
20 JUNE 1983**

This copy is a reprint which includes current pages from Changes 1 and 2.

TABLE OF CONTENTS
PAGE I

EQUIPMENT DESCRIPTION
PAGE 1-4

OPERATING INSTRUCTIONS
PAGE 2-1

PREVENTIVE MAINTENANCE
PAGE 2-15

DETAILED OPERATING
INSTRUCTIONS
PAGE 2-19

MAINTENANCE PROCEDURES
PAGE 3-1

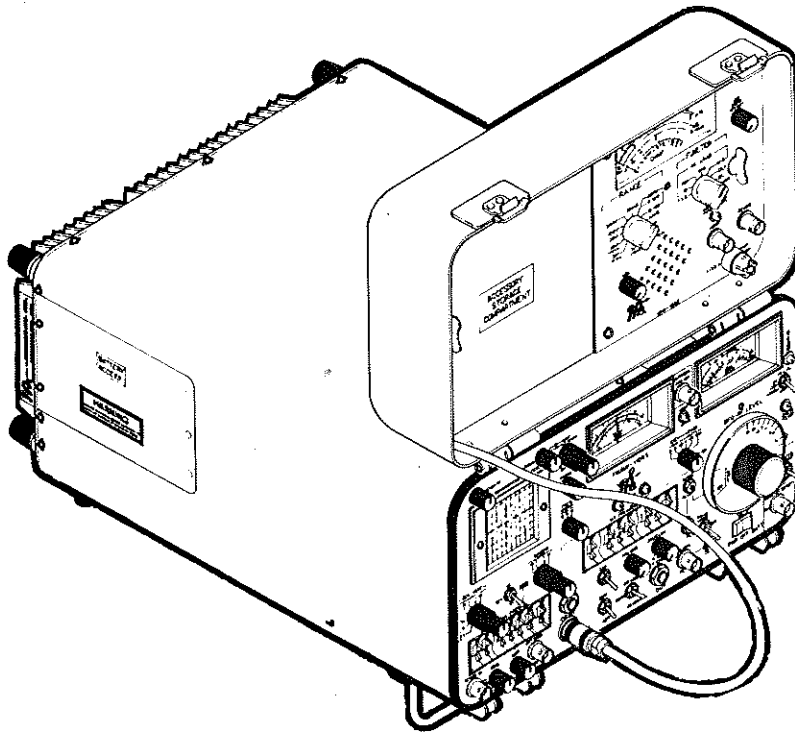
**5****SAFETY STEPS TO FOLLOW IF SOMEONE
IS THE VICTIM OF ELECTRICAL SHOCK****1****DO NOT TRY TO PULL OR GRAB THE INDIVIDUAL****2****IF POSSIBLE, TURN OFF THE ELECTRICAL POWER****3****IF YOU CANNOT TURN OFF ELECTRICAL
POWER, PULL, PUSH, OR LIFT THE PERSON TO
SAFETY USING A WOODEN POLE OR A ROPE
OR SOME OTHER INSULATING MATERIAL****4****SEND FOR HELP AS SOON AS POSSIBLE****5****AFTER THE INJURED PERSON IS FREE OF CONTACT
WITH THE SOURCE OF ELECTRICAL SHOCK, MOVE
THE PERSON A SHORT DISTANCE AWAY AND
IMMEDIATELY START ARTIFICIAL RESUSCITATION**

A20

TM-11-6625-3016-10-1

TABLE OF CONTENTS
PAGE 1

OPERATOR'S MANUAL



EQUIPMENT DESCRIPTION
PAGE 1-4

OPERATING INSTRUCTIONS
PAGE 2-1

PREVENTIVE MAINTENANCE
PAGE 2-15

DETAILED OPERATING
INSTRUCTIONS
PAGE 2-19

RADIO TEST SET AN/GRM-114A

(NSN 6625-01-144-4481)

MAINTENANCE PROCEDURES
PAGE 3-1

**HEADQUARTERS, DEPARTMENT OF THE ARMY
20 JUNE 1983**

This copy is a reprint which includes current
pages from Changes 1 and 2.

By Order of the Secretary of the Army:

CARL E. VUONO
General, United States Army
Chief of Staff

Official:

WILLIAM J. MEEHAN II
Brigadier General, United States Army
The Adjutant General

DISTRIBUTION:

To be distributed in accordance with DA Form 12-36 Operator requirements for AN/GRM-114,A.

CHANGE }
No. 1 }

HEADQUARTERS
DEPARTMENT OF THE ARMY
Washington, DC, 5 March 1985

OPERATOR'S MANUAL
RADIO TEST SET
AN/GRM-114A
(NSN 6625-01-144-4481)

TM 11-6625-3016-10-1, 20 June 1983, is changed as follows:

1. Remove old pages and insert new pages as indicated below. New or changed material is indicated by a vertical bar in the margin of the page.

Remove

i and ii
1-1 through 1-4
2-15 and 2-16
2-33 and 2-34
2-45 and 2-46
A-1/(A-2 blank)
C-1/(C-2 blank)

Insert

i and ii
1-1 through 1-4
2-15 and 2-16
2-33 and 2-34
2-45 and 2-46
A-1/A-2 blank)
C-1/C-2 blank)

2. File this change sheet in front of the publication for reference purposes.

By Order of the Secretary of the Army:

Official:

JOHN A. WICKHAM JR.
General, United States Army
Chief of Staff

DONALD J. DELANDRO
Brigadier General, United States Army
The Adjutant General

DISTRIBUTION:

To be distributed in accordance with DA Form 12-51 literature requirements for AN/VRC-12.

WARNING

HIGH VOLTAGE
IS USED IN THE EQUIPMENT.
DEATH ON CONTACT
MAY RESULT IF SAFETY PRECAUTIONS
ARE NOT OBSERVED.

Maintenance adjustments of this equipment are made with power applied. Be careful when working near the AC power input on rear panel.

DON'T TAKE CHANCES!

DANGEROUS DC VOLTAGES, UP TO 2,000 V, MAY EXIST WITHIN THE AN/GRM-114A WHILE THE UNIT IS OPERATING. AVOID SHOCK HAZARDS.

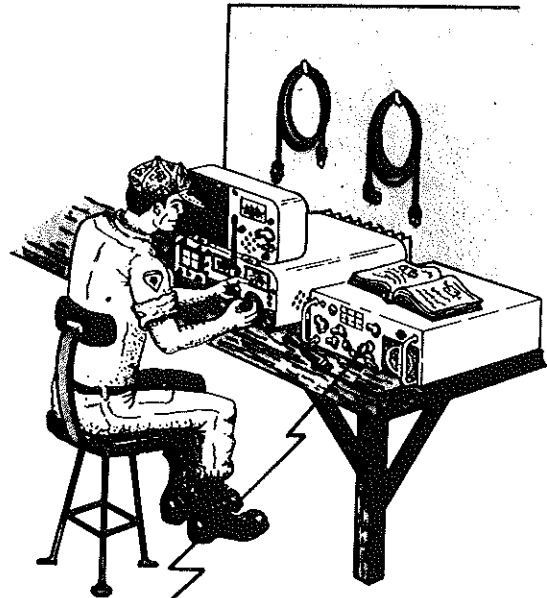
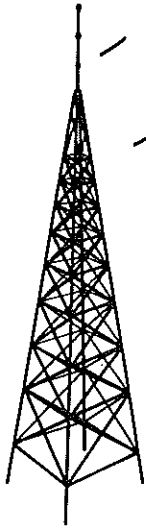
Two people are required to lift and/or carry the AN/GRM-114A.

DO NOT SERVICE OR ADJUST ALONE.

DO NOT ATTEMPT INTERNAL SERVICE OR ADJUSTMENTS UNLESS ANOTHER PERSON, CAPABLE OF RENDERING FIRST AID AND RESUSCITATION IS PRESENT.

OTHER WARNINGS AND CAUTIONS ARE CONTAINED ON PAGES WHERE THEY APPLY THROUGHOUT THIS MANUAL.

A PERIODIC REVIEW OF SAFETY PRECAUTIONS IN TB 385-4, SAFETY PRECAUTIONS FOR MAINTENANCE OF ELECTRICAL/ELECTRONICS EQUIPMENT, IS RECOMMENDED.



SIGNAL GENERATORS CAN INTERFERE WITH COMMUNICATIONS RECEIVERS AND DISRUPT COMMUNICATION SERVICE FOR A RADIUS OF SEVERAL MILES. WHEN USING THIS EQUIPMENT, TAKE NECESSARY PRECAUTIONS TO AVOID POSSIBLE COMMUNICATION INTERFERENCE PROBLEMS.



HOW TO USE THIS MANUAL

THIS MANUAL TELLS YOU ABOUT YOUR RADIO TEST SET, AN/GRM-114A, AND CONTAINS INSTRUCTIONS ABOUT HOW TO USE IT DURING MAINTENANCE WHILE WORKING ON OTHER ELECTRONIC EQUIPMENT.

THE TECHNICAL MANUAL FOR THE ELECTRONIC EQUIPMENT YOU ARE MAINTAINING WILL TELL YOU WHERE TO MAKE CERTAIN CONNECTIONS AND WHERE TO USE THE VARIOUS ATTENUATORS AND OTHER ACCESSORIES WHICH ARE PART OF YOUR RADIO TEST SET.

WHEN YOU FIRST RECEIVE YOUR RADIO TEST SET, START AT THE FRONT OF THE MANUAL AND GO ALL THE WAY THROUGH TO THE BACK. BECOME FAMILIAR WITH EVERY PART OF THE MANUAL AND TEST SET.

THIS MANUAL HAS AN EDGE INDEX WHICH WILL HELP YOU FIND SPECIFIC INFORMATION IN A HURRY WHEN YOU HAVE TO USE YOUR RADIO TEST SET. SIMPLY SPREAD THE PAGES ON THE RIGHT EDGE OF THE MANUAL UNTIL THE PRINTED BLOCKS CAN BE SEEN. OPEN THE MANUAL WHERE THE BLOCK ON THE EDGE OF THE PAGE LINES UP WITH YOUR SELECTED TOPIC PRINTED ON THE FRONT COVER INDEX BLOCK.

Headquarters
Department of the Army
Washington, DC, 20 June 1983

OPERATOR'S MANUAL
RADIO TEST SET
AN/GRM-114A
(NSN 6625-01-144-4481)

REPORTING ERRORS AND RECOMMENDING IMPROVEMENTS

You can help improve this manual. If you find any mistakes, or if you know of a way to improve the procedures, please let us know. Mail your letter, DA Form 2028 (Recommended Changes to Publications and Blank Forms), or DA Form 2028-2 located in the back of this manual direct to Commander, US Army Communications-Electronic Command and Fort Monmouth, ATTN: AMSEL-ME-MP, Fort Monmouth, New Jersey 07703-5007.

A reply will be furnished direct to you.

		Page
	HOW TO USE THIS MANUAL	B
CHAPTER 1.	INTRODUCTION	1-0
Section I.	General Information	1-0
II.	Equipment Description	1-4
CHAPTER 2.	OPERATING INSTRUCTIONS	2-1
Section I.	Description and Use of Operator Controls, Connectors and Indicators	2-1
II.	Preventive Maintenance Checks and Services	2-15
III.	Detailed Operating Procedures	2-19
IV.	Operating Under Usual Conditions	2-64
V.	Operating Under Unusual Conditions	2-68
CHAPTER 3.	MAINTENANCE INSTRUCTIONS	3-1
Section I.	Lubricating Instructions	3-1
II.	Troubleshooting Procedures	3-1

APPENDIX A.	REFERENCES	A-1
B.	COMPONENT OF END ITEM LIST	B-1
C.	ADDITIONAL AUTHORIZATION LIST	C-1
D.	EXPENDABLE SUPPLIES AND MATERIALS LIST	D-1
E.	INDEX	E-1

LIST OF ILLUSTRATIONS

FIGURE NUMBER	TITLE	Page
2-1	FM/AM-1100S Front Panel	2-1
2-2	RF Frequency MHz Thumbwheels	2-6
2-3	CRT Display Graticule Markings	2-7
2-4	FM/AM-1100S Rear Panel	2-10
2-5	MM-100E Front Panel	2-11
2-6	MM-100E Probe and Probe Kit	2-15
2-7	FM/AM-1100S Initial Adjustments and Control Settings for RF Signal Generator Operation ..	2-21
2-8	FM/AM-1100S Initial Adjustments and Control Settings for Generating AM RF Signals	2-24
2-9	FM/AM-1100S Initial Adjustments and Control Settings for Generating FM RF Signals	2-27
2-10	FM/AM-1100S Initial Adjustments and Control Settings for Oscilloscope Operation	2-30
2-11	FM/AM-1100S Initial Adjustments and Control Settings for Receiver Operation	2-32
2-12	FM/AM-1100S Initial Adjustments and Control Settings for Spectrum Analyzer Operation	2-40
2-13	FM/AM-1100S Initial Adjustments and Control Settings for Spurious Signal Detection Using Spectrum Analyzer	2-44
2-14	FM/AM-1100S and MM-100E Initial Adjustments and Control Settings for Generating Audio Signals	2-49
2-15	FM/AM-1100S Initial Adjustments and Control Settings for Measuring Transmitter Carrier Power	2-53
2-16	FM/AM-1100S Initial Adjustments and Control Settings for Master Oscillator Calibration Using Received Time Standard Signal (WWV) ...	2-55
2-17	FM/AM-1100S Initial Adjustments and Control Settings for Frequency Error Measurement	2-59
B-1	Components of End Item	B-1

LIST OF TABLES

TABLE NUMBER	TITLE	Page
2-1	Preventive Maintenance Checks and Services	2-17
2-2	AN/GRM-114A Start-Up Procedures, Emergency Operating Procedures and Stopping Procedures	2-20
2-3	AN/GRM-114A RF Signal Generator Operating Instructions	2-21
2-4	AN/GRM-114A RF Signal Generator Operating Instructions for Generating AM RF Signals ...	2-24
2-5	AN/GRM-114A RF Signal Generator Operating Instructions for Generating FM RF Signals ...	2-27
2-6	AN/GRM-114A Oscilloscope Operating Procedures ..	2-29
2-7	AN/GRM-114A Receiver Operating Instructions	2-32
2-8	AN/GRM-114A Spectrum Analyzer Operating Instructions	2-40
2-9	AN/GRM-114A Spectrum Analyzer Operating Instructions for Spurious Signal Detection ..	2-44
2-10	Audio Generation with MM-100E Operating Instructions	2-49
2-11	Audio Generation with Oscilloscope Operating Instructions	2-51
2-12	Power Monitor Operating Instructions for Measuring Transmitter Carrier Power	2-53
2-13	Master Oscillator Calibration Using Received Time Standard Signal (WWV)	2-55
2-14	Master Oscillator Calibration Using an External Frequency Standard	2-58
2-15	Frequency Error Measurement Operating Instructions	2-59
2-16	Multimeter Operating Instructions	2-61
3-1	Trouble Shooting	3-2



CHAPTER 1

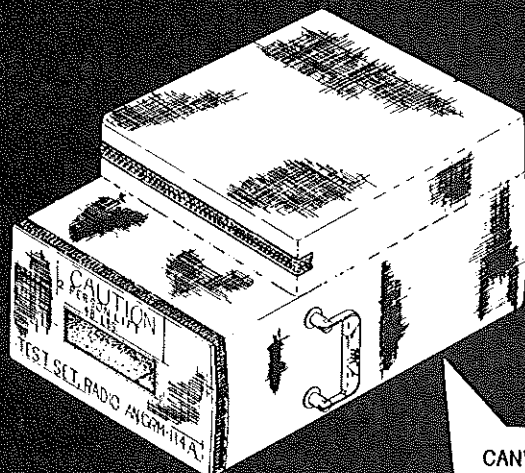
INTRODUCTION

Section 1, GENERAL INFORMATION

1-1. SCOPE.

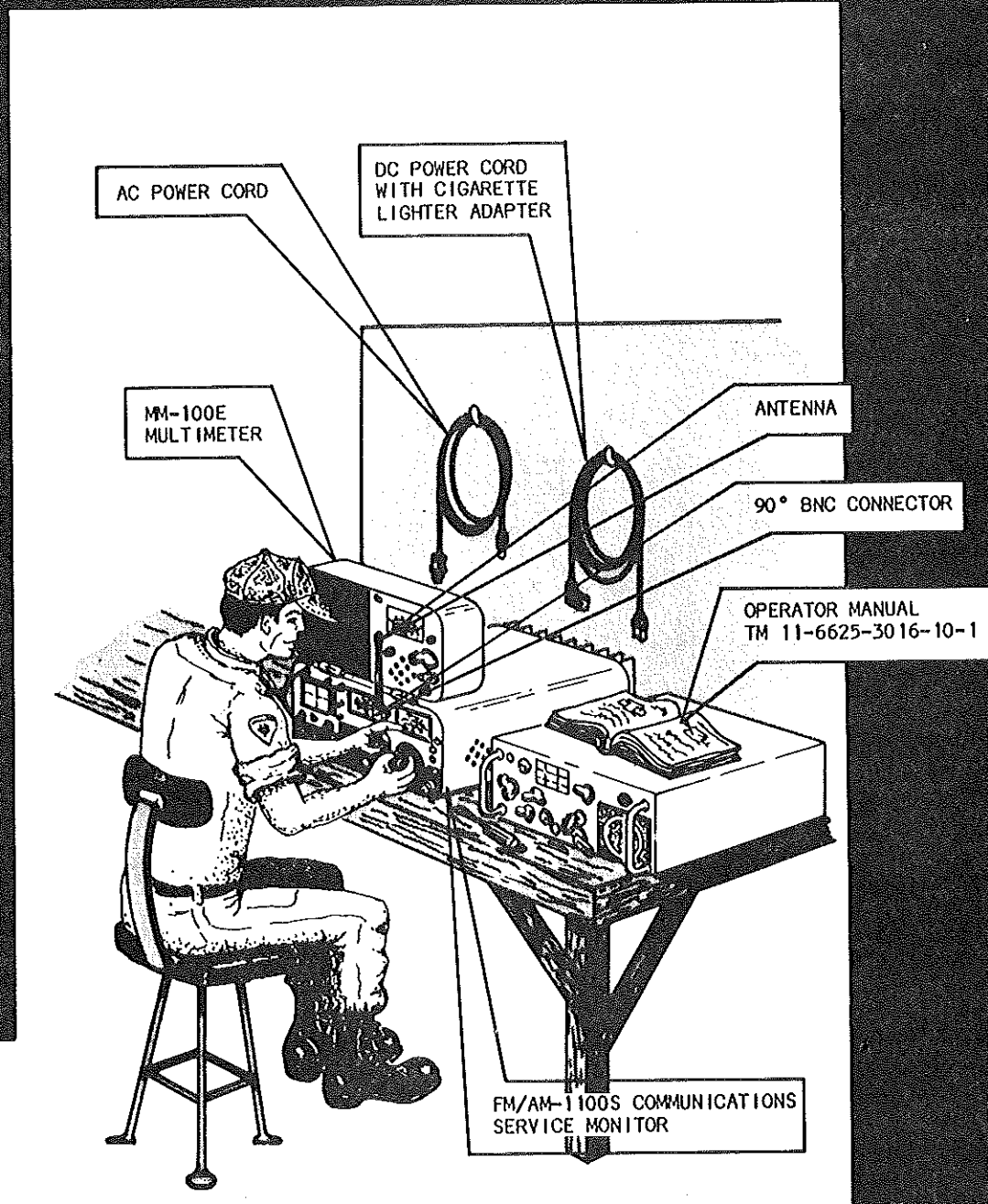
The purpose of this manual is to tell you how to operate and maintain the AN/GRM-114A Radio Test Set.

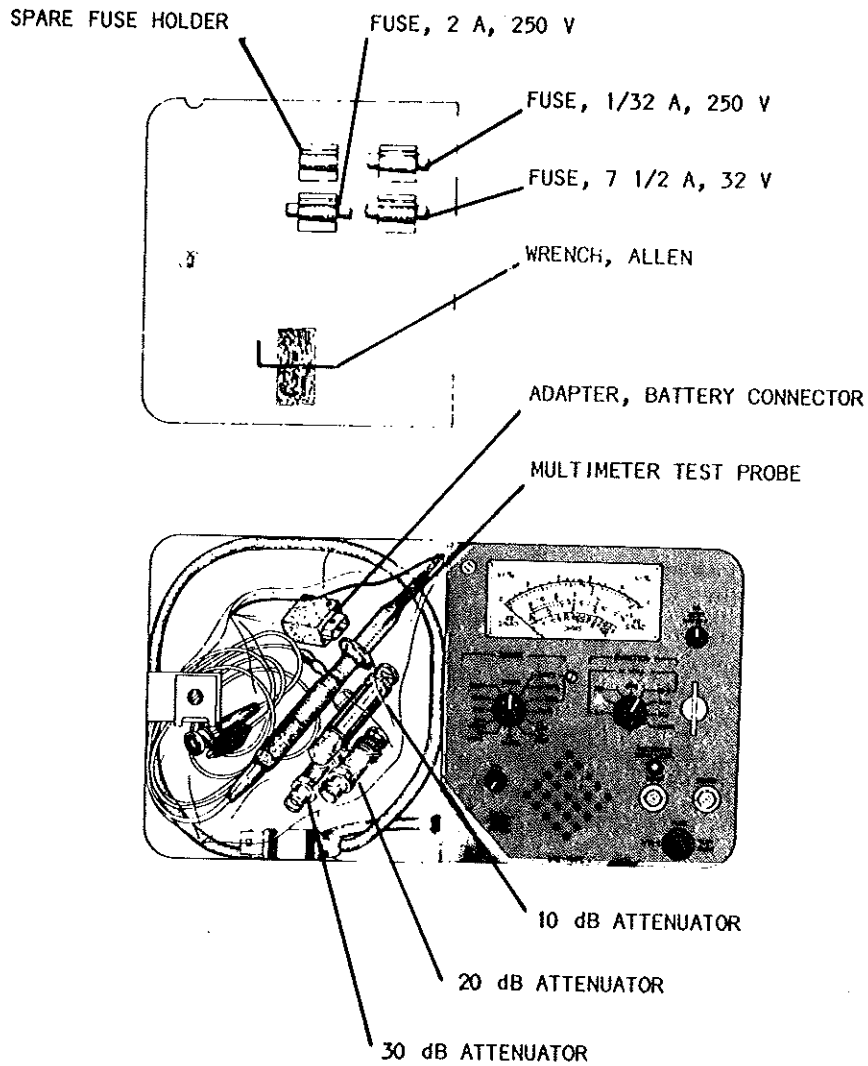
The AN/GRM-114A is a compact, lightweight, portable maintenance instrument which provides test and measurement capabilities to effectively test and service a variety of avionics and communications equipment. The AN/GRM-114A incorporates the function of an FM/AM signal generator, FM/AM receiver, RF spectrum analyzer, oscilloscope, audio generator, power monitor and a multimeter which permits the test set to perform general diagnostic tests and transmitter/receiver performance tests.



CANVAS COVER/CARRYING CASE

Radio test set AN/GRM-114A in use by operator during maintenance of a radio receiver transmitter.





1-2. MAINTENANCE FORMS, RECORDS AND REPORTS.

Reports of Maintenance and Unsatisfactory Equipment.

Department of the Army forms and procedures used for equipment maintenance will be those prescribed by DA Pam 738-750, as contained in Maintenance Management Update.

Report of Packaging and Handling Deficiencies.

Fill out and forward SF 364 (Report of Discrepancies (ROD)) as prescribed in AR 735-11-2/DLAR 4140.55/NAVMATINST 4355.73 A/AFR 400-54/MCO 4430.3F.

Discrepancy in Shipment Report (DISREP) (SF 361).

Fill out and forward Discrepancy in Shipment Report (DISREP) (SF 361) as prescribed in AR 55-38/NAVSUPINST 4610.33 C/AFR 75-18/MCO P4610.19 D/DLAR 4500.15.

1-3. REPORTING EQUIPMENT IMPROVEMENT RECOMMENDATIONS (EIR'S).

If your AN/GRM-114A needs improvement, let us know. Send us an EIR. You, the user, are the only one who can tell us what you don't like about your equipment. Let us know why you don't like the design. Put it on an SF 368 (Quality Deficiency Report). Mail it to: Commander, US Army Communications-Electronics Command and Fort Monmouth, ATTN: AMSEL-ME-MP, Fort Monmouth, New Jersey, 07703-5007. We'll send you a reply.

1-4. LIST OF ABBREVIATIONS.

The following abbreviations and symbols are commonly used throughout the TM 11-6625-3016-10-1 Operator's Manual:

A	- Ampere	Hz	- Hertz
AC	- Alternating Current	IC	- Integrated Circuit
AH	- Ampere-Hours	IF	- Intermediate Frequency
AM	- Amplitude Modulation	INT MOD	- Internal Modulation
BATT	- Battery	Kg	- Kilogram
BFO	- Beat Frequency Oscillator	kHz	- KiloHertz
BNC	- Bayonet-Coupled Quick Disconnect (Industry standard coax connector)	lbs	- pounds
°C	- Degrees Celsius	MHz	- Megahertz
CAL	- Calibrated	µs	- microsecond
CCW	- counterclockwise	µV	- microvolt
cm	- centimeter	ms	- millisecond
CW	- clockwise	msec	- millisecond
CW	- Continuous Wave	mV	- millivolt
CRT	- Cathode Ray Tube	mW	- milliwatt
CUT	- Circuit Under Test	N/A	- Not Applicable
dB	- decibels	No.	- Number
dBm	- decibels per 1 milliwatt	PPM	- Pulse Per Minute
DC	- Direct Current	psi	- pounds per square inch
EXT ACC	- External Accessory	PWR	- Power
EXT MOD	- External Modulation	RF	- Radio Frequency
EXT V/DIV	- External Volts per Division	RFi	- Radio Frequency Interference
°F	- Degrees Fahrenheit	RMS	- Root Mean Square
FM	- Frequency Modulation	sec	- second(s)
GEN	- Generator	SIG	- Signal
HI LVL	- High Level	SINAD	- Signal plus Noise and Distortion
HORIZ	- Horizontal		

TM11-6625-3016-10-1

SSB	- Single Sideband	VDC	- Volts Direct Current
TCXO	- Temperature Compensated Crystal Oscillator	VOL	- Volume
TRANS	- Transmitter	VOM	- Volt Ohmmeter
UUT	- Unit Under Test	Vp	- Volts Peak
V	- Volts	Vp-p	- Volts Peak-to-Peak
VAC	- Volts Alternating Current	V RMS	- Volts Root Mean Square
		W	- Watts

Section II, EQUIPMENT DESCRIPTION

1-5. PURPOSE OF THE AN/GRM-114A.

The AN/GRM-114A Radio Test Set is easily and efficiently used in testing the VRC Series Radio. As a portable unit containing an internal rechargeable battery, operation of the AN/GRM-114A is possible almost anywhere without concern for immediate power. Mobile operation is possible directly from 11 to 28 Volt DC power systems, using a furnished cigarette lighter adapter plug. AC power operation is possible from 110 to 250 VAC, 50 to 400 Hz power services.

1-6. CAPABILITIES AND FEATURES.

- Generates FM/AM/CW signals from 100 Hz to 1 GHz,
- Has a variable generator output level from -127 dBm to 0 dBm.
- Receives FM/AM/CW/SSB frequencies from 1 MHz to 1 GHz.
- By using a sniffer cable, the receiver can measure oscillator frequencies without loading down the oscillator.
- Measures transmitter frequency error, power, FM deviation and AM% modulation.
- Has a spectrum analyzer with a 70 dB dynamic range, 30 kHz bandwidth, variable dispersion and frequency range from 0 to 1 GHz. The DC to 1 MHz oscilloscope can display the AM envelope, instantaneous FM deviation and lissajou patterns for audio frequency comparisons.
- Has a built-in dual tone generator, one tone generator fixed at 1000 Hz and one tone generator variable from 10 Hz to 20 kHz, selectable in .1 Hz steps.
- Has a general purpose VOM for measuring volts AC, volts DC, ohms, signal distortion and signal plus noise and distortion (SINAD).

1-7 PERFORMANCE DATA.

A. ELECTRICAL CHARACTERISTICS.

RF GENERATOR

● Frequency range:

100 Hz to 999.9999 MHz in 100 Hz steps

● Frequency accuracy:

5×10^{-7} ($\pm 0.00005\%$)

2×10^{-7} (typically)

(See specification on TCXO Master Oscillator)

● FM Quieting:

42 dB below 3.3 kHz deviation at 1 kHz rate, as measured in a 0.3 to 3 kHz post-detection bandwidth

● Residual FM:

Less than 100 Hz

● RF Output Power:

-130 dBm to -35 dBm (100 Hz to 1 GHz)

-130 dBm to 0 dBm (20 kHz to 1 GHz)

Continually variable into 50Ω .

● Ranges:

NORM (Normal), $\mu V \times 100$, and HI LVL (HI LVL)
(0 dBm)

● Accuracy:

-110 to -35 dBm ± 2.5 dB up to 400 MHz

± 3.0 dB above 400 MHz

● "HI LEVEL" Power Range

Indicator Accuracy:

0 dBm; ± 2.5 dB (20 kHz to 600 MHz)

± 4.0 dB (600 MHz to 999.9999 MHz)

(Dial indicator accuracy (dBm scale) is maintained relative to 0 dBm indication.)

● Internal Modulation:

AM:

10 Hz to 5 kHz (0 to 90%)

FM:

50 Hz to 20 kHz rate, 10 Hz to ± 20 kHz deviation

● External Modulation:

AM:

Approx. 3.0 V peak-to-peak produces 90% modulation

FM:

Approx. 6.0 V peak-to-peak produces 15 kHz deviation (Maximum modulating frequency = 20 kHz)

● Distortion INT/EXT:

2% maximum @ 15 kHz deviation

OSCILLOSCOPE

● Display size:

5 cm x 5 cm

● Vertical bandwidth:

DC to 1 MHz (at 3 dB bandwidth) AC or DC inputs

● External Vertical Input Ranges:

10 mV, 100 mV, 1 V, 10 V per division

● Horizontal Sweep Rate:

10 ms, 1 ms, 100 μ s, 10 μ s per division

SPECTRUM ANALYZER

● Dynamic Range:

70 dB (-30 dBm to -100 dBm)

● Dispersion:

Continuous from ± 0.5 MHz to ± 5 MHz from center frequency (1 to 10 MHz span)

● Bandwidth Resolution:

30 kHz

AUDIO GENERATOR

● Frequency Range:

Variable Tone:

10 Hz to 20 kHz

Fixed Tone:

1 kHz

● Accuracy:

Variable Tone:

0.01%

Fixed Tone:

±20 Hz

Resolution:

0.1 Hz

● Output Level:

0 to 2.5 VRMS into 150Ω.

0 to 3.0 VRMS into 600Ω.

● Distortion:

Variable Tone:

10 Hz to 100 Hz: 1.5% maximum

100 Hz to 20 kHz: 0.7% maximum

Fixed Tone:

2% maximum

RECEIVER/MONITOR

● Frequency Range:

300 kHz to 999.9999 MHz

TM11-6625-3016-10-1

● Resolution:

100 Hz

10 dB Sinad Sensitivity:

2 μ V (typical)

● Selectivity at 3 dB Point

Narrow:

Receiver 15 kHz; detector audio bandwidth is 8 kHz

Mid:

Receiver 150 kHz; detector audio bandwidth is 8 kHz

Wide:

Receiver 150 kHz; detector audio bandwidth is
80 kHz

Quieting:

Deviation measurements can be made down to 0.1 kHz

Adjacent Channel Rejection:

Greater than 25 dB at 25 kHz (typical)

Greater than 40 dB at 50 kHz (typical)

● Deviation Measurement:

Meter Accuracy:

$\pm 7\%$ @ 0-50°C

Range:

0-2, 0-6, 0-20 kHz

● Beat Frequency/Oscillator Accuracy:

BFO is phase-locked to master oscillator ± 3 dB,
from 2 μ V to 5000 μ V

● Demodulation Output Level:

AM:

100% = 0.5 V peak-to-peak nominal

FM:

± 10 kHz = 0.65 V peak-to-peak nominal

- Receiver Antenna Input Protection:

0.25 watts maximum level without damage

POWER MONITOR

- Frequency Range:

1 MHz to 1 GHz

- Power Ranges:

0-4 W, 0-40 W and 0-400 Watts

- Accuracy:

1 to 600 MHz:

$\pm 7\%$ of reading plus 3% of full scale

600 MHz to 1 GHz:

$\pm 20\%$ of reading plus 3% of full scale

- Input Power:

65 W continuous at 25⁰ C with unrestricted airflow, 150 W for 1 minute ON with 1 minute OFF, 635 WPEP when using a two tone test on a SSB transmitter (317.5 W average) for 1 minute ON with 5 minutes OFF.

- Input Power Protection:

An audible alarm is provided in addition to a visual alarm when power limits are exceeded.

No damage will result if the input power is removed within 20 seconds after the indicator is activated.

TCXO MASTER OSCILLATOR

- Accuracy:

5×10^{-7} ($\pm 0.00005\%$)

2×10^{-7} (typical)

Greater accuracy is obtainable with front panel adjustment

TM11-6625-3016-10-1

- Aging Stability:

$\pm 1 \times 10^{-6}$ per year or less

FREQUENCY ERROR METER MEASUREMENT CAPABILITY

- Meter Sensitivity:

Typically $1.5 \mu\text{V}$ above 1 MHz (sensitivity is reduced below 1 MHz)

- Ranges:

$\pm 1.5 \text{ kHz}$, $\pm 5 \text{ kHz}$, $\pm 15 \text{ kHz}$ (full scale)

- Resolution:

50 Hz (calibration marks at 100 Hz on $\pm 1.5 \text{ kHz}$ range)

- Zeroing:

Frequency error meter is automatically zeroed every 1.5 seconds during a 3 ms time period. Auto zeroing may be disabled with AUTO ZERO/OFF/BATT Switch.

MM-100E MULTIMETER

- SINAD:

Range:

0-20 dB

Accuracy:

$\pm 1.5 \text{ dB}$

- Distortion: (DIST)

Range:

0-10%, and 0-30%

Accuracy:

$\pm 1.5\%$ for the 0-10% range
 $\pm 3.5\%$ for the 0-30% range

● \pm DC Volts:

Ranges:

.1 V, .3 V, 1 V, 3 V, 10 V, 30 V, 100 V, and 300 V
full scale

Accuracy:

\pm 3% full scale

● AM%:

Range:

0-100%

Accuracy:

\pm 10% of modulation

AC LOAD

HI-Z ($1M\Omega$)

● Impedance:

3.2, 8, 150, 600, and 1 $M\Omega$ unbalanced

Ohms:

30Ω center scale x1

Accuracy:

\pm 5% at Midscale

● AC Volts:

Frequency Range 50 Hz to 20 kHz

Accuracy:

\pm 5% of full scale reading

B. PHYSICAL CHARACTERISTICS.

● Power:

105 to 266 VAC, 50 to 400 Hz or 11 to 30 VDC

● Size:

12.5 in wide (31.8 cm), 8 in high (20.3 cm),
22.0 in deep (55.9 cm)

● Weight:

48 lbs. (21.8 kg)

● Typical DC Currents:

4.3 A at 12 V and 1.85 A at 28 V with Oscillo-
scope/receiver ON and dual tone generator/
spectrum analyzer OFF

● Typical Power Consumption:

57 Watts

● Internal Battery:

13.2 VDC, 4.0 Ah @ 0.8 ampere rate

C.

ENVIRONMENTAL CHARACTERISTICS.

- Complies with type II, class 5, style E, per MIL-T-28800C

CHAPTER 2 OPERATING INSTRUCTIONS

Section I, DESCRIPTION AND USE OF OPERATOR CONTROLS, CONNECTORS AND INDICATORS

WARNING

DO NOT OPERATE THE AN/GRM-114A UNTIL YOU HAVE READ AND UNDERSTAND ALL OPERATING INSTRUCTIONS.

2-1. AN/GRM-114A CONTROLS, CONNECTORS AND INDICATORS.

- FM/AM-1100S Front Panel Controls, Connectors and Indicators. (Numbers correspond to key numbers in the following table.)

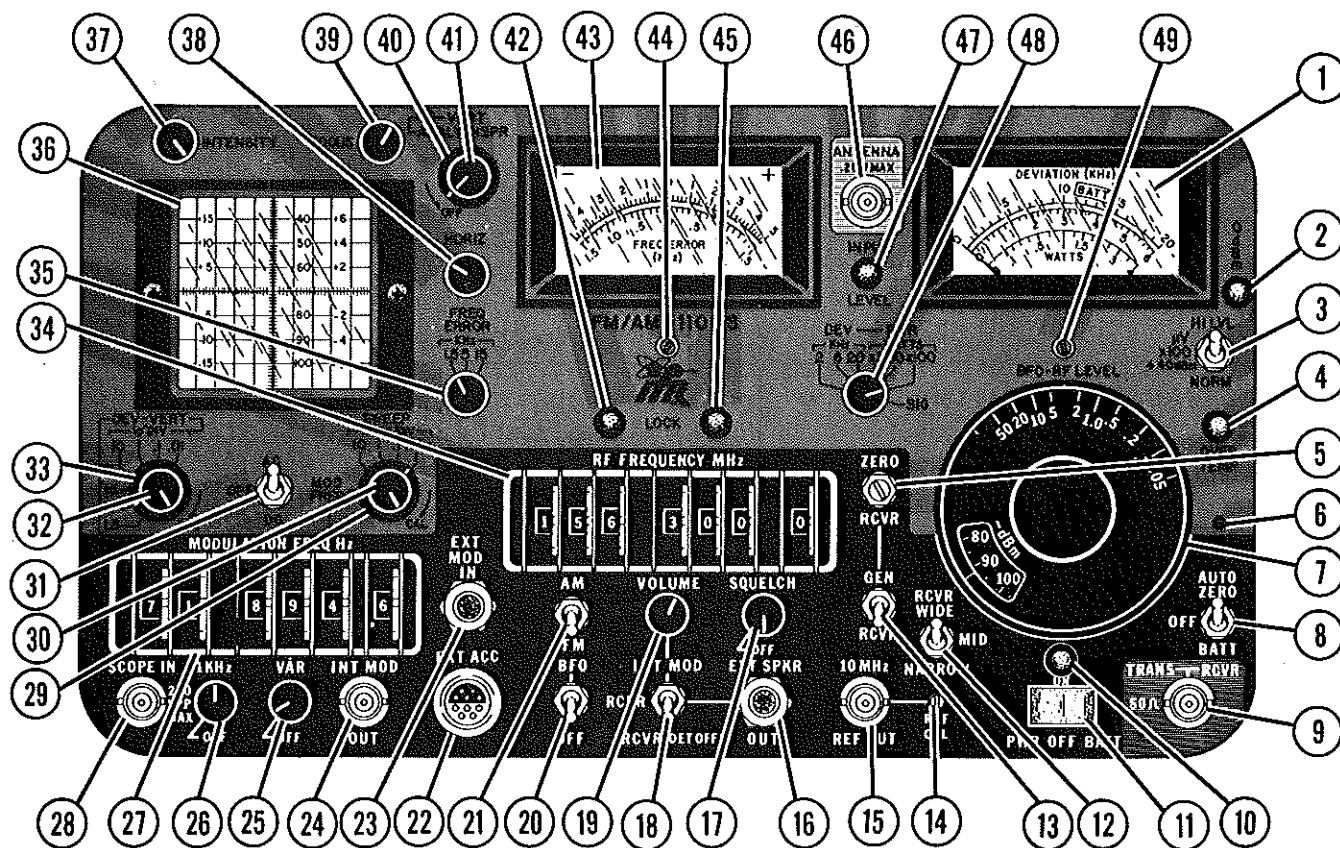


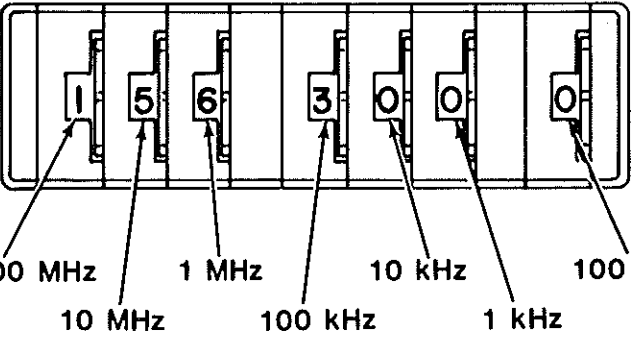
Figure 2-1 FM/AM-1100S Front Panel

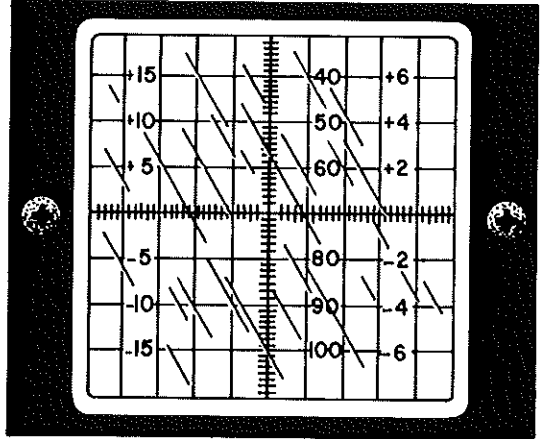
KEY	CONTROL, INDICATOR OR CONNECTOR	FUNCTION
1	DEVIATION/WATTS Meter	Provides visual display of peak FM deviation, transmitter output power, transmitter signal strength and internal battery charge condition.
2	0 dBm Lamp	Lights when AN/GRM-114A RF signal output is at 0 dBm or above.
3	HI LVL/ μ V x 100/NORM Switch	<p>Three position switch which selects power range for BFO-RF LEVEL Control (7) as follows:</p> <p>"NORMAL" Position - RF/BFO output level is equal to setting on BFO-RF LEVEL Control (7) on "μV" or dBm scale.</p> <p>"μV x 100" Position - RF/BFO output level is 100 times the BFO-RF LEVEL Control (7) setting on the μV scale.</p> <p>"HIGH LEVEL" Position - Enables RF output levels above -35 dBm to be achieved.</p>
4	OVER TEMP Lamp	Lights when rear panel heat sink becomes overheated.
5	ZERO RCVR Adjustment	Adjustment screw for zeroing FREQ ERROR Meter (43) when test set power is "ON". (GEN/RCVR Switch (13) must be in "GEN" position when zeroing meter.)
6	OVER TEMP Alarm	Alarms when rear panel heat sink becomes overheated.
7	BFO-RF LEVEL Control	Controls AN/GRM-114A RF output level when set is operating in signal generator mode and BFO (beat frequency oscillator) injection level when set is operating in receiver mode.
8	AUTO ZERO/OFF/BATT Switch	Three position switch which turns the auto-zeroing "ON" or "OFF" and provides a visual indication of internal battery voltage as follows:

KEY	CONTROL, INDICATOR OR CONNECTOR	FUNCTION
8	(Continued)	<p>"AUTO ZERO" position- Auto-zeroing circuit is activated, automatically zeroing receiver and FREQ ERROR Meter (42) through an internal self-check.</p> <p>"OFF" Position - Auto-zeroing circuit is turned "OFF".</p> <p>"BATT" Position - When switch is held in this position, the internal battery voltage condition is displayed on DEVIATION/WATTS Meter (1). (Battery is discharged when DEVIATION/WATTS Meter (1) is 11 volts under load.)</p>
9	TRANS/RCVR Connector	50Ω RF input/output connector for connecting UUT to AN/GRM-114A.
10	POWER ON Lamp	Lights when test set is turned on.
11	PWR/OFF/BATT Switch	<p>Supplies or interrupts power to AN/GRM-114A as follows:</p> <p>"PWR" Position - Applies external AC or DC power to AN/GRM-114A.</p> <p>"OFF" Position - Shuts off all power to the AN/GRM-114A (except battery charger circuit).</p> <p>"BATT" Position - Powers AN/GRM-114A by its internal battery. Test set will automatically shut off after approximately 10 minutes of operation, to prevent battery rundown. (To manually shut off test set, depress the PWR/OFF/BATT Switch to BATT position second time.)</p>
12	RCVR WIDE/MID/NARROW Switch	Selects "WIDE", "MID", "NARROW" bandwidth of AN/GRM-114A receiver.

KEY	CONTROL, INDICATOR OR CONNECTOR	FUNCTION
13	GEN/RCVR Switch	<p>Selects either signal generator or receiver mode of operation as follows:</p> <p>"GEN" Position - Places AN/GRM-114A to signal generator mode of operation. If RF is applied to TRANS/RCVR Connector (9) while set is in generator mode, set will automatically switch to receiver mode.</p> <p>"RCVR" Position - Places AN/GRM-114A to receiver mode of operation. Set receives signals through either the TRANS/RCVR Connector (9) or "off-the-air" via an external antenna attached to ANT INPUT Connector (46).</p>
14	CAL Adjustment	Fine tunes the AN/GRM-114A 10 MHz oscillator frequency.
15	10 MHz REF OUT Connector	10 MHz master oscillator output connector.
16	EXT SPKR Connector	Audio output connector for remote speaker, headphones, etc.
17	SQUELCH Control	Squelch threshold control. Squelch disables audio output when RF input at ANT INPUT Connector (46) falls below squelch threshold.
18	INT MOD/RCVR/RCVR (DET OFF) Switch	Couples AN/GRM-114A receiver or dual tone generator audio output to internal speaker. With the switch placed in RCVR (DET OFF) position, the power monitor detector is disabled to allow accurate Transmitter 2nd harmonic measurements on the AN/GRM-114A spectrum Analyzer.
19	VOLUME Control	Controls audio output level to either the internal speaker or external speaker if connected.
20	BFO/OFF Switch	Turns on or off the internal beat frequency oscillator (BFO).

KEY	CONTROL, INDICATOR OR CONNECTOR	FUNCTION
21	AM/FM Switch	Selects either the AM or FM mode of operation as follows: "AM" Position - AN/GRM-114A generates or receives amplitude modulated (AM) signals. "FM" Position - AN/GRM-114A generates or receives frequency modulated (FM) signals.
22	EXT ACC Connector	Output connector providing power or signal source for MM-100E.
23	EXT MOD Connector	Input connector for external modulation.
24	INT MOD OUT Connector	Output connector couples dual tone generator output to external devices. (Output is controlled by VAR/OFF and 1 kHz/OFF Controls (25 and 26)).
25	VAR/OFF Control	Controls %AM modulation or FM peak deviation of the frequency selected on MODULATION FREQ Hz Thumbwheel (27). Modulation Control is "OFF" in fully ccw detent position.
26	1 kHz/OFF Control	Controls %AM modulation or FM peak deviation for an approximately 1 kHz tone. Modulation control is "OFF" in full ccw detent position.
27	MODULATION FREQ Hz Thumbwheels	Selects internal modulation frequency produced by the dual tone generator from 10 Hz thru 20 kHz.
28	SCOPE IN Connector	Vertical deflection input for oscilloscope.
29	SWEEP Control	Controls the horizontal sweep speed of the oscilloscope.
30	SWEEP VERNIER Control	Permits continuous variation of sweep speed within any of the ranges provided by SWEEP Control (29). In "CAL" position (fully cw, detent), oscilloscope horizontal graticule divisions are equal to the setting of the SWEEP Control (29).

KEY	CONTROL, INDICATOR OR CONNECTOR	FUNCTION
31	AC/OFF/DC Switch	Three position switch which AC couples scope inputs in "AC" position, "DC" couples scope inputs in "DC" position and disconnects power from oscilloscope/spectrum analyzer in "OFF" position.
32	DEV-VERT VERNIER Control	Permits variation of oscilloscope vertical sensitivity within any of the ranges provided by DEV-VERT Control (33). In "CAL" position (fully cw, detent), oscilloscope vertical graticule divisions are equal to the setting of the DEV-VERT Control (33).
33	DEV-VERT Control	<p>Controls vertical sensitivity and input source applied to the oscilloscope as follows:</p> <p>"EXT V/DIV" Positions - Selects oscilloscope vertical sensitivity (in indicated voltage increments per graticule division) for signals applied to SCOPE IN Connector (28).</p> <p>"kHz" Positions - Oscilloscope displays frequency deviation (in "FM" mode) or modulation envelope (in "AM" mode).</p>
34	RF Frequency MHz Thumbwheels	<p>Selects signal generator or receiver frequency.</p>  <p>The diagram shows a row of seven thumbwheels. From left to right, they are labeled with the following frequencies: 100 MHz, 10 MHz, 1 MHz, 100 kHz, 10 kHz, 1 kHz, and 100 Hz. Each thumbwheel has a small window showing a digit. The first four thumbwheels (100 MHz, 10 MHz, 1 MHz, 100 kHz) have windows showing the digits 1, 5, 6, and 3 respectively. The last three thumbwheels (10 kHz, 1 kHz, 100 Hz) have windows showing the digit 0.</p> <p>Figure 2-2 RF Frequency MHz Thumbwheels</p>

KEY	CONTROL, INDICATOR OR CONNECTOR	FUNCTION
35	FREQ ERROR Control	Selects full scale sensitivity of "FREQUENCY ERROR METER" (43).
36	CRT Display	<p>Display screen for oscilloscope and spectrum analyzer.</p>  <p>Figure 2-3 CRT Display Graticule Markings</p>
37	INTENSITY Control	Controls the brightness of the CRT trace.
38	HORIZ Control	Controls the horizontal position of the oscilloscope trace.
39	FOCUS Control	Controls sharpness of oscilloscope trace.
40	VERT Control	Controls the vertical position of the oscilloscope trace.
41	ANALY DISPR Control	Continuously varies spectrum analyzer dispersion within a span of 1 to 10 MHz. Full cw rotation of control provides a dispersion of 1 MHz per major graticule division; full ccw rotation (short of detent) provides a dispersion of 0.1 MHz per major graticule division. In full ccw detent position, spectrum analyzer is "OFF" and oscilloscope is "ON".

KEY	CONTROL, INDICATOR OR CONNECTOR	FUNCTION
42	HIGH Frequency Phase LOCK Lamp	When lit, this lamp indicates proper operation of the high frequency phase lock board. (Light will "blink" momentarily when the "MHz" segments of the FREQUENCY MHz Thumbwheels (34) are switched from one frequency to another; however the light should remain lit at all other times when the AN/GRM-114A is turned on.)
43	FREQ ERROR Meter	Provides visual display of difference between the received frequency and AN/GRM-114A receiver frequency, as selected on the FREQUENCY MHz Thumbwheels (34).
44	FREQ ERROR Meter Zero Adjustment	An adjustment screw used to set the meter at zero position (with power off).
45	LOW Frequency Phase LOCK Lamp	When lit, this lamp indicates proper operation of the 79-80 MHz low frequency phase lock board. (Light will "blink" momentarily when the "kHz" or "Hz" segments of the FREQUENCY MHz Thumbwheels (34) are switched from one frequency or another; however the light should remain lit at all other times when the AN/GRM-114A is turned on.)
46	ANTENNA Connector	<p>External antenna input to AN/GRM-114A, used primarily for "off-the-air" testing.</p> <div style="border: 1px solid black; padding: 5px; margin: 10px 0;"> <p style="text-align: center;">CAUTION</p> <p>THE MAXIMUM CONTINUOUS INPUT TO THE ANT INPUT CONNECTOR MUST NOT EXCEED .25 W.</p> <p>FOR PROPER SPECTRUM ANALYZER OPERATION, THE INPUT TO THE ANT INPUT CONNECTOR SHOULD NOT EXCEED -30 dBm.</p> </div>

KEY	CONTROL, INDICATOR OR CONNECTOR	FUNCTION
46	(Continued)	<div style="border: 1px solid black; padding: 5px; text-align: center;"> <p>CAUTION</p> <p>IF AN EXTERNAL ANTENNA ATTACHED TO AN UNTERMINATED COAX CABLE IS USED, REMOVE ANY POSSIBLE STATIC CHARGE BUILDUP BEFORE CONNECTING COAX TO ANT INPUT CONNECTOR.</p> </div>
47	INPUT LEVEL Lamp	Indicates input level at ANT INPUT Connector (46) is above the squelch threshold of AN/GRM-114A receiver when lit.
48	DEV/POWER Control	<p>Selects the ranges for peak FM frequency deviation, input power at TRANS/RCVR Connector (9) and received signal strength as follows:</p> <p>"kHz" Position - Selects full scale range for peak FM deviation as displayed by DEVIATION WATTS Meter (1).</p> <p>"WATTS" Position - Selects multiplier for output power measurements on red "WATTS" scale of the DEVIATION/WATTS Meter (1).</p> <p>"SIG" Position - For signals received "off-the-air", an indication of the signal strength can be determined by the needle deflection of the DEVIATION/WATTS Meter (1). As the signal strength increases, the meter needle deflection will increase towards the right of the meter scale.</p>
49	DEVIATION/WATTS Meter Adjustment	An adjustment screw used to set the meter at zero position (with power off).

● FM/AM-1100S Rear Panel Controls, Connectors or Indicators.

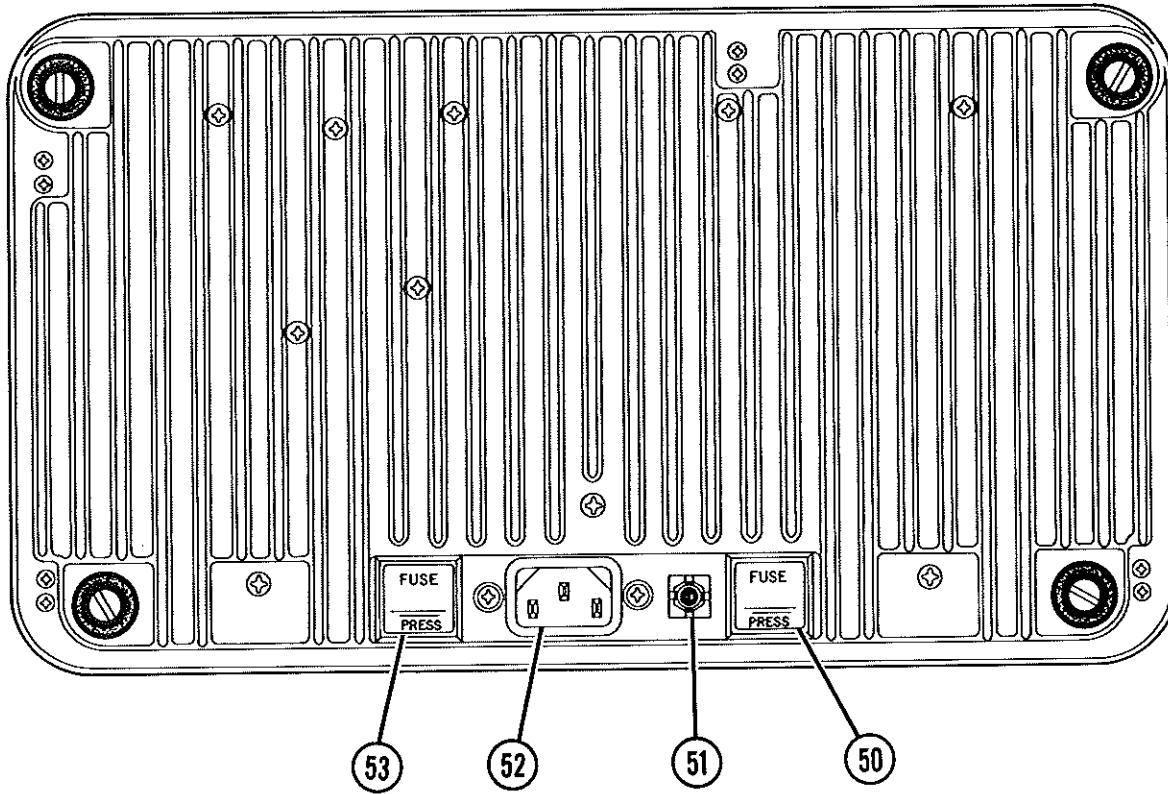


Figure 2-4 FM/AM-1100S Rear Panel

KEY	CONTROL, INDICATOR OR CONNECTOR	FUNCTION
50	INTERNAL POWER Fuse	7½ Amp Fuse
51	DC POWER Input Connector	11-30 V Input
52	AC POWER Input Connector	105-266 VAC @ 50-400 Hz Input
53	AC LINE Fuse	2 Amp SLO BLO Fuse

● MM-100E Front Panel Controls, Connectors or Indicators.

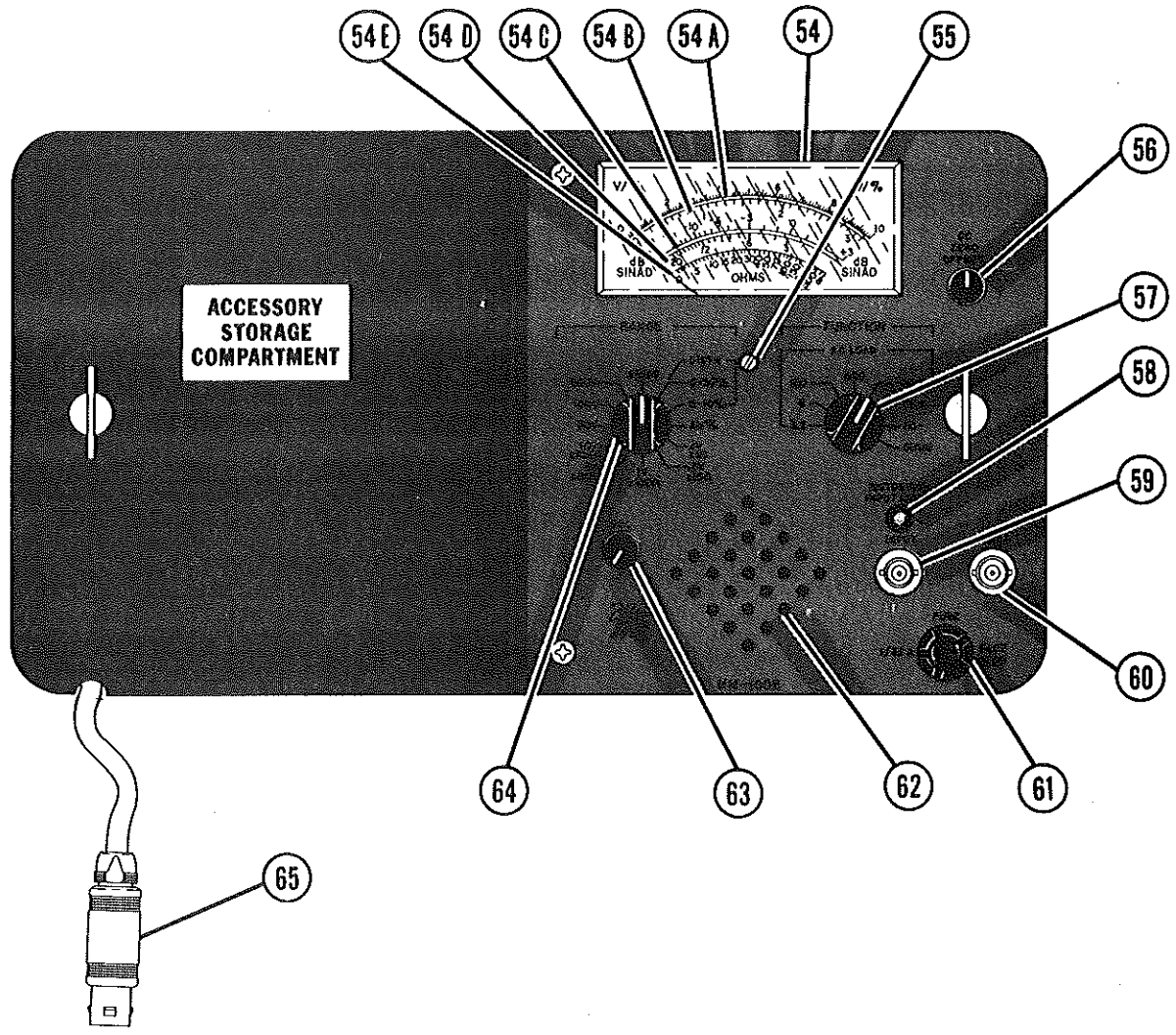


Figure 2-5 MM-100E Front Panel

KEY	CONTROL, INDICATOR OR CONNECTOR	FUNCTION
54	METER Display	A DC milliammeter with face (viewing area) having five scales for measuring voltage, distortion, SINAD and resistance.
54A.	V/% (0-10) Scale	
54B.	V/% (0-3) Scale	
54C.	dB Scale	
54D.	SINAD Scale	
54E.	Ohms Scale	

KEY	CONTROL, INDICATOR OR CONNECTOR	FUNCTION
55	METER ZERO Adjust	An adjusting screw used to set the meter at zero position (with power off).
56	DC ZERO OFFSET Control	An adjusting control which gives the voltmeter the capability to offset the meter's zero point to approximately the midpoint of the meter, and then return the zero point without adversely affecting the meter's calibration. (This gives the voltmeter provisions for measuring positive and negative voltages.)
57	FUNCTION Control	<p>A multi-function rotary select switch.</p> <ul style="list-style-type: none"> a. "OHMS" position selects function for measuring resistance. MM-100 audio monitoring function is disabled. Select one of five ohm ranges on RANGE Control (64); this will enable the meter needle to indicate the resistance at INPUT Connector (59) on the meter's ohm scale. b. "DC+" and "DC-" positions select function for measuring positive and negative dc voltage. Select one of eight voltage ranges on RANGE Control (64); this will enable the meter needle to indicate dc voltage input from INPUT Connector (59) on the meter's V/% scales (54A and 54B). c. The five AC/INPUT Z function positions (12 o'clock position thru 4 o'clock position) select impedance load for measuring audio signals and ac voltages.

KEY	CONTROL, INDICATOR OR CONNECTOR	FUNCTION
57	(Continued)	(1) INPUT Z positions "3.2, 8, and 600" select corresponding audio impedance load and places the INPUT Z load in the meter measuring circuit. Select one of eight voltage ranges on RANGE Control (64); this will enable the meter needle to indicate audio voltage input from Connector (59) on the meter's V/% scales (54A and 54B).
58	DISTORTION INPUT LEVEL Lamp	Illuminates when input is sufficient to drive distortion analyzer. NOTE Distortion analyzer readings may be inaccurate when lamp is not illuminated.
59	INPUT Connector	A BNC Connector that provides a convenient connection to attach a test probe.
60	DE-MOD Connector	A BNC Connector used for AM detector of FM demodulator output.
61	FAST BLOW Fuse	A 1/32 ampere fuse is placed in ohms measuring circuit to protect the ohms measuring circuit.
62	AUDIO Monitor (Speaker)	The speaker provides an audible monitor for audio signals received through the INPUT Connector (59), except in the OHMS position.
63	VOL Control	Volume Control selects listening level of monitored audio.
64	RANGE Control	A multi-function rotary select switch that selects a meter function or selects a meter range. The meter function positions are "SINAD, DIST 0-30%, DIST 0-10%, and AM%".

KEY	CONTROL, INDICATOR OR CONNECTOR	FUNCTION
64	(Continued)	<p>a. "SINAD" position selects meter function for measuring SINAD ratio. Select an INPUT Z, determined from unit under test, on the FUNCTION Control (57). This will enable the meter needle to indicate the ratio input from INPUT Connector (59) on the meter's SINAD scale.</p> <p>b. DISTN 0-30% and DISTN 0-10% positions select meter function for measuring signal distortion. Select an INPUT Z, determined from unit under test, on the FUNCTION Control (57). This will enable meter needle to indicate signal distortion input from INPUT Connector (59) on the meter's V/% scales (54A and 54B).</p> <p>c. "AM%" position selects meter function for measuring percentage of amplitude modulation. Input to the meter is thru the MM-100E Interconnect Power Cable. This will enable meter needle to indicate percentage of amplitude modulation on the meter's V/% scale (54A and 54B).</p> <p>d. OHMS range positions "X1, X10, X100, X1K and X10K" (4 o'clock position thru 8 o'clock position) select corresponding resistive loads to place multipliers in the resistance measuring circuit. Refer to FUNCTION Control (57) for additional information for measuring resistance.</p> <p>e. VOLTS range positions ".1, .3, 1, 3, 10, 30, 100, and 300" (4 o'clock position thru 11 o'clock position) select corresponding meter full scale range, for measuring dc volts, ac volts and audio signals.</p>

KEY	CONTROL, INDICATOR OR CONNECTOR	FUNCTION
64	(Continued)	e. Refer to FUNCTION Control (57) for additional information.
65	MM-100E INTERCONNECT POWER Connector	Used to interface the MM-100E with the FM/AM-1100S.

● MM-100E PROBE

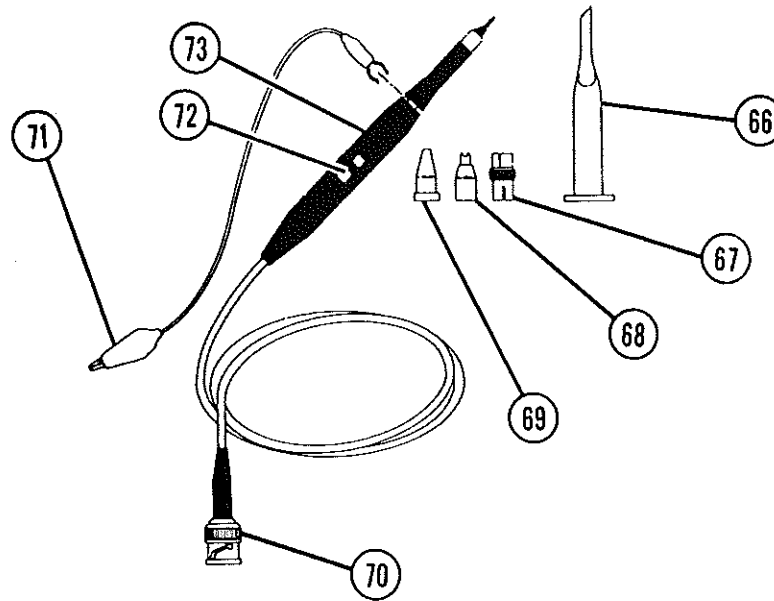


Figure 2-6 MM-100E Probe and Probe Kit

- | | |
|-----------------|-------------------------|
| 66. Probe Clip | 70. Probe BNC Connector |
| 67. BNC Adaptor | 71. Probe Ground Clip |
| 68. Insulator | 72. Probe Range Switch |
| 69. Insulator | 73. Probe |

Section II, PREVENTIVE MAINTENANCE CHECKS AND SERVICES (PMCS).

2-2. GENERAL.

You must do the PREVENTIVE MAINTENANCE CHECKS AND SERVICES (PMCS) to insure the AN/GRM-114A is always ready for use.

BEFORE OPERATION

Perform your **B** PMCS to be sure the AN/GRM-114A is ready for use. Always keep in mind the CAUTIONS and WARNINGS that appear in this manual.

DURING OPERATION

Perform your **D** PMCS. This should help you spot small troubles before they become big problems. Always keep in mind the CAUTIONS and WARNINGS that appear in this manual.

AFTER OPERATION

Perform your **A** PMCS. This should help you keep your AN/GRM-114A in top operating condition.

IF THE AN/GRM-114A FAILS TO OPERATE DO THE FOLLOWING

Troubleshoot: Refer to Page 3-1. Fill out DD Form 2404 following instructions in DA Pam 738-750; turn it in to your maintenance supervisor or organizational maintenance.

2-3. SPECIAL INSTRUCTIONS.

If the equipment must be kept in continuous operation, check and service only those items that can be checked and serviced without disturbing operation. Make the complete checks and services when the equipment can be shut down.

2-4. PREVENTIVE MAINTENANCE CHECKS AND SERVICES (PMCS) TABLE.

Perform the weekly (W) as well as before operation (B) PMCS if:

- (1) You are the assigned operator and have not operated the AN/GRM-114A since the last W PMCS.
- (2) You are operating the item for the first time.

NOTE

USE THE ITEM NO. COLUMN IN YOUR PMCS TABLE TO GET THE NUMBERS FOR THE TM ITEM NO. COLUMN ON DA FORM 2404 (EQUIPMENT INSPECTION AND MAINTENANCE WORKSHEET) WHEN YOU FILL OUT THE FORM.

EQUIPMENT INSPECTION AND MAINTENANCE WORKSHEET

DA FORM 2404

ITEM NO. 5

DEVIATION / WATTS METER WILL NOT ZERO UP

USE PMCS ITEM NO.

Table 2-1 Preventive Maintenance Checks and Services

B-Before Operation D-During Operation A-After Operation W-Weekly

ITEM NO.	INTERVAL				ITEM TO BE INSPECTED	PROCEDURES CHECK FOR AND HAVE REPAIRED OR ADJUSTED AS NECESSARY	EQUIPMENT IS NOT READY/ AVAILABLE IF:
	B	D	A	W			
1	●				SET-UP	REMOVE AN/GRM-114A FROM FIELD CASE. CHECK THAT THE TEST SET IS NOT DENTED OR DAMAGED AND METER WINDOW NOT BROKEN.	TEST SET IS DAMAGED OR METER WINDOW GLASS BROKEN.
2	●		●		POWER CABLES	LOOK AT AC/DC POWER CABLES AND MULTIMETER PROBE BE SURE CABLES ARE NOT FRAYED NOR CRACKED.	CABLES ARE FRAYED AND/OR CRACKED.
3				●	FUSES	REMOVE THE FUSES TO VERIFY THE PROPER RATED FUSE IS INSTALLED. WARNING DAMAGE TO TEST SET CAN RESULT WHEN OPERATING WITH OVERSIZED FUSES INSTALLED.	OVERRATED FUSE IS INSTALLED IN TEST SET.
4	●				CALIBRATION SEAL	BE SURE THE CALIBRATION SEAL DA LABEL 80 IS NOT EXPIRED.	CALIBRATION SEAL IS DISTURBED.
5	●				<u>METERS</u> DEVIATION/WATTS METER, FREQ ERROR METER AND MM-100E METER	CHECK ZERO ADJUSTMENT OF METERS. ADJUST BOTH ZERO METER ADJUSTMENT SCREWS ON THE FM/AM-1100S AND THE METER ADJUSTMENT SCREW ON THE MM-100E, AS NECESSARY WITH ALL POWER OFF, TO ZERO ADJUST THE METERS.	EITHER METER WILL NOT ZERO ADJUST.
6	●				POWER/OFF/BATT SWITCH	SET POWER/OFF/BATT SWITCH TO PWR OR BATT POSITION.	THE POWER ON LAMP DOES NOT ILLUMINATE.
7	●				SWITCHES AND CONTROLS	CHECK THAT ALL SWITCHES OR CONTROLS MOVE TO INDICATED POSITIONS WITHOUT STICKING OR BINDING.	SWITCHES OR CONTROLS STICK OR BIND OR CANNOT BE MOVED TO INDICATED POSITIONS.

TABLE 2-1 PMCS (Continued)

ITEM NO.	INTERVAL				ITEM TO BE INSPECTED	PROCEDURES CHECK FOR AND HAVE REPAIRED OR ADJUSTED AS NECESSARY	EQUIPMENT IS NOT READY/ AVAILABLE IF:
	B	D	A	W			
8	●				INDICATOR LAMPS HI FREQ LOCK LAMP, LOW FREQ LOCK LAMP, 0 DBM LAMP AND POWER ON LAMP	WITH THE AN/GRM-114A PWR/OFF/BATT SWITCH TURNED ON, GEN/RCVR SWITCH TO GEN, HI/LVL/ μ V X 100/NORM SWITCH TO HI LVL, AND BFO-RF LEVEL CONTROL FULLY CW, BE SURE ALL LAMPS ARE LIT.	ANY OR ALL LAMPS NOT ILLUMINATED.
9	●				BATTERY VOLTAGE	WITH POWER/OFF/BATT SWITCH TO BATT, HOLD AUTO ZERO/OFF/BATT SWITCH TO BATT POSITION, AND VERIFY THE BATTERY VOLTAGE IS WITHIN TOLERANCE ON DEVIATION/WATTS METER (BETWEEN 12-15 VOLTS).	FOR BATTERY OPERATION IF BATTERY VOLTAGE DISPLAYED ON DEVIATION/WATTS METER IS NOT WITHIN TOLERANCE.
10		●			BATTERY CHARGER	SET POWER/OFF/BATT SWITCH TO PWR POSITION, HOLD AUTO/ZERO/OFF/BATT SWITCH IN BATT POSITION, VERIFY THE BATTERY VOLTAGE IS WITHIN TOLERANCE ON DEVIATION/WATTS METER (BETWEEN 12-15 VOLTS).	BATTERY VOLTAGE DISPLAYED ON DEVIATION WATTS METER IS NOT WITHIN TOLERANCE.
11		●			OVERTEMP LAMP	BE SURE OVERTEMP LAMP DOES NOT LIGHT WHEN OPERATING. REMOVE RF INPUT POWER IF OVERTEMP LAMP IS LIT.	OVERTEMP LAMP IS ILLUMINATED.
12	●				PROBE KIT ATTENUATORS & ACCESSORIES	BE SURE ITEMS ARE NOT FRAYED, CRACKED OR DAMAGED.	PROBE, ATTENUATORS ARE FRAYED, CRACKED OR DAMAGED.
13			●		SHUTDOWN	ADJUST CRT INTENSITY CONTROL CCW SO DISPLAY IS BARELY VISIBLE. SET THE POWER/OFF/BATT SWITCH TO OFF POSITION. REMOVE ALL ACCESSORY EQUIPMENT FROM TEST SET. STOW ALL CABLES, TEST PROBES IN PROPER COMPARTMENTS. STOW THE TEST SET IN THE CANVAS COVER/CARRYING CASE.	

Section III, DETAILED OPERATING INSTRUCTIONS

CAUTION

A TRANSMITTER MUST ONLY BE CONNECTED TO THE TRANS/RCVR CONNECTOR (9) ON THE AN/GRM-114A FRONT PANEL. CONNECTING A TRANSMITTER TO ANY OTHER CONNECTOR WILL SEVERELY DAMAGE THE AN/GRM-114A.

2-5. OPERATING PROCEDURES.

Operating instructions relating to all major functions of the AN/GRM-114A can be found on Tables 2-2 through 2-16.

Observe the following precautions when operating the AN/GRM-114A.

- When working with "live" circuits of high potential, keep one hand in pocket or behind back to avoid serious shock hazard.
- Remove all jewelry or other cosmetic apparel before performing any test procedures involving "live" circuits.
- Use only insulated troubleshooting tools when working with "live" circuits.
- For added insulation, place rubber bench mat underneath all powered bench equipment, as well as a rubber floor mat underneath operator chair.
- Heed all WARNINGS and CAUTIONS concerning maximum voltage and power inputs.
- Avoid using oscilloscope/spectrum analyzer in direct sunlight, as scope trace is difficult to see under these conditions.
- Do not allow scope trace to become concentrated on CRT as a stationary spot, as CRT screen may be burned permanently. Reduce trace intensity if trace must remain stationary.
- Protect AN/GRM-114A from vibration or mechanical shock. The CRT of the AN/GRM-114A is highly evacuated and if broken, will implode causing possible serious injury from fragmented glass.

Table 2-2 AN/GRM-114A Start-Up Procedures, Emergency Operating Procedures and Stopping Procedures

Condition	Procedure
Start-Up	<p>a. For battery operation, set PWR/OFF/BATT Switch on front panel to "BATT".</p> <p style="text-align: center;">NOTE</p> <p>Battery will operate for 40 minutes before requiring re-charging if oscilloscope is being used, and for 1 hour if it is not. Battery may be re-charged from external AC power source while source powers AN/GRM-114A. Whether oscilloscope is being used or not, AN/GRM-114A will shut off every 6 to 10 minutes. When it does, immediately set PWR/OFF/BATT Switch to "BATT" position. Power will return to unit.</p> <p>For operating from external AC or DC power source, connect socket on end of furnished AC or DC power cable to plug on rear panel.</p> <p>b. For AC operation, connect 3-pin grounded plug of AC power cable to standard 3-pin grounded outlet.</p> <div style="border: 1px solid black; padding: 5px; text-align: center; margin: 10px 0;"> <p>WARNING</p> <p>DO NOT CONNECT 3-PIN GROUNDED PLUG TO 2-PIN OUTLET THROUGH AN ADAPTER. ELECTRICAL SHOCK MAY RESULT.</p> </div> <p>c. For DC operation, connect cigarette lighter adapter of DC power cable to cigarette lighter socket.</p> <p>d. Set the PWR/OFF/BATT Switch on front panel to "PWR" or "BATT" position as required.</p>

Condition	Procedure
Emergency	If battery weakens and recharging is not practical, first disconnect power from UUT (if UUT is connected), then set PWR/OFF/BATT Switch on front panel to "OFF" position, connect external AC or DC power supply as specified in paragraphs a, b, or c, then set PWR/OFF/BATT Switch to "PWR" position. Finally, connect power to UUT (if UUT is connected).
Stopping	Disconnect power from UUT (if UUT is connected). Set PWR/OFF/BATT Switch on front panel to "OFF" position if operating with AC/DC power and "BATT" position if operating with internal battery. Disconnect UUT from AN/GRM-114A. Remove either 3-pin grounded plug (AC power cable) from 3-pin grounded outlet, or cigarette lighter adapter from cigarette lighter socket; then remove power cable plug from socket on rear panel.

Table 2-3 AN/GRM-114A RF Signal Generator Operating Instructions

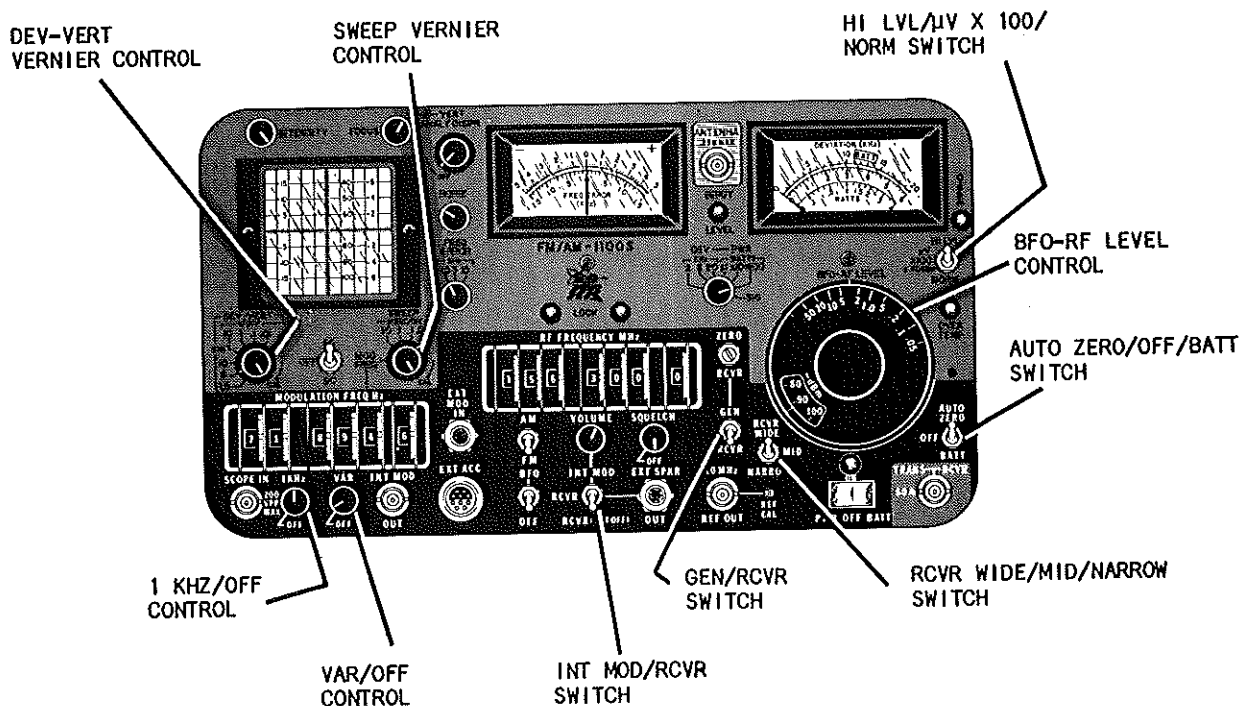


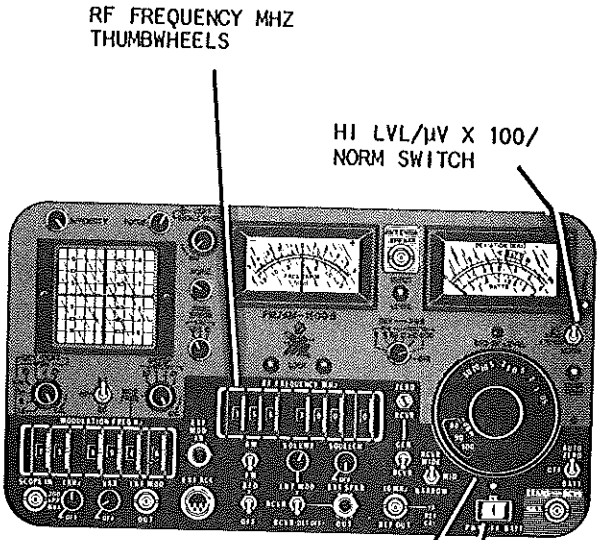
Figure 2-7 FM/AM-1100S Initial Adjustments and Control Settings for RF Signal Generator Operation

CONTROL

INITIAL SETTING

HI LVL/ μ V X 100/NORM Switch
 BFO-RF LEVEL Control
 AUTO ZERO/OFF/BATT Switch
 RCVR WIDE/MID/NARROW Switch
 GEN/RCVR Switch
 INT MOD/RCVR Switch
 VAR/OFF Control
 1 kHz/OFF Control
 DEV-VERT VERNIER Control
 SWEEP VERNIER Control
 PWR/OFF/BATT Switch

"NORM"
 Fully ccw
 "AUTO ZERO"
 "NARROW"
 "GEN"
 "RCVR"
 Fully ccw, detent "OFF"
 Fully ccw, detent "OFF"
 Fully cw, detent "CAL"
 Fully cw, detent "CAL"
 "PWR" or "BATT"

STEP	PROCEDURE	ILLUSTRATION
1	Set RF FREQUENCY MHz Thumbwheels to desired RF frequency output.	
2	<p>For an RF output less than 50 μV, set HI LVL/μV X 100/NORM Switch to "NORM" and rotate BFO-RF LEVEL Control to desired μV setting.</p> <p style="text-align: center;">NOTE</p> <p>RF output in dBm is indicated by the reading on the dBm scale.</p> <p>The AN/GRM-114A is now generating RF signals at the desired frequency and output level.</p>	
3	<p>For an RF output level greater than 50 μV (but less than 5000 μV):</p> <p>a. Place HI LEVEL/μV X 100/NORM Switch to "μV X 100" position.</p> <p>b. Rotate BFO-RF LEVEL Control to desired μV setting. The AN/GRM-114A is now generating RF signals at desired frequency and output level.</p>	

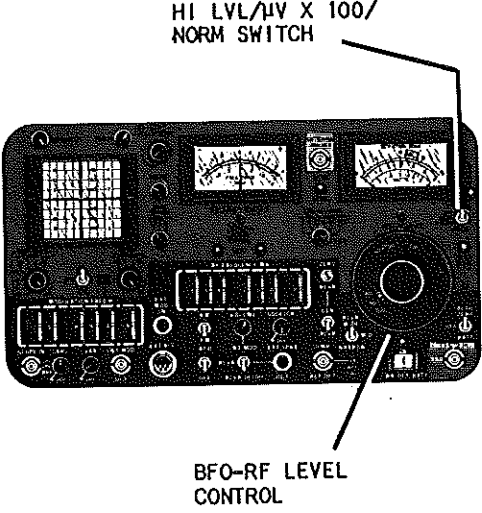
STEP	PROCEDURE	ILLUSTRATION
3	<p>(Continued)</p> <p style="text-align: center;">NOTE</p> <p>RF output level in μV is now 100 times the setting of BFO-RF LEVEL Control on μV scale.</p> <p>Equivalent RF output level in dBm can be determined by mathematically adding +40 dBm to reading on dBm scale.</p>	
4	<p>For an RF output level greater than -35 dBm:</p> <ol style="list-style-type: none"> a. Place HI LVL/μV X 100/NORM Switch to "HI LVL" position. b. Slowly rotate BFO-RF LEVEL Control cw until 0 dBm Lamp lights. c. Record setting of BFO-RF LEVEL Control on dBm scale. d. Add result obtained in Step 4c to desired RF output level in dBm. Record result. e. Rotate BFO-RF LEVEL Control to setting obtained in Step 4d. f. The AN/GRM-114A is now generating RF signals at desired frequency and output level. 	 <p>The illustration shows the front panel of the AN/GRM-114A. Two callout lines point to specific controls: one points to a switch at the top right labeled 'HI LVL/μV X 100/NORM SWITCH', and another points to a large rotary knob on the right side labeled 'BFO-RF LEVEL CONTROL'. The panel features several meters, a digital display, and various indicator lights.</p>

Table 2-4 AN/GRM-114A RF Signal Generator Operating Instructions for AM RF Signals

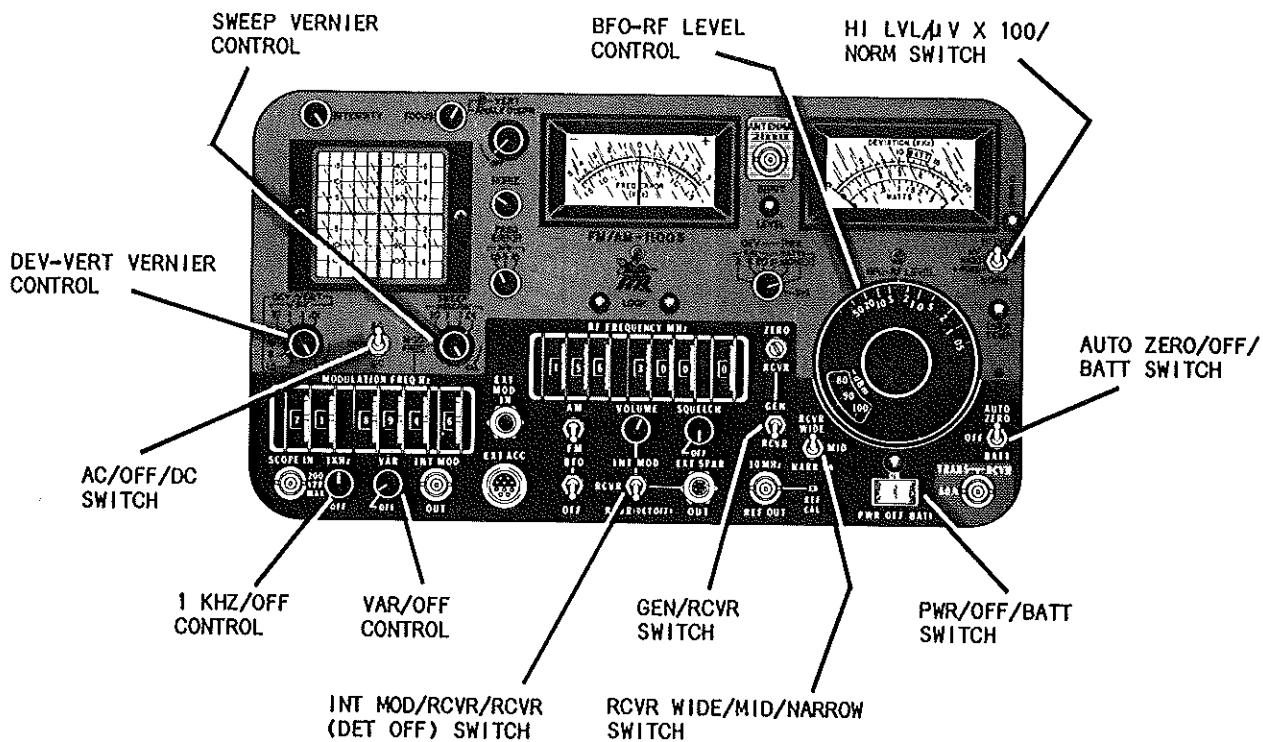
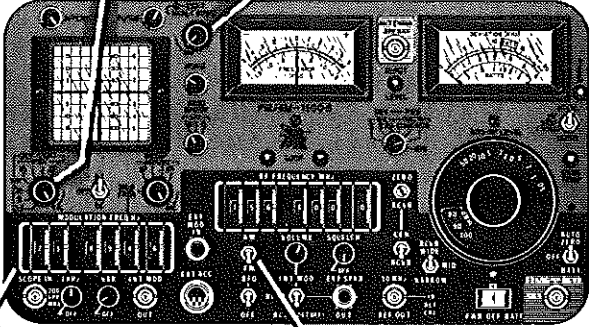
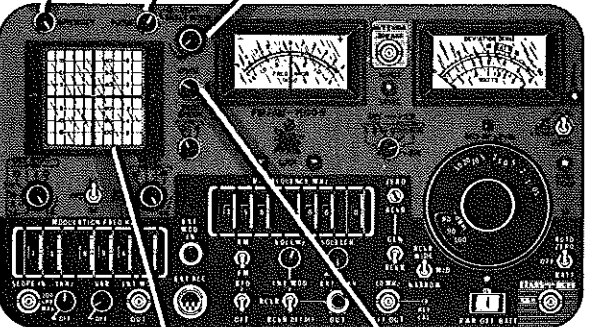


Figure 2-8 FM/AM-1000S Initial Adjustments and Control Settings for Generating AM RF Signals

CONTROL

INITIAL SETTING

HI LVL/ μ V X 100/NORM Switch	"NORM"
BFO-RF LEVEL Control	Fully ccw
AUTO ZERO/OFF/BATT Switch	"AUTO ZERO"
RCVR WIDE/MID/NARROW Switch	"NARROW"
GEN/RCVR Switch	"GEN"
INT MOD/RCVR Switch	"RCVR"
VAR/OFF Control	Fully ccw, detent "OFF"
1 kHz/OFF Control	Fully ccw, detent "OFF"
DEV-VERT VERNIER Control	Fully cw, detent "CAL"
SWEEP VERNIER Control	Fully cw, detent "CAL"
SWEEP Control	10 μ Sec
AC/OFF/DC Switch	"AC"
PWR/OFF/BATT Switch	"PWR" or "BATT"

STEP	PROCEDURE	ILLUSTRATION
1	Set AM/FM Switch to "AM".	
2	Set MODULATION FREQ Hz Thumbwheels to desired tone modulation frequency.	
3	Rotate ANALY/DISPR Control fully ccw to detent position.	
4	Place DEV-VERT Control to either the "1.5 kHz", "6 kHz" or "15 kHz" position. <div style="border: 1px solid black; padding: 5px; margin: 10px 0;"> <p style="text-align: center;">CAUTION</p> <p>WHEN APPLYING POWER TO OSCILLOSCOPE OR SPECTRUM ANALYZER THROUGH PWR/OFF/BATT SWITCH OR AC/OFF/DC SWITCH, MAKE SURE INTENSITY CONTROL IS AT MODERATE (LEFT) POSITION.</p> </div>	
5	Adjust INTENSITY Control cw and FOCUS Control for a sharp visible trace display. Set PWR/OFF/BATT Switch to "PWR" position.	
6	Adjust VERT Control and HORIZ Control to obtain a centered trace, with lower edge of displayed carrier aligned with horizontal axis.	
7	Measure peak-to-peak amplitude (in graticule divisions) of displayed carrier. Record result.	
8	Apply result obtained in Step 7 to the following equation: $X = \frac{(\text{DESIRED \% MOD}) \times (\text{RESULT OF STEP 7})}{100}$ Where: X = number of graticule divisions (peak-to-peak) of modulated signal.	

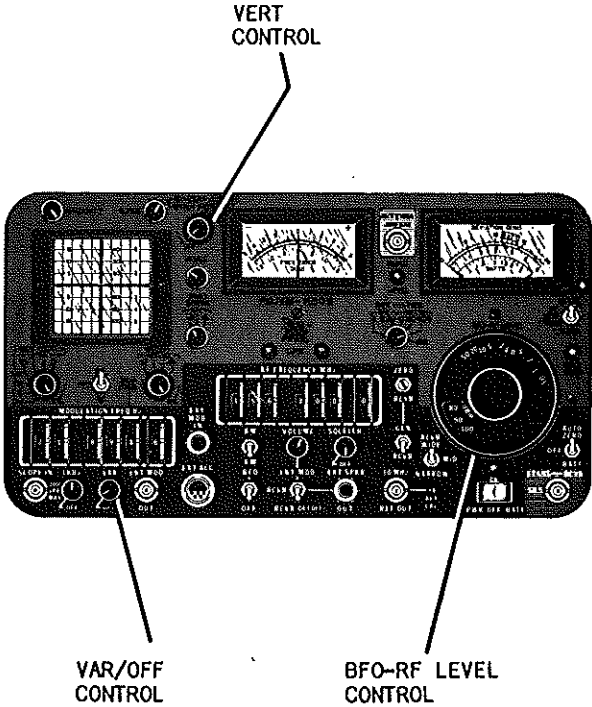
STEP	PROCEDURE	ILLUSTRATION
9	<p style="text-align: center;">NOTE</p> <p>Steps 9a and b must be performed simultaneously, as one will affect the other.</p> <p>a. Adjust VERT Control to align negative peak of the modulated signal with the horizontal axis.</p> <p>b. Rotate VAR/OFF Control to adjust peak-to-peak amplitude of the same modulated signal (in graticule divisions) to the value of x obtained in Step 8.</p> <p>c. The signal generator is now calibrated to the desired percent modulation and is generating at the selected frequency and output level.</p>	
10	<p>To measure SINAD sensitivity, perform Steps 5, 6 and 7 in Table 2-16, then proceed to Step 11 this procedure.</p>	
11	<p>Rotate BFO-RF/LEVEL Control until MM-100E display indicates desired SINAD level. BFO-RF LEVEL Control will now indicate UUT sensitivity.</p> <p style="text-align: center;">NOTE</p> <p>If HI LVL/μV X 100/NORM Switch is in "μV X 100" position, multiply μV setting on BFO-RF LEVEL Control by 100 or add 40 dB to reading to obtain correct UUT sensitivity.</p>	
12	<p>Emergency operating procedures: Refer to Table 2-2.</p>	
13	<p>Stopping procedures: Refer to Table 2-2.</p>	

Table 2-5 AN/GRM-114A RF Signal Generator Operating Instructions for Generating FM RF Signals

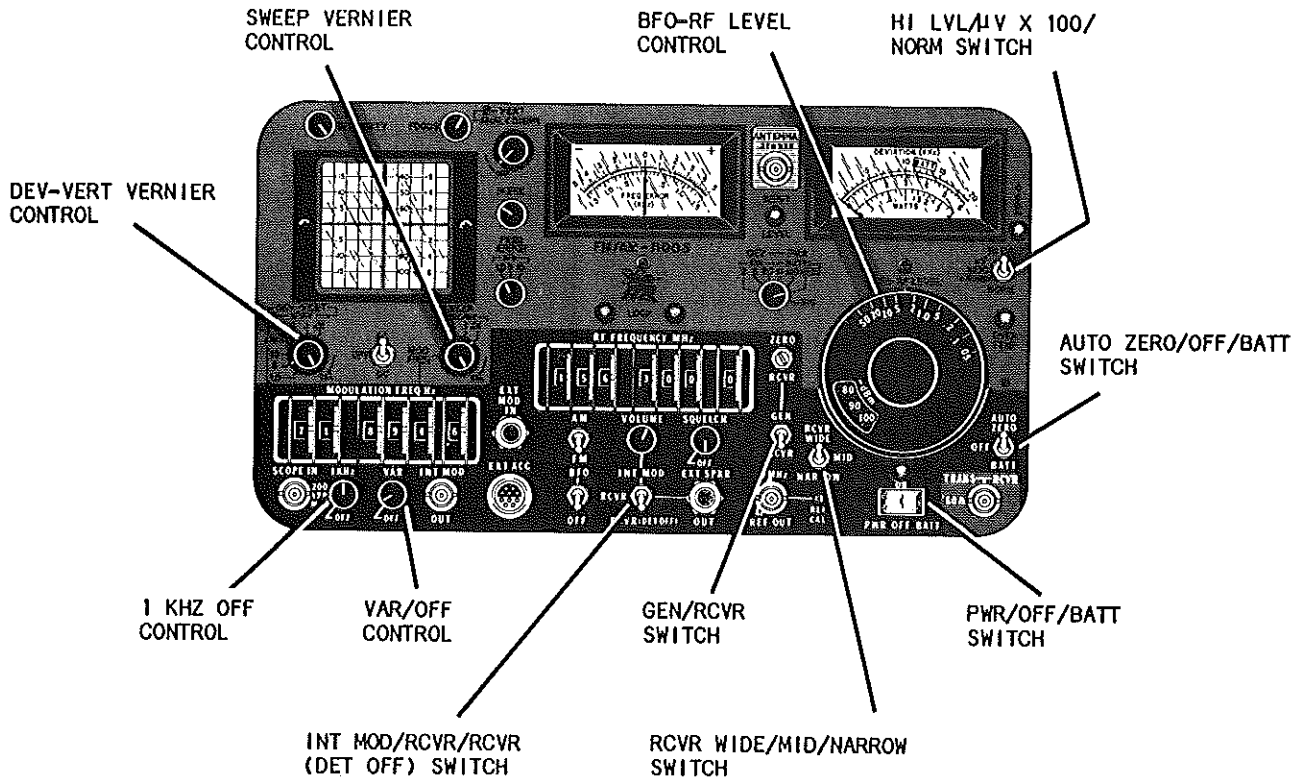


Figure 2-9 FM/AM-1100S Initial Adjustments and Control Settings for Generating FM RF Signals

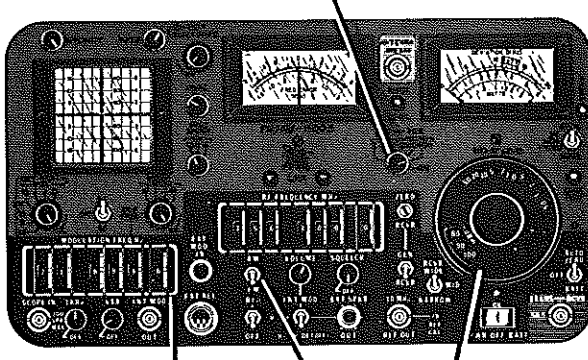
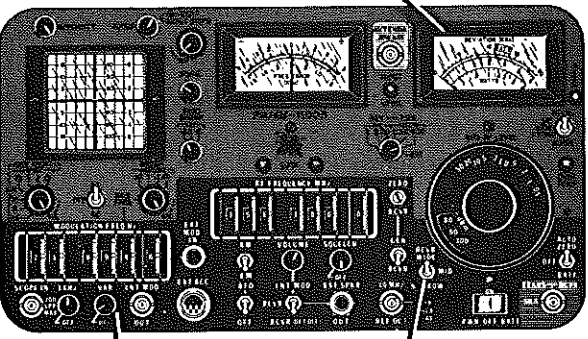
CONTROL

INITIAL SETTING

HI LVL/ μ V X 100/NORM Switch
 BFO-RF LEVEL Control
 AUTO ZERO/OFF/BATT Switch
 RCVR WIDE/MID/NARROW Switch
 GEN/RCVR Switch
 INT MOD/RCVR/RCVR (DET OFF) Switch
 VAR/OFF Control
 1 kHz/OFF Control
 DEV-VERT VERNIER Control
 SWEEP VERNIER Control
 PWR/OFF/BATT Switch

"NORM"
 Fully ccw
 "AUTO ZERO"
 "NARROW"
 "GEN"
 "RCVR"
 Fully ccw, detent "OFF"
 Fully ccw, detent "OFF"
 Fully cw, detent "CAL"
 Fully cw, detent "CAL"
 "PWR" or "BATT"

STEP	PROCEDURE	ILLUSTRATION
1	Perform Steps 1 thru 4 in Table 2-3 for generating RF signals.	

STEP	PROCEDURE	ILLUSTRATION	
2	Set AM/FM Switch to "FM" position.		
3	Set MODULATION FREQ Hz Thumbwheels to desired tone modulation frequency.		
4	Place DEV/PWR Control to desired deviation range (2, 6, or 20 kHz).	 <p data-bbox="1088 231 1185 283">DEV/PWR CONTROL</p> <p data-bbox="1079 714 1169 766">AM/FM SWITCH</p> <p data-bbox="812 829 1039 882">MODULATION FREQ HZ THUMBWHEELS</p> <p data-bbox="1218 829 1380 882">BFO-RF LEVEL CONTROL</p>	
5	To measure SINAD sensitivity, perform Steps 5, 6 and 7 in Table 2-16, then proceed to Step 6 this procedure.		
6	Rotate BFO-RF LEVEL Control until MM-100E display indicates desired SINAD level. BFO-RF LEVEL Control will now indicate UUT sensitivity. <p data-bbox="422 882 527 924">NOTE</p> <p data-bbox="267 934 730 1165">If HI LVL/μV X 100/NORM Switch is in μV X 100 position, multiply μV setting on BFO-RF LEVEL Control by 100 or add 40 dB to reading to obtain correct UUT sensitivity.</p>		
7	Rotate VAR/OFF Control cw while observing DEVIATION/WATTS Meter until meter indicates desired deviation on appropriate scale (2, 6 or 20 kHz). The AN/GRM-114A is now generating frequency modulated RF signals within the desired deviation range. <p data-bbox="430 1522 535 1564">NOTE</p> <p data-bbox="267 1575 771 1711">If deviation is above 5 kHz, place RCVR WIDE/MID/NARROW Switch to "MID" or "WIDE" position.</p>	 <p data-bbox="998 1123 1201 1176">DEVIATION/WATTS METER</p> <p data-bbox="860 1617 958 1669">VAR/OFF CONTROL</p> <p data-bbox="998 1711 1266 1764">RCVR WIDE/MID/NARROW SWITCH</p>	

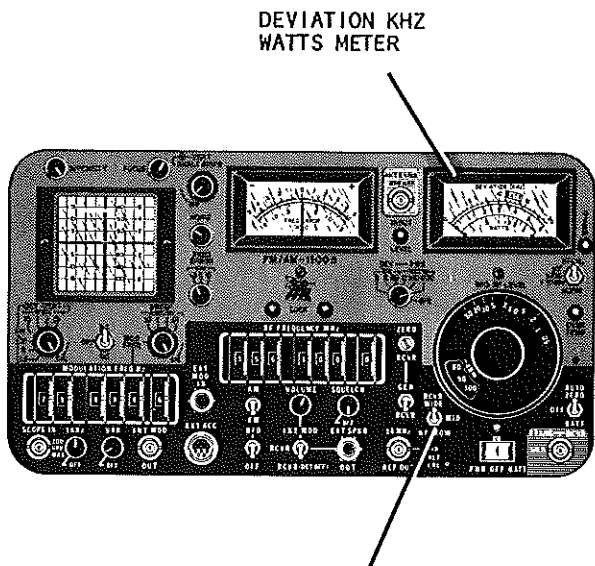
STEP	PROCEDURE	ILLUSTRATION
7	<p>(Continued)</p> <p style="text-align: center;">NOTE</p> <p>Signals at a 1 kHz rate with more than 5 kHz deviation must be monitored with RCVR WIDE/MID/NARROW Switch in "MID" position.</p> <p>Signals modulated above 2 kHz should be monitored with RCVR WIDE/MID/NARROW Switch in "WIDE" position. Note residual modulation indication due to noise on DEVIATION (kHz)/WATTS Meter; add this value to desired value.</p>	
8	<p>Emergency operating procedures: Refer to Table 2-2.</p>	
9	<p>Stopping procedures: Refer to Table 2-2.</p>	

Table 2-6 AN/GRM-114A Oscilloscope Operating Procedures

WARNING

DO NOT APPLY MORE THAN 200 VOLTS (PEAK-TO-PEAK) TO SCOPE-IN CONNECTOR. IF AN OSCILLOSCOPE PROBE IS USED TO APPLY A SIGNAL FROM A UUT TO THE SCOPE-IN CONNECTOR, ATTACH THE GROUND LEAD OF THE PROBE TO UUT GROUND.

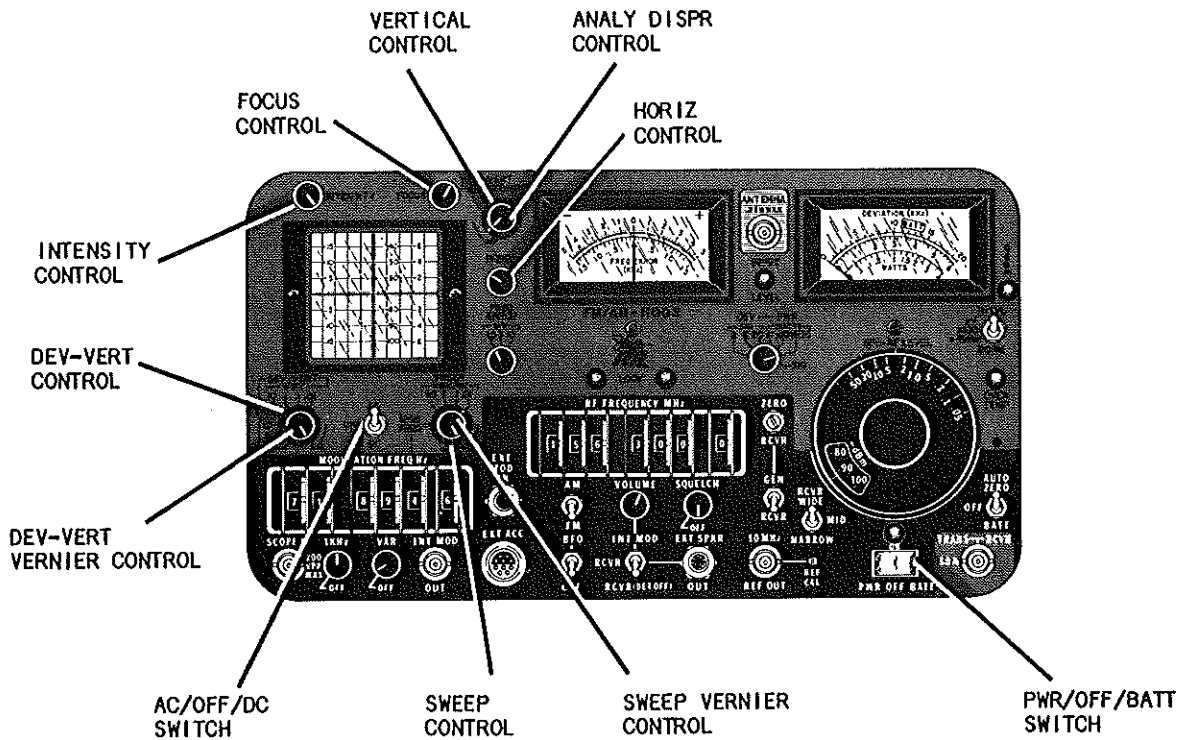


Figure 2-10 FM/AM-1100S Initial Adjustments and Control Settings for Oscilloscope Operation

CONTROL

INITIAL SETTING

- SWEEP Control "1 ms"
- SWEEP VERNIER Control Fully cw, detent "CAL"
- AC/OFF/DC Switch "AC"
- DEV-VERT VERNIER Control Fully cw, detent "CAL"
- DEV-VERT Control "10 V/DIV"
- INTENSITY Control Midrange
- HORIZ Control Midrange
- FOCUS Control Midrange
- VERT Control Midrange
- ANALY DISPR/OFF Control Fully ccw detent "OFF"
- PWR/OFF/BATT Switch "PWR" or "BATT"

STEP	PROCEDURE	ILLUSTRATION
	<p style="text-align: center;">NOTE</p> <p>Warm-up time for the CRT is approximately 30 seconds from a "COLD" start-up. The trace will not appear until the CRT warms up.</p>	

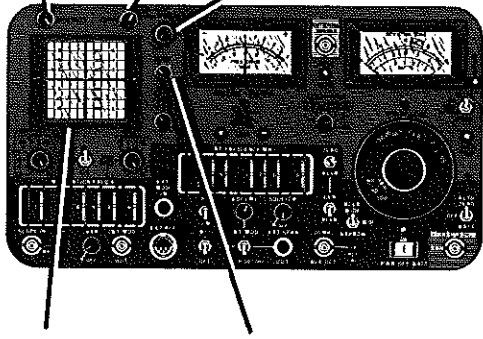
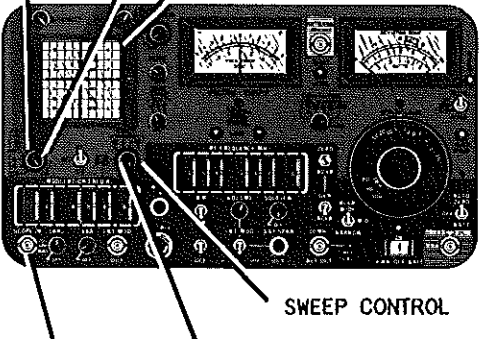
STEP	PROCEDURE	ILLUSTRATION
1	Adjust INTENSITY Control cw and FOCUS Control appropriately to obtain a sharp visible trace display.	 <p>INTENSITY CONTROL</p> <p>FOCUS CONTROL</p> <p>VERT CONTROL</p> <p>CRT DISPLAY</p> <p>HORIZ CONTROL</p>
2	Adjust VERT Control and HORIZ Control to center scope trace over horizontal axis of CRT.	
3	Connect UUT signal to SCOPE-IN Connector.	
4	Adjust SWEEP Control, DEV-VERT Control and SWEEP VERNIER Control to obtain a stable waveform.	
<p style="text-align: center;">NOTE</p> <p style="text-align: center;">DEV-VERT VERNIER Control must remain in "CAL" position (fully cw, detent).</p>		 <p>DEV-VERT CONTROL</p> <p>DEV-VERT VERNIER CONTROL</p> <p>CRT DISPLAY</p> <p>SWEEP CONTROL</p> <p>SCOPE IN CONNECTOR</p> <p>SWEEP VERNIER CONTROL</p>
5	Disconnect the UUT Signal from the SCOPE-IN Connector.	
6	Emergency operating procedures (battery weakening) in Table 2-2.	
7	<p>Stopping procedures:</p> <p>a. Set AC/DC/OFF Switch to "OFF" position.</p> <p>b. For further stopping procedures, refer to Table 2-2.</p>	

Table 2-7 AN/GRM-114A Receiver Operating Instructions

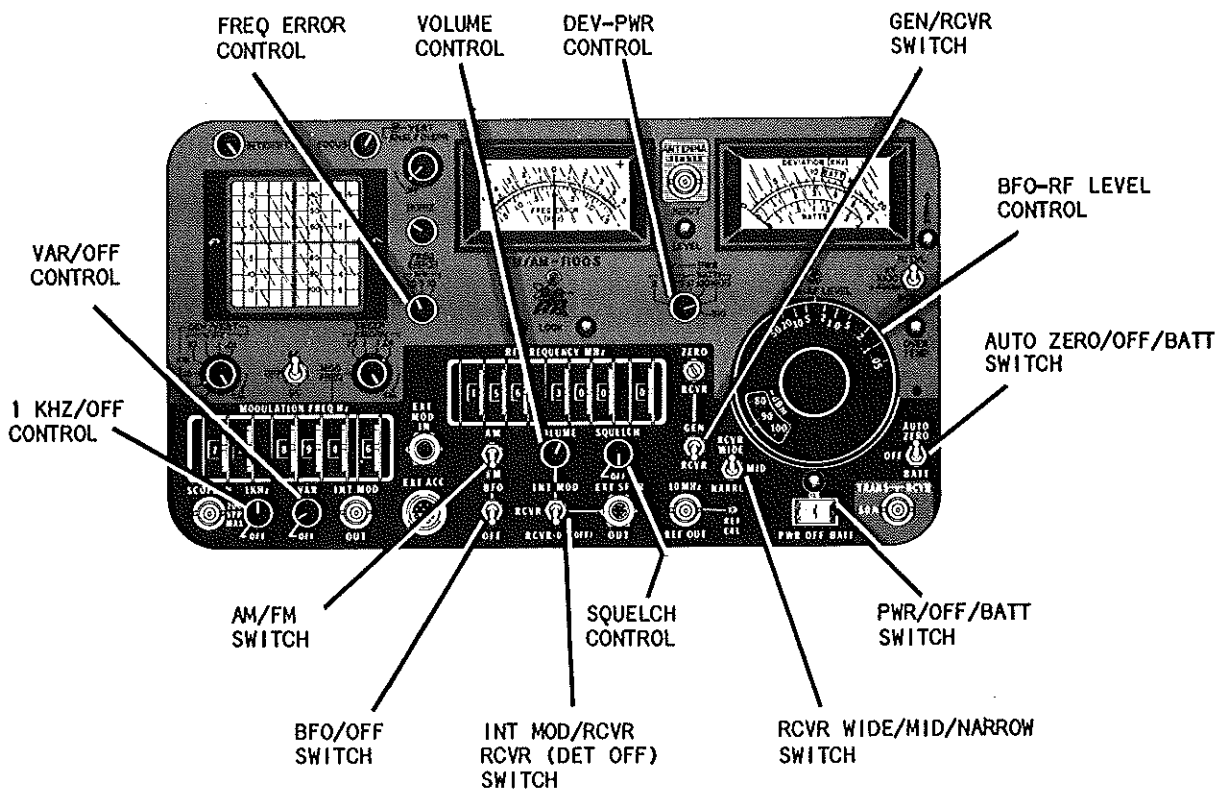
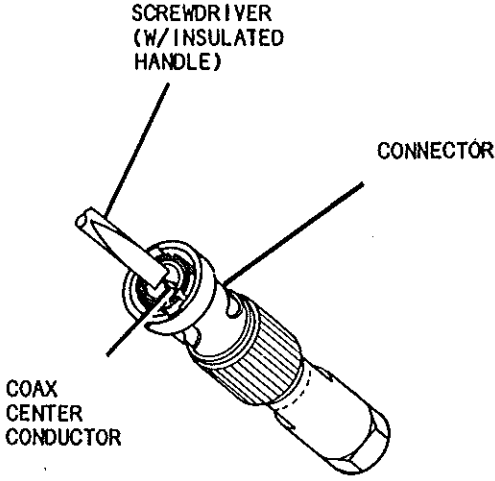
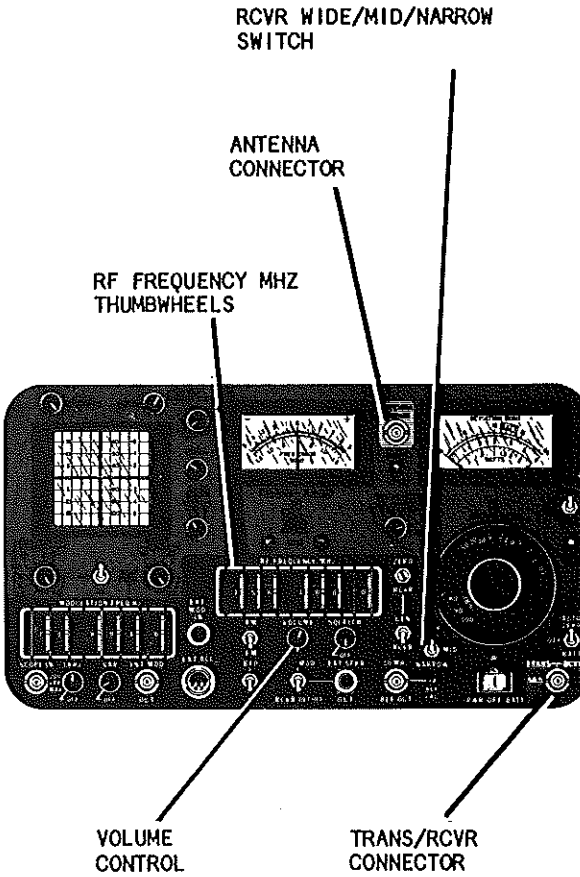
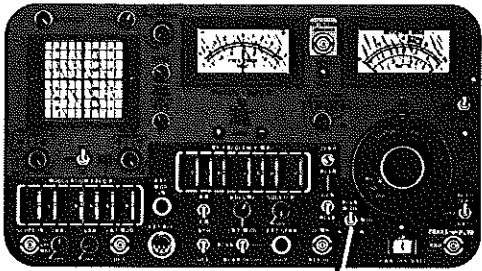
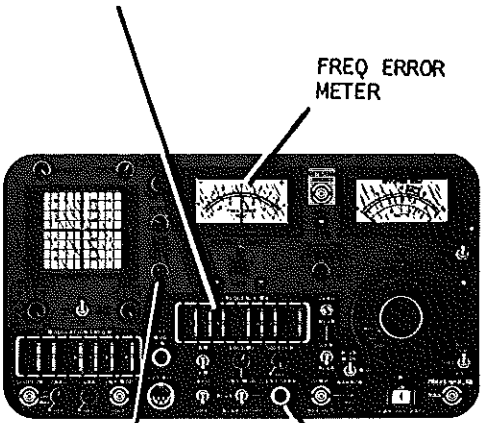


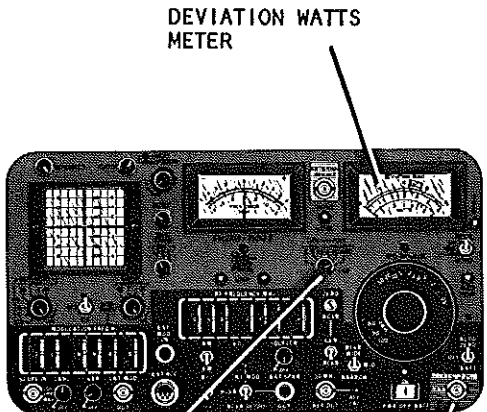
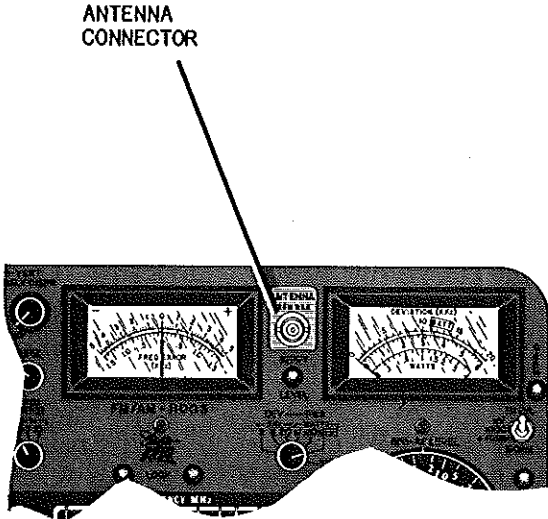
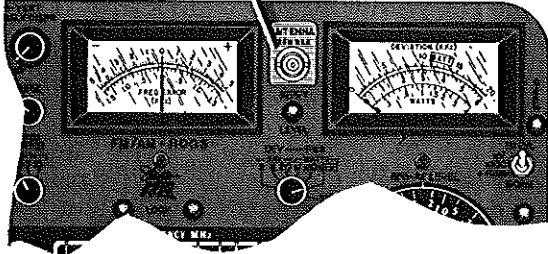
Figure 2-11 FM/AM-1100S Initial Adjustments and Control Settings for Receiver Operation

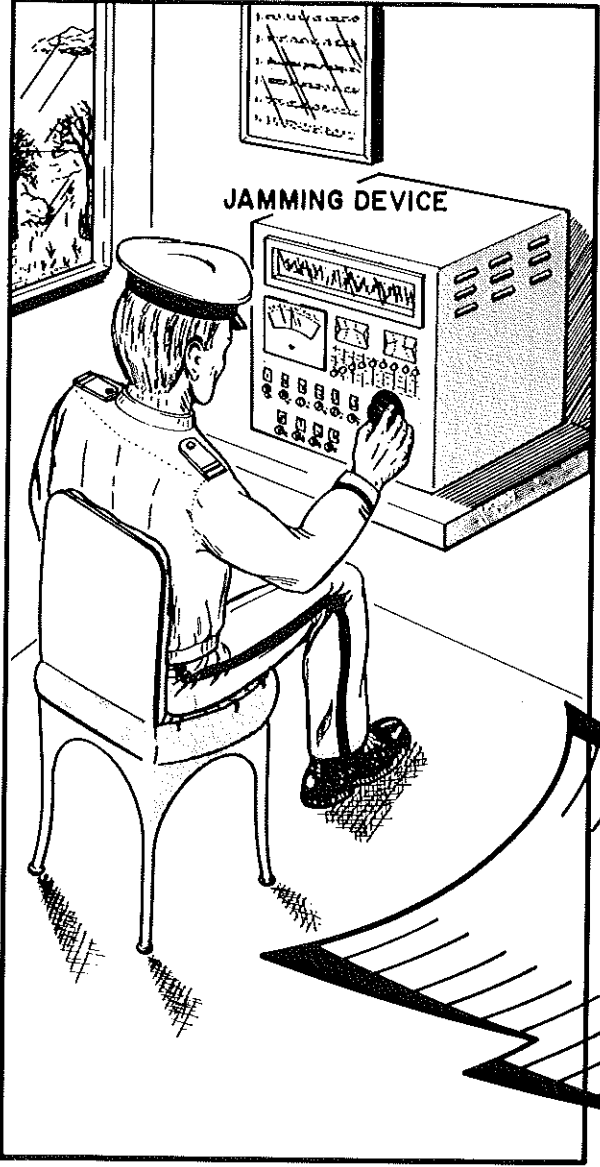
CONTROL	INITIAL SETTING
DEV/PWR Control	"SIG"
GEN/RCVR Switch	"RCVR"
RCVR WIDE/MID/NARROW Switch	"WIDE"
BFO-RF LEVEL Control	Fully ccw
AUTO ZERO/OFF/BATT Switch	"AUTO ZERO"
SQUELCH/OFF Control	Fully ccw, short of detent
INT MOD/RCVR Switch	"RCVR"
VOL Control	Fully ccw
BFO/OFF Switch	"OFF"
AM/FM Switch	"AM" or "FM" (depending on mode of signal to be received)
1 kHz/OFF Control	Fully ccw, detent "OFF"
VAR/OFF Control	Fully ccw, detent "OFF"
FREQ ERROR Control	"15 kHz"
PWR/OFF/BATT Switch	"PWR" or "BATT"

STEP	PROCEDURE	ILLUSTRATION
	<p style="text-align: center;">CAUTION</p> <p>DO NOT CONNECT A TRANSMITTER TO THE ANTENNA CONNECTOR. CONNECT ONLY AN EXTERNAL ANTENNA TO THE ANT INPUT CONNECTOR.</p> <p>MAXIMUM CONTINUOUS INPUT TO THE ANTENNA CONNECTOR MUST NOT EXCEED 0.25 W.</p> <p>DO NOT EXCEED 200 V (PEAK-TO-PEAK) INTO THE SCOPE IN CONNECTOR.</p> <p style="text-align: center;">NOTE</p> <p>Remove any static discharge from an unterminated antenna before connecting it to the AN/GRM-114A.</p>	 <p style="text-align: center;">TOUCH SCREWDRIVER BLADE TO COAX CENTER CONDUCTOR AND CONNECTOR COLLAR SIMULTANEOUSLY TO DISCHARGE STATIC BUILDUP</p>
<p>1</p>	<p>Select one of the following methods of signal reception:</p> <p style="padding-left: 40px;">a. External antenna</p> <p>Connect external antenna to ANTENNA Connector for "off-the-air" monitoring. Proceed to Step 3.</p> <p style="text-align: center;">CAUTION</p> <p>SEE SPECIFICATIONS ON PAGE 1-9 FOR POWER MONITOR INPUT POWER REQUIREMENTS.</p>	

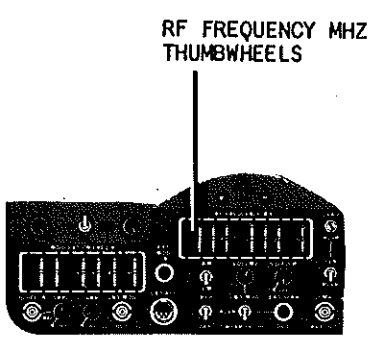
STEP	PROCEDURE	ILLUSTRATION
1	<p>(Continued)</p> <p>b. Direct Cable Connection from UUT</p> <p>Connect cable from UUT to TRANS/RCVR Connector.</p> <p>Maximum operating "ON" time for measurement of transmitter output, as indicated on DEVIATION/WATTS Meter, using TRANS/RCVR Connector is:</p> <p>635 WPEP; 1 Minute ON, 5 Minutes OFF.</p> <p>100 W; 15 Minutes ON, 10 Minutes OFF.</p> <p>65 W; Continuous</p>	
2	Apply power to UUT (if applicable).	
3	Set RF FREQUENCY MHz Thumbwheels to the frequency of signal to be received.	
4	Adjust VOLUME Control to a comfortable listening level.	
5	<p>If an area of the spectrum is being monitored where frequency channels are packed closely together, bandwidth of signal may be reduced by placing RCVR WIDE/MID/NARROW Switch to "MID" or "NARROW" setting.</p> <p>When monitoring FM signals, the NARROW setting of RCVR WIDE/MID/NARROW Switch will not accommodate greater than 5 kHz FM deviation of FM transmitters. If FM deviation is more than 5 kHz, place RCVR WIDE/MID/NARROW Switch to "MID" position.</p>	

STEP	PROCEDURE	ILLUSTRATION
5	<p>(Continued)</p> <p style="text-align: center;">NOTE</p> <p>Ensure that proper band-pass width has been selected on RCVR WIDE/MID/NARROW Switch. Too high a bandpass will cause higher noise reading. Too low a bandpass will cause distortion.</p>	 <p style="text-align: center;">RCVR WIDE/MID/NARROW SWITCH</p>
6	<p>Fine tune the receiver to center frequency (within 100 Hz) as follows:</p> <p>a. If FREQ ERROR Meter appears centered at zero, proceed to Step 6b; if meter needle is not centered, increase or decrease settings of RF FREQUENCY MHz Thumbwheels in 10 kHz and 1 kHz steps to center needle as closely as possible to zero, then proceed to Step 6b.</p> <p>b. Rotate FREQ ERROR Control to "5 kHz" position. If FREQ ERROR Meter remains centered at zero, proceed to Step 6c; if meter needle deviates from zero, increase or decrease settings of RF FREQUENCY MHz Thumbwheels in 1 kHz steps to center needle as closely as possible to zero, then proceed to Step 6c.</p> <p>c. Rotate FREQ ERROR Control to "1.5 kHz" position. Increase or decrease settings of RF FREQUENCY MHz Thumbwheels in 100 Hz steps until meter needle is centered at zero. Setting of RF FREQUENCY MHz Thumbwheels now reflects frequency of received signal.</p>	 <p style="text-align: center;">RF FREQUENCY MHZ THUMBWHEELS</p> <p style="text-align: center;">FREQ ERROR METER</p> <p style="text-align: center;">FREQ ERROR CONTROL</p> <p style="text-align: center;">SQUELCH ON/OFF SWITCH</p>

STEP	PROCEDURE	ILLUSTRATION
7	<p>If received signal is being monitored through a direct cable connection at TRANS/RCVR Connector, set DEV/PWR Control to "WATTS X 10". If DEVIATION (kHz)/WATTS Meter reading is under 4 watts (on red scale), set DEV/PWR Control to "WATTS X 1".</p>	 <p>DEVIATION WATTS METER</p> <p>DEV/PWR CONTROL</p> <p>TRANS/RCVR CONNECTOR</p>
8	<p>Output power of UUT can now be measured on red scale of DEVIATION (kHz)/WATTS Meter.</p> <p style="text-align: center;">NOTE</p> <p>For signals received "off-the-air", a representation of relative signal strength can be determined by observing DEVIATION (kHz)/WATTS Meter needle deflection (with DEV/PWR Control in SIG position). As signal strength increases, the meter needle deflection will increase toward the right of meter scale. For exact measurement of "off-the-air" signal strength, refer to the procedures for measuring signal strength under spectrum analyzer operating instructions (Table 2-8).</p>	 <p>ANTENNA CONNECTOR</p>
9	<p>Emergency operation procedures.</p> <p>a. Broken antenna. Remove antenna from ANT INPUT Connector. Remove insulation to expose wire. Butt the two separated ends together and secure with any nonconductive material.</p>	

STEP	PROCEDURE	ILLUSTRATION
9	<p>(Continued)</p> <p>b. Jammed signals. It is likely that under real or simulated tactical conditions, the receiver will be jammed by the enemy. Enemy jamming is done by transmitting a strong signal on the same frequency as that used for communication, making it difficult or impossible to receive the desired signal. Unusual noise or signal strength indications without messages may be caused by enemy jamming, signals from a friendly station, or noise from a local source; or the receiver may be defective. To determine whether or not the interference is originating in the AN/GRM-114A, disconnect and remove the antenna. If the interference continues, the AN/GRM-114A is defective. Enemy jamming signals may be typed as continuous wave or modulated. A jamming signal may be intended to block a single frequency (called spot jamming), or one or several transmitters may be used to jam a block of frequencies (called barrage jamming). Following are several types of jamming signals:</p> <p>(1) CW (continuous wave) jamming. CW jamming is transmitted as a steady carrier. This signal beats with another signal and produces a steady tone or in some cases, a quieting effect. CW jamming signals may also be keyed by using a random on-and-off signal or using actual code characters keyed to the same rate or a little faster than the signal being received.</p>	 <p>The illustration shows a person in a military-style uniform and cap sitting in a chair, operating a large piece of electronic equipment labeled 'JAMMING DEVICE'. The person is holding a microphone or control knob. The device has a control panel with various dials and buttons. In the background, there is a window showing a landscape and a framed document on the wall with some text and a diagram.</p>

STEP	PROCEDURE	ILLUSTRATION
9	<p>(Continued)</p> <p>(2) Modulated jamming. Modulated jamming signals may consist of noise, laughter, singing, music, various tone, or almost any unusual sound, or it may be a combination of these sounds. Various types of modulated jamming signals are explained in the following paragraph.</p> <p>(a) SPARK. This is one of the simplest, most effective, and most easily produced jamming signals. This type of signal sounds very rough, raspy, and sometimes like an operating electric motor with sparking electric brushes. The signal is very broad; therefore, it will interfere with a large number of communication channels.</p> <p>(b) SWEEP-THROUGH. This signal is the result of sweeping or moving a carrier back and forth at a slow or rapid rate. The numerous signals of varying amplitude and frequency produce a sound like that of a low-flying airplane passing overhead. When it is varied rapidly, it is effective against all types of voice signals.</p> <p>(c) STEPPED TONES OR BAGPIPES. This signal usually consists of several separate tones. The tones are transmitted in the order of first increasing and then decreasing pitch, repeated over and over, the audible effect is like the sound of a Scottish bagpipe.</p>	

STEP	PROCEDURE	ILLUSTRATION
9	<p>(Continued)</p> <p>(d) NOISE. Noise is random both in amplitude and frequency. It produces a sound similar to that heard when a receiver is not tuned to a station and the VOLUME Control is turned to maximum.</p> <p>(e) GULLS. This signal consists of a quick rise and fall of a variable audio frequency. The sound is similar to the cry of the sea gull.</p> <p>(f) TONE. This signal consists of a single audio frequency of unvarying tone. Another method of tone jamming is to vary it slowly. This produces a howling sound of varying pitch.</p> <p>(3) Antijamming procedures. When it is determined that the incoming signal is being jammed, notify your immediate superior officer and continue to operate the equipment. To provide maximum intelligibility of jammed signals, follow one of more of the operation procedures given in the following steps. If these procedures do not provide sufficient signal separation, change to an alternate frequency.</p> <p>(a) Detune RF FREQUENCY MHz Thumbwheel switches by several increments on either side of received signal. This may cause some separation of received signal and jamming signal.</p> <p>(b) Vary VOLUME Control. This may reduce jamming signal enough to permit weak signal to be heard.</p>	 <p>RF FREQUENCY MHZ THUMBWHEELS</p>

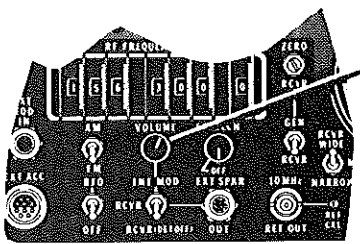
STEP	PROCEDURE	ILLUSTRATION
9	(Continued) (c) Refer to Table 2-2 for further emergency operating procedures (battery weakening).	
10	Stopping procedure: Refer to Table 2-2.	

Table 2-8 AN/GRM-114A Spectrum Analyzer Operating Instructions

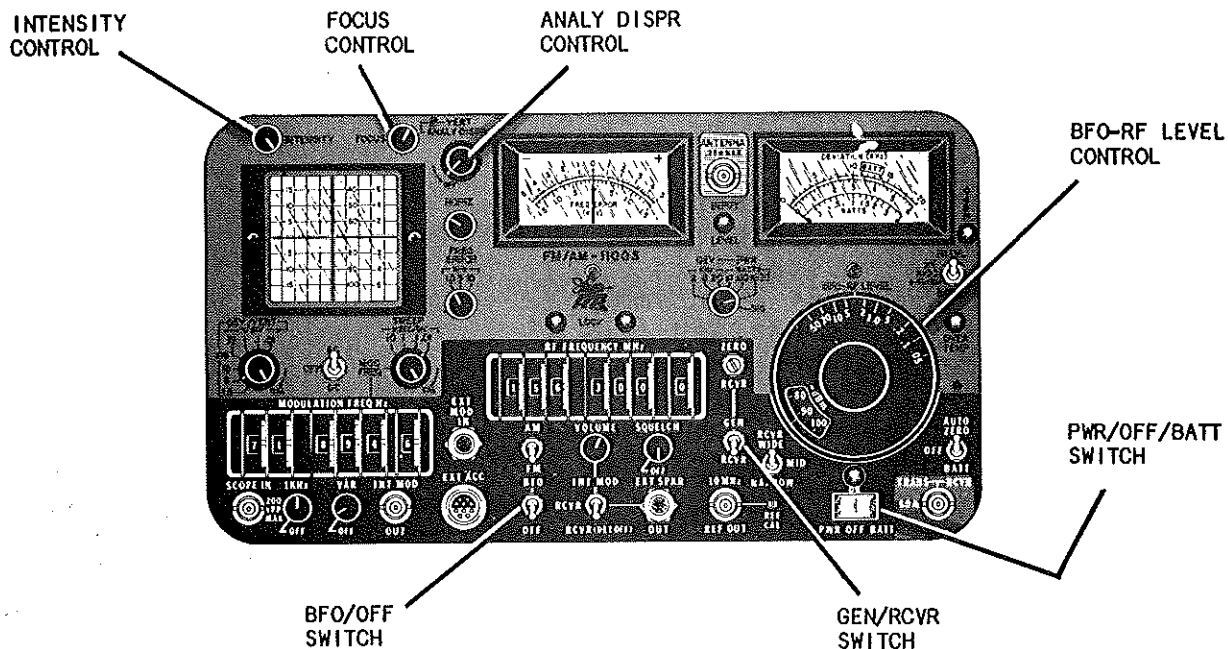
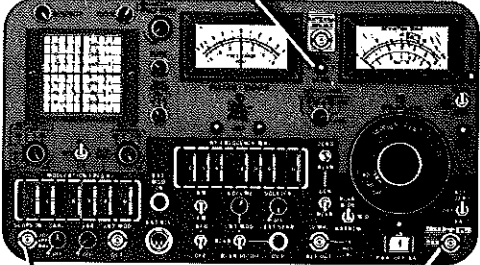
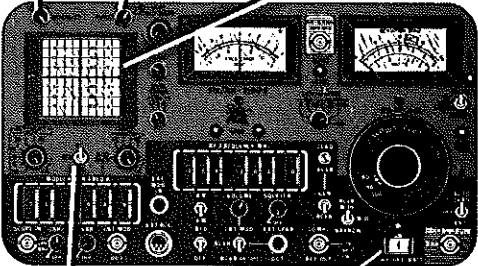
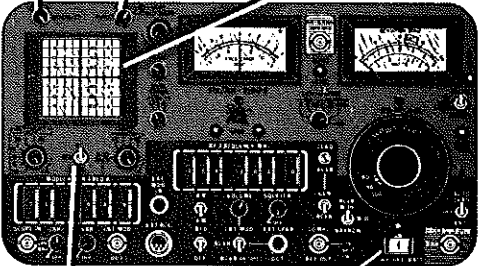
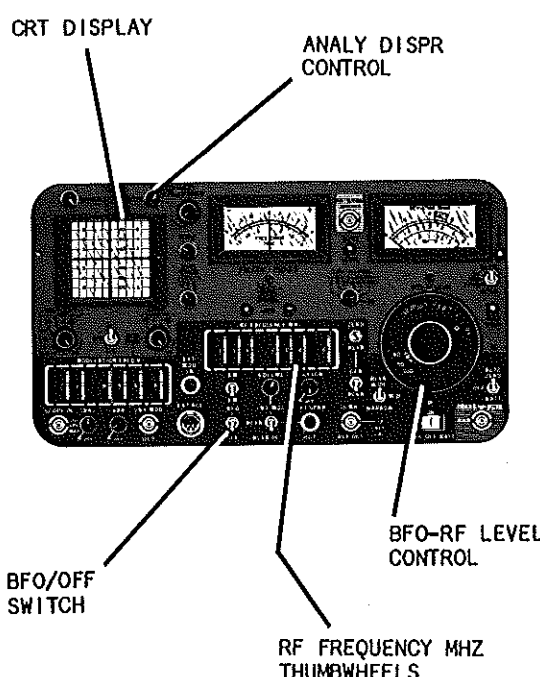
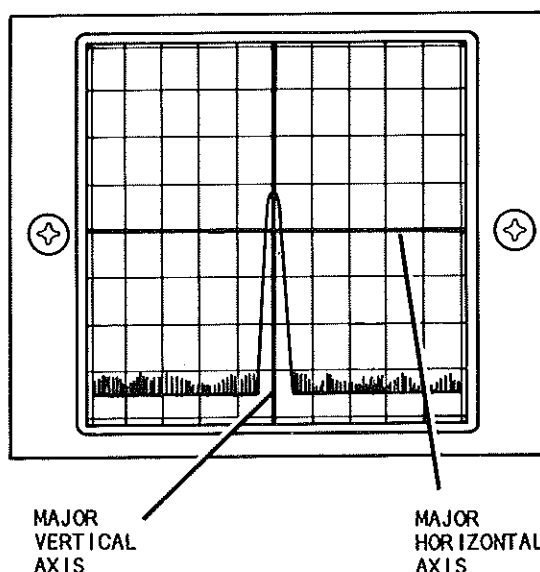


Figure 2-12 FM/AM-1100S Initial Adjustments and Control Settings for Spectrum Analyzer Operation

CONTROL	INITIAL SETTING
BFO-RF LEVEL Control	Fully ccw
GEN/RCVR Switch	"RCVR"
BFO/OFF Switch	"OFF"
ANALY DISPR Control	Fully cw
INTENSITY Control	Midrange
FOCUS Control	Midrange
PWR/OFF/BATT Switch	"PWR" or "BATT"

STEP	PROCEDURE	ILLUSTRATION
	<p style="text-align: center;">NOTE</p> <p>Remove any static discharge from an unterminated antenna before connecting it to the AN/GRM-114A. Perform the following steps to measure signal strength.</p> <div style="border: 1px solid black; padding: 5px; margin: 10px 0;"> <p style="text-align: center;">CAUTION</p> <p>DO NOT EXCEED 200 V (PEAK-TO-PEAK) INTO THE SCOPE IN CONNECTOR.</p> <p>MAXIMUM CONTINUOUS INPUT TO THIS CONNECTOR MUST NOT EXCEED 0.25 W.</p> <p>MAXIMUM INPUT IS -30 dBm FOR PROPER SPECTRUM ANALYZER OPERATION (SIGNALS ABOVE -30 dBm MAY CAUSE SPURIOUS SIGNALS TO BE GENERATED AND DISPLAYED BY AN/GRM-114A).</p> </div>	 <p>ANTENNA CONNECTOR</p> <p>SCOPE IN CONNECTOR</p> <p>TRANS/RCVR CONNECTOR</p>
1	<p>Connect signal stimuli to ANTENNA Connector, or connect transmitter output to TRANS/RCVR Connector.</p> <div style="border: 1px solid black; padding: 5px; margin: 10px 0;"> <p style="text-align: center;">CAUTION</p> <p>WHEN APPLYING POWER TO THE OSCILLOSCOPE OR SPECTRUM ANALYZER FROM PWR/OFF/BATT SWITCH OR AC/DC/OFF SWITCH, MAKE SURE INTENSITY CONTROL IS IN MODERATE (LEFT) POSITION.</p> </div>	 <p>INTENSITY CONTROL</p> <p>FOCUS CONTROL</p> <p>CRT DISPLAY</p> <p>PWR/OFF/BATT SWITCH</p>
2	<p>Adjust INTENSITY Control cw and FOCUS Control appropriately to obtain a sharp visible trace display.</p>	 <p>AC/OFF/DC SWITCH</p>

STEP	PROCEDURE	ILLUSTRATION
2	<p>(Continued)</p> <p style="text-align: center;">NOTE</p> <p>Warm-up time of CRT is approximately 30 seconds from a "cold" startup; trace display will not become visible until CRT achieves warm-up.</p>	
3	Adjust RF FREQUENCY MHz Thumbwheels so that desired signal is aligned along vertical axis of CRT. Signal to be measured is now on center frequency.	
4	Place ANALY DISP Control fully ccw, short of detent position.	
5	Adjust RF FREQUENCY MHz Thumbwheels so desired signal is aligned along vertical axis on CRT.	
6	Measure and record peak of displayed signal along vertical dB scale.	
7	Offset displayed signal to either side of vertical axis two major graticule divisions by increasing or decreasing settings of FREQUENCY MHz Thumbwheels.	
8	Set BFO/OFF Switch to "BFO" position.	
9	Rotate BFO-RF LEVEL Control cw so that injected BFO signal is the same amplitude as the signal under test.	

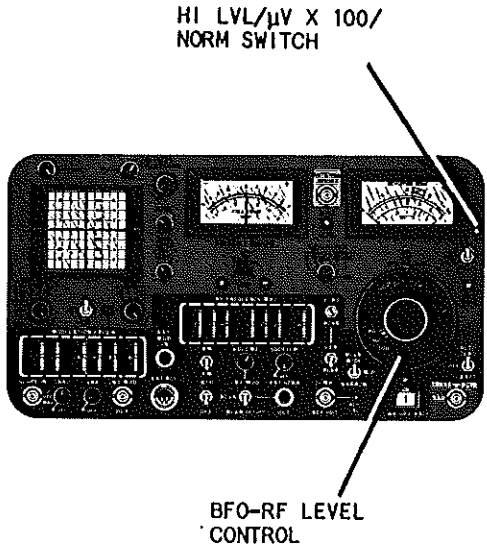
STEP	PROCEDURE	ILLUSTRATION
9	<p>(Continued)</p> <p style="text-align: center;">NOTE</p> <p>If injected BFO signal cannot be raised to the amplitude of the signal under test, set HI LVL/μV X 100/NORM Switch to "μV X 100". Again rotate BFO-RF LEVEL Control cw until injected BFO signal matches the amplitude of signal under test.</p>	
10	<p>Read signal strength of signal under test on μV or dBm scale of BFO-RF LEVEL Control as follows:</p> <p>a. If HI LVL/μV X 100/NORM Switch is at "NORM" position, setting of BFO-RF LEVEL Control represents measured signal strength.</p> <p>b. If HI LVL/μV X 100/NORM Switch is at "μV X 100" position, add +40 dBm to reading of BFO-RF LEVEL Control on dBm scale to obtain true signal strength in dBm. For equivalent signal strength in μV, multiply μV setting of BFO-RF LEVEL Control by 100.</p>	

Table 2-9 AN/GRM-114A Spectrum Analyzer Operating Instructions for Spurious Signal Detection

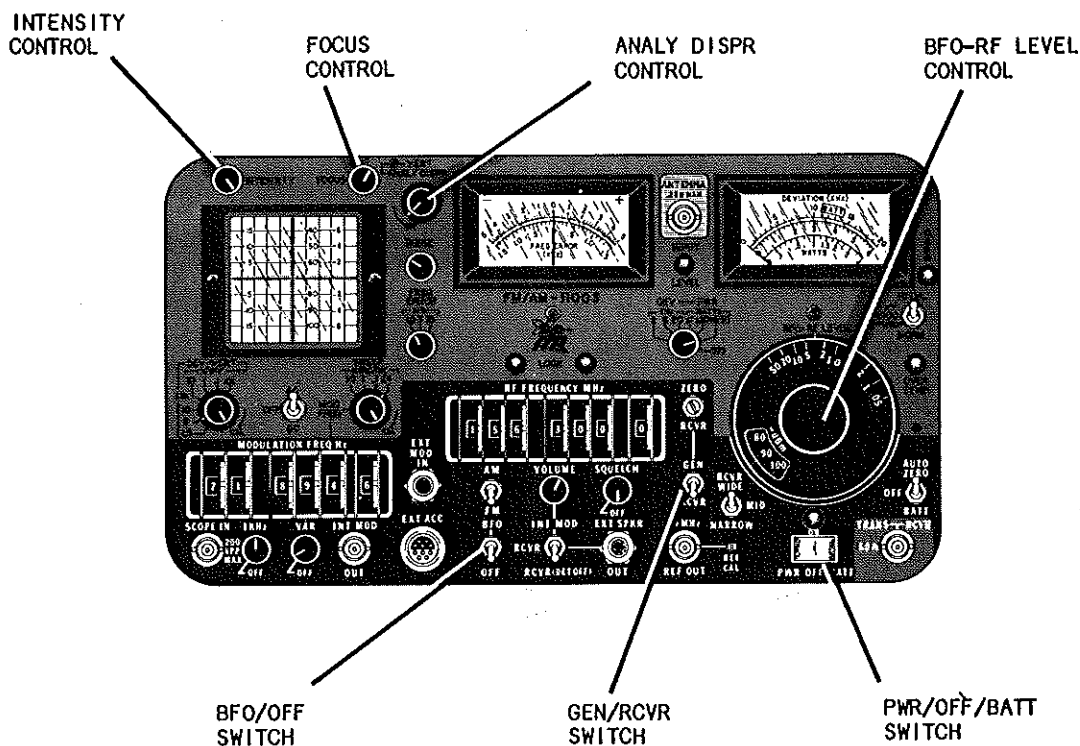


Figure 2-13 FM/AM-1100S Initial Adjustments and Control Settings for Spurious Signal Detection Using Spectrum Analyzer

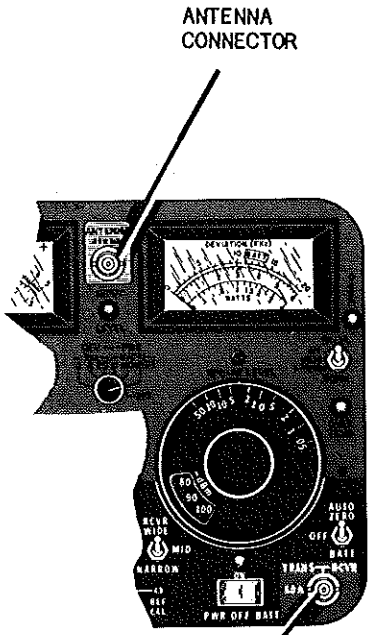
CONTROL

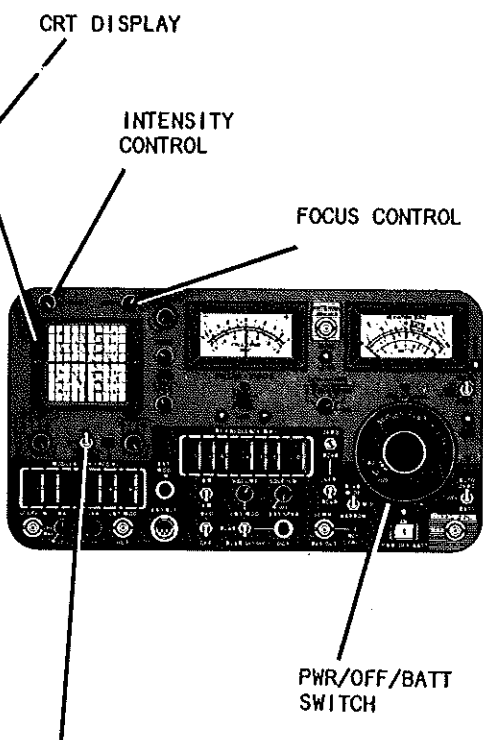

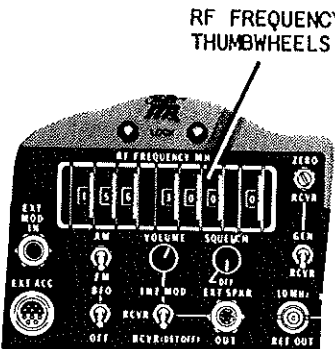
INITIAL SETTING

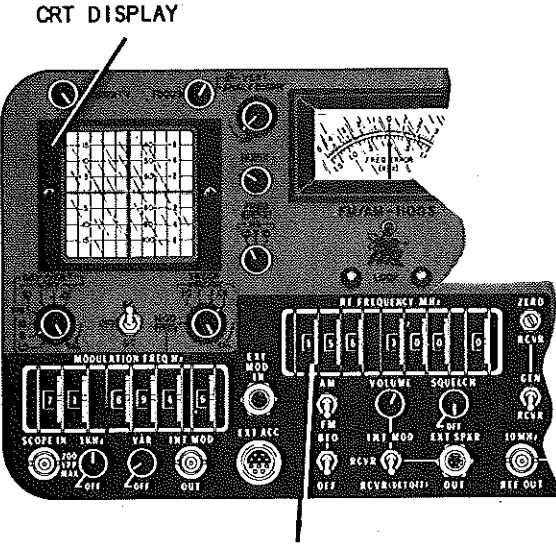
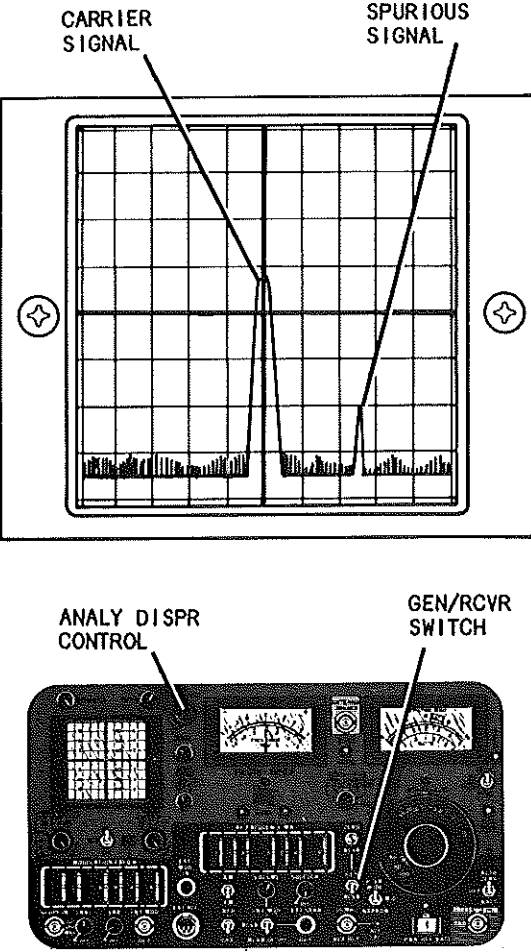
BFO-RF LEVEL Control
 GEN/RCVR Switch
 BFO/OFF Switch
 ANALY DISPR Control
 INTENSITY Control
 FOCUS Control
 PWR/OFF/BATT Switch

Fully ccw
 "RCVR"
 "OFF"
 Fully cw
 Midrange
 Midrange
 "PWR" or "BATT"

STEP	PROCEDURE	ILLUSTRATION
	<p style="text-align: center;">NOTE</p> <p>Remove any static discharge from an unterminated antenna before connecting to the AN/GRM-114A.</p>	

STEP	PROCEDURE	ILLUSTRATION
	<p>(Continued)</p> <p style="text-align: center;">CAUTION</p> <p>DO NOT CONNECT TRANSMITTER TO ANTENNA CONNECTOR. CONNECT ONLY EXTERNAL ANTENNA TO ANTENNA CONNECTOR.</p> <p>MAXIMUM CONTINUOUS INPUT TO ANTENNA CONNECTOR MUST NOT EXCEED 0.25 W.</p> <p>MAXIMUM INPUT TO ANTENNA CONNECTOR IS -30 dBm FOR PROPER SPECTRUM ANALYZER OPERATION (SIGNALS ABOVE -30 dBm MAY CAUSE SPURIOUS SIGNALS TO BE GENERATED AND DISPLAYED BY AN/GRM-114A).</p> <p>IF A SIGNAL IS TO BE MONITORED THROUGH THE UUT THROUGH A DIRECT CABLE CONNECTION TO TRANS/RCVR CONNECTOR, DO NOT APPLY MORE THAN 100 WATTS OF CONTINUOUS INPUT TO TRANS/RCVR CONNECTOR. MAXIMUM OPERATING "ON" TIME FOR MEASUREMENT OF A TRANSMITTER OUTPUT USING TRANS/RCVR CONNECTOR IS:</p> <ul style="list-style-type: none"> ● 635 WPEP; 1 Minute ON, 5 Minutes OFF, ● 100 W; 15 Minutes ON, 10 Minutes OFF, ● 65 W; Continuous. 	 <p>The illustration shows a handheld spectrum analyzer. A label 'ANTENNA CONNECTOR' points to a connector on the top left of the device. Another label 'TRANS/RCVR CONNECTOR' points to a connector on the bottom right. The device features a large circular dial in the center, a display screen at the top, and various control buttons and switches.</p>
<p>1</p>	<p>Connect external antenna to ANTENNA Connector for "off-the-air" monitoring.</p>	

STEP	PROCEDURE	ILLUSTRATION
2	<p>Apply power to UUT (if applicable).</p> <div style="border: 1px solid black; padding: 5px; margin: 10px 0;"> <p style="text-align: center;">CAUTION</p> <p>WHEN APPLYING POWER TO SPECTRUM ANALYZER OR OSCILLOSCOPE FROM PWR/OFF/BATT SWITCH OR AC/DC/OFF SWITCH, MAKE SURE INTENSITY CONTROL IS IN MODERATE (LEFT) POSITION.</p> </div>	
3	<p>Adjust INTENSITY Control cw and FOCUS Control appropriately for a sharp visible trace on CRT.</p> <div style="border: 1px solid black; padding: 5px; margin: 10px 0;"> <p style="text-align: center;">NOTE</p> <p>Warm-up time of CRT is approximately 30 seconds from a "cold" startup.</p> </div>	
4	<p>Set RF FREQUENCY MHz Thumbwheels to desired center frequency.</p>	
5	<p>Momentarily remove and reapply power to UUT (or in case of a transmitter spectral purity check, key transmitter on and off), while carefully observing carrier signal and surrounding span for any spurious signals.</p> <div style="border: 1px solid black; padding: 5px; margin: 10px 0;"> <p style="text-align: center;">NOTE</p> <p>When interrupting power to UUT (or keying transmitter on and off), certain momentary spikes which protrude above the noise level may appear. Disregard these momentary spikes; look for signals which remain constant in amplitude during this time.</p> </div>	

STEP	PROCEDURE	ILLUSTRATION
6	<p>To determine origin of spurious signal, increase or decrease setting of 1 MHz and 100 kHz segments of RF FREQUENCY MHz Thumbwheels several times above or below center frequency.</p> <p>a. If the spurious signal moves closer to or further away from carrier signal, the spurious signal is being produced by the AN/GRM-114A and thus can be disregarded.</p> <p>b. If the spurious signal moves in same direction and same distance as carrier signal, the spurious signal is being produced by UUT.</p>	 <p>CRT DISPLAY</p> <p>RF FREQUENCY MHz THUMBWHEELS</p>
7	<p>To determine frequency of spurious signal, increase or decrease the setting of the RF FREQUENCY MHz Thumbwheels while rotating ANALY DISPR/OFF Control ccw until the spurious signal is aligned with vertical axis. The setting of RF FREQUENCY MHz Thumbwheels represents frequency of spurious signal.</p> <p>NOTE</p> <p>ANALY DISPR/OFF Control should be fully ccw, short of detent when final frequency reading is taken.</p> <p>To verify actual center of AN/GRM-114A spectrum analyzer, set GEN/RCVR Switch to "GEN" position and observe generated signal:</p>	 <p>CARRIER SIGNAL</p> <p>SPURIOUS SIGNAL</p> <p>ANALY DISPR CONTROL</p> <p>GEN/RCVR SWITCH</p>

STEP	PROCEDURE	ILLUSTRATION
7	<p>(Continued)</p> <p>a. If generated signal is aligned with vertical axis, frequency of detected spurious signal is equal to setting of RF FREQUENCY MHz Thumbwheels.</p> <p>b. If generated signal is not centered over vertical axis, note position of generated signal on CRT graticule; set GEN/RCVR Switch to "RCVR" and increase and decrease setting of RF FREQUENCY MHz Thumbwheels to align spurious signal to same position to which the generated signal was previously aligned. The setting of RF FREQUENCY MHz Thumbwheels represents frequency of detected spurious signal.</p>	
8	<p>Emergency operating procedures: Refer to the Table 2-7 and Step 9 of Table 2-7.</p>	
9	<p>Stopping procedures: Refer to Table 2-2.</p>	

AN/GRM-114A Audio Generator Operating Instructions

- The following note applies to both tables 2-10 and 2-11.

NOTE

When the AN/GRM-114A is used as an audio generator, the operation can be accomplished by either the use of the MM-100E to measure the audio signal level and match the impedance of the UUT or through the use of the oscilloscope as the audio signal level monitor. Therefore, two procedures are presented. Table 2-10 lists the operating instructions using the MM-100E and Table 2-11 lists the operating instructions using the oscilloscope.

Table 2-10 Audio Generation with MM-100E Operating Instructions

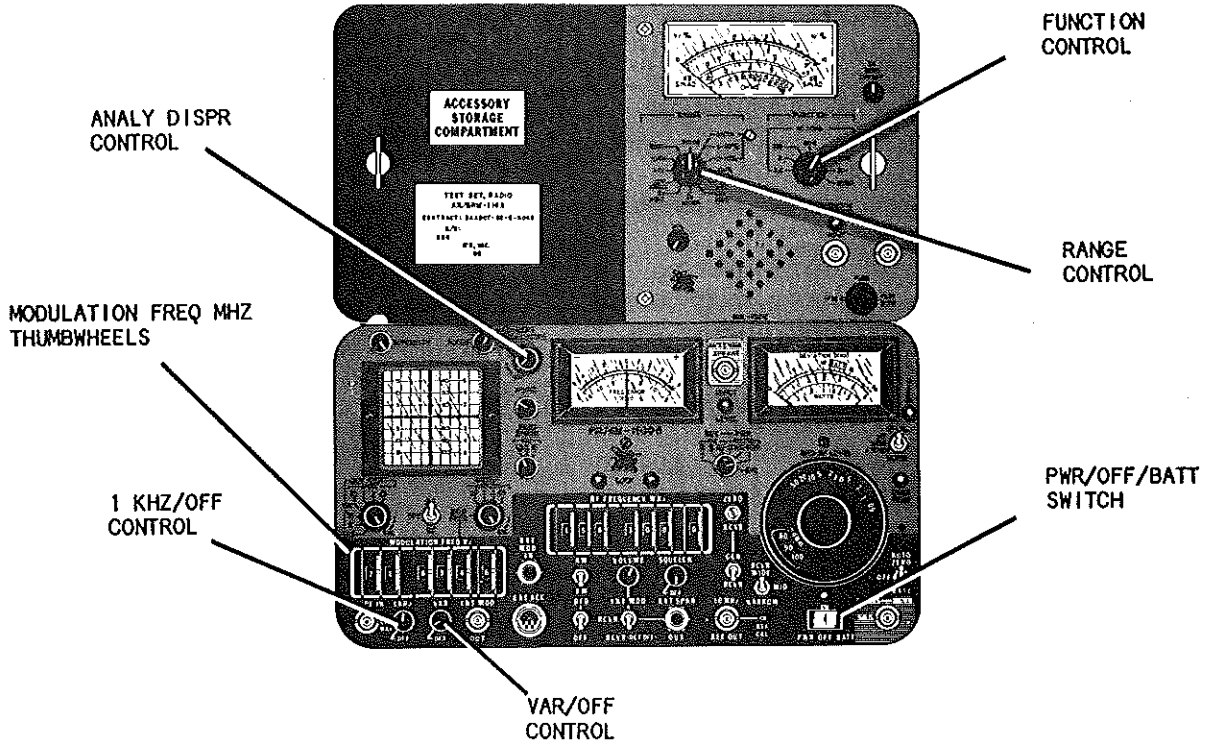


Figure 2-14 FM/AM-1100S and MM-100E Initial Adjustments and Control Settings for Generating Audio Signals

CONTROL	INITIAL SETTING
VAR/OFF Control	Fully ccw, detent "OFF"
1 kHz/OFF Control	Fully ccw, detent "OFF"
MODULATION FREQ Hz Thumbwheels	"0000.0 Hz"
ANALY DISPR Control	Fully ccw, detent "OFF"
FUNCTION Control	"HI-Z"
RANGE Control	"300"
PWR/OFF/BATT Switch	"PWR" or "BATT"

STEP	PROCEDURE	ILLUSTRATION
1	Connect INTERCONNECT POWER Cable to EXT ACC Connector and connect one end of coaxial cable to INT MOD OUT Connector and opposite end of cable to the INPUT Connector of MM-100E.	<p>The illustration shows three connector locations on the MM-100E: INT MOD OUT CONNECTOR (bottom left), EXT ACC CONNECTOR (bottom center), and INPUT CONNECTOR (top right).</p>

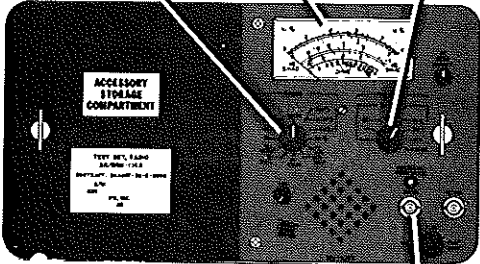
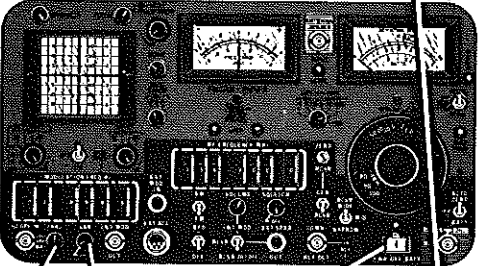

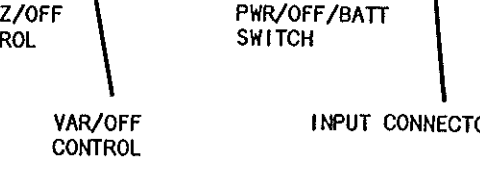
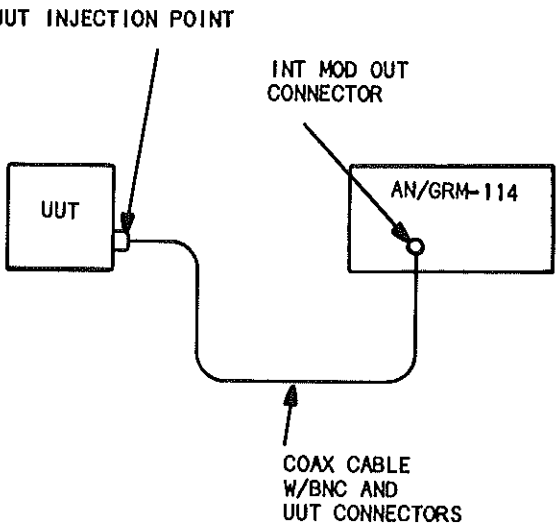
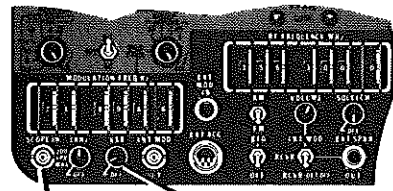
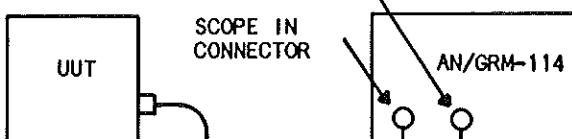
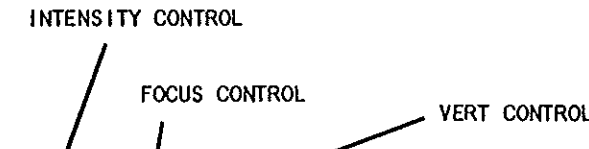
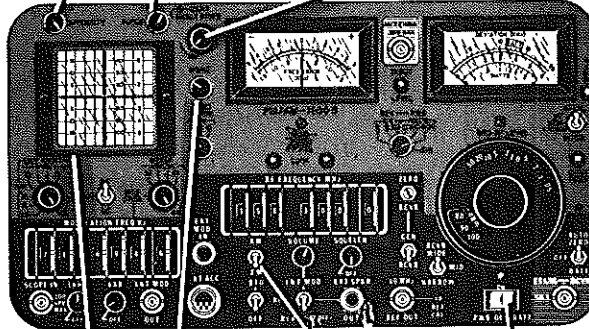
STEP	PROCEDURE	ILLUSTRATION
2	Determine the input impedance of the unit to be tested and determine the level of the audio signal to be inserted into the UUT.	
3	Set the FUNCTION Control to the setting which corresponds with the impedance of the UUT.	
4	Set the RANGE Control to audio signal level to be injected into the UUT.	
5	Set MODULATION FREQ Hz Thumb-wheels to the desired audio frequency.	
6	Apply power to AN/GRM-114A as instructed in Table 2-2 and also apply power to UUT. While observing the MM-100E METER Display, adjust VAR/OFF Control to the desired level (AC volts RMS).	
7	Disconnect one end of the coax cable from the MM-100E INPUT Connector and connect it to the UUT input.	

Table 2-11 Audio Generation with Oscilloscope Operating Instructions

STEP	PROCEDURE	ILLUSTRATION
1	<p style="text-align: center;">CAUTION</p> <p>DO NOT EXCEED 200 V (PEAK-TO-PEAK) TO SCOPE-IN CONNECTOR.</p> <p>Connect BNC tee connector to SCOPE-IN Connector.</p>	 <p>SCOPE IN CONNECTOR</p> <p>VAR/OFF CONTROL</p>
2	<p>Connect one end of short coax cable to INT MOD OUT Connector and opposite end to BNC tee connector attached to SCOPE-IN Connector. Using another coax cable, connect UUT to opposite end of BNC tee connector.</p>	 <p>UUT</p> <p>SCOPE IN CONNECTOR</p> <p>INT MOD OUT CONNECTOR</p> <p>AN/GRM-114</p> <p>COAX CABLE W/BNC AND UUT CONNECTORS</p> <p>BNC "TEE" CONNECTOR</p> <p>SHORT COAX CABLE</p>
3	<p>Apply power to AN/GRM-114A as instructed in Table 2-2, and also apply power to UUT.</p> <p style="text-align: center;">CAUTION</p> <p>WHEN APPLYING POWER TO OSCILLOSCOPE OR SPECTRUM ANALYZER FROM PWR/OFF/BATT SWITCH OR AC/DC/OFF SWITCH, MAKE SURE INTENSITY CONTROL IS IN MODERATE (LEFT) POSITION.</p>	 <p>INTENSITY CONTROL</p> <p>FOCUS CONTROL</p> <p>VERT CONTROL</p>
4	<p>Adjust INTENSITY Control cw and FOCUS Control appropriately for a sharp visible trace on CRT Display.</p> <p style="text-align: center;">NOTE</p> <p>Warm-up time of CRT is approximately 30 seconds from a "cold" startup; trace display will not become visible until CRT achieves warm-up.</p>	 <p>CRT DISPLAY</p> <p>HORIZ CONTROL</p> <p>AC/OFF/DC SWITCH</p> <p>PWR/OFF/BATT SWITCH</p>

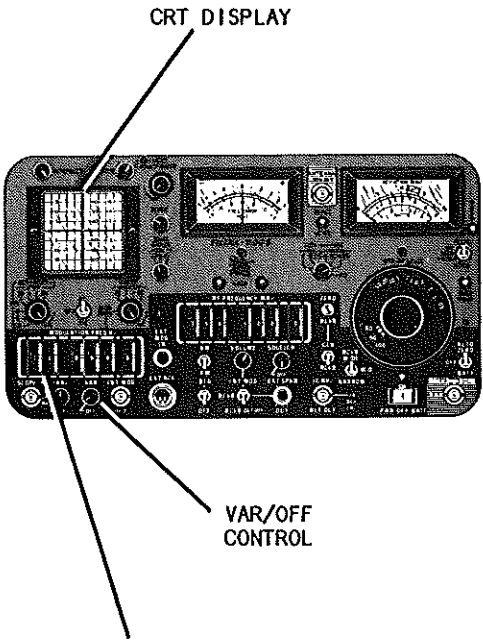
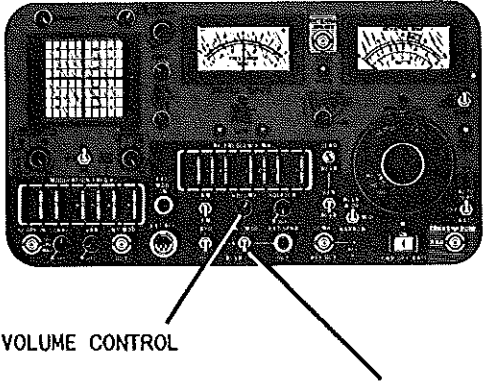
STEP	PROCEDURE	ILLUSTRATION
5	Adjust VERT and HORIZ Controls so that the trace is centered and aligned along the horizontal axis.	
6	Set MODULATION FREQ Hz Thumbwheels to desired audio frequency.	
7	<p>For calibration, the level of the injected audio tone must be expressed in volts peak-to-peak. Volts RMS or volts peak must be converted to volts peak-to-peak, using following formulas:</p> <p>volts peak-to-peak = 2.828 x volts rms</p> <p>volts peak-to-peak = 2 x volts peak</p>	 <p>CRT DISPLAY</p> <p>VAR/OFF CONTROL</p> <p>MODULATION FREQ HZ THUMBWHEELS</p>
8	<p>Rotate VAR/OFF Control to adjust waveform to desired amplitude in volts peak as displayed on CRT Display.</p> <p style="text-align: center;">NOTE</p> <p>Desired audio tone is now being injected into the UUT.</p>	
9	<p style="text-align: center;">CAUTION</p> <p>DO NOT EXCEED 200 V (PEAK-TO-PEAK) TO SCOPE-IN CONNECTOR.</p> <p>To monitor the injected tones, set INT MOD/RCVR/RCVR (DET OFF) Switch to "INT MOD" position and VOLUME Control for a comfortable listening level.</p>	 <p>VOLUME CONTROL</p> <p>INT/MOD/RCVR SWITCH</p>
10	Emergency operating procedures: Refer to Table 2-2.	
11	Stopping procedures: Refer to Table 2-2.	

Table 2-12 Power Monitor Operating Instructions for Measuring Transmitter Carrier Power

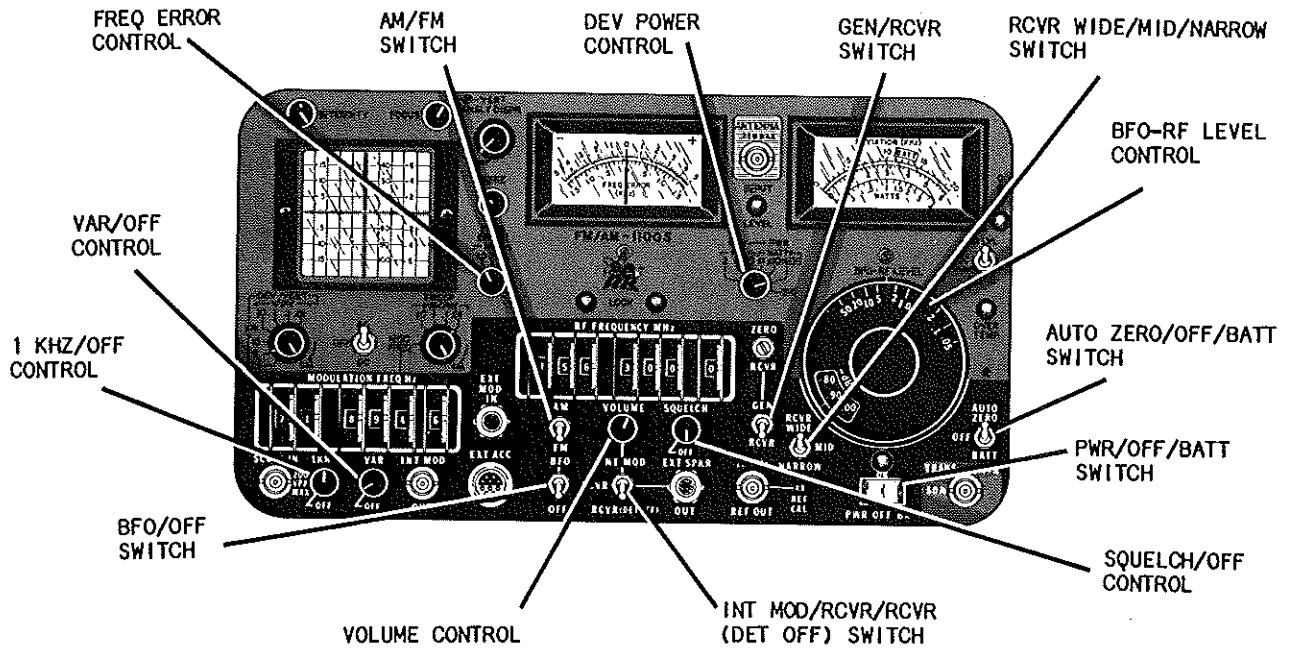
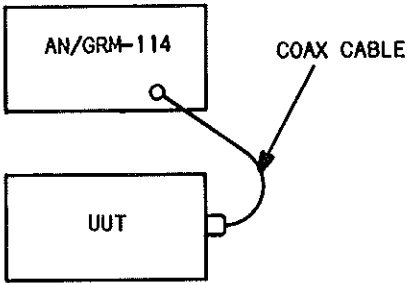
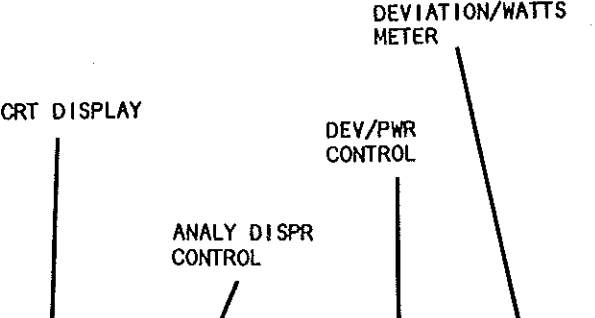
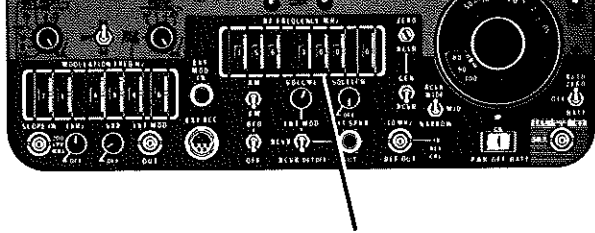


Figure 2-15 FM/AM-1100S Initial Adjustments and Control Settings for Measuring Transmitter Carrier Power

CONTROL	INITIAL SETTING
DEV/PWR Control	"SIG"
GEN/RCVR Switch	"RCVR"
RCVR WIDE/MID/NARROW Switch	"WIDE"
BFO-RF LEVEL Control	Fully ccw
AUTO ZERO/OFF/BATT Switch	"AUTO ZERO"
SQUELCH/OFF Control	Fully ccw, short of detent
INT MOD/RCVR/RCVR (DET OFF) Switch	"RCVR"
VOLUME Control	Fully ccw
BFO/OFF Switch	"OFF"
AM/FM Switch	"AM" or "FM" (depending on mode of signal to be received)
1 kHz/OFF Control	Fully ccw, detent "OFF"
VAR/OFF Control	Fully ccw, detent "OFF"
FREQ ERROR Control	"15 kHz"
PWR/OFF/BATT Switch	"PWR" or "BATT"

STEP	PROCEDURE	ILLUSTRATION
1	Apply power to AN/GRM-114A as instructed in Table 2-2.	

STEP	PROCEDURE	ILLUSTRATION
2	Apply power to UUT.	
3	Connect a coax cable between the UUT RF output and AN/GRM-114 TRANS/RCVR Connector. <div style="text-align: center;">NOTE</div> Due to various construction of buildings, a national standard (e.g. WWV) signal may not be obtained without a rooftop antenna or relocation of AN/GRM-114A to an outdoor location.	
4	Rotate DEV/PWR Control to "WATTS X 10".	
5	Key UUT. Read UUT power output on red scale of DEVIATION (kHz)/WATTS Meter. <div style="text-align: center;">NOTE</div> If DEVIATION (kHz)/WATTS Meter needle deflection is less than 10 watts when UUT is keyed, rotate DEV/PWR Control to "WATTS X 1".	
6	Set RF FREQUENCY MHz Thumbwheels to frequency on transmitter.	
7	Place ANALY DISPR Control ccw just short of detent. <div style="text-align: center;">NOTE</div> UUT power output can also be viewed on CRT Display spectrum analyzer dB scale, using following approximate equivalencies: -30 dB marking on spectrum analyzer = 100 watts,	

STEP	PROCEDURE	ILLUSTRATION
7	(Continued) -40 dB marking on spectrum analyzer = 10 watts, -50 dB marking on spectrum analyzer = 1 watt, and -60 dBm marking on spectrum analyzer = 0.1 watt.	
8	Emergency operating procedures: Refer to Table 2-2.	
9	Stopping procedures: Refer to Table 2-2.	

Table 2-13 Master Oscillator Calibration Using Received Time Standard Signal (WWV)

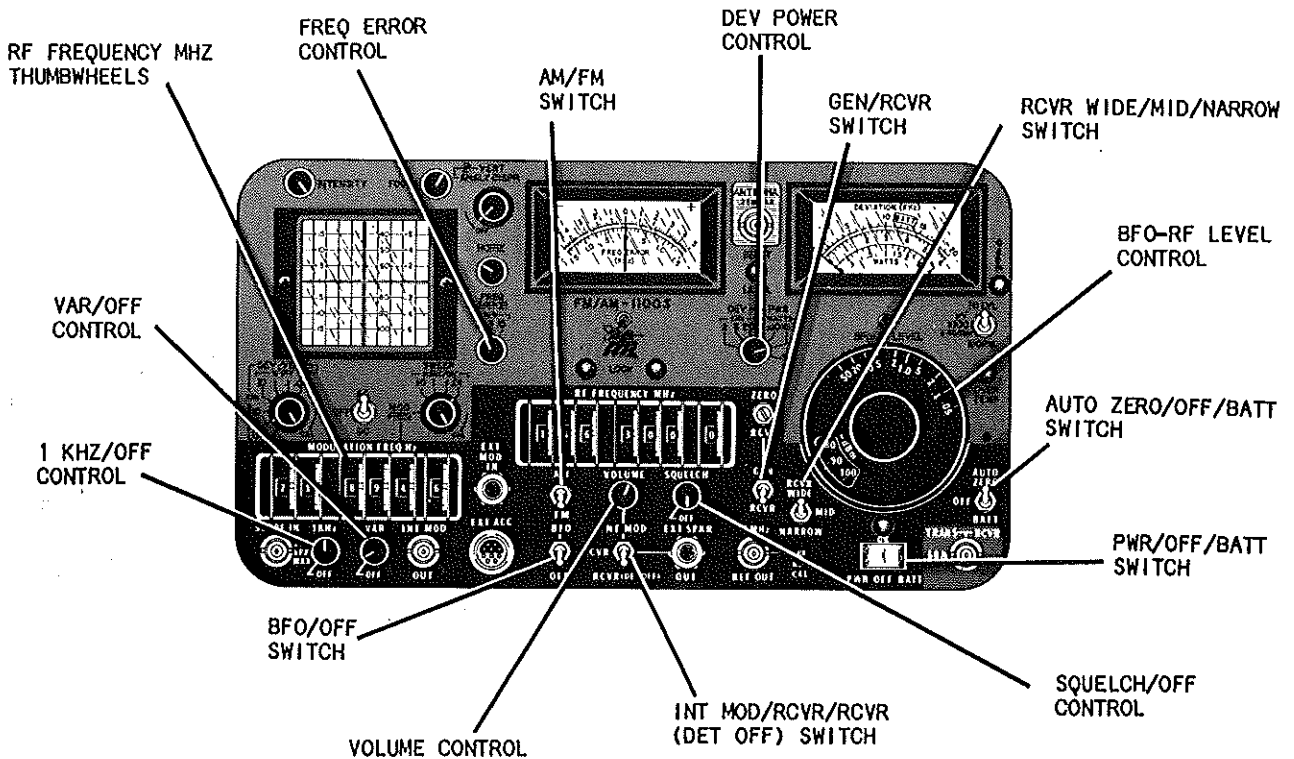


Figure 2-16 FM/AM-1100S Initial Adjustments and Control Settings for Master Oscillator Calibration Using Received Time Standard Signal (WWV)

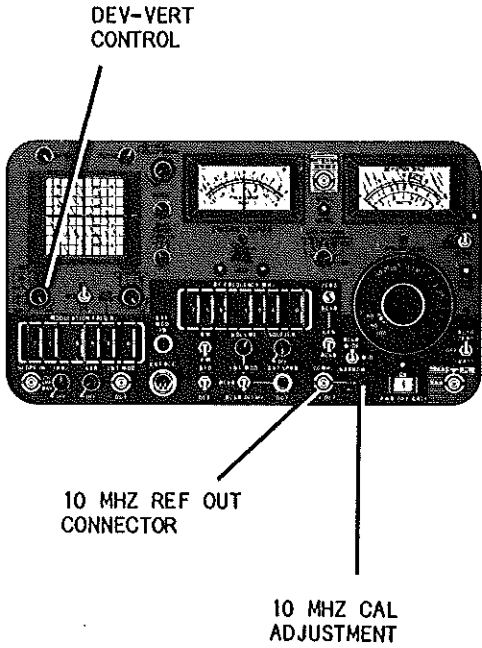
CONTROL

INITIAL SETTING

DEV/PWR Control
 GEN/RCVR Switch
 RCVR WIDE/MID/NARROW Switch
 BFO-RF LEVEL Control
 AUTO ZERO/OFF/BATT Switch
 SQUELCH/OFF Control
 INT MOD/RCVR/RCVR (DET OFF)
 Switch
 VOLUME Control
 BFO/OFF Switch
 AM/FM Switch
 1 kHz/OFF Control
 VAR/OFF Control
 FREQ ERROR Control
 RF FREQUENCY MHz Thumbwheels
 PWR/OFF/BATT Switch

"SIG"
 "RCVR"
 "WIDE"
 Fully ccw
 "AUTO ZERO"
 Fully ccw, short of detent

 "RCVR"
 Fully ccw
 "OFF"
 "AM"
 Fully ccw, detent "OFF"
 Fully ccw, detent "OFF"
 "15 kHz"
 "10.0000 MHz"
 "PWR" or "BATT"

STEP	PROCEDURE	ILLUSTRATION
1	Perform the steps necessary to receive AM signals as listed in Table 2-7.	
2	Set AN/GRM-114A controls for oscilloscope operation as shown in Figure 2-10.	
3	Place DEV-VERT Control to "15 kHz" position.	
4	Insert a short length of wire into center conductor of 10 MHz REF OUT Connector.	
5	Adjust position of wire to obtain a suitable beat note from AN/GRM-114A speaker.	
6	<p>Using small screwdriver, adjust the 10 MHz CAL Adjustment until the beat note achieves as low a frequency as possible:</p> <p>a. Initially, it is helpful to observe oscillation of the waveform on the oscilloscope while rotating 10 MHz CAL Adjustment; adjust screw until oscillation diminishes to a point of being as close as possible to stationary.</p>	

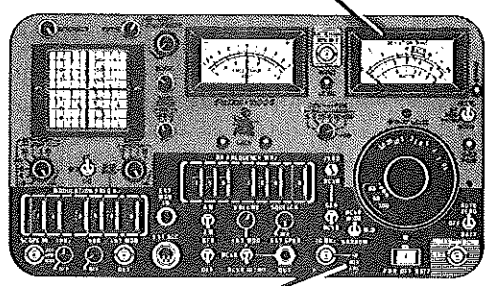
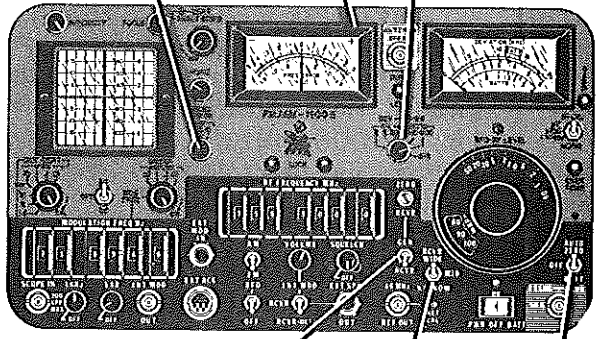
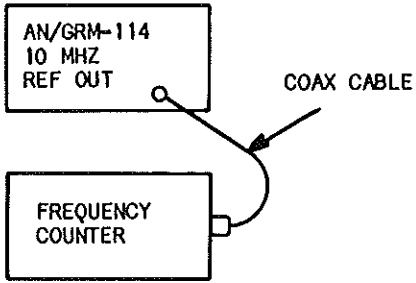
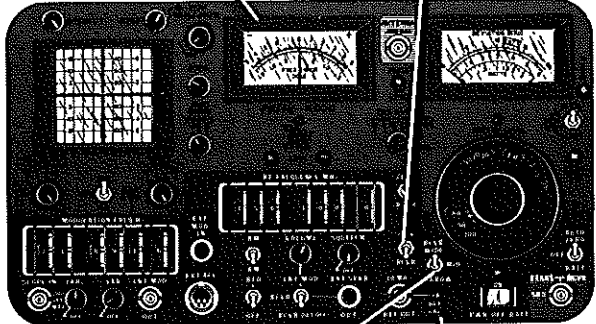
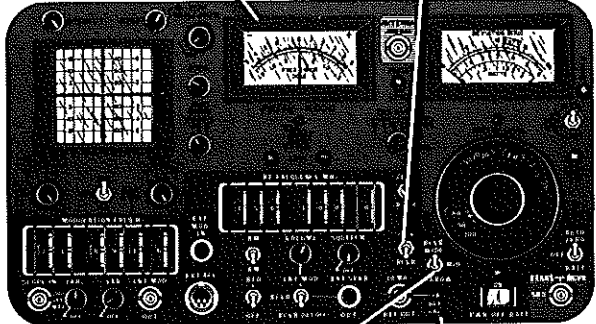
STEP	PROCEDURE	ILLUSTRATION
6	<p>(Continued)</p> <p>(b) While observing DEVIATION/WATTS Meter, continue to adjust the 10 MHz CAL Adjustment until meter needle oscillation is as slow as possible. During this step, recheck oscilloscope to be sure the waveform is stable. Master oscillator is now calibrated in accordance with the time standard signal.</p> <p style="text-align: center;">NOTE</p> <p>Careful calibration can result in a beat frequency less than 0.1 Hz.</p>	 <p>DEVIATION WATTS METER</p> <p>10 MHz CAL ADJUSTMENT</p>
7	<p>When calibrating the master oscillator for accurate frequency reference/measurement, the FREQ ERROR Meter should also be zeroed for reliable frequency measurements. Procedure is as follows:</p> <p>a. Set GEN/RCVR Switch to "GEN".</p> <p style="text-align: center;">NOTE</p> <p>RCVR WIDE/MID/NARROW Switch must be in "NARROW".</p> <p>b. Make sure AUTO ZERO/OFF/BATT Switch is in "AUTO".</p> <p>c. Rotate FREQ ERROR Control to "1.5 kHz".</p> <p>d. Adjust ZERO RCVR Adjustment cw or ccw to center FREQ ERROR Meter needle at zero.</p>	 <p>FREQ ERROR METER</p> <p>FREQ ERROR CONTROL</p> <p>ZERO RCVR ADJUSTMENT</p> <p>GEN/RCVR SWITCH</p> <p>RCVR WIDE/MID/NARROW SWITCH</p>
8	<p>Emergency operating procedures: Refer to Table 2-2.</p>	<p>AUTO ZERO/OFF/BATT SWITCH</p>
9	<p>Stopping procedures: Refer to Table 2-2.</p>	

Table 2-14 Master Oscillator Calibration Using an External Frequency Standard

NOTE

The procedures in Table 2-14 are for calibrating the master oscillator through an external source when a 10 MHz "off-the-air" reference is not available.

STEP	PROCEDURE	ILLUSTRATION
1	<p>Connect one end of coax cable to the 10 MHz REF OUT Connector.</p> <p>Connect opposite end of coax cable to input of frequency counter.</p>	
2	<p>Apply power to frequency counter.</p>	
3	<p>Apply power to AN/GRM-114A as instructed in Table 2-2.</p> <p style="text-align: center;">NOTE</p> <p>For most precise adjustment, wait approximately 5 minutes before proceeding with Step 5.</p>	
4	<p>Adjust 10 MHz CAL Adjustment until frequency counter reads 10.000000 MHz. Master oscillator is now calibrated to frequency counter.</p>	
5	<p>When calibrating the master oscillator for accurate frequency reference/measurement, the FREQ ERROR Meter must be zeroed for reliable frequency measurements. Procedure is as follows:</p> <p>a. Set GEN/RCVR Switch to "GEN".</p> <p style="text-align: center;">NOTE</p> <p>RCVR WIDE/MID/NARROW Switch must be in "NARROW".</p>	

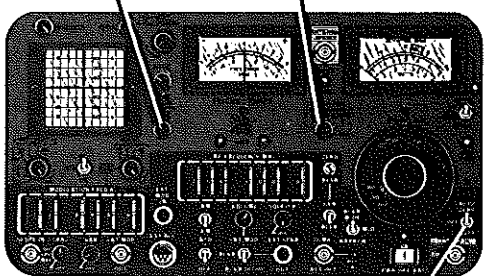
STEP	PROCEDURE	ILLUSTRATION
5	<p>(Continued)</p> <p>b. Make sure AUTO ZERO/OFF/BATT Switch is in "AUTO ZERO" position.</p> <p>c. Rotate FREQ ERROR Control to "1.5 kHz".</p> <p>d. Adjust ZERO RCVR Adjustment cw or ccw to center FREQ ERROR Meter needle at zero.</p>	
6	<p>Emergency operating procedures: Refer to Table 2-2.</p>	
7	<p>Stopping procedures. Disconnect power from AN/GRM-114A as instructed in Table 2-2 before disconnecting power from frequency counter.</p>	

Table 2-15 Frequency Error Measurement Operating Instructions

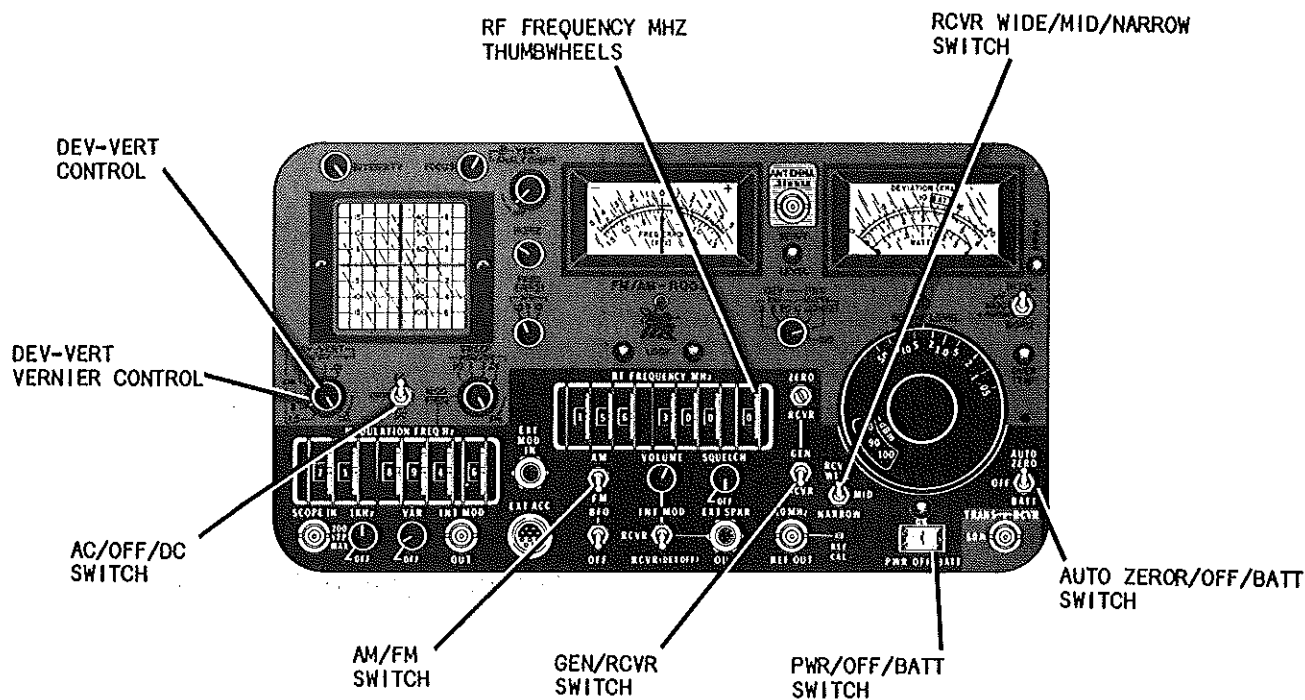


Figure 2-17 FM/AM-1100S Initial Adjustments and Control Settings for Frequency Error Measurement

CONTROL

INITIAL SETTING

AUTO ZERO/OFF/BATT Switch
 RCVR WIDE/MID/NARROW Switch
 GEN/RCVR Switch
 RF FREQUENCY MHz Thumbwheels
 AC/OFF/DC Switch
 DEV-VERT Control
 DEV-VERT VERNIER Control
 AM/FM Switch
 PWR/OFF/BATT Switch

"AUTO ZERO"
 "NARROW"
 "RCVR"
 "0000000 MHz"
 "DC"
 "15 kHz"
 "CAL"
 "FM"
 "PWR" or "BATT"

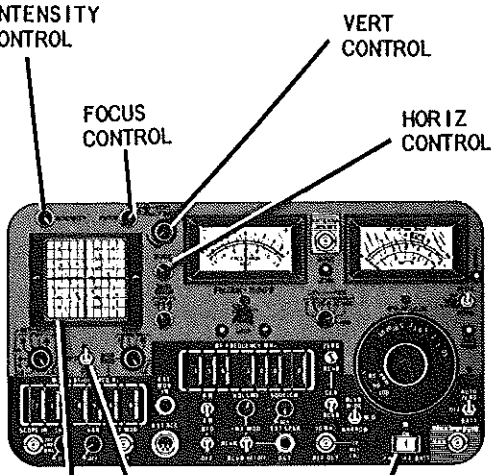
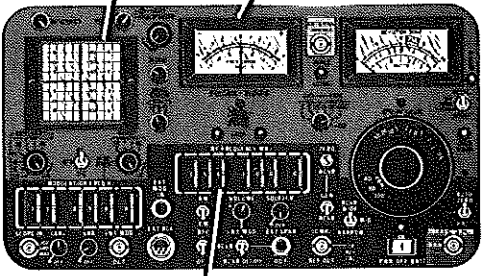

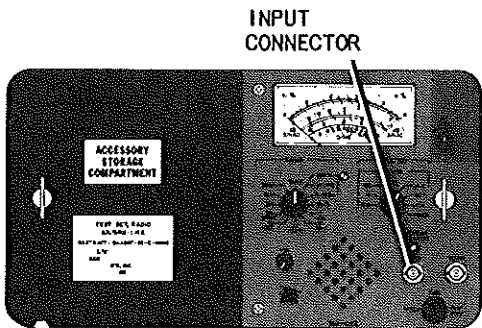
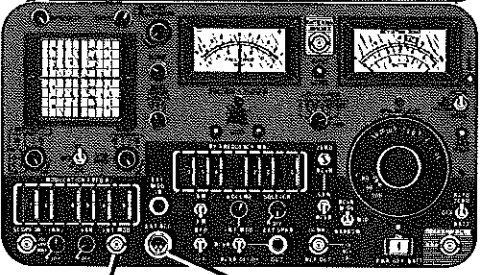
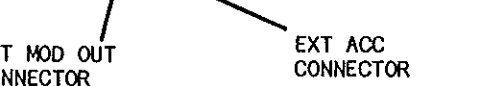
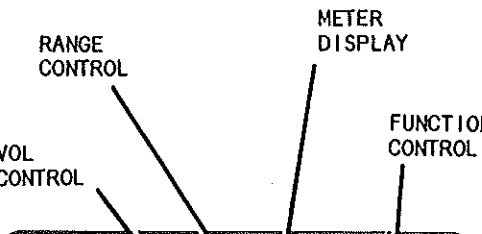
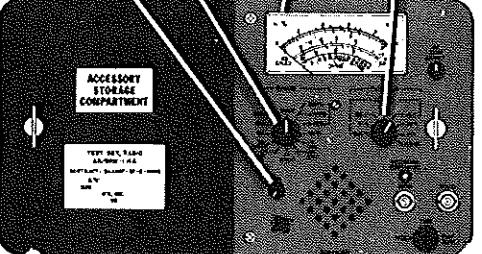
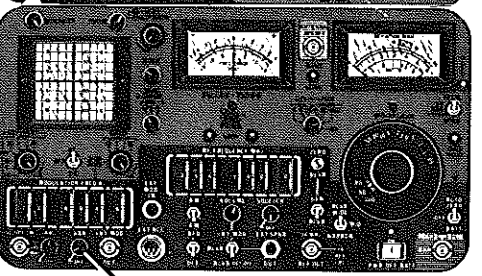

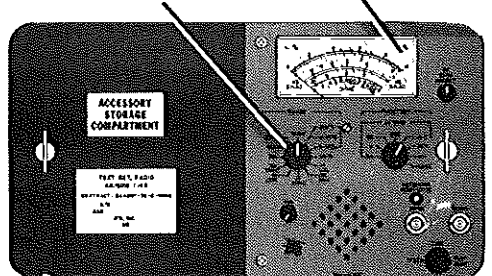
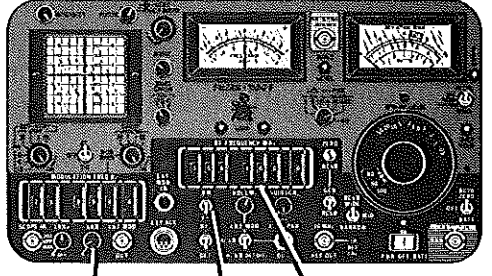
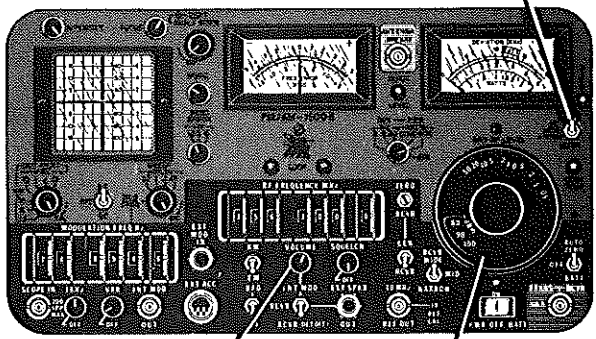
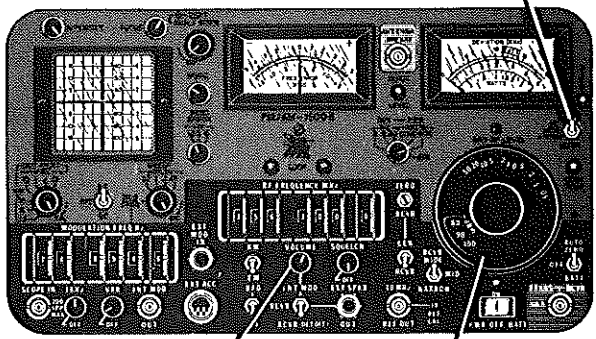
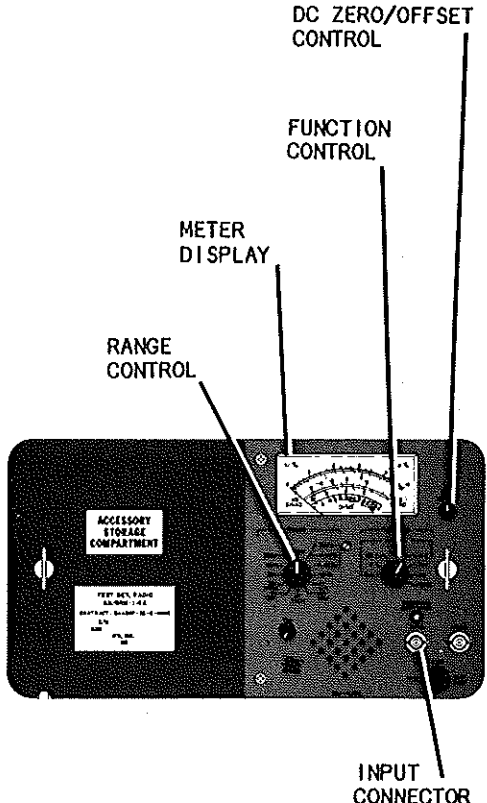
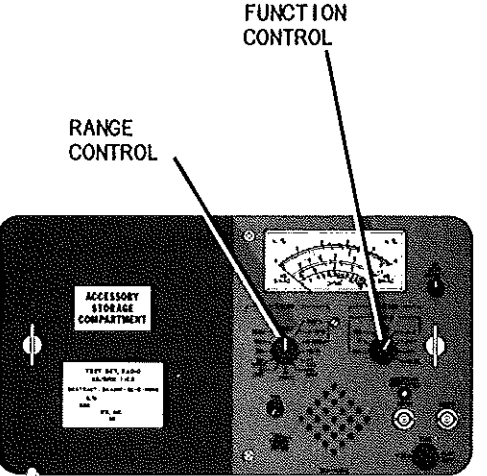
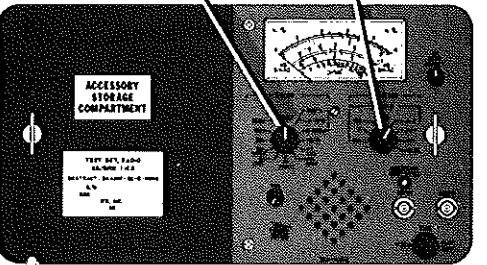
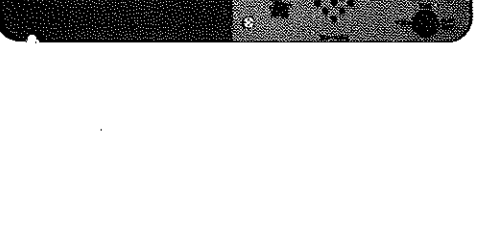
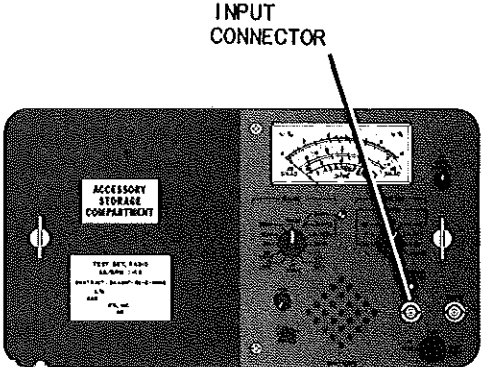
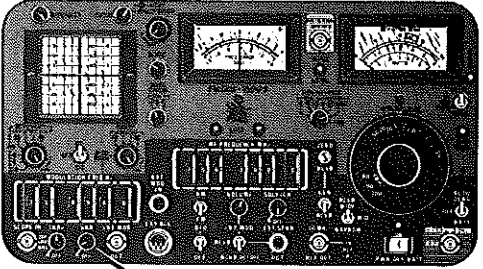
STEP	PROCEDURE	ILLUSTRATION
1	<p style="text-align: center;">CAUTION</p> <p>WHEN APPLYING POWER TO THE OSCILLOSCOPE OR SPECTRUM ANALYZER FROM THE PWR/OFF/BATT SWITCH OR FROM THE AC/DC/OFF SWITCH, MAKE SURE INTENSITY CONTROL IS IN MODERATE (LEFT) POSITION.</p> <p>Center the oscilloscope trace using the HORIZ and VERT Controls.</p>	
2	Place the FREQ ERROR Control to "15 kHz".	
3	Set RF FREQUENCY MHz Thumbwheels to "0000100".	
4	Verify both the oscilloscope and the FREQ ERROR Meter read "10 kHz".	
5	Other oscilloscope and FREQ ERROR Meter ranges may be checked in the same manner.	
6	Emergency operating procedures: Refer to Table 2-2.	
7	Stopping procedures. Refer to Table 2-2.	

Table 2-16 Multimeter Operating Instructions

STEP	PROCEDURE	ILLUSTRATION
1	<p style="text-align: center;">CAUTION</p> <p>DO NOT EXCEED 300 V INTO THE MULTIMETER INPUT CONNECTOR AND 600 VRMS OR 800 VDC INTO PROBE.</p> <p>Connect the INTERCONNECT POWER Connector to the EXT ACC connector.</p>	 <p style="text-align: center;">INPUT CONNECTOR</p>
2	<p>Connect probe between the AC voltage or signal under test and MM-100E INPUT Connector.</p>	
3	<p>Apply power to AN/GRM-114A as instructed in Table 2-2.</p>	 <p style="text-align: center;">INT MOD OUT CONNECTOR EXT ACC CONNECTOR</p>
4	<p>When generating a signal by the AN/GRM-114A is necessary, refer to procedures in Tables 2-2 and 2-3 or 2-4.</p>	 <p style="text-align: center;">RANGE CONTROL METER DISPLAY</p> <p style="text-align: center;">VOL CONTROL FUNCTION CONTROL</p>
5	<p>To measure an AC voltage of the generated signal, set FUNCTION Control to "HI-Z" (for amplifiers with low impedance outputs, set function switch to match amplifier output (i.e. 600Ω, 150Ω, 8Ω or 3.2Ω)) and RANGE Control to the VOLTS position which gives best meter reading (top or second scale, depending on VOLTS position). Place probe switch to either X1 or X10 position.</p>	 <p style="text-align: center;">RANGE CONTROL METER DISPLAY</p> <p style="text-align: center;">VOL CONTROL FUNCTION CONTROL</p>
6	<p>Adjust VOL Control for a comfortable listening level.</p>	
7	<p style="text-align: center;">NOTE</p> <p>The multimeter measures distortion of 300 Hz to 20 kHz signals. AN/GRM-114A variable tone generator</p>	 <p style="text-align: center;">VAR/OFF CONTROL</p>

STEP	PROCEDURE	ILLUSTRATION
7	<p>(Continued)</p> <p>NOTE</p> <p>must be used as the audio or modulation source to the UUT.</p> <p>To measure distortion of the UUT, connect probe to UUT audio output. Set RANGE Control to the DISTN position which gives best meter reading (top or second scale, depending on the DISTN position).</p>	 <p>METER DISPLAY</p> <p>RANGE CONTROL</p>
8	<p>To measure SINAD value or 0 to 100% distortion of applied signal, set RANGE Control to "SINAD". Read value on SINAD scale or top scale of meter.</p>	 <p>AM/FM SWITCH</p> <p>RF FREQUENCY MHZ THUMBWHEELS</p>
9	<p>NOTE</p> <p>For the following step, the AM/FM Switch of the AN/GRM-114A must be in AM position. (Ref Table 2-4 or 2-7 for generating and receiving RF signals.)</p> <p>To read the AM% modulation of the applied signal, set RANGE Control of multimeter to "AM%" position, read meter indication on top scale.</p>	 <p>VAR/OFF CONTROL</p> <p>HI LVL/AV X 100/ NORM SWITCH</p>
10	<p>When generating RF signals, adjust VAR/OFF Control for desired AM% modulation. Accuracy will be best with a 1 kHz signal.</p> <p>NOTE</p> <p>To measure DC voltage, a DC source external to the AN/GRM-114A, or a battery external to the AN/GRM-114A is required.</p>	 <p>VOLUME CONTROL</p> <p>BFO-RF LEVEL CONTROL</p>

STEP	PROCEDURE	ILLUSTRATION
10	<p>(Continued)</p> <p style="text-align: center;">NOTE</p> <p>If using source external to the AN/GRM-114A, connect probe to INPUT Connector of multimeter and one end to output of external source. Make sure power is applied to AN/GRM-114A and thus to multimeter before applying power to external sources.</p> <div style="border: 1px solid black; padding: 5px; margin: 10px 0;"> <p style="text-align: center;">CAUTION</p> <p>DO NOT EXCEED 600 VRMS OR 800 VDC ON THE MULTIMETER PROBE.</p> </div>	 <p>DC ZERO/OFFSET CONTROL</p> <p>FUNCTION CONTROL</p> <p>METER DISPLAY</p> <p>RANGE CONTROL</p> <p>INPUT CONNECTOR</p>
11	<p>To measure DC voltage, set DC ZERO OFFSET Control fully ccw, detent position and FUNCTION Control to "+" or "-" DC depending on voltage to be measured.</p> <p style="text-align: center;">NOTE</p> <p>Remove probe from any voltage source prior to placing FUNCTION Control to "OHMS" position.</p>	 <p>RANGE CONTROL</p> <p>FUNCTION CONTROL</p>
12	<p>Set RANGE Control to the "VOLTS" position and probe switch to "X1" or "X10" position for the best meter reading (on either the top or second scale, depending on VOLTS position).</p>	
13	<p>To measure resistance, set FUNCTION Control to "OHMS" and probe switch to "X1" position.</p>	

STEP	PROCEDURE	ILLUSTRATION
13	<p>(Continued)</p> <div style="border: 1px solid black; padding: 5px; margin: 10px 0;"> <p style="text-align: center;">CAUTION</p> <p>WHEN NO LONGER MEASURING RESISTANCE, REMOVE FUNCTION CONTROL FROM "OHMS" (ONLY) POSITION. PLACING MULTIMETER PROBES ACROSS LARGE VOLTAGES WHEN IN "OHMS" (ONLY) POSITION WILL BLOW MULTIMETER FUSE.</p> </div>	
14	Connect multimeter probe across resistance to be measured.	
15	Set RANGE Control to the OHMS position which gives the best meter reading (on OHMS scale).	
16	Emergency operating procedures: Refer to Table 2-2.	
17	<p>Stopping procedures:</p> <ol style="list-style-type: none"> a. Refer to Table 2-2. b. Disconnect BNC cable from INPUT Connector of multimeter and INT MOD OUT Connector of AN/GRM-114A, or output of external signal source. 	

Section IV, OPERATING UNDER USUAL CONDITIONS

WARNING

WHEN THE AC AND DC POWER CABLES ARE BOTH CONNECTED TO THE AN/GRM-114A AND THE AC CABLE IS PLUGGED INTO AN AC POWER SOURCE, APPROXIMATELY 16 VDC WITH OVER 6 AMPS CAPACITY IS PRESENT AT THE PLUG END OF THE DC POWER CABLE.

2-6. OPERATING WITH THE BATTERY.

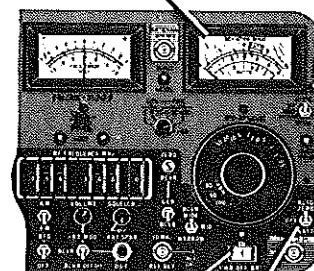
NO POWER CABLES REQUIRED

- Be sure the AN/GRM-114A battery is fully charged prior to placing the test set in operation.

- Use the procedure below to determine the battery status under load:

- Set the POWER/OFF/BATT Switch to "BATT" position. Depress the AUTO ZERO/OFF/BATT Switch to the "BATT" position (switch is spring loaded in "BATT" position) to read the battery voltage on the DEVIATION WATTS Meter.

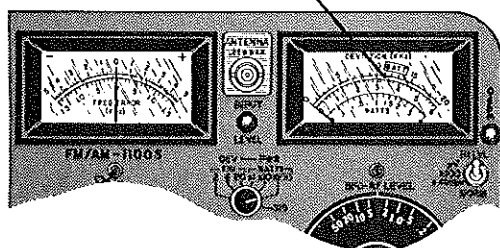
DEVIATION WATTS METER



PWR/OFF/BATT SWITCH

AUTO ZERO/OFF/BATT SWITCH

11 VDC



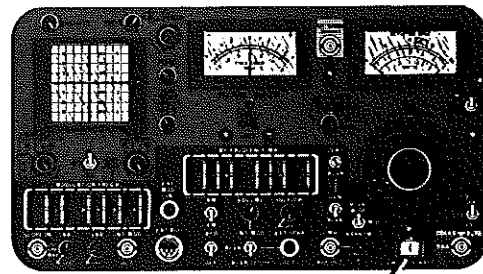
The battery voltage displayed on the DEVIATION WATTS Meter should be 11 to 15 VDC. (Battery is discharged when the voltage displayed on DEVIATION WATTS Meter is less than 11 VDC under load.)

NOTE

The AC or DC line cord must be removed from either the AC or DC power source to obtain an accurate reading of the battery voltage on the DEVIATION WATTS Meter.

- The operating time of your AN/GRM-114A is limited to 10 minute intervals during battery operation to prolong the life of the battery. (You can expect to get approximately 50 minutes (5 ten minute cycles) of operation, from a fully charged battery, between battery charges.)

- When the AN/GRM-114A automatically shuts off after ten minutes of continuous operation, simply depress the PWR/OFF/BATT Switch to the "BATT" position of restore battery power to your Radio Test Set.



PWR/OFF/BATT SWITCH

NOTE

During battery operation, turn off the oscilloscope when not in use, to extend battery operating time between charges.

- The battery should be charged before use if it has been 30 days or longer since it has been used or charged up.
- You should remove the battery from your radio test set after use, if it is to be stored and/or not used for a period of 30 days or more.

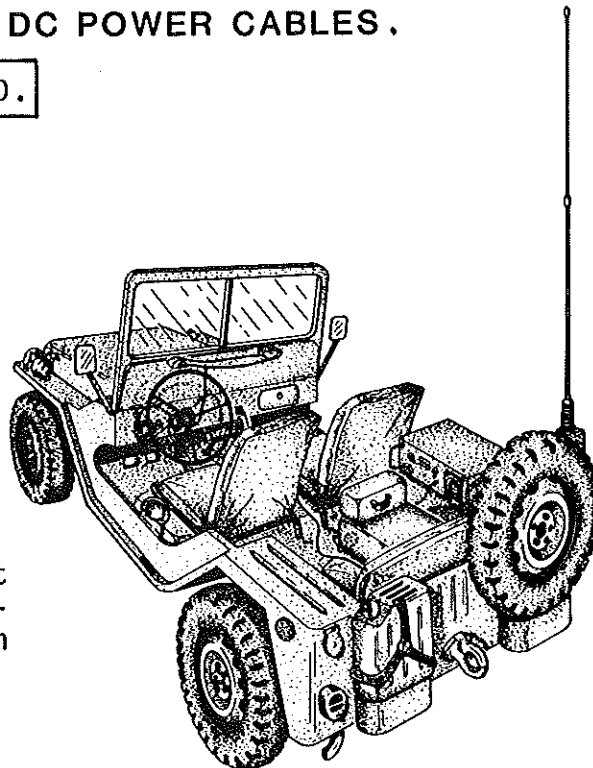
2-7. OPERATION WITH THE AC OR DC POWER CABLES.

AC AND/OR DC POWER CABLES REQUIRED.

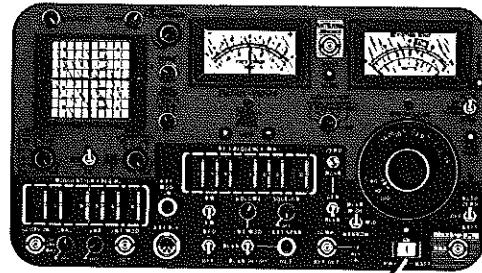
DC OPERATION

NOTE

A DC power cable with a cigarette lighter plug is provided with your AN/GRM-114A, so for remote operation, your vehicle must be equipped to accept this cable. (This manual is not an authority to have a cigarette lighter installed in a vehicle.)



- Be sure the PWR/OFF/BATT Switch is in "OFF" position.



PWR/OFF/BATT SWITCH

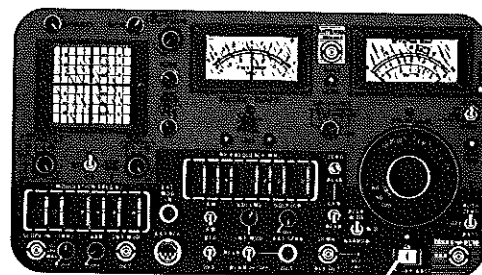
CAUTION

WHENEVER USING AN EXTERNAL DC POWER SOURCE, BE SURE THE AC POWER CABLE IS NOT CONNECTED TO AN EXTERNAL POWER SOURCE.

- Connect the DC power cable to the power source connector.
- Operate your radio test set utilizing the step by step operating procedures in Table 2-2 through Table 2-16.
- Disconnect DC power cable from power source and stow in proper compartment provided. Place AN/GRM-114A in field case.

AC OPERATION

- Be sure the PWR/OFF/BATT Switch is in "OFF" position.



PWR/OFF/BATT SWITCH

WARNING

WHENEVER USING AN AC POWER SOURCE, BE SURE THE DC POWER CABLE IS NOT CONNECTED TO THE RADIO TEST SET AS A SHOCK HAZARD (16 VDC WITH OVER 6 AMP CAPACITY) MAY EXIST AT THE PLUG END OF THE DC POWER CABLE.

- Connect the AC power cable to the power source connector.

NOTE

When the radio test set power cable is connected to a power source, the internal battery is constantly charging whether the test set is turned on or off.

- Operate your radio test set utilizing the step by step operating procedures in Table 2-2 through Table 2-16.
- Disconnect AC power cable from power source and stow in proper compartment provided. Place AN/GRM-114A in field case.

Section V, OPERATING UNDER UNUSUAL CONDITIONS

2-8. OPERATION IN UNUSUAL WEATHER .

The AN/GRM-114A is designed and manufactured to operate in either a fixed (laboratory) or mobile environment, thus subjecting the test set to a wide range of temperatures plus unusual weather conditions during operation. While operating the test set in normal or usual conditions, no protection from the elements is required; however, under extreme conditions, the following precautions are necessary:

COLD CLIMATES: Extreme cold causes cables to become hard, brittle and difficult to handle.

- Be careful when handling the cables and connecting them to the UUT so that kinks and unnecessary loops will not result in permanent damage.
- Make sure connectors, controls and terminals are free of frost, snow and ice. Keep connectors, controls and terminals protected from the elements when not in use.
- Be careful when cables and probes are connected to the test set. Never drag or place the cables or probes in the snow.

HOT CLIMATES: In hot, dry climates, (i.e. desert and dusty areas) connectors, controls and meter displays are subject to damage from dust and dirt.

Never place your test set directly on the ground (sand or dusty area). First lay a protective cover on the ground on which to place the test set.

Protect connectors, controls and terminals from blowing sand and dust.

Keep sand and dust clear of heat sink on rear panel. Periodically check heat sink to be sure it is free of any buildup of sand and/or dust.

Increase cleaning interval, as necessary, to keep connectors, controls and meter movements free of dust and dirt.

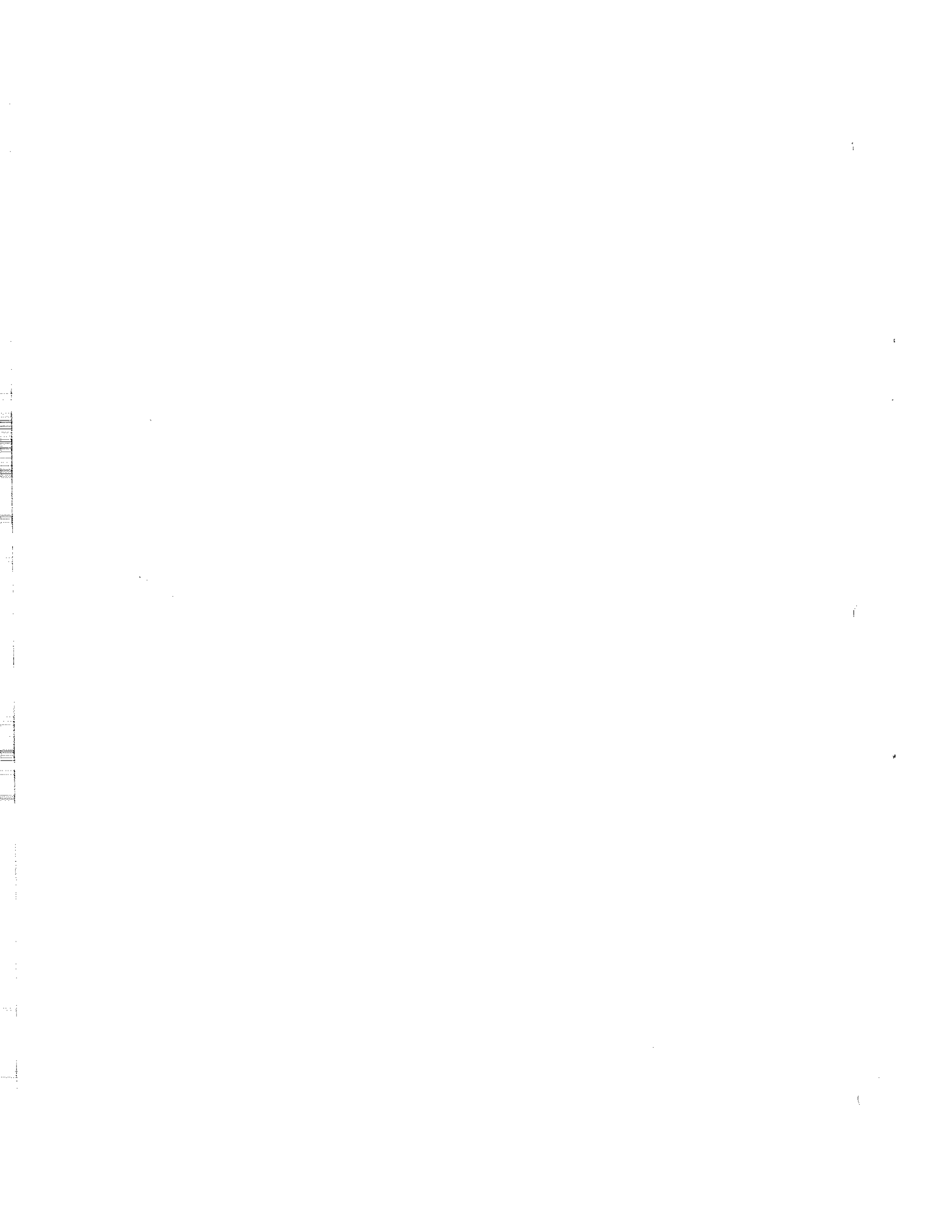
WARM, DAMP CLIMATES: In warm, damp climates, the equipment is subject to damage from moisture and fungi. Wipe all moisture and fungi from equipment with a soft lint-free cloth.

WARNING

DO NOT OPERATE YOUR AN/GRM-114A WHEN MOISTURE IS CONDENSING ON THE TEST SET. KEEP IT SHELTERED FROM THE RAIN.

-9. EMERGENCY STOPPING PROCEDURES.

Perform the emergency stopping procedures as outlined in Table 2-2.



CHAPTER 3
MAINTENANCE INSTRUCTIONS
Section I, LUBRICATING INSTRUCTIONS

There are no lubrication requirements for the AN/GRM-114A.

3-1. EXTERNAL CLEANING.

- Clean front panel and case with a soft lint-free cloth moistened with trichlorotrifluoroethane.
- Remove tar or oil from outside case.

WARNING

ADEQUATE VENTILATION SHOULD BE PROVIDED WHILE USING TRICHLOROTRIFLUOROETHANE. PROLONGED BREATHING OF VAPORS SHOULD BE AVOIDED. THE SOLVENT SHOULD NOT BE USED NEAR HEAT OR OPEN FLAME; THE PRODUCTS OF DECOMPOSITION ARE TOXIC AND IRRITATING. SINCE TRICHLOROTRIFLUOROETHANE DISOLVES NATURAL OILS, PROLONGED CONTACT WITH SKIN SHOULD BE AVOIDED. WHEN NECESSARY, USE GLOVES WHICH THE SOLVENT CANNOT PENETRATE. IF THE SOLVENT IS TAKEN INTERNALLY, CONSULT A PHYSICIAN IMMEDIATELY.

Section II TROUBLESHOOTING PROCEDURES

The TROUBLESHOOTING Table lists the common malfunctions which you may find during the operation or maintenance of the AN/GRM-114A, Radio Test Set. You should perform the tests, inspections, and corrective actions in the order listed.

This manual cannot list all malfunctions that may occur, nor all tests or inspections and corrective actions. If a trouble is not listed or it cannot be corrected by performing the corrective action, notify general support maintenance.

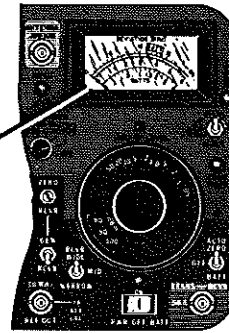
Table 3-1 TROUBLESHOOTING

STEP	MALFUNCTION <div style="margin-left: 20px;"> <p>TEST OR INSPECTION</p> <p>CORRECTIVE ACTION</p> </div>
------	---

1. Test set will not operate in battery position.

Low battery voltage indication on DEVIATION WATTS Meter.

DEVIATION WATTS METER

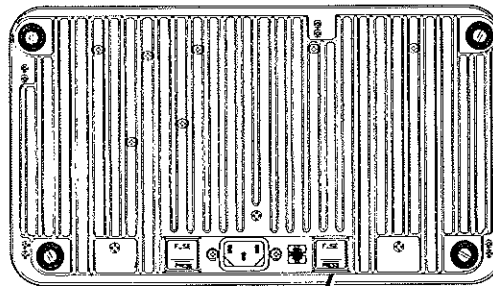


Replace battery in AN/GRM-114A.

Connect AN/GRM-114A to either an AC or DC power source to charge internal battery.

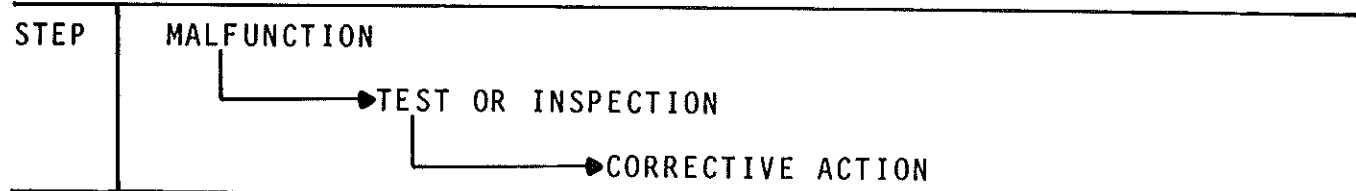
Check INTERNAL POWER Fuse (A1A22F2).

Replace fuse: If the INTERNAL POWER Fuse (A1A22F2) continues to blow, notify general support maintenance.



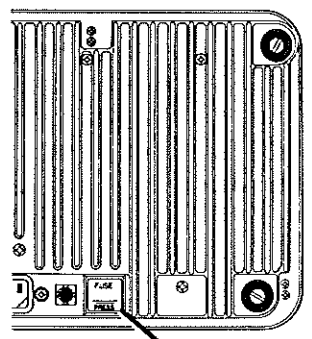
INTERNAL POWER FUSE

Table 3-1 TROUBLESHOOTING (Continued)



2. Test set will not operate from an external DC power source.

Check INTERNAL POWER Fuse (A1222F2).



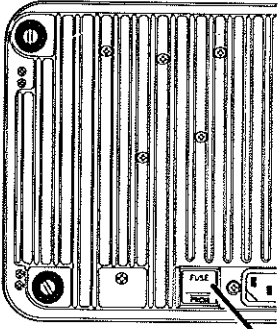
INTERNAL POWER FUSE

Replace fuse: If the INTERNAL POWER Fuse (A1A22F2) continues to blow, notify general support maintenance.

3. Test set will not operate from an external AC power source.

Check AC LINE Fuse (A1A22F1).

Replace fuse: If the AC LINE Fuse (A1A22F1) continues to blow, notify general support maintenance.



AC LINE FUSE

Table 3-1 TROUBLESHOOTING (Continued)

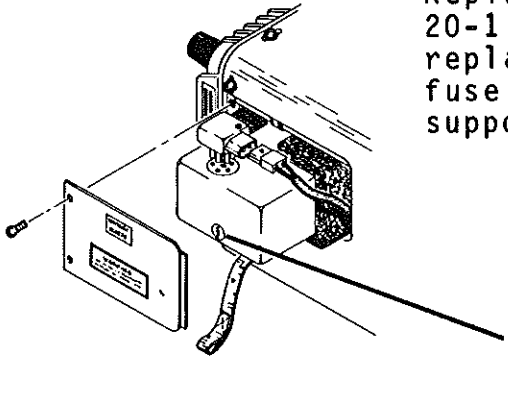
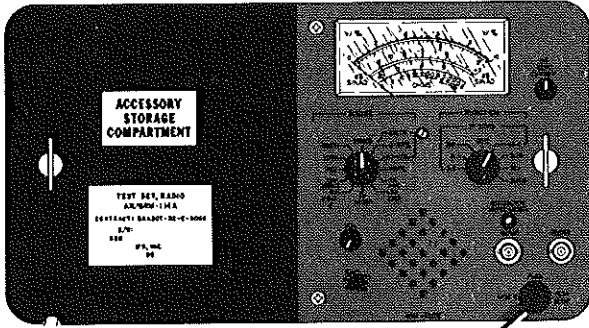
STEP	<p>MALFUNCTION</p> <p>TEST OR INSPECTION</p> <p>CORRECTIVE ACTION</p>
4.	<p>Test set will not operate from internal battery power source.</p> <p>Check internal battery fuse.</p> <p>Replace fuse: (Refer to TM11-6625-3016-20-1 for battery removal and fuse replacement.) If the internal battery fuse continues to blow, notify general support maintenance.</p> 
5.	<p>MM-100E, Multimeter does not operate in Ohms position.</p> <p>Check Fuse (A2A1F1).</p> <p>Replace fuse: If the MM-100E fuse continues to blow, notify general support maintenance.</p> 

Table 3-1 TROUBLESHOOTING (Continued)

STEP	MALFUNCTION
------	-------------

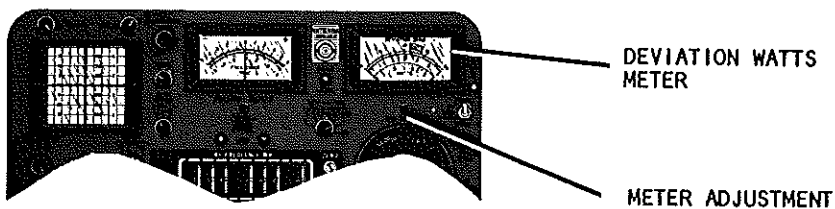
└───┬───> TEST OR INSPECTION
 └───┬───> CORRECTIVE ACTION

6. FM/AM-1100S DEVIATION WATTS Meter will not indicate correct reading.

Perform Step 5 in PMCS Table 2-1.

Zero adjust meter with all power off to test set.

Notify general support maintenance if meter will not zero adjust.



7. FM/AM-1100S FREQUENCY ERROR Meter will not indicate correct reading.

Perform Step 5 in PMCS Table 2-1.

Zero adjust meter with all power off to test set.

If zero adjust does not correct problem, place PWR/OFF/BATT Switch to "ON", GEN/RCVR Switch to "GEN" and AUTO ZERO/OFF/BATT Switch to "AUTO ZERO". Zero adjust frequency error meter using the ZERO RCVR Adjustment.

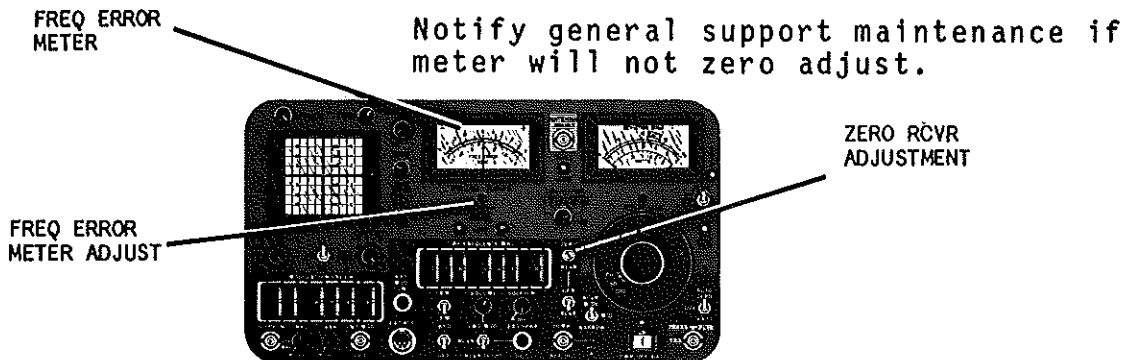
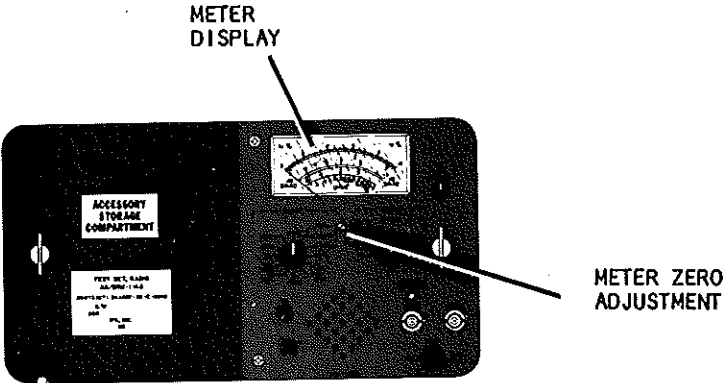


Table 3-1 TROUBLESHOOTING (Continued)

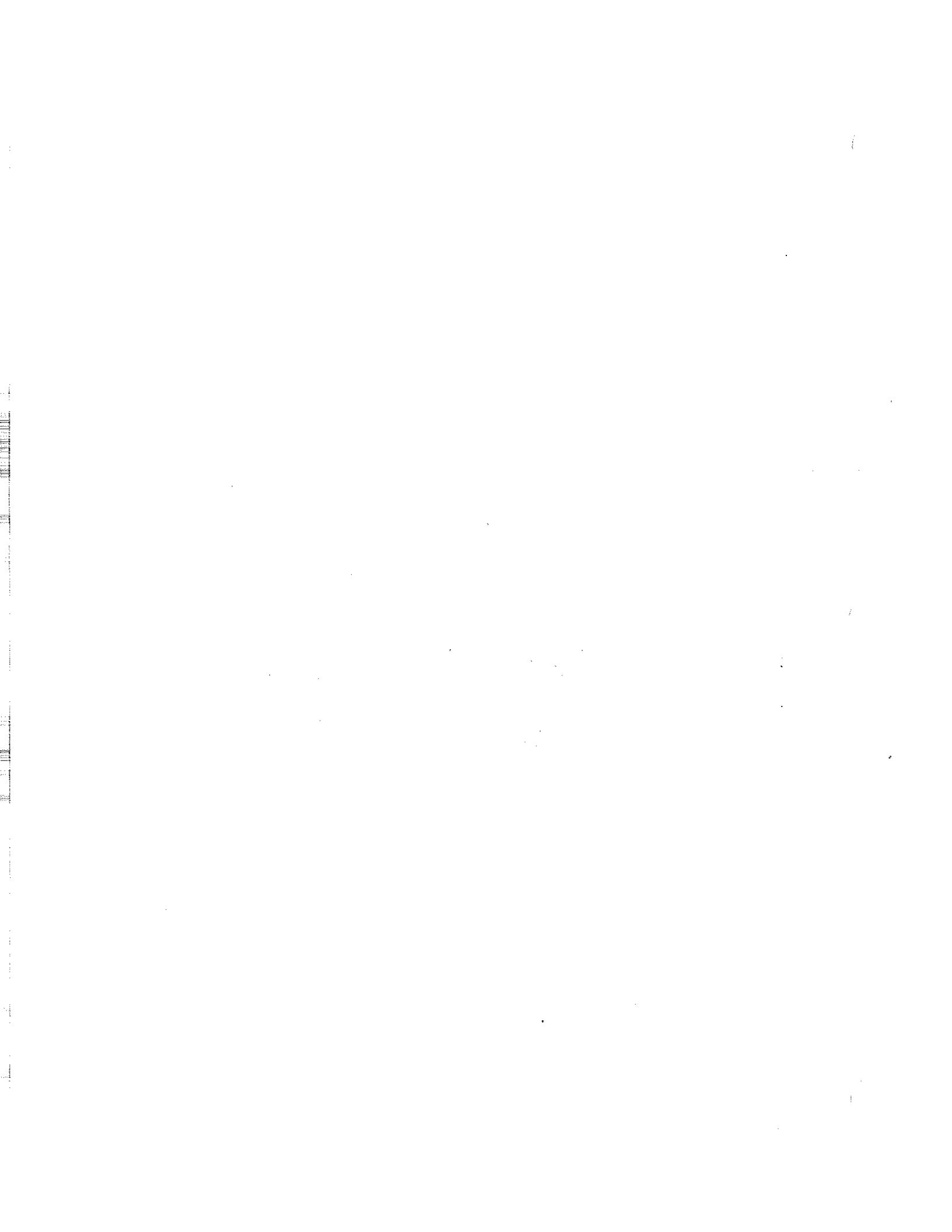
STEP	MALFUNCTION <div style="margin-left: 40px;"> <p>└───▶ TEST OR INSPECTION</p> <p>└───▶ CORRECTIVE ACTION</p> </div>
8.	<p>MM-100E Meter will not indicate correct reading.</p> <p style="padding-left: 40px;">Perform Step 5 in PMCS Table 2-1.</p> <p style="padding-left: 40px;">Zero adjust meter with all power off to test set.</p> <p style="padding-left: 40px;">Notify general support maintenance if meter will not zero adjust.</p> <div style="text-align: center; margin-top: 20px;">  <p>The diagram shows a rectangular MM-100E meter. On the left side, there is a compartment labeled 'ACCESSORY STORAGE COMPARTMENT' with a small label below it that reads 'PERM. VOL. RANGE 0-100V 1-400Hz APPROX. 100mA 10-400Hz 100V 100mA'. On the right side, there is a circular 'METER DISPLAY' with a needle and scale. Below the display is a 'METER ZERO ADJUSTMENT' screw. Two other screws are visible at the bottom right of the meter face.</p> </div>

APPENDIX A

REFERENCES

The following is a list of applicable references that are available to the operator of the AN/GRM-114A Radio Test Set.

DA Pam 310-1	Consolidated Index of Army Publications and Blank Forms.
DA Pam 738-750	The Army Maintenance Management System (TAMMS).
SB 11-573	Painting and Preservation of Supplies Available for Field Use for Electronics Command Equipment.
SB 38-100	Preservation, Packaging, Packing and Marking Materials, Supplies and Equipment Used by the Army.
TB 43-0118	Field Instructions for Painting and Preserving Electronics Command Equipment Including Camouflage Pattern Painting of Electrical Equipment Shelters.
TB 43-180	Calibration Requirements for the Maintenance of Army Material.
TB 43-180-1	Calibration and Repair Requirements for the Maintenance of Army Material.
TB 385-4	Safety Precautions for Maintenance of Electrical/Electronic Equipment.
TM 11-6625-3016-10-1	Operator's Manual for Radio Test Set AN/GRM-114A (NSN 6625-01-144-4481).
TM 11-6625-3016-20-1	Organizational Maintenance Manual for Radio Test Set AN/GRM-114A (NSN 6625-01-144-4481).
TM 740-90-1	Administrative Storage of Equipment
TM 750-244-2	Procedures for Destruction of Electronics Materiel to Prevent Enemy Use (Electronics Command).



APPENDIX B

COMPONENT OF END ITEM LIST

Section I, INTRODUCTION

B-1. SCOPE.

This appendix lists Components of End Item and Basic Issue Items for the AN/GRM-114A to help you inventory items required for safe and efficient operation.

B-2. GENERAL.

The Components of End Item list is divided into the following sections:

a. Section II, INTEGRAL COMPONENTS OF THE END ITEM.

These items, when assembled, comprise the AN/GRM-114A Radio Test Set and must accompany it whenever it is transferred or turned in. The illustration following this section (Figure B-1) will help you identify these items.

b. Section III, BASIC ISSUE ITEMS.

Not applicable.

B-3. EXPLANATION OF COLUMNS.

a. Column (1) - Illustration Number (Illus. Number). This column indicates the number on the illustration in which the item is shown.

b. Column (2) - National Stock Number. Indicates the National stock number assigned to the item and will be used for requisitioning purposes.

c. Column (3) - Description. Indicates the Federal item name and, if required, a minimum description to identify and locate the item. The last line for each item indicates the FSCM (in parentheses) followed by the part number.

d. Column (4) - Unit of Measure (U/M). Indicates the measure used in performing the actual operational/maintenance function. This measure is expressed by a two-character alphabetical abbreviation (e.g. EA, IN, PR).

e. Column (5) - Quantity Required (Qty rqr). Indicates the quantity of the item authorized to be used with/on the equipment.

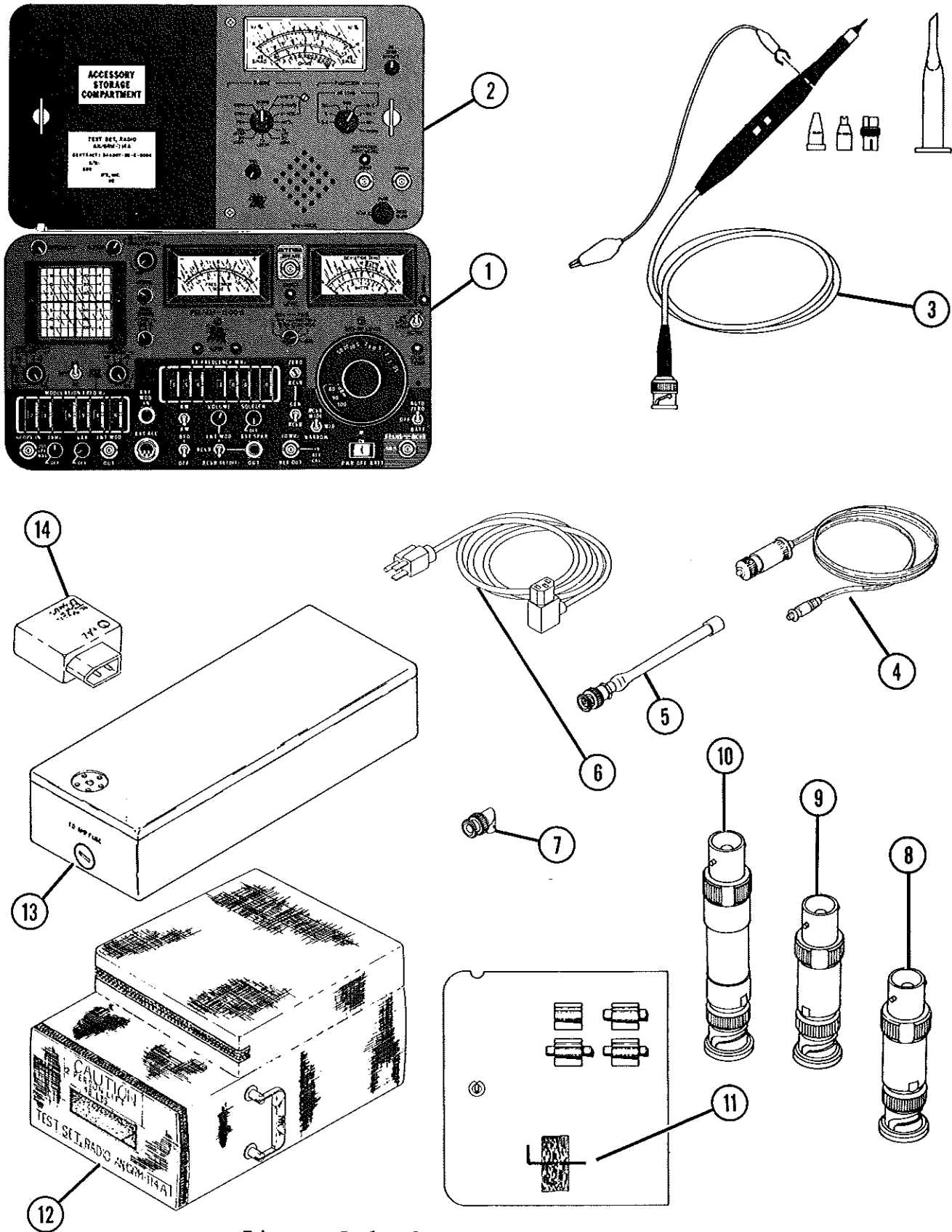


Figure B-1 Components of End Item

Section II. COMPONENTS OF END ITEM

(1)	(2)	(3)	(4)	(5)
ILLUS. NUMBER	NATIONAL STOCK NUMBER	DESCRIPTION FSCM and PART NUMBER	U/M	QTY RQR
1	6625-01-141-4481	FM/AM-1100S Communications Service Monitor (51190) (7002-2364-303)	EA	1
2	6625-01-148-6598	MM-100E Multimeter (51190) (7002-2389-100)	EA	1
3	6625-01-164-4408	Probe Kit (51190) (6500-2380-800)	EA	1
4	6625-01-191-2905	Cable Assembly, DC Power (51190) (6041-5082-700)	EA	1
5	6625-01-166-2755	Antenna, Flex (51190) (1201-7616-500)	EA	1
6	6510-01-105-0344	Cable Assembly, AC Power (51190) (6041-0001-001)	EA	1
7	5935-01-032-5404	Adapter, Connector BNC 90 (51190) (2113-0000-013)	EA	1
8	5985-00-689-1923	Attenuator, Fixed 10 dB, 2.0 GHz, 1 W (51190) (2901-0401-010)	EA	1
9	4920-00-456-6965	Attenuator, Fixed 20 dB, 2.0 GHz, 1 W (51190) (2901-0401-020)	EA	1
10	5985-01-190-6837	Attenuator, Fixed 30 dB, 12.4 GHz, 2 W (51190) (2901-0402-030)	EA	1
11		Key, Hex short arm, .050 (51190) (2850-0000-059)	EA	1
12	6625-01-192-0269	Case Canvas Cover/Carrying which includes the TM 11- 6625-3016-10-1 and TM 11- 6625-3016-20-1 Manuals (51190) (1412-2380-700)	EA	1

Section II COMPONENTS OF END ITEM (CONTINUED)

(1) ILLUS. NUMBER	(2) NATIONAL STOCK NUMBER	(3) DESCRIPTION FSCM and PART NUMBER	(4) U/M	(5) QTY RQR
13	6140-01-084-1460	Battery, Rechrq, sealed nickel cadmium 13.2 V, 4.0 ah @ .8 amperes (51828) (BB-586/U)	EA	1
14	5935-01-254-6039	Adapter, battery connector (51190) (2146-2399-600)	EA	1

**APPENDIX C
ADDITIONAL AUTHORIZATION LIST**

Section I, INTRODUCTION.

C-1. SCOPE.

This appendix lists additional items you are authorized for support of the Radio Test Set.

C-2. GENERAL.

This list identifies items that do not have to accompany the AN/GRM-114A Radio Test Set and that do not have to be turned in with it. These items are all authorized to you by CTA, MTOE, TDA or JTA.

C-3. EXPLANATION OF LISTING.

National stock numbers, descriptions, and quantities are provided to help you identify and request the additional items you require to support the equipment. The items are listed in alphabetical sequence by item name under the type document (i.e. CTA, MTOE, TDA or JTA) which authorizes the item(s) to you.

Section II, ADDITIONAL AUTHORIZATION LIST

(1) NATIONAL STOCK NUMBER	(2) DESCRIPTION FSCM & PART NUMBER	(3) U/M	(4) QTY AUTH
5920-00-280-5029	Fuse 1/32 A, 250 V (51190) (5106-4500-031)	EA	1
(none assigned)	Fuse 2.0 A, 250 V (51190) (5106-4602-000)	EA	1
5920-00-056-6620	Fuse 7 1/2 A, 32 V (51190) (5106-0000-009)	EA	1
6140-01-084-1460 or 5920-00-557-2080	Fuse 10 A, 32 V	EA	1

APPENDIX D
EXPENDABLE SUPPLIES AND MATERIALS LIST
Section I, INTRODUCTION

D-1. SCOPE.

This appendix lists expendable supplies and materials you will need to operate and maintain the AN/GRM-114A Radio Test Set. These items are authorized to you by CTA 50-970, expendable items (Except Medical, Class V, Repair Parts and Heraldic Items).

D-2. EXPLANATION OF COLUMNS.

a. Column (1) - Item Number. No number appears in this column if the expendable item is referenced in the narrative by military specifications on other items. If the item is identified in the narrative instructions by an item number, this number will appear in this column.

b. Column (2) - Level. This column identifies the lowest level of maintenance that requires the listed item.

C - Operator/Crew

O - Organizational Maintenance

F - Direct Support Maintenance

H - General Support Maintenance

c. Column (3) - National Stock Number. This is the National stock number assigned to the item; use it to request or requisition the item.

d. Column (4) - Description. Indicates the Federal item name and, if required, a description to identify the item. The last line for each item indicates the FSCM in parenthesis followed by the part number in parenthesis.

e. Column (5) - Unit of Measure (U/M). Indicates the measure used in performing the actual maintenance function. This measure is expressed by a two-character alphabetical abbreviation (e.g. EA, IN, PR). If the unit of measure differs from the unit of issue, requisition the lowest unit of issue that will satisfy your requirements.

Section II, EXPENDABLE SUPPLIES AND MATERIALS LIST

(1) ITEM NUMBER	(2) LEVEL	(3) NATIONAL STOCK NUMBER	(4) DESCRIPTION FCSM and PART NUMBER	(5) UNIT OF MEASURE
	0	8010-00-584-3157	Paint Rubber, Olive Drab No. X204B7 (81348) (MIL-F-014072)	PT
	0	9150-00-159-4513	Enamel, Semigloss Black (80244) (27038)	PT
	0	FED STD 595	Enamel, Semigloss Gray (26440)	PT
	0	6850-00-105-3084	Trichlorotriflouroethane (Cleaning compound) (81349) (Type TF)	QT
	0	8020-00-721-9657	Brush, Paint, Flat 1½" wide (81348) (FED-SPEC H-B-451)	EA
	0	5350-00-264-3485	Paper, Abrasive, Flint, extra fine grade (81348) (FED-SPEC-PP-105)	RL
	0	5350-00-145-0147	Primer, 3 in chromate (81348) (FED-SPEC-TT-P-600)	PT
	0		Soft lint-free cloth	RL

APPENDIX E

INDEX

	Page
A	
Abbreviations	1-3
AC Operation	2-67
Audio Generation with MM-100E Operating Instructions	2-49
Audio Generator Operating Instructions	2-48
B	
Battery Operation	2-64
C	
Capabilities and Features	1-4
Cleaning	3-1
Controls, Connectors and Indicators	
Front Panel	2-1
Rear Panel	2-10
MM-100E	2-11
D	
Detailed Operating Instructions	2-19
DC Operation	2-66
E	
Electrical Characteristics	1-5
Emergency Operation	
Jamming	2-36
Emergency Operating Procedures	2-20
Environmental Characteristics	1-12
Equipment Description	1-4
F	
Forms, Maintenance	1-2
Frequency Error Measurement Operating Instructions	2-59
J	
Jamming	2-36

M

Master Oscillator Calibration Using External Frequency Standard 2-58
 Master Oscillator Calibration Using Received Time Standard Signal (WWV) 2-55
 Multimeter Operating Instructions 2-61

O

Operation
 Under Unusual Conditions 2-68
 Under Usual Conditions 2-64
 Oscilloscope Operating Procedures 2-29

P

Performance Data 1-5
 Physical Characterisitics 1-11
 Power Monitor Operating Instructions for Measuring Transmitter Carrier Power 2-53
 Preventive Maintenance 2-15

R

Receiver Operating Instructions 2-32
 Records, Maintenance 1-2
 Reports, Equipment Improvement Recommendations (EIR) i
 RF Signal Generator Operating Instructions 2-21
 Generating AM RF Signals 2-24
 Generating FM RF Signals 2-27

S

Spectrum Analyzer Operating Instructions 2-40
 Detecting Spurious Signals 2-44
 Start-Up Procedures 2-20
 Stopping Procedures 2-21

T

Troubleshooting Procedures 3-1

By Order of the Secretary of the Army:

Official:

JOHN A. WICKHAM JR.
General, United States Army
Chief of Staff

ROBERT M. JOYCE
Major General, United States Army
The Adjutant General

Distribution:

To be distributed in accordance with special list.

DISTRIBUTION:

To be distributed in accordance with DA Form 12-34C, requirements for Calibration Procedures Publications.

RECOMMENDED CHANGES TO EQUIPMENT TECHNICAL PUBLICATIONS



THEN... JOT DOWN THE DOPE ABOUT IT ON THIS FORM. CAREFULLY TEAR IT OUT. FOLD IT AND DROP IT IN THE MAIL.

SOMETHING WRONG WITH THIS PUBLICATION?

FROM: (PRINT YOUR UNIT'S COMPLETE ADDRESS)

CDR, 1st Bn, 65th ADA
ATTN: SP4 John Doe
Key West, FL 33040

DATE SENT
14 January 1979

PUBLICATION NUMBER

TM 9-1430-550-34-1

PUBLICATION DATE

7 Sep 72

PUBLICATION TITLE Unit of Radar Set
AN/MPQ-50 Tested at the HFC

BE EXACT... PIN-POINT WHERE IT IS

PAGE NO	PARA-GRAPH	FIGURE NO	TABLE NO
9-19		9-5	
21-2	step 1C		21-2

SAMPLE

IN THIS SPACE TELL WHAT IS WRONG AND WHAT SHOULD BE DONE ABOUT IT:

"B" Ready Relay K11 is shown with two #9 contacts. That contact which is wired to pin 8 of relay K16 should be changed to contact #10.

Reads: Multimeter B indicates 600 K ohms to 9000 K ohms.

Change to read: Multimeter B indicates 600 K ohms minimum.

Reason: Circuit being checked could measure infinity. Multimeter can read above 9000 K ohms and still be correct.

NOTE TO THE READER:

Your comments will go directly to the writer responsible for this manual, and he will prepare the reply that is returned to you. To help him in his evaluation of your recommendations, please explain the reason for each of your recommendations, unless the reason is obvious.

All comments will be appreciated, and will be given immediate attention. Handwritten comments are acceptable.

For your convenience, blank "tear out" forms, preprinted, addressed, and ready to mail, are included in this manual.

PRINTED NAME, GRADE OR TITLE, AND TELEPHONE NUMBER

SP4 John Doe, Autovon 222-222

SIGN HERE

DA FORM 2028-2
1 JUL 79

PREVIOUS EDITIONS ARE OBSOLETE.

PS --IF YOUR OUTFIT WANTS TO KNOW ABOUT YOUR RECOMMENDATION MAKE A CARBON COPY OF THIS AND GIVE IT TO YOUR HEADQUARTERS

RECOMMENDED CHANGES TO EQUIPMENT TECHNICAL PUBLICATIONS

SOMETHING WRONG

WITH THIS PUBLICATION?



THEN... JOT DOWN THE DOPE ABOUT IT ON THIS FORM, CAREFULLY CUT IT OUT, FOLD IT AND DROP IT IN THE MAIL!

FROM: (PRINT YOUR UNIT'S COMPLETE ADDRESS)

DATE SENT

PUBLICATION NUMBER

PUBLICATION DATE

PUBLICATION TITLE

BE EXACT... PIN-POINT WHERE IT IS

IN THIS SPACE TELL WHAT IS WRONG AND WHAT SHOULD BE DONE ABOUT IT:

PAGE NO.	PARA-GRAPH	FIGURE NO.	TABLE NO.
----------	------------	------------	-----------

CUT ALONG THIS LINE

PRINTED NAME, GRADE OR TITLE, AND TELEPHONE NUMBER

SIGN HERE

DA FORM 1 JUL 79 2028-2

PREVIOUS EDITIONS ARE OBSOLETE.

PS - IF YOUR OUTFIT WANTS TO KNOW ABOUT YOUR RECOMMENDATION MAKE A CARBON COPY OF THIS AND GIVE IT TO YOUR HEADQUARTERS

FILL IN YOUR
UNIT'S ADDRESS



FOLD BACK

DEPARTMENT OF THE ARMY

Commander
U.S. Army Aviation and Missile Command
ATTN: AMSAM-MMC-LS-LP
Redstone Arsenal, AL 35898-5230

CUT ALONG THIS LINE

RECOMMENDED CHANGES TO EQUIPMENT TECHNICAL PUBLICATIONS

SOMETHING WRONG WITH THIS PUBLICATION?



THEN... JOT DOWN THE DOPE ABOUT IT ON THIS FORM, CAREFULLY CUT IT OUT, FOLD IT AND DROP IT IN THE MAIL!

FROM: (PRINT YOUR UNIT'S COMPLETE ADDRESS)

DATE SENT

PUBLICATION NUMBER

PUBLICATION DATE

PUBLICATION TITLE

BE EXACT... PIN-POINT WHERE IT IS

PAGE NO.

PARA-GRAPH

FIGURE NO.

TABLE NO.

IN THIS SPACE TELL WHAT IS WRONG AND WHAT SHOULD BE DONE ABOUT IT:

CUT ALONG THIS LINE

PRINTED NAME, GRADE OR TITLE, AND TELEPHONE NUMBER

SIGN HERE

FILL IN YOUR
UNIT'S ADDRESS



FOLD BACK

DEPARTMENT OF THE ARMY

CUT ALONG THIS LINE

Commander
U.S. Army Aviation and Missile Command
ATTN: AMSAM-MMC-LS-LP
Redstone Arsenal, AL 35898-5230

FILL IN YOUR
UNIT'S ADDRESS



FOLD BACK

DEPARTMENT OF THE ARMY

CUT ALONG THIS LINE

Commander
U.S. Army Aviation and Missile Command
ATTN: AMSAM-MMC-LS-LP
Redstone Arsenal, AL 35898-5230