

**1200 SUPER S
COMMUNICATION
SERVICE MONITOR**

**OPERATION
MANUAL**

10200 West York / Wichita, KS 67215 U.S.A.

(316) 522-4981 / FAX (316) 524-2623

SAFETY FIRST: TO ALL OPERATIONS & SERVICE PERSONNEL

REFER ALL SERVICING OF UNIT TO QUALIFIED TECHNICAL PERSONNEL.

SAFETY IDENTIFICATION IN TECHNICAL MANUAL

The following terms are used throughout this manual to draw attention to possible safety hazards, which may exist when operating or servicing this equipment.

CAUTION: THIS TERM IDENTIFIES CONDITIONS WHICH CAN RESULT IN EQUIPMENT OR PROPERTY DAMAGE.

WARNING: THIS TERM IDENTIFIES CONDITIONS OR ACTIVITIES WHICH, IF IGNORED, CAN RESULT IN PERSONAL INJURY OR DEATH.

SAFETY SYMBOLS IN MANUALS & ON UNITS



INFORMATION PRECAUTION: Corresponds with an applicable item on the device and in the manual. This symbol defines specific voltage, current and power requirements or other related information for safe operation or service of equipment.



AC OR DC TERMINAL: Terminal which may supply or be supplied with ac or dc voltage.



DC TERMINAL: Terminal which may supply or be supplied with dc voltage.



AC TERMINAL: Terminal which may supply or be supplied with ac voltage.



SWITCH OFF: AC line power to the device is OFF.



SWITCH ON: AC line power to the device is ON.

POWER SUPPLY

This device is intended for operation from a power source no more than 120 VAC (North American)/240 VAC (European) at a frequency of 50 to 400 Hz. Power supply specifications are provided within the manual.

EQUIPMENT GROUNDING PRECAUTION

Improper grounding of equipment can result in electrical shock.

USE OF PROBES

Check the maximum voltage, current and power ratings of any connector on the equipment in the product specifications prior to connecting it with a probe from a terminal device. Be sure the terminal device performs within these specifications prior to using it for measurement, to prevent electrical shock or damage to the equipment.

POWER CORDS

Power cords are supplied specifically for use with this product. The power cord must not be frayed, broken nor expose bare wiring when operating this equipment.

USE RECOMMENDED FUSES ONLY

Use only fuses specifically recommended for the equipment at the specified current and voltage ratings.

CASE, COVER OR PANEL REMOVAL

Removing protective covers, casings or panels from this product exposes the operator to electrical hazards which can result in electrical shock or equipment damage. Do not operate this equipment with the case, cover or panels removed.

CAUTION: INTEGRATED CIRCUITS AND SOLID STATE DEVICES ARE SUSCEPTIBLE TO DAMAGE BY ELECTROSTATIC DISCHARGES RECEIVED FROM IMPROPER HANDLING, THE USE OF UNGROUNDED TOOLS, AND IMPROPER STORAGE AND PACKAGING. PROPER ESD PRECAUTIONS MUST BE UTILIZED AS REQUIRED.

THE USE OF SIGNAL GENERATORS FOR MAINTENANCE AND OTHER ACTIVITIES CAN BE A SOURCE OF ELECTRO-MAGNETIC INTERFERENCE (EMI) TO COMMUNICATION RECEIVERS, WHICH CAN CAUSE DISRUPTION AND INTERFERENCE TO COMMUNICATION SERVICE OUT TO A DISTANCE OF SEVERAL MILES. USERS OF THIS EQUIPMENT SHOULD SCRUTINIZE ANY OPERATION WHICH RESULTS IN RADIATION OF A SIGNAL (DIRECTLY OR INDIRECTLY) AND SHOULD TAKE NECESSARY PRECAUTIONS TO AVOID POTENTIAL COMMUNICATION INTERFERENCE PROBLEMS.

TABLE OF CONTENTS

SECTION 1 - OVERVIEW

1.1	1200 SUPER S Overview	1-1
1.2	To Install the 1200 SUPER S	1-2
1.3	Operating Basics	1-3

SECTION 2 - CONTROLS, CONNECTORS AND INDICATORS

2.1	1200 SUPER S Front Panel	2-1
2.2	1200 SUPER S Rear Panel	2-6
2.3	Keyboard Description	2-7

SECTION 3 - OPERATION

3.1	Generate Mode Operation	3-1
3.2	Receive Mode Operation	3-7
3.3	Duplex Mode Operation	3-12
3.4	Duplex Generate Mode Operation	3-14
3.5	Oscilloscope Operation	3-15
3.6	Spectrum Analyzer Operation	3-16
3.7	Digital Voltmeter (DVM) Operation	3-18
3.8	Tone Generator Operation	3-19

SECTION 4 - APPLICATIONS

4.1	How to Measure Receiver Center Frequency	4-1
4.2	How to Measure Receiver Sensitivity	4-2
4.3	How to Measure Receiver Audio Output Level	4-3
4.4	How to Measure Modulation Acceptance Bandwidth for an FM Receiver	4-4
4.5	How to Measure Receiver IF Bandwidth	4-5
4.6	How to Measure Transmitter Frequency Error	4-6
4.7	How to Measure Transmitter CTCSS Frequency	4-7
4.8	How to Measure Transmitter Harmonics	4-8
4.9	How to Perform Cable Fault Test	4-9
4.10	How to Perform Deviation Check	4-10

SECTION 5 - REMOTE OPERATION

5.1	Remote Operations Overview	5-1
5.2	1200 SUPER S Remote Commands	5-2

SECTION 6 - OPTIONS

6.1	List of Options Available	6-1
6.2	Generate Amplifier Option	6-1
6.3	European Tone Signaling Option	6-2
6.4	Tracking Generator Option	6-4
6.5	IEEE-488 (GPIB) Option	6-4
6.6	CLEARCHANNEL LTR [®] Option	6-5
6.7	E-TACS/AMPS Mobile Station Test Option	6-11

APPENDICES

Appendix A	Specifications	A-1
Appendix B	Table of User I/O Ports and Connector Pin-Out Tables	B-1
Appendix C	Abbreviations	C-1
Appendix D	Repacking for Shipment	D-1

INDEX

Index	Index-1
-----------------	---------

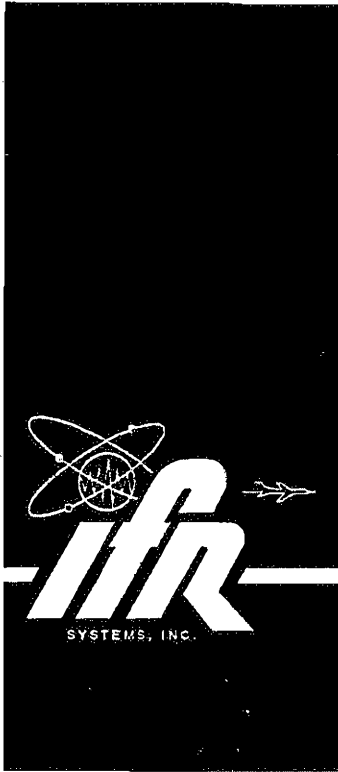

**OPERATION
MANUAL
SUPPLEMENT**

**1200 SUPER S
RS-232 REMOTE OPERATION**

PUBLISHED BY
IFR SYSTEMS, INC.
Wichita, Kansas

COPYRIGHT © 1995 by IFR SYSTEMS, INC.

All rights reserved. Printed in the United States of America. No part of this publication may be reproduced, stored in a retrieval system, or transmitted in any form or by any means, electronic, mechanical, photocopying, recording or otherwise without the prior permission of the publisher.

1200 SUPER S RS-232 REMOTE OPERATION SUPPLEMENT

1. Introduction

This supplement contains necessary information to effectively use the RS-232 Serial Port on the 1200 Super S rear panel.

It is strongly recommended that personnel be thoroughly familiar with the contents of this supplement before attempting Remote Operation of the 1200 Super S.

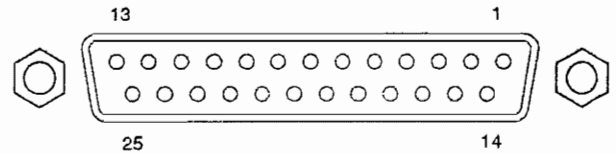

RS232 01

RS-232 25-Pin Connector Identification

2. Pin-Out Tables

The following tables illustrate pin assignments for the Standard RS-232 25-Pin Connector and the RS-232 9-Pin Connector.

PIN NUMBER	INPUT/OUTPUT	REMARKS
2 (RD _X)	Commands	
3 (TD _X)	Info	
4 (RTS)		If high, the unit can receive command. If low, the unit busy
5 (CTS) 6 (DSR) (Pin 5 & 6 tied together)		If low, terminal not ready to receive. If not used, it must be tied high
7 (Common Ground)		
1, 8 thru 25 not used		

Pin-Out Table for RS-232 25-Pin Connector (Standard)

PIN NUMBER	INPUT/OUTPUT	DATA
1	Input	DCD
2	Output	TX
3	Input	RX
4	Input	DSR
5	None	GND
6	Output	DTR
7	Input	CTS
8	Output	RTS
9	Input	/RI

Pin-Out Table for RS-232 9-Pin Connector

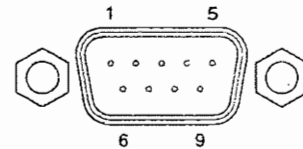

RS232 02

RS-232 9-Pin Connector Identification

1200 SUPER S RS-232 REMOTE OPERATION SUPPLEMENT

3. Wiring Diagram

An effective communication link between the 1200 Super S and Personal Computer (PC) is dependent on a properly wired cable. Refer to illustration for a properly wired cable assembly.

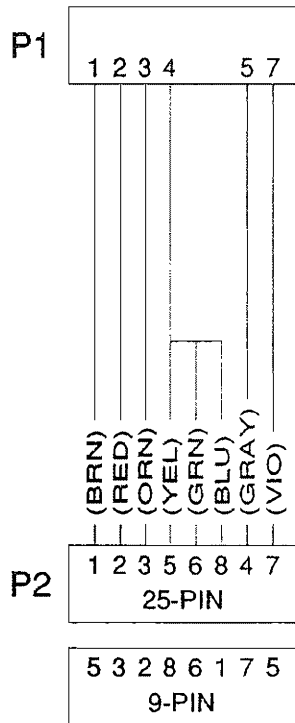

RS232 03

Cable Assembly Bill of Materials (with IFR Part Numbers)

- 1 ea., 25-Pin "D" Shell Connector (Male)(P1), 2116-0000-006
 - 6 ea., Contact, Male, 2114-0000-005
 - 1 ea., 25-Pin "D" Shell Connector (Female)(P2), 2116-0000-005
 - 8 ea., Contact, Female, 2114-0000-003
- 2 ea., Cover, "D" Shell, Metal, 2121-0000-008
 - 4 ft., Tubing, Vinyl, Clear, 6012-0186-110
 - 26 ga., Stranded Wire, as required (Colors not necessary)
- For 9-Pin IBM Connector (P2), use IFR Part Number 2116-0000-001 and Female Contacts mentioned above.
- ### 4. Equipment Needed
- Along with a properly wired cable, the only piece of equipment needed for successful remote operation is a (PC) with RS-232 communication capability installed with a communications software package (such as PROCOMM PLUS[®] or the Terminal Program . available with Microsoft[®] Windows[™]).
- ### 5. Set up the PC, Interface and Perform a Simple Test
- This example uses the PROCOMM PLUS[®] communication software package.
- Access PROCOMM PLUS[®] on the PC.
 - Access the Current Settings screen.
 - Establish Baud Rate, Parity, Data Bits, Stop Bits and Port preferences.
 - Refer to Section 5, Remote Operation, in the 1200 Super S Operation Manual to configure the 1200 Super S for remote operation.
- Match the 1200 Super S settings to the PROCOMM PLUS[®] settings.**
- At the PC prompt, type "UOK?". Hit ENTER. A "%" symbol on the PC means successful communication.

1200 SUPER S RS-232 REMOTE OPERATION SUPPLEMENT

6. List of Remote Commands

Refer to Section 5, Remote Operation, in the 1200 Super S Operation Manual for a complete list of remote commands.

7. DOS Qbasic Programming Example

Here is a sample practice program to help familiarize programmers with the 1200 Super S RS-232 capabilities. This example uses Microsoft MS-DOS® Version 6.2.

This sample practice program finds any audio tone frequency on the RF Signal. The program search begins at 300 Hz and graduates until all audio tone frequencies are detected and identified. Run the program or use it as a reference guide when programming.

Access Qbasic on the PC. Type the program in the lefthand column. The column on the right is the prescribed action. *Do not type it in.*

PROGRAM	PRESCRIBED ACTION
DECLARE SUB Delay (Time!)	
DECLARE SUB Say (Text\$)	
DECLARE FUNCTION Ask\$ (Text\$)	
CLS	
OPEN "com2:19200,n,8,1,cs,ds,lf" FOR RANDOM AS #1	establish communication with 1200 Super S
Say ""	1200 Super S says RS-232 ENABLED
A\$ = Ask("UOK?")	1200 Super S returns "%"
Say "REM"	take control of switches
Say "AFE3"	set freq error meter to audio 300
Freq! = 100 0	
Say "AEF=" + STR\$(Freq!)	first trial tone
Reply! = VAL(Ask\$("MTR1?"))	get the meter reading

1200 SUPER S RS-232 REMOTE OPERATION SUPPLEMENT

PROGRAM	PRESCRIBED ACTION
PRINT Reply!	
Delay 4	wait 4 seconds
DO	
Say "AFF=" + STR\$(Freq!)	set the trial tone
LOCATE 1, 1	
PRINT "Trial Frequency: "; Freq!; " "	show the trial tone
Delay 2	wait 2 seconds for meter to settle
Reply! = VAL(Ask\$("MTR1?"))	get meter reading
IF ABS(Reply!) > 300 THEN Reply! = 600 * SGN(Reply!)	overrange
Freq! = INT((Freq! + Reply!) * 10) / 10	set next trial tone
IF Freq! < 0 THEN Freq! = 0	handle negative frequency
IF ABS(Reply!) < 30 THEN	
IF ABS(Reply!) < 3 THEN	
IF NOT Flag2% THEN	
Flag2% = True	
Say "AFE1"	set freq error meter to audio 3
Delay 4	wait 4 seconds
END IF	
ELSE	

1200 SUPER S RS-232 REMOTE OPERATION SUPPLEMENT

PROGRAM	PRESCRIBED ACTION
IF NOT Flag1% THEN	
Flag1 = True	
Say "AEE2"	set freq error meter to audio 30
Delay 4	wait 4 seconds
END IF	
END IF	
END IF	
LOOP UNTIL ABS(Reply!) < .2	loop until resolution of meter
LOCATE 2, 2	
PRINT "Tone Frequency: "; Freq!	
Say "!" + "Tone is" + STR\$(Freq!)	print the tone on the 1200 Super S
Say "LOC"	release control of the 1200 Super S
END	
FUNCTION Ask\$ (Text\$) STATIC	send the text\$ and return a reply
PRINT #1, Text\$	
INPUT #1, A\$	
Ask\$ = A\$	
END FUNCTION	
SUB Delay (Time!)	wait Time! number of seconds

1200 SUPER S RS-232 REMOTE OPERATION SUPPLEMENT

PROGRAM	PRESCRIBED ACTION
T! = TIMER + Time!	
DO WHILE T! > TIMER	
LOOP	
END SUB	
SUB Say (Text\$) STATIC	send text\$ to the
PRINT #1, Text\$	1200 Super S
END SUB	



ATTENTION

The following paragraph on Page 2-8 of the 1200 SUPER S Operation Manual (1002-2200-100) requires a pen amend. Please amend your Operation Manual to remove:

POCSAG parameters (POCSAG),

(current paragraph)

SETUP

Accesses Setup Function for VFD Intensity (INTENSITY), Serial Communication Data (COMM), DTMF parameters (DTMF), Tone Sequence parameters (TSEQ), European Tone Signalling parameters (EURO), POCSAG parameters (POCSAG), Scan Function Parameters (SCAN), Harmonic Check Function Parameters (HARMONIC CHECK) and Deviation Check Parameters (DEVIATION CHECK).

(paragraph with pen amend)

SETUP

Accesses Setup Function for VFD Intensity (INTENSITY), Serial Communication Data (COMM), DTMF parameters (DTMF), Tone Sequence parameters (TSEQ), European Tone Signalling parameters (EURO), Scan Function Parameters (SCAN), Harmonic Check Function Parameters (HARMONIC CHECK) and Deviation Check Parameters (DEVIATION CHECK).

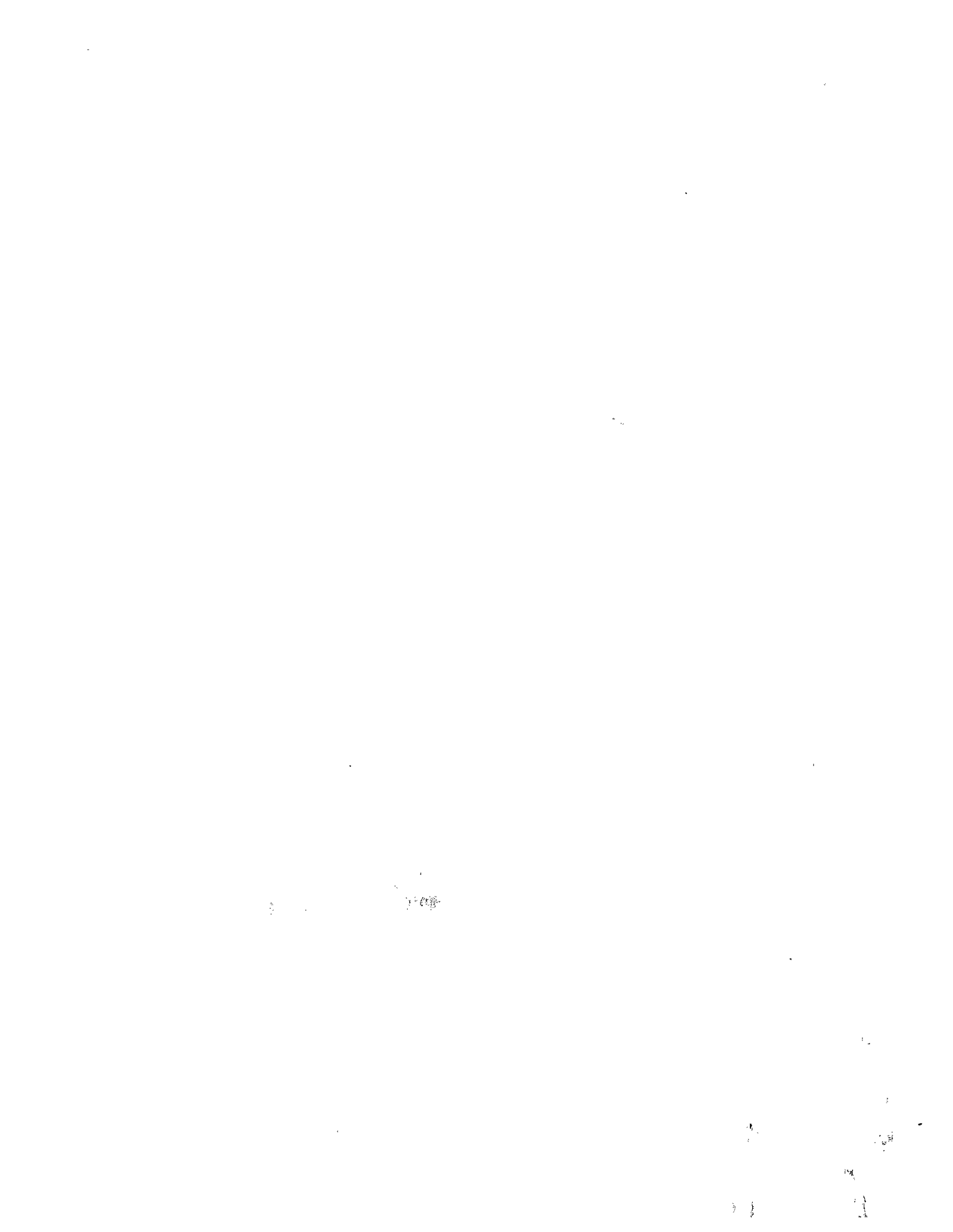

OVERVIEW

1.1 1200 SUPER S OVERVIEW

GENERATE MODE

In Generate Mode, the 1200 SUPER S is an RF Signal Generator with the ability to test a Receiver using internal testing abilities such as an Oscilloscope, Distortion Meter, SINAD Meter and DVM. The 1200 SUPER S has two internal modulation sources. There is a 1 kHz fixed tone generator and a variable tone generator. Additionally, external modulation or a microphone can be used as a modulation source. These modulations can be used to modulate the RF Signal as FM or AM modulation types.

Generate Mode testing that can be performed by the 1200 SUPER S includes:

- Receiver Sensitivity
- Receiver Audio Distortion
- Receiver Audio Output Level
- Receiver IF Bandwidth
- Modulation Acceptance

RECEIVE MODE

In Receive Mode, the 1200 SUPER S is an RF Receiver with the ability to measure a Transmitter using internal testing abilities such as a Spectrum Analyzer, Oscilloscope, Modulation Meter, Relative Signal Strength Meter, Wattmeter (average and peak), Distortion Meter, Frequency Error Meter, SINAD Meter and DVM. In Receive Mode, the 1 kHz and Variable Tone Generators are also available for use as audio sources for the Transmitter Under Test.

Receive Mode testing that can be performed by the 1200 SUPER S includes:

- Transmitter Modulation Level
- Transmitter Power (Average or Peak)
- Transmitter Frequency Error
- Transmitter SINAD
- Transmitter Distortion

DUPLEX MODE

In DUPLEX MODE, the 1200 SUPER S acts as both Generator and Receiver to test both sides of a Duplex System. The 1200 SUPER S Generator is limited to two levels, Low and High. The frequency for the 1200 SUPER S Generator is offset by an operator defined Offset Value from the 1200 SUPER S Receiver Frequency. Metering capabilities in DUPLEX MODE are the same as in RECEIVE MODE.

DUPLEX GENERATE MODE

In DUPLEX GENERATE MODE, the 1200 SUPER S acts as a Generator to test the receiver section of a Duplex System. Operation in this mode is identical to GENERATE MODE only the Frequency of transmission is the Offset Value added to the RF Value. Metering capabilities in DUPLEX GENERATE MODE are the same as in GENERATE MODE. Automatic RECEIVE MODE change over on detection of 100 mW at the T/R port is disabled.

1.2 TO INSTALL THE 1200 SUPER S

1.2.1 AC POWER INSTALLATION

SETTING 120/240 VAC SWITCH

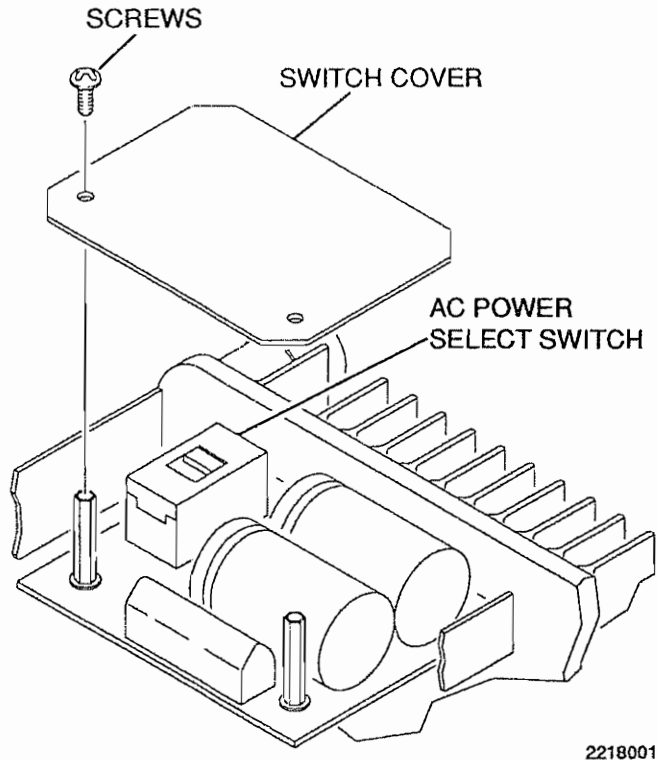

Prior to installation of ac power, the operator must verify that the 120/240 VAC Switch is properly set for the power source to be used. Inspect and set the 120/240 VAC Switch as follows:

1. Remove any external power sources from the unit.
2. Loosen 4 captive screws and remove the case from the unit.
3. Remove 2 screws and Switch Cover to expose AC Power Select Switch.
4. Verify switch is set to proper setting. If not, set switch. Current power setting is visible on switch.
5. Reinstall Switch Cover and Case.

INSTALLING AC POWER

Once 120/240 VAC Switch is properly set, ac power can be applied to the unit as follows:

1. Connect Power Cord between power source and AC Power Input Connector.
2. Set PWR/STANDBY/BATT Switch to *PWR*.

1.2.2 DC POWER INSTALLATION

1. Connect Power Cord between power source and DC Power Input Connector.
2. Set PWR/STANDBY/BATT Switch to *PWR*.

1.2.3 BATTERY INSTALLATION

Once unit is activated on Battery Power, an internal timer is set that turns the unit off after approximately 10 minutes of use. Additionally, the battery voltage is monitored and if battery voltage falls below a certain level, the unit turns off automatically.

If the unit is not to be used for 30 days or more, disconnect the battery. The battery is charged whenever external ac or dc power is applied, independent of the position of the POWER/STANDBY/BATT Switch.

Apply power as follows:

Set PWR/STANDBY/BATT Switch to *BATT*. This switch setting is a spring-loaded momentary switch. Once pressed to the *BATT* position, it will return to the *STANDBY* position. To turn the unit off manually, set PWR/STANDBY/BATT Switch to *BATT*.

1.3 OPERATING BASICS

Setting VFD Intensity

The VFD Intensity is set by pressing **2ND FUNCT**, **SETUP** and \uparrow or \downarrow Key until "SET INTENSITY" appears on the VFD with "INTENSITY" flashing. Press **ENTER** to access the function. Press \uparrow or \downarrow Key until the VFD is at desired Intensity. Press **ENTER** to complete the edit.

Editing Numeric Entries using Cursor Control Keys

When a Numeric Entry is edited, Cursor Control Keys are used to increase or decrease the value of a single digit. When editing, the flashing digit is the current cursor location. The \leftarrow and \rightarrow Keys are used to change the cursor location to another digit. Once the cursor is on the desired digit, the \uparrow and \downarrow Keys are used to increase or decrease the digit value. As the digit passes zero, more significant digits are increased or decreased, accordingly. Press **ENTER** to exit this edit mode.

Programming Memory Locations 0 through 15

Use Memory Location 0 for temporary storage only. Memory Location 0 is the "Scratch Pad" memory location and should only be used for direct entry. Program Memory Locations 1 through 9 by selecting the number corresponding to that memory location. The Memory Locations 10 through 15 for **TONE**, **RF**, **OFFSET** and **DTMF/RCC** Functions are accessed by pressing **2ND FUNCT** and a special symbol key. The key stroke requirements for each location are represented in the following table.

Memory Location	Keystroke Sequence
10	2ND FUNCT, A
11	2ND FUNCT, B
12	2ND FUNCT, C
13	2ND FUNCT, D
14	2ND FUNCT, #
15	2ND FUNCT, *

Activating 1 kHz and Variable Tone Generators

The 1 kHz Tone and the Variable Tone Generators are activated in a similar way. The 1 kHz Tone Selector Switch and the VAR Tone Selector Switch have three settings. The center setting for both switches is **OFF**. Setting either or both switches to **SPKR** routes active tones to the speaker only. Setting either or both switches to **INTL** routes the active tones to the speaker, TONE OUT Connector and RF Generator, when active, as modulation.

Once the desired Tone Generator(s) are activated, the level is set by either the VAR Tone Level Control or the 1 kHz Tone Level Control. Rotating the active control(s) cw increases the volume of the speakers, the voltage of the signal to the TONE OUT Connector and the Modulation Level of the RF Generator, depending on the position of the 1 kHz Tone Selector Switch and the VAR Tone Switch.

Setting Variable Tone Generator Frequency and Shape

The Variable Tone Generator is variable both in frequency and wave shape. To vary the frequency and wave shape, press *TONE*. The VFD displays "TONE" followed by a frequency and a wave shape. The most significant digit location flashes. The operator must enter a new frequency or edit the displayed frequency. Once the frequency has been selected, press *ENTER*, or, if the wave shape is to be changed, press the → Key until displayed wave shape is flashing. Press ↑ or ↓ Key until desired waveshape is displayed. Press *ENTER* to complete the operation.

Programming the TONE List

The 1200 SUPER S has 15 storage locations for programming Variable Tone Generator Settings. Each location is programmed by pressing *PROG, TONE* and the number of the desired storage location. The VFD then displays "TONE" followed by a frequency and a waveshape indication. The operator must enter a new frequency or edit the displayed frequency and then press the → Key until the wave shape is flashing. The Operator must then press the ↑ or ↓ Key until the desired waveshape is displayed and press *ENTER*. Once the Operator presses *ENTER*, the unit exits Programming Mode and returns to Direct Entry Mode.

How to Set RF Directly

To set the RF, press *RF*. The VFD then displays "RF" followed by the current frequency. Enter the new frequency using Data Entry Keys or use Cursor Control Keys to edit the current frequency. Press *ENTER* to complete the operation.

Programming the RF List

The 1200 SUPER S has 15 storage locations for programming both Generate and Receive RF Settings. Each location is programmed by pressing *PROG, RF* and the number of the desired storage location. The VFD then displays "GEN" followed by a frequency. The operator must enter a new frequency, edit the displayed frequency or press the +/- Key to transfer the frequency in the Direct Mode Buffer. Press *ENTER*. The VFD then displays "REC" followed by a frequency. The operator must enter a new frequency, edit the displayed frequency or press the +/- Key to transfer the frequency in the Direct Mode Buffer. Press *ENTER*. The VFD then displays "FUNCT?" followed by a function that is flashing. The operator must then press the ↑ or ↓ Key until the desired function appears and press *ENTER*. The operator will then be prompted for the value of that function, if required. Once the Operator enters the function value and presses *ENTER*, the unit exits Programming Mode and returns to Direct Entry Mode.

How to Execute a Programmed RF Setting

To execute a previously programmed RF Setting, press *EXEC, RF* and the number of the storage location (1 to 15). The RF is changed as well as any other function activated by that programmed setting.

How to Set RF as a Channel

In addition to setting the RF as a frequency, the operator can also set the RF as a channel in one of several modes. The Channel modes are as follows:

- Cellular (C) - forward (FWD), reverse (REV)
- LTR[®] Trunking (T) - forward (FWD), reverse (REV)
- Cordless Phone (CP) - forward (FWD), reverse (REV)
- Cable Television (TVC) - audio (AUD), video (VID)
- Standard Television (TVS) - audio (AUD), video (VID)
- Citizens Band (CB)
- User Defined (U)

To Set RF as a channel, press **2ND FUNCT** and **CHANNEL**. The abbreviation of the current channel type is displayed, flashing. Press the ↑ or ↓ Key until the desired channel type abbreviation is displayed. Press +/- to select between forward and reverse or audio and video, as required. Press the → Key to edit the channel number or **ENTER** if current channel number is desired. Enter a new channel or edit current channel. Press **ENTER** to complete the operation.

Performing a Battery Test

The Battery Test is for testing the voltage level of the Battery. With the Unit activated, set the Modulation METER Control to **BATT**. The Modulation Meter is now a Battery Voltage Tester. The range displayed on the Modulation Meter as "BATT" displays the voltage present in the Battery.

How to Focus the CRT

Rotate the FOCUS Control cw or ccw to focus the CRT.

How to Move the Trace on the CRT

Controls are provided for moving the trace on the screen. The VERT POS Control controls the movement of the trace vertically. The HORIZ POS Control controls movement of the trace horizontally.

How to Set the CRT Intensity

Rotate the INT Control cw or ccw to set the intensity of the CRT. **DO NOT OPERATE THE CRT WITH EXCESSIVE TRACE INTENSITY.**

Displaying Readout of Meters on VFD

The VFD is capable of displaying the current digital readings of both the **FREQ ERROR** and the **Modulation Meters**. To display the digital readings for the meters, press **2ND FUNCT** and **METER**.

CONTROLS, CONNECTORS AND INDICATORS

2.1 1200 SUPER S FRONT PANEL

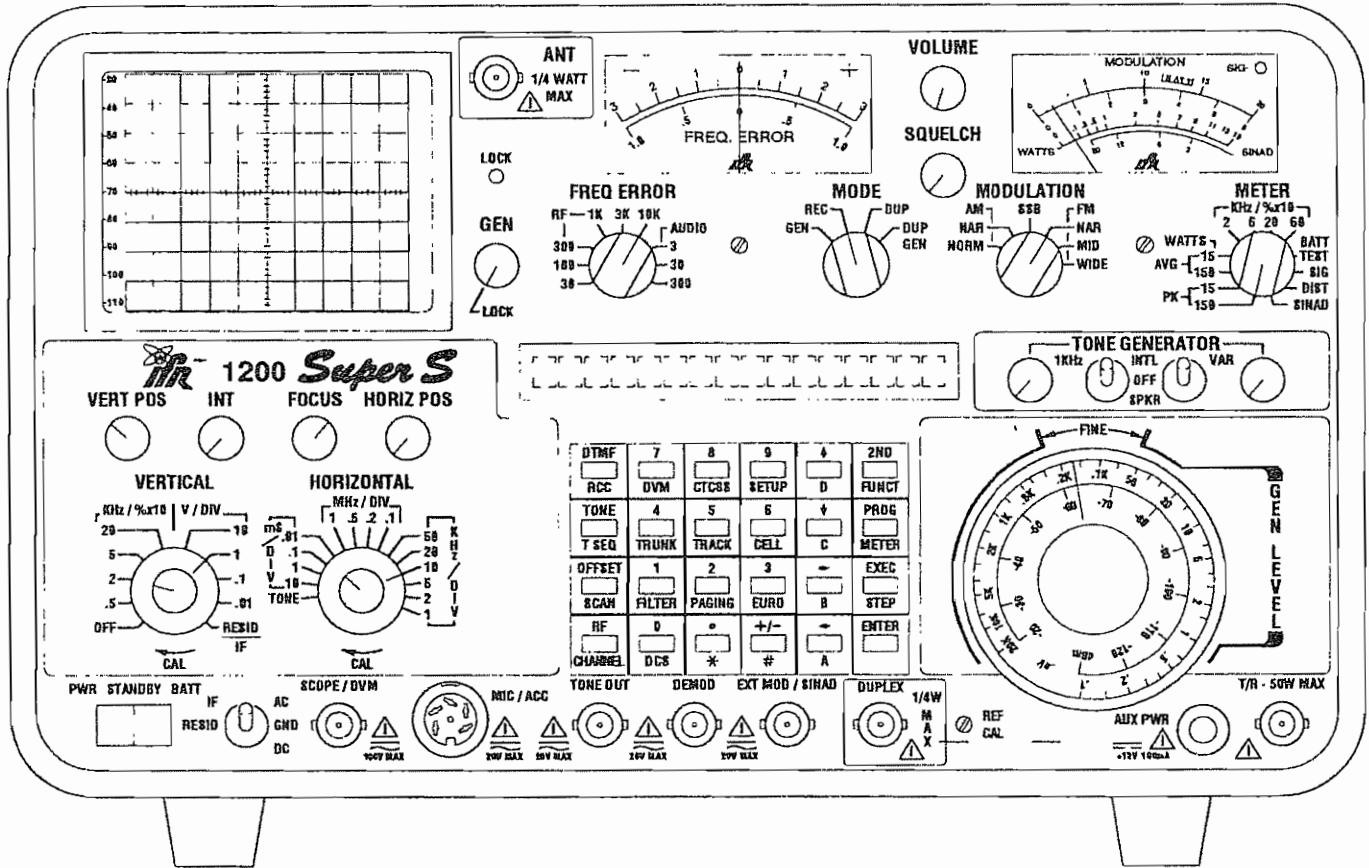

2220001

2.1.1 FRONT PANEL CONTROLS

PWR/STANDBY/BATT Switch

Applies/interrupts power as follows:

- **PWR** activates the unit using an ac or dc power source.
- **STANDBY** deactivates the unit.
- **BATT** activates the unit using the internal battery. Pressing **BATT**, again, deactivates the unit, when using internal battery.

VERTICAL Attenuator Vernier Control

Divides the vertical attenuator choice, set by the Vertical Attenuator Selector Control, by a factor of 1 to 10. In **CAL**, the factor is 1.

VERTICAL Attenuator Selector Control

Selects Vertical Attenuator Rate as follows:

- **OFF** sets Scope Display to OFF.
- **kHz/%x10** selects internal demodulated audio signal scale.
- **V/Div** selects SCOPE/DVM Connector input scale.
- **RESID IF** displays residual distortion when Modulation METER Control is set to **SINAD** or **DIST** and AC/GND/DC Switch is set to **RESID**.

HORIZONTAL Sweep Vernier Control and Spectrum Analyzer Sweep Rate

Divides the horizontal sweep rate, set by HORIZONTAL Sweep Selector Control, by a factor of 1 to 10. In *CAL*, factor is 1.

HORIZONTAL Sweep Selector Control

Selects the horizontal sweep rate of the Oscilloscope or dispersion of the Spectrum Analyzer in *MHz/DIV* or *kHz/DIV* positions. Oscilloscope Control positions are:

- *TONE* Position makes tone generator waveform output the driver for the Oscilloscope horizontal sweep.
- *ms/DIV* represents Oscilloscope sweep rate in ms per division with Horizontal Sweep Vernier Control set to *CAL*.

VERT POS Control

Controls vertical position of the CRT trace.

INT Control

Controls intensity of the CRT trace. Rotating the INT Control cw increases trace intensity. **DO NOT OPERATE CRT DISPLAY WITH EXCESSIVE TRACE INTENSITY.**

FOCUS Control

Controls focus of the CRT trace.

HORIZ POS Control

Controls the CRT trace horizontal position.

GEN/LOCK Control

Allows RF to be slewed off frequency in Generate and Duplex Generate Mode. Acts as a clarifier when receiving SSB.

FREQ ERROR Meter Range Selector Control

Selects full scale sensitivity of the FREQ ERROR Meter between RF and audio frequency ranges. Audio frequency error is referenced to Variable Tone Generator frequency.

FREQ ERROR Meter Zero Adjustment

Mechanical zero adjustment for FREQ ERROR Meter.

MODE Selector Control

- *GEN* places unit in the Generate Mode.
- *REC* places unit in the Receive Mode.
- *DUP* turns on Duplex Generator, allowing signal output at DUPLEX Output Connector and T/R Connector. Unit remains in Receive Mode. Receive capability exists even when transmitting into T/R Connector.
- *DUP GEN* places unit in generate mode with Generator on and offset by a pre-programmed amount. In this position, Receive Mode is overridden when transmitting into T/R Connector with external transmitter. DUP GEN Output is only available at T/R Connector with level controlled by RF Level Attenuator Control.

VOLUME Control

Controls volume of Speaker.

SQUELCH Control

Controls receiver squelch threshold. Audio output, freq error and modulation indicators are disabled when RF input at the ANT Connector falls below the squelch threshold. Controls the LED indicator in Mod Meter.

Modulation Meter Zero Adjustment

Adjustment screw for mechanical zeroing of MODULATION METER.

MODULATION Select Control

Selects modulation and demodulation modes of FM, AM, SSB and their associated pre- and post-detection bandwidths as follows:

Setting	Pre-Detection Bandwidth	Post-Detection Bandwidth
AM NAR	6 kHz	8 kHz
AM NORM	15 kHz	8 kHz
SSB	6 kHz	8 kHz
FM NAR	15 kHz	8 kHz
FM MID	200 kHz	8 kHz
FM WIDE	200 kHz	80 kHz

Modulation METER Control

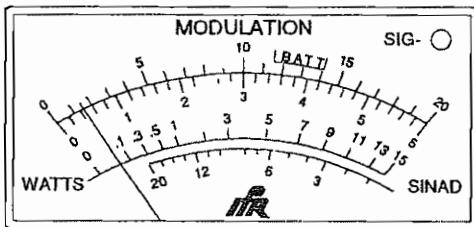

2220004

Selects input source for MODULATION METER. Selections and scales are as follows:

Setting	Meter	Scale
WATTS PK	Peak Wattmeter	WATTS
WATTS AVG	Average Wattmeter	WATTS
KHz/%x10	Modulation Meter	MODULATION (upper and lower)
BATT TEST	1200 SUPER S Internal Battery Voltage Tester	MODULATION (upper)

Setting	Meter	Scale
SIG	Relative Signal Strength Meter	NONE (relative measurement)
DIST	Distortion Meter	MODULATION (upper)
SINAD	SINAD Meter	SINAD

VAR Tone Selector Switch

Selects variable tone as follows:

- *INTL* provides signal to RF Generator for internal modulation, to the TONE OUT Connector and to the Speaker. With this setting, the active audio signal is visible on the Oscilloscope Display, when the HORIZONTAL Sweep Selector Control is in the TONE Position.
- *OFF* sets variable tone to OFF.
- *SPKR* routes the tone to the Speaker.

VAR Tone Level Control

Controls variable tone level.

1 kHz Tone Selector Switch

Selects 1 kHz fixed tone as follows:

- *INTL* provides signal to RF Generator for internal modulation, to the TONE OUT Connector and to the Speaker. With this setting, the active audio signal is visible on the Oscilloscope Display, when the HORIZONTAL Sweep Selector Control is in the TONE Position.
- *OFF* sets the tone to OFF.
- *SPKR* routes the tone to the speaker.

1 kHz Tone Level Control

Controls 1 kHz fixed tone level.

RF Level Attenuator Control

Controls RF output level of Signal Generator in 10 dB steps.

RF Level Attenuator Vernier Control

Adjusts RF Output Level of Signal Generator, as indicated on dBm/ μ V scale.

REF CAL Adjustment

For adjustment of 1200 SUPER S Master Oscillator (TCXO) or .05 PPM Oven Oscillator (Option 02).

Keyboard

Used for data entry and control of microprocessor as described in paragraph 2.3.

AC/GND/DC Switch

Sets coupling of the oscilloscope external input to IF/AC, DC or RESID/GND (Ground).

2.1.2 FRONT PANEL CONNECTORS

T/R Connector

Provides connector for Generate signal or can be used in Receive Mode to connect transmitter under test directly to unit. Inputs to the T/R Connector greater than .5 W sets the unit to Receive Mode, internally. **DO NOT APPLY MORE THAN 150 W TO THE T/R CONNECTOR. DO NOT APPLY MORE THAN 50 W CONTINUOUS. IF APPLYING GREATER THAN 50 W, USE THIS FORMULA: ONE MINUTE ON, FIVE MINUTES OFF.**

AUX POWER Connector

+12 V is available at this connector in Generate and Duplex Generate modes for the Generate Amplifier (Option 05).

DUPLEX Output Connector

In **DUPLEX HIGH** Mode, -15 dBm (± 10 dB) is present at the DUPLEX Output Connector at the selected offset frequency. In **DUPLEX LOW** Mode, an output -25 dB (± 5 dB) below the **DUPLEX HIGH** output is present at the DUPLEX Output Connector. In the Tracking Mode (Option 12), the output is -5 dBm (± 3 dB) in **TRACK HIGH** Mode, -15 dBm (± 7 dB) in **TRACK MED** Mode and -40 dBm (± 5 dB) in **TRACK LOW** Mode.

EXT MOD/SINAD Connector

Allows input of external modulation when Generate Mode is selected. Provides input for SINAD or Distortion measurement when Modulation METER Control is set to **SINAD** or **DIST**.

DEMODO Connector

Provides output of the demodulated received or generated audio signal.

tone OUT Connector

Provides output of active tones when VAR Tone Selector Switch or 1 kHz Tone Selector Switch is set to **INTL**.

MIC/ACC Connector

Allows use of external microphone. With the microphone connected, pressing the MIC Key automatically switches the unit internally to Generate Mode if the MODE Selector Control is set to **REC** or **DUP**.

SCOPE/DVM Connector

Provides input to Oscilloscope or Digital Voltmeter. **DO NOT APPLY >100 VDC, >100 VRMS OR A COMBINATION GREATER THAN 50 VDC AND 50 VRMS TO THE SCOPE/DVM CONNECTOR.**

ANT Connector

Provides external Antenna Input.
**MAXIMUM INPUT TO ANT
CONNECTOR MUST NEVER BE
GREATER THAN 0.25 W.**

FREQ ERROR Meter

Provides a display of the difference between received signal frequency and selected receive frequency when set to an RF setting. Provides a display of difference between the DEMOD audio signal frequency and selected variable tone generator frequency when set to an AUDIO setting.

MODULATION METER

Provides a visual display of modulation levels, RF power levels (peak and average), relative signal strength, battery test voltage, distortion and SINAD as selected by the Modulation METER Control.

2.1.2 FRONT PANEL INDICATORS

CRT

Display screen for Oscilloscope and Spectrum Analyzer function.

LOCK Lamp

Indicates in the following manner:

Steady Light — RF frequencies are phase locked.

Blinking Light — GEN/LOCK Control is out of LOCK position or unit is experiencing a malfunction.

VFD (Vacuum Fluorescent Display)

Provides display of Keyboard entries as described in paragraph 3-3.

SIG Indicator Lamp

When illuminated, indicates input level at ANT Connector is above squelch threshold of receiver.

2.2 1200 SUPER S REAR PANEL

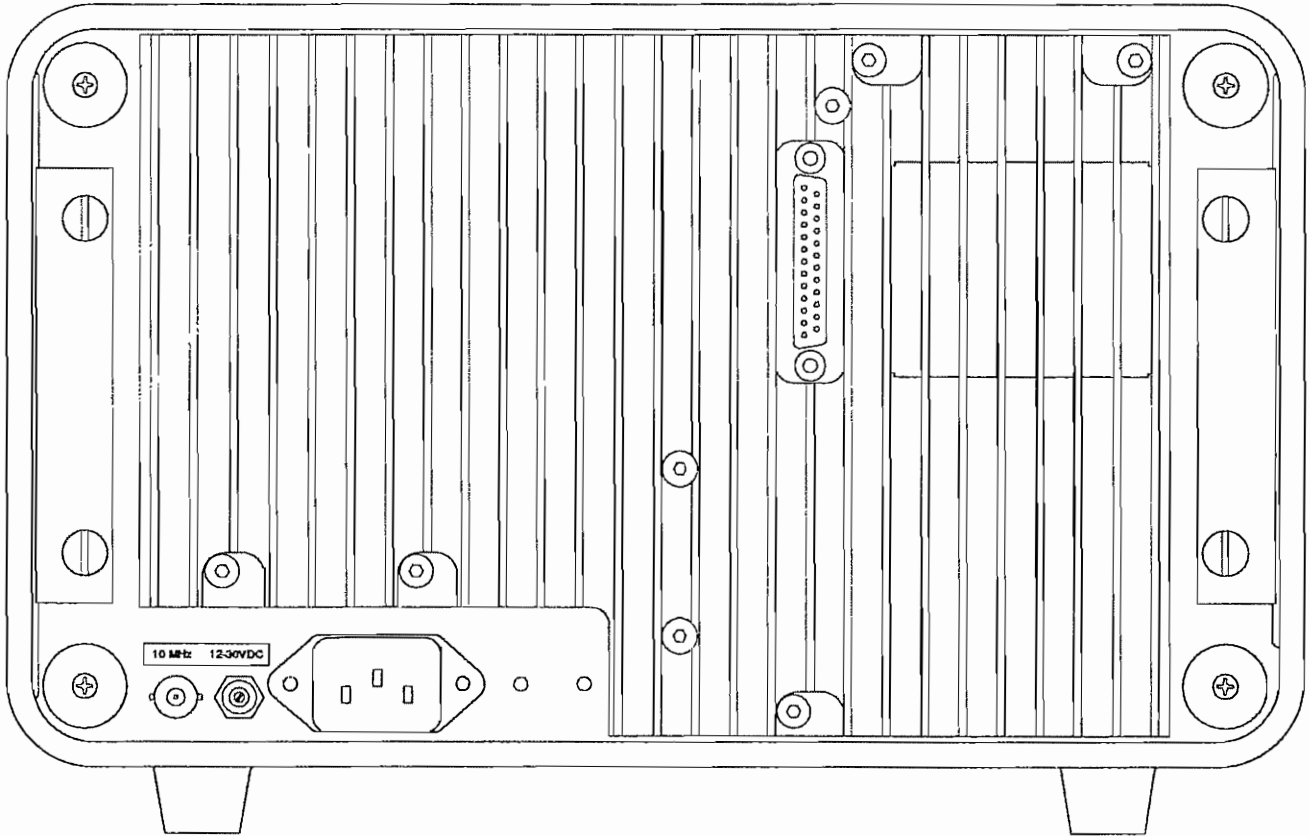

2220002

RS-232/GPIB (Option 13) Connector

Connector for remote control. Refer to Section 5 for additional information.

AC Power Input Connector

Input for AC power at 120/240 VAC at 50 to 400 Hz.

DC Power Input Connector

Input for DC Power at 12 to 30 Vdc.

External Reference Connector

Allows monitoring of 10 MHz internal reference or the use of an external 10 MHz reference. The input and output are automatically switched. Automatic switching to external source occurs when a signal of +5 dBm or greater is applied at the External Reference Connector. **DO NOT EXCEED 0.25 W INPUT IN THE EXTERNAL REFERENCE CONNECTOR.**

2.3 KEYBOARD DESCRIPTION

DTMF []	7 []	8 []	9 []	↓ []	2ND []
RCC	DVM	CTCSS	SETUP	D	FUNCT
TONE []	4 []	5 []	6 []	↑ []	PROG []
T SEQ	TRUNK	TRACK	CELL	C	METER
OFFSET []	1 []	2 []	3 []	→ []	EXEC []
SCAN	FILTER	PAGING	EURD	B	STEP
RF []	0 []	* []	+/- []	← []	ENTER []
CHANNEL	DCS	*	#	A	

2.3.1 FUNCTION KEYS

These keys determine the active function. Most keys have dual functions, selected as 1st or 2nd order functions by the operator. 2nd order functions are accessed by pressing *2ND FUNCT* and the desired key.

1st ORDER FUNCTIONS (Black Lettering)

DTMF

Accesses DTMF encode/decode functions.

TONE

Accesses variable tone generator functions.

OFFSET

Accesses Duplex Offset functions.

RF

Used to set Generate/Receive Frequency.

2nd ORDER FUNCTIONS (Blue Lettering)

RCC

Accesses MTS, IMTS, 10 PS Variable Pulsed Audio and 20 PS Variable Pulsed Audio.

TSEQ

Accesses Tone Sequence Function.

SCAN

Accesses Scan Function.

CHANNEL

Accesses Channel Functions.

DVM

Accesses Digital Voltmeter Function.

TRUNK

Accesses CLEARCHANNEL LTR[®] Testing Function (Option 14).

FILTER

Accesses Audio Filter Function.

DCS

Accesses DCS encode/decode function.

CTCSS

Accesses CTCSS decode function.

TRACK

Accesses Tracking Generator Function (Option 12) and Duplex Output Level.

PAGING

Accesses 5/6 Tone and 2 Tone Functions.

SETUP

Accesses Setup Function for VFD Intensity (INTENSITY), Serial Communication Data (COMM), DTMF parameters (DTMF), Tone Sequence parameters (TSEQ), European Tone Signalling parameters (EURO), POCSAG parameters (POCSAG), Scan Function Parameters (SCAN), Harmonic Check Function Parameters (HARMONIC CHECK) and Deviation Check Parameters (DEVIATION CHECK).

CELL

Accesses Cellular Testing Functions (Option 15).

EURO

Accesses European Signaling Format Testing Functions (Option 11). Signaling formats include: CCIR, EEA, CCIRH, CCIRH4, EIA, ZVEIA, ZVEI2, ZVEI3, NATEL, EURO, 5/6 TONE and 2 Tone

METER

Displays FREQ ERROR and Modulation Meter digital readings on VFD. Flashing Display indicates an overrange condition.

STEP

Accesses Step Function.

2.3.2 INSTRUCTION KEYS

These keys instruct the processor to perform a specific operation or permit the execution of a key entry. Specific key functions are:

2ND FUNCT

Accesses 2nd Order Functions on the Keyboard which are printed in blue.

PROG

Places Unit in programming mode for entering parameters for programmable functions and allows entry of frequencies into RF, TONE, and OFFSET storage locations. Keyboard entries are immediately displayed on the VFD but are not executed by the processor.

EXEC

Executes function specified by key pressed after **EXEC** is pressed. Parameters for executed function must be defined prior to execution.

ENTER

Ends key-in sequence. Press **ENTER** twice to exit from execute mode and return to the direct mode.

2.3.3 CURSOR CONTROL KEYS

The ← and → Keys move the cursor laterally within the VFD viewing area for purposes of changing data values. To change a data value, the cursor must be positioned directly on the desired character position prior to making a value change.

The ↑ and ↓ Keys are used to increase or decrease any value position in the cursor and the value of the character to the left of the cursor position as the cursor character passes "0." Also, the ↑ and ↓ Keys are used to slew through stored memory fields.

2.3.4 DATA ENTRY KEYS

These keys include numeric keys 0 through 9 and special symbol keys as follows:

• Key

Used as a decimal character to justify Tone, Offset and RF fields.

+/- Key

Used to change the sign of Offset, DCS and DVM functions. Also used to toggle between selections in some functions.

A, B, C, D, * and # Keys

Used in conjunction with DTMF or RCC functions or for program preset position selections 10 through 15. Accessed using **2ND FUNCT**.

OPERATION

3.1 GENERATE MODE OPERATION

To access the Generate Mode of the 1200 SUPER S, set the MODE Selector Control to *GEN*.

In Generate Mode, the 1200 SUPER S is an RF Signal Generator with the ability to monitor a Receiver Under Test using internal testing abilities such as an Oscilloscope, Distortion Meter, SINAD Meter and DVM. The 1200 SUPER S has two internal modulation sources, a 1 kHz tone generator and a variable tone generator. Additionally, external modulation or a microphone can be used as modulation. These modulation sources can be used to modulate the RF Signal as FM or AM modulation types.

Generate Mode testing that can be performed by the 1200 SUPER S includes:

- Receiver Sensitivity

- Receiver Audio Distortion
- Receiver Audio Output Level
- Receiver IF Bandwidth
- Modulation Acceptance

The signal being Generated by the 1200 SUPER S is available only at the T/R Connector. The EXT MOD/SINAD Connector is used for applying external modulation or for applying the test audio from the Receiver Under Test for SINAD or Distortion Measurements. The TONE OUT Connector provides an output of the active internal Tone Generators. The MIC/ACC Connector allows connection of a Microphone for modulating the RF Signal with MIC Modulation.

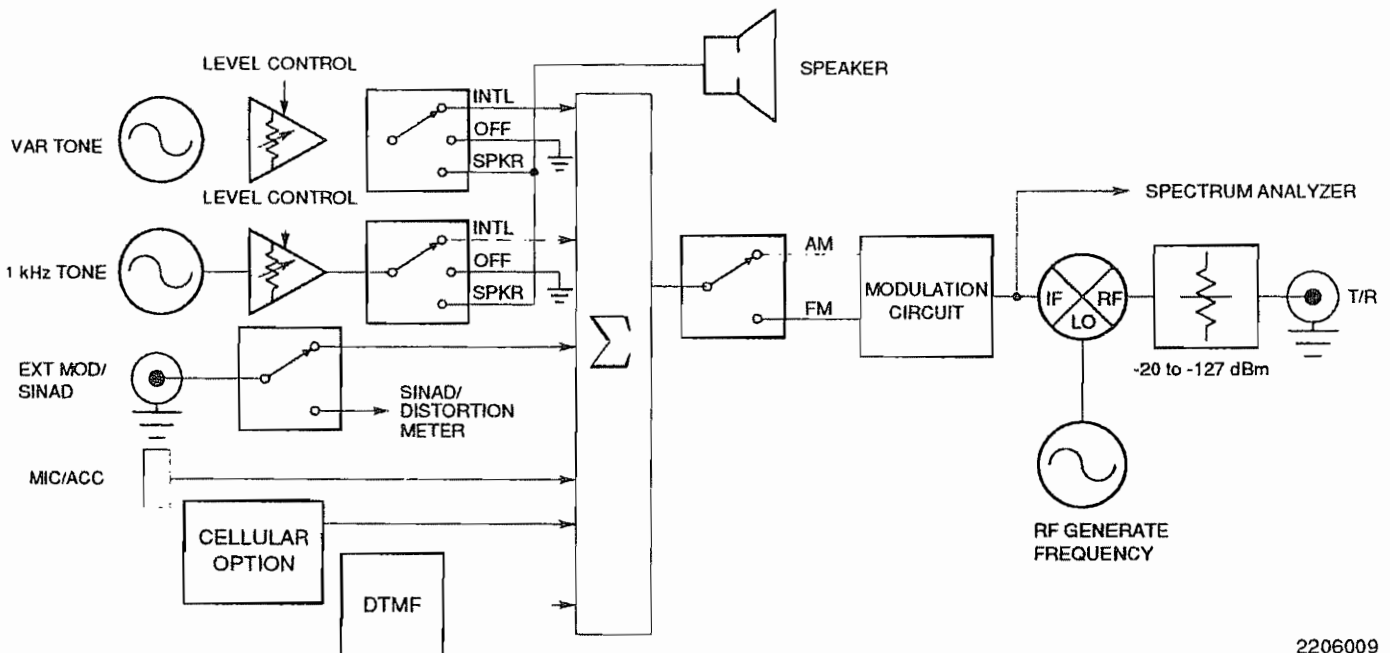

Generate Mode Block Diagram

2206009

How to Set the RF Output Level

The RF output level is adjusted by two controls. The RF Level Attenuator Control provides the coarse adjustment in 10 dB steps and the RF Level Attenuator Vernier Control provides the fine adjustment. To set the RF output level, adjust the RF Level Attenuator Control to place the desired output band between the lines indicating the range of fine adjustment located on the Front Panel. Adjust the RF Level Attenuator Vernier control to the desired level as indicated on the dBm/ μ V scale.

How to Set the Modulation Type

The modulation types available in Generate Mode are AM and FM. To set AM as the modulation type, set the MODULATION Select Control to *AM NAR* or *AM NORM*. To set FM as the modulation type, set the MODULATION Select Control to *FM NAR*, *FM MID* or *FM WIDE*.

How to Set the Modulation Level

Each of the two Tone Generators that are used as modulation source have a level control for setting the level of the modulation source. To determine the modulation level, set the Modulation Meter to one of the *KHz/%x10* ranges. The current output level is displayed by the MODULATION METER deflection. If the modulation source is the 1 kHz Tone Generator, adjust the 1 kHz Tone Level Control until the desired modulation level is displayed on the MODULATION METER. If the Variable Tone Generator is the modulation source, adjust the VAR Tone Level Control until the desired modulation level is displayed on the MODULATION METER.

How to Measure the SINAD of an FM Receiver

To test the SINAD of the Receiver Under Test, route the audio output of the Receiver to the EXT MOD/SINAD Connector. Set the Modulation METER Control to *SINAD*. To modulate, set the 1 kHz Fixed Tone Generator to 3.3 kHz deviation and generate an RF signal to the Receiver Under Test. The MODULATION METER displays the SINAD Measurement of the Receiver Demodulated Audio. Reduce the 1200 Super S RF output level to the desired SINAD reading and read the attenuator RF level.

How to Measure the Distortion of a Receiver

To test the Distortion of the Receiver Under Test Audio, route the audio output of the Receiver audio to the EXT MOD/SINAD Connector. Set the Modulation METER Control to *DIST*. Using the 1 kHz Tone Generator as the Modulation signal, transmit an RF signal to the Receiver Under Test. The MODULATION METER displays the Distortion Measurement of the Receiver Demodulated Audio.

How to Generate an RF Signal with MIC Modulation

Microphone Modulation can be used to modulate an RF Signal by passing the Microphone Modulation to the 1200 SUPER S through the MIC/ACC Connector.

To generate an RF Signal with Microphone Modulation, configure the 1200 SUPER S for the desired frequency and level of the RF Signal. Select a Modulation Type, AM or FM, using the MODULATION Select Control. Connect the Microphone to the MIC/ACC Connector. Press the MIC Key to activate the Microphone. The audio signal passed through the Microphone to the 1200 SUPER S is used to modulate the RF Signal.

How to Generate an RF Signal with External Modulation

External Modulation can be used to modulate an RF Signal by passing the External Modulation to the 1200 SUPER S through the EXT MOD/SINAD Connector. The resulting modulation level is dependent on the input level of the external modulation.

To generate an RF Signal with External Modulation, configure the 1200 SUPER S for the desired frequency and level of the RF Signal. Select a Modulation Type, AM or FM, using the MODULATION Select Control. Set the Modulation METER Control to a $KHz/\%x10$ setting that is sufficient to measure the output modulation. Input the desired modulation signal at the EXT MOD/SINAD Connector. Increase or decrease the modulation source output level, as required, to set the RF Signal Modulation Level to the desired setting.

How to Program the DCS Code for Transmission

THE 1200 SUPER S has one storage location for a DCS Code. To program, press *PROG*, *2ND FUNCT* and *DCS*. "DCS" appears with the current DCS Code and Polarity. Enter a new DCS Code or edit current code. Press +/- to switch polarity as required. Press *ENTER* to complete the operation.

How to Generate an RF Signal with DCS Code as Modulation

Once the 1200 SUPER S has been set up to transmit an RF Signal and the desired Modulation Type has been selected, a DCS Code can be transmitted as a modulation signal. To generate the DCS Code, press *EXEC*, *2ND FUNCT* and *DCS*. The DCS Code is automatically transmitted. Press *ENTER* twice to complete the operation. Set the VAR Tone Selector Switch to *INTL*. Adjust the VAR Tone Level Control for the desired modulation level. Press *TONE* to stop DCS Code.

How to Decode Baseband DTMF Coded Signals in Generate Mode

To configure the 1200 SUPER S to decode Baseband DTMF Coded Signals, press *2ND FUNCT*, *SETUP* and ↑ Keys until "SET DTMF" appears on the VFD. Press *ENTER*. Press ↑ Key until "ENC IN GEN" (Encode in Generate Mode) or "DEC IN GEN" (Decode in Generate Mode) appears. Press +/-, as required, to display "DEC IN GEN." Press *ENTER* to complete configuring test set. Press *DTMF* to set the 1200 SUPER S for decoding DTMF. Attach the signal to the EXT MOD/SINAD Connector. The decoded DTMF is displayed on the VFD.

How to Setup the DTMF Generator

To setup the DTMF Generator, press *2ND FUNCT*, *SETUP* and ↑ Keys until "SET DTMF" appears on the VFD. Press *ENTER*. Press ↑ Key until "DTMF SPACE" appears followed by the current DTMF Space time. Enter a new DTMF Space time or edit the current time. Once the DTMF Space time is edited, press ↑ Key until "DTMF MARK" appears followed by the current DTMF Mark time. Enter a new DTMF Mark time or edit the current time. Once the DTMF Mark time is edited, press ↑ Key until "ENC IN GEN" (Encode in Generate Mode) or "DEC IN GEN" (Decode in Generate Mode) appears. Press +/-, as required, to display "ENC IN GEN." Press ↑ Key until "DTMF ONE-SHOT" or "DTMF CONTINUOUS" appears. "DTMF ONE-SHOT" means the DTMF Generator is set to generate the DTMF character string once only. "DTMF CONTINUOUS" means the DTMF Generator is set to generate the DTMF character string repeatedly until another Function Key is pressed. To toggle between the modes press +/- . Press *ENTER* to complete the operation. To set DTMF Operation to Systems Default, press *2ND FUNCT*, *SETUP* and ↑ Keys until "SET DTMF" appears. Press *ENTER*. Press the ↑ Key until "DTMF DEFAULT" appears with "DEFAULT" flashing. Press *ENTER* to restore system defaults.

How to Program DTMF/RCC Codes for Execution

DTMF/RCC Codes of 16 characters or less are stored in 15 locations. To program a DTMF/RCC Code, Press **PROG**, **DTMF** and the Data Entry Key for the desired storage location. Once "DTMF" appears on the VFD, enter a DTMF/RCC Code of 16 characters or less. Press **ENTER** to complete the Operation.

Pressing **PROG**, **2ND FUNCT**, **RCC** and the Data Entry Key for the desired storage location is an alternative method to program the 15 storage locations. Once "RCC" appears on the VFD, enter a DTMF/RCC Code of 16 characters or less. Press **ENTER** to complete the Operation.

How to Generate an RF Signal with DTMF Modulation

The 1200 SUPER S modulates an RF Signal by simulating a DTMF Keyboard or with preprogrammed DTMF Character Strings.

Once the 1200 SUPER S is configured to generate an RF Signal, pressing **DTMF** activates the Data Entry Keys as a DTMF Keyboard. The special characters A, B, C, D, # and * are activated by pressing **2ND FUNCT** and the desired key. The RF Signal is modulated by the DTMF Code specified by the pressed key until the key is released. Once the operation is completed, press **ENTER** to exit the function.

A preprogrammed DTMF Character String is used as modulation. To activate the DTMF Character String, press **EXEC**, **DTMF** and the number that designates the storage location of the desired DTMF Character String. The DTMF CODE is generated continuously or as a single transmission as was previously configured. Once activated, a continuous DTMF transmission continues until another function is accessed.

How to Generate an RF Signal with RCC Format as Modulation

Once the 1200 SUPER S has been set up to transmit an RF Signal and the desired Modulation Type has been selected, an RCC Code can be transmitted as a modulation signal. To generate the RCC Code, press **EXEC**, **2ND FUNCT** and **RCC**. "EXECUTE" appears on the VFD, followed by the current RCC type. Select the desired RCC Type by pressing the ↑ or ↓ Key until the desired selection is displayed. RCC Types available include MTS, IMTS, 10 PS and 20 PS. Once the desired RCC Type is displayed, enter the storage location using the Data Entry Keys. The RCC Code is then transmitted. Press **ENTER** twice to exit the Execute Mode of Operation. Set the VAR Tone Selector Switch to **INTL**. Adjust the VAR Tone Level Control for the desired modulation level.

How to Generate an RF Signal with 5/6 Tone as Modulation

In order to generate 5/6 Tone, it must first be programmed. To Program 5/6 Tone, Press **PROG**, **2ND FUNCT** and **PAGING**. "PAGER" appears followed by the current Pager Format. Press the ↑ or ↓ Key until "5/6 TONE" is displayed. Press **ENTER**. "5/6" appears with the preamble digit flashing. Enter a new preamble digit or edit the current digit. If a new digit is entered, the cursor automatically advances to the first digit of the signalling sequence, otherwise press the → Key to advance the cursor to the signalling sequence. Enter a new sequence or edit the current sequence. The sequence is up to 8 digits long. Press **ENTER** to complete the operation.

Once the 5/6 Tone sequence has been programmed, execute the sequence by pressing **EXEC**, **2ND FUNCT** and **PAGING**. The sequence is then transmitted. Press **ENTER** twice to complete the operation. Set the VAR Tone Selector Switch to **INTL**. Adjust the VAR Tone Level Control for the desired modulation level.

How to Generate an RF Signal with Two Tone as Modulation

In order to generate Two Tone, it must first be programmed. To Program Two Tone, Press **PROG**, **2ND FUNCT** and **PAGING**. "PAGER" appears followed by the current Pager Format. Press the ↑ or ↓ Key until "2-TONE" is displayed on the VFD. Press **ENTER**. "2T" appears with the variable flashing. Press the ↑ or ↓ Key until "#1" is displayed. Press the → Key to access the Tone Frequency Field. Enter a new frequency for the first tone or edit the current frequency. Press the → Key to access the Tone Duration Field. Enter a new duration in ms for the first tone duration or edit the current duration. Press **ENTER**. The VFD displays "2T GAP" followed by the pause time between the two tones in ms. Enter a new pause time or edit the current pause time. Press **ENTER**. The VFD displays "2T #2" with the cursor on the second tone frequency. Enter a new frequency or edit the current frequency. Press the → Key to access the Tone Duration Field. Enter a new duration in ms for the second tone duration or edit the current duration. Press **ENTER** to complete the edit. Set the VAR Tone Selector Switch to **INTL**. Adjust the VAR Tone Level Control for the desired modulation level.

Once the Two Tone sequence has been programmed, execute the sequence by pressing **EXEC**, **2ND FUNCT** and **PAGING**. The sequence is then transmitted. Press **ENTER** twice to complete the operation.

How to Decode CTCSS Code in Generate Mode

To decode CTCSS Code, press **2ND FUNCT** and **CTCSS**. "CTCSS" appears followed by three dashes. Connect the baseband CTCSS Code signal to EXT MOD/SINAD Connector. The three dashes are replaced by the decoded CTCSS Code Frequency.

How to Generate an RF Signal with CTCSS Code as Modulation

Once the desired RF and FM Modulation has been selected, a CTCSS Code is selected as modulation. To program CTCSS Code, press **2ND FUNCT** and **CTCSS**. "CTCSS" appears followed by three dashes. Press the +/- Key until "CTCSS" is displayed followed by the current code frequency. Press the ↑ or ↓ Key to select the desired frequency. Press **ENTER**. The "CTCSS" is displayed followed by the selected code frequency and "ON." Set the VAR Tone Selector Switch to **INTL**. Adjust the VAR Tone Level Control for the desired modulation level. Press **2ND FUNCT**, **CTCSS** and • to turn off the CTCSS Generator. If the European Signaling Option (Option 11) is installed, press the → or ← Key to access the deviation field. Press the ↑ or ↓ Key until the desired deviation level is displayed. If the European Signaling Option is installed, the VAR Tone Generator is not required.

How to Program and Execute the Channel Scan Function in Generate

The Channel SCAN Function switches the RF for the Generate Mode at specific time intervals. The Channel SCAN Function uses the RF of the specified Channel Type for the SCAN Frequencies. The program scans sequentially through all channels of the specified Channel Type unless the Channel Type is User. If User is the desired Channel Type, the range of channels is selected. Upon reaching the final channel, the scan sequence automatically repeats, beginning at the first channel.

To program the Channel SCAN Function, press **2ND FUNCT**, **SETUP** and \uparrow or \downarrow Key until "SET SCAN" is displayed. Press **ENTER**. Press the \uparrow or \downarrow Key until the desired Channel Type is displayed. Selections include:

CELLULAR	TRUNKING	PHONE
TV CBL	TV STD	CB
USER		

Press **ENTER**. to complete selection. To select whether Forward, Reverse, Video or Audio channels are scanned, press **2ND FUNCT** and **CHANNEL** and select desired Channel Type.

To enter to the time interval for the Scan Function, press the **PROG**, **2ND FUNCT** and **SCAN** Keys. If User is the defined Channel Type, use the Keypad to enter the SCAN Start Channel (SCAN XX) and Stop Channel (THRU XX). Press the **ENTER** Key. For all other Channel Types press **ENTER** to bypass this field. Use the Keypad to enter the Resume Time. Press **ENTER**.

To execute Channel SCAN Function, press **EXEC**, **2ND FUNCT** and **SCAN**. The 1200 SUPER S automatically scans until another function is executed. If the \uparrow or \downarrow Key is pressed while Scanning Function is active, the Function will restart at the first location.

How to Program and Execute the Standard Scan Function in Generate

The Standard SCAN Function switches the RF for the Generate Mode at specific time intervals. The Standard SCAN Function uses RF memory locations 0 thru 15 (where 0 is the current frequency) for the SCAN Frequencies. A range or all locations are used in the Standard SCAN Function. The program scans sequentially through the RF memory locations beginning with the start memory location entry and ending with the stop memory location. Upon reaching the programmed stop memory location, the scan sequence automatically repeats, beginning at the programmed start memory location.

To program the Standard SCAN Function, press **2ND FUNCT**, **SETUP** and \uparrow or \downarrow Key until "SET SCAN" is displayed. Press **ENTER**. Press the \uparrow or \downarrow Key until "SCAN STANDARD" is displayed. Press **ENTER**. Program RF memory location 01 thru 15 as desired. Press the **PROG**, **2ND FUNCT** and **SCAN** Keys. Use the Keypad to enter the SCAN Start Memory Location (SCAN XX) and Stop Memory Location (THRU XX). Press the **ENTER** Key. Use the Keypad to enter the Resume Time. Press **ENTER**. The 1200 SUPER S executes each programmed RF Memory location as listed for the SCAN Function.

To execute Standard SCAN Function, press **EXEC**, **2ND FUNCT** and **SCAN**. The 1200 SUPER S automatically scans through desired frequencies until another function is executed. If the \uparrow or \downarrow Key is pressed while Scanning Function is active, the Function will restart at the first location.

3.2 RECEIVE MODE OPERATION

To access the Receive Mode of the 1200 SUPER S, set the MODE Selector Control to *REC*.

In Receive Mode, the 1200 SUPER S is an RF Receiver with the ability to monitor a Transmitter Under Test using internal testing abilities such as an Oscilloscope, Spectrum Analyzer, Frequency Error Meter, Wattmeter, Distortion Meter, SINAD Meter and DVM. The 1200 SUPER S is capable of demodulating AM, FM and SSB signals with varying pre- and post-detection filters.

Receive Mode testing that can be performed by the 1200 SUPER S includes:

- Transmitter Modulation Level
- Transmitter Power

- Transmitter Frequency Error
- Receiver IF Bandwidth
- Modulation Acceptance

The signal is received by the 1200 SUPER S at the T/R Connector or the ANT Connector. The T/R Connector is used for direct connection to the transmitter and the ANT Connector is used for off-the-air measurements. The DEMOD Connector provides an output of the demodulated signal during receive operation. The EXT MOD/SINAD Connector is used for SINAD or Distortion Measurements.

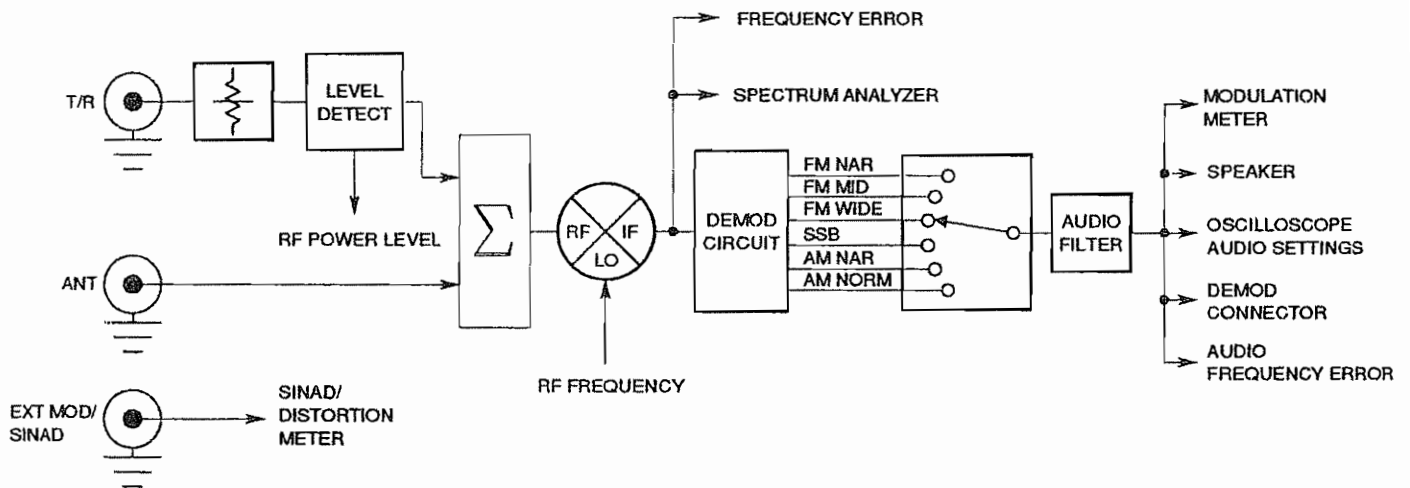

2206010

Receive Mode Block Diagram

How to Adjust Squelch

The SQUELCH Control adjusts the threshold level of the squelch for signals received at the ANT Connector. Turning the control cw increases the amount of signal required before the 1200 SUPER S breaks squelch. When the SIG Indicator Lamp lights, the input to the unit is sufficient to break squelch. When level drops below the squelch threshold, the SIG Indicator Lamp is no longer lit.

How to Set Modulation Type

The demodulation types available in Receive Mode are AM, FM and SSB. To set AM as the modulation type, set the MODULATION Select Control to *AM NAR* or *AM NORM*. To set FM as the modulation type, set the MODULATION Select Control to *FM NAR*, *FM MID* or *FM WIDE*. To set SSB as a Modulation Type set the MODULATION Select Control to *SSB*. Recommended uses for each setting are as follows:

Setting	Recommended Use
AM NAR	Off-the Air AM Monitoring
AM NORM	Direct Connection AM Monitoring
SSB	Receiving SSB
FM NAR	Land mobile radios at low to moderate modulation rates
FM MID	Commercial FM transmitters or wide deviation FM transmitters at low to moderate modulation rates
FM WIDE	Commercial FM transmitters or wide-deviation FM transmitters at high modulation rates

How to Measure Distortion of a Transmitter

To test the Distortion of the Transmitter Under Test, route the DEMOD Connector to the EXT MOD/SINAD Connector using a coaxial cable. Set the Modulation METER Control to *DIST*. Use a 1 kHz tone to modulate the transmitter. Connect the Transmitter Output to the T/R Connector. Set the RF of the 1200 SUPER S to the frequency of the Transmitter. Transmit an RF signal to the 1200 SUPER S. The MODULATION METER displays the Distortion Measurement of the Transmitter demodulated audio.

How to Decode DTMF Code

Once the 1200 SUPER S is configured to receive the RF Signal from a Transmitter, the test set is configured to decode DTMF by pressing *DTMF*. Transmit the DTMF signal to the 1200 SUPER S. The Decoded DTMF Code is displayed on the VFD.

How to Decode DCS Code

Once the 1200 SUPER S is configured to receive the RF Signal from a Transmitter, the test set is configured to decode DCS by pressing *2ND FUNCT* and *DCS*. Transmit the DCS Coded signal to the 1200 SUPER S. The Decoded DCS Code is displayed on the VFD.

How to Decode CTCSS Code

Once the 1200 SUPER S is configured to receive the RF Signal from a Transmitter, the test set is configured to decode CTCSS Code by pressing *2ND FUNCT* and *CTCSS*. Transmit the CTCSS Coded signal to the 1200 SUPER S. The Decoded CTCSS Code is displayed on the VFD.

How to Measure Peak Power

With the Transmitter connected to the T/R Connector, set the METER Control to *WATTS PK 15* or *WATTS PK 150*. The *WATTS PK 15* sets POWER METER full deflection to 15 W. The *WATTS PK 150* sets POWER METER full deflection to 150 W. Activate the Transmitter and transmit the signal. The Peak Power Measurement is displayed on the MODULATION METER WATTS Scale. **DO NOT APPLY MORE THAN 150 W PEAK OR MORE THAN 50 W CONTINUOUS TO THE T/R CONNECTOR.**

How to Measure Average Power

With the Transmitter connected to the T/R Connector, set the Modulation METER Control to *WATTS AVG 15* or *WATTS AVG 150*. The *WATTS AVG 15* sets POWER METER full deflection to 15 W. The *WATTS AVG 150* sets POWER METER full deflection to 150 W. Activate the Transmitter and transmit the signal. The Average Power Measurement is displayed on the MODULATION METER WATTS Scale. **DO NOT APPLY MORE THAN 150 W PEAK OR MORE THAN 50 W CONTINUOUS TO THE T/R CONNECTOR.**

How to Measure RF Error

Once the 1200 SUPER S is configured to receive the RF Signal from a Transmitter, the test set is configured to measure Frequency Error by setting the *FREQ ERROR* Meter Range Selector Control to an RF Setting. To measure the Frequency Error, activate the transmitter and observe the deflection of the *FREQ ERROR* Meter. The Frequency Error measured is the difference between the frequency of the Transmitted signal and the 1200 SUPER S RF Setting.

How to Measure Relative Signal Strength

The Relative Signal Strength measurement provides a relative measurement of a signal as compared to a reference signal. Two measurements must be made: the reference measurement and the unit-under-test measurement. The results are unitless and are meant to be compared. Perform each of the measurements as follows:

Configure the 1200 SUPER S to receive the transmitted signal. With the transmitter connected to the T/R Connector, set the Modulation METER Control to *SIG*. Transmit the signal. The Signal Strength is displayed on the MODULATION METER. **DO NOT APPLY MORE THAN .25 W TO THE ANT CONNECTOR.**

How to Set Audio Filters

To access the 1200 SUPER S Audio Filters, press *2ND FUNCT* and *FILTER* on the Keypad. The Audio Filter is toggled ON or OFF using the +/- Key. Press the *ENTER* Key. PRESET or MANUAL Mode is selected using the ← or → Keys.

PRESET Mode allows the selection of the *SPEECH (BAND PASS)* Filter Type. All other parameters are programmed with default values.

PRESET FILTER
Speech (Band Pass)
DEMOD AUDIO Thru Filter METER Thru Filter CLOCK SPEED = 100 kHz QUALITY = 1.35 CENTER Freq. = 1336.9

MANUAL Mode allows the selection of four different filter types. Select BAND PASS, HIGH PASS, LOW PASS or NOTCH by toggling the +/- Key. Press the ENTER Key. The CENTER, QUALITY and DEMOD ROUTE parameters are selected using the +/- Key. Parameters are programmed using the ↑ and ↓ Keys with these filter specifications:

MANUAL FILTERS

Select From:

BAND PASS, HIGH PASS, LOW PASS, NOTCH

Select CENTER Frequency, QUALITY and DEMOD ROUTE for each Filter Type.

DEMOD ROUTE			+
Selection	Demod Audio	Meter	Clock Speed
OFF	Bypassed	Bypassed	1 MHz
MTR1	Bypassed	Thru Filter	1 MHz
SCP1	Thru Filter	Bypassed	1 MHz
M/S1	Thru Filter	Thru Filter	1 MHz
MTR5	Bypassed	Thru Filter	100 kHz
SCP5	Thru Filter	Bypassed	100 kHz
M/S5	Thru Filter	Thru Filter	100 kHz

QUALITY			
0.57 = loose tolerance, 85.00 = tight tolerance.			
Select From:			
0.57	1.35	5.00	15.50
0.65	1.65	5.80	17.50
0.71	1.95	7.20	20.00
0.79	2.20	8.70	24.00
0.87	2.50	10.00	30.00
0.95	3.00	11.50	35.00
1.05	3.50	12.00	55.00
1.20	4.25	13.50	85.00

CENTER Frequency (Hz)			
Demod Route Clock Speed: 1 MHz			
Select From:			
5000.0	7153.1	10224.9	14619.9
5227.4	7479.4	10695.2	15290.5
5467.5	7818.6	11185.7	16000.0
5717.6	8176.6	11695.9	16722.4
5980.9	8554.3	12224.9	17482.5
6253.9	8944.5	12787.7	18248.2
6540.2	9354.5	13369.0	19120.5
6839.9	9775.2	13986.0	20000.0

CENTER Frequency (Hz)			
Demod Route Clock Speed: 100 kHz			
Select From:			
500.0	715.3	1022.4	1461.9
522.7	747.9	1069.5	1529.0
546.7	781.8	1118.5	1600.0
571.7	817.6	1169.5	1672.2
598.0	855.4	1222.4	1748.2
625.3	894.4	1278.7	1824.8
654.0	935.4	1336.9	1912.0
683.9	977.5	1398.6	2000.0

How to Program and Execute the Channel Scan Function in Generate

The Channel SCAN Function switches the RF for the Receive Mode at specific time intervals. The Channel SCAN Function uses the RF of the specified Channel Type for the SCAN Frequencies. The program scans sequentially through all channels of the specified Channel Type unless the Channel Type is User. If User is the desired Channel Type, the range of channels is selected. Upon reaching the final channel, the scan sequence automatically repeats, beginning at the first channel.

To program the Channel SCAN Function, press **2ND FUNCT**, **SETUP** and **↑** or **↓** Key until "SET SCAN" is displayed. Press **ENTER**. Press the **↑** or **↓** Key until the desired Channel Type is displayed. Selections include:

CELLULAR	TRUNKING	PHONB
TV CBL	TV STD	CB
USER		

Press **ENTER**. to complete selection. To select whether Forward , Reverse, Video or Audio channels are scanned, press **2ND FUNCT** and **CHANNEL** and select desired Channel Type.

To enter to the time interval for the Scan Function, press the **PROG**, **2ND FUNCT** and **SCAN** Keys. If User is the defined Channel Type, use the Keypad to enter the SCAN Start Channel (SCAN XX) and Stop Channel (THRU XX). Press the **ENTER** Key. For all other Channel Types press **ENTER** to bypass this field. Use the Keypad to enter the Resume Time. Press **ENTER**.. If 0.0 is selected, Scan Function scans through list until squelch is broken. The 1200 Super S remains at that channel until squelch is no longer broken. Scan Function then continues at the next frequency.

To execute Channel SCAN Function, press **EXEC**, **2ND FUNCT** and **SCAN**. The 1200 SUPER S automatically scans until another function is executed. If the **↑** or **↓** Key is pressed while Scanning Function is active, the Function will restart at the first location. Pressing +/- forces the 1200 SUPER S to continue at the next frequency.

How to Program and Execute the Standard Scan Function in Receive

The Standard SCAN Function switches the RF for the Receive Mode at specific time intervals. The Standard SCAN Function uses RF memory locations 0 thru 15 (where 0 is the current frequency) for the SCAN Frequencies. A range or all locations are used in the Standard SCAN Function. The program scans sequentially through the RF memory locations beginning with the start memory location entry and ending with the stop memory location. Upon reaching the programmed stop memory location, the scan sequence automatically repeats, beginning at the programmed start memory location. The SCAN remains at the RF memory location for the programmed resume time if squelch at that frequency is broken.

To program the Standard SCAN Function, press *2ND FUNCT*, *SETUP* and \uparrow or \downarrow Key until "SET SCAN" is displayed. Press *ENTER*. Press the \uparrow or \downarrow Key until "SCAN STANDARD" is displayed. Press *ENTER*. Program RF memory location 01 thru 15 as desired. Press the *PROG*, *2ND FUNCT* and *SCAN* Keys. Use the Keypad to enter the SCAN Start Memory Location (SCAN XX)

and Stop Memory Location (THRU XX). Press the *ENTER* Key. Use the Keypad to enter the Resume Time. Press *ENTER*. The 1200 SUPER S executes each programmed RF Memory location as listed for the SCAN Function. At each frequency where squelch is broken, the Receiver will pause the entered resume time, then continue scanning the programmed frequencies. If 0.0 is selected for the resume time, Scan Function scans through the list until squelch is broken. The 1200 Super S remains at that frequency until squelch is no longer broken. Scan Function then continues at the next frequency.

To execute Standard SCAN Function, press *EXEC*, *2ND FUNCT* and *SCAN*. The 1200 SUPER S automatically scans through desired frequencies until another function is executed. If the \uparrow or \downarrow Key is pressed while Scanning Function is active, the Function will restart at the first location. Pressing +/- forces the 1200 SUPER S to continue at the next frequency.

3.3 DUPLEX MODE OPERATION

To access the Duplex Mode of the 1200 SUPER S, set the MODE Selector Control to *DUP*.

In Duplex Mode, the 1200 SUPER S is both an RF Generator and an RF Receiver. This operation mode is designed to test the transmitter function of the Duplex System being tested. Internal testing abilities available include an Oscilloscope, Spectrum Analyzer, Frequency Error Meter, Wattmeter, Distortion Meter, SINAD Meter and DVM. Tests and capabilities of this mode are identical to the Receive Mode of operation, including Audio Filter selection.

The Duplex Generator, in this mode of Operation, is limited to only two output levels. The frequency of the Duplex Generator is offset by the Offset Value from the RF Setting. The Duplex Receiver receives at the selected RF.

The Duplex Generator Signal is available at the DUPLEX Connector or the T/R Connector. The Duplex Receiver receives signals off-the-air at the ANT Connector. Direct connections to Duplex Transmitters are made using the T/R Connector.

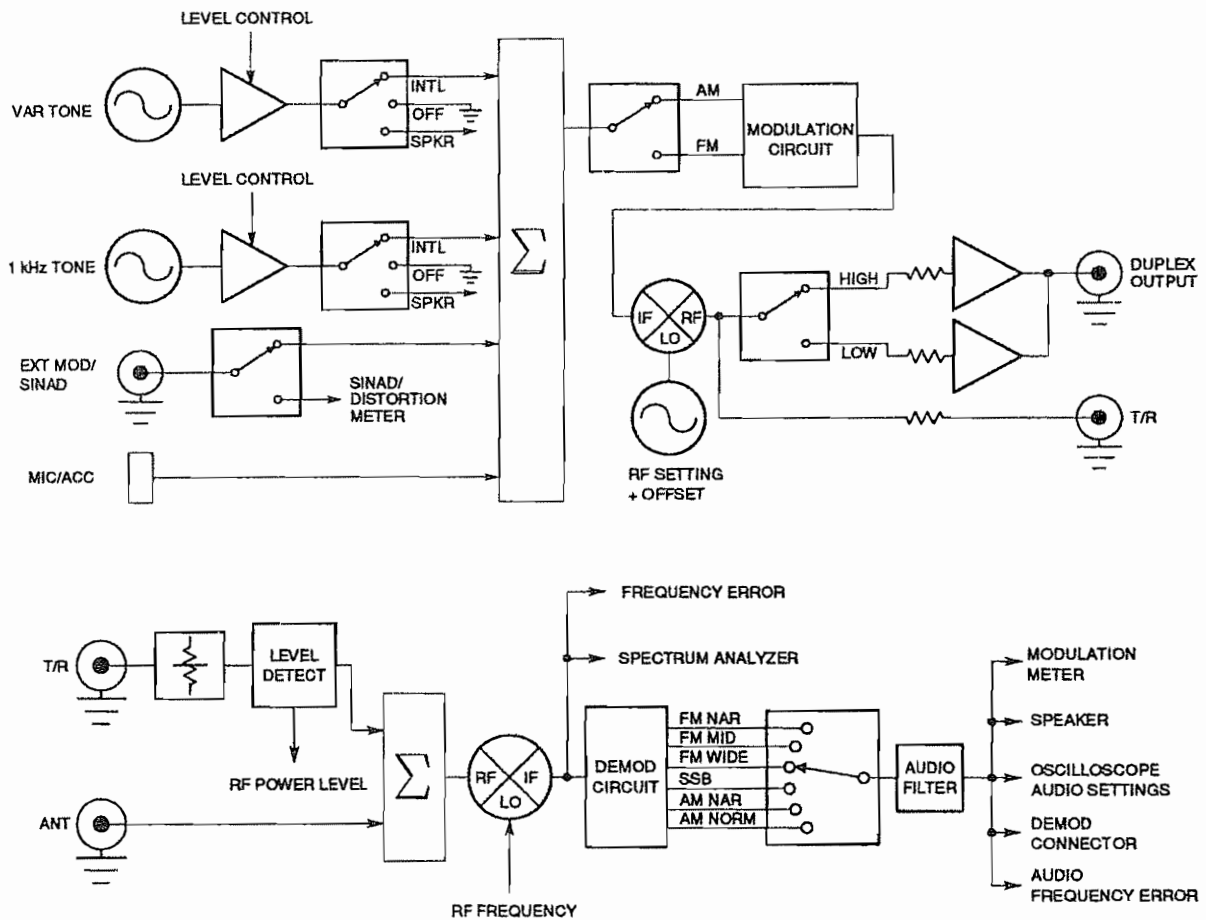

2206018

Duplex Mode Block Diagram

How to Set the Duplex Generator Level

The Duplex Generator has two settings: Duplex High and Duplex Low. To set the Duplex Transmitter level to Duplex Low, press **2ND FUNCT, TRACK** and the \uparrow Key until "DUPLEX LOW" is displayed on the VFD. Press **ENTER**. "DUPLEX LOW ON" is displayed and the Duplex Generator output is set to Duplex Low. To set the Duplex Transmitter level to Duplex High, press **2ND FUNCT, TRACK** and the \uparrow Key until "DUPLEX HIGH" is displayed on the VFD. Press **ENTER**. "DUPLEX HIGH ON" is displayed and the Duplex Generator output is set to Duplex High.

How to Set the Duplex Offset Directly

To Set the Duplex Offset directly, press **OFFSET**. "OFFSET" and the current Offset Frequency are displayed. Enter a new Offset Frequency or edit the current value. Press +/- to toggle between a positive and negative value. Press **ENTER** to complete the operation.

How to Program the Duplex Offset

The 1200 SUPER S has 15 storage locations for programming the Offset Frequency. Each location is programmed by pressing **PROG, OFFSET** and the number of the desired storage location. "OFFSET" and the current stored Offset Frequency are displayed. Enter a new Offset Frequency or edit the current value. Press +/- to toggle between a positive and negative value. Press **ENTER** to complete the operation.

How to Execute a Programmed Offset

To execute a previously programmed Offset Frequency, press **EXEC, OFFSET** and the number of the storage location. The Offset Frequency is set to the stored frequency. Press **ENTER** twice to exit Execute Mode.

How to Select between DTMF Encode or Decode Operation.

DTMF can be encoded or decoded in Duplex Mode. To select the desired operation, press **2ND FUNCT, SETUP** and the \uparrow or \downarrow Key until "SET DTMF" appears on the VFD. Press **ENTER**. Press the \uparrow Key until "DTMF" followed by "ENC IN DUP" (Encode in Duplex Mode) or "DEC IN DUP" (Decode in Duplex Mode) appears. Press +/- until the desired function appears. Press **ENTER** to complete the Operation.

3.4 DUPLEX GENERATE MODE OPERATION

To access the Duplex Generate Mode of the 1200 SUPER S, set the MODE Selector Control to *DUP GEN*.

In Duplex Generate Mode, the 1200 SUPER S is an RF Generator. This operation mode is designed to test the receiver function of the Duplex System being tested. Tests and capabilities of this mode are identical to the Generate Mode of operation. Automatic RECEIVE MODE change over on detection of 100 mW at the T/R port is disabled.

The frequency of the Generator, in Duplex Generate Mode, is the RF Setting plus the Offset Setting. The level of the Duplex Generator is set by the RF Level Attenuator Control and the RF Level Attenuator Vernier Control in the same manner as the level is set in the Generate Mode.

The Duplex Generator Signal is available at the T/R Connector.

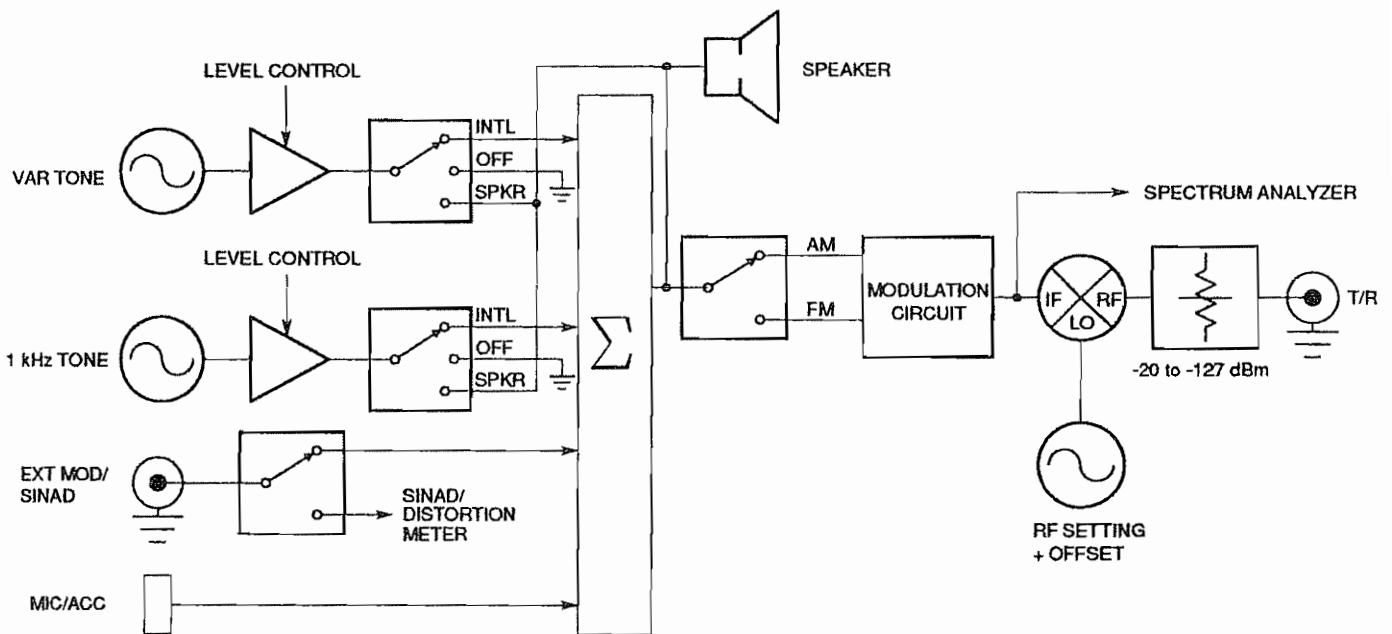

2206013

Duplex Generate Mode Block Diagram

3.5 OSCILLOSCOPE OPERATION

The 1200 SUPER S has a dc to 1 MHz bandwidth single trace Oscilloscope. Triggering for the Oscilloscope is automatic. Inputs available are the internal demodulated signal, the residual distortion and external signals connected to the SCOPE/DVM Connector. In addition, the TONE selection on the HORIZONTAL Sweep Selector Control allows the use of the Lissajou method of frequency comparison.

To turn the Oscilloscope OFF, set the VERTICAL Attenuator Selector Control to OFF.

How to Set the Coupling for SCOPE/DVM Connector

Coupling for the SCOPE/DVM Connector is set by the AC/GND/DC Switch. The position of the switch sets the coupling type.

How to Set the Vertical Scale

The VERTICAL Attenuator Selector Control sets the Vertical Scale for the Oscilloscope. The position that is used depends on both the magnitude of the signal and also the type of

signal being measured. Set the VERTICAL Attenuator Selector Control as follows:

Signal Type	Setting	Ranges
Set Oscilloscope Off	OFF	
Internal Demodulated Signals	KHz/%x10	.5, 2, 5, 20
External Signals	V/Div	.01, .1, 1, 10
Residual	RESID	
700 kHz IF	IF (Requires option provided by IFR Customer Service)	

How to Set the Horizontal Scale

The Oscilloscope shares the HORIZONTAL Sweep Selector Control with the Spectrum Analyzer, so to use the Oscilloscope, only certain settings are used. For normal Oscilloscope Operation, only the *ms/Div* setting is used with ranges of .01, .1, 1 and 10 ms/div. The *TONE* position allows the use of the internal Tone Generators for creating Lissajou patterns.

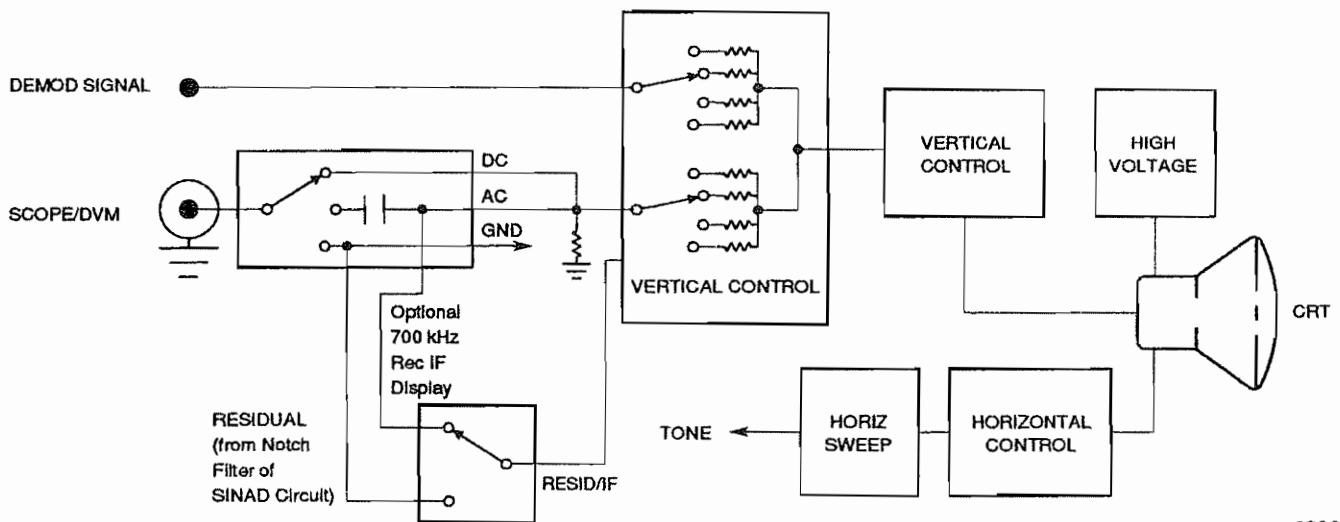

Oscilloscope Block Diagram

2206012

3.6 SPECTRUM ANALYZER OPERATION

The 1200 SUPER S Spectrum Analyzer provides measurements for both internal and external signals. In Generate and Duplex Generate Modes, the Spectrum Analyzer displays the generated signal. In Receive and Duplex Mode, the Spectrum Analyzer displays the signal received at the ANT or T/R Connector. The Spectrum Analyzer is calibrated to display -30 dBm signal at the ANT Connector as a top-of-screen signal.

In Generate and Duplex Generate Modes, the Spectrum Analyzer displays the generated signal. In Receive and Duplex Mode, the Spectrum Analyzer displays the signal received at the ANT or T/R Connector. The Spectrum Analyzer is calibrated to display -30 dBm signal at the ANT Connector as a top-of-screen signal.

To turn the Spectrum Analyzer OFF, set the VERTICAL Attenuator Selector Control to OFF.

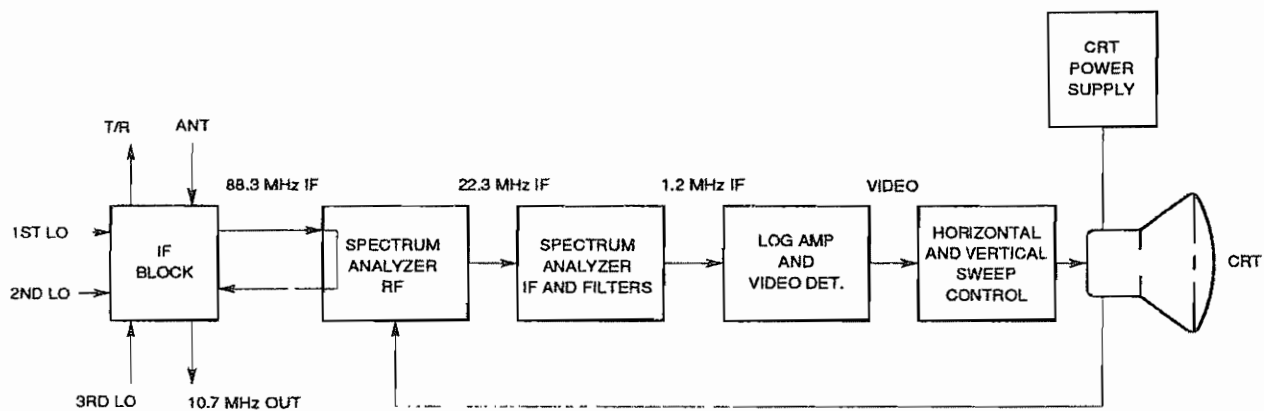

2206017

Spectrum Analyzer Block Diagram

How to Set Horizontal Scale

The Spectrum Analyzer shares the HORIZONTAL Sweep Selector Control with the Oscilloscope, so to use the Spectrum Analyzer, only certain settings are used. For Spectrum Analyzer Operation, the *MHz/DIV* and the *kHz/DIV* settings are used. The resolution bandwidth is fixed for each setting range. Available ranges and resolution bandwidths, for each setting, are as follows:

Setting	Range	Resolution Bandwidth
kHz/DIV	1	300 Hz
kHz/DIV	2	300 Hz
kHz/DIV	5	3 kHz
kHz/DIV	10	3 kHz
kHz/DIV	20	3 kHz
kHz/DIV	50	30 kHz
MHz/DIV	.1	30 kHz
MHz/DIV	.2	30 kHz
MHz/DIV	.5	30 kHz
MHz/DIV	1	30 kHz

How to Adjust to the Spectrum Analyzer Horizontal and Vertical Position

To assure a calibrated Horizontal and Vertical position on the analyzer, set the 1200 SUPER S to Generate Mode with no modulation. Set the Analyzer Horizontal dispersion to 1 kHz/DIV. Use the VERT POS Control to adjust the baseline exactly to the bottom graticule. Set the Analyzer Horizontal dispersion to the desired span and use the HORIZ POS Control to place the center of the displayed signal exactly to the center graticule.

3.7 DIGITAL VOLTMETER (DVM) OPERATION

The DVM in the 1200 SUPER S is capable of making ac and dc measurements from 0 to 100 V. DC measurements are in Vdc. AC measurements are in VRMS or in dBm. The ac dBm measurements are referenced to 0 dBm at a 600 Ω external load. Input for the DVM is only through the SCOPE/DVM Connector.

Press *2ND FUNCT* and *DVM* to display the DVM on the VFD.

How to Set the DVM to Measure DC Voltage

Press *2ND FUNCT* and *DVM* to display the DVM on the VFD. Press +/- Key until "DVM --- DC" is displayed.

How to Set the DVM to Measure AC Voltage

Press *2ND FUNCT* and *DVM* to display the DVM on the VFD. If measurement in VRMS is desired, Press +/- Key until "DVM --- AC" is displayed. If measurement in dBm is desired, Press +/- Key until "DVM --- DBM" is displayed.

How to Set the DVM to dBm Reference Mode

Press *2ND FUNCT* and *DVM* to display DVM on the VFD. Press +/- Key until "DVM --- DBM" is displayed. Press "." Key to set the current reading as a "zero" reference. The display becomes "DVM + 0.00 DBMR." Press "." to undo the reference.

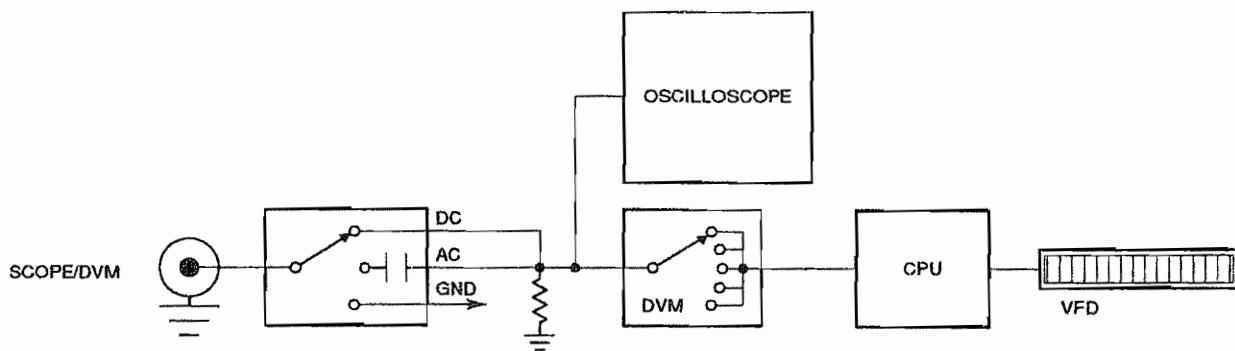

2206015

Digital Voltmeter (DVM) Block Diagram

3.8 TONE GENERATOR OPERATION

To access the Tone Generators of the 1200 SUPER S, locate **TONE GENERATOR** on the front panel. The Function Generator (Variable Tone) is capable of SINE, SQUARE, RAMP and TRIANGLE waveforms as well as TTL, TONE SEQ and DCS. Use the toggle switch for the 1 kHz Fixed Tone or the Variable Tone to select INTL (Internal), OFF or SPKR (Speaker). Adjust the Control Knobs for desired Volume or Level. To use as a modulation source for UUT, use the TONE OUT Connector.

The Fixed Tone is a 1 kHz sinewave. The output level is variable to 2.5 VRMS minimum into 150 Ω load.

The Variable Tone has a frequency range of 10 Hz to 100 kHz in 0.1 Hz increments. It is capable of SINE, SQUARE, RAMP, TRIANGLE waveforms and TTL. The output level is variable to 2.5 VRMS minimum into 150 Ω load.

How to Set an Audio Level at the Tone Connector

Set the 1 kHz Fixed Tone or the Variable Tone Generator to INTL. Set desired frequency if Variable Tone is used. Connect a coax between the TONE OUT and SCOPE/DVM Connectors. Access the DVM by pressing **2ND FUNCT** and **DVM**. Set DVM to read AC. Adjust the Tone Level Control for desired Output Level as measured on the DVM. Disconnect the coax. The desired Output Level is now present at the TONE OUT Connector. The impedance of the circuit TONE OUT is connected to will effect the output level.

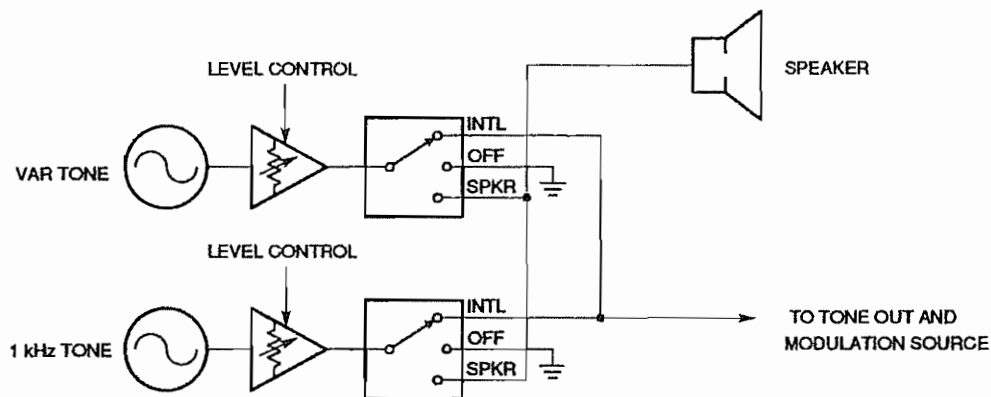

2206016

Tone Generator Block Diagram

How to Program the T SEQ (Tone Sequence) Function

T SEQ (Tone Sequence) programs the ON time and OFF time of each of the 16 tone memory locations. All 16 (0 thru 15) locations may be programmed or any group of tones (e.g.; 00 thru 05, 03 thru 10, 12 thru 15, etc.) may be programmed for execution in sequential order. Each Tone Memory location will display an "ON TIME" (duration of Tone) and an "OFF TIME" (delay before the execution of the next tone in the sequence).

Tone memory locations which are not to be executed by the T SEQ function do not need to be programmed for "ON TIME" and "OFF TIME" since the 1200 SUPER S executes only the group of tones programmed.

To program the T SEQ Setup, press the **2ND FUNCT** and **SETUP** Keys. Press the \uparrow or \downarrow Key to select SET T SEQ. Press **ENTER**. Select T SEQ ONE-SHOT or T SEQ CONTINUOUS by toggling between the selections with the +/- Key. Press the \uparrow or \downarrow Key until T SEQ TONE SEQ or T SEQ TONE SWEEP is displayed. Press the +/- Key until T SEQ TONE SEQ is displayed.

Press **ENTER** and **RF**.

How to Program the T SEQ Memory

EXAMPLE: Program a Tone Sequence consisting of an 800 Hz tone of 1 second duration with a 0.500 second delay before executing a 600 Hz tone of 3 seconds duration.

Press **PROG**, **2ND FUNCT** and **T SEQ**. Press **0, 1** to enter the starting tone number. Press **0, 2** to enter the ending tone number in the tone sequence.

The Tone Sequence location that appears on the VFD is the last Tone Sequence memory location programmed. If necessary, use the \uparrow or \downarrow Keys to access Tone Memory Location 1.

The \uparrow and \downarrow Keys in the T SEQ Mode are used to scroll through the tone memory location numbers only. Digits must be entered with the Keypad.

Press the **1,0,0,0** Keys. The "ON TIME" is now programmed for 1 second and the cursor moves to the "OFF TIME" data field.

Press the **0, 5, 0, 0** Keys. The "OFF TIME" is now programmed for a 0.500 second.

Press the \uparrow Key to access the Tone 2 sequence program screen.

Press the \leftarrow Key four times to access the Tone 2 Frequency Field. Press the **3, 0, 0, 0, 0, 0, 0, 0** Keys to program the tone "ON TIME" with no "OFF TIME."

Press the **PROG** and **TONE** Keys.

Press the **1** Key. The VFD shows the programmed Tone 1 frequency with the cursor over the first digit.

Press the **8, 0, 0, ., 0, ENTER** Keys.

Press the **PROG** and **TONE** Keys.

Press the **2** Key. The VFD shows the programmed Tone 2 frequency with the cursor over the first digit.

Press the **6, 0, 0, ., 0, ENTER** Keys.

How to Execute a Programmed Tone Sequence

In the Tone Sequence Mode, the 1200 SUPER S outputs programmed tones. The 1200 SUPER S must be set for the T SEQ Mode to execute a programmed Tone Sequence.

Press the *EXEC*, *2ND FUNCT* and *T SEQ* Keys. The 1200 SUPER S executes the Tone Sequence programmed. The VFD shows the frequency of the first tone in the programmed sequence. This frequency displays for the programmed ON TIME plus the programmed OFF TIME. The VFD then switches to the next tone programmed in the sequence. The sequence of tones continues until all tones programmed have been executed.

Press the *ENTER* Key twice to exit the Execute Mode.

How to Program the Tone Sweep Function

To program the TONE SWEEP Setup, press the *2ND FUNCT* and *SETUP* Keys. Press the \uparrow or \downarrow Key to select SET T SEQ. Press *ENTER*. Select T SEQ ONE-SHOT or T SEQ CONTINUOUS by toggling between the selections with the +/- Key. Press the \uparrow or \downarrow Key until T SEQ TONE SEQ or T SEQ TONE SWEEP is displayed. Press the +/- Key until T SEQ TONE SWEEP is displayed. Press the \uparrow or \downarrow Key to program these parameters:

TIME = the duration of each tone in the Tone Sweep (0.000 thru 9.999 Seconds). If TIME is set to 0.000, 1200 SUPER S must be turned OFF to stop execution of Tone Sweep.

STEP = Tone Step frequency increment in Hz (0.0 thru 99999.9 Hz).

STOP = ending Tone Sweep frequency in Hz (0.0 thru 99999.9 Hz).

START = starting Tone Sweep frequency in Hz (0.0 thru 99999.9 Hz).

Press *ENTER* and *RF*.

How to Execute the Tone Sweep Function

In the Tone Sweep Mode, the 1200 SUPER S outputs tones in steps from the Start Tone Frequency to the Stop Tone Frequency.

Press the *EXEC*, *2ND FUNCT* and *T SEQ* Keys. The VFD displays "TONE SWEEP" as the 1200 SUPER S sweeps from the START to the STOP frequency in increments of the STEP frequency. When the STOP frequency is reached, the VFD displays "COMPLETED."

APPLICATIONS

The following Applications are for testing Narrow Band FM Tranceivers.

4.1 HOW TO MEASURE RECEIVER CENTER FREQUENCY

The following procedure configures the 1200 SUPER S to measure the center frequency of a receiver.

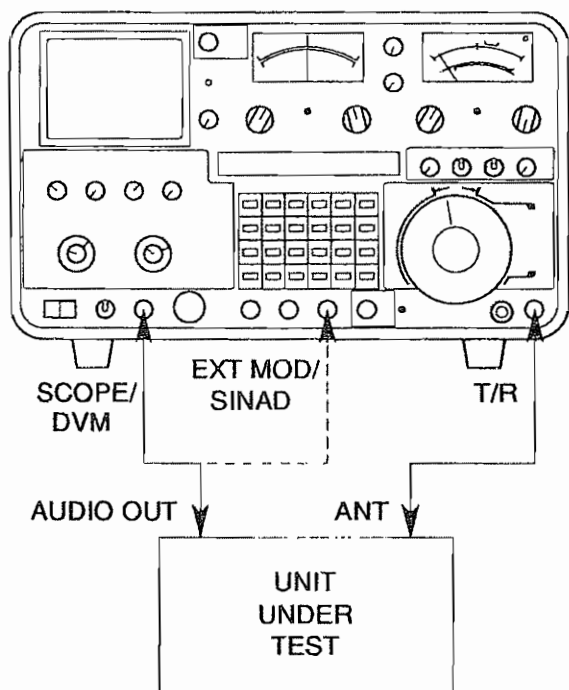

1. Set 1200 SUPER S RF Frequency for UUT Center Frequency.
2. Set 1200 SUPER S Mode Switch to *GEN*.
3. Set 1200 SUPER S RF output level to *-50 dBm*.
4. Set 1 kHz Fixed Tone Generator to *INTL*.
5. Set MODULATION Switch to *FM NAR*.

6. Set METER Switch to *6 kHz* range.
7. Adjust 1 kHz Fixed Tone Deviation Level to *3 kHz*.
8. Set 1200 SUPER S DVM to read AC voltage.
9. Connect 1200 SUPER S T/R Connector to UUT Antenna Connector and UUT Audio Out to SCOPE/DVM Connector.
10. Adjust UUT Audio Output for maximum output.
11. Measure Audio Output level on DVM.
12. Adjust UUT Audio Output level for 60% of maximum DVM reading.
13. Connect UUT Audio Output to EXT MOD/SINAD Input.
14. Set METER Switch to *SINAD*.
15. Adjust UUT RF Output level for 12 dB SINAD on Modulation Meter.
16. Press *RF*.
17. Adjust RF for highest SINAD Meter reading.
18. Slew the 1200 SUPER S RF Frequency in 1 kHz increments for the highest SINAD Meter reading. Final 1200 SUPER S Meter reading is UUT Center Frequency.

4.2 HOW TO MEASURE RECEIVER SENSITIVITY

The following procedure configures the 1200 SUPER S to measure Receiver Sensitivity.

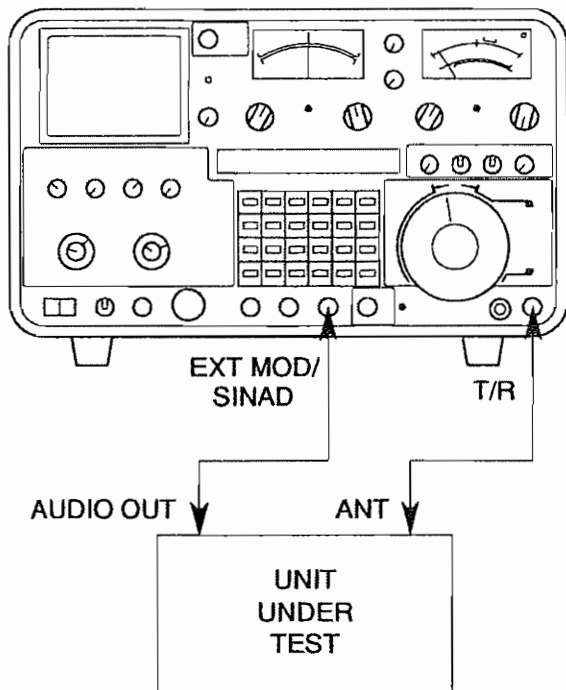

1. Determine UUT Center Frequency.
2. Set 1200 SUPER S RF for UUT Center Frequency.

3. Connect 1200 SUPER S T/R Connector to UUT Antenna Connector.
4. Set 1200 SUPER S Mode Switch to *GEN*.
5. Set RF output level to *-50 dBm*.
6. Set 1 kHz Fixed Tone Generator to *INTL*.
7. Set MODULATION Switch to *FM NAR*.
8. Set METER Switch to *6 kHz* range.
9. Adjust 1 kHz Fixed Tone Deviation Level to 60% of system rated deviation.
10. Adjust Volume on UUT for an audible level.
11. Set METER Switch to *SINAD*.
12. Connect UUT Audio Out to EXT MOD/SINAD and decrease RF Output level until 10 dB or 12 dB is reached as specified by Receiver Manufacturer. Final level is Receiver Sensitivity Level.

4.3 HOW TO MEASURE RECEIVER AUDIO OUTPUT LEVEL

The following procedure configures the 1200 SUPER S to measure Receiver Audio Output Level.

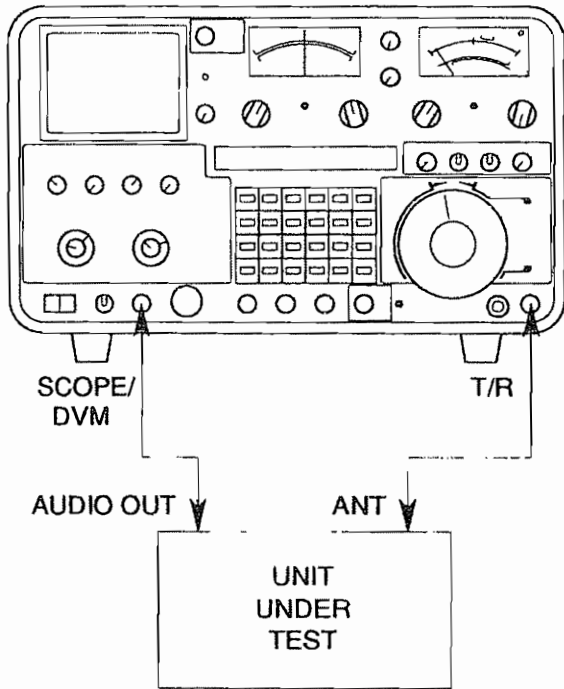

1. Set 1200 SUPER S RF for UUT Center Frequency.
2. Set Output Level to -50 dBm .
3. Set 1 kHz Fixed Tone Generator to *INTL*.
4. Set MODULATION Switch to *FM NAR*.
5. Adjust 1 kHz Fixed Tone Deviation Level to 3 kHz .
6. Connect 1200 SUPER S T/R Connector to UUT Antenna Connector and UUT Audio Out to SCOPE/DVM Connector.
7. Adjust Volume on UUT for an audible level.
8. Adjust UUT Audio Output for desired level.
9. Set DVM Readout for desired units. DVM Reading is Audio Output Level of Receiver.

4.4 HOW TO MEASURE THE MODULATION ACCEPTANCE BANDWIDTH FOR AN FM RECEIVER

The following procedure configures the 1200 SUPER S to measure Receiver Modulation Acceptance Bandwidth.

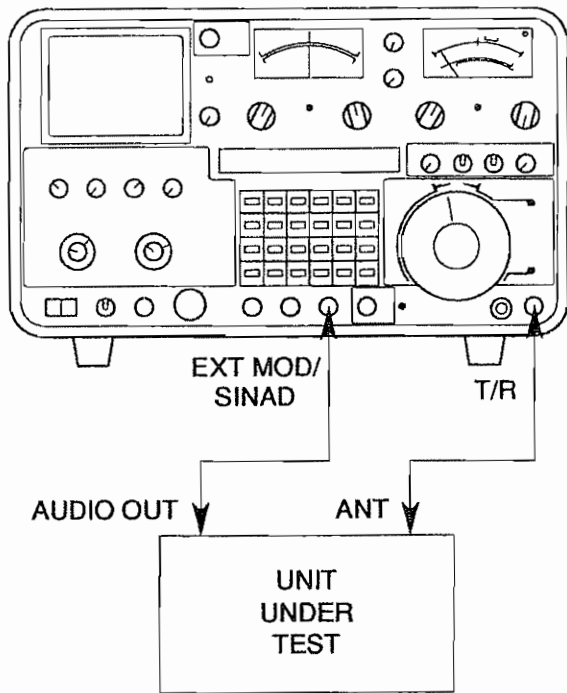

2206020

1. Determine UUT Center Frequency.
2. Set 1200 SUPER S RF for UUT Center Frequency.
3. Set 1 kHz Fixed Tone Generator to *INTL*.
4. Adjust 1 kHz Fixed Tone Deviation Level to 3 kHz.
5. Set METER Switch to SINAD.
6. Connect T/R Connector to UUT Antenna Connector and UUT Audio Out to EXT MOD/SINAD Connector.
7. Adjust Volume on UUT for an audible level.
8. Adjust RF Output for 12 dB SINAD Meter Reading.
9. Increase 1200 SUPER S RF Output Level 6 dB.
10. Increase Deviation Level until SINAD Meter Reads 12 dB.
11. Disconnect from EXT/MOD SINAD.
12. Set METER Switch to appropriate Deviation Range. Modulation Acceptance Bandwidth is twice Deviation Level.

4.5 HOW TO MEASURE RECEIVER IF BANDWIDTH

The following procedure configures the 1200 SUPER S to measure Receiver IF Bandwidth.

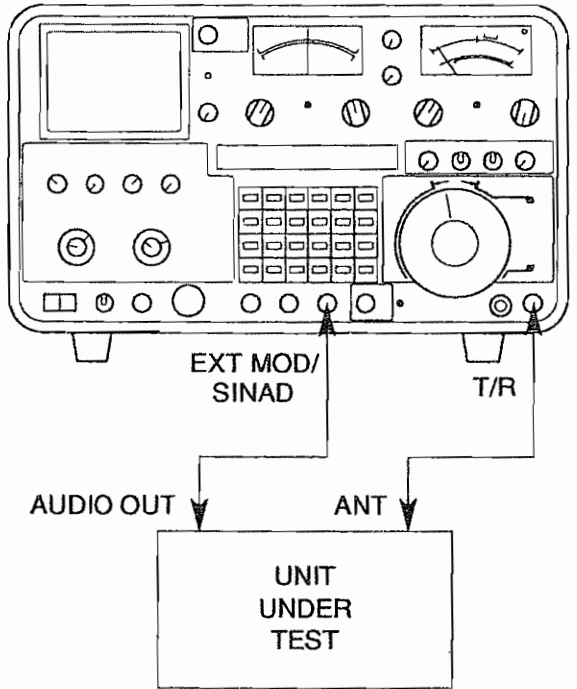

1. Set 1200 SUPER S RF for UUT Center Frequency.
2. Set Output Level to **-50 dBm**.
3. Set 1 kHz Tone Generator to **INTL**.
4. Set Modulation Switch to **FM MID**.
5. Adjust 1 kHz Fixed Tone Deviation Level to **3 kHz**.
6. Connect T/R Connector to UUT Antenna Connector and UUT Audio Out to EXT MOD/SINAD Connector.
7. Adjust Volume on UUT for an audible level.
8. Set Receiver Squelch to lowest setting.
9. Set METER Switch to SINAD.
10. Adjust Output level for 12 dB SINAD. Once 12 dB Point is reached, current level is Reference Sensitivity.
11. Increase 1200 SUPER S RF Output Level by 60 dB.
12. Increase RF until the SINAD Meter reads 12 dB. Resulting frequency is Upper Frequency.
13. Decrease RF below Center Frequency until the SINAD Meter reads 12 dB. Resulting frequency is Lower Frequency.
14. Subtract Lower Frequency from Upper Frequency to obtain Receiver IF Bandwidth.

4.6 HOW TO MEASURE TRANSMITTER FREQUENCY ERROR

TO AVOID THE RISK OF DAMAGE TO THE 1200 SUPER S, ALL TRANSMITTER APPLICATIONS WITH SIGNAL LEVELS OF -30 dB OR GREATER SHOULD BE INTRODUCED VIA THE T/R CONNECTOR.

The following procedure configures the 1200 SUPER S to measure the Frequency Error of a 100 MHz RF Signal at the ANTENNA Connector.

1. Set 1200 SUPER S RF to UUT Transmitter Center Frequency.
2. Set MODE Switch to *REC*.
3. Set *FREQ ERROR* Switch to *3 kHz RF* Range setting.
4. Connect UUT RF Output to 1200 SUPER S T/R Connector.
5. Press *2ND FUNCT* and *METER*.
6. Activate UUT Transmitter. Frequency Error is displayed on 1200 SUPER S VFD.

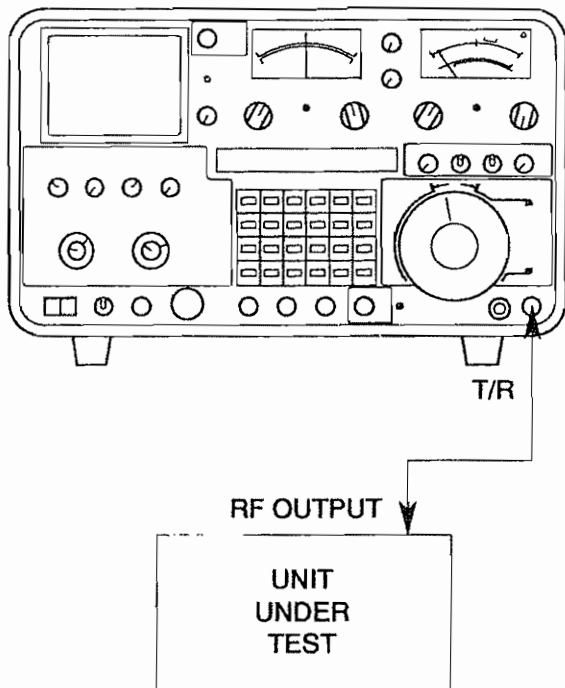

2206022

4.7 HOW TO MEASURE TRANSMITTER CTCSS FREQUENCY

The following procedure configures the 1200 SUPER S to measure the CTCSS Frequency of a Transmitter.

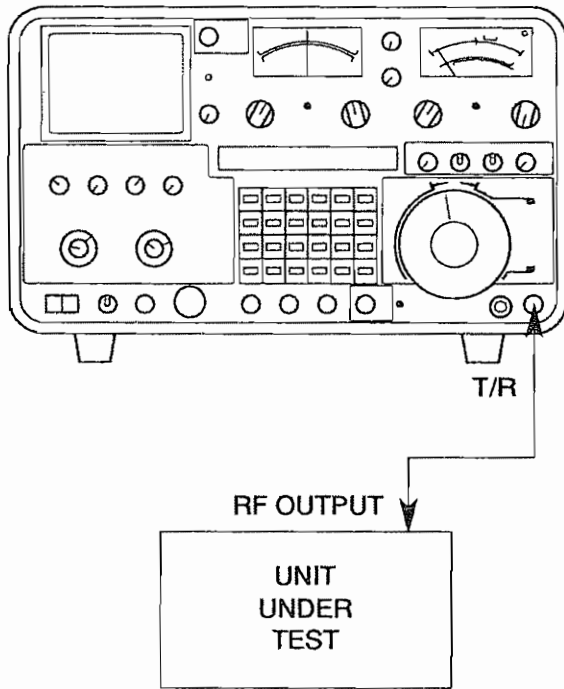

2206022

1. Set RF to UUT Transmitter Center Frequency.
2. Set MODE Switch to *REC*.
3. Connect UUT RF Output to 1200 SUPER S T/R Connector.
4. Press *2ND FUNCT* and *CTCSS*.
5. Activate UUT Transmitter. CTCSS Frequency is displayed on VFD when received.

4.8 HOW TO MEASURE TRANSMITTER HARMONICS

The following procedure configures the 1200 SUPER S to measure Harmonics.

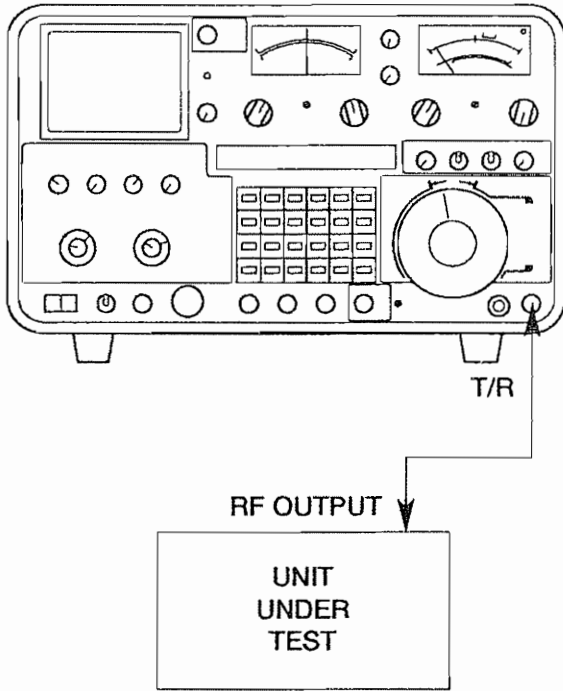

2206022

1. Set 1200 SUPER S RF to UUT Transmitter Center Frequency.
2. Set MODE Switch to *REC*.
3. Connect UUT RF Output to 1200 SUPER S T/R Connector.
4. Set ANALYZER on .1 MHz/DIV.
5. Activate UUT Transmitter.
6. Press *2ND FUNCT* and *SETUP*.
7. Use \uparrow or \downarrow Key to select *HARMONIC CHECK*. Press *ENTER*.
8. Use \uparrow or \downarrow Key to scroll through *HARMONICS F* (Fundamental) and 2 thru 8 (or up to 1 GHz). Analyzer displays selected *HARMONIC* Signal. Harmonic Signal Level on the Analyzer is referenced to the Fundamental Signal.

4.9 HOW TO PERFORM CABLE FAULT TEST

The following procedure configures the 1200 SUPER S to measure Cable Fault. Optional Tracking Generator required.

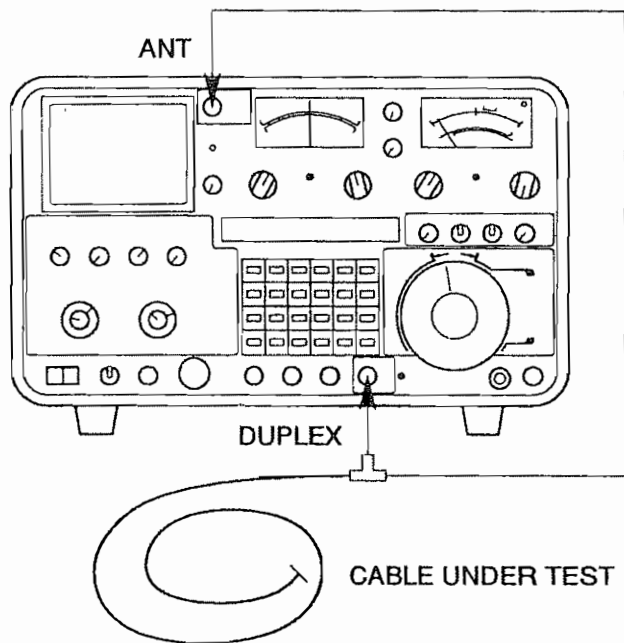

2206023

1. Set ANALYZER to .2 MHz/DIV.
2. Set MODE Switch to *DUP*.
3. Connect BNC "Tee" to DUPLEX Connector.
4. Connect coax to ANT Connector and BNC "Tee".
5. Connect Cable Under Test to BNC "Tee".
6. Press *2ND FUNCT* and *TRACK*.
7. Use ↑ or ↓ Keys to select *TRACK LOW*. Press *ENTER*.
8. Use ↑ or ↓ key to select *CABLE FAULT*. Press *ENTER*.
9. Select *1, 0, .*, and use ↑ or ↓ to center the first dip of the signal on the center graticule of the analyzer. Press *ENTER*.
10. Select *1, 0, .*, and use ↑ or ↓ to center the second dip of the signal on the center graticule of the analyzer. Press *ENTER*.
11. Set appropriate *VEL FACTOR*. Press *ENTER*. Cable length is displayed.
12. Press *ENTER* to toggle between *FEET* and *METERS*.
13. Press *RF* to Exit.

4.10 HOW TO PERFORM DEVIATION CHECK

The following procedure configures the 1200 SUPER S to perform an internal Deviation Check of the Modulation Meter.

1. Set 1200 SUPER S MODE Switch to **GEN**.
2. Set 1200 SUPER S RF Frequency to 100.0 MHz.
3. Set VAR Tone Generator to **INTL**.
4. Set MODE Switch to **FM NAR** for measurements made for deviation levels of ≤ 5 kHz. Set MODE Switch to **FM MID**, otherwise.
5. Set METER Switch to **6 kHz RANGE**.
6. Press **2ND FUNCT** and **SETUP**.
7. Use \uparrow or \downarrow key to select **DEVIATION CHECK**. Press **ENTER**.
8. Set **DESIRED** deviation point to check (in Hz). Press **ENTER**. "MODFREQ" is displayed.
9. Press **TONE**. Tone is automatically set to correct modulation frequency. Press **ENTER**.
10. Set ANALYZER to 1 kHz/DIV.
11. Starting from full ccw, slowly adjust VAR Tone amplitude until center carrier disappears into the noise floor. This point is exactly the desired deviation.
12. Verify Modulation Meter reads the desired deviation.

REMOTE OPERATION

5.1 REMOTE OPERATION OVERVIEW

How to Configure the 1200 SUPER S for Remote Operations

The 1200 SUPER S uses the RS-232 Format for Remote Operation unless the IEEE 488 Option is installed. To configure for Remote Operation, press *2ND FUNCT*, *SETUP* and \uparrow or \downarrow Key until "SET COMM" is displayed. Press *ENTER*. "SET BAUD" followed by the current baud rate setting is displayed. Set the desired baud rate by pressing the corresponding Numeric Key. Numeric Keys to select Baud Rates are as follows:

<u>Numeric Key</u>	<u>Baud Rate</u>
1	300 bps
2	600 bps
3	1200 bps
4	2400 bps
5	4800 bps
6	9600 bps
7	19200 bps

Press the \uparrow Key. "SET DATA BITS" followed by the current Data Bits setting is displayed. Set the desired data bits by pressing the corresponding Numeric Key, 7 or 8. Press the \uparrow Key. "SET STOP BITS" followed by the current Stop Bits setting is displayed. Set the desired stop bits by pressing the corresponding Numeric Key, 1 or 2. Press the \uparrow Key. "SET PARITY" is displayed followed by the current Parity setting. Settings include "N" (None) "E" (Even) and "O" (Odd). Select desired Parity using Numeric Keys. Select as follows:

<u>Numeric Key</u>	<u>Parity</u>
1, 4, 7	Odd ("O")
2, 5, 8	Even ("E")
3, 6, 9	None ("N")

Press *ENTER* to complete the configuration.

Syntax Used with Remote Commands

The 1200 SUPER S has three basic command types: Query, Program and Execute. These Command Types have the following basic structure:

Type	Format	Description
Query	FUNC? or FUNCn?	Used to request data on stored parameters or current operation. The "n" parameter defines the specific memory location.
Program	FUNC=x or FUNCn=x	Programs parameter "x" for the specified function. The "n" parameter defines the specific memory location.
Execute	FUNC or FUNCn	Executes the specified function. The "n" parameter defines the specific memory location.

All commands are executed by a Line Feed (LF), a Carriage Return (CR) or a colon (:). The colon is used when typing in multiple commands to be executed simultaneously.

Connecting the Controller to the 1200 SUPER S For Remote Operation.

To connect the Controller to the 1200 SUPER S, perform the following procedure:

1. Connect the Control Device to the 1200 SUPER S. Refer to Appendix B for 1200 SUPER S Connector information.
2. Configure the 1200 SUPER S for remote operations, setting the protocol for the 1200 SUPER S to match the protocol of the Control Device.
3. Type two Carriage Returns on the Control Device. "RS-232 Enabled" is displayed on the VFD.

5.2 1200 SUPER S REMOTE COMMANDS

COMMAND	RANGE	DESCRIPTION
RECEIVER FUNCTION		
REM		Puts 1200 SUPER S in Remote Mode.
REC		Puts 1200 SUPER S in Receive Mode.
RFFn=x	n = 0 to 15 x = 000.0000 to 999.9999	Programs RF where n is the Memory Location and x is the frequency in MHz.
RFF=x	x = 000.0000 to 999.9999	Programs and executes RF stored in memory location 0.
RFFn?	n = 0 to 15	Displays RF from memory location n on VFD.
RFFn	n = 0 to 15	Executes RF specified by memory location n.
RFEx	x = 1 to 6	Sets FREQ ERROR Meter to RF range as stored in x. 1 = 30 Hz RF 4 = 1 kHz RF 2 = 100 Hz RF 5 = 3 kHz RF 3 = 300 Hz RF 6 = 10 kHz RF
MMRx	x = 2, 6, 20, or 60	Sets Modulation Meter 2 = 2 kHz or 20% Full Scale 6 = 6 kHz or 60% Full Scale 20 = 20 kHz or 200% Full Scale 60 = 60 kHz or 600% Full Scale
SIG		Sets Modulation Meter to measure relative signal strength.
15A		Sets Modulation Meter to 15 W Average Power range.
150A		Sets Modulation Meter to 150 W Average Power range.
15P		Sets Modulation Meter to 15 W Peak Power range.
150P		Sets Modulation Meter to 150 W Peak Power range.
GENERATE FUNCTION		
REM		Puts 1200 SUPER S in Remote mode.
GEN		Puts 1200 SUPER S in Generate mode.
RFFn=x	n = 0 to 15 x = 000.0000 to 999.9999	Programs RF where n is the Memory Location and x is the frequency in MHz.
RFF=x		Programs and executes RF of memory location 0.
RFFn?		Displays RF memory location n on VFD.
RFFn	n = 0 to 15	Executes RF memory location n.
AFFn=x	n = 0 to 15 x = 000.0 to 99999.9	Programs Tone Generator Frequency where n is the memory location and x is the frequency.
AFF=x	x = 0000.0 to 99999.9	Programs and executes Tone Generator frequency stored in memory location 0.
AFFn?	n = 0 to 15	Displays Tone Generator memory location n on VFD.
AFFn	n = 0 to 15	Executes Tone Generator memory location n.
WAVn=x	n = 0 to 15 x = SIN, SQU, RMP, TRI	Programs Tone Waveform memory location n.
WAVn?	n = 0 to 15	Displays Wave Shape of Tone memory location n.

COMMAND	RANGE	DESCRIPTION
DUPLEX OPERATION		
REM		Puts 1200 SUPER S in Remote mode.
DUP		Puts 1200 SUPER S in Duplex mode.
RFFn=x	n = 0 to 15 x = 000.0000 to 999.9999	Programs RF where n is the Memory Location and x is the Frequency in MHz.
RFF=x		Programs and executes Duplex RF memory location 0.
DPXn	n = 0 to 15	Executes Duplex Offset memory location n.
RFFn?	n = 0 to 15	Displays Duplex RF of memory location n on the VFD.
RFFn	n = 0 to 15	Executes Duplex RF memory location n.
DPXn=x	n = 0 to 15 x = -49.99 to +49.99	Programs Offset where n is the Memory Location and x is the Frequency in MHz.
DPX=x	x = -49.99 to +49.99	Programs and executes Offset memory location 0.
DPXn?	n = 0 to 15	Displays Duplex Offset of memory location n.
DPXn	n = 0 to 15	Executes Duplex Offset memory location n.
DUPLEX GENERATE OPERATION		
REM		Puts the unit in Remote mode.
DPG		Puts the unit in Duplex Generate mode.
RFFn=x	n = 0 to 15 x = 000.0000 to 999.9999	Programs RF where n is the Memory Location and x is the Frequency in MHz.
RFF=x	x = 000.0000 to 999.9999	Programs and executes RF memory location 0.
RFFn?	n = 0 to 15	Displays RF memory location n on VFD.
RFFn	n = 0 to 15	Executes RF memory location n.
DPXn=x	n = 0 to 15 x = -49.99 to +49.99	Programs Duplex Offset memory location n.
DPX=x	x = -49.99 to +49.99	Programs and executes Duplex Offset stored in memory location 0.
DPXn?	n = 0 to 15	Displays Duplex Offset of memory location n.
SIGNALING TONES OPERATION		
REM		Puts the 1200 SUPER S in remote mode.
DTMn=x or DTMFn=x	n = 0 to 15 x = 0-9, A, B, C, D, #, *	Programs DTMF number (x) of memory location n. 16 digits are the Limit.
DTM=x or DTMF=x	x = 0-9, A, B, C, D, #, *	Programs and executes DTMF in memory location 0.
DTMn? or DTMFn?	n = 0 to 15	Displays DTMF Code in memory location n on VFD.
DTMn or DTMFn	n = 0 to 15	Executes DTMF Code in memory location n.
DTMD		Sets unit to DTMF Encode/Decode operation and returns DTMF value displayed on VFD after reception.

COMMAND	RANGE	DESCRIPTION
RCCn=x	n = 0 to 15 x = 0-9, A, B, C, D, #, *	Programs RCC Code (x) for memory location n. Limit is 16 digits.
RCCn?	n = 0 to 15	Displays RCC Code in memory location n.
IMTSn	n = 0 to 15	Executes IMTS Format of RCC Code in memory location n.
MTSn	n = 0 to 15	Executes MTS Format of RCC Code in memory location n.
VF1n	n = 0 to 15	Executes VF1 (10 pulses per second) of RCC Code in memory location n.
DCS=+n or DCS=-n	n = 000 to 777 (Octal)	Programs DCS Code (n). Programmed as DCS Normal if (+) is used. Programmed as DCS Inverted if (-) is used.
DCS?		Queries DCS Code.
DCS		Executes DCS Code.
VF2n	n = 0 to 15	Executes VF2 (20 pulses per second) of RCC Code in memory location n.
PROGRAMMABLE FILTER OPERATION		
REM		Puts the 1200 SUPER S in Remote mode.
FILTTYx	x = 0 to 7	Sets Filter Type as stored in x. 0 = Off 4 = High Pass 1 = Band Pass 5 = N/A 2 = Low Pass 6 = Notch 3 = N/A 7 = All Pass
FILTERx	x = 0 to 7	Sets Filter Demod Route and Clock. 0 = Demod Audio bypassed, Meter bypassed, Clock 1 MHz 1 = Demod Audio bypassed, Meter thru Filter, Clock 1 MHz 2 = Demod Audio thru Filter, Meter bypassed, Clock 1 MHz 3 = Demod Audio thru Filter, Meter thru Filter, Clock 1 MHz 4 = Demod Audio bypassed, Meter bypassed, Clock 100 kHz 5 = Demod Audio bypassed, Meter thru Filter, Clock 100 kHz 6 = Demod Audio thru Filter, Meter bypassed, Clock 100 kHz 7 = Demod Audio thru Filter, Meter thru Filter, Clock 100 kHz
FILTQx	x = 0 to 31	Sets Filter Quality. 0 = 0.57 8 = 1.35 16 = 5.00 24 = 15.50 1 = 0.65 9 = 1.65 17 = 5.80 25 = 17.50 2 = 0.71 10 = 1.95 18 = 7.20 26 = 20.00 3 = 0.79 11 = 2.20 19 = 8.70 27 = 24.00 4 = 0.87 12 = 2.50 20 = 10.00 28 = 30.00 5 = 0.95 13 = 3.00 21 = 11.50 29 = 35.00 6 = 1.05 14 = 3.50 22 = 12.00 30 = 55.00 7 = 1.20 15 = 4.25 23 = 13.50 31 = 85.00

COMMAND	RANGE	DESCRIPTION
DEL= (ascii#)	1 to 127	Changes the colon (:) delimiter to another character entered as the ASCII character decimal equivalent.
SCAN=x:y	x = 0 to 15 y = 0 to 15	Sets SCAN start (x) and stop (y) using 0 to 15 RF memory locations
SCAN?		Returns current RF memory locations programmed for SCAN.
SCAN		Executes SCAN function.
RESUME=x	x = 0.0 to 9.9	Sets resume time in seconds.
RESUME?		Returns current resume time.
STEPR=x	x = 000.0000 to 999.9999	Sets RF STEP increment in MHz.
STEPR?		Returns current RF STEP increment setting
STEPT=x	x = 0000.0 to 99999.9	Sets Tone STEP increments.
STEPT?		Returns current Tone STEP increment setting.
STEPR+		Increases RF by the RF STEP increment.
STEPR-		Decreases RF by the RF STEP increment.
STEPT+		Increases Tone by the Tone STEP increment.
STEPR-		Decreases Tone by the Tone STEP increment.
SQUELCH?		Returns Squelch Status of 1 or 0 where 1 is Squelched.
RF CHANNEL OPERATION		
REM		Puts the 1200 SUPER S in Remote mode.
CELLCH=x	x = 0 to 2047	Sets Operation to Cellular Channel at channel number x.
CELLCH?		Queries current Cellular Channel Number
CELFWD		Sets the Cellular Channel for Forward Channel Operation
CELREV		Sets the Cellular Channel for Reverse Channel Operation
LTRCH=x	x = 1 to 760	Sets Operation to Trunking Channel at channel number x.
LTRCH?		Queries current Trunking Channel Number.
LTRFWD		Sets the Trunking Channel for Forward Channel Operation.
LTRREV		Sets the Trunking Channel for Reverse Channel Operation.
PHNCH=x	x = 1 to 10	Sets Operation to Cordless Phone Channel at channel number x.
PHNCH?		Queries current Cordless Phone Channel Number.
PHNFWD		Sets the Cordless Phone Channel for Forward Channel Operation
PHNREV		Sets the Cordless Phone Channel for Reverse Channel Operation.
TVCCH=x	x = 2 to 61	Sets Operation to Cable TV at channel number x.
TVCCH?		Queries current Cable TV Channel Number.
TVCAUD		Sets the Cable TV Channel for Audio Channel Operation.
TVCVID		Sets the Cable TV Channel for Video Channel Operation.
TVSCH=x	x = 2 to 83	Sets Operation to Standard TV at channel number x.

COMMAND	RANGE	DESCRIPTION
TVSCH?		Queries current Standard TV Channel Number.
TVSAUD		Sets the Standard TV Channel for Audio Channel Operation.
TVSVID		Sets the Standard TV Channel for Video Channel Operation.
CBCH=x	x = 1 to 40	Sets Operation for Citizen's Band (CB) Radio at channel number x.
CBCH?		Queries current Citizen's Band (CB) Radio Channel Number.
USRLST _n	n = 0 to 99	Executes User Channel Number n.
USRLST _n =x	n = 0 to 99 x = 000.0000 to 999.99999	Programs User Channel Number n for the specified frequency (x).
USRLST _n ?	n = 0 to 99	Queries current User List Channel Number.
CHEXE		Executes the current RF Channel Selection.
EUROPEAN SIGNALING TONES OPERATION (OPTION 11)		
REM		Puts the 1200 SUPER S in Remote mode.
CCIR=x	x = 0 to 9, R and G	Sets and executes CCIR encode of up to 8 characters.
CCIR?		Returns decoded CCIR message.
CCIR		Executes CCIR encode.
EEA=x	x = 0 to 9, R and G	Sets and executes EEA encode of up to 8 characters.
EEA?		Returns decoded EEA message.
EEA		Executes EEA encode.
EIA=x	x = 0 to 9, R and G	Sets and executes EIA encode of up to 8 characters.
EIA?		Returns decoded EIA message.
EIA		Executes EIA encode.
ZV1=x	x = 0 to 9, R and G	Sets and executes ZVEI1 encode of up to 8 characters.
ZV1?		Returns decoded ZVEI1 message.
ZV1		Executes ZVEI1 encode.
ZV2=x	x = 0 to 9, R and G	Sets and executes ZVEI2 encode of up to 8 characters.
ZV2?		Returns decoded ZVEI2 message.
ZV2		Executes ZVEI2 encode.
ZV3=x	x = 0 to 9, R and G	Sets and executes ZVEI3 encode of up to 8 characters.
ZV3?		Returns decoded ZVEI3 message.
ZV3		Executes ZVEI3 encode.
NAT=x	x = 0 to 9, R and G	Sets and executes NATEL encode of up to 8 characters.
NAT?		Returns decoded NATEL message.
NAT		Executes NATEL encode.

COMMAND	RANGE	DESCRIPTION
EUR=x	x = 0 to 9, R and G	Sets and executes EUROencode of up to 8 characters.
EUR?		Returns decoded EURO message.
EUR		Executes EURO encode.
5/6=x	x = 0 to 9, R and G	Sets and executes 5/6 encode of up to 9 characters.
5/6?		Returns decoded 5/6 message.
5/6		Executes 5/6 encode.
CCH=x	x = 0 to 9, R and G	Sets and executes CCIRH encode of up to 8 characters.
CCH?		Returns decoded CCIRH message.
CCH		Executes CCIRH encode.
CCH4=x	x = 0 to 9, R and G	Sets and executes CCIRH4 encode of up to 8 characters.
CCH4?		Returns decoded CCIRH4 message.
CCH4		Executes CCIRH4 encode.
2T=x	x = 0 to 9, R and G	Sets and executes 2-TONE encode of up to 8 characters.
2T?		Returns decoded 2-TONE message.
2T		Executes 2-TONE encode.
EDEV=x	x = 0.00 to 9.99	Sets Encode Deviation in kHz.
EDEV?		Returns programmed Encode Deviation.
TRACKING GENERATOR OPERATION (OPTION 12)		
REM		Puts the Unit in Remote mode.
DPL=x	x = HIGH or LOW	Sets Duplex output level.
DPL?		Returns Duplex output level. Returns "OFF" if Tracking Generator is enabled.
TGL=x	x = HIGH, MED or LOW	Sets Tracking Generator output level.
TGL?		Returns Tracking Generator output level. Returns "OFF" if Duplex Generator is enabled.
TGA=x	x = ON or OFF	Enables/Disables the Tracking Generator Adjust Function.
TGA+		Increases Tracking Generator Adjust value when Tracking Generator Adjust Function is active.
TGA-		Decreases Tracking Generator Adjust value when Tracking Generator Adjust Function is active.
TGR		Resets Tracking Generator Adjust number.
CLEARCHANNEL LTR OPERATION (OPTION 14)		
AREA=x	x = 0 or 1	Sets System Area Bit.
AREA?		Returns System Area Bit.
GOTORP=x	x = 0 to 31	Sets GOTO Repeater number.
GPTORP?		Returns GOTO Repeater number.
MOBID=x	x = 0 to 255	Sets Mobile ID Number.

COMMAND	RANGE	DESCRIPTION
MOBID?		Returns Mobile ID Number.
HOMREP=x	x = 0 to 31	Sets Home Repeater Number.
HOMREP?		Returns Home Repeater Number.
HOMRCH=x	x = 0 to 760	Sets Home Repeater Channel Number.
HOMRCH?		Returns Home Repeater Channel Number.
FREREP=x	x = 0 to 20	Sets Free Repeater Number.
FREREP?		Returns Free Repeater Number.
FRERCH=x	x = 0 to 760	Sets Free Repeater Channel Number.
FRERCH?		Returns Free Repeater Channel Number.
CHBND=x	x = 800 or 900	Sets System Operation Band.
CHBND?		Returns System Operation Band.
BORDER=x	x = 0 or 1	Sets System Border Offset Value.
BORDER?		Returns System Border Offset Value.
HDSKID=x	x = 0 to 255	Sets Repeater ID for handshaking.
HDSKID?		Returns Repeater ID for handshaking.
LTRMANT		Executes LTR Manual Mode using T/R Connector.
LTRMANA		Executes LTR Manual Mode using ANT Connector.
LTRFREE		Executes LTR Repeater Free Test.
LTRBUSY		Executes LTR Repeater Busy Test.
LTRRICT		Executes LTR Repeater RIC Test using the T/R Connector.
LTRRICA		Executes LTR Repeater RIC Test using the ANT Connector.
LTRMOBT		Executes LTR Repeater Mobile Test using the T/R Connector.
LTRMOBA		Executes LTR Repeater Mobile Test using the ANT Connector.
CELLULAR OPERATION (OPTION 15)		
CNTCHN=x	x = 1 to 1023 AMPS x = 1 to 1000 or 1329 to 2047 E-TACS	Sets Control Channel.
CNTCHN?		Returns Control Channel.
HOMROM=x	x = HOME or ROAM	Sets HOME/ROAM Select.
HOMROM?		Returns HOME/ROAM Select.
VOCCHN=x	x = 1 to 1023 AMPS x = 1 to 1000 or 1329 to 2047 E-TACS	Sets Voice Channel.
VOCCHN?		Returns Voice Channel.
MIN=x	x = 0 to 9 , # or *	Sets Mobile I.D. Number to 10 digits.
MIN?		Returns Mobile I.D. Number.
SERIAL=x		Sets Serial Number (x) as Decimal up to 11 decimal digits.

COMMAND	RANGE	DESCRIPTION
SERNO?		Returns Serial Number, 8 hexadecimal or 11 octal/decimal digits.
SERNOD=x		Sets Serial Number (x) as Decimal up to 11 decimal digits.
SERNOX=x		Sets Serial Number (x) as Hexadecimal up to 8 hexadecimal digits.
SERNOO=x		Sets Serial Number (x) as Octal up to 11 octal digits.
SATFREQ=x	x = 5970, 6000 or 6030	Sets SAT Frequency.
SATFREQ?		Returns SAT Frequency.
HOMEID=x		Sets Home Area I.D. Number (x) of up to 5 decimal digits.
HOMEID?		Returns Home Area I.D. Number.
DCC=x	x = 0, 1 or 2	Sets Digital Color Code.
DCC?		Returns Digital Color Code.
HENAB=x	x = 0 or 1	Enables/Disables Handoff Test. If set to 0, test is enabled.
HENAB?		Returns Handoff Test Enable status.
HBEG=x	x = 1 to 1023 AMPS x = 1 to 1000 or 1329 to 2047 E-TACS	Sets Handoff Test Beginning Channel.
HBEG?		Returns Handoff Test Beginning Channel.
HEND=x	x = 1 to 1023 AMPS x = 1 to 1000 or 1329 to 2047 E-TACS	Sets Handoff Test End Channel.
HEND?		Returns Handoff End Channel.
HINC=x	x = 0 to 999	Sets Handoff Test Increment.
HINC?		Returns Handoff Test Increment.
HRATE=x	x = 0 to 9	Sets Handoff Delay Rate in Seconds.
HRATE?		Returns Handoff Delay Rate.
CFMT=x	x = AMPS or E-TACS	Specifies Cellular Format.
CFMT?		Returns Cellular Format.
OPID=x	x = 000 to 999	Specifies Operator I.D. Number.
OPID?		Returns Operator I.D. Number.
PENAB=x	x = 0 or 1	Enables/Disables Printer Function. If set to 1, function is enabled.
PENAB?		Returns Printer Function status.
PBAUD=x	x = 0 to 6	Sets Printer Baud Rate. 0 = 110 4 = 2400 1 = 300 5 = 4800 2 = 600 6 = 9600 3 = 1200
PBAUD?		Returns Printer Baud Rate.
PDATA=x	x = 7 or 8	Sets Printer Data Bits.
PDATA?		Returns Printer Data Bits.

COMMAND	RANGE	DESCRIPTION
PSTOP=x	x = 1 or 2	Sets Printer Stop Bits.
PSTOP?		Returns Printer Stop Bits.
PPARITY=x	x = 0, 1 or 2	Sets Printer Parity. 0 = None 1 = Odd 2 = Even
PPARITY?		Returns Printer Parity.
PFENAB=x	x = 0 or 1	Enables/Disables printout Pass/Fail Indicator. If set to 1, the indicator is enabled.
PFENAB?		Returns Pass/Fail Indicator Status.
REGENAB=x	x = 0 or 1	Enables/Disables Cellular Registration Test. If set to 1, test is enabled.
REGENAB?		Returns Cellular Registration Test Status.
CALLC		Executes Cell-Initiated Call Processing Test.
CALLM		Executes Mobile-Initiated Call Processing Test.
CALLA		Executes Call Processing Test in Auto-Test Mode.
CPRES?		Returns result of Call Processing Test where P indicates Pass and F indicates Fail.
CABORT		Aborts Cellular Radio Test.
SATDEV?		Returns SAT Tone Deviation Reading.
XPWR?		Returns Mobile Transmitter Signal Level.
XERR?		Returns Mobile Transmitter Frequency Error.
STDEV?		Returns Signal Tone Deviation.

OPTIONS

6.1 LIST OF OPTIONS AVAILABLE

Option 02 - 0.05 PPM OCXO Time Base
Replaces standard .2 PPM Time Base to increase frequency stability.

Option 05 - Generate Amplifier
Externally attached RF Amplifier.
Refer to para. 6.2 for additional information.

Option 06 - Microphone
This Microphone is designed to connect to the MIC/ACC Connector and provide MIC Modulation. If unit is in Receive or Duplex Mode, unit switches to Generate Mode when the Microphone is keyed.

Option 09 - Soft Padded Carrying Case
Case is designed to protect the unit when it is required to be portable.

Option 11 - European Tone Signaling
Provides additional Tone Signaling formats (Encode/Decode). Refer to para. 6.3 for additional information.

Option 12 - Tracking Generator
Provides Tracking Generator function with output at the DUPLEX Connector for use with the Spectrum Analyzer. This Option required for SWR Return Bridge, Part No. AC4101.

Option 13 - IEEE 488
Remote Control Interface using IEEE 488 (GPIB) protocol in place of the RS-232 interface. Refer to para. 6.5 for additional information.

Option 14 - CLEARCHANNEL LTR[®] Radio
Provides testing capabilities for both Mobile Stations and Repeater in CLEARCHANNEL LTR[®] Trunking Systems. Refer to para. 6.6 for additional information.

Option 15 - AMPS/E-TACS Cellular
Provides testing capabilities for AMPS and E-TACS Cellular Mobile Stations. Refer to para. 6.7 for additional information.

6.2 GENERATE AMPLIFIER OPTION

The Generate Amplifier is a 30 dB amplifier intended to increase the output level of a generated signal above the normal maximum level of the test set. It is not designed to receive any signal directly from a Transmitter. However, if properly installed, the Generate Amplifier can be used to transmit and receive signals. **DO NOT TRANSMIT DIRECTLY INTO THE GENERATE AMPLIFIER. DAMAGE TO THE GENERATE AMPLIFIER AND/OR THE TEST SET MAY RESULT.**

How to Install Generate Amplifier

To install the Generate Amplifier, insert the Banana Plug of the Generate Amplifier into the AUX PWR Connector and connect the Generate Amplifier BNC Connector to the T/R Connector.

If the 1200 SUPER S is to generate by direct connection to a Receiver, connect a coaxial cable between the Generate Amplifier and the RF input for the Receiver under test.

If the 1200 SUPER S is to be used to conduct a Radio Installation Checkout, connect a coaxial cable between the ANT Connector and the Generate Amplifier and connect an Antenna to the output connector of the Generate Amplifier. **THE RADIO INSTALLATION CHECK MUST BE PERFORMED WITH BOTH THE TEST SET AND THE UNIT UNDER TEST IN A SHIELDED AREA TO PREVENT UNRESTRICTED RADIATION OF RF SIGNALS.**

6.3 EUROPEAN TONE SIGNALING OPTION

The European Tone Signaling option allows the encoding and decoding of various formats. The European Tone Signaling formats available with this option include:

CCIR	ZVEI1	NATEL
EEA	ZVEI2	CCIRH
EIA	ZVEI3	EURO
CCIRH4		

Additionally this option allows both encode and decode of two pager formats that are encode only in the standard Test Set. Those Formats are 5/6 Tone and Two Tone.

Special characters are used to represent the Repeat and Group Codes. The Repeat Character is represented as "R" on the VFD. For the Repeat Character, press *2ND FUNCT* and #. The Group Character is represented as "G" on the VFD. For the Group Character, press *2ND FUNCT* and •.

How to Configure European Tone Signaling System Parameters

Press *2ND FUNCT*, *SETUP* and ↑ or ↓ Key until "SET EURO" is displayed on the VFD. Press *ENTER*. Press ↑ or ↓ Key until "ENC IN DUP" (Encode in Duplex Mode) or "DEC IN DUP" (Decode in Duplex Mode) is displayed. Press +/- until desired mode is displayed. Press ↑ or ↓ Key until "CONTINUOUS" OR "ONE-SHOT" is displayed. "CONTINUOUS" means the Tone Generator is set to generate the Code repeatedly until another Mode Key is pressed. "ONE-SHOT" means the Tone Generator is set to generate the Code once only. Press +/- until desired mode is displayed. Press ↑ or ↓ Key until "ENC IN GEN" (Encode in Generate Mode) or "DEC IN GEN" (Decode in Generate Mode) is displayed. Press +/- until desired mode is displayed. Press *ENTER* to complete the operation.

How to Select and Program European Tone Signaling Formats

To select the desired European Tone Signaling, press *PROG*, *2ND FUNCT* and *EURO*. The current format type appears with the current programmed code. Press the ↑ or ↓ Key until the desired format is displayed. Press the → Key to access the code field. Enter the new code or edit the current code. Press *ENTER*. "DEV=" appears followed by the current deviation setting in kHz. Enter the new deviation or edit the current setting. Press *ENTER* to complete the Operation.

How to Select and Program 5/6 Tone Format

To select the 5/6 Tone Function, press *PROG*, *2ND FUNCT* and *EURO*. The current format type appears with the current programmed code. Press the ↑ or ↓ Key until "5/6" is displayed for the format. Press the → Key to access the Preamble Character field. Enter the new Preamble Character or edit the current character. Press the → Key to access the code field. Enter the new code or edit the current code. Press *ENTER*. "DEV=" appears followed by the current deviation setting in kHz. Enter the new deviation or edit the current setting. Press *ENTER* to complete the operation.

How to Select and Program the Two Tone Function

To select Two Tone, press *PROG*, *2ND FUNCT* and *EURO*. Press the ↑ or ↓ Key until "2T" is displayed on the VFD. Press the → Key to access the Variable Field. Press the ↑ or ↓ Key until "#1" is displayed. Press the → Key to access the Tone Frequency Field. Enter a new frequency for the first tone or edit the current frequency. Press the → Key to access the Tone Duration Field. Enter a new duration in ms for the first tone duration or edit the current duration. Press *ENTER*. The VFD displays "2T GAP" followed by the pause time between the two tones in ms. Enter a new pause time or edit the current pause time. Press *ENTER*. The VFD displays "2T #2" with the cursor on the second tone frequency. Enter a new frequency or edit the current frequency. Press the → Key to access the Tone Duration Field. Enter a new duration in ms for the second tone duration or edit the current duration. Press *ENTER* to complete the edit.

How to Generate with Tone Signalling Format as Modulation Source

Once the 1200 SUPER S has been configured to generate an RF signal and the Tone Signaling format is programmed, the Tone Signaling can be used as a modulation source by pressing *EXEC*, *2ND FUNCT* and *EURO*. Press *ENTER* twice to escape from Execute Mode.

How to Decode Tone Signalling Formats

After the Format has been configured, the specified Signaling Format is decoded. To decode, press *2ND FUNCT* and *EURO*. The VFD displays the selected format and dashes for the code field. If the current Operation Mode is Receive or Duplex Mode, connect the signal to the T/R Connector or transmit the signal for off-the-air reception at the ANT Connector. If the current Operation Mode is Generate or Duplex Generate Mode, connect the baseband signal to the EXT MOD/SINAD Connector.

6.4 TRACKING GENERATOR OPTION

The Tracking Generator Option allows the operator to tune and align radio communications components such as notch filters, duplexers, circulators, combiners and isolators. The device under test is connected between the swept RF output present at the DUPLEX Connector and the input to the Spectrum Analyzer at the ANT Connector. To activate the Tracking Generator Option, the 1200 SUPER S must be in Duplex Mode.

How to Set Tracking Generator Level

To set the Tracking Generator level, press *2ND FUNCT* and *TRACK*. The active function is displayed with "ON" on the VFD. Press the \uparrow or \downarrow Key to display desired level. Tracking Generator Levels are as follows:

TRACK HIGH	-5 dBm (+3/-5 dB)
TRACK MED	-15 dBm (± 7 dB)
TRACK LOW	-40 dBm (+5,-10 dB)

Once desired output level is displayed, press *ENTER*.

How to Adjust Signal Tracking

When the HORIZONTAL Sweep Selector Control is set to 1, 2, 5 or 10 kHz/DIV, the Track Adjust Function can be used to compensate for the delay of the Resolution Bandwidth Filter.

To use the Track Adjust Function, the current Tracking Generator Level must be displayed. With the current Tracking Generator Level displayed, press the \rightarrow Key to access the Tracking Adjust Function. "TRACKING ADJ 0" is displayed. Use the \leftarrow or \rightarrow Key to edit the Tracking Adjust value and observe for a peak signal on the Spectrum Analyzer. The range of the value is ± 50 . To reset the value to 0, press *ENTER*. Press *ENTER* to complete the Operation.

6.5 IEEE-488 (GPIB) OPTION

The IEEE Option replaces the RS-232 Remote Control Interface with an IEEE-488 (GPIB) Remote Control Interface. The Remote Commands used with the GPIB Interface are identical to commands used with the RS-232 Interface. When set by the Host device, the 1200 SUPER S has the following capabilities:

- Complete Source and Acceptor Handshake
- Talker
- Listener
- Remote/Local (No local lockout capability)

The GPIB Interface conforms with the IEEE Standard 488-1978. Pin-out for the GPIB connector is in Appendix B.

How to Set the GPIB Address

In order to communicate using the GPIB Interface, the address of the 1200 SUPER S must be set. To set the GPIB Address, press *2ND FUNCT*, *SETUP* and the \uparrow or \downarrow Key until "SET COMM" is displayed. Press *ENTER*. Press the \uparrow or \downarrow Key until "SET GPIB ADRS" is displayed with the current address. Enter a new GPIB Address. Cursor Control Keys cannot be used to edit the current address. Press *ENTER* to complete the Operation.

6.6 CLEARCHANNEL LTR[®] OPTION

The CLEARCHANNEL LTR[®] Option provides the ability to test CLEARCHANNEL LTR[®] Trunked Radio operating systems to include testing of both mobile stations and repeaters. Testing capabilities for the mobile station include simple encode/decode capabilities, accessing a Home Repeater, handoff to a Free Repeater and testing Radio Interconnect Mode (RIC). Testing of Repeaters includes testing encode/decode capabilities when the Repeater is free and the 1200 SUPER S acts as a mobile station (Repeater Handshake Test) and the Repeater's ability to hand the 1200 SUPER S to a free Repeater

How to Set Trunking Parameters

1. Set the RF to the Trunking (Reverse) Channel of the Unit Under Test.
2. Set the Offset to +45 MHz if operating in the 800 MHz band or +39 MHz if operating in the 900 MHz band.
3. Set the MODULATION Selector Control to *FM MID*.
4. Set the Modulation METER Switch to *2 KHz/%x10*.
5. Set the MODE Selector Control to *GEN*.
6. Set the TONE to a 100 Hz Square Wave.
7. Set the VAR Tone Selector Switch to *INTL* and adjust the VAR Tone Level Control for 800 Hz reading on the MODULATION METER.
8. Set the MODE Selector Switch to *REC*. Adjust the SQUELCH fully ccw and then cw until the SIG Indicator goes out.
9. Press *PROG*, *2ND FUNCT* and *TRUNK* to access the Trunking Parameters.
10. Press the ↑ or ↓ key until "ID CODE" is displayed on the VFD. Enter the Mobile Station ID Code.
11. Press the ↑ key until "HOME REPEATER" is displayed on the VFD. Enter the Home Repeater Number.
12. Press the ↑ key until "HOME REP CHN" is displayed on the VFD. Enter the Home Repeater Channel Number.
13. Press the ↑ key until "FREE REPEATER" is displayed on the VFD. Enter the Free Repeater Number.
14. Press the ↑ key until "FREE REP CHN" is displayed on the VFD. Enter the Free Repeater Channel Number.
15. Press the ↑ key until "GOTO REPEATER" is displayed on the VFD. Enter the GOTO Repeater Number.
16. Press the ↑ key until "AREA" is displayed on the VFD. Enter 0 if Area bit does not need to be set or 1 if required.
17. Press the ↑ key until "BORDER OFFSET" is displayed on the VFD. Enter 0 if Border Offset Bit does not need to be set or 1 if required.
18. Press the ↑ key until "CHANNEL BAND" and the current Channel Band is displayed on the VFD. Press any numeric key on the Keyboard to toggle the Channel Band, as required.
19. Press the ↑ key until "REP H/S ID" is displayed on the VFD. Enter the Repeater Handshake ID Code (same as Mobile Station ID Code).
20. Press *ENTER* to complete the Operation.

How to Select Trunking Test Type

To select Trunking Test Type, press *EXEC*, *2ND FUNCT* and *TRUNK*. Press the \uparrow or \downarrow Key until desired Test is displayed. LTR Tests are as follows:

LTR MANUAL (Repeater Simulation)

In Duplex Mode, connects with the Mobile Station until Push-To-Talk is released, then transmits back to the Mobile Station to verify that the Mobile Station receives programmed LTR Code. In Duplex Generate Mode, transmits to the Mobile Station to verify that Mobile Station receives programmed LTR Code. In Receive Mode, decodes the LTR Code transmitted by the Mobile Station and displays the information on the screen. When LTR MANUAL Test is selected in Receive Mode, the 1200 SUPER S queries whether input is to the T/R Connector or to the ANT Connector. DO NOT transmit into the ANT Connector. Press +/- to toggle between the selections. Presentation of Data is as follows:

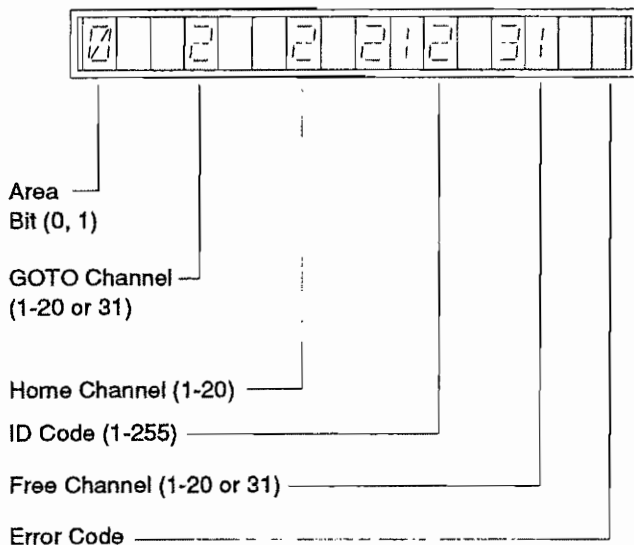

2203001

The Error Code displays nothing, an "S" flashing, an "S" not flashing or a "C."

When the Error Code Field displays nothing, no errors were found. The Error Code Field displays an "S" flashing when the Mobile Station is transmitting. This is not an error condition. The Error Code Field displays a nonflashing "S" when the Sync Code is not found. The Error Code Field displays a "C" to indicate a checksum error.

LTR REPTR FREE (Repeater Simulation)

Performed in Duplex Mode, verifies that the Unit Under Test handshakes with the Home Repeater (1200 SUPER S).

LTR REPTR BUSY (Repeater Simulation)

Performed in Duplex Mode, verifies that the Unit Under Test accesses the Free Repeater when the Home Repeater is busy.

LTR REPTR RIC (Repeater Simulation)

Performed in Duplex Mode, verifies that the Unit Under Test performs a Radio Interconnect and transmits a DTMF string. When LTR REPTR RIC Test is selected, the 1200 SUPER S queries whether input is to the T/R Connector or to the ANT Connector. Press +/- to toggle between the selections.

LTR MOBILE (Mobile Station Simulation)

Performed in Duplex Mode, verifies that the Repeater handshakes with a Mobile Unit.

LTR GENERATE (Repeater Simulation)

When activated, provides a signal to the Unit Under Test to open the squelch, but allows the operator to leave LTR and use the 1200 SUPER S to conduct other testing and troubleshooting.

Once selection is made, press *ENTER* to complete operation.

Repeater Simulation Applications

For all Repeater Simulation Tests, connect the Mobile Station to the 1200 SUPER S as follows:

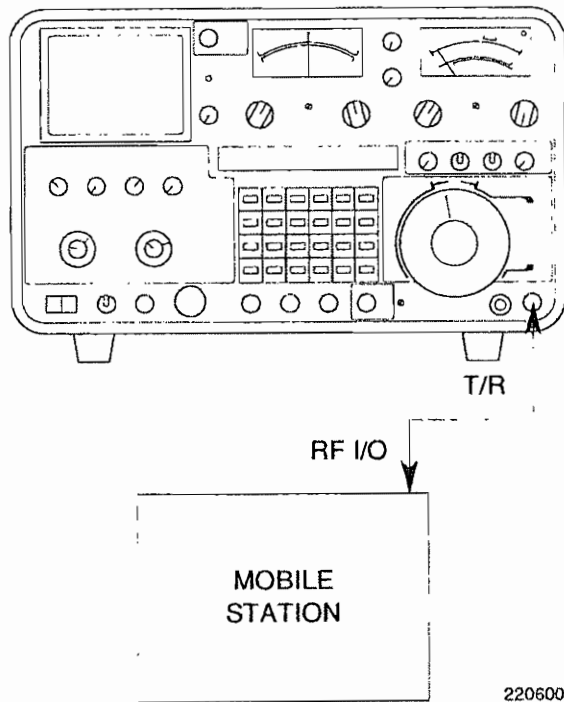

Encode Test (Repeater Simulation)

To perform an Encode Test, set the LTR Trunking Parameters, set the RF Level Attenuator Control and the RF Level Attenuator Vernier control for an output accepted by the Mobile Station Under Test, set the MODE Selector Switch to **DUP GEN** and select LTR MANUAL as the LTR Test. The 1200 SUPER S transmits the Handshaking Data and the Audio Signal to the Mobile Station. The transmitted Handshaking Data is displayed on the VFD. For correct operation, the Mobile Station must receive the signal, break squelch and the audio signal must be present. Receiver Sensitivity tests and other tests requiring a variable level attenuator are performed in this Test Mode. SINAD and Distortion Measurements for the Receive Section of the Mobile Station are available, when the 1 kHz Tone Generator is activated.

Decode Test (Repeater Simulation)

An alternate hookup is to connect an antenna to the Duplex Output of the Mobile Station and connect an antenna to the ANT Connector of the 1200 SUPER S.

To perform a Decode Test, set the LTR Trunking Parameters, set the MODE Selector Switch to **REC**, and select LTR MANUAL as the LTR Test, selecting T/R input if connections are made as shown or ANT input if antennas are used. Press and release the Push-To-Talk switch on the Mobile Station. The 1200 SUPER S decodes the Handshaking Data transmitted by the Mobile Station. For correct operation, the 1200 SUPER S must receive the signal, break squelch and display the proper Trunking Parameters on the VFD.

Performing a Repeater Access Test

To perform the Repeater Access Test, set the LTR Trunking Parameters, set the MODE Selector Switch to **DUP** and select LTR MANUAL as the Trunking Test. Press the Push-To-Talk switch on the Mobile Station. For correct operation, the 1200 SUPER S must receive the signal and break squelch. Release the Push-To-Talk Switch. Once the 1200 SUPER S senses the release of the Push-To-Talk switch, transmission of the Handshaking Data and the Audio Signal begins. For correct operation, the Mobile Station must receive the signal, break squelch and the audio signal must be present.

Performing a Handshake Test

To perform the Handshake Test, set the LTR Trunking Parameters, set the MODE Selector Switch to *DUP* and select LTR REPTR FREE as the Trunking Test. "HOME IDLE" is displayed on the VFD. Press the Push-To-Talk switch on the Mobile Station. For correct operation, the 1200 SUPER S must receive the signal, break squelch and display "PUSH TO TALK" on the VFD. Release the Push-To-Talk switch on the Mobile Station. For correct operation, the 1200 SUPER S must squelch and display "RELEASED PTT" on the VFD. A failure to handshake properly causes the 1200 SUPER S to display "LOST TRANSMITTER" on the VFD.

Performing a Handoff Test

To perform the Handoff Test, set the LTR Trunking Parameters, set the MODE Selector Switch to *DUP* and select LTR REPTR BUSY as the Trunking Test. "HOME/FREE IDLE" is displayed on the VFD. Press the Push-To-Talk switch on the Mobile Station. For correct operation, the 1200 SUPER S must receive the signal, break squelch and display "PUSH TO TALK" on the VFD. Release the Push-To-Talk switch on the Mobile Station. For correct operation, the 1200 SUPER S must squelch and display "RELEASED PTT" on the VFD. A failure to handshake properly between the Mobile Station causes 1200 SUPER S to display "LOST TRANSMITTER" on the VFD.

Testing RIC Interconnect

To test the RIC Interconnect, set the LTR Trunking Parameters, set the MODE Selector Switch to *DUP* and select LTR REPTR RIC as the Trunking Test. When "INPUT" is displayed on the VFD, press +/- until "T/R" is displayed. Press *ENTER*. "PLACE CALL" is displayed on the VFD. On the Mobile Station, enter a DTMF Code and transmit to the 1200 SUPER S. For correct operation, the 1200 SUPER S must receive the signal, break squelch and display "DTMF" on the VFD followed by the programmed DTMF Code. Once the transmission from the Mobile Station is complete, the 1200 SUPER S transmits back to the Mobile Station. Press +/- to display the ID received from the Mobile Station. Press +/- to return to the DTMF Decode Screen. Press Push-To-Talk Key on the Mobile Station followed by DTMF Keys to test the Mobile Station's DTMF Keyboard. Pressing the # Key on the Mobile Station's DTMF Keyboard terminates the call. Once the call is terminated, "CALL TERMINATED" is displayed on the VFD.

At any time before call is terminated, the SINAD of the Mobile Station Receiver Audio can be measured. To measure the SINAD, connect the Receiver Audio output to the EXT MOD/SINAD Connector on the 1200 SUPER S. Set the 1 kHz Tone Selector Switch to INTL and adjust the 1 kHz Tone Level Control as required. Set the Modulation METER Control to *SINAD*. "SINAD ENABLED" is displayed on the VFD and the MODULATION METER displays the SINAD Measurement. Digital display of the meters is not available in this function.

Mobile Station Simulation Applications

Handshake Test

To perform the Handshake Test, the Repeater System can be connected to the 1200 SUPER S in two ways. For Off-The-Air transmission, connect the Repeater System as follows:

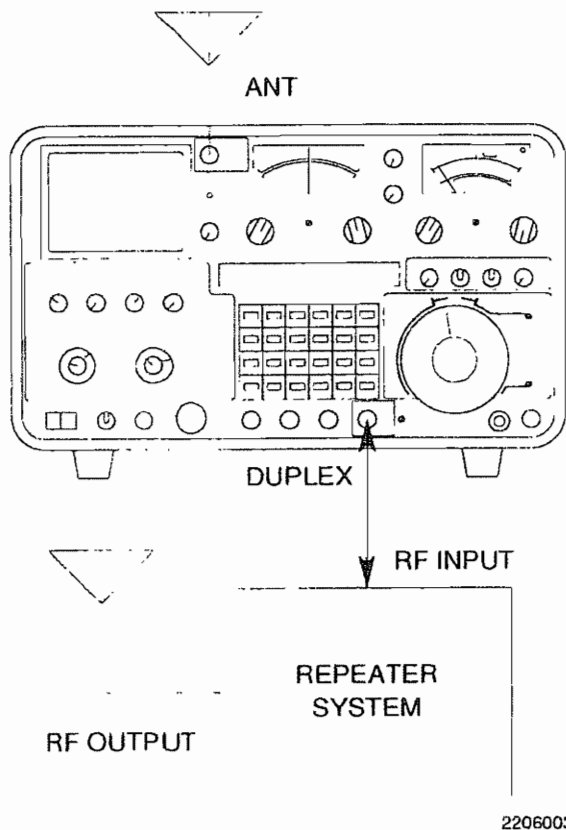

For direct transmission, connect the Mobile Station to the 1200 SUPER S as follows:

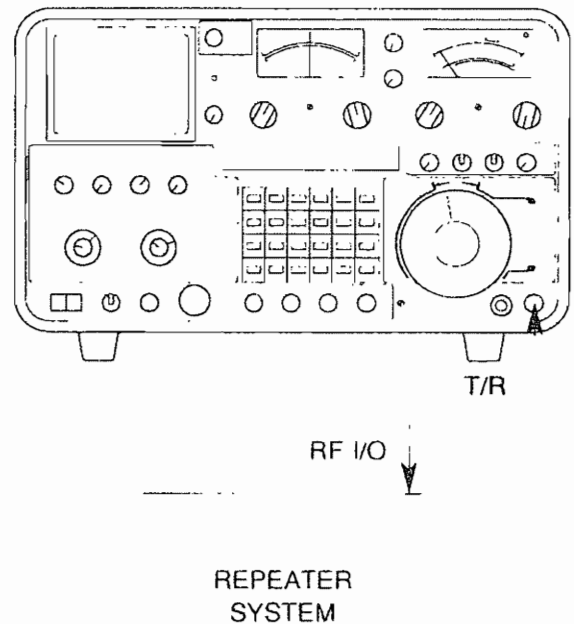

Once the connections are made, set the LTR Trunking Parameters, set the MODE Selector Switch to **DUP** and select LTR MOBILE as the Trunking Test. When "INPUT" is displayed on the VFD, press +/- until the desired output is displayed. Press **ENTER**. "HOME WAITING" is displayed on the VFD. When the 1200 SUPER S receives the correct digital data from the Repeater Under Test, "HOME IDLE" is displayed on the VFD. Press **I** to simulate pressing a Push-To-Talk Key. When the correct return digital data is transmitted from the Repeater Under Test, "H/S RECEIVED" is displayed on the VFD. Press **0** to simulate release of the Push-To-Talk Key. When the 1200 SUPER S receives digital data of PTT Release from the Repeater Under Test, "HOME COMPLETED" is displayed on the VFD. Failure of any communication results in test failure.

Handoff Test

To perform the Handoff Test, connect the Repeater System as follows:

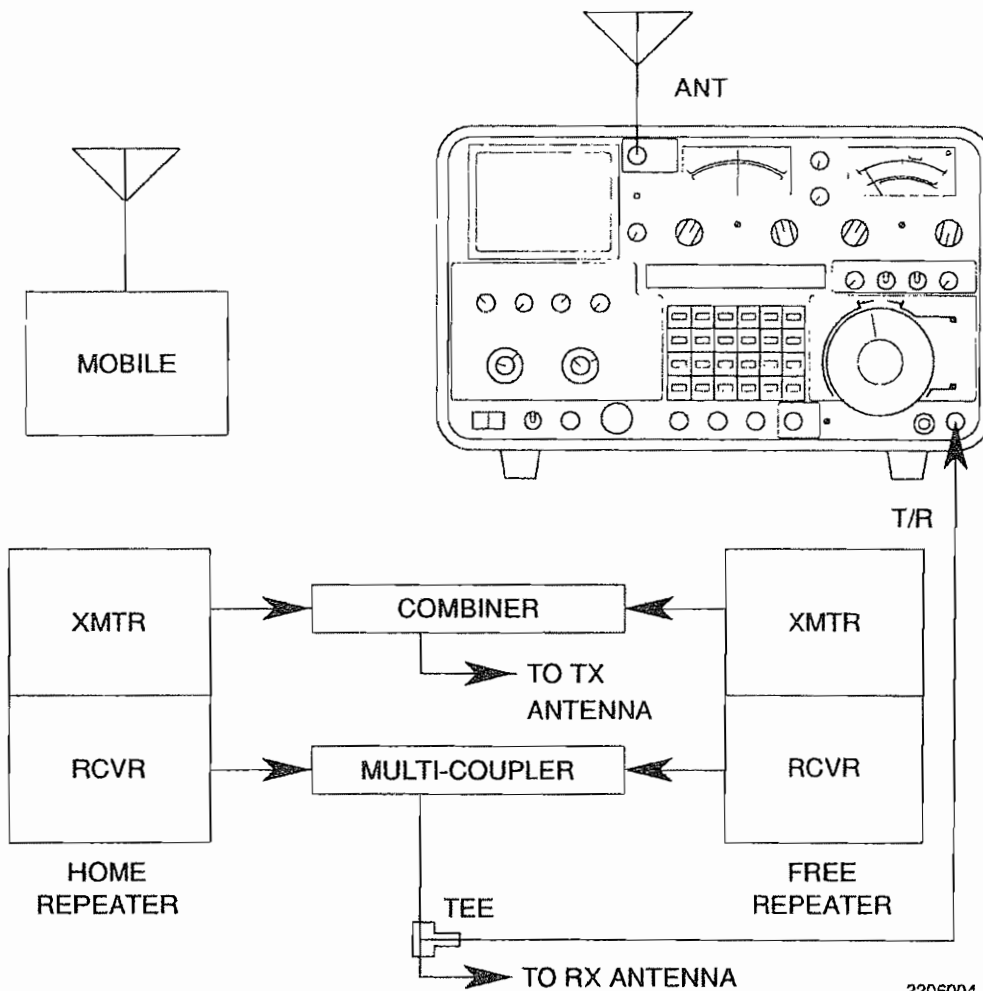

2206004

Once the connections are made, set the LTR Trunking Parameters, set the MODE Selector Switch to **DUP**. Press and hold the Push-To-Talk key on the Mobile Station to utilize the Home Repeater. Select LTR MOBILE as the Trunking Test. When "INPUT" is displayed on the VFD, press +/- until the desired output is displayed. Press **ENTER**. "HOME WAITING" is displayed on the VFD. When the 1200 SUPER S receives the correct digital data from the Home Repeater, "HOME BUSY" is displayed on the VFD. When the 1200 SUPER S receives the message from the Home Repeater, it switches

to the Free Repeater Channel and searches for digital data from the Free Repeater. When correct digital data is received from the Free Repeater, "FREE IDLE" is displayed on the VFD. Press **1** to simulate pressing a Push-To-Talk Key. When the correct return digital data is transmitted from the Free Repeater, "H/S RECEIVED" is displayed on the VFD. Press **0** to simulate release of the Push-To-Talk Key. When the 1200 SUPER S receives digital data of PTT Release from the Repeater Under Test, "FREE COMPLETED" is displayed on the VFD. Failure of any communication results in test failure.

6.7 E-TACS/AMPS MOBILE STATION TEST OPTION

How to Configure Cellular Parameters

To configure the 1200 SUPER S for testing Cellular Mobile Stations perform the following steps:

1. Set the following controls to the specified settings:

MODULATION Selector Control	<i>FM MID</i>
Modulation METER Control	<i>6 kHz/10x10</i>
VAR Tone Selector Switch	<i>INTL</i>
1 kHz Tone Selector Switch	<i>OFF</i>
RF Level Attenuator Control	<i>-50 dBm</i>
MODE Selector Control	<i>GEN</i>

2. Install the Cellular Power Meter as follows:

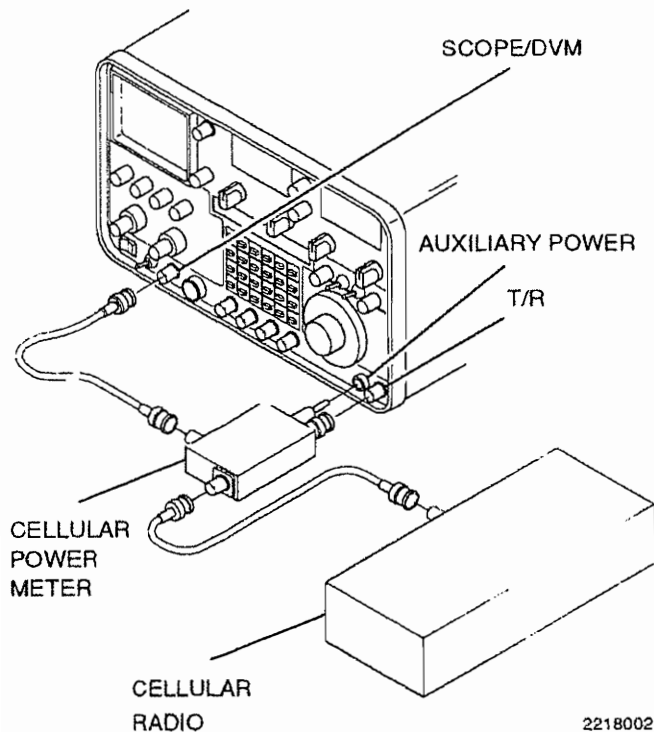

3. Press **TONE**. Set TONE for a 6 kHz sine wave. Press **ENTER**.

4. Adjust VAR Tone Level Control as required for a 2 kHz deviation indication on the MODULATION METER. Set VAR Tone Selector Switch to **OFF**.
5. Set the Modulation METER Switch to the **20 kHz** range. Set the 1 kHz Tone Selector Switch to **INTL**. Adjust the 1 kHz Tone Level Control for an 8 kHz deviation indication on the MODULATION METER. Set the 1 kHz Tone Selector Switch to **OFF**.
6. Set the VAR Tone Selector Switch to **INTL**.
7. Set the MODE Selector Switch to **DUP**.
8. Adjust the VOLUME Control as desired. If the volume is set too high, feedback from the UUT microphone may affect the tested modulation readings.
9. Adjust the SQUELCH Control fully ccw and then cw until the SIG Indicator Lamp goes out.
10. Set the MODE Selector Control to **GEN**.
11. Press **2ND FUNCT**, **TRACK** and **↑** or **↓** Key until "DUPLEX LOW" is displayed on the VFD. Press **ENTER**.
12. Press **PROG**, **2ND FUNCT**, **CELL** and **↑** or **↓** Key until "ID NO." is displayed on the VFD. This parameter is an optional ID Number for use as a test reference and appears on the Test Printout, if enabled. Enter the new ID Number.
13. Press the **↑** Key until "CONTRL CHAN" is displayed. Enter the Control Channel Number for the Station Under Test.

14. Press the ↑ Key until "VOICE CHAN" is displayed. Enter the Voice Channel for the Station Under Test.
15. Press the ↑ Key until "HOME/ROAM = HOME" or "HOME/ROAM = ROAM" is displayed. Press any numeric key to toggle between the two settings.
16. Press the ↑ Key until "MIN" is displayed. Enter the MIN Number of the Mobile Station Under Test.
17. Press the ↑ Key until "FORMAT= AMPS" or "FORMAT= E-TACS" is displayed. Press a numeric key to toggle between the two selections.
18. If ETACS is the selected format, press the ↑ Key until "SN" is displayed. Enter the Serial Number of the Mobile Station. If AMPS is the selected format, press the ↑ Key until "SND" (Decimal Serial Number), "SNO" (Octal Serial Number) or "SNX" (Hexadecimal Serial Number) is displayed. Press +/- until desired format is displayed. Enter the Serial Number of the Mobile Station.
19. Press the ↑ Key until "SAT FREQ" appears followed by the current SAT Frequency. Press any numeric key until desired SAT Frequency is displayed. SAT Frequencies available include 5970, 6000 and 6030 Hz.
20. Press the ↑ Key until "HOME ID" is displayed. Enter the Home ID Number of the Mobile Station.
21. Press the ↑ Key until "DCC" appears followed by the current Digital Color Code. Press any numeric key to toggle between 1, 2 and 3.
22. Press the ↑ Key until "HANDOFF ENABLE" is displayed on the VFD. If "HANDOFF ENABLE" is followed by a "1", then the Handoff Function is enabled. If it is followed by a "0", then the Handoff Function is disabled. Press any numeric key to toggle setting as required. If Handoff Function is not required, skip to Step 27.
23. Press the ↑ Key until "HANDOFF BEG" is displayed. Enter the channel at which the Handoff Function is to begin.
24. Press the ↑ Key until "HANDOFF END" is displayed. Enter the channel at which the Handoff Function is to end.
25. Press the ↑ Key until "HANDOFF INC" is displayed. Enter the increment for the Handoff Function.
26. Press the ↑ Key until "HANDOFF RATE" is displayed. Enter the delay in seconds between handoffs.
27. Press the ↑ Key until "SINAD ENABLE" is displayed. If "SINAD ENABLE" is followed by a "1", then the SINAD Function is enabled. If it is followed by a "0", then the SINAD Function is disabled. Press any numeric key to toggle setting as required. If SINAD Function is not required, skip to Step 29.
28. Press the ↑ Key until "SINAD DB" is displayed. Enter SINAD Level to use as reference for SINAD TEST.
29. Press the ↑ Key until "REG ENABLE" is displayed. If "REG ENABLE" is followed by a "1", then the Registration Test is enabled. If it is followed by a "0", then the Registration Test is disabled. Press any numeric key to toggle setting as required.

30. Press the \uparrow Key until "PRINT ENABLE" is displayed. If "PRINT ENABLE" is followed by a "1", then the Printer Function is enabled. If it is followed by a "0", then the Printer Function is disabled. Press any numeric key to toggle setting as required. If Printer Function is disabled, press *ENTER* to complete the configuration.

31. Press the \uparrow Key until "PASS - FAIL" is displayed. If "PASS - FAIL" is followed by a "1", then the pass/fail test results are printed on by the Printer Function. If it is followed by a "0", then the pass/fail test results are not printed. Press any numeric key to toggle setting as required.

32. Press the \uparrow Key until "SET BAUD" is displayed. Select the desired printer baud rate using number keys. Selections are as follows:

NUMERIC KEY	BAUD
0	110
1	300
2	600
3	1200
4	2400
5	4800
6	9600

33. Press the \uparrow Key until "SET DATA BITS" is displayed followed by current selection. Selections include 7 or 8. Press any numeric key to toggle between the two selections.

34. Press the \uparrow Key until "SET STOP BITS" is displayed followed by current selection. Selections include 1 or 2. Press any numeric key to toggle between the two selections.

35. Press the \uparrow Key until "SET PARITY" is displayed followed by current selection. Selections include ODD, EVEN and NONE. Press any numeric key to toggle between the selections.

36. Press *ENTER* to complete the configuration.

How to Use Meters during Cellular Testing

During Cellular Testing the MODULATION METER and the FREQ ERROR Meter can be used to measure selected Cellular parameters. Measurements made are dependent on Meter settings. Measurements available are as follows:

- SAT Deviation can be measured using the MODULATION METER. The Modulation METER Control must be set to *2 kHz/%x10* or *6 KHz/%x10*.
- Signal Tone (ST) Deviation can be measured using the MODULATION METER. The Modulation METER Control must be set to *20 KHz/%x10* or *60 KHz/%x10*.
- The Mobile Station transmitter frequency error can be measured using the FREQ ERROR Meter. The FREQ ERROR Meter Range Selector must be set for an RF setting.
- The SAT frequency error is measured using the FREQ ERROR Meter. The FREQ ERROR Meter must be set to an AUDIO setting.

If the Mobile Station and the 1200 SUPER S are connected for Manual Testing and "Hxxx PL=y SAT=z" is displayed on the VFD, press *2ND FUNCT* and *METER* to display the digital readings. Press +/- to return to Manual Cellular Testing.

How to Review Test Results

Once Cellular Testing is completed, press *2ND FUNCT* and *CELL* to access test results. Press the \uparrow or \downarrow Key to scroll through the test results.

Applications

Performing a Manual Mobile-to-Cell Site Test

Before performing this test, configure the Cellular Parameters. To perform a Manual Mobile-to-Cell Site Test, press *EXEC*, *2ND FUNCT* and *CELL*. "1=MANUAL 2=AUTO" is displayed on the VFD. Press *1* to select Manual Testing. Press the ↑ or ↓ Key until "PLACE CALL" is displayed. Press *ENTER* to select the test type. "MOBILE INIT" is displayed followed by "PLACE CALL." Once the Mobile Station's indicators show service is available, enter a DTMF Code on the Mobile Station's Keypad and transmit the code to the 1200 SUPER S. If the call is completed, "CALL" is displayed followed by the DTMF code received by the 1200 SUPER S. As many as 11 digits are displayed on the VFD, however the 1200 SUPER S accepts up to 16 digits. Once the call has successfully completed "MOBILE CONNECTED" is displayed. After a pause the VFD will display "PWR ----" to indicate that a power measurement is being taken. After the power measurement is taken, "PWR" is displayed followed by the power measurement in "MW" and "PL" is displayed followed by the Power Level Number of the Mobile Station. This display is then be replaced by the "Hxxx PL=y SAT=z" where xxxx is the Voice Channel Number, y is the Power Level Number and z is a code for the SAT Frequency. SAT Frequency codes are as follows:

SAT=0	5970 Hz
SAT=1	6000 Hz
SAT=2	6030 Hz

All three fields can be edited. The field available for edit flashes. To change between fields press the ← or → Key. Press +/- to return to the this screen if additional testing is performed such as DTMF.

To edit the SAT Frequency, press the ↑ or ↓ Key. Care should be used in changing the SAT Frequency. If the SAT Frequency is changed too quickly, communication can be lost between the Mobile Station and the 1200 SUPER S. To edit the Power Level field, press the ↑ or ↓ Key to set the Mobile Station's Power Level from 0 (highest) through 7 (lowest). The Voice Channel can be changed to simulate a handoff in two ways. The first is to press the ↑ or ↓ Key to increase or decrease the Channel Number by the Handoff Increment that was previously programmed. The second was is to enter the Handoff Channel using Numeric Keys and pressing the ↑ or ↓ Key to activate the handoff. With either method, the VFD displays "HANDOFF TO" and the Handoff Channel Number before returning to the "Hxxx PL=y SAT=z" display where xxxx is now the Handoff Channel Number.

To Terminate testing press • on the 1200 SUPER S or terminate the call on the Mobile Station. "CALL ENDED" is displayed on the VFD.

Manual Cell Site-to Mobile Call (Page Mobile)

Before performing this test, configure the Cellular Parameters. To perform a Manual Cell Site-to-Mobile Test, press **EXEC**, **2ND FUNCT** and **CELL**. "1=MANUAL 2=AUTO" is displayed on the VFD. Press **I** to select Manual Testing. Press the **↑** or **↓** Key until "PAGE MOBILE" is displayed. Press **ENTER** to select the test type. "CELL INIT" is displayed followed by "REGISTRATION" if the Registration Test is enabled. If the Registration Test passes, the Mobile ID Number (MIN) is displayed followed by a pass ("P") or fail ("F") indicator. If the Registration Test was disabled, These two fields are skipped and the unit goes on to the next display. "PAGING MOBILE" replaces the previous display (the MIN Number if Registration was enabled and "CELL INIT" otherwise). If the Mobile Station responds to the page, "PAGE ANSWERED" is displayed and the Mobile Station rings. Once the Mobile Station answers the call, "MOBILE CONNECTED" is displayed. This display is then replaced by "Hxxxx PL=y SAT=z."

This display is then replaced by "Hxxxx PL=y SAT=z." In this field, xxxx is the Voice Channel Number, y is the Power Level Number and z is a code for the SAT Frequency. SAT Frequency codes are as follows:

SAT=0	5970 Hz
SAT=1	6000 Hz
SAT=2	6030 Hz

All three fields can be edited. The field available for edit flashes. To change between fields press the **←** or **→** Key. Press **+/-** to return to the original values once testing is complete.

To edit the SAT Frequency, press the **↑** or **↓** Key. Care should be used in changing the SAT Frequency. If the SAT Frequency is changed too quickly, communication can be lost between the Mobile Station and the 1200 SUPER S. To edit the Power Level field, press the **↑** or **↓** Key to set the Mobile Station's Power Level from 0 (highest) through 7 (lowest). The Voice Channel can be changed to simulate a handoff in two ways. The first is to press the **↑** or **↓** Key to increase or decrease the Channel Number by the Handoff Increment that was previously programmed. The second is to enter the Handoff Channel using Numeric Keys and pressing the **↑** or **↓** Key to activate the handoff. With either method, the VFD displays "HANDOFF TO" and the Handoff Channel Number before returning to the "Hxxxx PL=y SAT=z" display where xxxx is now the Handoff Channel Number.

To Terminate testing press **•** on the 1200 SUPER S or terminate the call on the Mobile Station. "CALL ENDED" is displayed on the VFD.

SINAD Measurement during Manual Test

The SINAD of the Mobile Station Receiver Audio can be measured during Manual Testing. SINAD must be measured after the 1200 SUPER S and the Mobile Station have connected and "Hxxxx PL=y SAT=z" is displayed on the VFD. To make a SINAD Measurement, connect the Mobile Station Receiver Audio output to the EXT MOD/SINAD Connector. Set the MODULATION Meter Control to *SINAD*. Set the 1 kHz Tone Selector Switch to *INTL*. Press *2ND FUNCT* and *METER* to display digital SINAD Meter reading. Adjust the RF Level Attenuator Vernier Control and the RF Level Attenuator Control until meter reading displays desired SINAD reading. To return to the Manual Cellular Test, set the 1 kHz Tone Selector Switch to "OFF", disconnect Mobile Station Receiver Audio output from the EXT MOD/SINAD Connector and press +/-.

Decoding DTMF Digits During Manual Test

The Mobile Station DTMF Keypad can be measured during Manual Testing. The Keypad must be tested after the 1200 SUPER S and the Mobile Station are connected and "Hxxxx PL=y SAT=z" is displayed on the VFD. To test the DTMF Keypad, press *DTMF*. "DTMF" is displayed on the VFD. Press the keys on the Mobile Station Keypad. DTMF digits are displayed on the VFD as each digit is pressed. To return to the Manual Cellular Test, press +/-.

Performing a Flash Hook Test

A Flash Hook Test can be performed during Manual Testing. The Flash Hook Test must be performed after the 1200 SUPER S and the Mobile Station are connected and "Hxxxx PL=y SAT=z" is displayed on the VFD. To perform a Flash Hook Test, press the "SEND" or Flash Hook Key on the Mobile Station. The 1200 SUPER S displays "FLASH HOOK" on the VFD when the Flash Hook Message is received. To return to the Manual Cellular Test, press +/-.

Checking Voice Deviation

The maximum Voice Deviation of the Mobile Station can be measured during Manual Testing. Voice Deviation must be measured after the 1200 SUPER S and the Mobile Station are connected and "Hxxxx PL=y SAT=z" is displayed on the VFD. To make the Voice Deviation Measurement, set the VERTICAL Attenuator Selector Control for *5 KHz/%x10*. Set the HORIZONTAL Sweep Selector Control to *1 ms/DIV*. Turn the VOLUME Control fully ccw. Turn the 1 KHz Tone Level Control fully ccw. Set the 1 KHz Tone Selector Switch to *SPKR*. With the Mobile Station MIC unmuted, hold the MIC close to the 1200 SUPER S Speaker and turn the 1 KHz Tone Level Control until the signal observed on the Oscilloscope no longer increases in level. Measure the Voice Deviation on the Oscilloscope.

During this test the SAT is also visible on the Oscilloscope and low level feedback may occur when the handset is held close to the 1200 SUPER S Speaker.

To return to the Manual Cellular Test, set the 1 kHz Tone Selector Switch to "OFF" and press +/-.

Making a Supervisory Audio Tone (SAT) Measurement

This procedure requires specific Maintenance Instructions for the Mobile Station. To perform a SAT Measurement, configure the Cellular Parameters, connecting the UUT output directly to the T/R Connector. Set the MODE Selector Switch to *REC*. Set the Modulation METER Control to *6 KHz/%x10*. Set the 1200 SUPER S for Cellular Reverse Channel operation and enter the selected Voice Channel. Using the Maintenance Instructions for the Mobile Station, set the Mobile Station to transmit the SAT at the selected Voice Channel. Press *EXEC*, *2ND FUNCT* and *CELL*. "1=MANUAL 2=AUTO" is displayed on the VFD. Press *1* to select Manual Testing. Press the ↑ or ↓ Key until "SAT TONE" is displayed. Press *ENTER* to select the test type. The SAT TONE is displayed on the MODULATION METER. To display the SAT on the VFD, press *2ND FUNCT* and *METER*.

Making a Signal Tone Measurement

This procedure requires specific Maintenance Instructions for the Mobile Station Under Test. To perform a Signal Tone Measurement, configure the Cellular Parameters, connecting the UUT output directly to the T/R Connector. Set the MODE Selector Switch to *REC*. Set the Modulation METER Control to *6 KHz/%x10*. Set the 1200 SUPER S for Cellular Reverse Channel operation and enter the selected Voice Channel. Using the Maintenance Instructions for the Mobile Station, set the Mobile Station to transmit the Signal Tone at the selected Voice Channel. Press *EXEC*, *2ND FUNCT* and *CELL*. "1=MANUAL 2=AUTO" is displayed on the VFD. Press *1* to select Manual Testing. Press the ↑ or ↓ Key until "SAT TONE" is displayed. Press *ENTER* to select the test type. The SAT Frequency is displayed on the MODULATION METER. To display the SAT on the VFD, press *2ND FUNCT* and *METER*.

Performing a No-Coax Mobile-To-Cell Call

A Mobile Station-to-Cell Site Test can be performed without using coaxial cables. This test should be performed in a shielded environment. To Conduct a No-Coax Mobile-To-Cell Call, connect antennas to the DUPLEX Connector and the ANT Connector. Press *2ND FUNCT*, *TRACK* and the ↑ or ↓ Key until "DUPLEX HIGH" is displayed. Press *ENTER*. Configure the Cellular Parameters without connecting the Mobile Station to the 1200 SUPER S. Press *EXEC*, *2ND FUNCT* and *CELL*. "1=MANUAL 2=AUTO" is displayed on the VFD. Press *1* to select Manual Testing. Press the ↑ or ↓ Key until "NO COAX CALL" is displayed. Press *ENTER* to select the test type. "MOBILE INIT" is displayed and the remainder of the test is identical to the test using coaxial cables, however, the Power Measurements are invalid.

Performing a No-Coax Cell-To-Mobile Call

A Cell Site-To-Mobile Station Test can be performed without using coaxial cables. This test should be performed in a shielded environment. To Conduct a No-Coax Cell-To-Mobile Call, connect antennas to the DUPLEX Connector and the ANT Connector. Press *2ND FUNCT*, *TRACK* and the ↑ or ↓ Key until "DUPLEX HIGH" is displayed. Press *ENTER*. Configure the Cellular Parameters without connecting the Mobile Station to the 1200 SUPER S. Press *EXEC*, *2ND FUNCT* and *CELL*. "1=MANUAL 2=AUTO" is displayed on the VFD. Press *1* to select Manual Testing. Press the ↑ or ↓ Key until "NO COAX PAGE" is displayed. Press *ENTER* to select the test type. "REGISTRATION" is displayed and the remainder of the test is identical to the test using coaxial cables, however, the Power Measurements are invalid.

Performing Manual Registration

To Perform the Manual Registration Test, configure the Cellular Parameters, connecting the UUT output directly to the T/R Connector. Press *EXEC*, *2ND FUNCT* and *CELL*. "1=MANUAL 2=AUTO" is displayed on the VFD. Press *1* to select Manual Testing. Press the \uparrow or \downarrow Key until "REGISTRATION" is displayed. Press *ENTER* to select the test type and start the test. If the test passes and the 1200 SUPER S successfully completes the Registration Test, "MIN," followed by the Mobile ID Number of the Mobile Station and a "P" (Pass) are displayed. If the 1200 SUPER S cannot successfully complete a Registration Test, "REGISTRATION F" is displayed.

If Printer Function was enabled in the configuration process, the following is passed to the printer:

```
***** IFR FM/AM 1200S AMPS CELLULAR MOBILE AUTO TEST *****
* NAME _____ DATE _____
* MOBILE I.D. NUMBER - 2340729457 USER ID# 000
* MOBILE SERIAL NUMBER - 13000645849 HEX: 8209DAD9 OCT: 20202355331
* HOME ID - 00020 SCM - 01010 SAT - 5970 HZ DCC - 0 [HOME]
* POWER CLASS III CONTINUOUS BANDWIDTH = 25 MHZ *
```

Performing a Cellular Auto Test

The Cellular Auto Test automatically performs the following Tests:

- Registration
- Mobile-To-Cell Call
- SINAD Test (if enabled)
- Cell-To-Mobile Call
- Power Level 0 to 7 Measurement
- Handoff Test (if enabled)
- Supervisory Audio Tone (SAT) Measurement
- Signal Tone (ST) Measurement

Before performing this test, configure the Cellular Parameters. To perform an Auto Manual Cell Site-to-Mobile Test, press **EXEC**, **2ND FUNCT** and **CELL**. "1=MANUAL 2=AUTO" is displayed on the VFD. Press 2 to select Automatic Testing. The test immediately starts and "REGISTRATION" is displayed. If the Registration Test passes, "MIN", the Mobile ID Number and "P" are displayed. If the Registration Test fails, "REGISTRATION F" is displayed. Once the Registration Test is complete, "PLACE CALL" is displayed. Once the Mobile Station recognizes that service is available, transmit a DTMF Code "CALL" and the DTMF Code, followed by "MOBILE CONNECTED" are displayed.

If the SINAD Test is enabled, "xxDB SINAD = yyy" is displayed, where xx is the desired SINAD level and yyy is the Generate Level of the 1200 SUPER S. To continue with the SINAD Test, connect the Mobile Station Audio output to the EXT MOD/SINAD Connector. The EXT MOD/SINAD input range is .25 to 2 VRMS. Place the 1 kHz Tone Selector Switch to **INTL**. Adjust the RF Level Attenuator Control and the RF Level Vernier Attenuator Control for a MODULATION METER SINAD Reading of "xxDB." Enter the RF Level of the 1200 SUPER S using the Numeric Keys. Set the 1 kHz Tone Selector Switch to **OFF** and disconnect the audio input from the EXT MOD/SINAD Connector. Press **ENTER** to complete the operation.

After completion of the SINAD Test or if the SINAD Test is disabled, after "MOBILE CONNECTED" is displayed, "CALL ENDED" is displayed and the 1200 SUPER S terminates the connection. "PAGING MOBILE" is displayed, next, to indicate the start of the Cell-To-Mobile Call. Once the Mobile Station rings, answer the call. "MOBILE CONNECTED" is displayed. The 1200 SUPER S then conducts power level checks for Power Level Settings of 0 through 7. Once the test is completed "POWER LEVEL" is displayed followed by a pass ("P") or fail ("F") indicator. The 1200 SUPER S starts the Handoff Test and "HANDOFF TO hhhh" is displayed with hhhh indicating the current Handoff Channel. At the completion of the test, "HANDOFF TEST" is displayed followed by a pass ("P") or fail ("F") indicator. "TEST RESULT" is then displayed followed by a pass ("P") or fail ("F") indicator to indicate whether the composite test passed or failed.

If Printer Output is enabled, test reports are passed to the printer. Typical test reports for both AMPS and ETACS formats are as follows:

```

***** IFR FM/AM 1200S AMPS CELLULAR MOBILE AUTO TEST *****
* NAME _____ DATE _____ *
* MOBILE I.D. NUMBER - 2340729457 USER ID# 000 *
* MOBILE SERIAL NUMBER - 13000645849 HEX: 8209DAD9 OCT: 20202355331 *
* HOME ID - 00020 SCM - 01010 SAT - 5970 HZ DCC - 0 [HOME] *
* POWER CLASS III CONTINUOUS BANDWIDTH = 25 MHZ *
***** MOBILE INITIATED CALL*****
* CALLED NUMBER 123 *
* CHANNEL = 1023 825.0000/870.0000 MHZ *
* FREQ. ERROR +0.295 KHZ *
* DEVIATION 1.960 KHZ SAT ONLY *
* TRANSMITTER POWER 793.1 mW *
* HANGUP DEVIATION 09.46 KHZ ST + SAT *
***** 12 dB SINAD TEST *****
* ATTENUATOR READING = -116 dBM -OR- 0.3 μV *
***** POWER LEVEL TEST *****
* LEVEL POWER READING PASS/FAIL *
* 0 797.5 mW F *
* 1 801.8 mW F *
* 2 801.8 mW F *
* 3 358.5 mW F *
* 4 167.0 mW F *
* 5 56.7 mW F *
* 6 24.2 mW F *
* 7 9.9 mW P *
***** HAND-OFF TEST *****
* CHANNEL = 222 831.6600/876.6600 MHZ *
* FREQ. ERROR +0.292 KHZ *
* DEVIATION 1.956 KHZ SAT ONLY *
* TRANSMITTER POWER 876.8 mW *
***** CELL INITIATED CALL *****
* CHANNEL = 1023 825.0000/870.0000 MHZ *
* FREQ. ERROR +0.296 KHZ *
* DEVIATION 1.970 KHZ SAT ONLY *
* TRANSMITTER POWER 797.5 mW *
* RING DEVIATION 09.54 KHZ ST + SAT *
* HANGUP DEVIATION 09.42 KHZ ST + SAT *
*****

```

```

***** IFR FM/AM 1200S E-TACS CELLULAR MOBILE AUTO TEST *****
* NAME _____ DATE _____ *
* MOBILE I.D. NUMBER - 2340729457 USER ID# 000 *
* MOBILE SERIAL NUMBER - 03/05/00/08081 HEX: 1F910143 OCT: 03744200503 *
* HOME ID - 02051 SCM - 00001 SAT - 5970 HZ DCC - 0 [HOME] *
* POWER CLASS 2 CONTINUOUS EQUIPPED FOR 1000 CHANNELS *
***** MOBILE INITIATED CALL*****
* CALLED NUMBER 123 *
* CHANNEL = 333 898.3125/943.3125 MHZ *
* FREQ. ERROR -0.245 KHZ *
* DEVIATION 1.338 KHZ SAT ONLY *
* TRANSMITTER POWER 2125.0 mW *
* HANGUP DEVIATION 08.12 KHZ ST + SAT *
***** 12 dB SINAD TEST *****
* ATTENUATOR READING = -116 dBM -OR- 0.3 uV *
***** POWER LEVEL TEST *****
* LEVEL POWER READING PASS/FAIL *
* 0 2132.0 mW F *
* 1 935.9 mW F *
* 2 367.7 mW F *
* 3 142.7 mW F *
* 4 58.3 mW F *
* 5 23.6 mW F *
* 6 9.0 mW F *
* 7 4.0 mW P *
***** HAND-OFF TEST *****
* CHANNEL = 222 895.5375/940.5375 MHZ *
* FREQ. ERROR -0.204 KHZ *
* DEVIATION 1.366 KHZ SAT ONLY *
* TRANSMITTER POWER 2220.0 mW *
***** CELL INITIATED CALL *****
* CHANNEL = 1023 898.3125/943.3125 MHZ *
* FREQ. ERROR -0.203 KHZ *
* DEVIATION 1.360 KHZ SAT ONLY *
* TRANSMITTER POWER 2132.0 mW *
* RING DEVIATION 08.06 KHZ ST + SAT *
* HANGUP DEVIATION 08.06 KHZ ST + SAT *
*****

```

APPENDICES

APPENDIX A - SPECIFICATIONS

(Specifications and Features are Subject to Change without Notice)

RF SIGNAL GENERATOR

Frequency:

Range: 250 kHz to 999.9999 MHz
Resolution: 100 Hz
Accuracy: ± 5 Hz + Master Oscillator

Level:

Range: -127.0 to -20.0 dBm (10 dB steps with 11 dB range vernier)
Accuracy: ± 2.5 dB

Variable Generate:

± 10 kHz

Output Impedance:

50 Ω

Spectral Purity:

Residual FM: <100 Hz RMS (300 Hz to 3 kHz Bandwidth)
Harmonics: <-25 dBc
Non-Harmonics and Spurious (at offset from selected frequency):
 ± 10 kHz to ± 1.5 MHz: ≤ -30 dBc in band
 ± 15 MHz to band end: ≤ -55 dBc
(IF image ≤ -35 dB)

RF SIGNAL MODULATION

Internal Modulation:

Deviation Range: 0 to 50 kHz (with 1 kHz tone)
% AM Range: 0% to 90% (with 1 kHz tone)

External Modulation:

Frequency Response: FM: Hz to 30 kHz (DC when in variable generate)
AM: 10 Hz to 10 kHz (30% maximum modulation above 5 kHz)

Modulation Sensitivity: FM: 0.1 VRMS/kHz (-0 to +30%)
AM: 0.01 VRMS/% (-0 to +30%)

Distortion (at 1 kHz sine):

FM: <1% to 20 kHz deviation
AM: <10% to 60% modulation

Input Impedance:

10 k Ω (nominal)

RECEIVE/MONITOR

Frequency Range:

100 kHz to 999.9999 MHz in 100 Hz increments

Sensitivity:

2 μ V typical (1 to 1000 MHz FM narrow)

Selectivity (at 3 dB):

<u>MODE</u>	<u>RECEIVER BANDWIDTH</u>	<u>AUDIO BANDWIDTH</u>
FM WIDE	200 kHz	80 kHz
FM MID	200 kHz	8 kHz
FM NAR	15 kHz	8 kHz
SSB	6 kHz	8 kHz

RECEIVE/MONITOR (CONTINUED)

Selectivity (at 3 dB):	<u>MODE</u>	<u>RECEIVER BANDWIDTH</u>	<u>AUDIO BANDWIDTH</u>
	AM NAR	6 kHz	8 kHz
	AM NORM	15 kHz	8 kHz
Adjacent Channel Rejection:	<u>RECEIVER BANDWIDTH</u>	<u>GREATER THAN 40 dB DOWN</u>	
	200 kHz	±300 kHz	
	15 kHz	±27 kHz	
	6 kHz	±15 kHz	
Demodulation Output:			
Impedance:	600 Ω		
Output Level:	Into an open circuit FM: 60 mVRMS/1 kHz (nominal) AM: 5 mVRMS/% (nominal)		
Receiver Antenna Input Protection:	0.25 W (maximum without damage)		

DUPLEX GENERATOR

Frequency Range:	±49.99 MHz from receive frequency in 10 kHz steps
Frequency Resolution:	2.5 kHz
Frequency Accuracy:	(See Master Oscillator)
Duplex Output Level:	
Duplex High:	-15 dBm into 50 Ω ±10 dB
Duplex Low	-40 dBm into 50 Ω (-25 dB [±5 dB] below Duplex High at the same frequency)
Input Protection	0.25 W (maximum without damage)
T/R Port:	-85 dBm (±10 dB) fixed level

FUNCTION GENERATOR

Functions	SINE, SQUARE, RAMP, TRIANGLE, TTL, DTMF, TONE SEQ and DCS
Tone Accuracy:	
Fixed:	(Same as Master Oscillator)
Variable:	±0.01%
Tone Distortion:	(At 2.5 VRMS output)
Fixed:	<0.5%
Variable (SINE):	<2% (10 to 100 Hz) <0.7% typical (100 Hz to 30 Hz)
Tone Output Level:	Variable to 2.5 VRMS minimum, either tone, into 150 Ω load
Frequency Range (Variable):	10 Hz to 100 kHz in 0.1 Hz increments

FUNCTION GENERATOR (CONTINUED)

DTMF ENCODE:

Deviation: 3.5 kHz Fixed (± 500 Hz)
Mark Time: 50 ms Minimum
Space Time: 50 ms Minimum

DTMF DECODE: See Digital Voltmeter

MODULATION METER

FM Deviation:

Accuracy: $\pm 5\%$ of reading
 $\pm 3\%$ of full scale for a 1 kHz tone
Ranges: 2, 6, 20 and 60 kHz full scale

AM % Modulation:

Accuracy: $\pm 5\%$ of reading
 $\pm 3\%$ full scale for a 1 kHz tone
Ranges: 20%, 60%, 200% full scale

FREQUENCY ERROR METER

RF Accuracy:

\pm Master Oscillator
 $\pm 3\%$ of full scale

RF Ranges:

± 10 kHz, ± 3 kHz, ± 1 kHz, ± 300 Hz,
 ± 100 Hz and ± 30 Hz full scale

Audio Counter:

Frequency Range: 10 Hz to 12 kHz
Accuracy: $\pm 0.01\%$ $\pm 3\%$ full scale
Ranges: ± 300 , ± 30 and ± 3 Hz full scale

SINAD/DISTORTION METER

SINAD:

3 to 20 dB at 1 kHz

Accuracy: ± 1 dB at 12 dB SINAD

Distortion Range:

0 to 20% at 1 kHz

Accuracy: $\pm 1\%$ at 10% distortion

Input Level:

0.25 to 2 VRMS (10 VRMS maximum)

Impedance:

10 k Ω (nominal)

POWER METER

Range:

0 to 15 and 0 to 150 W peak or average responding

Accuracy:

1 to 600 MHz, $\pm 7\%$ of reading, $\pm 3\%$ of full scale
600 to 1000 MHz, $\pm 20\%$ of reading, $\pm 3\%$ full scale

Input Power:

50 W continuous
>50 to 150 W, one minute "ON", five minutes
"OFF"

OSCILLOSCOPE

Display Size: 2 inches X 2.5 inches
Vertical Bandwidth: DC to 1 MHz (at 3 dB Bandwidth)
External Vertical Input Ranges: 10 mV, 100 mV, 1 V and 10 V per division
Horizontal Sweep Rate: 10 ms, 1 ms, 100 μ s and 10 μ s per division

SPECTRUM ANALYZER

Log Scale: Within ± 2 dB linearity from -30 to -90 dBm indication
Dynamic Range: 70 dB (from display reading of -30 to 100)

Modes:	<u>SCAN WIDTH</u>	<u>BANDWIDTH</u>
	1 MHz/DIV	30 kHz
	500 kHz/DIV	30 kHz
	200 kHz/DIV	30 kHz
	100 kHz/DIV	30 kHz
	50 kHz/DIV	30 kHz
	20 kHz/DIV	3 kHz
	10 kHz/DIV	3 kHz
	5 kHz/DIV	3 kHz
	2 kHz/DIV	300 Hz
	1 kHz/DIV	300 Hz

DIGITAL VOLTMETER/DTMF DECODE

AC Volts:
Frequency Range: 45 Hz to 10 kHz
Voltage Range: 0 to 100 VRMS
Accuracy: $\pm 10\% \pm 2$ Counts
DC Volts:
Voltage Range: 0 to 100 Vdc
Accuracy: $\pm 10\% \pm 2$ Counts
DTMF DECODE:
Deviation: 1 kHz Minimum
Mark Time: 50 ms Minimum
Space Time: 50 ms Minimum
Sensitivity: 20 dB FM Quieting

MASTER OSCILLATOR

Standard TCXO:
Stability: 0.2 PPM (0° - 50°C)
Aging: 0.5 PPM per year
Optional Oven Oscillator:
(Option 2)
Stability: 0.05 PPM (0° - 50°C)

MASTER OSCILLATOR (CONTINUED)

Optional Oven Oscillator: (Option 2)
Aging: 0.25 PPM per year

GENERATE AMPLIFIER (OPTIONAL)

Gain: 30 dB (± 2 dB) typical, 250 kHz to 1000 MHz
Test Set Output with
Amplifier Installed: Variable to +10 dBm, FM, CW
Variable to +4 dBm, AM

TRACKING GENERATOR (OPTIONAL)

Frequency Range: 1 to 999.9999 MHz
Output Level and Accuracy:
TRACK HIGH: -5 dBm (+3/-5 dB)
TRACK MED: -15 dBm (± 7 dB)
TRACK LOW: -40 dBm (+5/-10 dB)
Flatness: ± 1 dB over center 80% of displayed area,
 ± 5 dB over remaining display
Tracking Span: 10 kHz to 10 MHz as set by Spectrum Analyzer scan width
Output Impedance: 50 Ω (nominal)
Spurious: Harmonic and Non-Harmonic are < 5 dBc, typically
10 dB. Image (RF + 180 MHz) typically 0 dBc
Dynamic Range: 70 dB
Tracking Range Adjustment: -200 Hz to 1.0 kHz minimum as compared to analyzer
center

GENERAL CHARACTERISTICS

Temperature Range: 0 to 50°C

POWER REQUIREMENTS

Line: 105 to 130/210 to 260 VAC
50 to 400 Hz at 60 W typical
External DC: 12 to 30 Vdc nominal, 3.5 A at 12 V typical,
1.5 A at 28 V typical

APPENDIX B - TABLE OF USER I/O PORTS AND CONNECTOR PIN-OUT TABLES

B.1 USER I/O PORTS

CONNECTOR NAME/TYPE		SIGNAL INPUT/OUTPUT/TYPE	
T/R	BNC	Input/Output	RF: -20 dB Out, Max 150 W In
AUX PWR	Banana	Output GEN Mode Only	+12 VDC at 100 mA
DUPLEX	BNC	Output	RF
EXT MOD/SINAD	BNC	Input	Audio
DEMOD	BNC	Output	Audio
TONE OUT	BNC	Output	Audio
MIC/ACC	5-Pin Microphone Connector	Input/Output	See Pin-Out
SCOPE/DVM	BNC	Input 100 V Max	DC to 1 MHz AC or DC
ANT	BNC	Input	RF
RS-232 (Standard)	25-Pin, Type D	Input/Output	See Pin-Out
GPIB (Option 13)	24-Pin, IEEE 1978	Input/Output	See Pin-Out
AC Power	EAC-301	Input	105-130 VAC 210-260 VAC
DC Power	712A	Input	12-30 Vdc
External Reference	BNC	Input/Output	10 MHz RF

Table of I/O Ports

B.2 PIN OUT FOR MIC/ACC CONNECTOR

PIN NUMBER	SIGNAL NAME	SIGNAL TYPE	INPUT/OUTPUT
1	+12 Vdc	DC Voltage	1/8 A Fused Output
2	Chassis GND		
3	Mic Key	Switched	GND for Generate
4	Mic Audio	Audio	Input
5	Tone Key	Switched	GND to Remove Variable Tone

MIC/ACC Connector Pin Assignments

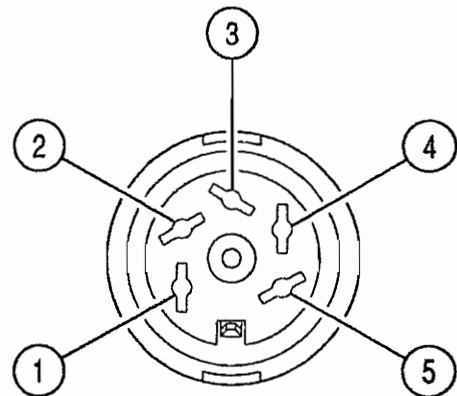

2206006

MIC/ACC Connector Pin Identification (Front View)

B-3 PIN-OUT TABLE FOR RS-232 CONNECTOR

PIN NUMBER	INPUT/OUTPUT	REMARKS
2 (RDX)	Commands	
3 (TDX)	Info	
4 (RTS)		If high, 1200 SUPER S can receive command. If low, 1200 SUPER S busy.
5 (CTS) 6 (DSR) (Pin 5 & 6 tied together)		If low, terminal not ready to receive. If not used, it must be tied high.
7 (Common Ground)		
1, 8 thru 25 not used		

RS-232 Connector Pin Assignments (Standard)

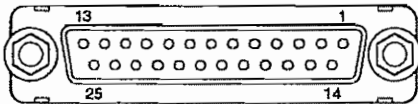

2206007

RS-232 Connector Pin Identification

1200 SUPER S PROTOCOL

No Parity Must be Half Duplex Must be Upper Case 8 Data Bits Per Character	Bit 8 Must be Zero (Most Significant Bit) 1 Stop Bit (End of Character) High Level = +12 V Low Level = -12 V
PIN NUMBER	ASSIGNMENT
7	Common Ground
13	CTS
14	RDX
16	TDX
19	RTS

RS-232 Pin Assignments with Option 15 Installed

B.4 PIN-OUT TABLE FOR GPIB CONNECTOR (OPTION 13)

When the GPIB Option (Option 13) is installed, a 24-Pin Connector is provided in place of the RS-232 Connector on the rear panel for connection to an external controller. Pin-Outs are shown in the table below. The operator should ensure proper interface between the 1200 SUPER S and the external controller. After the proper connection is made, the 1200 SUPER S can be initialized with the proper address using the GPIB Menu.

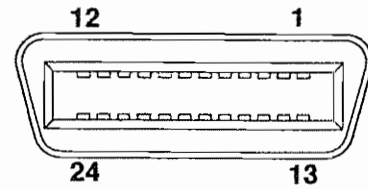

2206008

GPIB (Option 13) Connector Pin Identification

PIN NUMBER	SIGNAL	PIN NUMBER	SIGNAL
1	DIO 1	13	DIO 5
2	DIO 2	14	DIO 6
3	DIO 3	15	DIO 7
4	DIO 4	16	DIO 8
5	EOI	17	REN
6	DAV	18	Ground
7	NRFD	19	Ground
8	NDAC	20	Ground
9	IFC	21	Ground
10	SRQ	22	Ground
11	ATN	23	Ground
12	Ground	24	Ground

Pin-Out Table for GPIB Connector (Option 13)

APPENDIX C - ABBREVIATIONS

	A	DTMF	Dual Tone Multi-Frequency
A	Ampere	DVM	Digital Voltmeter
ac or AC	Alternating Current		E
AF	Audio Frequency	E-TACS	Enhanced Total Access Communications System
AMPS	Advanced Mobile Phone System	ESD	Electrostatic discharge
ANSI	American National Standards Institute	EXT MOD	External Modulation
ANT	Antenna		F
ASCII	American National Standard Code for Information Interchange	freq	Frequency
Avg	Average	FWD	Forward
	B		G
BATT	Battery	GEN	Generate
bps	Bit per second	GND	Ground
	C	GPIB	General Purpose Interface Bus
CCITT	International Consultative Committee for Telephone and Telegraph		H
ccw	Counterclockwise	HORIZ	Horizontal
cw	Clockwise	Hz	Hertz
CRT	Cathode Ray Tube	Hex	Hexadecimal
CTCSS	Continuous Tone-Coded Squelch System	Id	Identification
	D	ISDN	Integrated Services Digital Network
dB	Decibel	IEEE	Institute of Electrical and Electronic Engineers
dBc	Decibels relative to carrier	INTL	Internal
dBm	Decibels relative to 1 milliwatt	I/O	Input/Output
dc or DC	Direct Current		K
DCS	Digitally Coded Squelch	kbps	Kilobits per second

kHz	Kilohertz (1000 Hertz)		S
	L	sec	Second
lvl	Level	SIG	Signal
	M	SPKR	Speaker
MHz	Megahertz (1000000 Hertz)	SSB	Single Sideband
MIC	Microphone Source		T
min	Minute	T/R	Transmit/Receive
MIN	Mobile Identification Number		U
ms	Millisecond	UUT	Unit Under Test
mV	Millivolt		V
mVp-p	Millivolt peak to peak		
mW	Milliwatt	VERT	Vertical
	P	V	Volt
Pk	Peak	VAC	Alternating current voltage
POS	Position	Vdc	Direct current voltage
ppm	Part per million	VFD	Vacuum Fluorescent Display
PWR	Power (switch)	Vp-p	Volt peak to peak
	R	VSWR	Voltage standing wave ratio
RCVR	Receiver		W
REC	Receive	W	Watt
Recap	Recapture		
Ret	Return		
REV	Reverse		
RF	Radio Frequency		
RF Pwr Lvl	RF Power Level		
rms	Root Mean Square		

APPENDIX D - REPACKING FOR SHIPMENT

D.1 SHIPPING INFORMATION

IFR Test Sets returned to factory for calibration, service or repair must be repackaged and shipped subject to the following conditions:

AUTHORIZATION

Do not return any products to factory without authorization from IFR Customer Service Department.

CONTACT: IFR Systems, Inc.
Customer Service Dept.
10200 West York Street
Wichita, Kansas 67215-8935

Telephone: 800-835-2350
TWX: 910-741-6952

TAGGING TEST SETS

All test sets must be tagged with:

- Owner's identification and address.
- Nature of service or repair required.
- Model No. and Serial No.

SHIPPING CONTAINERS

Test Sets must be repackaged in original shipping containers using IFR packing materials. If original shipping containers and materials are not available, contact IFR Customer Service Department for shipping instructions.

FREIGHT COSTS

All freight costs on non-warranty shipments are assumed by the customer. (See "Warranty Packet" for freight charge policy on warranty claims.)

D.2 REPACKING PROCEDURE

- Make sure bottom packing mold is seated on floor of shipping container.
- Adjust handle to lay unlocked against Test Set.
- Carefully wrap Test Set with polyethylene sheeting.
- Place Test Set into shipping container, making sure Test Set is securely seated in bottom packing mold.
- Place top packing mold over top of Test Set and press down until mold rests solidly on bottom packing mold.
- Close shipping container lids and seal with shipping tape or an industrial stapler. Tie all sides of container with break resistant rope, twine or equivalent.

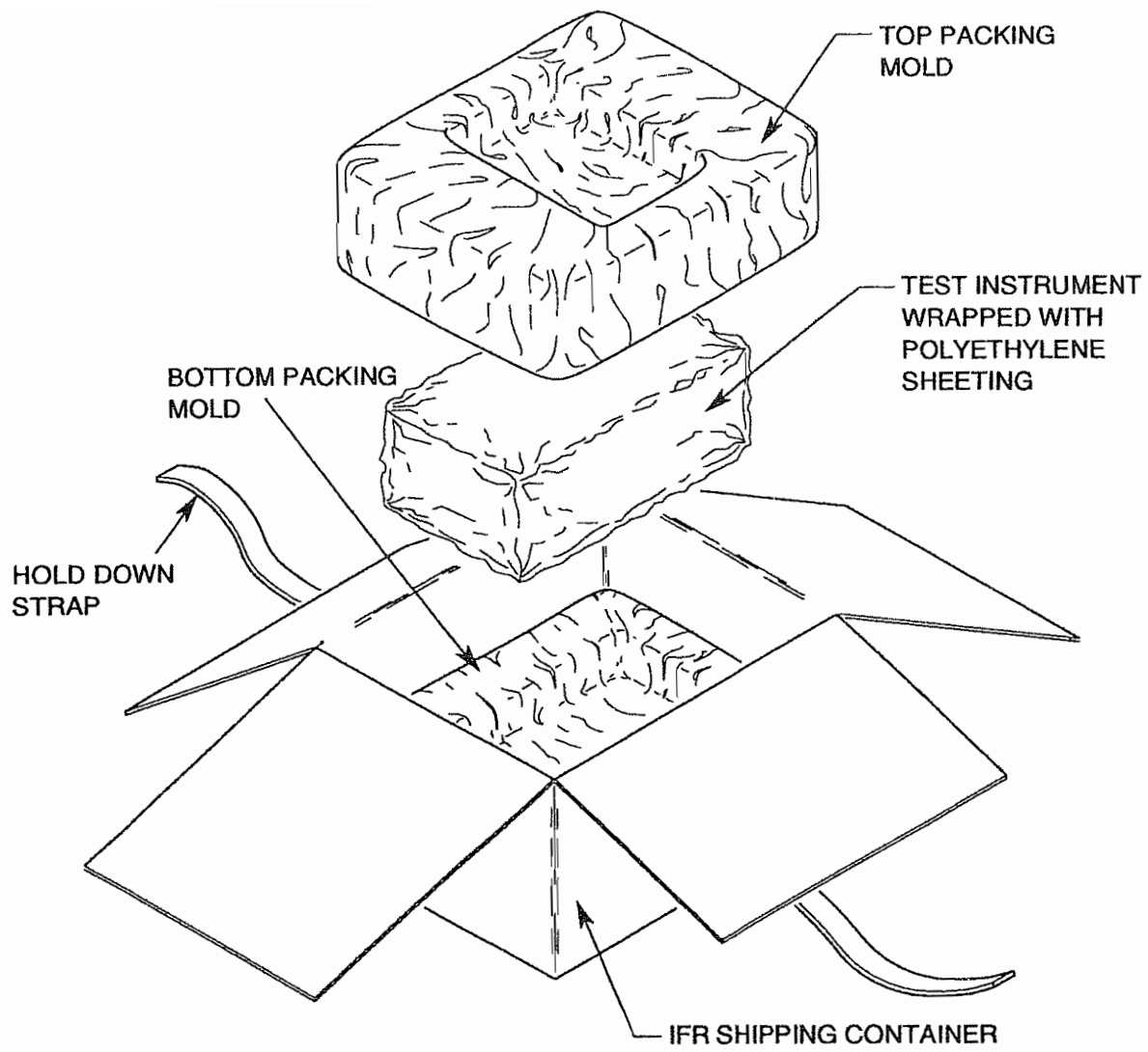

2206005

Repacking for Shipment

INDEX

A		D (Continued)	
Abbreviations	C-1	Duplex Mode	1-1
AC/GND/DC Switch	2-4	Duplex Mode Operation	3-13
AC Power Input Connector	2-6	DUPLEX Output Connector	2-4
AC Power Installation	1-2		
Activating Tone Generators	1-3	E	
Adjust Signal Tracking	6-4	Editing Numeric Entries	1-3
Adjust Squelch	3-8	Encode Test (Repeater Simulation)	6-7
Adjust to the Spectrum Analyzer		E-TACS/AMPS Mobile Station	
Horizontal and Vertical Position	3-18	Test Option	6-11
ANT Connector	2-5	European Tone Signaling Option	6-2
Appendices	A-1	Execute a Programmed Offset	3-14
Applications	4-1	Execute a Programmed RF Setting	1-4
Applications (E-TACS/AMPS)	6-14	Execute a Programmed Tone	
AUX POWER Connector	2-4	Sequence	3-22
		Execute the Tone Sweep Function	3-22
B		External Reference Connector	2-6
Battery Installation	1-2	EXT/MOD/SINAD Connector	2-4
C		F	
Cable Fault Test	4-9	First Order Functions	
Checking Voice Deviation	6-16	(Black Lettering)	2-7
CLEARCHANNEL LTR [®] Option	6-5	FOCUS Control	2-2
Configure Cellular Parameters	6-11	Focus the CRT	1-5
Configure European Tone Signaling		FREQ ERROR Meter	2-5
System Parameters	6-2	FREQ ERROR Meter Range Selector	
Configure the 1200 SUPER S for		Control	2-2
Remote Operations	5-1	FREQ ERROR Meter Zero Adjustment	2-2
Connecting the Controller to the		Front Panel	2-1
1200 SUPER S for Remote		Front Panel Controls	2-1
Operation	5-1	Function Keys	2-7
Controls, Connectors and			
Indicators	2-1	G	
Coupling for SCOPE/DVM Connector	3-16	Generate Amplifier Option	6-1
CRT	2-5	Generate an RF Signal with 5/6	
Cursor Control Keys	2-8	Tone as Modulation	3-4
		Generate an RF Signal with CTCSS	
D		Code as Modulation	3-5
Data Entry Keys	2-8	Generate an RF Signal with DCS	
dBm Reference Mode	3-19	Code as Modulation	3-3
DC Power Input Connector	2-6	Generate an RF Signal with DTMF	
Decode Baseband DTMF Coded		Modulation	3-4
Signals in Generate Mode	3-3	Generate an RF Signal with External	
Decode CTCSS Code in Generate		Modulation	3-3
Mode	3-5	Generate an RF Signal with MIC	
Decode CTCSS Code (Receive)	3-8	Modulation	3-2
Decode DCS Code	3-8	Generate an RF Signal with RCC	
Decode DTMF Code	3-8	Format as Modulation	3-4
Decode Test (Repeater Simulation)	6-7	Generate an RF Signal with Two	
Decode Tone Signaling Formats	6-3	Tone as Modulation	3-5
Decoding DTMF Digits during Manual		Generate Mode	1-1
Test	6-16	Generate Mode Operation	3-1
DEMOC Connector	2-4	Generate with Tone Signaling	
Deviation Check	4-10	Format as Modulation Source	6-3
Digital Voltmeter (DVM) Operation	3-19	GEN/LOCK Control	2-2
Displaying Readout of Meters on VFD	1-5		
Duplex Generate Mode	1-1		
Duplex Generate Mode Operation	3-15		

H

Handoff Test	6-10
Handshake Test	6-9
Horizontal Scale, Oscilloscope	3-15
Horizontal Sweep Selector Control	2-2
Horizontal Sweep Vernier Control and Spectrum Analyzer Sweep Rate	2-2
HORIZ POS Control	2-2

I

IEEE-488 (GPIB) Option	6-4
Install Generate Amplifier	6-1
Instruction Keys	2-8
INT Control	2-2

K

Keyboard	2-4
Keyboard Description	2-7

L

List of Options Available	6-1
LOCK Lamp	2-5

M

Making a Signal Tone Measurement	6-17
Making a Supervisory Audio Tone (SAT) Measurement	6-17
Manual Cell Site-to-Mobile Call (Page Mobile)	6-15
Measure AC Voltage	3-19
Measure Average Power	3-9
Measure DC Voltage	3-19
Measure Distortion of a Receiver	3-2
Measure Distortion of a Transmitter	3-8
Measure Peak Power	3-9
Measure Relative Signal Strength	3-9
Measure RF Error	3-9
Measure the SINAD of an FM Receiver	3-2
MIC/ACC Connector	2-4
Mobile Station Simulation Applications	6-9
MODE Selector Control	2-2
Modulation Acceptance Bandwidth for an FM Receiver	4-4
MODULATION METER	2-5
Modulation METER Control	2-3
Modulation Meter Zero Adjustment	2-3
MODULATION Select Control	2-3
Move the Trace on the CRT	1-5

O

1 kHz Tone Level Control	2-3
1 kHz Tone Selector Switch	2-3
Operation	3-1
Options	6-1

O (CONTINUED)

Oscilloscope Operation	3-16
------------------------	------

P

Performing a Battery Test	1-5
Performing a Cellular Auto Test	6-19
Performing a Flash Hook Test	6-16
Performing a Handoff Test	6-8
Performing a Handshake Test	6-8
Performing a Manual Mobile-to-Cell Site Test	6-14
Performing a No-Coax Cell-to-Mobile Call	6-17
Performing a No-Coax Mobile-to-Cell Call	6-17
Performing a Repeater Access Test	6-7
Performing Manual Registration	6-18
Program and Execute the Channel Scan Function in Generate	3-6
Program and Execute the Standard Scan Function in Generate	3-6
Program and Execute the Channel Scan Function in Receive	3-11
Program and Execute the Standard Scan Function in Receive	3-12
Program DCS Code for Transmission	3-3
Program DTMF/RCC Codes for Execution	3-4
Programming Memory Locations	1-3
Programming the RF List	1-4
Programming the Tone List	1-4
Program the Duplex Offset	3-14
Program the Tone Sweep Function	3-22
Program the T SEQ Memory	3-21
Program the T SEQ (Tone Sequence) Function	3-21
PWR/STANDBY/BATT Switch	2-1

R

Rear Panel	2-6
Receive Mode	1-1
Receive Mode Operation	3-7
Receiver Audio Output Level	4-3
Receiver Center Frequency	4-1
Receiver IF Bandwidth	4-5
Receiver Sensitivity	4-2
REF CAL Adjustment	2-4
Remote Operation	5-1
Remote Commands	5-2
Remote Operation Overview	5-1
Repacking for Shipment	D-1
Repeater Simulation Applications	6-7
Review Test Results, Cellular Test	6-13
RF Level Attenuator Control	2-4
RF Level Attenuator Vernier Control	2-4
RS-232/GPIB (Option 13) Connector	2-6

S

SCOPE/DVM Connector 2-4
 Second Order Functions
 (Blue Lettering) 2-7

S (Continued)

Select and Program 5/6 Tone
 Format 6-2
 Select and Program European
 Tone Signaling Formats 6-2
 Select and Program the Two Tone
 Function 6-3
 Select between DTMF Encode or
 Decode Operation 3-14
 Select Trunking Test Type 6-6
 Set an Audio Level at the Tone
 Connector 3-20
 Set Audio Filters 3-9
 Set Horizontal Scale, Spectrum
 Analyzer 3-18
 Set Modulation Type (Receive) 3-8
 Set RF as a Channel 1-5
 Set RF Directly 1-4
 Set RF Output Level 3-2
 Set the Coupling for SCOPE/DVM
 Connector 3-16
 Set the CRT Intensity 1-5
 Set the Duplex Generator Level 3-14
 Set the Duplex Offset Directly 3-14
 Set the DVM to dBm Reference Mode 3-19
 Set the DVM to Measure AC Voltage 3-19
 Set the DVM to Measure DC Voltage 3-19
 Set the GPIB Address 6-4
 Set the Horizontal Scale, Oscilloscope 3-16
 Set the Modulation Type 3-2
 Set the Modulation Level 3-2
 Set the Vertical Scale, Oscilloscope 3-16
 Setting Variable Tone Generator
 Frequency and Shape 1-4
 Setting VFD Intensity 1-3
 Set Tracking Generator Level 6-4
 Set Trunking Parameters 6-5
 Setup the DTMF Generator 3-3
 SIG Indicator Lamp 2-5
 SINAD Measurement during Manual
 Test 6-16
 Specifications A-1
 Spectrum Analyzer Operation 3-17
 SQUELCH Control 2-2
 Syntax Used with Remote Commands 5-1

T

Table of User I/O Ports and
 Connector Pin-Out Tables B-1
 Testing RIC Interconnect 6-8
 Tone Generator Operation 3-20
 TONE OUT Connector 2-4
 Tracking Generator Level 6-4
 Tracking Generator Option 6-4
 Transmitter CTCSS Frequency 4-7
 Transmitter Frequency Error 4-6
 Transmitter Harmonics 4-8
 T/R Connector 2-4

U

Use Meters during Cellular Testing 6-13

V

VAR Tone Level Control 2-3
 VAR Tone Selector Switch 2-3
 Vertical Attenuator Vernier Control 2-1
 Vertical Attenuator Selector Control 2-1
 Vertical Scale, Oscilloscope 3-16
 VERT POS Control 2-2
 VFD (Vacuum Fluorescent Display) 2-5
 VOLUME Control 2-2

