

**FM/AM-500/A**

# **OPERATOR'S GUIDE**

1002-5201-300

PUBLISHED BY  
IFR SYSTEMS, INC.  
Wichita, Kansas

Copyright © 1989 by IFR Systems, Inc.

All rights reserved. Printed in the United States of America. No part of this publication may be reproduced, stored in a retrieval system or transmitted in any form or by any means, electronic, mechanical, photocopying, recording or otherwise, without the prior permission of the publisher.

Original Printing: November 15, 1983  
Revision 01: March 15, 1985  
Revision 02: October 1, 1987  
Revision 03: January 1, 1989

## INTRODUCTION TO THE FM/AM-500/A OPERATOR'S GUIDE

This publication was developed to aid the communication service technician in using the FM/AM-500 or FM/AM-500A to analyze certain common transmitter and receiver performance parameters. Tests included were selected because of appropriateness, application to as wide a spectrum of equipment as possible, and minimum amount of auxiliary equipment required to perform the test. All tests described in this Operator's Guide can be performed with either the FM/AM-500 (referred to as the 500) or the FM/AM-500A (referred to as the 500A), except for those tests specifically designated for the 500A. The term "500/A" refers to both models.

The major outward distinction between the 500 and 500A is the Front Panel markings on the Modulation Meter, Modulation Meter Range Switch and EXT MOD/SINAD connector. Only the 500A Front Panel is shown in this manual.

The scope of this publication does not allow the inclusion of specific troubleshooting techniques, nor guarantee that the included tests will be suitable for all applications. Consult material from the UUT manufacturer for specific test requirements or other appropriate tests.

IFR, Inc. assumes no liability for damage to equipment or personnel resulting from the misuse of IFR equipment, these test procedures, or equipment serviced by IFR equipment. See "CAUTIONS" on page 5.

Perform tests exactly as given. Careful attention must be given to antenna loading, impedance matching and the use of attenuators (if needed). 500/A controls, indicators, and connectors are identified by reference numbers. Items on other equipment are designated by generic name.

# TABLE OF CONTENTS

NOTES AND CAUTIONS .....	4
GENERAL OPERATING DATA .....	6
DESCRIPTION OF CONTROLS, CONNECTORS, AND INDICATORS .....	9
USING AUDIO GENERATOR	
GENERATING AUDIO TONES .....	11
USING SPEAKER TO EXCITE MICROPHONE .....	13
USING RECEIVER/MONITOR	
RECEIVING SIGNALS .....	15
MEASURING DEVIATION AND % MODULATION .....	17
MEASURING RF FREQUENCIES .....	19
MEASURING AUDIO FREQUENCIES OFF-THE-AIR OR THROUGH THE GENERATOR (500/A) .....	21
MEASURING AUDIO FREQUENCIES DIRECTLY FROM UUT (500A ONLY) .....	23
USING RF SIGNAL GENERATOR	
GENERATING RF SIGNALS .....	25
MEASURING RECEIVER SENSITIVITY .....	27
MEASURING SINAD (500A ONLY) .....	29
MEASURING DISTORTION (500A ONLY) .....	31
MEASURING POWER (500A ONLY) .....	33
MEASURING RECEIVER BANDWIDTH .....	35
MEASURING SQUELCH THRESHOLD AND DIFFERENTIAL .....	37
USING GENERATE AMPLIFIER OPTION	
OPTIONAL GENERATE AMPLIFIER OPERATION .....	39
RADIO INSTALLATION CHECKOUT .....	41
USING FREQUENCY STANDARD	
CALIBRATION TO WWV .....	43
CALIBRATION TO EXTERNAL FREQUENCY COUNTER .....	45
OPERATION FROM EXTERNAL FREQUENCY STANDARD .....	47
SPECIFICATIONS .....	48

## NOTES AND CAUTIONS

REFER TO DESCRIPTION OF CONTROLS, CONNECTORS, AND INDICATORS (pages 8 and 9) FOR COMPONENT IDENTIFICATION.

### NOTES

- Each 500/A control, indicator, or connector identified in ACTION/RESULTS column is designated by reference number in quotes (" ").
- Designators used in test procedures refer to the illustration opposite each procedure.
- With Modulation Meter Range Switch "4" in SIG position, MODULATION Meter "1" indicates the level of the received signal relative to the gain required for receiver operation. Larger numbers indicate a stronger signal, thus less gain is required. Factors such as internal set temperature, set aging, distance from transmitter station, and antenna used affect the indication.

## CAUTIONS

- ANTENNA Connector "23" is used for "off-the-air" testing and with optional Generate Amplifier only. Do **not** connect a transmitter to this input.
- Do **not** connect UUT transmitter output to any jack other than T/R Connector "5".
- Maximum ON time for measurement of transmitter output using T/R Connector "5" is:
  - 150 W = 1 min. max. ON time, 5 min. minimum OFF time.
  - 100 W = 1½ min. max. ON time, 4 min. minimum OFF time.
  - 50 W = 2 min. max. ON time, 2 min. minimum OFF time.
  - 25 W = Continuous.
- If the furnished DC power cord is not used when using external DC power, a 3 Amp fuse must be installed in the DC power supply circuit.
- If the 500/A is plugged into a vehicle's DC supply, disconnect the set while starting the engine.
- Remove any possible static charge from an unterminated antenna before connecting to the 500/A ANTENNA Connector "23". The T/R Connector "5" may be used for this purpose.
- Do **not** force RF LEVEL Controls "11" and "12" past the stops.
- When operating on DC, remove the external AC power cord from the set. A potential shock hazard could exist in event of a malfunction.

## GENERAL OPERATING DATA

REFER TO DESCRIPTION OF CONTROLS, CONNECTORS, AND INDICATORS (pages 8 and 9) FOR COMPONENT IDENTIFICATION.

## CASE REMOVAL AND INSTALLATION

**REMOVAL:** Loosen the two captive screws attaching rear escutcheon to Rear Panel. Remove escutcheon, then slide chassis from case.

**INSTALLATION:** Slide chassis into case and engage case in groove of front escutcheon. Position rear escutcheon on case and engage case in groove, then tighten two captive screws securing escutcheon to Rear Panel.

## FUSES

Line:	120 VAC operation:	1 Amp Slow Blow
	240 VAC operation:	1/2 Amp Slow Blow
Battery:		3 Amp Slow Blow
External DC (in cord):		3 Amp Slow Blow

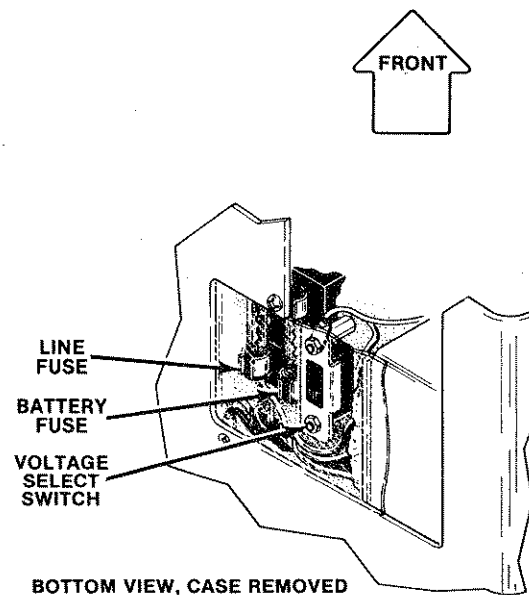

### **OPERATING FROM EXTERNAL AC POWER**

For operation on 120 or 240 VAC, set internal Voltage Select Switch appropriately and install correct fuse (see page 6). Place Power Switch "17" in LINE position. Use AC power cord furnished with 500/A.

### **OPERATING FROM EXTERNAL DC POWER**

For operation from external 12 VDC, connect DC power cord (furnished with 500/A) into standard cigarette lighter socket and into DC Power Connector "31", then place Power Switch "17" in BATT position.

Internal battery will recharge from external DC power only when voltage is above 13.5 V (vehicle engine running). Operation above 14 volts may result in an excessive charge rate on the internal battery and blowing the external DC fuse.

Except when the optional oven oscillator is installed, the set automatically turns off after approximately 10 minutes of battery operation. To resume operation, turn Power Switch "17" OFF, then back to BATT.

### **OPERATING FROM INTERNAL BATTERY**

To check battery level, place Power Switch "17" in BATT and Modulation Meter Range Switch "4" in BATT TEST position. Charge level is shown on MODULATION Meter "1". Recharge battery if below 11.5 VDC.

To recharge battery, connect set to 120 or 240 VAC and place Power Switch "17" in OFF or LINE position. Charge time (80% charge) in OFF position is approximately 8 hours; in LINE position, approximately 12 hours.

The set operates on battery even if connected to 120 or 240 VAC when Power Switch "17" is in BATT position.

The set automatically turns off after approximately 10 minutes of DC operation. To resume operation, turn Power Switch "17" OFF, then back to BATT.



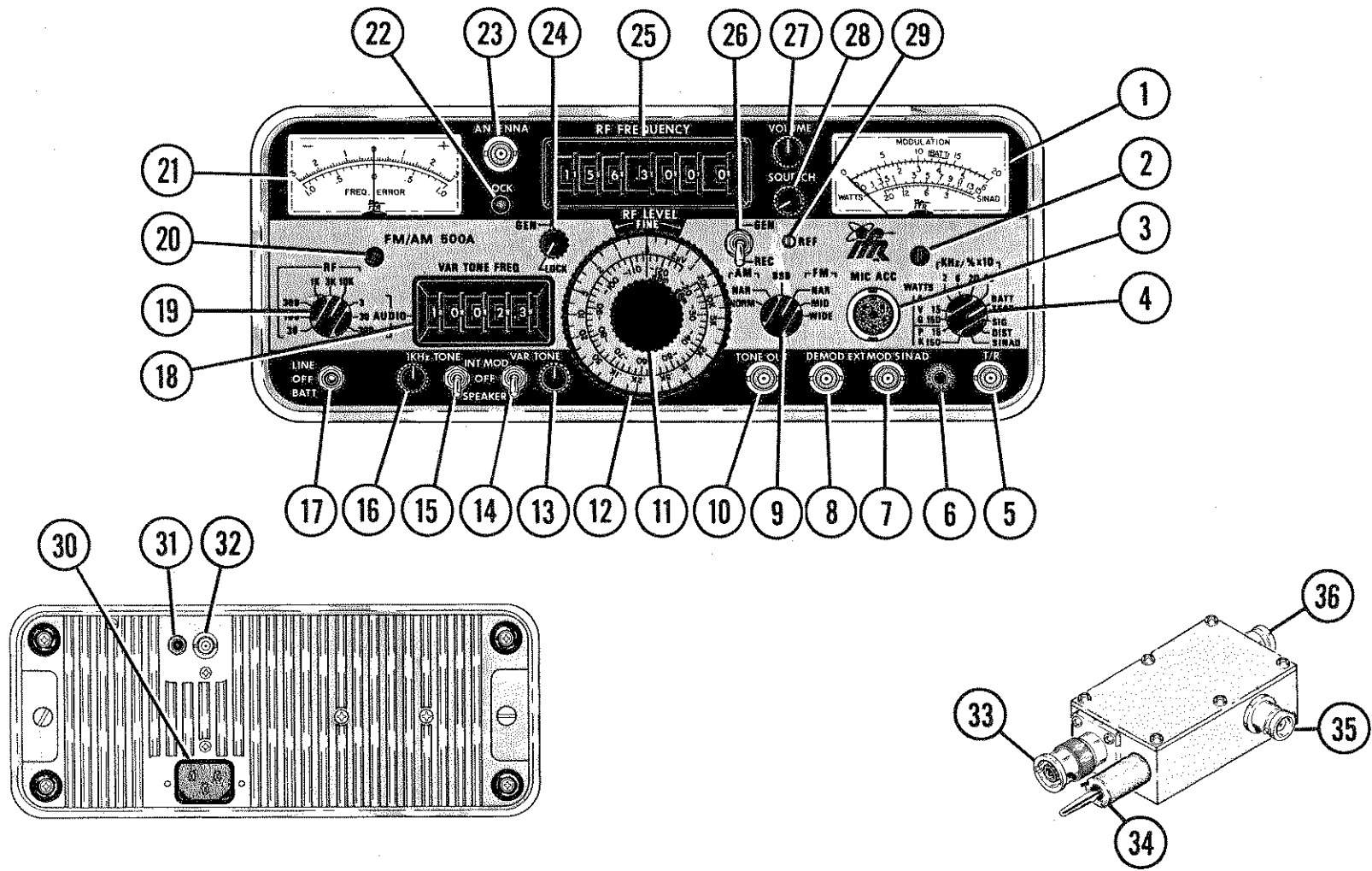

## DESCRIPTION OF CONTROLS, CONNECTORS, AND INDICATORS

### No.

- 1 MODULATION Meter
- 2 Modulation Meter Zero Adjustment
- 3 MIC/ACC Connector
- 4 Modulation Meter Range Switch
- 5 T/R (Trans/Rec) Connector
- 6 Optional Generate Amplifier Connector
- 7 EXT MOD/SINAD Connector
- 8 DEMOD Connector
- 9 Modulation Mode Selector Switch
- 10 TONE OUT Connector
- 11 RF LEVEL Attenuator Control
- 12 RF LEVEL FINE Adjust Control
- 13 VAR TONE Level Control
- 14 VAR TONE Selector Switch
- 15 1 kHz TONE Selector Switch
- 16 1 kHz TONE Level Control
- 17 Power Switch
- 18 VAR TONE FREQ Thumbwheels

### No.

- 19 FREQ ERROR Meter Range Switch
- 20 Freq Error Meter Zero Adjustment
- 21 FREQ ERROR Meter
- 22 RF Frequency LOCK Lamp
- 23 ANTENNA Connector
- 24 GEN/LOCK Control
- 25 RF FREQUENCY Thumbwheels
- 26 GEN/REC Mode Switch
- 27 VOLUME Control
- 28 SQUELCH Control
- 29 REF Frequency Adjustment
- 30 AC Power Connector
- 31 DC Power Connector
- 32 Frequency Standard Connector
- 33 Monitor T/R (Connects to 5)
- 34 Monitor Power (Connects to 6)
- 35 Monitor Antenna (Connects to 23)
- 36 UUT T/R Test (Connects to UUT)

ITEM	NAME	DESCRIPTION
------	------	-------------

**1. MODULATION Meter**

Provides a visual display of modulation levels, RF power levels (peak and average), relative signal strength, battery test voltage, distortion and SINAD when selected by the Modulation Meter Range Switch "4".

**2. Modulation Meter Zero Adjustment**

Adjustment screw for mechanical zeroing of MODULATION Meter "1" when power to FM/AM-500A is OFF

**3. MIC/ACC Connector**

Allows use of external microphone.

**4. Modulation Meter Range Switch**

Selects input source for MODULATION Meter "1".

**5. T/R (Trans/Rec) Connector**

50  $\Omega$  I/O Connector for connecting UUT to FM/AM-500A.

**CAUTION:**

DO NOT APPLY MORE THAN 150 WATTS TO THIS CONNECTOR. IRREVERSIBLE DAMAGE TO INTERNAL COMPONENTS OF FM/AM-500A MAY RESULT.

**6. Optional Generate Amplifier Connector**

+12V is applied to this connector in Generate mode to power the Generate Amplifier.

**7. EXT MOD/SINAD Connector**

Allows application of external modulation when "Generate" Mode is selected. Permits measurement of UUT SINAD and/or Distortion when Modulation Meter Range Switch "4" is positioned to "SINAD" or "DIST"

**8. DEMOD Connector**

Allows external scope monitoring of the demodulated received or generated audio signal.

ITEM	NAME	DESCRIPTION
9.	<b>Modulation Mode Selector Switch</b>	Selects modulation and demodulation modes of FM/AM-500A receiver/generator for FM, AM, SSB and their associated pre and post-detection bandwidths.
10.	<b>TONE OUT Connector</b>	When either VAR Ton Selector Switch "14" or 1 kHz Tone Selector Switch "15" is positioned to "INTL"; variable, fixed or both tones are present at this connector.
11.	<b>RF LEVEL Attenuator Control</b>	Controls RF output level of the FM/AM-500A signal generator in 10 dB steps.
12.	<b>RF LEVEL FINE Adjust Control</b>	Provides fine adjustment of RF Output Level of FM/AM-500A Signal Generator, as indicated on dB/uv scale (0 to -12 dB).
13.	<b>VAR TONE Level Control</b>	Controls variable tone level.
14.	<b>VAR TONE Selector Switch</b>	<p>Selects variable tone as follows:</p> <p>INTL- Variable tone will be routed to RF generator for modulation, and routed to TONE OUT Connector "10".</p> <p>OFF- Disconnects tone from internal modulation, TONE OUT Connector "10" and Speaker.</p> <p>SPKR- Variable tone will be routed to the FM/AM-500A Speaker only.</p>

ITEM	NAME	DESCRIPTION
------	------	-------------

**15. 1 kHz TONE Selector Switch**

Selects 1 kHz fixed tone as follows:

INTL- 1 kHz fixed tone will be routed to RF generator for modulation and routed to TONE OUT Connector "10".

OFF- Disconnects tone from internal modulation, TONE OUT Connector "10" and Speaker.

SPKR- Variable tone will be routed to the FM/AM-500A Speaker only.

**16. 1 kHz TONE Level Control**

Controls 1 kHz fixed tone level.

**17. Power Switch**

Applies/Interrupts power to FM/AM-500A as follows:

LINE- FM/AM-500A is powered by external AC or DC power source.

OFF- FM/AM-500A is OFF.

BATT- FM/AM-500A is powered by internal battery.

**NOTE:**

Internal FM/AM-500A battery is continuously charged whenever external AC power or external DC power is connected to set, regardless of Power Switch position.

**18. VAR TONE FREQ Thumbwheels**

Select frequency of the variable tone generator.

ITEM	NAME	DESCRIPTION
19.	<b>FREQ ERROR Meter Range Switch</b>	Selects full scale sensitivity of FREQ ERROR Meter "21" between RF and audio frequency ranges. The audio frequency is referenced to the Variable Tone Generator.
20.	<b>Freq Error Meter Zero Adjustment</b>	Mechanical zero adjustment for FREQ ERROR Meter "21" when power to FM/AM-500A is OFF.
21.	<b>FREQ ERROR Meter</b>	Provides a visual display of the difference between received signal frequency and selected FM/AM-500A receiver frequency.  Provides a visual display of the difference between the DEMOD audio signal frequency and selected variable tone generator.
22.	<b>RF Frequency LOCK Lamp</b>	Indicates in the following manner: STEADY LIGHT- VCO's are phase locked. BLINKING LIGHT- GEN/LOCK Control "24" is out of the "LOCK" position or FM/AM-500A is experiencing a malfunction. NO LIGHT- Malfunction in lamp circuitry.
23.	<b>ANTENNA Connector</b>	External Antenna Input used primarily for "OFF-THE-AIR" testing.

**CAUTION:**

TO PREVENT DAMAGE TO FM/AM-500A INTERNAL COMPONENTS, MAXIMUM CONTINUOUS INPUT TO ANTENNA CONNECTOR MUST NOT EXCEED 0.25 WATT.

ITEM	NAME	DESCRIPTION
24.	<b>GEN/LOCK Control</b>	Allows the RF frequency to be slewed off frequency in Generate and acts as a clarifier when receiving SSB.
25.	<b>RF FREQUENCY Thumbwheels</b>	Selects the RF generator or receiver frequency.
26.	<b>GEN/REC Mode Switch</b>	GEN- Places FM/AM-500A in the generate mode. Transmitting into the T/R Connector "5" will automatically change FM/AM-500A to "Receive" mode. REC- Places FM/AM-500A in the receive mode to receive through the T/R Connector "5", or "OFF-THE-AIR" signals through the ANTENNA Connector "23".
27.	<b>VOLUME CONTROL</b>	Controls volume of FM/AM-500A speaker.
28.	<b>SQUELCH Control</b>	Controls receiver squelch threshold. Squelch disables audio output, freq error and modulation indicators when RF input at ANTENNA Connector "23" falls below squelch threshold.
29.	<b>REF Frequency Adjustment</b>	Adjustment screw for mechanical fine tuning of 10 MHz Internal Reference signal.

<b>ITEM</b>	<b>NAME</b>	<b>DESCRIPTION</b>
<b>30.</b>	<b>AC Power Connector</b>	AC power input connector for 105-130/210-260 VAC supply at 50-400 Hz.
<b>31.</b>	<b>DC Power Connector</b>	DC power input connector for 12-14 VDC supply.
<b>32.</b>	<b>Frequency Standard Connector</b>	Allows monitoring of 10 MHz internal reference frequency or the application of an external 10 MHz reference frequency.



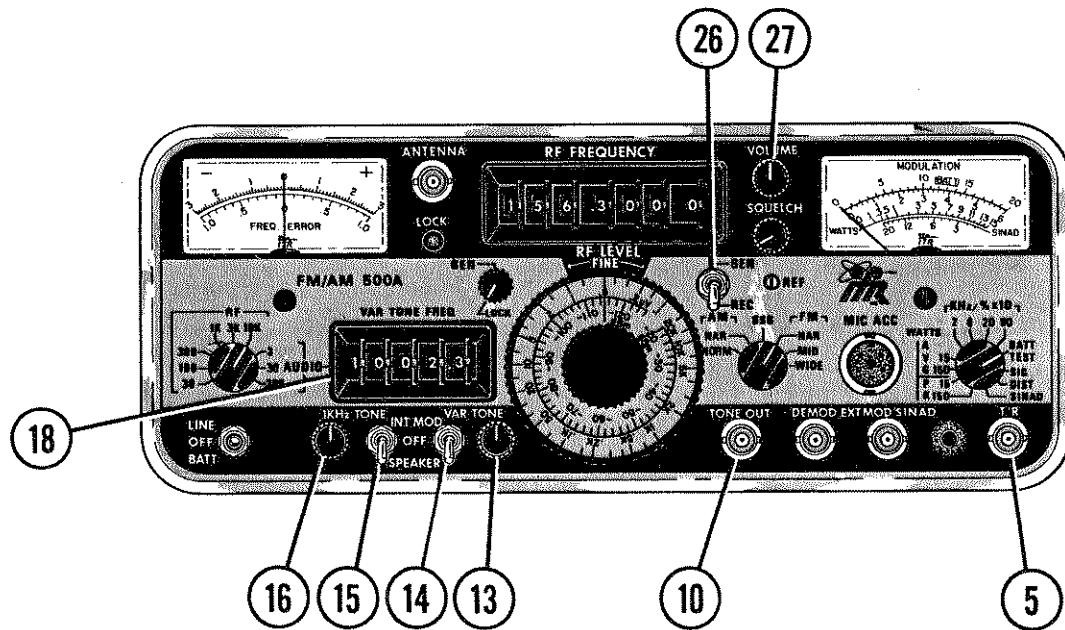

## GENERATING AUDIO TONES

STEP	CONTROL	SETTING	ACTION/RESULT
1			Connect coax cable between "10" and microphone jack or other audio input on UUT.
2	13 14 18  15 16	As desired INT MOD As required  INT MOD As desired	If variable tone is desired, set "13", "14" and "18".  If 1 kHz fixed tone is desired, set "15" and "16".
3	26  27	GEN or REC  As desired	For aural monitor of applied tone. To monitor UUT transmitter. (Connect coax between UUT RF output and "5".)

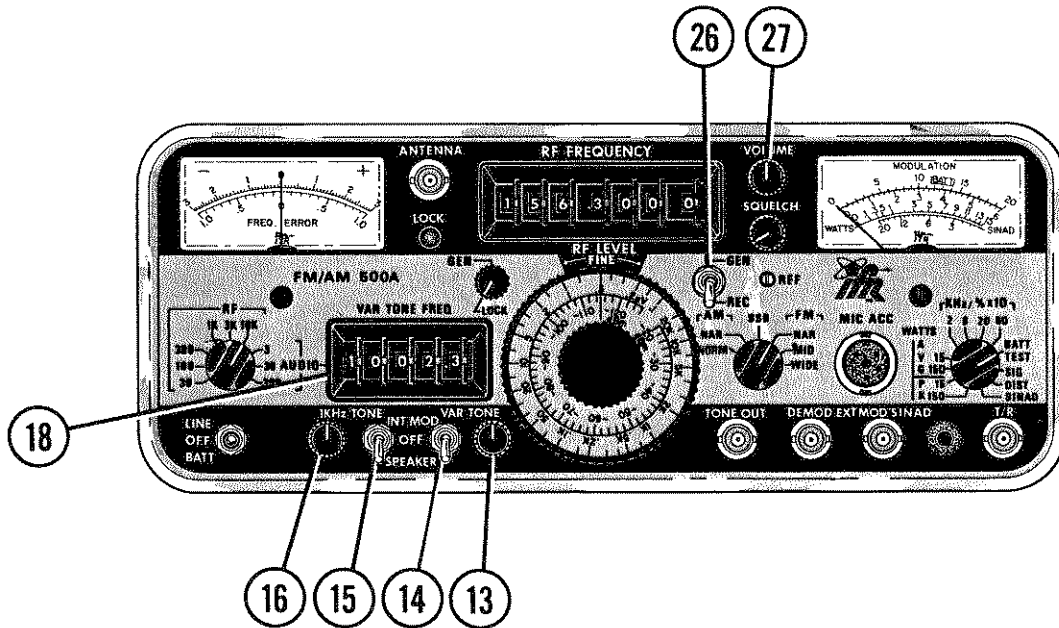

## USING SPEAKER TO EXCITE MICROPHONE

STEP	CONTROL	SETTING	ACTION/RESULT
1	26	REC	If variable tone is desired, set "13", "14" and "18".  If 1 kHz fixed tone is desired, set "15" and "16".
	27	Full ccw	
	13	As desired	
	14	SPKR	
	18	As required	
	15	SPKR	
16	As desired		
2			Hold UUT microphone close to 500/A speaker and depress Press-To-Talk Switch. Use 500/A to analyze UUT Modulation.

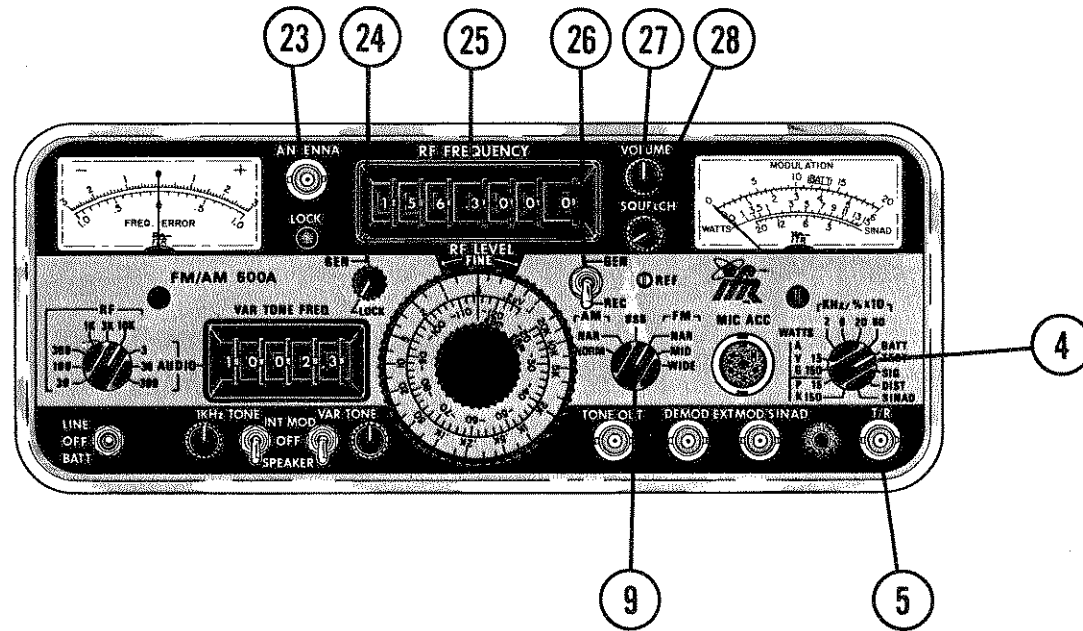

## RECEIVING SIGNALS

STEP	CONTROL	SETTING	ACTION/RESULT
1			<p>Connect antenna to "23" OR connect RF pickup to "23" and place pickup probe near frequency source OR connect coax from UUT RF output to "5".</p> <p style="text-align: center;"><b>CAUTION</b></p> <p>DO NOT EXCEED .25 W (¼ W) INTO "23". USE EXTERNAL PAD TO REDUCE SIGNAL TO LESS THAN -30 dBm IF NEEDED TO PREVENT RECEIVER OVERLOAD.</p>
2	<p style="text-align: center;">4</p>    <p style="text-align: center;">9 24 25 26</p>	<p style="text-align: center;">SIG</p>  <p style="text-align: center;">As required LOCK</p> <p style="text-align: center;">As required REC</p>	<p>If relative signal strength is desired, "4" must be in SIG position. See NOTE on page 4.</p> <p>NOTE: Any input to "5" over approximately 100 mW will automatically switch 500/A internally to Receive mode for duration of signal.</p>
3	<p style="text-align: center;">27 28</p>	<p style="text-align: center;">As required As required</p>	<p>Adjust to comfortable level.</p>

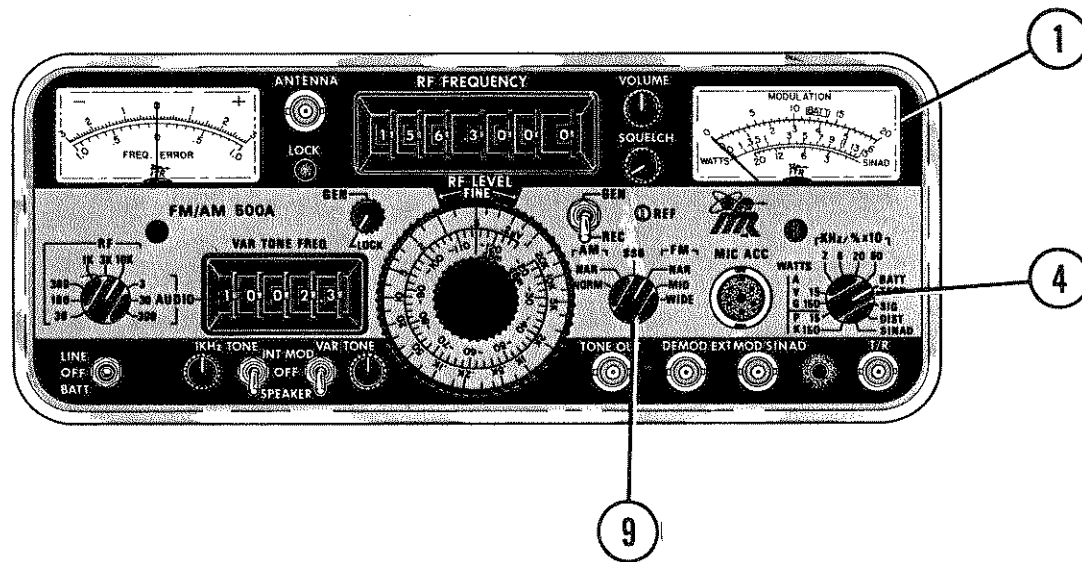

## MEASURING DEVIATION AND % MODULATION

STEP	CONTROL	SETTING	ACTION/RESULT
1			Perform RECEIVING SIGNALS procedure (see page 15).
2	4 9	As required As required	"1" indicates peak FM deviation or AM % modulation.



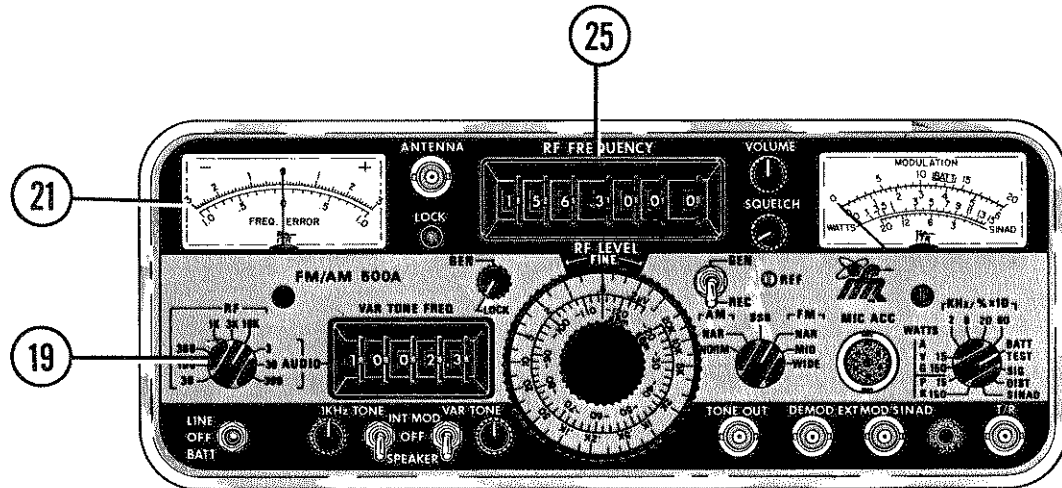

## MEASURING RF FREQUENCIES

STEP	CONTROL	SETTING	ACTION/RESULT
1			Perform RECEIVING SIGNALS procedure (see page 15).
2	19 25	RF 10 K Bring "21" on scale	Add or subtract reading of "21" to setting of "25" to obtain actual frequency. If greater accuracy is desired, perform Step 3.
3	19 25	RF 3 K Bring "21" on scale	Add or subtract reading of "21" to setting of "25" to obtain actual frequency. If greater accuracy is desired, perform Step 4.
4	19 25	RF 1 K Bring "21" on scale	Add or subtract reading of "21" to setting of "25" to obtain exact frequency.

NOTE: Although the 500/A can provide 1 Hz resolution, the master oscillator tolerance and aging may cause a significant indication error. See page 43 for calibrating the 500/A to WWV.

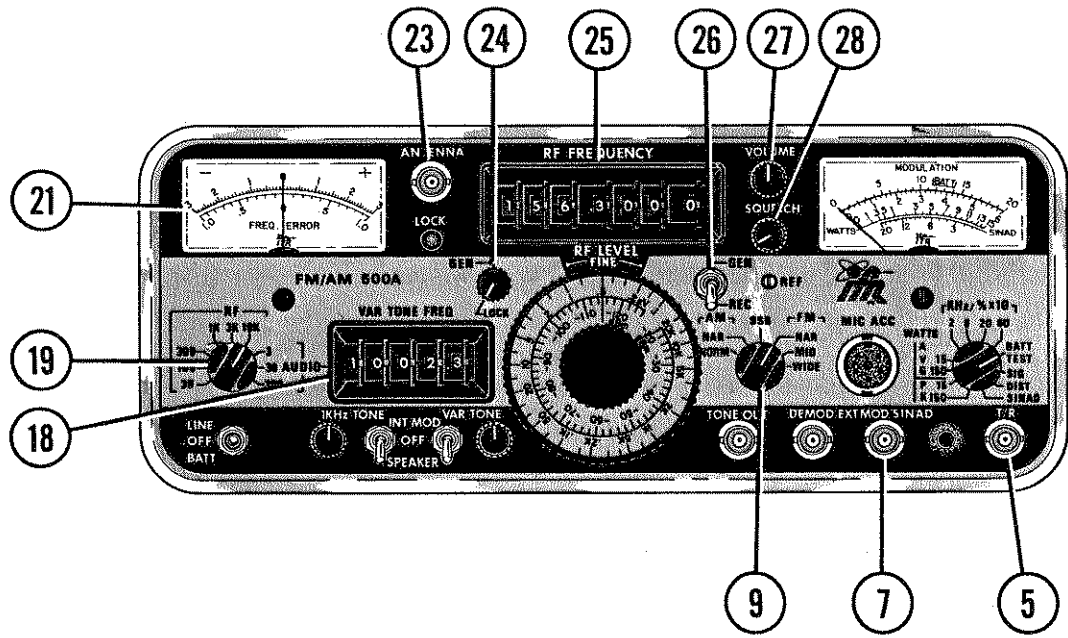

## MEASURING AUDIO FREQUENCIES Off-the-Air or Through the Generator (500/A)

STEP	CONTROL	SETTING	ACTION/RESULT
1			Connect antenna to "23" OR connect coax from transmitter to "5" OR connect coax from tone generating UUT to "7".
2	26	REC or GEN	For audio signals from transmitter or off-the-air. For audio from tone generating UUT.
3	9 24 25	As required LOCK As required	For audio from transmitter or off-the-air.
4	27 28	As required As required	Adjust to comfortable level.
5	19 18	AUDIO 300 Bring "21" on scale	Add or subtract reading of "21" to setting of "18" to obtain actual frequency. If greater accuracy is desired, perform Step 6.
6	19 18	AUDIO 30 Bring "21" on scale	Add or subtract reading of "21" to setting of "18" to obtain actual frequency. If greater accuracy is desired, perform Step 7.
7	19 18	AUDIO 3 Bring "21" on scale	Add or subtract reading of "21" to setting of "18" to obtain exact frequency.

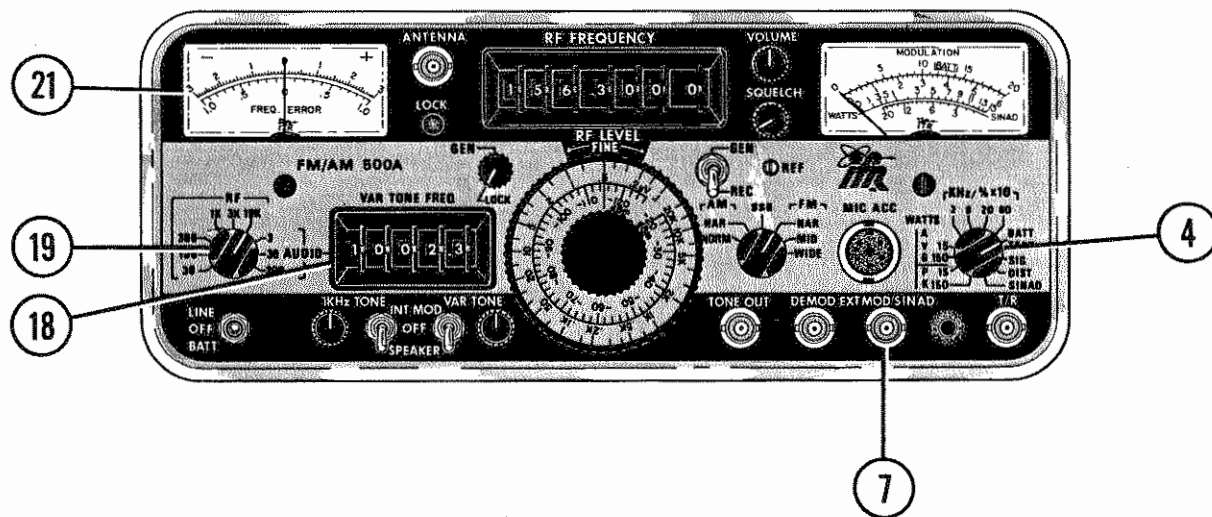

## MEASURING AUDIO FREQUENCIES Directly from UUT (500A Only)

STEP	CONTROL	SETTING	ACTION/RESULT
1	4	DIST or SINAD	Connect tone generating UUT to "7".
2	19 18	AUDIO 300 Bring "21" on scale	Add or subtract reading of "21" to setting of "18" to obtain actual frequency. If greater accuracy is desired, perform Step 3.
3	19 18	AUDIO 30 Bring "21" on scale	Add or subtract reading of "21" to setting of "18" to obtain actual frequency. If greater accuracy is desired, perform Step 4.
4	19 18	AUDIO 3 Bring "21" on scale	Add or subtract reading of "21" to setting of "18" to obtain exact frequency.

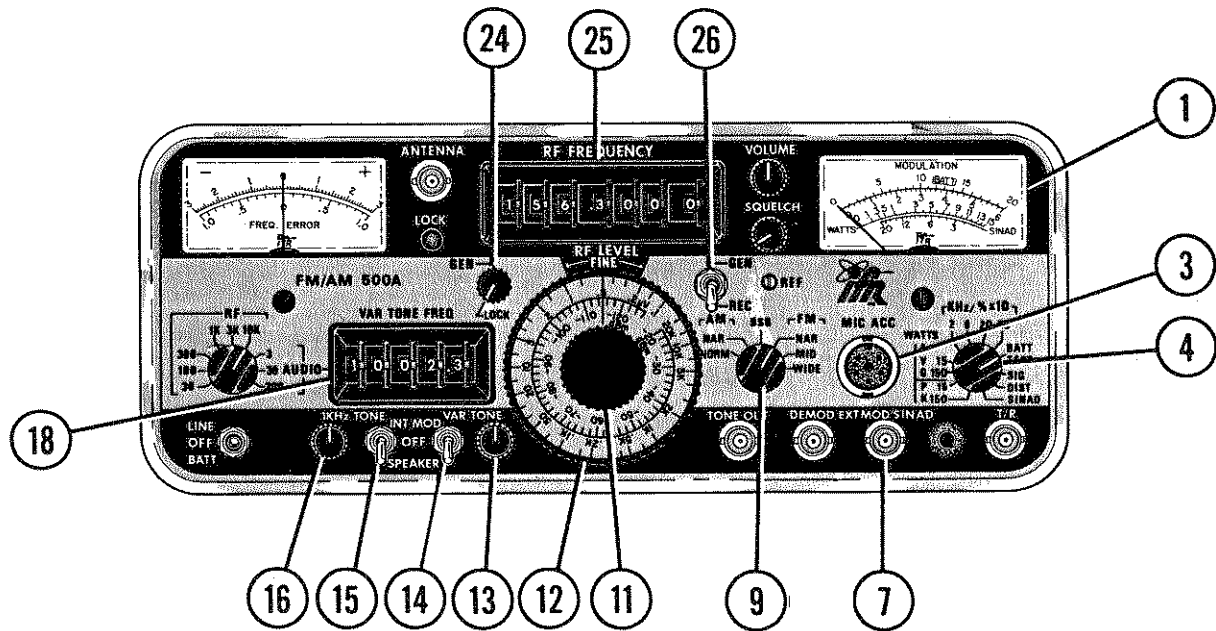

## GENERATING RF SIGNALS

STEP	CONTROL	SETTING	ACTION/RESULT
1	24 25 26 11 12	LOCK As required GEN As required As required	The 500/A is now generating a CW signal at selected frequency with level in dBm or $\mu$ V determined by "11" and "12".
2	9	AM or SSB FM	For AM signals For FM signals.
3	4	20 kHz/%	For lower modulation, "4" may be set to 6 or 2 as desired.
4	13 14 18  15 16	As required INT MOD As required  INT MOD As required	For use of variable tone generator. Adjust "13" until desired deviation or modulation is displayed on "1".  For use of 1 kHz fixed tone generator. Adjust "16" until desired deviation or modulation is displayed on "1".
5			An external modulation source can be applied to "7" if desired.
6			Microphone may be connected to "3" if desired. Depressing Mic Key will automatically switch 500/A internally to GEN mode regardless of position of "26".

NOTE: "1" will always read total peak modulation of all signals applied. Therefore, to read modulation from one source only, all other sources must be disabled momentarily.



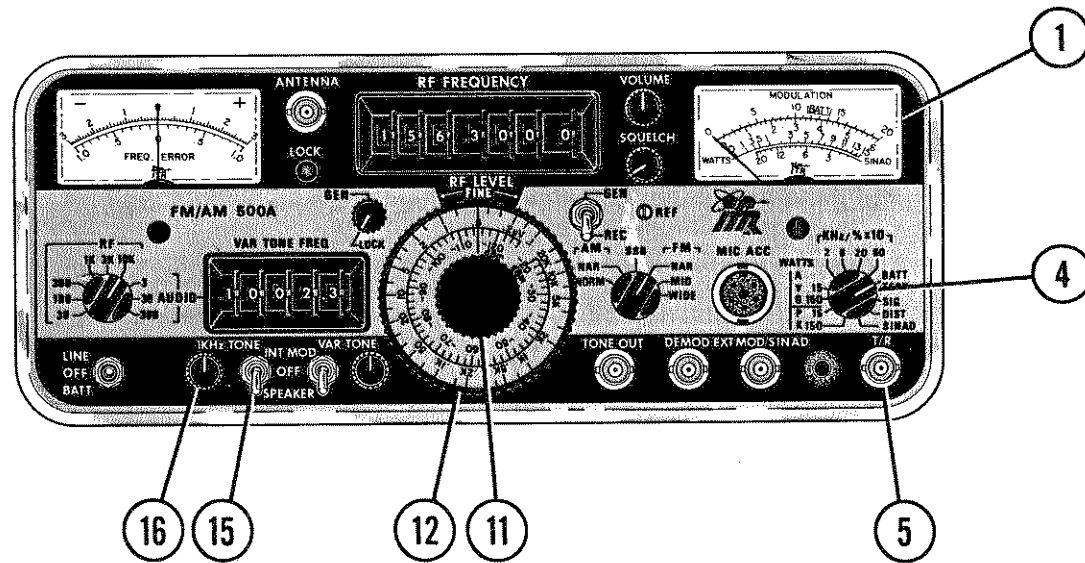

## MEASURING RECEIVER SENSITIVITY

STEP	CONTROL	SETTING	ACTION/RESULT
1			Connect coax from "5" to receiver RF input.
2			Perform GENERATING RF SIGNALS procedure (see page 25).
3	15	INT MOD or OFF	INT MOD for AM or FM receiver. OFF for SSB receiver.
4	4 16	6 kHz/% As required	Adjust "16" to obtain indication of 4 kHz (for FM) or 30% modulation (for AM) on "1".
5	11 12	As required As required	Rotate both controls as required to obtain desired signal-to-noise ratio, quieting, or SINAD. Read sensitivity from "11" and "12".

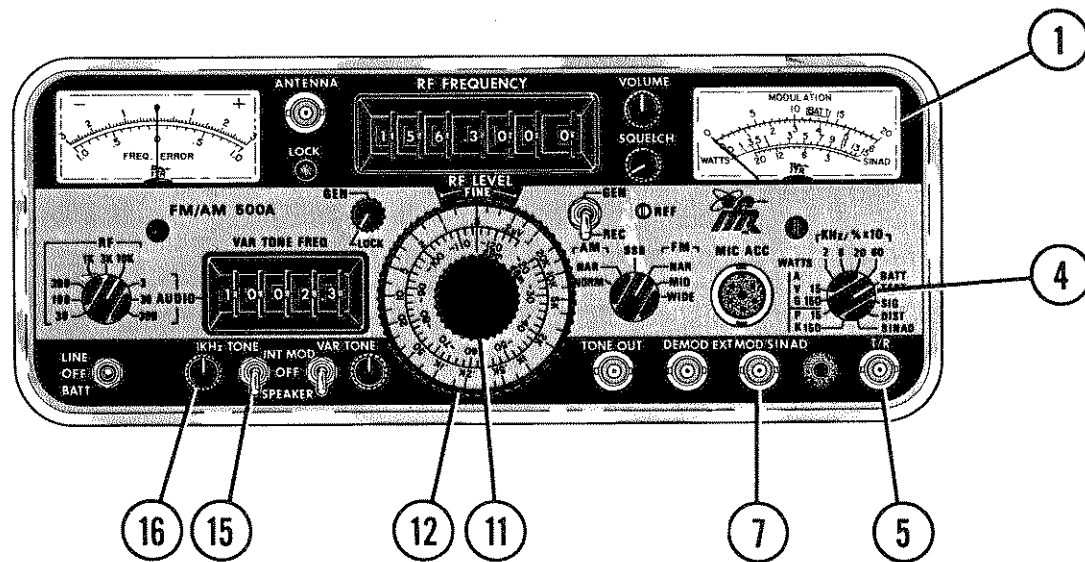

## MEASURING SINAD (500A Only)

STEP	CONTROL	SETTING	ACTION/RESULT
1			Connect coax from "5" to receiver RF input.
2			Perform GENERATING RF SIGNALS procedure (see page 25).
3	15	INT MOD or OFF	INT MOD for AM or FM receiver. OFF for SSB receiver.
4	4 16	6 kHz/% As required	Adjust "16" to obtain indication of 4 kHz (for FM) or 30% modulation (for AM) on "1".
5	4 11 12	SINAD As required As required	Adjust "11" and "12" to sensitivity specified for UUT (i.e., .5 $\mu$ V for FM).
6			Connect UUT Audio Output to "7" and read SINAD in dB from "1".

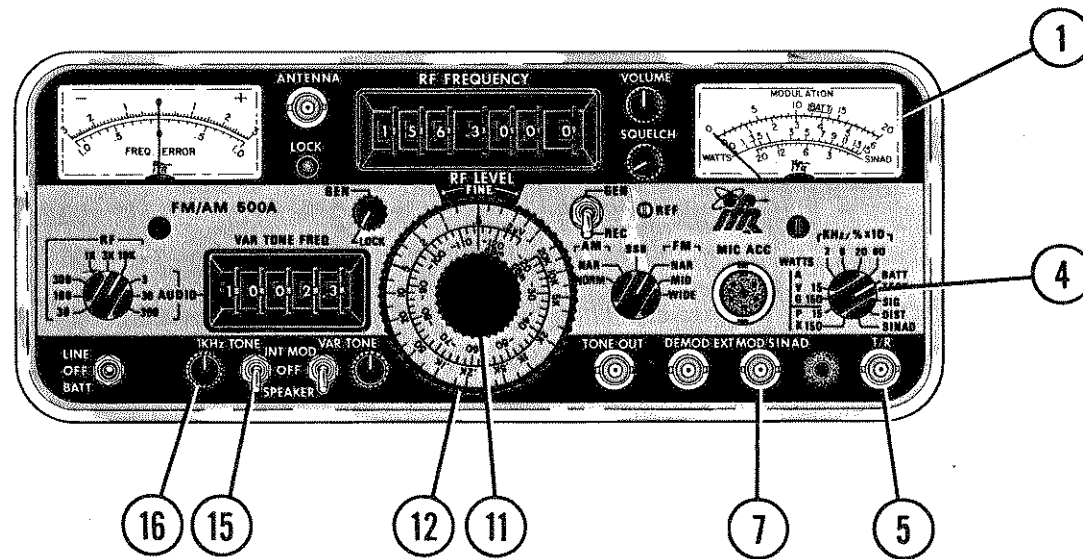

## MEASURING DISTORTION (500A Only)

STEP	CONTROL	SETTING	ACTION/RESULT
1			Connect coax from "5" to receiver RF input.
2			Perform GENERATING RF SIGNALS procedure (see page 25).
3	15	INT MOD or OFF	INT MOD for AM or FM receiver. OFF for SSB receiver.
4	4 16	6 kHz/% As required	Adjust "16" to obtain indication of 4 kHz (for FM) or 30% modulation (for AM) on "1".
5	4 11 & 12	DIST -67 dBm	Connect UUT Audio Output to "7" and read distortion in % on 0-20 scale of "1".

NOTE: When adjusting "16", UUT Audio Output must be disconnected from "7" to prevent UUT audio output from externally modulating the generator and producing a false reading on "1".

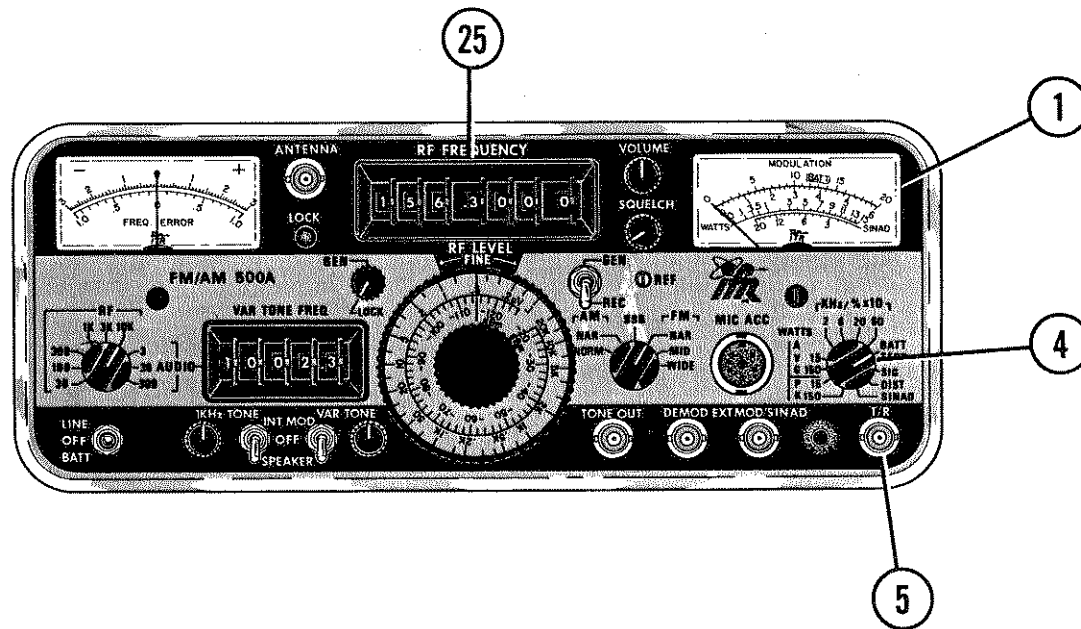

## MEASURING POWER (500A Only)

STEP	CONTROL	SETTING	ACTION/RESULT
1	4		Connect coax from "5" to transmitter RF output.
2	4	As required	Set "4" for AVG (typically for AM or FM) or PK (typically for SSB) at either 15 W or 150 W as required for the UUT. Read the transmitter output power on the 0-15 scale of "1".

NOTE: Power measurement is independent of frequency selected on "25".



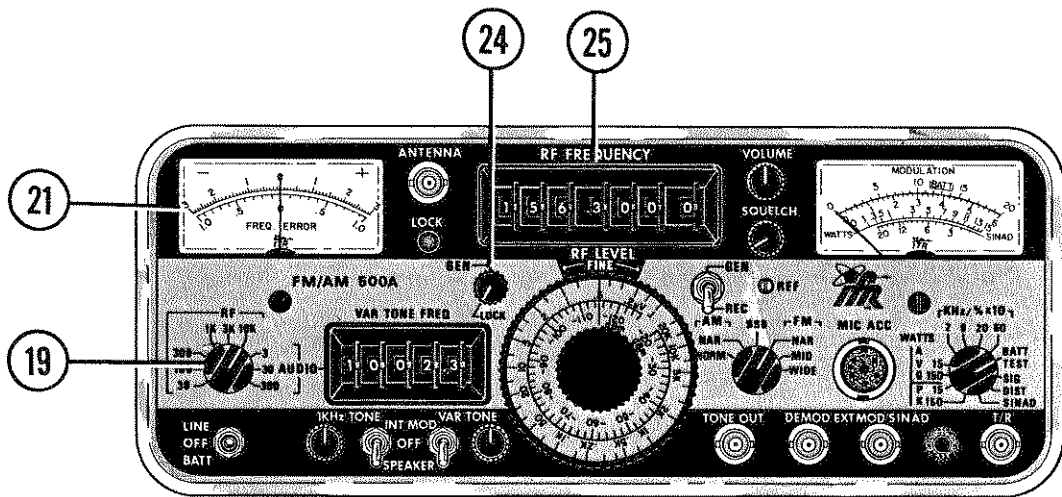

## MEASURING RECEIVER BANDWIDTH

STEP	CONTROL	SETTING	ACTION/RESULT
1			Perform RECEIVER SENSITIVITY procedure (see page 27).
2	19 24	RF 10 K As required	Rotate "24" cw and ccw. Observe receiver band edges on "21". NOTE: If bandwidth exceeds range of "24", proceed with Step 3.
3	25	As required	Rotate "25" up and down as required to determine band edges. "24" may be used in conjunction with "25" if desired.

NOTE: When "24" is out of LOCK position, external modulation is DC-controlled.

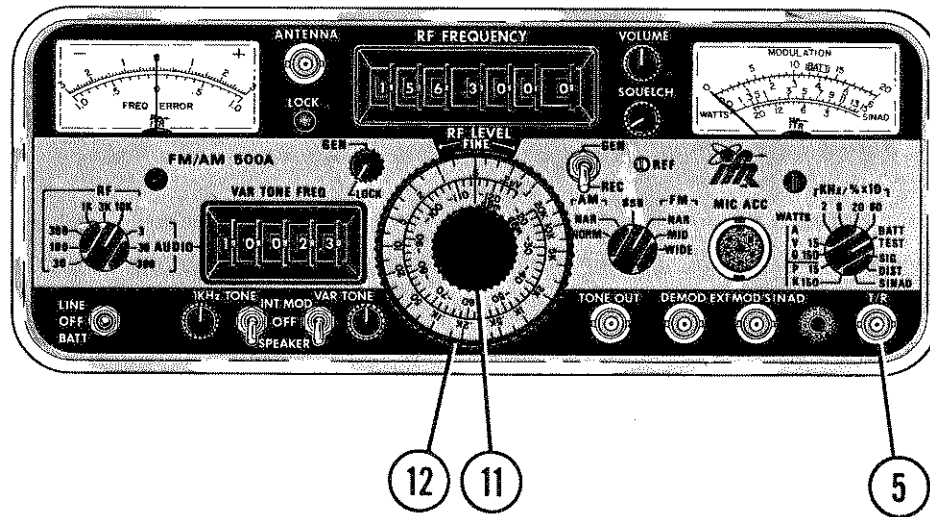

## MEASURING SQUELCH THRESHOLD AND DIFFERENTIAL

STEP	CONTROL	SETTING	ACTION/RESULT
1			Connect coax from "5" to receiver antenna connector.
2			Perform GENERATING RF SIGNALS procedure (see page 25).
3	Squelch (on UUT) 11 12	OFF or mini- mum squelch Full ccw Full ccw	Rotate "11" from full ccw slowly cw to detent where tone becomes audible. Rotate "12" from full ccw slowly cw until tone is barely audible. Record minimum squelch threshold as indicated on "11" and "12".
4	Squelch (on UUT) 11 12	ON or maxi- mum squelch Full cw Full cw	Rotate "11" from position in Step 3 slowly ccw to detent where tone ceases. Rotate "12" cw or ccw as necessary until tone again is barely audible. Record maximum squelch threshold as indicated on "11" and "12".
5			Subtract result in Step 3 from result in Step 4 to determine differential in dB.

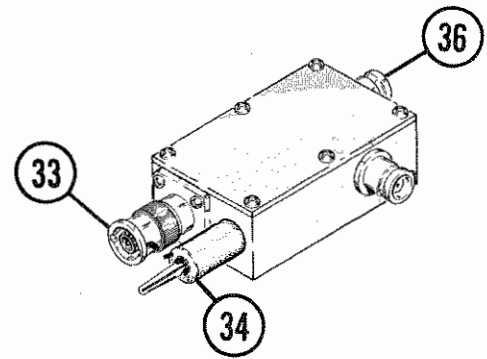
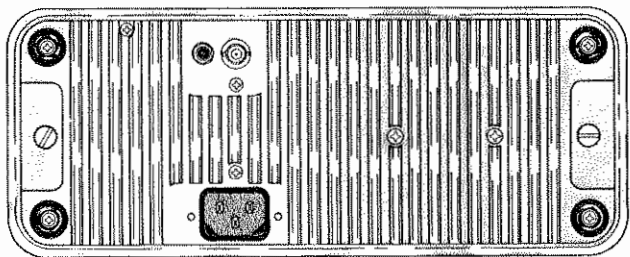
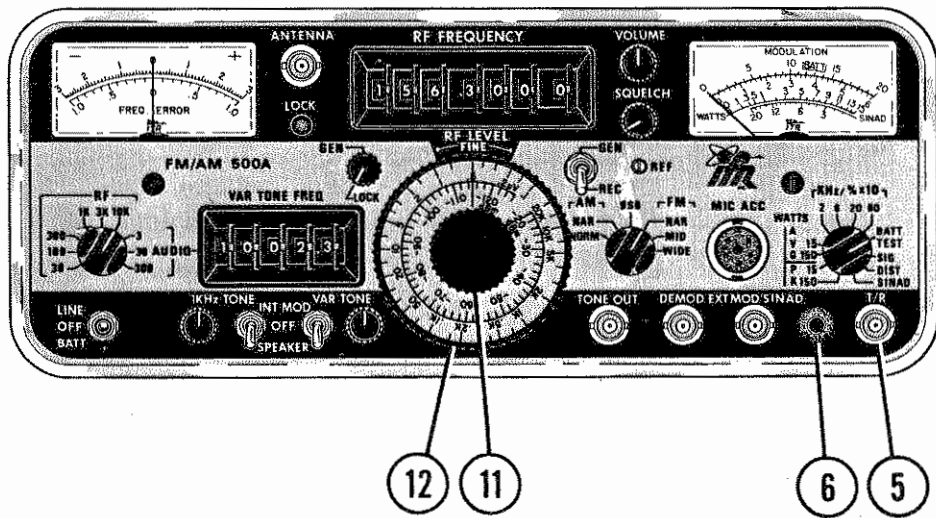

## OPTIONAL GENERATE AMPLIFIER OPERATION

STEP	CONTROL	SETTING	ACTION/RESULT
1			Connect optional Generate Amplifier connectors "33" and "34" to "5" and "6" respectively.
2			Connect coax from UUT to "36".  <b>CAUTION</b> DO NOT TRANSMIT INTO THIS JACK OR DAMAGE TO GENERATE AMPLIFIER AND/OR 500A WILL RESULT.
3			Perform GENERATING RF SIGNALS procedure (see page 25).  NOTE: Output is 30 dB greater than indication on "11" and "12".

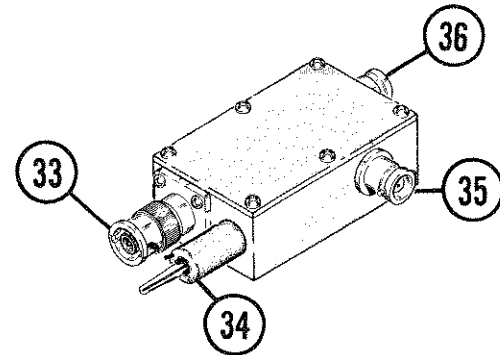
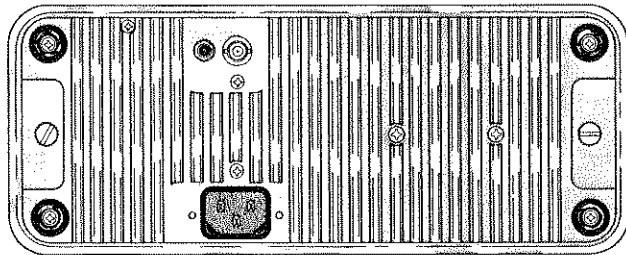
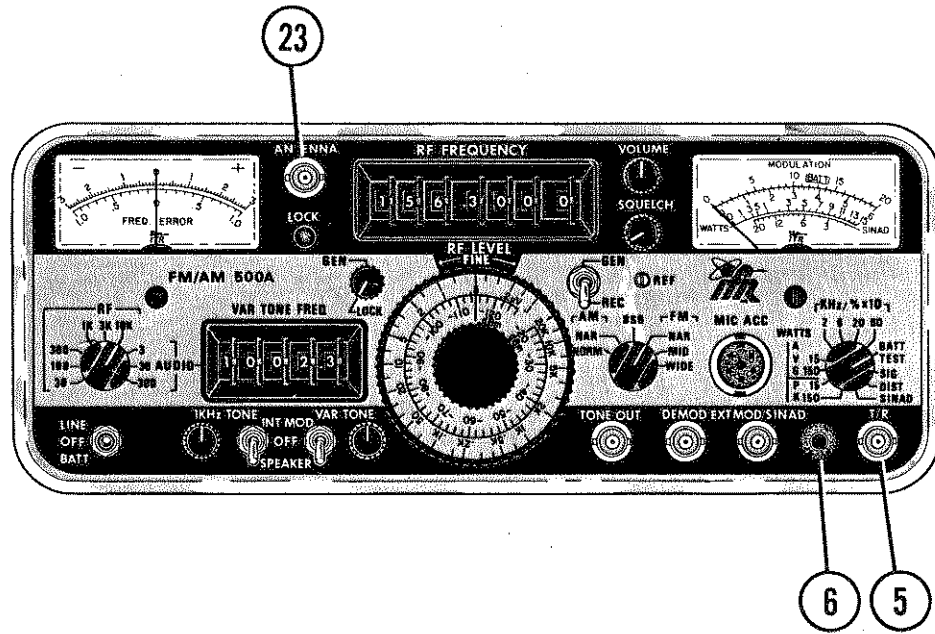

## RADIO INSTALLATION CHECKOUT

STEP	CONTROL	SETTING	ACTION/RESULT
1			Connect Generate Amplifier connectors "33" and "34" to "5" and "6" respectively.
2			Connect antenna to "36". Connect coax between "23" and "35".
3			Perform RECEIVING SIGNALS and GENERATING RF SIGNALS procedures (see pages 15 and 25) to check out radio installation.

WARNING: THIS TEST MUST BE CONDUCTED WITH 500/A AND INSTALLED RADIO INSIDE A SHIELDED AREA TO PREVENT INADVERTENT RADIATION OF RF SIGNALS.



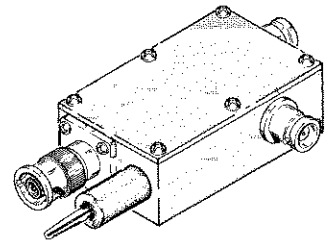
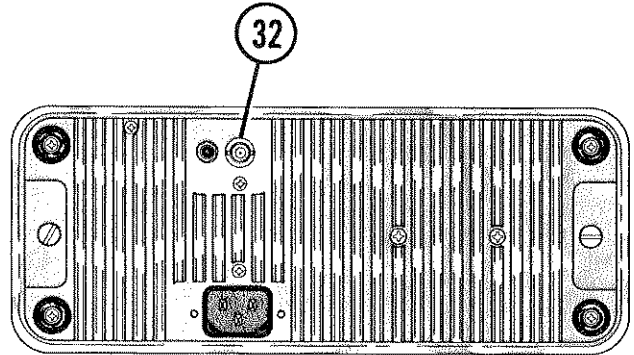
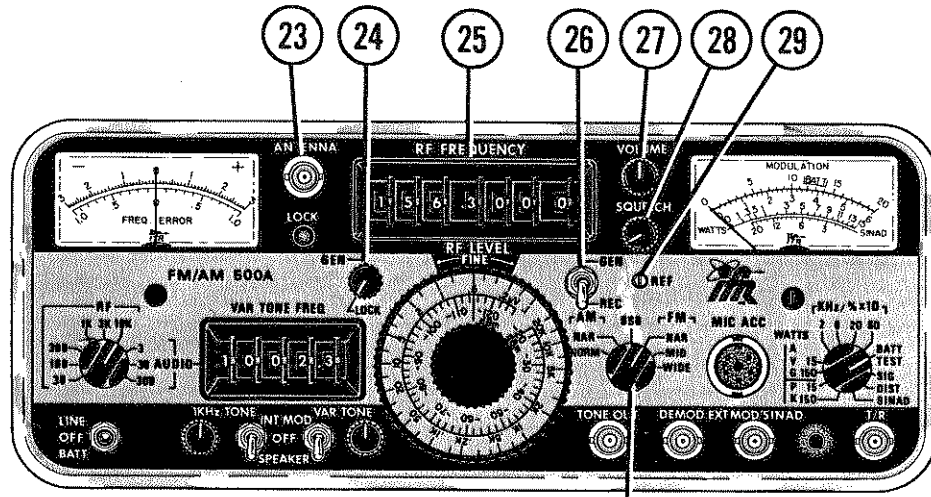

## CALIBRATION TO WWV

STEP	CONTROL	SETTING	ACTION/RESULT
1			Connect antenna to "23". Connect test lead to "32".
2	9 24 25 26 27 28	AM NORM or NAR LOCK 10 MHz REC As required As required	To receive WWV standard, select 10 MHz on "25".
3	29	As required	Adjust "29" for audible zero beat.

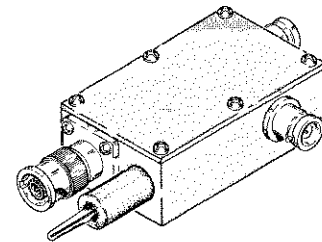
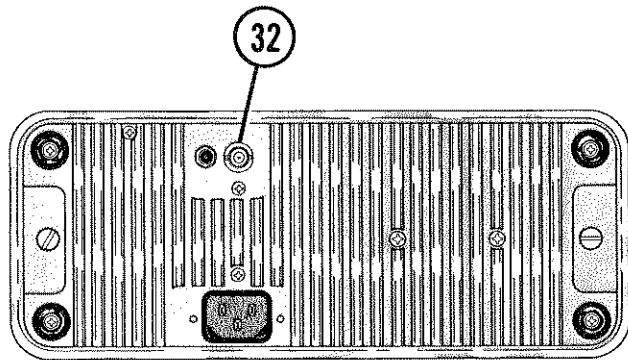
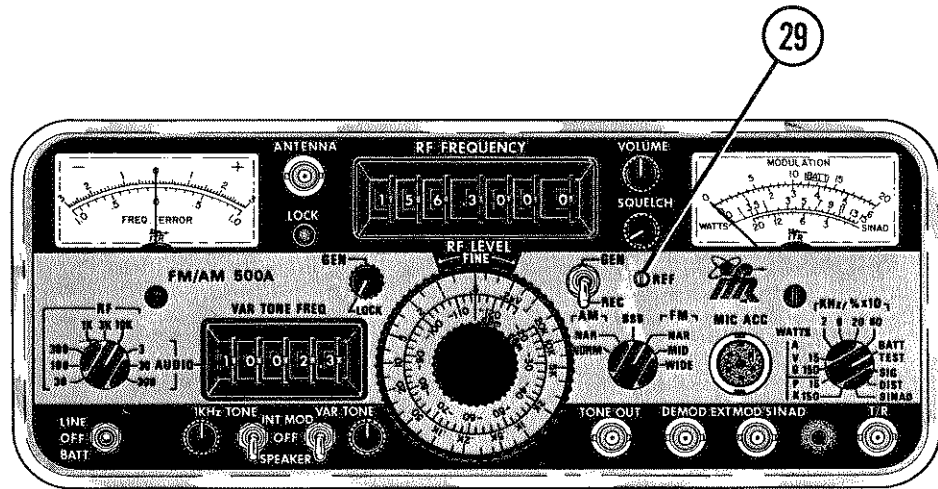

## CALIBRATION TO EXTERNAL FREQUENCY COUNTER

STEP	CONTROL	SETTING	ACTION/RESULT
1			Connect coax to frequency counter and "32".
2	29	As required	Adjust "29" for 10 MHz indication on counter.

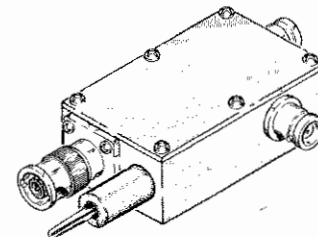
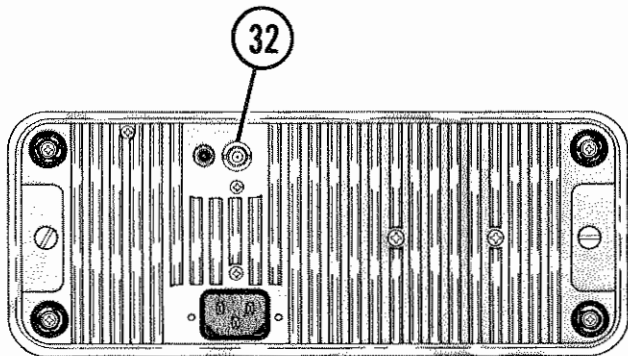
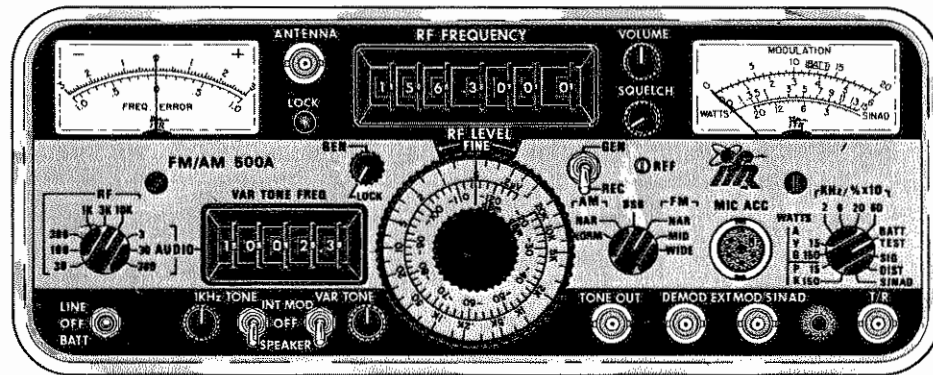

# OPERATION FROM EXTERNAL FREQUENCY STANDARD

STEP	CONTROL	SETTING	ACTION/RESULT
1			Connect coax from external standard to "32".  NOTE: 500/A will automatically switch to external standard when a signal of 1 Vp-p minimum to 5 Vp-p maximum to "32".

# SPECIFICATIONS

## RF SIGNAL GENERATOR

Frequency Range:	250 kHz to 999.9999 MHz in 100 Hz increments
Frequency Accuracy:	Same as Master Oscillator
Variable Generate:	Continuous tuning $\pm 10$ kHz from selected frequency
Residual FM:	< 100 Hz peak, 300 Hz to 3 kHz bandwidth
RF Output Accuracy:	-127 dBm to -20 dBm (10 dB steps with 11 dB range continuous vernier)
RF Output Accuracy:	$\pm 3$ dB
Output Impedance:	50 Ohms Nominal
Output Protection:	Fully protected, 25 Watts continuous, 150 watts for 60 seconds. Auto changeover from generate to monitor will occur at a nominal 100 mW level.
Internal Modulation:	See Audio Generator
External Modulation:	
Frequency Response:	FM: 2 Hz to 30 kHz (DC when in variable generate) AM: 10 Hz to 10 kHz (30% maximum modulation above 5 kHz)
Modulation Sensitivity:	FM: 0.08 VRMS/kHz AM: 0.01 VRMS/%
Distortion (1 kHz tone):	FM: < 1% to 20 kHz deviation AM: < 10% to 60% modulation
Input Impedance:	Greater than 10 K Ohms

## AUDIO GENERATOR\*

Operating Modes:	
Internal:	Modulation/Tone Out level controlled by 1 kHz or Variable Tone Control
Speaker:	Tone applied directly to speaker with volume controlled by 1 kHz or Variable Tone Control
External Plus Internal:	External modulation input is summed directly with tones and applied to modulator
Tone Accuracy:	
Fixed:	Same as Master Oscillator
Variable:	$\pm 0.01\%$
Tone Distortion (at 2.5 VRMS Output):	
Fixed:	0.5%
Variable:	0.5% at 1 kHz, 1.5% 10 Hz to 9999.9 Hz
Tone Output Level:	0 to 2.5 VRMS minimum either tone into 150 Ohm load
Frequency Range (Variable):	10 Hz to 9999.9 Hz in 0.1 Hz increments

\*Variable Tone Generator is optional on FM/AM-500, standard on FM/AM-500A

## GENERATE AMPLIFIER (Optional)

Gain:	30 $\pm$ 2 dB typical, 100 kHz to 1000 MHz
Test Set Output with Amplifier Installed:	Variable to +10 dBm, FM CW Variable to +4 dBm, AM (nominal)

# SPECIFICATIONS

## RECEIVER/MONITOR

Frequency Range: 100 kHz to 999.9999 MHz in 100 Hz increments

Sensitivity: 2  $\mu$ V (1 MHz to 1000 MHz, FM Narrow)

Selectivity:	Mode	RCVR	Audio
		Bandwidth	Bandwidth
	FM WIDE	200 kHz	80 kHz
	FM MID	200 kHz	8 kHz
	FM NAR	15 kHz	8 kHz
	SSB	6 kHz	8 kHz
	AM NAR	6 kHz	8 kHz
	AM NORM	15 kHz	8 kHz

Adjacent Channel Rejection:	RCVR	
	Bandwidth	-40 dB at
	200 kHz	$\pm$ 300 kHz
	15 kHz	$\pm$ 27 kHz
	6 kHz	$\pm$ 12 kHz

Demodulation

Output:

Output

Impedance: 600 Ohms

Output Level (Measured into an open circuit):

FM: 60 mVRMS/ $\pm$  1 kHz

AM: 5 mVRMS/%

Receiver Antenna Input

Protection: 0.25 watts maximum without damage

## GENERAL

Operating Temperature Range: 0 to 50°C

Power Requirements: Line: 105-130/210-260 VAC, 50-400 Hz at 30 Watts typical  
Ext. DC: 12-14 VDC Nominal at 2 AMPS  
Operation on Internal Battery (Optional): Approximately 2 hours

Dimensions: 11.5" wide, 4.9" high, 14.3" deep (29.2 cm W, 12.4 cm H, 36.3 cm D)  
18" deep (45.7 cm D) with lid and handle

Weight (Nominal): 16 lbs. (7.2 kg)  
22 lbs. (9.9 kg) with battery

Standard Accessories: Line Cord  
DC Power Cord  
Flexible Antenna  
Lid

## MASTER OSCILLATOR

Standard TCXO:

Stability: 0.5 PPM (0-50°C)

Aging: 3 PPM first year, 1 PPM thereafter

Optional TCXO:

Stability: 0.2 PPM (0-50°C)

Aging: 3 PPM first year, 1 PPM thereafter

Optional Oven (Prohibits internal battery installation):

Accuracy: 0.05 PPM (0-50°C)

Aging: 1 PPM per year



# SPECIFICATIONS

## FREQUENCY ERROR METER

### RF Counter:

Accuracy:  $\pm$  Master Oscillator  $\pm$ 3% of full scale

### Ranges:

FM/AM-500  $\pm$  10 kHz,  $\pm$  3 kHz,  $\pm$  1 kHz full scale  
High Resolution Option:  
 $\pm$  300 Hz,  $\pm$  100 Hz,  $\pm$  30 Hz full scale)  
FM/AM-500A  $\pm$  10 kHz,  $\pm$  3kHz,  $\pm$  1 kHz,  $\pm$  300 Hz,  
 $\pm$  100 Hz,  $\pm$  30 Hz full scale

### Audio Counter:

FM/AM-500 (with variable tone generator option only)

FM/AM-500A (all)

Accuracy:  $\pm$  0.01% of frequency  $\pm$  6% of full scale  
Ranges:  $\pm$  300 Hz,  $\pm$  30 Hz,  $\pm$  3 Hz full scale

## MODULATION METER (Monitor Mode)

Type: Maximum of positive or negative peak (AM or FM)

### FM Deviation:

Accuracy:  $\pm$  5% of reading  $\pm$  3% of full scale  
Ranges: 2 kHz, 6 kHz, 20 kHz, 60 kHz full scale

### AM% Modulation:

Accuracy:  $\pm$  5% of reading  $\pm$  3% of full scale  
Ranges: 60%, 200% full scale

## SINAD/DISTORTION METER (FM/AM-500A Only)

### SINAD:

Accuracy:  $\pm$  1 dB at 12 dB  
Range: 3 to 20 dB at 1 kHz  
Input Level: 0.25 VRMS to 10 VRMS

### Distortion:

Range: 0 to 20% at 1 kHz  
Input Level: 0.25 VRMS to 2 VRMS

Impedance: 10 K Ohms nominal

## POWER METER (FM/AM-500A Only)

### Accuracy:

1-600 MHz:  $\pm$  7% of reading  $\pm$  3% of full scale  
600-1000 MHz:  $\pm$  20% of reading  $\pm$  3% of full scale

### Range:

0-15 and 0-150 Watts, peak or average responding

### Input Power:

25 Watts continuous, 150 Watts  
60 seconds ON, 5 minutes OFF

### Correlation Chart - dBm to Microvolts at 50 Ω

<b>dBm</b>	<b>μV</b>	<b>dBm</b>	<b>μV</b>	<b>dBm</b>	<b>μV</b>	<b>dBm</b>	<b>μV</b>	<b>dBm</b>	<b>μV</b>	<b>dBm</b>	<b>μV</b>
+14	1,120,000	-11	63,000	-36	3,540	-61	199	-86	11.2	-111	0.630
+13	999,000	-12	56,200	-37	3,160	-62	178	-87	9.99	-112	0.562
+12	890,000	-13	50,100	-38	2,820	-63	158	-88	8.90	-113	0.501
+11	793,000	-14	44,600	-39	2,510	-64	141	-89	7.93	-114	0.446
+10	707,000	-15	39,800	-40	2,240	-65	126	-90	7.07	-115	0.398
+9	630,000	-16	35,400	-41	1,900	-66	112	-91	6.30	-116	0.354
+8	562,000	-17	31,800	-42	1,780	-67	99.9	-92	5.62	-117	0.316
+7	501,000	-18	28,200	-43	1,580	-68	89.0	-93	5.01	-118	0.282
+6	446,000	-19	25,100	-44	1,410	-69	79.3	-94	4.46	-119	0.251
+5	398,000	-20	22,400	-45	1,260	-70	70.7	-95	3.98	-120	0.224
+4	354,000	-21	19,900	-46	1,120	-71	63.0	-96	3.54	-121	0.199
+3	316,000	-22	17,800	-47	999	-72	56.2	-97	3.16	-122	0.178
+2	282,000	-23	15,800	-48	890	-73	50.1	-98	2.82	-123	0.158
+1	251,000	-24	14,100	-49	793	-74	44.6	-99	2.51	-124	0.141
0	224,000	-25	12,600	-50	707	-75	39.8	-100	2.24	-125	0.126
-1	199,000	-26	11,200	-51	630	-76	35.4	-101	1.99	-126	0.112
-2	178,000	-27	9,990	-52	562	-77	31.6	-102	1.78	-127	0.0999
-3	158,000	-28	8,900	-53	501	-78	28.2	-103	1.58	-128	0.0890
-4	141,000	-29	7,930	-54	446	-79	25.1	-104	1.41	-129	0.0793
-5	126,000	-30	7,070	-55	398	-80	22.4	-105	1.26	-130	0.0707
-6	112,000	-31	6,300	-56	354	-81	19.9	-106	1.12	-131	0.0630
-7	99,900	-32	5,620	-57	316	-82	17.8	-107	0.999	-132	0.0562
-8	89,000	-33	5,010	-58	282	-83	15.8	-108	0.890	-133	0.0501
-9	79,300	-34	4,460	-59	251	-84	14.1	-109	0.793	-134	0.0446
-10	70,700	-35	3,980	-60	224	-85	12.6	-110	0.707	-135	0.0398

