

INSTRUCTION MANUAL
MODELS 200, 200A
ELECTROMETER VOLTMETERS

WARRANTY

We warrant each of our products to be free from defects in material and workmanship. Our obligation under this warranty is to repair or replace any instrument or part thereof (except tubes and batteries) which, within a year after shipment, proves defective upon examination. We will pay domestic surface freight costs.

To exercise this warranty, call your local field representative or the plant directly, DDD 216-795-2666. You will be given assistance and shipping instructions.

REPAIRS AND RECALIBRATION

Keithley Instruments maintains a complete repair service and standards laboratory in Cleveland, and has authorized field repair facilities in Los Angeles and Albuquerque.

To insure prompt repair or recalibration service, please contact your local field representative, or the plant directly, before returning the instrument.

Estimates for repairs, normal recalibrations, and calibrations traceable to the National Bureau of Standards are available upon request.

TABLE OF CONTENTS

<u>Title</u>	<u>Page</u>
Section I. General	1-1
Table of Specifications	1-2
Section II. Description	2-1
Section III. Operation	3-1
Connections	3-1
Range	3-1
Zero	3-1
Measurement	3-1
Increasing Voltage Sensitivity	3-3
Alternative Methods of Recording	3-3
Uses	3-3
Section IV. Maintenance	4-1
Battery Replacements	4-1
Tube Replacement	4-1
Recalibration Instructions	4-1
Insulation Resistance	4-2
Schematic Diagrams	
Appendix - Uses	

SECTION I - GENERAL

The Keithley Vacuum Tube Electrometers provide rapid and accurate measurements of dc voltage in circuits having extremely high internal resistance, and for dc applications where no current can be drawn from the voltage source. They are also widely used as micromicroammeters, megohmmeters, and static detectors. The instruments contain a subminiature electrometer tube which operates from batteries within the case. Highly stable circuits insure long battery life, very low drift, instantaneous warmup, and accurate calibration over long periods of time. Principal characteristics are:

A. Ranges, Model 200: The two ranges are 2 volts and 20 volts full scale; the pointer can be electrically zeroed at any point on the scale to read positive or negative inputs.

Ranges, Model 200A: The two ranges are 2 volts and 8 volts full scale; the pointer can be electrically zeroed at any point on the scale to read positive or negative inputs.

B. Input Impedance: The input circuit has a resistance higher than 10^{14} ohms in parallel with a capacitance of 8 micro-microfarads.

C. Grid Drift Current, Model 200: The open grid drift current is less than 5×10^{-14} ampere on the 2-volt range, and 5×10^{-13} ampere on the 20-volt range. This means that with the HI input terminal floating, the meter pointer will drift across the scale on either range in approximately three minutes. The drift rate is reduced when capacitance is connected across the input terminals, and no drift or zero displacement is observable if a resistance of 10^{12} ohms or less is connected across the input terminals.

Grid Drift Current, Model 200A: The open grid drift current on the 2-volt range is less than 5×10^{-14} ampere, just as in the Model 200. On the 8-volt range the current is less than 2×10^{-13} ampere.

TABLE OF SPECIFICATIONS

RANGES: Model 200: Zero to 2 Volts; Zero to 20 Volts.
Model 200A: Zero to 2 Volts; Zero to 8 Volts.

ACCURACY: 2% of full scale.

ZERO DRIFT: Less than 1% per hour after a 2-hour warmup.

INPUT IMPEDANCE: More than 10^{14} ohms, 8 micro-microfarads.

GRID CURRENT: 5×10^{-14} ampere maximum.

OUTPUT BANDWIDTH: DC to 20 kc.

MAXIMUM NOISE LEVEL: 0.5% of full scale.

INPUT PROTECTION: 1 megohm.

OUTPUT GAIN: About .65 on each range.

OUTPUT IMPEDANCE: 50 K (Loads under 5 megohms affect meter reading).

POWER REQUIREMENTS: Batteries: One D cell, two type 411, seven penlight cells.
D cell life, 200 hours; others, 800 hours.

TUBE COMPLEMENT: One 5886.

DIMENSIONS: 8 in. high X $5\frac{1}{4}$ in. wide X 4 in. deep.

WEIGHT: 5 pounds.

SECTION II - DESCRIPTION

The equipment layout and circuit schematic diagrams are enclosed at the back of the bulletin.

- A. Meter: The large meter on the face of the instrument indicates the dc potential in volts across the input terminals.
- B. Selector switch, Model 200 (OFF-20-2): The right hand knob on the panel turns the instrument off or to the 20- or 2-volt ranges.
- Selector switch, Model 200A (OFF-8-2): The right hand knob on the panel turns the instrument off or to the 8- or 2-volt ranges.
- C. Zero: The knob at the left is the electrical zero adjustment; with it, the meter pointer can be set to any point on the scale with the input terminals connected together. The scale is marked for zero at the left and for zero at the center.
- D. Input Terminals: The input terminals are HI and ground.
- E. Output Terminals: The output terminals of the Models 200 and 200A electrometers are located on the panel to the right of the range switch. The white terminal is connected to the cathode (F-) of the electrometer tube; the black terminal is marked LO and is connected to ground. Thus, the terminals permit the use of the electrometer tube as a cathode follower. 10 megohms is the minimum permissible load resistance for less than 2% change in the panel meter sensitivity. Table I, below, gives the voltage gain and zero offset (the voltage between the two output terminals with the electrometer input short-circuited and the panel meter set to zero) for the three ranges of the battery electrometers.

Table I

Range	Voltage Gain	Zero Offset
2.0 volts	0.54	2.6 volts
8.0	0.68	4.6
20.0	0.66	7.6

F. Input Switch: The input switch S2, is depressed while setting the instrument zero. It connects the tube grid to the low side of the circuit. The one-megohm resistor, R1, prevents short-circuiting the circuit under test.

G. Calibration Controls: The two range calibration controls, R7 and R8, are accessible through holes in the back of the case. CAUTION -- DO NOT ADJUST THESE CONTROLS WITHOUT REFERRING TO THE RECALIBRATION INSTRUCTIONS ON PAGE 4-1.

H. Batteries and Tube: The batteries and tube are readily accessible by removing the panel from the case.

SECTION III - OPERATION

The Model 200 and Model 200A Vacuum Tube Electrometers are shipped complete with a fresh set of batteries, and are accurately calibrated at the factory. Numerous applications and circuit possibilities for use of these instruments are discussed in the appendix.

A. Connections: The HI terminal should be connected to the high resistance, or highly insulated terminal, of the circuit under test. Ground is the other input terminal.

B. Range, Model 200: Set the range switch at the 2-volt or 20-volt position as required to read the voltage across the input terminals. In measuring potentials over 20 volts, the ground terminal can be raised in potential to approximate the source voltage and the difference read on the Electrometer, as discussed on page 1A. Or, if a shunt resistance of 10^{12} ohms across the source is permissible, 100:1 and 1000:1 Voltage Dividers, Models 2006 and 2007 respectively, may be used to extend the maximum voltage to 20,000 volts.

Range, Model 200A: Set the range switch at the 2-volt or 8-volt position as required to read the voltage across the input terminals. In measuring potentials over 8 volts the methods discussed on page 1A may be used, or, if a 10^{12} ohm load is permissible, 100:1 and 1000:1 Voltage Dividers, Models 2006 and 2007 respectively, may be used to extend the maximum voltage to 8000 volts.

Be certain that the range switch is in the OFF position after using the instrument to avoid unnecessary discharge of the batteries.

C. Zero: The instrument should be zeroed by depressing the input switch and rotating the ZERO knob to bring the meter pointer to the desired zero. If the voltage to be measured is positive, use the zero point at the left of the scale to take advantage of the full scale range; if the voltage changes sign or is negative, use the mid-scale zero; or zero at the right for large negative potentials. Depressing the input switch connects a one-megohm resistance across the input terminals. If charged capacitors are in the circuit under test, they will be discharged or brought to the proper initial state of charge, as the case may be, when the input switch is closed. In any case, the one-megohm resistor prevents high surge currents from flowing.

D. Measurement: Read the voltage directly on the appropriate scale, keeping in mind the full-scale voltage corresponding to the position of the range switch. At this point, several precautions should be mentioned.

1. Shielding: Circuits with internal resistance less than 10^{10} ohms can usually be shielded adequately against stray electrostatic and power frequency fields by keeping the HI lead short — no more than a few inches long.

It is sometimes necessary to enclose the highly insulated portion of the circuit and lead to the HI terminal in an electrostatic shield. Support insulators may be fashioned from polystyrene or polyethylene stock. The importance of rigid supports cannot be overemphasized, especially if the shield is at a high potential with respect to the HI terminal. Small relative motions

of these parts cause the capacitance of the system to change, and as the charge remains constant, large changes in potentials result from the motion, as in the familiar condenser microphone. Frictional electricity which results from the HI leads moving over the surface of an insulating support can also cause annoying disturbances.

2. Time Constant: The RC time constant of the measurement circuit begins to approach one second when the resistance across the input terminals of the Electrometer gets above 10^{11} ohms, for the input capacitance is about 6 mmf. To get accurate readings, it is necessary to wait until the pointer stops moving. The inherent circuit drift of the Electrometer is very low, so that any drift that is apparent can usually be attributed to drift in the circuit under test or to slow recovery in circuits having extremely long time constants.

The most significant exception is that upscale drift will occur if there is no resistor across the input terminals of the Electrometer and the capacitance between these terminals is low or virtually only the internal capacity of the instrument. Here, the reverse grid current of the tube charges the circuit being measured and the pointer drifts slowly upscale.

3. Correction for Grid Current: The grid current of the Electrometer may be measured by timing the open-grid drift upscale.

$$I = C \frac{E}{t} = 6 \times 10^{-12} \frac{E}{t} \text{ ampere}$$

In making this test the HI terminal should be shielded, preferably by a metal tube large enough to slip over the guard ring. The following table illustrates the grid current computations for the different ranges:

RANGE	E_0	E_t	Δt	i_c
2 volt	0	0.2 volt	24 sec.	5.0×10^{-14} ampere
8 volt	0	0.8	24	2.0×10^{-13}
20 volt	0	2.0	24	5.0×10^{-13}

Alternatively, the grid current may be measured by observing the voltage across a known high resistance connected between the input terminals.

$$I = \frac{E}{R}$$

R must be at least 10^{12} ohms, giving a long time constant, and steady state conditions must be reached before reading E. The grid current is approximately constant over the 2-volt range, but on the 20-volt range, it is greatest near zero volts and decreases considerably as HI is made more positive.

The grid current may be abnormally high if the tube has not been in use for a long period. After an hour's operation the grid current should fall to within the normal limits.

In low current circuits, the grid current must be subtracted (algebraically) from the total current read to give the correct current in the circuit being measured.

4. Correction for Input Capacity: It must be remembered that the internal capacitance of the Electrometer shunts any external capacitance connected to the input terminals. The internal capacity is approximately 6×10^{-12} farad, and corrections must be made if this is appreciable compared to an external capacitor whose voltage is being measured.

E. Increasing Voltage Sensitivity: The panel meter on the Models 200 and 200A has a 0-50 microampere movement. If a more sensitive galvanometer were connected in series with the panel meter, the voltage sensitivity of the electrometer, as read on the galvanometer, would be proportional to the increase in sensitivity afforded by the galvanometer. The limitation of the increase in most cases comes when the zero control of the electrometer becomes too coarse.

F. Alternative Methods of Recording: An alternative way to record is to connect a galvanometer in series with the panel meter, whose movement is 0-50 microamperes. Photographic recording is most common with the mirror galvanometers. The General Electric Photoelectric recorder, however, has also found use; here, the mirror galvanometer actuates a photoelectric servo system, and a pen recorder is made to follow the galvanometer deflections. The meter connections are made accessible by removing the cabinet, then removing the battery tray.

G. Uses: Typical applications of the Electrometer are described in the Appendix. The suggested circuits are indicative of the many uses of the instrument in measuring voltage, current, charge, capacitance, resistance, and various capacitor parameters more quickly and accurately than was previously possible.

In many cases the circuit arrangement is greatly simplified through the use of the various Keithley Electrometer accessories. These include shunts, voltage dividers, a test voltage supply, and a static detector, listed in the descriptive literature included with the instruction manual.

SECTION IV - MAINTENANCE

The Keithley Model 200 and Model 200A Vacuum Tube Electrometers have been designed to give long, trouble free service; the only regular attention necessary is the occasional replacement of batteries. The tube should give several thousand hours service in normal use. The sensitivity adjustments at the rear of the instruments do not require attention throughout the life of the batteries. The calibration, nevertheless, should be rechecked occasionally, and particularly after replacing the tube.

A. Battery Replacement: To check the batteries, remove the panel from the case by removing the six No. 4 sheet metal screws around the edge of the panel. Then remove the battery cover plate by removing the two screws holding it.

Low batteries may cause the zero to shift beyond the range of the zero control; they may cause rapid drift, or high forward grid current. Since the D cell (flash-light cell) has the shortest rated life, it should be checked first; it should be replaced if it measures below 1.1 volts, using a 1000-ohms-per-volt meter.

The miniature B batteries should be replaced if they measure less than 12 volts. If they are too low, the zero control cannot be advanced far enough clockwise to zero the instrument at full scale on either scale. Low B batteries also cause high forward grid current on the high end of the 20-volt scale. This is evident if the zero is set at full scale and the meter drift observed with the input terminals open. The pointer moves quickly downscale, and stops at about 3/4 full scale. This behaviour indicates that the B batteries should be replaced. Low penlight cells cause the same effect on the 2-volt range. These cells should be replaced if the series voltage of the 10.5-volt group goes below 7 volts. Low batteries have very little effect on the calibration of either range, down to the point where the instrument cannot be zeroed to full scale. When replacing batteries, it is essential that the indicated polarities be observed.

B. Tube Replacement: The tube should give thousands of hours of service in this application, but it can easily be replaced with a Keithley Instruments Part EV-5886-3 (Model 200) or EV-5886-4 (Model 200A) if it becomes damaged.

Observe caution when replacing the tube: DIRT or MOISTURE from the HANDS will cause leakage from the base of the tube to the grid lead, which impairs the operation of the instrument in measuring low currents. Connect the leads as shown in DR 10299 or 10446, Figure 3.

New tubes sometimes exhibit large reverse grid current, which falls to normal value after an hour's operation.

C. Recalibration Instructions, Model 200: To reset the sensitivity, a voltmeter to read 1.5 volts and 15 volts to 2% is required for comparison. Calibration at these two points on the 2-volt and 20-volt scales gives the best overall accuracy. The 20-volt scale is calibrated by applying 15 volts, zeroing the meter by closing the input switch, and adjusting the pointer to 15 volts with the calibration control at the back of the instrument. This adjustment has a small effect on the zero setting, so the process should be repeated several times to obtain an accurate setting. The same procedure is followed with the 2-volt scale, except 1.5 volts are applied to the input terminal.

Recalibration Instructions, Model 200A: The procedure is the same as above, except 6 volts are applied to calibrate the 8-volt range.

Adjustments of the calibration control for one range do not affect the other range in either instrument.

D. Insulation Resistance: Clean insulation is essential for a high input resistance. The resistance should always be sufficiently high to permit reading grid current by observing the open circuit meter drift (Section III-D-3). To clean the insulation supporting the HI terminal and supporting the input resistor inside the case, dust it with a small brush, or if necessary wash it lightly with carbon tetrachloride. Spurious static charges may accumulate on the insulation after cleaning, necessitating a wait of several minutes after cleaning before operation can be resumed.

The insulation resistance will be lowered by extremely high humidity, but the excellent high resistance properties return when the humidity decreases.

E. Severe Damage: If the instrument cannot be calibrated by following the procedure outlined above, factory repairs are recommended.

REVISIONS			
LTG	ECC NO.	APPR.	DATE
A			

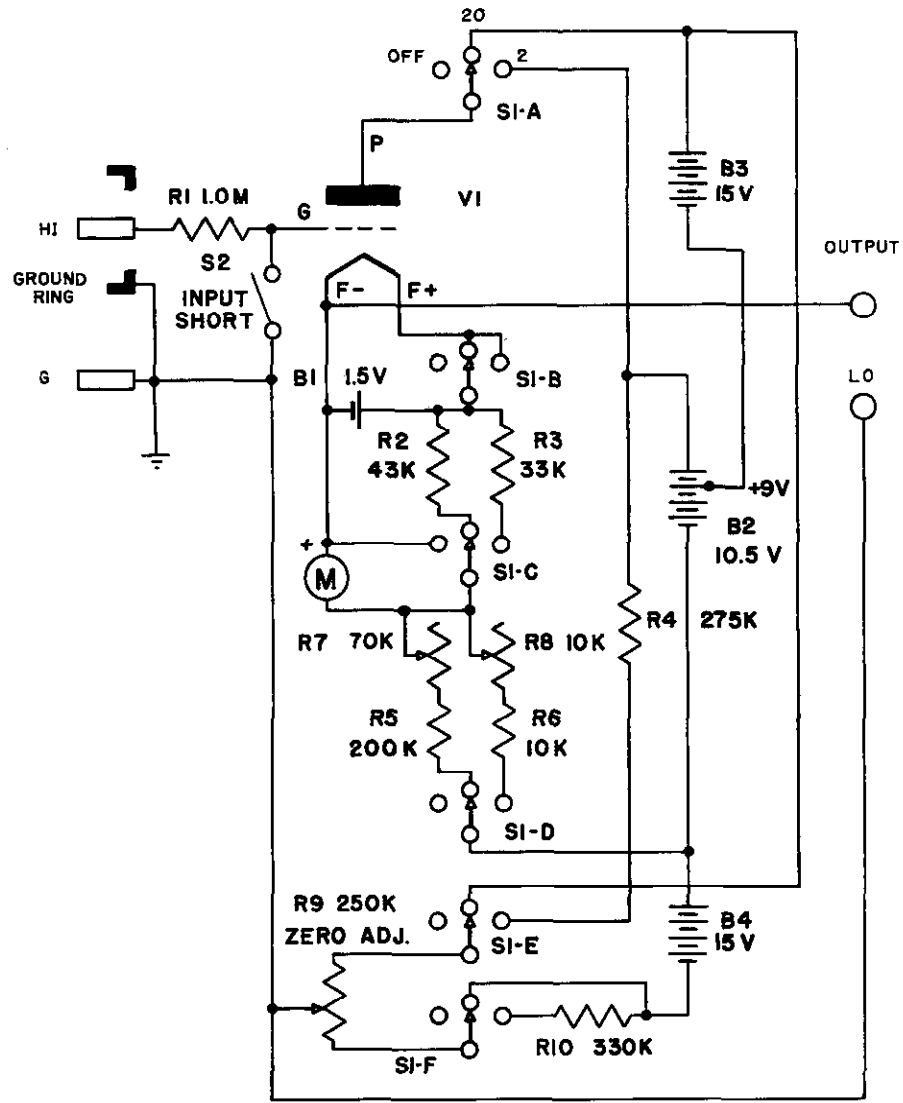

FIG.1 CIRCUIT SCHEMATIC DIAGRAM

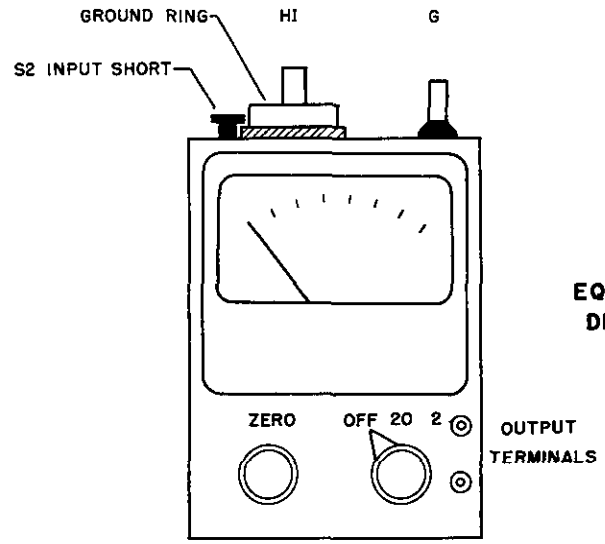

FIG.2 EQUIPMENT DIAGRAM

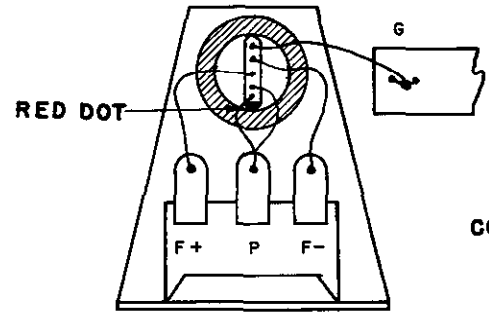

FIG.3 TUBE CONNECTIONS

MODEL 200 VACUUM TUBE ELECTROMETER

CONFIDENTIAL
 PROPERTY OF KEITHLEY INSTRUMENTS, INC.
 IS NOT TO BE USED OR REPRODUCED EXCEPT
 AS AUTHORIZED BY THE COMPANY.

DIMENSIONAL TOLERANCES UNLESS OTHERWISE SPECIFIED			DRN <i>Can</i>	DATE 2-8-63
FRAC.	DEC.	ANG.	CKD.	DATE
± 1/64	± .005	± 1°	ENG. APPR.	DATE
DO NOT SCALE			PILOT RELEASE	DATE
			PROD. RELEASE	DATE

KEITHLEY INSTRUMENTS
 CLEVELAND, OHIO

TITLE	
PART NUMBER	10299C

MODEL NEXT ASSEMBLY QUANT. USED ON

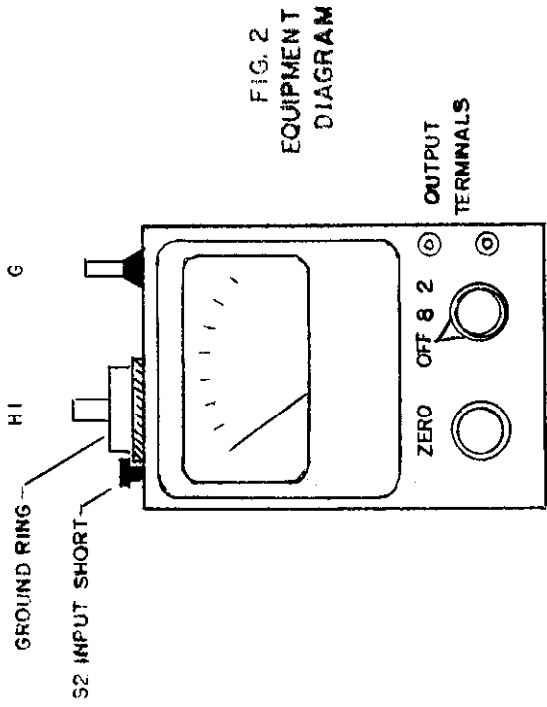

FIG. 2
EQUIPMENT
DIAGRAM

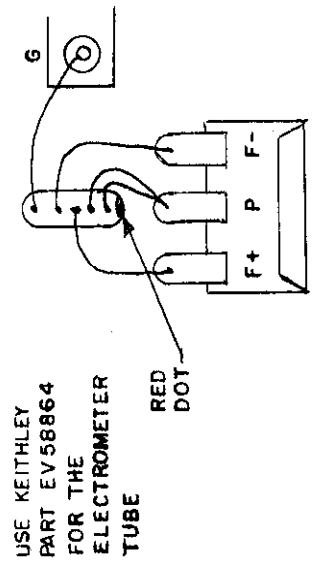

FIG. 3 TUBE CONNECTIONS

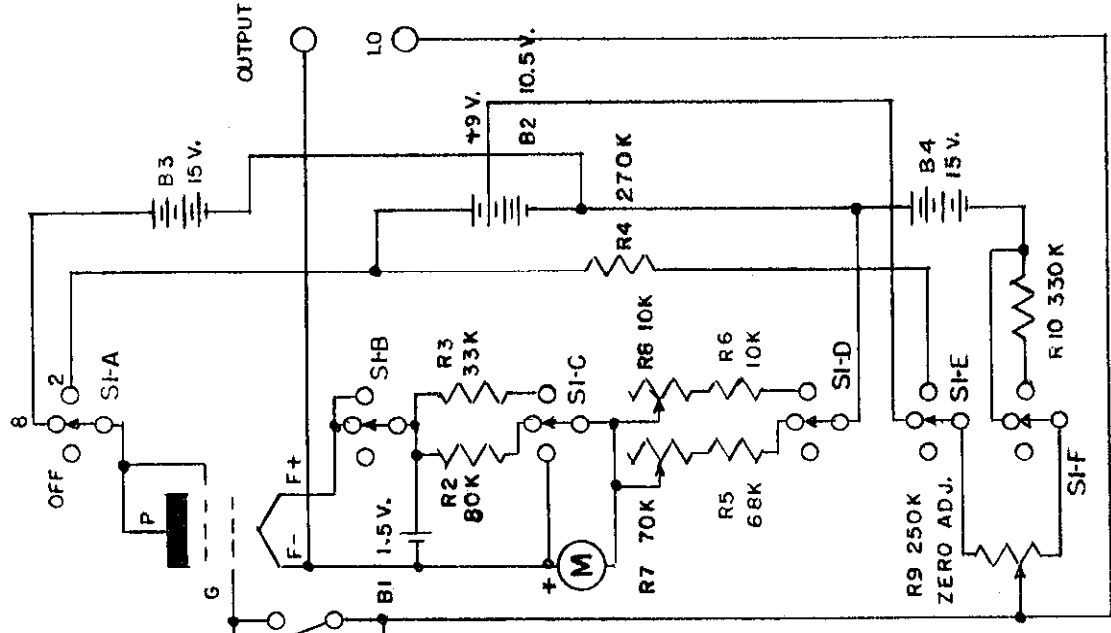

FIG. 1 CIRCUIT SCHEMATIC DIAGRAM

CONFIDENTIAL
PROPERTY OF KEITHLEY INSTRUMENTS, INC.
NOT TO BE USED OR REPRODUCED EXCEPT
AS AUTHORIZED BY THE COMPANY

MODEL 200A VACUUM TUBE ELECTROMETER				
KEITHLEY INSTRUMENTS CLEVELAND, OHIO				
DR	DATE	CH	DATE	DR 10446 -A

APPENDIX - USES

Typical applications are included on the next few pages to indicate the many measurements which the Electrometer and its accessories can make accurately and quickly. Full operating instructions for the various accessories are included in the last section of this book.

TYPICAL POTENTIAL MEASUREMENTS

High resistance source within scale range. The high resistance or highly insulated terminal of the source is connected to the HI terminal of the Electrometer. The voltage is read directly, as described previously under OPERATION.

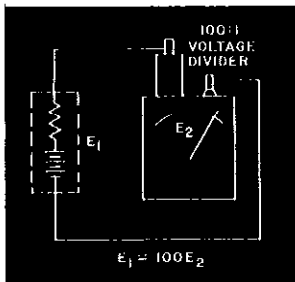
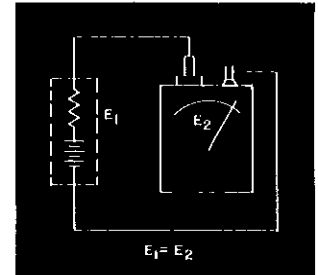

High resistance source, less than 20,000 volts. The Keithley Models 2006 and 2007 voltage dividers, (100:1 and 1000:1 ratios), convert the Electrometer into an extremely sensitive kilovoltmeter. 10^{12} ohms input resistance.

High resistance source, buckout method. An additional voltage source, such as the Keithley Model 2004A, is used to buck out most of the voltage, and the difference is read on the Electrometer. To avoid having excessive grid current flow through the unknown voltage source, the bucking voltage should be made more positive than the unknown voltage initially, then reduced until the difference can be read on the Electrometer. In this application the G terminal potential should not be made greater than about 50 volts from ground.

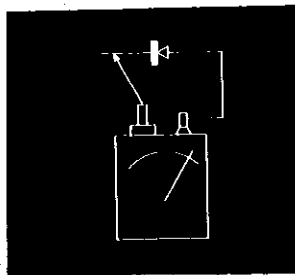
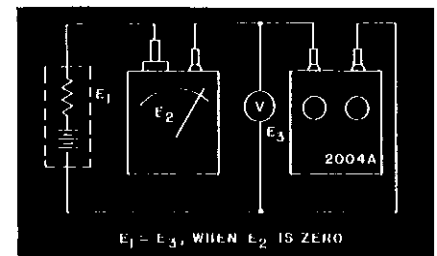

Surface contact potentials in semi-conductors or thermionic devices. The measurement is made by direct connection to the Electrometer.

Piezo-electric potentials. The electrode which provides the best shielding is connected to the G terminal. The other electrode is connected to the HI terminal. The electrometer reads the instantaneous voltage at the terminals of the crystal at low frequencies. The HI lead should be connected so that it does not move appreciably, particularly with crystals which have low internal capacitance.

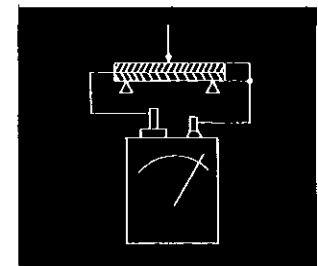

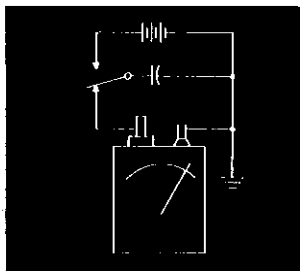

Potentials of charged capacitors. Connect HI to the high impedance terminal and G to the low impedance terminal, being careful not to discharge the capacitor through low resistance paths while making the connections. The voltage is read directly.

Vacuum Tube electrode potentials. The Electrometer is well suited to measuring electrode potentials in vacuum tube circuits, for only a very slight disturbance is caused by its connection, even in high resistance circuits. This is particularly desirable in dc amplifier work where small variations in potential can be greatly amplified, upsetting the normal operating conditions. The HI terminal is connected to the electrode, and G to ground or an auxiliary potential source depending on the magnitude of the voltage to be measured. As shown, a voltage divider is being used to permit measurement of the screen potential. An alternative method would be the buckout method described above.

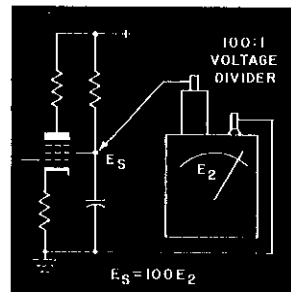

The presence of a large ac signal at the electrode being measured can cause an erroneous reading, because of rectification in the electrometer tube grid circuit. The peak value of the ac signal should be held within the voltage of the scale range used, or a simple signal filter which passes only the dc component can be used.

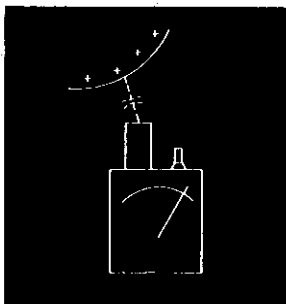

Static charge detection. The Electrometer is extremely sensitive to static charges, and can be used to make both qualitative and quantitative measurements. Addition of the Model 2005 Static Detector accessory, shown here, permits varying the sensitivity of the Electrometer, and confines the sensitivity to a small cone along the axis of the detector, permitting quick location of charged objects.

Equipotential contour plotting in an electrolytic analogy tank. The Electrometer is a particularly useful instrument for electrolytic field plotting. Conventional techniques are employed, dc potential is applied, and a high resistance electrolyte is used. In addition to the usual following of preset equipotential lines, the potential of any point can be read directly.

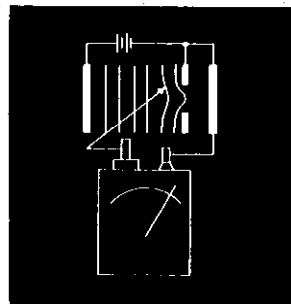

TYPICAL CURRENT MEASUREMENTS

The Electrometer is converted quickly to a micromicroammeter by use of the Keithley Decade Shunt, Model 2008, which permits accurate measurements as low as 5×10^{-14} ampere.

Photoelectric cell current. With very high shunt resistances, small currents which represent very low levels of illumination can be measured. It is important to keep the leakage across the photocell and its connector low, for the measured current should be predominantly emission current. The G terminal should always be kept at ground potential. Mass spectrometer currents and inverse currents in semi-conductors can easily be measured by the same direct method.

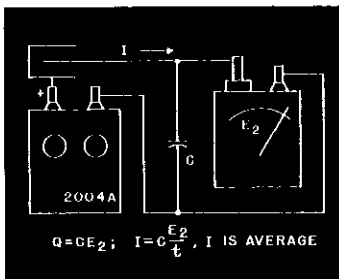
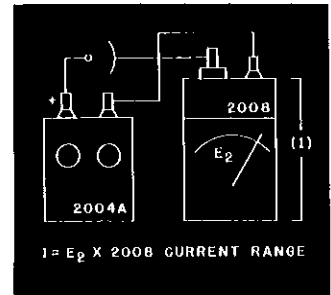

Ion Chamber current by accumulation of charge, or measuring total accumulated charge. Current from sources such as photoelectric cells or ion chambers can be measured by the rate of accumulation of charge on a known capacitance. Discharge C , and observe the increase of E_2 with time.

The current, derived from the relationship in the diagram, is the magnitude of a constant current or the average value of a varying current. The value of C determines the rate of rise, and should be chosen so that the time can be read accurately. A low leakage capacitor should be used. The electrometer can be removed from the circuit during the accumulation to prevent its grid current from charging the capacitor.

The total accumulated charge resulting from an instantaneous exposure of a photocell to light or an ion chamber to radiation can also be measured with this circuit. E_2 , the capacitor potential, is made zero initially, and the accumulated charge is CE_2 , as indicated.

It is essential that the charge originate in an infinite impedance source such as a photocell or an ion chamber.

The charge Q is a measure of the total radiation dose when an ion chamber is the current source. When a photocell is the current source, the charge is a measure of the total light falling on the cell and corresponds to photographic exposure.

TYPICAL RESISTANCE MEASUREMENTS

The Keithley Electrometer can be used for accurate measurement of resistances up to approximately 10^{16} ohms. Here are three suggested methods:

Insulation leakage resistance. Make the connections as shown, and allow the circuit to come to equilibrium after releasing the input switch.

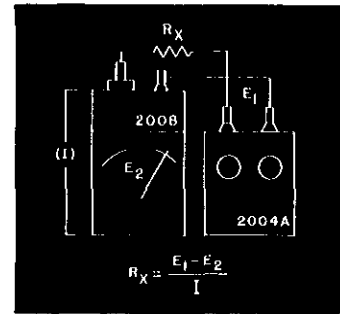

It should be noted that high resistances often do not follow Ohm's law, but exhibit appreciable voltage coefficients of resistance. This effect is observed by trying various values of E_1 . The voltage across R_X must be kept within the manufacturer's rating, or the voltage coefficient of the standard will introduce some error.

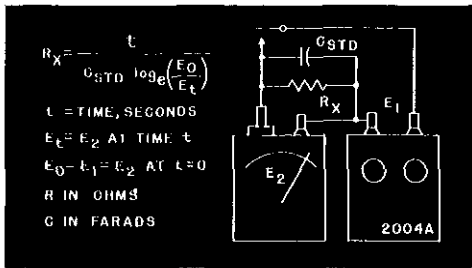

High Resistance by the Charge leakage method.

High resistances may be measured with the Electrometer, a good capacitor (leakage resistance high compared with the unknown), and a stop watch. In the illustration a Keithley Regulated Voltage Supply is used as a convenient charging source. Once the capacitor is charged, the switch is released, the decay of E_2 with time is observed, and the unknown resistance is computed.

The leakage resistance of the capacitor may be determined by omitting R_X from the circuit.

This measurement method can also be used to determine the deviation of the capacitor and leakage resistance from the ideal relationship. By plotting the decay of voltage with time on semi-log graph paper (time-linear, voltage-logarithmic), departure from a straight line indicates the presence of factors other than R and C . Such a capacitor probably cannot be used for accurate integrating over long periods of time. If C has little capacitance, correction should be made for the internal capacitance of the Electrometer, Section III. In extreme cases it may also be necessary to correct for grid current, Section III.

High Resistance by Wheatstone Bridge Method. Accurate measurements of high resistances can be made by using the familiar Wheatstone Bridge. The Ratio Arms, R_A and R_B , of relatively low resistance, are adjusted until the Electrometer reads zero. The voltage coefficients of the standard and the unknown can affect the balance point; this can be checked by varying the battery voltage.

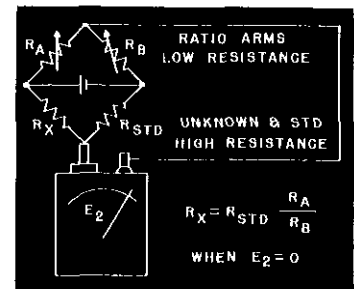

TYPICAL CAPACITANCE MEASUREMENTS

Measurement of Capacity by Charge leakage method.

This uses the same circuit as measuring resistance by the charge leakage method except a Keithley Shunt is used as a standard resistance and the equation is solved by capacitance. Thus, a standard high resistance can be used to measure the capacity of a low leakage capacitor.

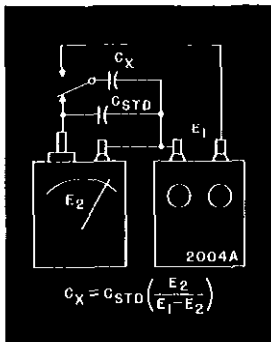
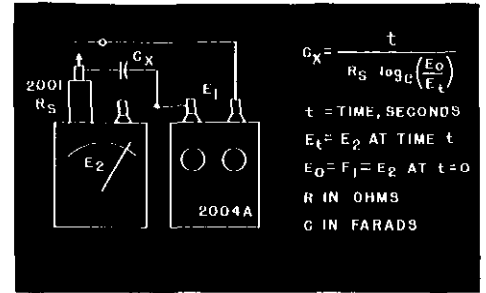

Measurement of capacity, parallel capacitors. Switch C_x and C_{STD} in parallel, and discharge the system. Switch C_x to E_1 , charging it. Finally, switch C_x across C_{STD} and the Electrometer. The charge is conserved and the unknown capacitance is computed.

Measurement of capacity, series capacitors. Switch C_x to ground, discharging both capacitors. Switch C_x to connect E_1 across the capacitors in series. The charges will be equal on both capacitors, and the relationship under the diagram gives the unknown.

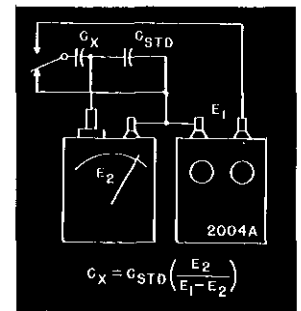

In both the series and parallel methods of measuring capacity, C_x and C_{STD} can be interchanged to increase the range of measurement.

The Keithley Regulated Voltage Supply, Model 2004A, is a convenient source for E_1 in each of the above set-ups.

APPENDIX - ACCESSORIES

VOLTAGE DIVIDERS -- MODELS 2006, 2007

Two resistive voltage dividers are made by Keithley Instruments. The Model 2007 is taller than the Model 2006 Divider illustrated; both may be used with all Keithley 200-series Electrometers.

No special techniques are required in using the dividers. Each plugs over the HI terminal of the Electrometer, extending its range by the ratio indicated on the nameplate.

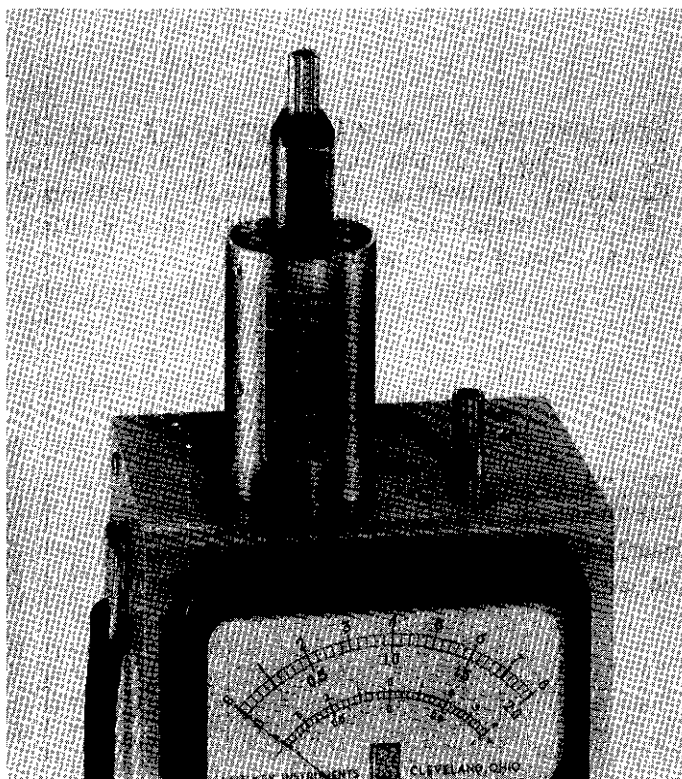

Principal characteristics are as follows:

MODEL	RATIO	RATIO ACCURACY	INPUT RES. OHMS	MAX. INPUT V.	VOLTAGE COEFF.	TEMP. COEFF.	RESISTOR MANUFACTURER
2006	100:1	5%	10^{12}	2000	-	-0.2%/°C	RPC
2007	1000:1	5%	10^{12}	20000	-	-0.2%/°C	RPC

RPC Resistance Products Company, Harrisburg, Pennsylvania

MODEL 2005 STATIC DETECTOR

Description · The Model 2005 Static Detector is an accessory for Keithley Electrometers which increases their usefulness in locating static charges.

The Electrometers are extremely sensitive to static charges--so much so as to be almost useless for locating a charged object, especially in an area where other electrostatic fields are present. The Static Detector controls the sensitivity of the Electrometer and also gives a directional characteristic to the instrument. Maximum sensitivity is along the cylinder axis.

Operation The Static Detector is clipped onto the Electrometer HI terminal. The meter is then set to zero electrically by depressing the Input Switch and turning the zero knob. If the charges being investigated are of unknown polarity, as is usually the case, the meter should be set to the center zero. This zero setting must be done away from the charged object. If the meter zero is set while in the static field the meter will deflect in a direction opposite from normal when the instrument is removed from the field.

The sensitivity of the instrument is determined by the meter range and by the position of the inner tube of the Static Detector. Least sensitivity results when the meter is set on the highest voltage range and the inner tube is fully extended. Closing the tube completely will increase the sensitivity about 200 times. Switching to the most sensitive voltage range of the Electrometer will, of course, give maximum sensitivity.

Normally the instrument will be held in the operator's hands and readings will be made as outlined. If the stray fields are strong enough, a charge may be induced in the operator's body, which will cause erroneous readings. In such cases it may be necessary to run a metallic conductor from the earth to the G terminal of the Electrometer.

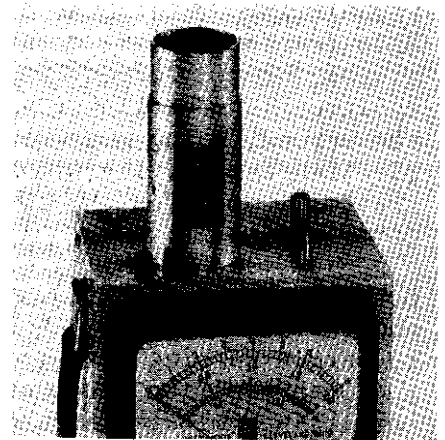

MODEL 2008 DECADE SHUNT

DESCRIPTION This shunt clips onto a Keithley Electrometer to make a very sensitive micro-microammeter. Current ranges on the panel are reciprocals of resistor values in the circuit. The current being measured is simply the Electrometer reading times the current range. Thus, 1.5 volts on the 10^{-12} range is 1.5×10^{-12} ampere.

Both the Short position of the selector switch, and the button on top short-circuit the input, to permit zeroing the Electrometer pointer. The Open position disconnects all resistors, permitting voltage measurements with minimum current drain.

The low terminal is connected internally to the cabinet, and should be on the low impedance side of the test circuit.

OPERATION Turn on the Electrometer, zero the pointer, and turn the Shunt switch to the right until the Electrometer needle indicates. Overlapping voltage ranges of the 200A and 210 Electrometers permit upper-scale readings of most currents.

Keep test leads short, and shield high-impedance circuits to prevent disturbances from stray electrostatic and power-frequency fields.

MAINTENANCE Occasionally clean the insulation at the high terminal and switch with a lint-free cloth. Do not touch the glass resistor envelopes with the hands.

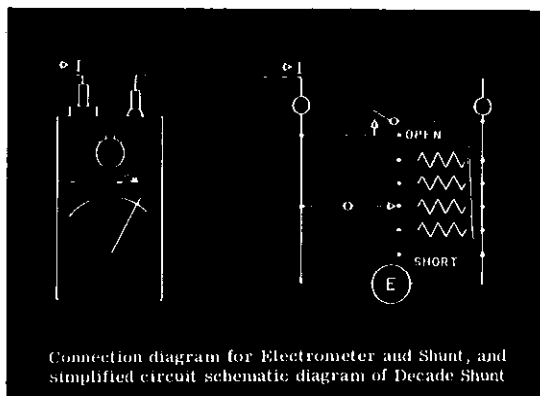
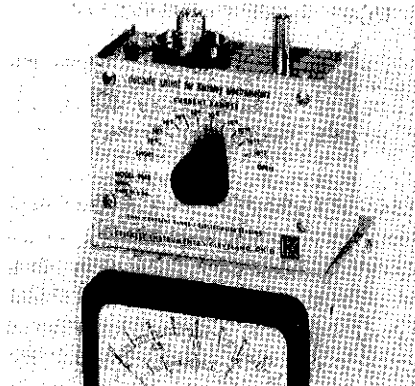

RESISTOR SPECIFICATIONS

Current Range	Ohms Resistance	Nominal Resistor Tolerance	Amps Full Scale on Typical Electrometer Ranges	
			30 mv Range	0.8 v Range
Short	0			
10 ⁻³	10 ³	1%	3×10^{-5}	8×10^{-4}
10 ⁻⁴	10 ⁴	1%	3×10^{-6}	8×10^{-5}
10 ⁻⁵	10 ⁵	1%	3×10^{-7}	8×10^{-6}
10 ⁻⁶	10 ⁶	1%	3×10^{-8}	8×10^{-7}
10 ⁻⁷	10 ⁷	1%	3×10^{-9}	8×10^{-8}
10 ⁻⁸	10 ⁸	1%	3×10^{-10}	8×10^{-9}
10 ⁻⁹	10 ⁹ +	2%*	3×10^{-11}	8×10^{-10}
10 ⁻¹⁰	10 ¹⁰ +	2%*	3×10^{-12}	8×10^{-11}
10 ⁻¹¹	10 ¹¹ +	2%*	3×10^{-13}	8×10^{-12}
10 ⁻¹²	10 ¹² +	2%*	-	8×10^{-13}
Open	-		*Listed at back of Shunt within 1%	

+ Temperature coefficient is 0.1 - 0.15% per degree; resistors are measured at 25°C. A drift of about 1/2% per year is to be expected.

CHANGE NOTICE

November 6, 1964

MODELS 200, 200A ELECTROMETERS

Model 200 Schematic Drawing DR10299:

Change the value of R2 to 50 K ohms nominal value.

Model 200A Schematic Drawing DR10446-A:

Change the value of R4 to 275 k Ω ;
Change the value of R5 to 60 k Ω ;
Change the value of R10 to 333 k Ω .