

THE LeCROY MODEL 9400A

DIGITAL OSCILLOSCOPE

North American Headquarters:

LeCROY Corporation
700 Chestnut Ridge Road
Chestnut Ridge, NY 10977-6499
U.S.A.
Tel: 914-578 6097

European Headquarters:

LeCROY S.A.
2, rue Pré-de-la-Fontaine
Case postale 341
1217 Meyrin 1 / Geneva
Switzerland
Tel: 41-22-719-21-11

Serial Number _____

January 1990



TABLE OF CONTENTS

Section	Page Number
1. GENERAL INFORMATION	
Technical Data Sheet	
1.1 Warranty	1-1
1.2 Assistance and Maintenance Agreements	1-1
1.3 Documentation Discrepancies	1-2
1.4 Service Procedure	1-2
1.5 Return Procedure	1-2
1.6 Initial Inspection	1-3
2. PRODUCT DESCRIPTION	
2.1 Introduction	2-1
2.2 9400A Architecture	2-1
2.3 ADCs and Memories	2-2
2.4 Trigger	2-3
2.5 Automatic Calibration	2-3
2.6 Display	2-3
2.7 Manual and Programmed Control	2-3
3. INSTALLATION	
3.1 Safety Information	3-1
3.2 Operating Voltage	3-1
3.3 Switching on the 9400A	3-2
4. DISPLAY LAYOUT	
4.1 Menu Field	4-1
4.2 Time and Frequency Field	4-2
4.3 Trigger Delay Field	4-2
4.4 Abridged Front Panel Status Field	4-2
4.5 Displayed Trace Field	4-2
4.6 Message Field	4-3
5. MANUAL OPERATION	
5.1 Front-panel Controls	5-1
5.1.1 Vertical	5-1
5.1.2 Time Base	5-4
5.1.3 Trigger	5-6
5.1.4 Displaying Traces	5-12
5.1.5 Display Control	5-12
5.1.6 Screen Adjustments	5-1
5.1.7 Cursors	5-15

5.2	Menu Controls	5-18
5.2.1	Store Menu	5-18
5.2.2	Panel Status Menu	5-20
5.2.3	Memory Status	5-22
5.2.4	Storage and Recall of Front Panel Setups	5-24
5.2.5	Special Modes	5-25
5.2.5.1	Auto-store Mode	5-25
5.2.5.2	Common Expand Mode	5-26
5.2.6	RS-232-C Setup	5-26
5.2.7	Plotter Setup	5-28
6.	REAR PANEL CONTROLS AND CONNECTORS	
6.1	Fuse Protection	6-1
6.2	Accessory Power Connectors	6-1
6.3	Battery Pack	6-1
6.4	GPIB and RS-232-C Port Selection	6-1
6.5	Plotter Connector	6-2
7.	REMOTE OPERATIONS	
7.1	Programmed Control	7-1
7.2	RS-232-C Ports	7-1
7.3	GPIB Port (Option OP02 only)	7-2
7.4	GPIB and RS-232-C Command Format	7-3
7.4.1	Introduction	7-3
7.4.2	Compound Commands	7-4
7.4.3	Command Format	7-4
7.4.4	Answers from the 9400A	7-5
7.4.5	Flushing of 9400A Output Buffer	7-6
7.4.6	Command Synchronization with Data Acquisition	7-6
7.4.7	Character Strings	7-7
7.4.8	Prompt	7-7
7.4.9	Errors and Adapted Values	7-8
7.5	Data Block Transfers	7-8
7.6	Commands	7-11
7.6.1	Notation	7-11
7.6.2	Acquisition Parameter Commands	7-12
7.6.3	Display Commands	7-15
7.6.4	Plotter Commands	7-20
7.6.5	Transfer Commands	7-22
7.6.6	Other Remote Commands	7-30
7.6.7	Communication Format Command	7-31
7.6.8	Status Byte and Mask Register Commands	7-34
7.6.9	GPIB Interface Message Interpretation	7-38
7.6.10	RS-232-C Only Commands	7-39

7.7	Binary Format of Waveform Descriptors	7-43
7.8	Format of Trigger Time(s)	7-47
7.9	Data Addressing Conventions	7-48
7.10	Interpretation of Waveform Data Values	7-50
7.10.1	Waveform Data in 8-bit Format	7-50
7.10.2	Waveform Data in 16-bit Format	7-52
7.11	Use of the Service Request (SRQ) Interrupts	7-52
7.11.1	Service Request in GPIB	7-52
7.11.2	Service Request in RS-232-C	7-55
8. BASIC 9400A WAVEFORM MEASUREMENTS AND OPERATING PROCEDURES		
8.1	Repetitive Signal Acquisition	8-1
8.2	Single Shot Acquisition	8-3
8.3	Trace Expansion - Expand A/B	8-5
8.4	Sequential Recording of Single Events in Segmented Memory	8-6
8.5	Slow Signal Recording	8-8
8.6	Window Triggering	8-9
8.7	Storing and Recalling Front Panel Setups	8-9
8.8	Signal Storage in Memories C, D	8-10
8.9	Redefinition Function - Expand Memories C, D	8-11
8.10	Auto-Store in Memory C, D	8-12
8.11	Common Expand Mode	8-13
8.12	Remote Control Via RS-232-C Port	8-14
8.13	Remote Control Via GPIB (Option OPO2 Only)	8-18
8.14	Making a Plot when the Computer, the 9400A, and the Plotter are All Connected Together on a GPIB Bus (Option OPO2 Only)	8-19
8.15	Configuring the Parallel Polling (Option OPO2 Only)	8-20
9. GETTING THE MOST OUT OF YOUR 9400A		
9.1	Front Panel Controls	9-1
9.2	Accurate Amplitude Measurements	9-1
9.3	Accurate Time Measurements	9-3
9.4	Auto-calibration	9-4
10. WPO1 WAVEFORM PROCESSING OPTION		
10.1	Processing Capabilities	10-1
10.2	Setting up a Waveform Processing Function Manually	10-2
10.2.1	Summed Average	10-3
10.2.2	Continuous Average	10-4
10.2.3	Extrema	10-5
10.2.4	Arithmetic	10-6
10.2.5	Functions	10-6
10.2.6	Smoothing	10-6

10.3	Remote Control of Waveform Processing Functions	10-8
10.4	Additional Values in the Descriptors of Processed Waveforms	10-13
10.5	Vertical Scaling Units	10-15
10.6	Index of Topics	10-17
11.	Fast Fourier Waveform Processing Option (WPO2, V 2.06FT)	
11.1	Processing Capabilities	11-1
11.2	Modification to WPO1 Functions	11-3
11.3	FFT Processing Examples	11-4
11.4	Remote Control of FFT Processing	11-7
11.4.1	Remote Commands	11-7
11.4.2	Additional Values in the Descriptors of FFT Processed Waveforms	11-9
11.5	FFT Application Hints	11-11
11.5.1	Some practical suggestions	11-11
11.5.2	Relationships of 9400A FFT output waveforms to the FFT computation steps	11-12
11.5.3	Computation Speed of FFT	11-15
11.6	FFT 9400A Glossary	11-16
11.7	Errors and Warnings	11-21
11.8	Table of Nyquist Frequencies	11-22
11.9	References	11-29
11.10	Index of Topics	11-30

Appendix

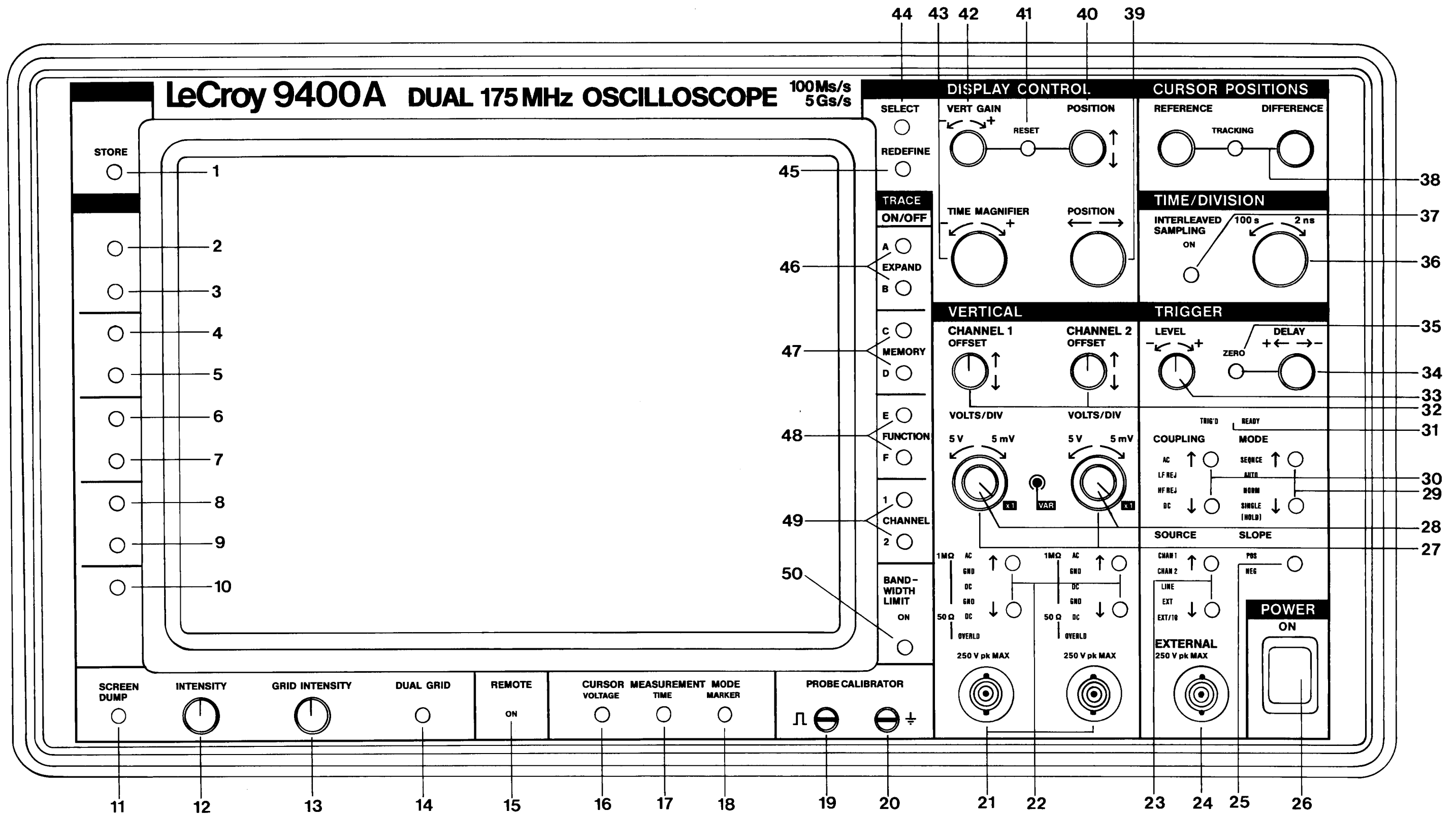

9400A FRONT PANEL
Figure 1.1

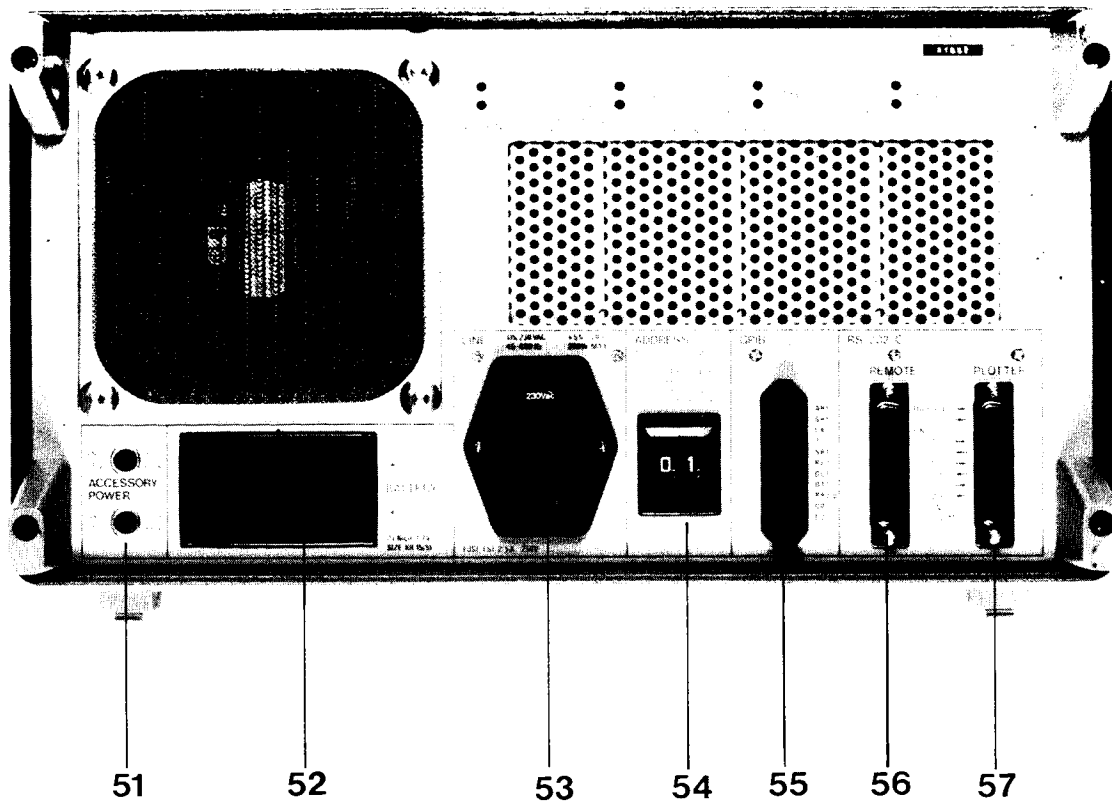

9400A REAR PANEL

Figure 1.2



DIGITAL OSCILLOSCOPE
175 MHz BANDWIDTH, 100 Ms/s, 5 Gs/s

LeCroy

**MODEL 9400A PORTABLE
DUAL-CHANNEL OSCILLOSCOPE**

9400A 

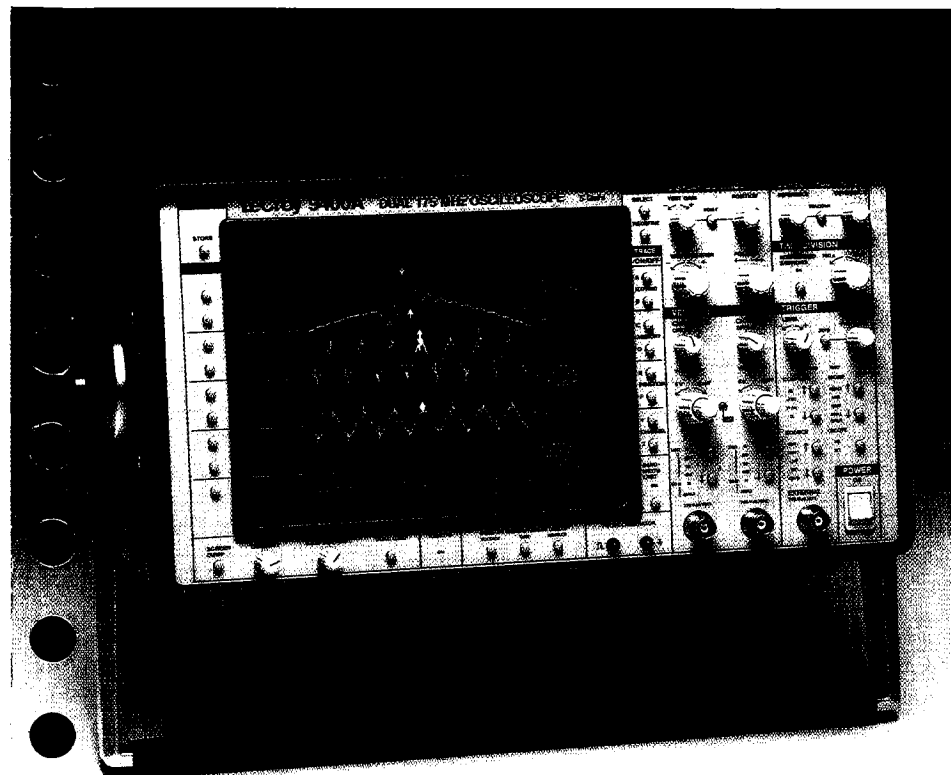

- High Bandwidth and Precision
- Long Memories
- High-resolution Display
- Signal Processing and FFT
- Mass Storage

Signal averaging improves the signal-to-noise ratio and increases sensitivity and vertical resolution. Above, a function generator signal is averaged 40 times to show the details of a perturbation (top trace).

**THE COMPLETE TEST
AND MEASUREMENT
SYSTEM**

The LeCroy 9400A Digital Oscilloscope is a powerful general-purpose tool for waveform recording and analysis. Combining ease of use with a comprehensive range of measurement and processing capabilities, it enables extremely precise measurements.

The LeCroy 9400A provides 175 MHz bandwidth, 100 megasamples/sec 8-bit ADCs, $\pm 2\%$ DC accuracy ($\pm 1\%$ optional), 32K memory per channel, and up to 192K of waveform storage memory. It is fully programmable over RS-232-C or GPIB interfaces. Plotter drivers enable color archiving via a wide range of digital plotters.

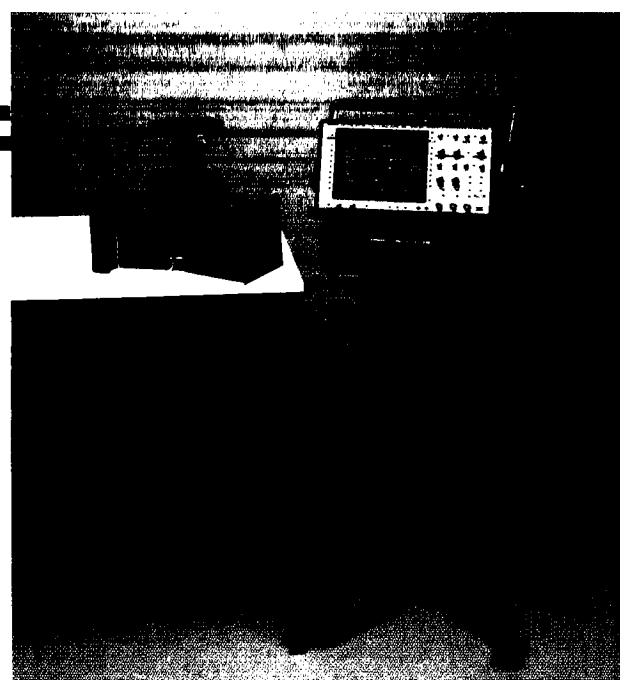

A wide range of oscilloscope accessories including cameras and a scope cart (pictured) are available for the 9400A.

Oscilloscope Accessories (cont'd)

CA9001	Camera (using Polaroid film) and Hood
CA9002	Camera Adapter (35mm) with Hood
CS9400	Certified Calibration
DP9001	Digital Plotter, 8-pen A4 size
94XX-FC	Front Cover
OC9001	Oscilloscope Cart
P9010	10:1 Oscilloscope Probe
P9010/2	10:1 Oscilloscope Probe with 2 m cable
P9011	10:1/1:1 Oscilloscope Probe
P9100	100:1 Oscilloscope Probe
RM9400	Adapter Kit for Rack Mounting
SG9001	High-voltage Protector
TC9001	Transit Case
TC9002	Protective Cover
TC9003	Transit Case for 9400A and Mass Storage

Greece:	Hellenic S/R Ltd., (01) 721 1140
India:	Electronic Ent., (02) 4137096
Israel:	Ammo, (03) 453157
Italy:	LeCroy Srl, Roma (06) 302-9646, Milano (02) 2940-5634
Japan:	Toyo Corp., (03) 279 0771
Korea:	Samduk Science & Ind., Ltd., (02) 468 04914
Mexico:	Nucleoelectronica SA, (905) 5693 6043
New Zealand:	E.C. Gough Ltd., (03) 798-740
Norway:	Avantec AS, (02) 630520
Portugal:	M.T. Brandao, Lta., (02) 691116
Spain:	Anadig Ingenieros SA, (01) 433 24 12
Switzerland:	LeCroy SA (022) 719 21 11
Sweden:	MSS AB, (0764) 68100
Taiwan:	Topward El. Inst., Ltd., (02) 601 8801
United Kingdom:	LeCroy Ltd., (0235) 33 114

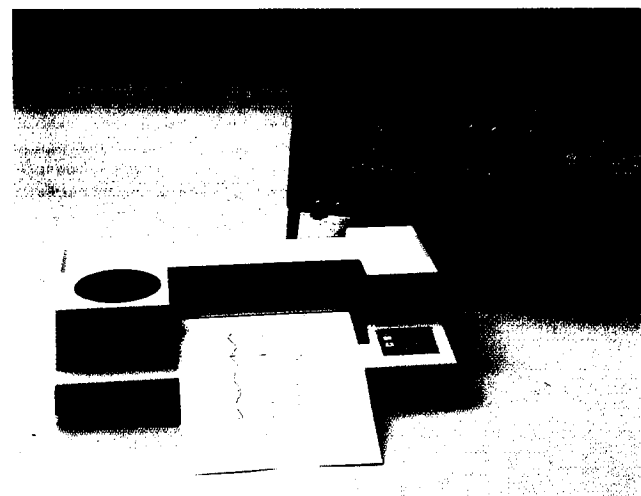

For instant hard copies the 9400A's screen dump feature sends data directly to the DP9001 8-pen digital plotter.

ORDERING INFORMATION
Oscilloscope and Options

Code	Description
9400A/G	Digital Oscilloscope
9400AOP01	High-precision Option
9400AOP03	Printer Option for 9400A/G
9400AWP01	Waveform Processing Option
9400AWP02	FFT Processing Option (requires 9400AWP01)
9400AMS01	Mass Storage and Remote Control Package, including an IBM lap-top controller, interface, cables and software
9400AIM01	GPIB Interface for IBM-PCC computers
9400CS01	Calibration Software

Oscilloscope Accessories

OM9400A	Operator's Manual
SM9400A	Service Manual

US SALES OFFICES

1-800-5-LeCroy

automatically connects you to your local sales office.

WORLDWIDE

Australia:	Scient. Devices Pty, Ltd, (03) 579-3622
Austria:	Dewetron Elektr. Messgeräte GmbH, (0316) 391804
Benelux:	LeCroy B.V. *31-4902-89285
Canada:	Rayonics Sci. Inc., W. Ontario, (416) 736-1600 E. Ontario/Manitoba, (613) 521-8251 Quebec, (514) 335-015 W. Canada, (604) 293-1854
Denmark:	Lutronic Aps, (42) 459764
Finland:	Labtronic OY, (90) 847144
France:	LeCroy Sarl (1) 69073897
Germany:	LeCroy GmbH, (06221) 49162, (North) (0405) 42713

LeCroy

Innovators in Instrumentation

LeCROY CORPORATE HEADQUARTERS

700 Chestnut Ridge Road
Chestnut Ridge, NY 10977-6499
Telephone: (914) 425-2000
TWX:(710) 577-2832
Fax: (914) 425-8967

LeCROY EUROPEAN HEADQUARTERS

2, rue Pré-de-la-Fontaine
P.O. Box 341
1217 Meyrin 1-Geneva, Switzerland
Telephone: (022) 719 21 11 Telex: 41 90 58
Fax: (022) 782 39 15

FEATURES

High bandwidth and precision – Two independent channels, each with 175 MHz bandwidth and a high-performance 8-bit ADC, handle input signals with better than $\pm 2\%$ DC accuracy ($\pm 1\%$ optional). The 9400A features sampling rates of 100 megasamples/sec for transient events. Long memories and a versatile cursor system (including voltage, time and cross-hair cursors), give time measurements with an accuracy of $\pm 0.02\%$ of the time-base setting, and resolution of $\pm 0.002\%$ full scale.

High-resolution display – The 9400A's large display screen produces bright, stable, razor-sharp pictures of your signal under any repetition rate conditions. Very accurate signal comparisons are possible as up to four waveforms (live, expanded or processed) can be displayed simultaneously on the high-resolution screen (1024 x 1024 pixels).

Long memories – The long 32K acquisition memories of the 9400A Digital Oscilloscope capture waveforms with high fidelity. At similar time-base settings, the 9400A's long memories allow sampling rates up to 25 times faster than that of instruments which have only 1K of acquisition memory (see graph below). Faster sampling rates ensure higher single-shot bandwidth as well as significantly reducing problems caused by undersampling and aliasing. The 9400A's long memories allow displayed waveforms to be expanded up to 100 times to show the finest signal details.

Transient recording – With a sampling rate of 100 megasamples/sec, the 9400A is an extremely powerful transient recorder. Long 32K data point acquisition memories, combined with a continuously adjustable trigger (from 100% pre-trigger to 10,000 divisions post-trigger at any time-base setting), ensure that rare events cannot be missed. Both channels are sampled simultaneously so that exact time correlation is maintained between channels.

Full programmability – All the 9400A's front-panel controls are fully programmable via the two RS-232-C interface ports or the GPIB port. A single push-button initiates a screen dump for accurate color hard copies of the display via a wide range of digital plotters. The GPIB comes complete with LeCroy "MASP" software offering computer control and mass storage on any PC compatible with the IBM® standard.

Signal processing – The waveform processing options extend the applications of the 9400A to high bandwidth signal characterization, as well as mathematical and spectral analysis. The routines include averaging (summed and continuous), smoothing, integration, differentiation, square, square-root, full arithmetic, FFT spectral analysis, and Extrema monitoring.

Mass storage and remote control – A sophisticated mass storage and remote control package is available to assist users involved in automated and computer-aided testing. Convenient portability for field applications is also provided by a lap-top computer.

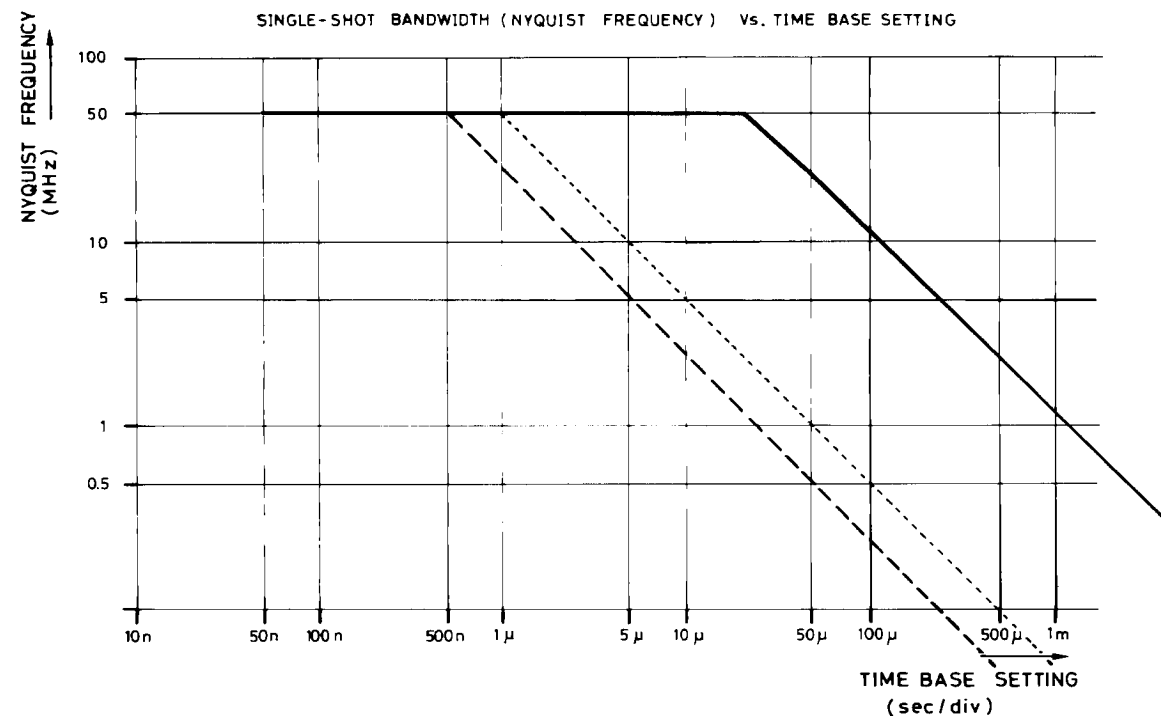

Single-shot bandwidth is a function of sampling rate. Long memories enable higher sampling rates at equal time-base settings. Above, the 9400A (solid line) is compared to oscilloscopes with 1K (dotted line) and 512 points (dashed line) of memory. At slower time-base settings, the single-shot bandwidth of the 9400A, expressed as Nyquist frequency, is typically 25 times higher than in oscilloscopes with 1K memory and 50 times higher than in those with only 512 points.

SPECIFICATIONS

VERTICAL ANALOG SECTION

Bandwidth (–3 dB):

@ 50 Ω: DC – 175 MHz at 10 mV/div, up to 225 MHz at 1V/div;
DC – 150 MHz at 5 mV/div.

@ 1 MΩ AC: < 10 Hz – 100 MHz typical.

@ 1 MΩ DC: DC – 100 MHz typical.

Single shot: DC – 50 MHz (Nyquist).

Input impedance: 1 MΩ // 50 pF and 50 Ω ± 1%.

Channels: Two; standard BNC connector inputs.

Sensitivity range: 5 mV/div to 1 V/div at 50 Ω impedance and 5 mV/div to 5 V/div at 1 MΩ impedance; detents at 1–2–5, 1: 2.5 continuously variable.

Offset: ± 8 divisions in 0.04 division increments.

DC accuracy: Standard $\leq \pm 2\%$, optional $\leq \pm 1\%$.

Noise: $\leq 0.45\%$ RMS.

Bandwidth limiter (–3 dB): 30 MHz.

Max input voltage: 250 V (DC + peak AC) at 1 MΩ, 5 V DC (500 mW) or ± 10 V peak AC at 50 Ω.

VERTICAL DIGITAL SECTION

ADCs: One per channel, 8-bit flash.

Conversion rate: Up to 100 megasamples/sec for transient signals, up to 5 gigasamples/sec for repetitive signals, simultaneously on both channels.

Aperture uncertainty: ± 10 psec.

Overall dynamic accuracy (typical): Sine wave applied to the BNC input for RMS curve fit at 80% full scale. The accuracy measurement includes the front-end amplifier, sample & hold and ADC.

Input frequency (MHz)	1.0	10.0	Nyquist 50.0	100.0	175.0
Signal-to-noise ratio (dB)	41.9	41.9	41.9	37.1	29.9
Effective bits	7.0	7.0	7.0	6.2	5.0

Acquisition memories, Channels 1 and 2: Two, 32K 8-bit word memories (64K total) which can be segmented into 8, 15, 31, 62, 125 or 250 blocks.

Reference memories, C and D: Two, 32K, 16-bit word memories (64K total) which can store two acquired and/or processed waveforms.

Function memories E and F (optional): Two 32K, 16-bit word memories (64K total) for waveform processing.

Glitch detection: Permanent glitch detection for events down to 0.04% of the time-base setting, 10 nsec minimum.

HORIZONTAL SECTION

Time Base

Range: 2 nsec/div to 100 sec/div.

Accuracy: Better than $\pm 0.002\%$ of the time-base setting.

Interpolator resolution: 10 psec.

Acquisition Modes

Random Interleaved Sampling (RIS) for repetitive signals from 2 nsec/div to 2 μsec/div;

Single shot for transient signals and repetitive signals from 50 nsec/div to 200 msec/div;

Roll for slowly-changing signals from 500 msec/div to 100 sec/div;

Sequence for capturing transients in segmented memories of 8, 15, 31, 62, 125 or 250 blocks.

Trigger

Sources: CHAN1, CHAN2, LINE, EXT, EXT/10.

Slope: Positive, negative, window.

Coupling: AC, LF REJ, HF REJ, DC.

Modes:

Sequence: stores multiple events in segmented acquisition memories.

Auto: automatically re-arms after each sweep. If no trigger occurs, one is generated at 2 Hz repetition rate.

Normal: re-arms after each sweep. If no trigger occurs after 2 sec, the display is erased.

Single (hold): holds display after a trigger occurs. Re-arms only when the "single" button is pressed again.

Pre-trigger: Adjustable in 0.2% increments, to 100%.

Post-trigger delay: Adjustable in 0.02 division increments up to 10,000 divisions.

External trigger input: 1MΩ, < 30pF, 250V max., ± 2 V in EXT, ± 20 V in EXT/10.

Rate: > 200 MHz.

SELF TESTS

Auto-calibration: Performed every 20 minutes or whenever the gain or time-base parameters are changed; provides accuracies of:

DC gain: $\pm 2\%$ ($\pm 1\%$ optional) of full scale;

Offset: $\pm 0.5\%$ of full scale (50Ω only);

Time: 20 psec RMS.

During the warming-up period, auto-calibration is carried out at 1 minute intervals unless the oscilloscope is in single or sequence trigger mode.

DISPLAY

CRT: 12.5 x 17.5 cm (5 x 7 inches); magnetic deflection; vector graphics system.

Resolution: 1024 x 1024 addressable points.

Grid: Internally generated; separate intensity control for grid and waveforms. Single and dual grid mode.

Expansion: Dual zoom horizontal expansion operates simultaneously on live, stored and processed waveforms, expanding up to 100 times. Vertical expansion from 0.4 up to 2 times for non-processed waveforms, up to 10 times for processed waveforms.

Screen dump: Single or multi-pen digital plotters are menu selected. The 9400A supports the HP 7400 series, as well as the Tektronix 4662, Philips PM 8151, Graphtek WX 4638/6, and compatible models. Screen dumps are activated by a front-panel push-button.

Cursors: Two **time** cursors give time resolution of $\pm 0.2\%$ full scale for unexpanded traces; up to $\pm 0.002\%$ for expanded traces. The corresponding frequency information is also provided. Two **voltage** cursors measure voltage differences to 0.2% of full scale for each trace.

A **cross-hair** marker measures absolute voltage versus signal ground as well as the time relative to the trigger.

DIGITAL OSCILLOSCOPE
175 MHz BANDWIDTH, 100 Ms/s, 5 Gs/s

LeCroy

**MODEL 9400A PORTABLE
DUAL-CHANNEL OSCILLOSCOPE**

9400A 

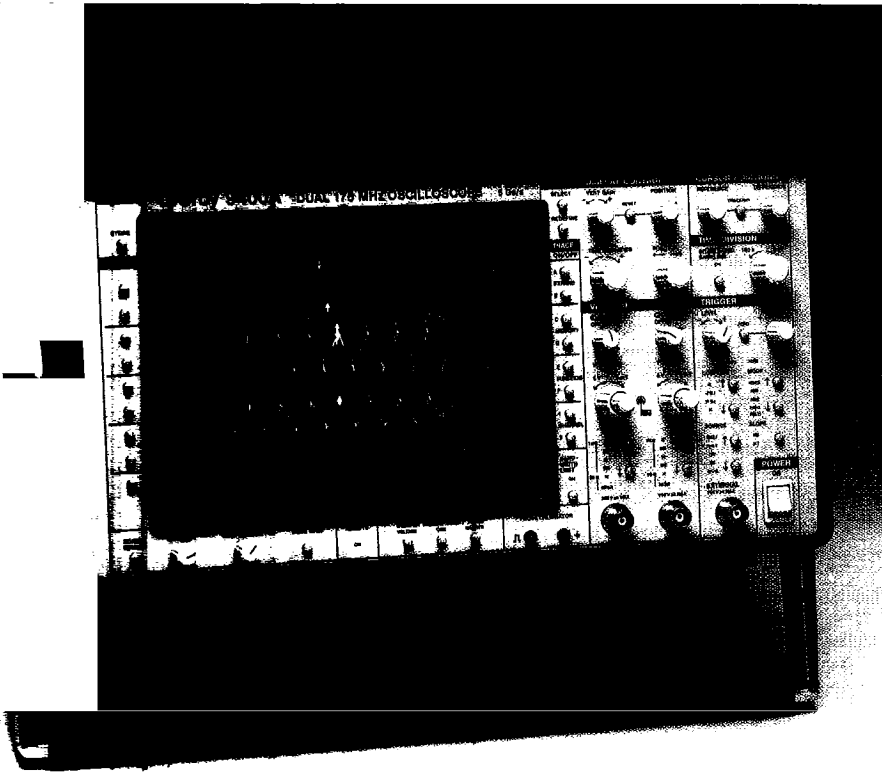

- High Bandwidth and Precision
- Long Memories
- High-resolution Display
- Signal Processing and FFT
- Mass Storage

Signal averaging improves the signal-to-noise ratio and increases sensitivity and vertical resolution. Above, a function generator signal is averaged 40 times to show the details of a perturbation (top trace).

**THE COMPLETE TEST
AND MEASUREMENT
SYSTEM**

The LeCroy 9400A Digital Oscilloscope is a powerful general-purpose tool for waveform recording and analysis. Combining ease of use with a comprehensive range of measurement and processing capabilities, it enables extremely precise measurements.

The LeCroy 9400A provides 175 MHz bandwidth, 100 megasamples/sec 8-bit ADCs, $\pm 2\%$ DC accuracy ($\pm 1\%$ optional), 32K memory per channel, and up to 192K of waveform storage memory. It is fully programmable over RS-232-C or GPIB interfaces. Plotter drivers enable color archiving via a wide range of digital plotters.

FEATURES

High bandwidth and precision – Two independent channels, each with 175 MHz bandwidth and a high-performance 8-bit ADC, handle input signals with better than $\pm 2\%$ DC accuracy ($\pm 1\%$ optional). The 9400A features sampling rates of 100 megasamples/sec for transient events. Long memories and a versatile cursor system (including voltage, time and cross-hair cursors), give time measurements with an accuracy of $\pm 0.02\%$ of the time-base setting, and resolution of $\pm 0.002\%$ full scale.

High-resolution display – The 9400A's large display screen produces bright, stable, razor-sharp pictures of your signal under any repetition rate conditions. Very accurate signal comparisons are possible as up to four waveforms (live, expanded or processed) can be displayed simultaneously on the high-resolution screen (1024 x 1024 pixels).

Long memories – The long 32K acquisition memories of the 9400A Digital Oscilloscope capture waveforms with high fidelity. At similar time-base settings, the 9400A's long memories allow sampling rates up to 25 times faster than that of instruments which have only 1K of acquisition memory (see graph below). Faster sampling rates ensure higher single-shot bandwidth as well as significantly reducing problems caused by undersampling and aliasing. The 9400A's long memories allow displayed waveforms to be expanded up to 100 times to show the finest signal details.

Transient recording – With a sampling rate of 100 megasamples/sec, the 9400A is an extremely powerful transient recorder. Long 32K data point acquisition memories, combined with a continuously adjustable trigger (from 100% pre-trigger to 10,000 divisions post-trigger at any time-base setting), ensure that rare events cannot be missed. Both channels are sampled simultaneously so that exact time correlation is maintained between channels.

Full programmability – All the 9400A's front-panel controls are fully programmable via the two RS-232-C interface ports or the GPIB port. A single push-button initiates a screen dump for accurate color hard copies of the display via a wide range of digital plotters. The GPIB comes complete with LeCroy "MASP" software offering computer control and mass storage on any PC compatible with the IBM® standard.

Signal processing – The waveform processing options extend the applications of the 9400A to high bandwidth signal characterization, as well as mathematical and spectral analysis. The routines include averaging (summed and continuous), smoothing, integration, differentiation, square, square-root, full arithmetic, FFT spectral analysis, and Extrema monitoring.

Mass storage and remote control – A sophisticated mass storage and remote control package is available to assist users involved in automated and computer-aided testing. Convenient portability for field applications is also provided by a lap-top computer.

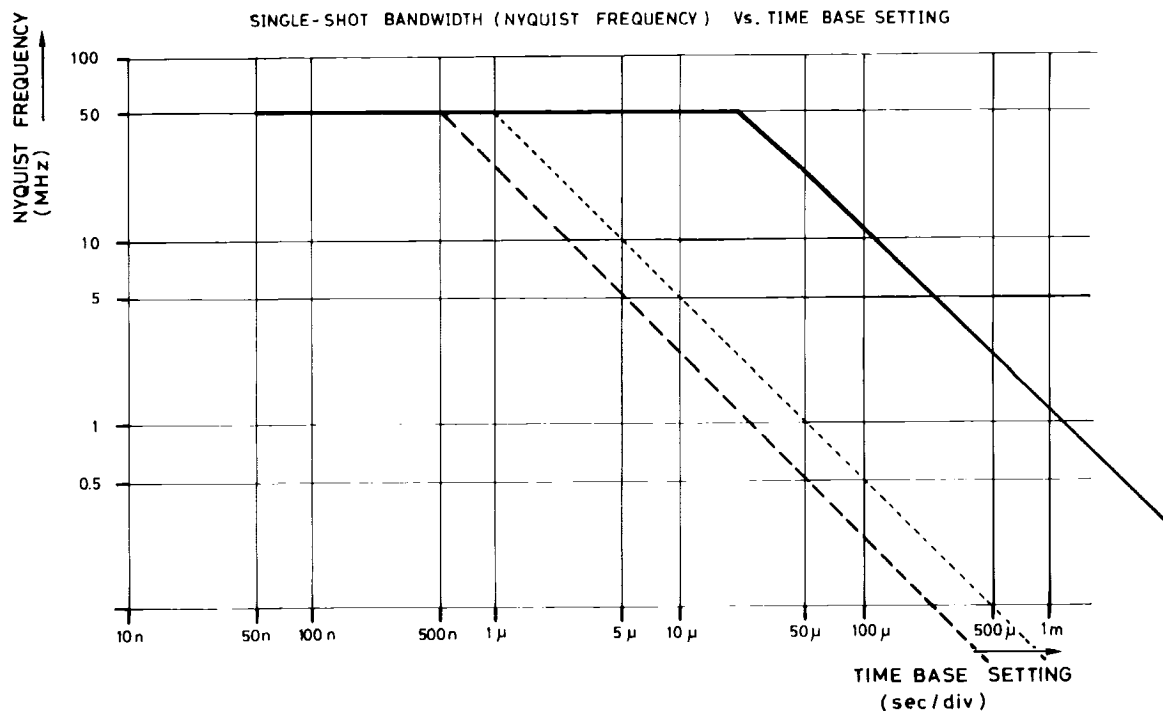

Single-shot bandwidth is a function of sampling rate. Long memories enable higher sampling rates at equal time-base settings. Above, the 9400A (solid line) is compared to oscilloscopes with 1K (dotted line) and 512 points (dashed line) of memory. At slower time-base settings, the single-shot bandwidth of the 9400A, expressed as Nyquist frequency, is typically 25 times higher than in oscilloscopes with 1K memory and 50 times higher than in those with only 512 points.

SPECIFICATIONS

VERTICAL ANALOG SECTION

Bandwidth (-3 dB):

@ 50 Ω : DC - 175 MHz at 10 mV/div, up to 225 MHz at 1V/div;
DC - 150 MHz at 5 mV/div.

@ 1 M Ω AC: < 10 Hz - 100 MHz typical.

@ 1 M Ω DC: DC - 100 MHz typical.

Single shot: DC - 50 MHz (Nyquist).

Input impedance: 1 M Ω // 50 pF and 50 Ω \pm 1%.

Channels: Two; standard BNC connector inputs.

Sensitivity range: 5 mV/div to 1 V/div at 50 Ω impedance and 5 mV/div to 5 V/div at 1 M Ω impedance; detents at 1-2-5, 1:2.5 continuously variable.

Offset: \pm 8 divisions in 0.04 division increments.

DC accuracy: Standard \leq \pm 2%, optional \leq \pm 1%.

Noise: \leq 0.45% RMS.

Bandwidth limiter (-3 dB): 30 MHz.

Max input voltage: 250 V (DC + peak AC) at 1 M Ω , 5 V DC (500 mW) or \pm 10V peak AC at 50 Ω .

VERTICAL DIGITAL SECTION

ADCs: One per channel, 8-bit flash.

Conversion rate: Up to 100 megasamples/sec for transient signals, up to 5 gigasamples/sec for repetitive signals, simultaneously on both channels.

Aperture uncertainty: \pm 10 psec.

Overall dynamic accuracy (typical): Sine wave applied to the BNC input for RMS curve fit at 80% full scale. The accuracy measurement includes the front-end amplifier, sample & hold and ADC.

Input frequency (MHz)	1.0	10.0	Nyquist 50.0	100.0	175.0
Signal-to-noise ratio (dB)	41.9	41.9	41.9	37.1	29.9
Effective bits	7.0	7.0	7.0	6.2	5.0

Acquisition memories, Channels 1 and 2: Two, 32K 8-bit word memories (64K total) which can be segmented into 8, 15, 31, 62, 125 or 250 blocks.

Reference memories, C and D: Two, 32K, 16-bit word memories (64K total) which can store two acquired and/or processed waveforms.

Function memories E and F (optional): Two 32K, 16-bit word memories (64K total) for waveform processing.

Glitch detection: Permanent glitch detection for events down to 0.04% of the time-base setting, 10 nsec minimum.

HORIZONTAL SECTION

Time Base

Range: 2 nsec/div to 100 sec/div.

Accuracy: Better than \pm 0.002 % of the time-base setting.

Interpolator resolution: 10 psec.

Acquisition Modes

Random Interleaved Sampling (RIS) for repetitive signals from 2 nsec/div to 2 μ sec/div;

Single shot for transient signals and repetitive signals from 50 nsec/div to 200 msec/div;

Roll for slowly-changing signals from 500 msec/div to 100 sec/div;

Sequence for capturing transients in segmented memories of 8, 15, 31, 62, 125 or 250 blocks.

Trigger

Sources: CHAN1, CHAN2, LINE, EXT, EXT/10.

Slope: Positive, negative, window.

Coupling: AC, LF REJ, HF REJ, DC.

Modes:

Sequence: stores multiple events in segmented acquisition memories.

Auto: automatically re-arms after each sweep. If no trigger occurs, one is generated at 2 Hz repetition rate.

Normal: re-arms after each sweep. If no trigger occurs after 2 sec, the display is erased.

Single (hold): holds display after a trigger occurs. Re-arms only when the "single" button is pressed again.

Pre-trigger: Adjustable in 0.2% increments, to 100%.

Post-trigger delay: Adjustable in 0.02 division increments up to 10,000 divisions.

External trigger input: 1M Ω , < 30pF, 250V max., \pm 2V in EXT, \pm 20V in EXT/10.

Rate: > 200 MHz.

SELF TESTS

Auto-calibration: Performed every 20 minutes or whenever the gain or time-base parameters are changed; provides accuracies of:

DC gain: \pm 2% (\pm 1% optional) of full scale;

Offset: \pm 0.5% of full scale (50 Ω only);

Time: 20 psec RMS.

During the warming-up period, auto-calibration is carried out at 1 minute intervals unless the oscilloscope is in single or sequence trigger mode.

DISPLAY

CRT: 12.5 \times 17.5 cm (5 \times 7 inches); magnetic deflection; vector graphics system.

Resolution: 1024 \times 1024 addressable points.

Grid: Internally generated; separate intensity control for grid and waveforms. Single and dual grid mode.

Expansion: Dual zoom horizontal expansion operates simultaneously on live, stored and processed waveforms, expanding up to 100 times. Vertical expansion from 0.4 up to 2 times for non-processed waveforms, up to 10 times for processed waveforms.

Screen dump: Single or multi-pen digital plotters are menu selected. The 9400A supports the HP 7400 series, as well as the Tektronix 4662, Philips PM 8151, Graphtek WX 4638/6, and compatible models. Screen dumps are activated by a front-panel push-button.

Cursors: Two **time** cursors give time resolution of \pm 0.2% of full scale for unexpanded traces; up to \pm 0.002% for expanded traces. The corresponding frequency information is also provided. Two **voltage** cursors measure voltage differences to 0.2% of full scale for each trace.

A **cross-hair** marker measures absolute voltage versus signal ground as well as the time relative to the trigger.

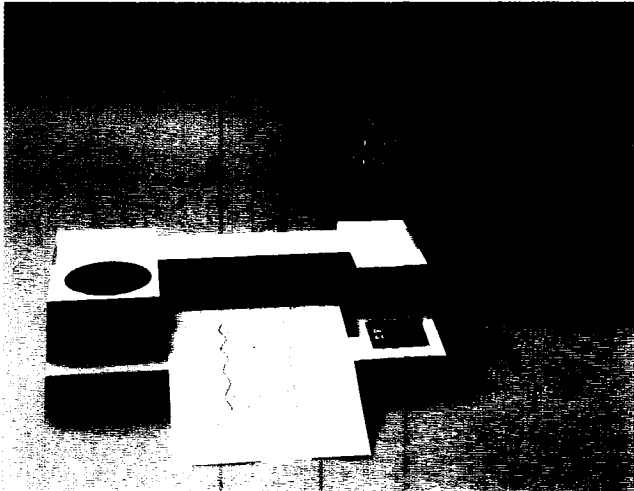

For instant hard copies the 9400A's screen dump feature sends data directly to the DP9001 8-pen digital plotter.

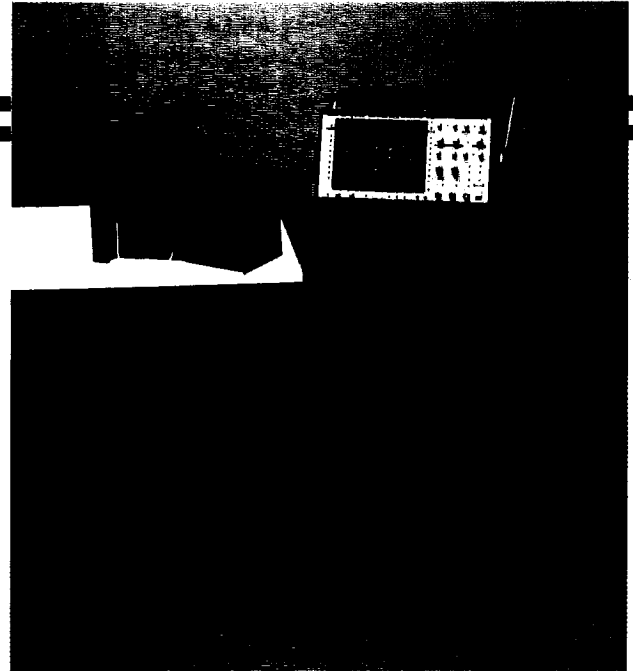

A wide range of oscilloscope accessories including cameras and a scope cart (pictured) are available for the 9400A.

ORDERING INFORMATION

Oscilloscope and Options

Code	Description
9400A/G	Digital Oscilloscope
9400AOP01	High-precision Option
9400AOP03	Printer Option for 9400A/G
9400AWP01	Waveform Processing Option
9400AWP02	FFT Processing Option (requires 9400AWP01)
9400AMS01	Mass Storage and Remote Control Package, including an IBM lap-top controller, interface, cables and software
9400AIM01	GPIO Interface for IBM-PCC computers
9400CS01	Calibration Software

Oscilloscope Accessories

OM9400A	Operator's Manual
SM9400A	Service Manual

Oscilloscope Accessories (cont'd)

CA9001	Camera (using Polaroid film) and Hood
CA9002	Camera Adapter (35mm) with Hood
CS9400	Certified Calibration
DP9001	Digital Plotter, 8-pen A4 size
94XX-FC	Front Cover
OC9001	Oscilloscope Cart
P9010	10:1 Oscilloscope Probe
P9010/2	10:1 Oscilloscope Probe with 2 m cable
P9011	10:1/1:1 Oscilloscope Probe
P9100	100:1 Oscilloscope Probe
RM9400	Adapter Kit for Rack Mounting
SG9001	High-voltage Protector
TC9001	Transit Case
TC9002	Protective Cover
TC9003	Transit Case for 9400A and Mass Storage

US SALES OFFICES

1-800-5-LeCroy

automatically connects you to your local sales office.

WORLDWIDE

Australia: Scient. Devices Pty, Ltd, (03) 579-3622
Austria: Dewetron Elektr. Messgeräte GmbH, (0316) 391804
Benelux: LeCroy B.V. *31-4902-89285
Canada: Rayonics Sci. Inc., W. Ontario, (416) 736-1600
 E. Ontario/Manitoba, (613) 521-8251
 Quebec, (514) 335-015
 W. Canada, (604) 293-1854
Denmark: Lutronic Aps, (42) 459764
Finland: Labtronic OY, (90) 847144
France: LeCroy Sarl (1) 69073897
Germany: LeCroy GmbH, (06221) 49162, (North) (0405) 42713

Greece: Hellenic S/R Ltd., (01) 721 1140
India: Electronic Ent., (02) 4137096
Israel: Ammo, (03) 453157
Italy: LeCroy Srl, Roma (06) 302-9646, Milano (02) 2940-5634
Japan: Toyo Corp., (03) 279 0771
Korea: Samduk Science & Ind., Ltd., (02) 468 04914
Mexico: Nucleoelectronica SA, (905) 5693 6043
New Zealand: E.C. Gough Ltd., (03) 798-740
Norway: Avantec AS, (02) 630520
Portugal: M.T. Brandao, Lta., (02) 691116
Spain: Anadig Ingenieros SA, (01) 433 24 12
Switzerland: LeCroy SA (022) 719 21 11
Sweden: MSS AB, (0764) 68100
Taiwan: Topward El. Inst., Ltd., (02) 601 8801
United Kingdom: LeCroy Ltd., (0235) 33 114

LeCroy

Innovators in Instrumentation

LeCROY CORPORATE HEADQUARTERS

700 Chestnut Ridge Road
 Chestnut Ridge, NY 10977-6499
 Telephone: (914) 425-2000
 TWX:(710) 577-2832
 Fax: (914) 425-8967

LeCROY EUROPEAN HEADQUARTERS

2, rue Pré-de-la-Fontaine
 P.O. Box 341
 1217 Meyrin 1-Geneva, Switzerland
 Telephone: (022) 719 21 11 Telex: 41 90 58
 Fax: (022) 782 39 15

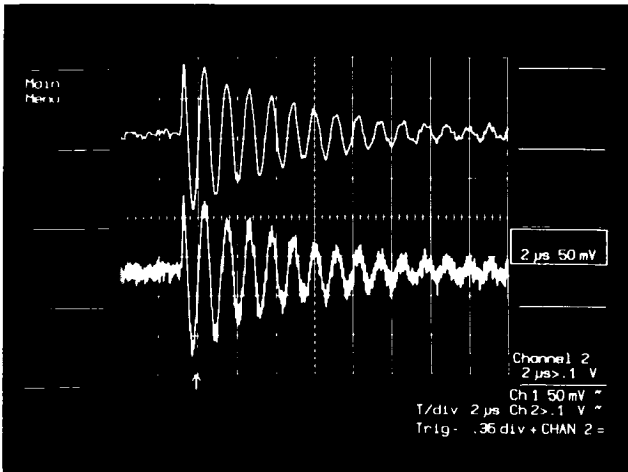

In single-shot applications the 9400A's smoothing routines can be used to remove high-frequency noise from transients.

MASS STORAGE 9400AMS01

Optional dual floppy-disk storage system mounted externally on the oscilloscope.

Controller: PC01 programmable controller with LCD display and full-size keyboard.

Medium: 720 kilobyte, 3 1/2 inch flexible diskettes.

Bus transfer rate: 220 kilobytes/sec over National Instruments™ GPIB interface model 80400-50.

Dimensions: 6.9 x 31.2 x 40.5 cm;
2.7 x 12.3 x 15.9 inches.

Weight: 6 kg, 13 lbs.

For further information refer to the mass storage data sheet.

CALIBRATION SOFTWARE AND SYSTEMS

9400CS01 "CALSOFT"

Test and calibration software providing a convenient and un-



A lap-top IBM-PCC is used to provide mass storage and remote control (9400AMS01) for field and automated testing applications.

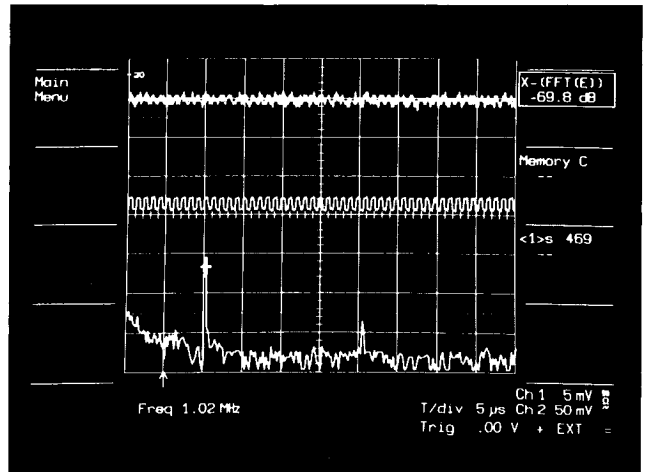

An apparent noise signal (top trace) is averaged over 400 times (middle) to reveal a low amplitude clock signal. FFT analysis (lower) shows the clock frequency to be 1.02 MHz.

ambiguous check of the 9400A's specifications. If instruments traceable to a standard are used, the calibration will be traceable to the same standard.

Computer required: Any computer compatible with the IBM-PC standard.

Tests: A comprehensive series of tests include internal, bandwidth, linearity, noise, rise time/overshoot, sinefit, time base and trigger.

Presentation of results: Results of the calibration check are fully documented on hard copy, or can be archived on hard disk or diskette.

"CALSOFT" systems: Various system configurations including 9400CS01, signal generators, power supplies, and a computer with accessories and fixtures are quoted on request.

Training: User training classes on service and maintenance of the 9400 series oscilloscopes, as well as calsoft operation are scheduled regularly.

CERTIFIED CALIBRATION CS9400

Certified traceable calibration to NBS or any other national standard is obtained by specifying CS9400 when ordering the 9400A.

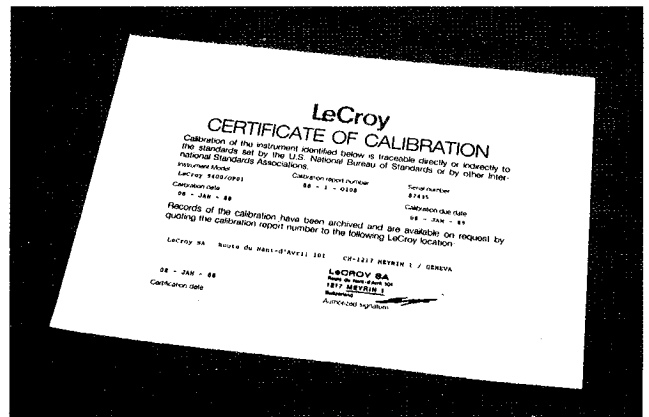

Time and cross-hair cursors indicate Hz and dB or volt values when an FFT spectrum analysis is made.

Menus:

Standard: Waveform storage; acquisition parameters; memory status; store/recall front-panel configurations, RS-232-C configuration; plotter setup.

Optional: (WP01/WP02) averaging, arithmetic, functions, extrema, smoothing, FFT and frequency domain averaging.

REMOTE CONTROL

All the front-panel controls, including variable gain, offset and position controls (not cursor positioning), and all the internal functions are programmable.

RS-232-C ports: Two: for computer/terminal control and plotter connection. Asynchronous up to 19200 baud.

GPIB port: (IEEE-488). Configured as talker/listener for computer control and fast data transfer; 400 kilobytes/sec maximum. ASCII or binary. The address switches are on the rear panel.

It includes LeCroy MS02 (MASP) IBM-PC-based software for mass storage and remote control applications. For further details on MASP software, please refer to the MS01/02 data sheet.

PROBES

Probe calibration: 976 Hz square wave, 1 V p-p \pm 1%.

Standard probes: Two model P9010, $\times 10$ attenuating passive probes with 10 M Ω input impedance in parallel with a 5.5 pF capacitance.

Probe power: Two power outlets on the rear panel provide \pm 15 V and + 5 V DC for active probes.

GENERAL

Temperature: 5 to 40°C rated; to 50°C operating.

Humidity: 80%

EMI Immunity: The 9400A complies with the following standards: IEC 801, VDE 0871, FCC PART 15 and SEV.

Safety standards: The 9400A complies with the following: IEC-348, ASE 3453 and VDE 0411.

Power required: 110 or 220 V AC, 48 to 65 Hz, 200 W.

Battery backup: NiCd batteries maintain front-panel settings for 6 months minimum.

Dimensions: (HWD) 19.2 \times 36.5 \times 46.5 cm,
(7 1/2 \times 14 3/8 \times 18 3/8 inches).

Weight: 14 kg (30 lbs) net, 20 kg (44 lbs) shipping.

Warranty: 2 years.

OPTIONS FOR THE 9400A

9400AOP01: \pm 1% DC high-precision option. A certificate of traceability is provided with this option.

9400AOP03: Printer drive for HP 2225 ThinkJet.

WAVEFORM PROCESSING 9400AWP01, AND 9400AWP02

Routines are called and set up via menus. Extensive signal processing in both time and frequency domains is provided

by optional firmware packages. These include FFT spectrum analysis, arithmetic functions, integration, differentiation, square root, square, averaging (continuous and summation) and smoothing, as well as Extrema monitoring.

For additional information refer to data sheets WP01 and WP02.

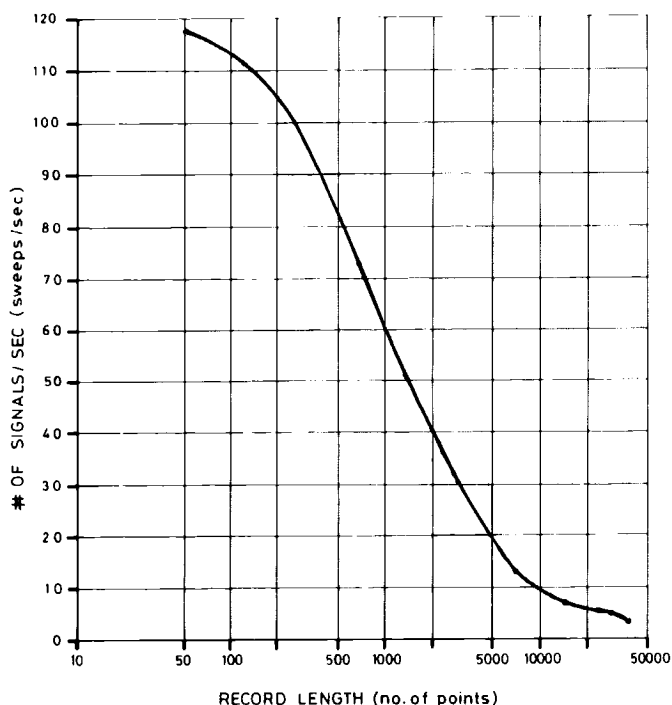

With option WP01 installed, the 9400A becomes a fast signal averager (both summation and continuous). As many as 100,000 points/sec are averaged with record lengths chosen by the user up to a maximum of 32,000. The graph above displays the relationship between record length and the number of signals/sec averaged.

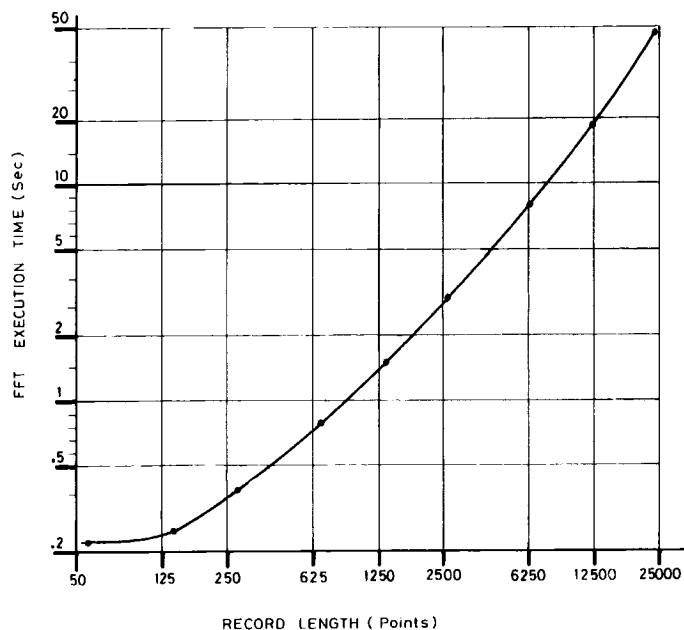

FFT execution time as a function of record length, including window calculations and display generation, is expressed in the graph above.

WAVEFORM PROCESSING PACKAGE
INCLUDING AVERAGING, INTEGRATION, DIFFERENTIATION

LeCroy

**WP01 WAVEFORM PROCESSING FIRMWARE
FOR MODEL 9400A DIGITAL OSCILLOSCOPE**

9400AWP01 

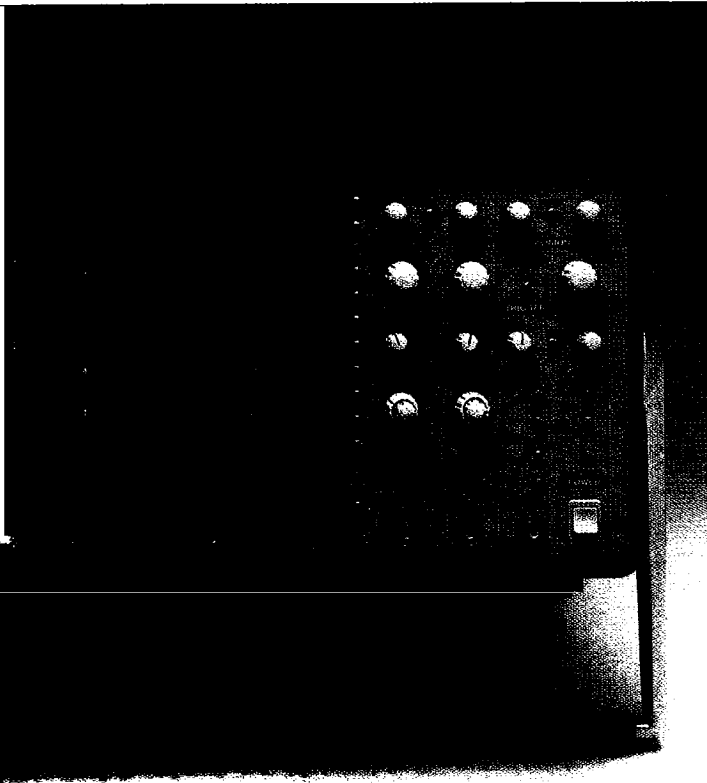

- **Averaging - Summation and Continuous**
- **Arithmetic - including Addition, Subtraction, and Multiplication**
- **Functions - including Integration, Differentiation, and Square Root**
- **Extrema Mode - Storage of Extreme Positive and Negative Values**
- **Smoothing - Reduction of Noise on Single Events**

By chaining different mathematical functions together, the WP01 waveform processing package perform complex measurement sequences with ease. Above, a damped sine wave (top) is squared (middle) and then integrated (bottom) allowing RMS measurements to be calculated.

**FOR SIGNAL
CHARACTERIZATION
AND ANALYSIS**

The LeCroy WP01 Waveform Processing Firmware Package offers powerful routines that extend the use of the 9400A to signal characterization, mathematical analysis, and post-processing of single events. Ordered as an option, or retrofitted, WP01 allows for further extensions of the 9400A's processing capabilities with other firmware packages.

The LeCroy 9400A provides 175 MHz bandwidth, 100 megasamples/sec 8-bit ADCs, $\pm 2\%$ DC accuracy ($\pm 1\%$ optional), 32K memory per channel, and up to 192K of waveform storage memory. It is fully programmable over RS-232-C or optional GPIB interfaces. Plotter drivers enable color archiving via a wide range of digital plotters.

FEATURES

Extensive Signal Averaging – Two operation modes:

- Summation averaging up to 1,000,000 waveforms
- Continuous averaging with weighting factors up to 128.

Averages up to 100,000 words/sec in summation mode.

Offset Dithering – Improves the vertical resolution for low-noise measurements by several bits in summation averaging mode. Reduces the effect of ADC differential non-linearities.

Artifact Rejection – Rejects waveforms that exceed the dynamic range of the ADC to ensure statistical validity of summed average results.

“Extrema” Mode – Keeps track of time and amplitude drift by storing extreme positive and negative values, such as glitches, over a programmable number of sweeps.

Powerful Arithmetic – Processes addition, subtraction, multiplication or division on pairs of waveforms stored in the 9400A's memory locations CH1, CH2, C, D and E. Waveform data can be normalized by additive or multiplicative constants.

Complex Functions – Computes integration, differentiation, square, square root and negation on single waveforms stored in the 9400A memory locations CH1, CH2, C, D and E. Waveform data can be multiplied by constants.

Smoothing – Allows two smoothing modes to reduce unwanted noise on single events:

- Mean value smoothing down to 50 segments
- N-point smoothing with up to 9-point filter.

Vertical Expansion – Provides vertical scale expansion by a factor of up to 10 in signal averaging mode.

Chaining of Operations – Automatically chains two operations.

Example: $F(E) = \text{Average}(\text{CH1-CH2})$.

An indefinite number of operations can be performed sequentially, either manually or via remote control.

Remote Control – Controls remotely all front-panel settings, as well as all waveform processing options via either GPIB or RS-232-C interfaces.

Color Archiving – Copies screen in color using a wide range of digital plotters.

FUNCTIONAL DESCRIPTION

WP01, an optional waveform processing firmware package for the 9400A Digital Oscilloscope, is optimized for processing signals in real time. The powerful 68000-based system permits rapid representation of processed results such as averages, differentiations, multiplications, integrations and smoothing of waveforms.

Waveform operations can be performed on live or stored signals, or a combination of both. They are selected through simple menus, and it is even possible to chain them and compute for example the integral of the multiplication of two traces, or average the difference of CH1 and CH2.

WP01 includes an additional 512 kilobytes random access memory for accumulation, computation and waveform buffering. It permits the accumulation of up to 1,000,000 waveforms of 32000 points each.

All processing occurs in waveform memories E and F which may be displayed on the screen by pressing FUNCTION E, F buttons. Whenever one of the FUNCTIONS E or F or their expansions (EXPAND A or B) is turned on, the corresponding waveform processing is executed and the result displayed.

SIGNAL AVERAGING

WP01 offers two powerful, high-speed signal averaging modes to improve signal-to-noise ratio and provide more accurate measurements. Averaging increases the dynamic range by several bits, allowing the sensitivity to reach μVolts .

Summed averaging consists of the repeated addition,

with equal weight, of recurrences of the selected source waveform. Whenever the required number of waveforms is reached, the averaging process will stop. The total number of waveforms to be accumulated can be selected between 10 and 1,000,000 sweeps in a 1-2-5 sequence. Signals exceeding the dynamic range of the 9400A's 8-bit ADC at any point may be automatically rejected to ensure valid summed averaging results.

The user may also choose to «dither» the programmable offset of the input amplifier. Dithering uses slightly different portions of the ADC for successive waveforms so that the differential non-linearities are averaged. As a result, in a low-noise application, the measurement precision and dynamic range are improved.

Continuous averaging, sometimes called exponential averaging, consists of the repeated weighted average of the source waveform with the previous average. This mode of averaging is a continuous process. The effect of previous waveforms gradually tends to zero. Relative weighting factors can be chosen from 1:1 to 1:127. This averaging mode is most useful for setting up measurements or observing noisy signals that change with time.

EXTREMA MODE

Tracking rare glitches or monitoring signals drifting in time and amplitude is made easy with the unique EXTREMA mode. The computation of extrema consists of a repeated comparison of recurrences of the source waveform with the accumulated extrema waveform.

Whenever a given data point of the new waveform exceeds the existing data point of the accumulated extrema waveform it replaces it. In this way the maximum and/or minimum envelope of all waveforms is accumulated up to a maximum of 1,000,000 sweeps.

ARITHMETIC

WP01 also offers basic arithmetic operations such as addition, subtraction, division, and multiplication. These arithmetic functions can be performed on two source waveforms on a point by point basis. Different vertical gains and offsets of the two sources are automatically taken into account. However, both source waveforms must have the same time-base setting. The first waveform may be multiplied by a constant factor and offset by a constant.

MATHEMATICAL FUNCTIONS

Mathematical functions such as negation, square, square root, integral and differentiation are performed on a single source waveform. The waveform may be multiplied by a constant factor and may be offset by a constant. Arithmetical and mathematical functions may be chained by using memory C and D.

SMOOTHING

WP01 provides two types of smoothing to decrease signal noise of single transient acquisitions.

SPECIFICATIONS

SUMMATION AVERAGING

Number of sweeps: 10 to 1,000,000 can be selected in a 1-2-5 sequence.

Number of points averaged over CH1, CH2: 50 to 32000 in 10 steps.

Offset dithering: up to 6 LSBs may be chosen.

Artifact Rejection: ON/OFF

Theoretical signal-to-noise improvement achievable: 57 dB.

Vertical expansion: 10 times maximum.

Maximum sensitivity: 500 μ V/div after vertical expansion.

CONTINUOUS AVERAGING

Number of sweeps: infinite.

Weighting factors selectable: 1:1, 1:3, 1:7, 1:15, 1:31, 1:127.

Number of points averaged: 50 to 32000 in 10 steps.

Vertical expansion: 10 times maximum.

Maximum sensitivity: 500 μ V/div after vertical expansion.

AVERAGING SPEED

The figures below assume that the display time between triggers is negligible:

record length (= of points)	summation (sweeps/sec)
32000	3
25000	4
12500	6
6250	13
2500	32
1250	51
625	73
250	100
125	112
50	118

Mean value smoothing divides the acquired signal into a chosen number of segments and then generates the smoothed waveform in which each displayed point corresponds to the mean value of "n" points contained in the corresponding segment. The number of segments can be between 50 and 32000. Mean value smoothing takes all digitized points on the screen into account.

N-point smoothing applies a moving average of N points symmetrically placed around each of the 50 to 32000 selected points for display.

Each selected point Y_k is replaced in the smoothed waveform by a processed point Y'_k corresponding to:

$$Y'(k) = \sum_{n=-(N-1)/2}^{(N-1)/2} C(n) Y(k+n)$$

where, in case of a 3-point filter,
 $N = 3$; $C_{-1} = 1/4$; $C_0 = 1/2$; $C_1 = 1/4$

The number of points N can be selected to be 3, 5, 7 or 9.

In interleaved sampling mode, the averaging speed is reduced as more signals are required to complete a displayed waveform.

WAVEFORM ARITHMETIC

Addition, subtraction, multiplication, and ratio can be performed on two live waveforms from CH1 and CH2, or from stored waveforms in memories C, D and E.

$$\begin{aligned} \text{Example: } E &= \text{CH1} - \text{CH2} \\ F &= \text{CH2} * D \\ F &= \text{CH1} + E \end{aligned}$$

Number of points processed: from 50 to 32000 can be selected in 10 steps.

Multiplicative constants: from 0.01 to 9.99 can be selected in steps of 0.01.

Additive constant: from -9.99 to 9.99 divisions can be selected in steps of 0.01.

Vertical expansion: 2 times maximum.

Typical execution time for 1250 points: 600 msec.

WAVEFORM FUNCTIONS

Integration, differentiation, square, square root, negation (invert).

$$\begin{aligned} \text{Examples: } E &= \int \text{CH1} dt \\ F &= - \text{CH2} \\ E &= \frac{dD}{dt} \end{aligned}$$

Number of points processed: from 50 to 32000 can be selected in 10 steps.

Multiplicative constants: from 0.01 to 9.99 can be selected in steps of 0.01.

Additive constant: from -9.99 divisions to 9.99 divisions can be selected in steps of 0.01.

Vertical expansion: 2 times maximum.
Typical execution time for 1250 points:
 400-1000 msec.

MEAN VALUE SMOOTHING

Number of adjacent blocks processed: 50 to 32000 in 10 steps.
Number of points per block: varies with the time base and the number of blocks selected.
Typical execution time for 1250 points: 700 msec.

N-POINT SMOOTHING

Filter coefficients with weighting factors for successive data points:

- 3 point - (1:2:1) 1/4
- 5 point - (1:4:6:4:1) 1/16
- 7 point - (1:6:15:20:15:6:1) 1/64
- 9 point - (1:8:28:56:70:56:28:8:1) 1/256.

Number of points processed: 50 to 32000 in 10 steps.
Vertical expansion: 2 times maximum.
Typical execution time of 1250 points: 500 msec.

EXTREMA MODE

Logs all extreme values of a waveform over a programmable number of sweeps. Maxima and minima are displayed separately by ROOF and FLOOR traces.

Number of sweeps: selected in a 1-2-5 sequence from 1 up to 1,000,000.
Number of points processed: 50 to 32000 in 10 steps. Glitches as short as 10 nsec or 0.04% of the time-base setting are displayed.
Vertical expansion: 2 times maximum.
Typical execution time for 1250 points: 300 msec.
CHAINING OF OPERATIONS
 Two functions can be automatically chained using functions E and F.

Example: E = CH1 - CH2
 F = summed average of E

Manual chaining using memory C and D for intermediate results may continue indefinitely.

REMOTE CONTROL

All front-panel controls and Waveform Processing functions are fully programmable via either the 9400A's GPIB or RS-232-C interfaces. Simple English-like mnemonics are used.

STORED FRONT PANELS

Up to 7 front-panel setups, including WP01 menus, can be stored and recalled by the menu buttons at the left side of the 9400A screen.

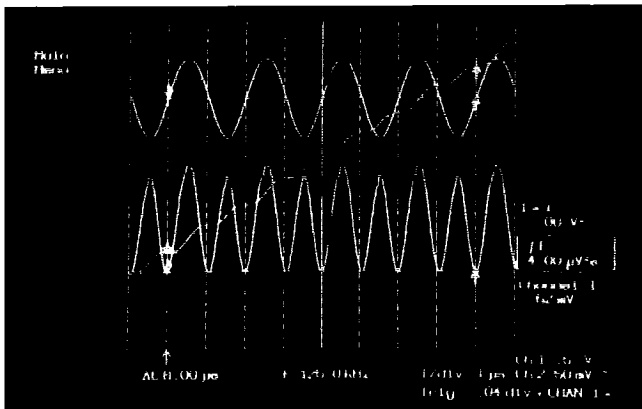

The ±1 V amplitude sine wave in channel 1 (upper trace) is squared (function E: 1 * 1, lower trace) and then integrated (functions F: f/E). The value of the integral between the two cursors is 4.00 μV²s. the RMS value can be calculated with the formula $RMS = (\frac{1}{\Delta t} \int V^2 dt)^{1/2}$. In this case: $RMS = (\frac{1}{8 \mu s} \cdot 4 \mu V^2 s)^{1/2} = 0.707 V$.

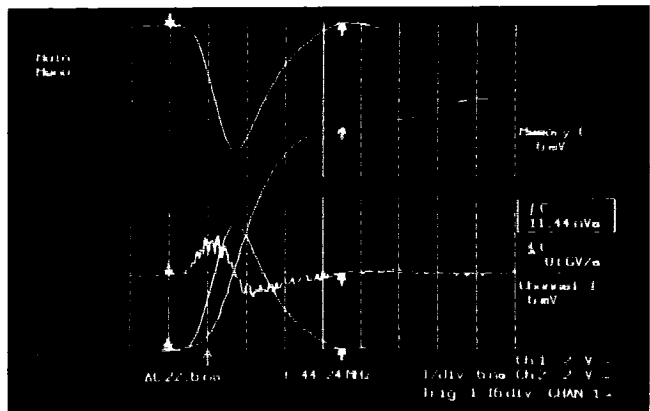

A fast negative going signal at 5 nsec/div (upper trace) recorded in Random Interleaved Sampling mode is inverted and stored in memory C (lower trace). Integral and differential are shown in function E and function F. The area under the inverted curve is measured by first defining the area with the time cursors and then reading the value of C. In this case: 11.44 nVs.

LeCroy
 Innovators in Instrumentation

LeCROY CORPORATE HEADQUARTERS
 700 Chestnut Ridge Road
 Chestnut Ridge, NY 10977-6499
 Telephone: (914) 578-6097
 800-5-LeCroy (532 769)
 TWX: (710) 577-2832
 Fax: (914) 425-8967

LeCROY EUROPEAN HEADQUARTERS
 Route du Nant-d'Avril 101
 P.O. Box 341
 1217 Meyrin 1-Geneva, Switzerland
 Telephone: (022) 82 33 55 Telex: 419 058
 Fax: (022) 82 39 15

Other sales and service representatives throughout the world.

FAST FOURIER PROCESSING PACKAGE

25,000 POINT TRANSFORMS, SPECTRAL AVERAGING

LeCroy

WP02 SPECTRUM ANALYSIS FIRMWARE
FOR MODEL 9400A DIGITAL OSCILLOSCOPE

9400AWP02

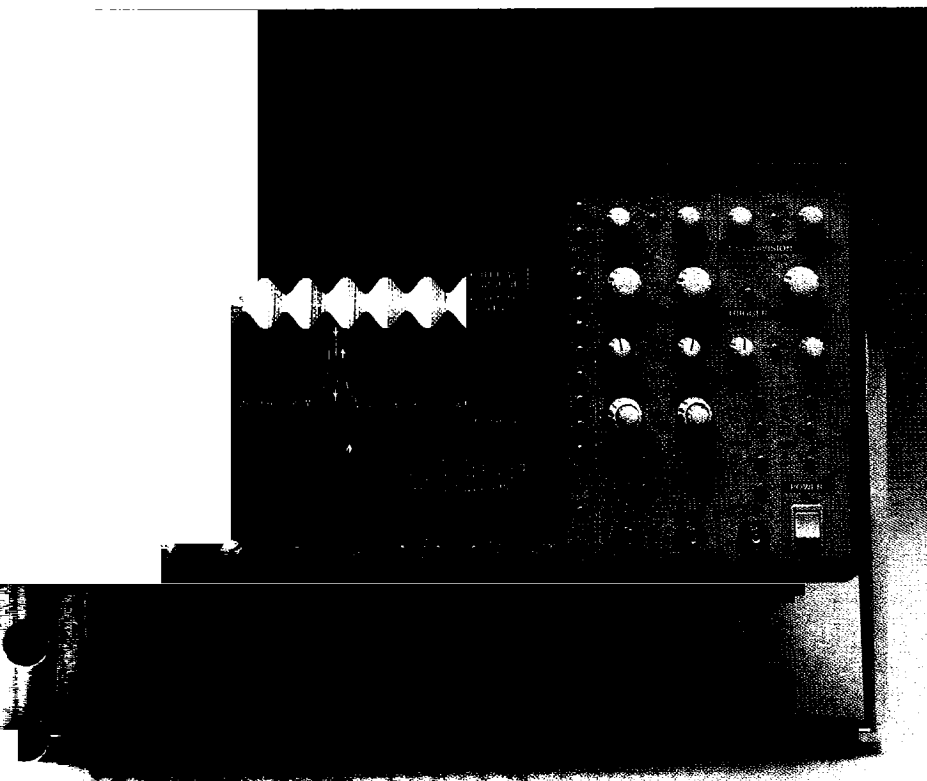

- 50 to 25,000 point FFTs over Two Channels Simultaneously
- Frequency Resolution from 1 Milli-Hz to 50 MHz
- Up to 5 GS/sec Sampling Rate
- Time and Frequency Domain Averaging
- Wide selection of FFT Display Formats and Window Functions

modulated signal (top trace) is analyzed in the frequency domain using the 9400A's FFT processing capability which provides power (middle) and magnitude (lower) information. Side lobes 6 kHz from the fundamental frequency are clearly visible.

FREQUENCY DOMAIN MEASUREMENTS AND ANALYSIS

The WP02 Spectrum Analysis Firmware Package brings powerful FFT routines to extend the capabilities of the 9400A Digital Oscilloscope into frequency domain measurement and analysis. It is available as an option, or may be retrofitted.

The LeCroy 9400A provides 175 MHz bandwidth, 100 megasamples/sec 8-bit ADCs, $\pm 2\%$ DC accuracy ($\pm 1\%$ optional), 32K memory per channel, and up to 192K of waveform storage memory. It is fully programmable over RS-232-C or optional GPIB interfaces. Plotter drivers enable color archiving via a wide range of digital plotters.

FEATURES

Long Record Transforms – Extremely long record FFTs (up to 25,000 points) provide significant signal-to-noise ratio improvement on single phenomena.

Wide Band Frequency Domain Analysis – Covers wide DC to 175 MHz bandwidth with high resolution in the frequency domain.

High Sampling Rates – Up to 5 gigasamples/sec effectively eliminates aliasing errors.

Broad Spectrum Coverage – Executes FFTs over record lengths as long as 25,000 data points giving up to 12,500 spectral components at almost any sampling rate.

Dual Input Channels – Both input channels can be analyzed simultaneously to allow comparison of independent signals for common frequency-domain characteristics.

Fast Processing – FFTs are processed and displayed rapidly, e.g. a 1,250 point waveform is transformed in less than 1.75 sec, a 50 point waveform within 300 msec.

Versatile Display Formats – Frequency-domain data may be presented as magnitude, phase, real, imaginary, log-power, log-PSD (power spectral density); and all may be selected via menu options after signal capture.

Standard Window Functions – Rectangular for transient signals; von Hann (Hanning) and Hamming for continuous waveform data; Flattop for accurate amplitude measurements; Blackman-Harris for maximum frequency resolution.

User-definable Window Functions – Specially defined window functions can be loaded over GPIB and stored in the 9400A's reference memories.

Calibrated Vertical Scaling – Flattop truncation window provides precisely calibrated vertical scaling for all spectral components.

Frequency Domain Averaging – Averages up to 200 FFT results to reduce base-line noise and allows analysis of phase-incoherent and non-triggerable noisy signals.

Time Domain Averaging – Can increase the dynamic range up to 72 dB or more when averaging real-time signals prior to FFT execution. Offset dithering helps to improve dynamic range and reduces ADC non-linearity effects.

Frequency Cursors – Cursors give up to 0.008% frequency resolution and measure power or voltage differences to 0.2% of full scale.

Automatic DC Suppression – DC signal components may be suppressed automatically prior to FFT execution (menu selected).

Full Documentation – The 9400A Digital Oscilloscope status in the Frequency Domain is fully documented on one comprehensive display page specifying Nyquist frequency, number of points, vertical scaling, window function, etc.

Chaining of Operations – Chains two operations automatically, e.g. Function F = FFT of (CH1 X CH2). Any number of operations may be performed sequentially, either manually or via remote control.

Full Remote Control – All front-panel settings and waveform processing functions are programmable via GPIB and/or RS-232-C interfaces. Acquired and processed waveforms can be downloaded to a computer and can later be retrieved and displayed on the 9400A.

Color Archiving – Provides color hard copies of the screen, using a wide range of digital plotters.

FFT BRINGS STRONG SPECTRAL ANALYSIS CAPABILITIES TO THE 9400A

POWERFUL PERFORMANCE IN A WIDE RANGE OF APPLICATIONS

The versatility and performance of the WP02-FFT package with the 9400A make it an ideal tool for a variety of applications such as:

Electronic engineering - As a very high performance spectrum analyzer it is extremely useful for measuring phase noise, characterizing filters, amplifier bandwidth roll-off, or harmonic distortion.

Communications - The FFT analyzer is ideal for characterizing HF links, modems and data links, cable TV, PCM, fiber optics, etc.

Acoustic devices - Covers the entire audio spectrum in one FFT operation from 25 kHz downwards with 2 Hz resolution.

Preventive maintenance systems - With a motion transducer (accelerometers/velocity and/or displacement transducers), the 9400AWP02 package can be used to analyze the vibration signatures of rotating and reciprocating machinery for early detection of wear or damage.

Non-destructive test engineering - The high bandwidth and sampling rate of the 9400A, together with its long memories, make it a valuable instrument for ultrasound non-destructive testing. "Long record FFTs" provide unprecedented spectral resolution, hence improved characterization of the material under test, and much shorter measuring times.

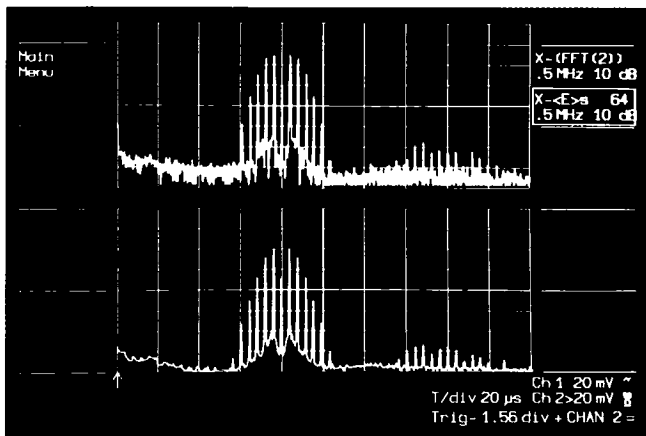

A 2 MHz signal is frequency modulated with a 99 kHz sine wave. To improve the signal-to-noise ratio on the phase-incoherent FM signal, spectral averaging of 64 spectra is used (bottom trace). The part of the spectrum at the right-hand side is the 2nd harmonic of the carrier with sidebands.

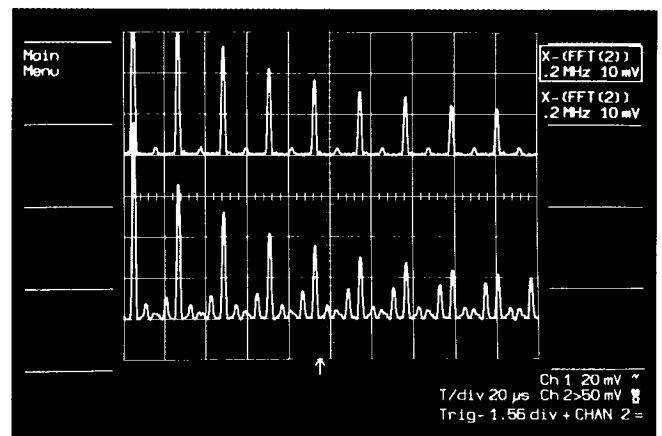

Long records allow higher sampling rates, to reduce aliasing. A 110 kHz square wave is recorded over 1250 and 6250 points with sampling rates of 200 and 40 nsec/point respectively. The bottom trace, a short record transform, has considerable aliasing whereas the longer record transform (top) is alias-free.

Redefine Trace	Definition of Function E	
Previous FIELD	Function Class:	Fourier Transform
Next	Display Type:	Power Density
	Max. # Points:	25000
	Source Trace:	Chan 2
Previous VALUE	Window Type:	Hanning
Next	Multiplication Factor:	1.00
	Additive Constant:	+0.00 div
	Zero-Suppression:	OFF
Return	Function E = FFT(Chan 2) For 25000 pnts, Nyquist=625 MHz	

The FFT menu documents all the relevant parameters.

LeCROY CORPORATE HEADQUARTERS
700 Chestnut Ridge Road
Chestnut Ridge, NY 10977-6499
Telephone: (914) 425-2000
TWX:(710) 577-2832
Fax: (914) 425-8967

LeCROY EUROPEAN HEADQUARTERS
2, rue Pré-de-la-Fontaine
P.O. Box 341
1217 Meyrin 1-Geneva, Switzerland
Telephone: (022) 719 21 11 Telex: 41 90 58
Fax: (022) 782 39 15

Other sales and service representatives throughout the world.

LeCroy
Innovators in Instrumentation

FUNCTIONAL DESCRIPTION

FOURIER PROCESSING

Fourier processing is a mathematical technique which permits a time-domain waveform to be described in terms of frequency-domain magnitude and phase, or real and imaginary spectra. In spectral analysis, a waveform can be sampled and digitized, then transformed by a discrete Fourier transform (DFT). Fast Fourier Transforms are a set of algorithms used to reduce the computation time (by better than a factor of 100 for a 1000 point FFT) needed to evaluate a DFT. The principal advantage of the FFT is the rapidity with which it can analyze large quantities of waveform samples. In effect, using standard measurement techniques, it converts a time-domain instrument into digital spectrum analyzer.

The WP02 Fast Fourier Processing Package enhances the outstanding features of the LeCroy 9400A Digital Oscilloscope. It provides high resolution, wide-band spectrum analysis capabilities along with sophisticated window functions and fast processing.

FFT AND THE LeCROY 9400A DIGITAL OSCILLOSCOPE

In FFT mode, the 9400A provides measurement capabilities superior to those of common swept spectrum analyzers.

In particular, it is now possible to perform spectral analysis on continuous and single events at an economic price. And it enables users to obtain time and frequency values simultaneously and to compare phases of the various frequency components with each other. Rather than the commonly used "power of two" record lengths the routines used in the WP02 package feature decimal record lengths, which can be selected in a 1-2-5 order. Resulting spectra are therefore also calibrated in convenient decimal Hertz values.

SPECIFICATIONS

VERTICAL ANALOG SECTION

Inputs: two; BNC connectors.

Sensitivity: 5 mV/div to 1 V/div at 50 Ω impedance and 5 mV/div to 5 V/div at 1 M Ω impedance; detents at 1-2-5, variable 1:2.5.

DC accuracy: standard $\leq \pm 2\%$; optional $\leq \pm 1\%$.

Bandwidth (-3 dB):

@ 50 Ω : DC - 175 MHz at 10 mV/div, up to 225 MHz at 1 V/div;
DC - 150 MHz at 5 mV/div.

@1 M Ω AC: 10 Hz-100 MHz typical

@1 M Ω DC: DC-100 MHz typical

Bandwidth limiter: 30 MHz (-3 dB).

Input impedance: 1 M Ω //50 pF and 50 Ω characteristic.

Maximum input: 250 V (DC + peak AC) at 1 M Ω , 5 V DC (500 mW) or ± 10 V peak AC at 50 Ω .

Offset: ± 8 divisions in 0.04-division increments.

The FFT's digital nature ensures high accuracy, stability and repeatability. These are strongly supported by the 9400A's superb DC and dynamic accuracy specifications, such as standard $\pm 2\%$, optional $\pm 1\%$, DC accuracy, high effective-bit count and increased resolution through signal averaging and dithering.

With the 9400A, signals may be acquired and processed simultaneously using Channels 1 and 2. This is particularly useful when looking for common frequency-domain characteristics in both signals or for characterization of networks.

IMPROVED RESOLUTION

The Fast Fourier Transform calculates equally-spaced frequency components from DC to the full 9400A bandwidth. By lowering the sampling rate, it is possible to make measurements with 1 milli-Hertz resolution up to 12.5 Hz (Nyquist). By increasing the sampling rate to 5 gigasamples/sec (200 psec/point) in Random Interleaved Sampling mode, the widest resolution becomes 50 MHz and the Nyquist frequency 2.5 GHz... comfortably above the highest frequency components recordable by the 9400A, thus virtually eliminating aliasing effects.

VERSATILE WINDOW FUNCTIONS

The WP02-FFT software provides a selection of window functions, designed to minimize leakage and to maximize spectral resolution of single and non-cyclic events. These include the familiar rectangular or unmodified window typically used for transient events, the von Hann (Hanning) and Hamming windows for continuous signals, and, in addition, Flattop and Blackman-Harris windows for more precise amplitude (power) measurements or strong suppression of side lobes respectively.

Furthermore, user-defined window functions may be loaded onto the 9400A via the GPIB interface. Through multiplication, they modify the acquired signal followed by FFT in an automated fashion.

MEMORIES

Acquisition memory: 32K x 8 bits per channel (CH1 and CH2).

Reference memory: 32K x 16 bits per reference memory (C and D).

Function memory: 32K x 16 bits per function memory (E and F).

The content of the acquisition and function memories can be stored in reference memories C and D.

Record length selection for FFT

Function memories E and F only: 50-25000 data points in 9 steps in 1-2-5 sequence. Record lengths are selected by decimation after signal acquisition. This implies that the Nyquist criterion can be adjusted and optimized after signal acquisition and prior to FFT execution.

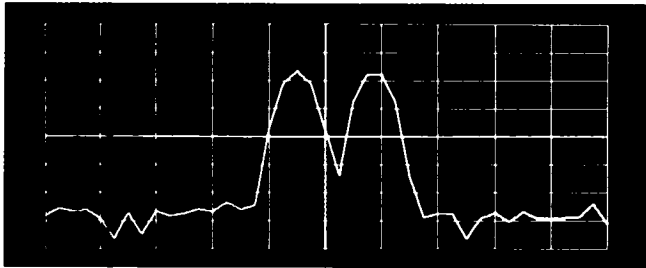

Blackman-Harris

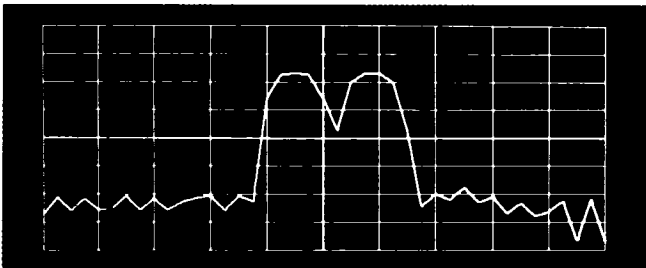

Flat top

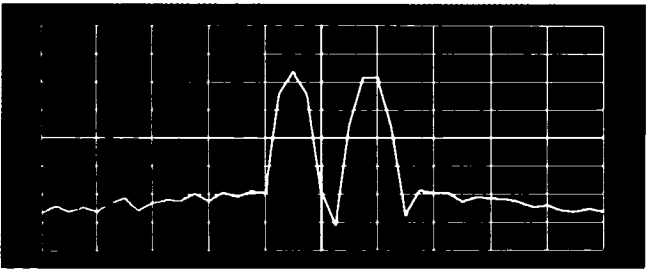

Hamming

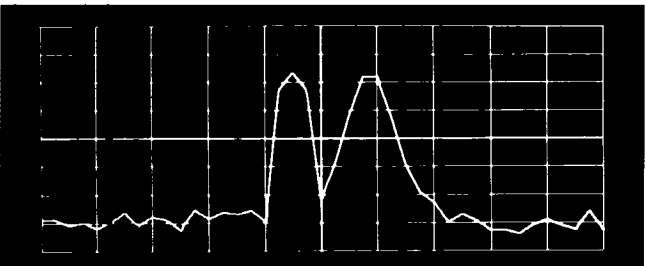

von Hann (Hanning)

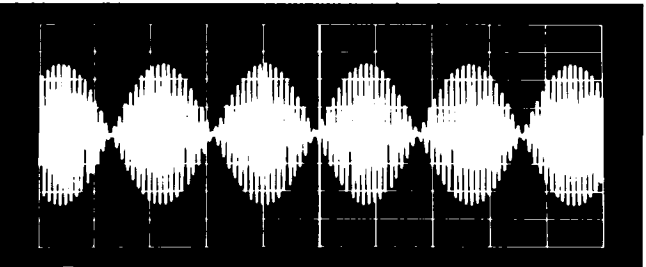

The sum of two 1 V p-p sinusoids of 500 kHz and 527.5 kHz is digitized over 2,500 points and transformed to the frequency domain. 4 different window functions are applied to indicate their effect on leakage suppression and spectral resolution. The vertical scale factor is 10 dB/div, 80 dBm full scale.

REMOTE CONTROL

All front-panel controls and WP01 and WP02 processing functions are fully programmable via the 9400A GPIB and RS-232-C interfaces. Simple English-like mnemonics are used.

STORED FRONT PANELS

Up to 7 front-panel setups, including WP01 and WP02 menu settings can be stored and recalled by the menu buttons at the left side of the 9400A screen.

WP02-FFT INSTALLATION

A WP02-FFT package may be retrofitted to a LeCroy 9400A Digital Oscilloscope. The WP01 Signal Processing hardware and software is a prerequisite for installation of WP02.

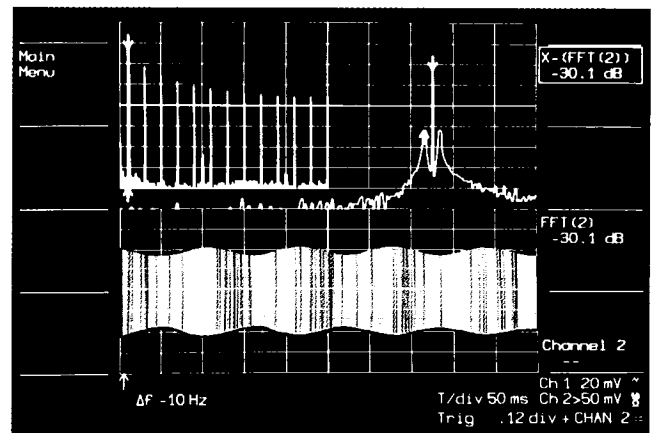

Long records give wide frequency span. FFT of 1000 Hz sine-amplitude modulated square wave, recorded over 25,000 points, shows harmonics up to 25 kHz. Expansion shows sidebands at 10 Hz and -30.1 dB.

ORDERING INFORMATION

Oscilloscope and Options

Code	Description
9400A	Digital Oscilloscope
9400AOP01	High-precision option ($\pm 1\%$ DC accuracy)
9400AWP01	Waveform processing option
9400AWP02	Fast Fourier processing option (requires 9400AWP01)
9400AMS01	Mass storage and remote control package, including an IBM lap-top controller, interface, cables and software
9400AIM01	GPIB interface for IBM-PCC computers

Oscilloscope Accessories

OM9400A	Operator's Manual
SM9400A	Service Manual
CA9001	Camera (using Polaroid film) and Hood
CA9002	Camera adapter (35 mm) with Hood
CS9400	Certified Calibration
DP9001	Digital Plotter, 8-pen A4 size
OC9001	Oscilloscope Cart
RM9400	Adapter Kit for Rack Mounting
SG9001	High-voltage protector
TC9001	Transit Case
TC9002	Protective Cover

FREQUENCY

Frequency range: DC to > 175 MHz.
Frequency resolution: 1 mHz to 50 MHz.
Nyquist frequency range: 25 mHz to 2.5 GHz.
Frequency scale factors: 5 mHz/div to 500 MHz/div in 1-2-5 sequence.
Frequency accuracy: 0.008% at center lobe.
Horizontal expansion: up to 100 times.
Cursors: Differential (arrows) and absolute (crosshair) provide frequency and related amplitude measurements.

AMPLITUDE AND PHASE

General

Amplitude accuracy: see window functions table below.
Signal overflow: A warning indication is provided at the top of the 9400A display when the input signal exceeds the ADC range.
DC suppression: selected via the menu (ON/OFF), removes DC component prior to FFT execution.
Cursors: Horizontal bars provide differential amplitude measurements.
Number of traces: Time domain and frequency domain data can be displayed simultaneously (up to 4 traces).

Spectrum Display Formats and Scaling

Real spectrum, in V/div, zero base line at 0 div (center of screen).
Imaginary spectrum in V/div, zero base line at 0 div.
Power spectrum in dBm.
Power spectral density in dBm.
Frequency Domain Averaging up to 200 spectra for power, PSD or magnitude.
Log display applies to power and PSD spectra in 10, 5, 2 or 1 dB/div; 80 dB display range.
 Markers at left edge of screen give absolute dBm reference (0 dBm is 1 mW into 50 Ω).

Phase

Phase range: + 180 degrees to - 180 degrees.
Phase accuracy: \pm 5 degrees.
Phase scale factor: 50 degrees/div.
Zero base line: 0 div (center of screen).

Calibrated Vertical Expansion

All spectra formats, up to 10 times, in 1-2-5 sequence.

Window Functions

Selected in menu: Rectangular, von Hann (Hanning), Hamming, Flattop, Blackman-Harris and user definable. The table below gives filter pass band shape and resolution:

FILTER PASS BAND AND RESOLUTION

Window type	Filter band-width at 6dB (freq. bins)	Highest side lobe (dB)	Scallop Loss (dB at bin)	Noise band-width (freq. bins)
Rectangular	1.21	-13	3.92	1.0
von Hann	2.00	-32	1.42	1.5
Hamming	1.81	-43	1.78	1.36
Flattop	1.78	-44	0.01	2.96
Blackman-Harris	1.81	-67	1.13	1.71

Definitions

Filter bandwidth at -6dB characterizes the frequency resolution of the filter.
Highest side lobe indicates the reduction in leakage of signal components into neighboring frequency bins.
Scallop loss gives amplitude accuracy of the magnitude spectrum.
Noise bandwidth is the bandwidth of an equivalent rectangular filter.

FFT EXECUTION TIME

FFT execution times, including window calculations and display generation, are provided in the graph below:

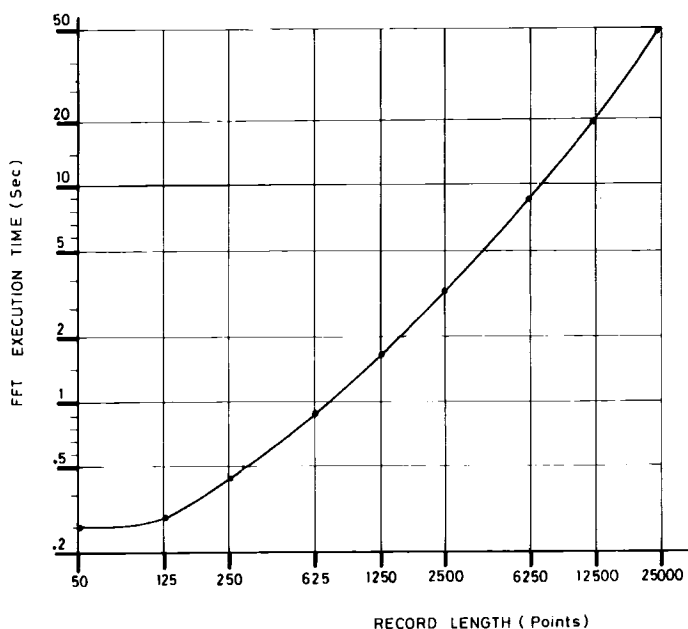

WP01 SIGNAL AVERAGING/ARITHMETIC PROCESSING (Prerequisite for WP02)

Summation averaging: 10-1,000,000 signals.
Continuous averaging: infinite number of signals, weighting factors 1, 3, 7, 15, 63, 31, 127.
Waveform arithmetic: +, -, *, \div .
Waveform functions: integration, differentiation, square, square root, negation (inversion).
Smoothing: 1-, 3-, 5-, 7-, 9-point filters.
Extrema: records extreme values (envelopes) over a programmable number of sweeps.

CHAINING OF OPERATIONS

Two functions can be automatically chained using functions E and F.

Examples: $fnE = CH1 * CH2$
 $fnF = FFT \text{ of } fnE$
 $fnE = FFT \text{ of } CH1$
 $fnF = \text{Integral } fnE$

Manual chaining using memories C and D for intermediate results may continue indefinitely.

SECTION 1

GENERAL INFORMATION

1.1 Warranty

LeCroy warrants its oscilloscope products to operate within specifications under normal use, and services them for a period of two years from the date of shipment. Spares, replacement parts and repairs are warranted for 90 days. Software is thoroughly tested but is supplied "as is" with no warranty of any kind covering detailed performance. Accessory products not manufactured by LeCroy are covered solely by the warranty of the original equipment manufacturer.

In exercising this warranty, LeCroy will repair or, at its option, replace any product returned to the Customer Service Department or an authorized service facility within the warranty period, provided that the warrantor's examination discloses that the product is defective due to workmanship or materials, and that the defect has not been caused by misuse, neglect, accident or abnormal conditions or operation.

The purchaser is responsible for the transportation and insurance charges arising from the return of products to the servicing facility. LeCroy will return all in-warranty products with transportation prepaid.

This warranty is in lieu of all other warranties, expressed or implied, including but not limited to any implied warranty of merchantability, fitness, or adequacy for any particular purpose or use. LeCroy shall not be liable for any special, incidental, or consequential damages, whether in contract, or otherwise.

1.2 Assistance and Maintenance Agreements

Answers to questions concerning installation, calibration, and use of LeCroy equipment are available from the Customer Service Department, 700 Chestnut Ridge Road, Chestnut Ridge, New York 10977-6499, U.S.A., (914)578-6097, and 101 Route du Nant d'Avril, 1217 Meyrin 1, Geneva, Switzerland, (41)22/782-33-55, or your local field engineering office.

LeCroy offers a selection of customer support services. For example, maintenance agreements provide extended warranty and allow the customer to budget maintenance costs after the initial two year warranty has expired. Other services requested by the customer such as installation, training, on-site repair, and addition of engineering improvements are made available through specific Supplemental Support Agreements.

1.3 Documentation Discrepancies

LeCroy is committed to providing state-of-the-art instrumentation and is continually refining and improving the performance of its products. While physical modifications can be implemented quite rapidly, the corrected documentation frequently requires more time to produce. Consequently, this manual may not agree in every detail with the accompanying product. There may be small discrepancies in the values of components for the purposes of pulse shape, timing, offset, etc., and, occasionally, minor logic changes. Where any such inconsistencies exist, please be assured that the unit is correct and incorporates the most up-to-date circuitry.

1.4 Service Procedure

Products requiring maintenance should be returned to the Customer Service Department or authorized service facility. If under warranty, LeCroy will repair or replace the product at no charge. The purchaser is only responsible for the transportation charges arising from return of the goods to the service facility.

For all LeCroy products in need of repair after the warranty period, the customer must provide a Purchase Order Number before any equipment which does not operate correctly can be repaired or replaced. The customer will be billed for the parts and labor for the repair as well as for shipping.

1.5 Return Procedure

To determine your nearest authorized service facility, contact the factory or your field office. All products returned for repair should be identified by the model and serial numbers and include a description of the defect or failure, name and phone number of the user, and, in the case of products returned to the factory, a Return Authorization Number (RAN). The RAN may be obtained by contacting the Customer Services Department in New York on 914-578-6059, in Geneva on (022) 782-33-55 or your nearest sales office.

Return shipments should be made prepaid. LeCroy will not accept C.O.D. or Collect Return Shipments. Air-freight is generally recommended. Wherever possible, the original shipping carton should be used. If a substitute carton is used it should be rigid, and should be packed such that the product is surrounded with a minimum of four inches of excelsior or a similar shock-absorbing material. In addressing the shipment, it is important that the Return Authorization Number be displayed on the outside of the container to ensure its prompt routing to the proper department within LeCroy.

1.6 Initial Inspection

It is recommended that the shipment be thoroughly inspected immediately upon delivery to the purchaser. All material in the container should be checked against the enclosed Packing List. LeCroy cannot accept responsibility for shortages in comparison with the Packing List unless notified promptly. If the shipment is damaged in any way, please contact the factory or local field office immediately.



SECTION 2

PRODUCT DESCRIPTION

2.1 Introduction

The LeCroy 9400A is a high-performance digital oscilloscope suited to research and to test and measurement applications. It is used to capture, analyze, display and archive electrical waveforms in fields such as electronic engineering, physics research, automated testing and measurement, telecommunications, electromagnetic pulse and interference measurement, LIDAR technology and ultrasonics research.

2.2 9400A Architecture

The 9400A has been built around the powerful 68000 microprocessor which is used by the unit to perform computations and control oscilloscope operation.

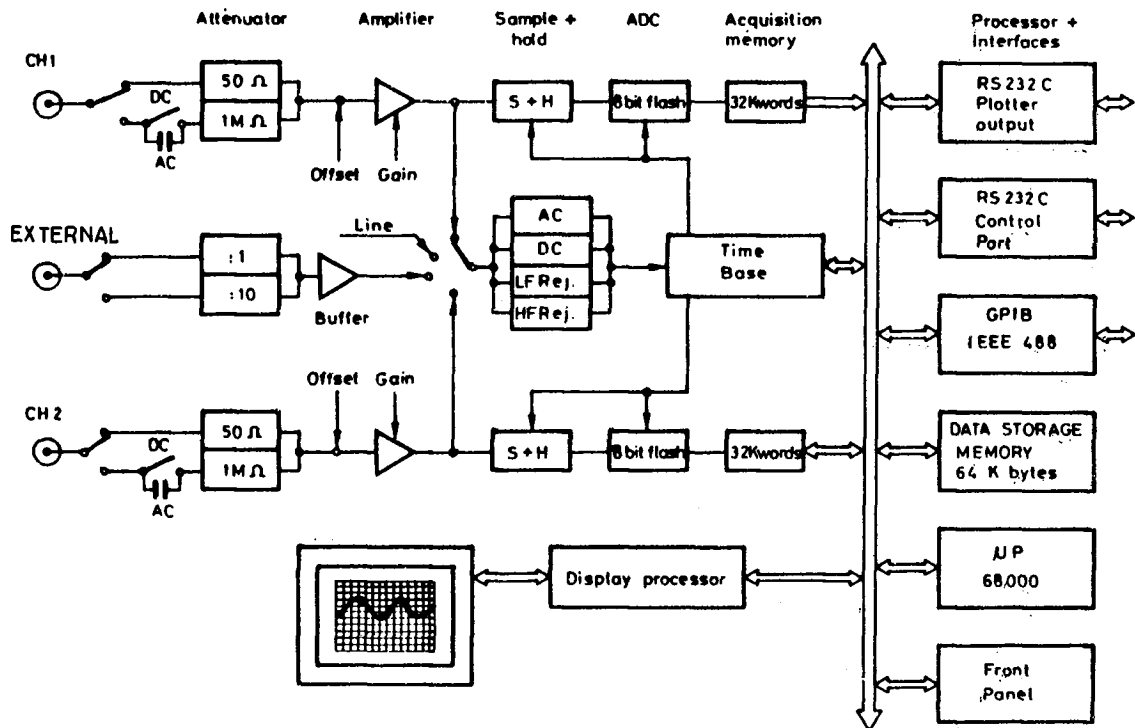

9400A BLOCK DIAGRAM

Figure 2.1

All front panel rotary knobs and push buttons are constantly monitored by the internal processor, and front panel setups are rapidly reconfigured via the unit's internal 16-bit bus. Data are quickly processed according to the selected front panel setups, and are transferred to the acquisition memory for direct waveform display or stored in the 9400A's reference memories.

The 68000 controls the unit's two RS-232-C ports which are used to directly interface the 9400A to a digital plotter, remote terminal or other slow-speed device and also controls GPIB (IEEE-488) operation when the 9400A is equipped with the I/O option, OP02.

2.3 ADCs and Memories

The 9400A's two identical input channels are equipped with a 100 megasample/second (megasample/sec), 8-bit ADC and a 32 kiloword acquisition memory (See Figure 2.1). This dual ADC architecture ensures absolute amplitude and phase correlation, maximum ADC performance for both single and dual channel acquisition modes, large record lengths and high time resolution.

The 9400A's two 32K acquisition memories simplify transient capture by providing very long waveform records that capture waveform features even when trigger timing is uncertain. In addition, very accurate time measurement is made possible by a digitally controlled zoom providing an expansion factor of up to 100 times the time base speed.

The 9400A oscilloscope is capable of acquiring and storing repetitive signals at a Random Interleaved Sampling rate of 5 gigasamples/second (gigasamples/sec). An exclusive high-precision time digitizing technique enables measurement of repetitive signals to a bandwidth of 175 MHz at an effective measuring interval of 200 psec.

The 9400A's very low aperture uncertainty of 10 psec assures precision measurements over its entire range as indicated by the table below:

Overall* dynamic accuracy (typical), RMS sine wave curve fit

Input Frequency (MHz)	1	10	50	100	175
Signal-to-noise Ratio (dB)	41.9	41.9	41.9	37.1	29.9
Effective bits	7.0	7.0	7.0	6.2	5.0

* including the front-end amplifier, sample and hold and ADC

9400A PERFORMANCE

Table 2.1

2.4 Trigger

The 9400A's digitally-controlled trigger system offers facilities such as pre-trigger recording, bi-slope and window triggering, sequence and roll modes in addition to the standard operating modes of Auto, Normal and Single (Hold). The trigger source can be external or can be either of the two inputs, and the coupling is selected from AC, LF REJECT, HF REJECT and DC.

2.5 Automatic Calibration

The 9400A has an automatic calibration facility that ensures overall vertical accuracies of $\pm 2\%$ (optionally $\pm 1\%$) and ± 20 psec RMS for the unit's crystal-controlled time base.

The time base is calibrated each time the 9400A's time base control is adjusted to a new TIME/DIV setting; vertical gain and offset calibration take place each time the front panel fixed gain control for either CHAN 1 or CHAN 2 is adjusted to a new VOLTS/DIV setting. Calibration of both channels also takes place each time the BANDWIDTH LIMIT push button is pressed.

Further information on automatic calibration may be found in Section 9.4, "Auto-calibration".

2.6 Display

The 9400A's large 12.5 cm \times 17.5 cm (5 \times 7 inches) screen displays analog waveforms with high precision and serves as an interactive, user-friendly interface via a set of screen-oriented push buttons located immediately to the left and right of the CRT.

The oscilloscope displays up to four waveforms, while simultaneously reporting the parameters controlling signal acquisition. In addition, the screen presents internal status and measurement results, as well as operational, measurement, and waveform analysis menus.

A hard copy of the 9400A's screen is available via the unit's dedicated plotter port.

2.7 Manual and Programmed Control

The 9400A's front panel layout and operation will be very familiar to users of analog oscilloscopes. The interactive software menus assist in quickly utilizing the recording and processing capability of the 9400A to its full potential.

The 9400A has also been designed for remote control operation in automated testing and computer aided measurement applications. The entire measurement process, including dynamic modification of front panel settings and display organization, can be controlled via the rear panel RS-232-C and optional GPIB (IEEE-488) ports. GPIB control enables direct interfacing between the 9400A and a host computer at data transfer rates of up to 400 kilobytes/sec.

The LeCroy 9400A is capable of storing up to seven front panel setups which may be recalled either manually or by remote control, thus ensuring rapid oscilloscope front panel configuration. When the power is switched on, the 9400A's front panel settings are the same as when it was last used.

SECTION 3

INSTALLATION

3.1 Safety Information

The 9400A has been designed to operate from a single-phase power source with one of the current-carrying conductors (neutral conductor) at ground (earth) potential. Operation from power sources in which both current-carrying conductors are live with respect to ground (such as phase-to-phase on a tri-phase system) is not recommended, as the 9400A is equipped with over-current protection for one mains conductor only.

The 9400A is provided with a three-wire electrical cord containing a three-terminal polarized plug for mains voltage and safety ground connection. The plug's ground terminal is connected directly to the frame of the unit. For adequate protection against electrical hazard, this plug must be inserted into a mating outlet containing a safety ground contact.

3.2 Operating Voltage

Prior to powering up the unit, make certain that the mains voltage for your area corresponds to the mains voltage value appearing in the window of the selector box at the rear of the 9400A.

The operating voltage for the 9400A is either 115 V or 220 V at 48 to 62 Hz. Switching from one mains voltage to another is not possible. If the mains voltage appearing in the window differs from that used in your area contact the nearest LeCroy sales office or distributor.

CAUTION

If a 9400A set for 115 V is plugged into a 220 V power source, severe damage can occur. Before powering up the unit, ensure that the correct line voltage has been set.

3.3 Switching on the 9400A

Switch on the 9400A by setting the **POWER** switch (26) to the ON position. An auto-calibration takes place and the grid is displayed after approximately 15 seconds.

Note that the 9400A is reset to the configuration it was in prior being to switched off.

SECTION 4

DISPLAY LAYOUT

The 9400A's CRT area is divided between the centrally located grid and six other fields. Traces from the acquisition or reference memories are displayed on the grid. A dual grid system is also available by pressing push button 14 (see Figure 1.1). The six fields are used to display such information as interactive menu queries and responses, current acquisition parameters, relative and absolute time and voltage measurements, and messages to assist the user.

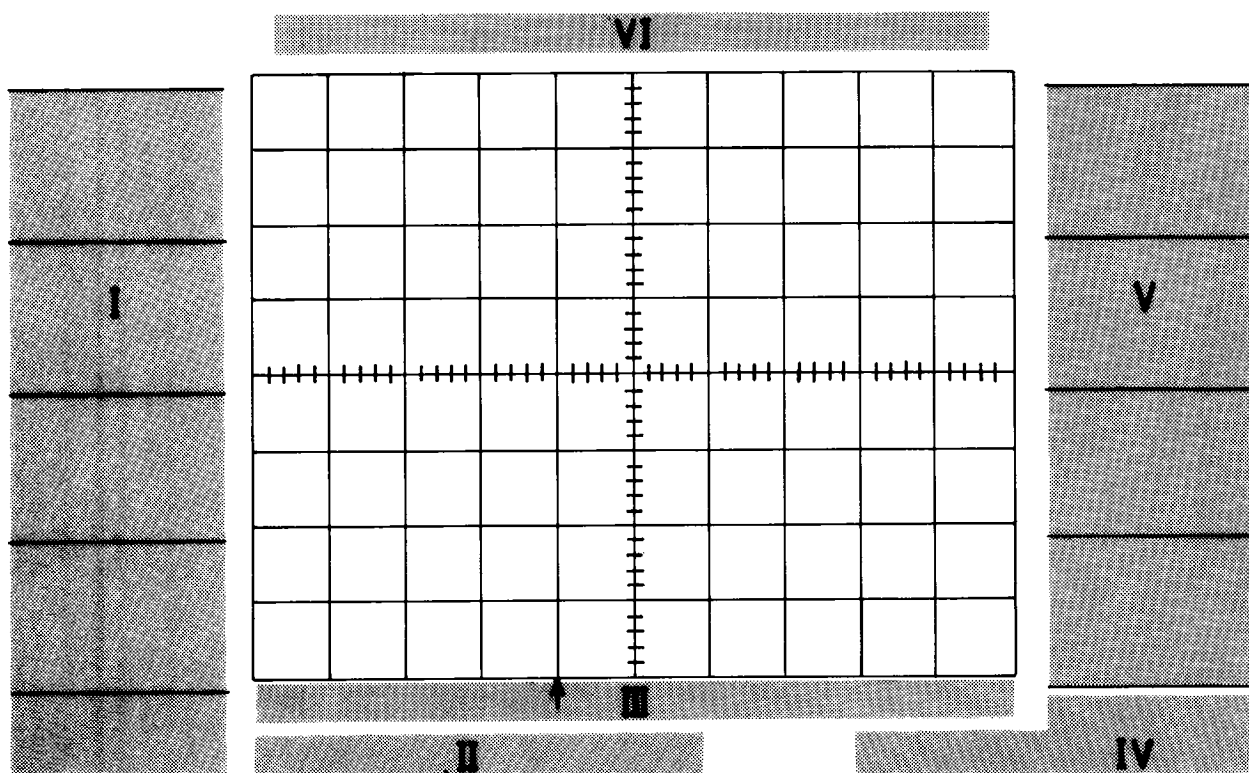

DISPLAY LAYOUT

Figure 4.1

4.1 Menu Field (I)

This field is divided into nine sub-fields associated with menu keys 2-10. Each field may display the name of a menu or perform an operation when the related menu key is pressed. The lowest field and related Return push button (10) are used to restore the higher menu level.

4.2 Time and Frequency Field (II)

When the Marker cursor is activated by pressing push button (18), this field displays the time difference between the Marker cross-hair and the point of triggering (common for all displayed traces).

When the Time cursors are activated by pressing push button (17), two readings are indicated. The left-hand reading indicates the time interval between the Reference and Difference arrowhead cursors, while the right-hand reading indicates the frequency corresponding to $1/(\text{Time interval})$.

4.3 Trigger Delay Field (III)

This field indicates one of the two trigger delay modes. In the pre-trigger mode, an upward-pointing arrow appears below the bottom line of the trace display grid, as shown in Figure 4.1. It is adjustable from 0 to 10 divisions, corresponding to a 0 to 100% pre-trigger setting. In the post-trigger mode, this arrow is replaced by a leftward-pointing arrow next to the post-trigger indication (in decimal fractions of a second) at the bottom of the grid. The maximum post-trigger setting corresponds to 10000 screen divisions.

4.4 Abridged Front Panel Status Field (IV)

This is a short-form display of the data acquisition parameters, and is updated whenever the 9400A's front panel controls are manipulated. This field indicates vertical sensitivities, input couplings, time base and trigger conditions.

See Section 5 for a detailed list of front panel parameters (including the absolute value of input offset).

4.5 Displayed Trace Field (V)

The Displayed Trace field is associated with push buttons 45-50. The data displayed in this field are the identity of the displayed trace, and the current time base and sensitivity settings for the acquired signal, as well as an indication of the position of the VAR sensitivity vernier (28). The symbol ">" appears when the vernier is not in the detent position (i.e. not in the fully clockwise position). Whenever Measurement Cursors (16, 17, 18) are activated, absolute or relative waveform voltage data are displayed in this field.

A frame formed around one of the upper six signal sources in the Displayed Trace field indicates which of the traces is to be acted upon during manipulation of the various display controls ((39) through (43).

Display Layout

4.6 Message Field (VI)

Messages appearing in field (VI) indicate the 9400A's current acquisition status or report improper manipulation of the front panel controls. The following figure illustrates a typical message displayed in the Message field.

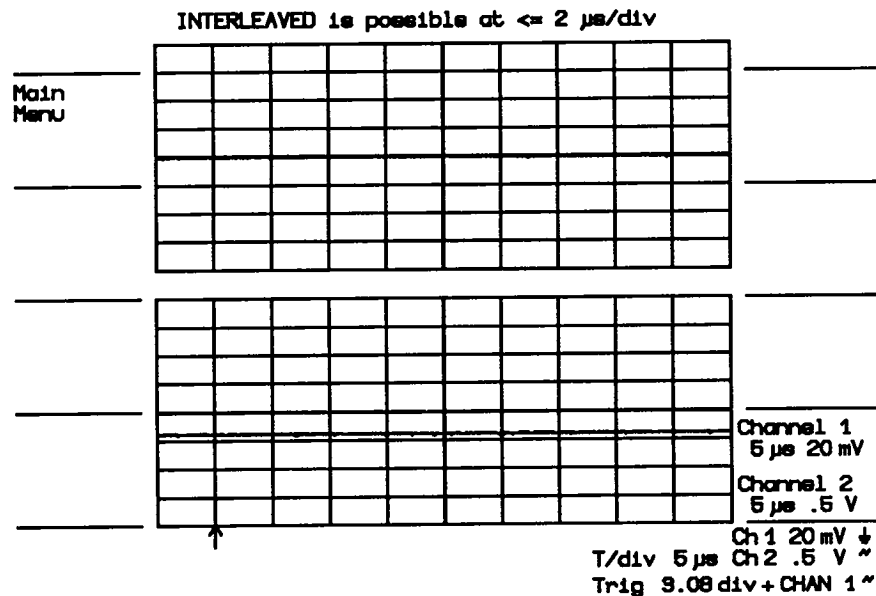

EXAMPLE of MESSAGE FIELD DISPLAY

Figure 4.2

NOTE

In the following sections, Roman numerals in parentheses refer to the display field numbering scheme in Figure 4.1. Arabic numerals relate to the numbering scheme used to refer to front and rear panel controls and connectors in Figures 1.1 and 1.2.



SECTION 5

MANUAL OPERATION

5.1 Front-Panel Controls

5.1.1 Vertical

Input Connectors (21) - BNC type connectors are used for both CHAN 1 and CHAN 2 signal inputs as well as the external trigger connector. The maximum permissible input voltage is 250 V (DC + peak AC).

Signal Coupling and Input Impedance (22) - Selects the method used to couple a signal to the vertical amplifier input.

Possible selections: AC, GND, or DC with 1 M Ω impedance
DC with 50 Ω impedance

In the AC position, signals are coupled capacitively, thus blocking the input signal's DC component and limiting the lower signal frequencies to < 10 Hz.

In the DC position, all signal frequency components are allowed to pass through, and the input impedance may be chosen to be 1 M Ω or 50 Ω . The user should note that with 1 M Ω input impedance the bandwidth is limited to 100 MHz. The maximum dissipation into 50 Ω is 0.5 W, and signals will automatically be disconnected whenever this occurs. A warning LED (OVERLD) lights when an overload condition is detected. The input coupling LED (22) is simultaneously switched to GND. The overload condition is reset by removing the signal from the input and selecting a 50 Ω input impedance again.

VOLTS/DIV (27) - Selects the vertical sensitivity factor in a 1-2-5 sequence. The sensitivity range is from 5 mV to 5 V/div at 1 M Ω input impedance and from 5 mV to 1 V/div at 50 Ω impedance (when the VAR vernier (28) is in the detent position, i.e. turned fully clockwise).

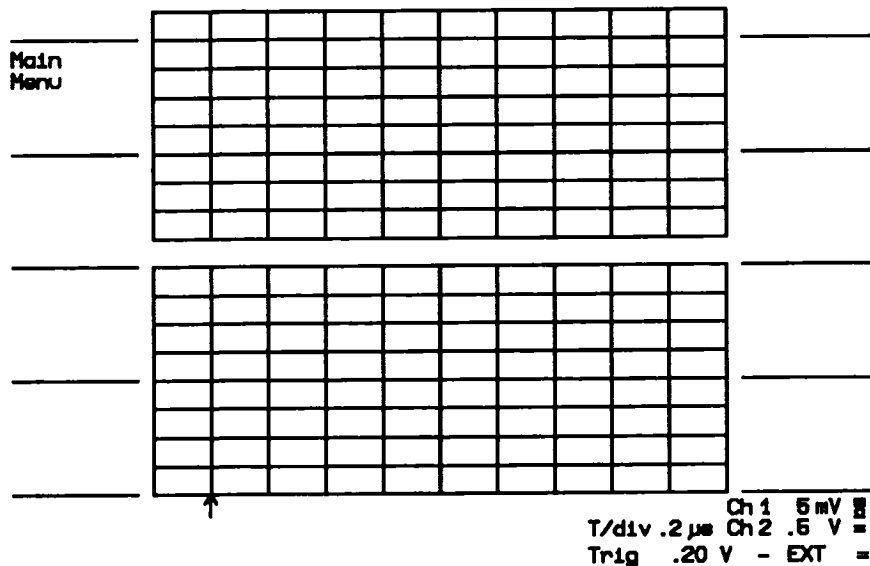

DISPLAY of VERTICAL SENSITIVITY PARAMETERS
in the ABRIDGED PANEL STATUS FIELD

Figure 5.1

The VOLTS/DIV setting for CHAN 1 and CHAN 2 is displayed, along with signal input coupling and various other data, in the Abridged Panel Status Field (IV), see Figure 4.1. It may be modified either manually or via remote control, and is immediately updated.

Whereas acquisition control settings displayed in the Abridged Panel Status Field (IV) are immediately updated upon manual or remote modifications of the VOLTS/DIV or TIME/DIV settings, the control settings in the Displayed Trace field (V), corresponding to the conditions under which the waveform was stored, are updated with every trigger.

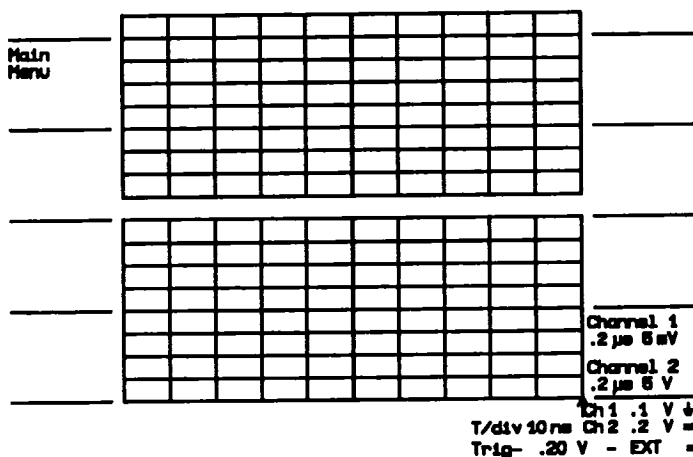

SENSITIVITY DATA DISPLAYED in the ABRIDGED PANEL
STATUS FIELD and in the DISPLAYED TRACE FIELD

Figure 5.2

VAR (28) - Verniers provide continuously variable sensitivity within the **VOLTS/DIV** settings and extend the maximum vertical sensitivity factor to up to 12.5 V/div. Variable sensitivity settings are indicated by the ">" symbol in the lower portion of the Abridged Front Panel Status field and the calibrated value appears in the Total V/div field of the Panel Status menu (See Section 5.2.2). (Minimum sensitivity is achieved by rotating the vernier counter-clockwise.)

VERTICAL OFFSET (32) - This control vertically positions the displayed trace. The maximum offset is ± 1 grid height (± 8 divisions) from the center of the screen, and is manually adjustable (or programmable) in 0.04 division increments. A pair of upward- or downward-pointing double-shaft arrows indicates when the trace has been positioned outside the grid, as shown in Figure 5.3.

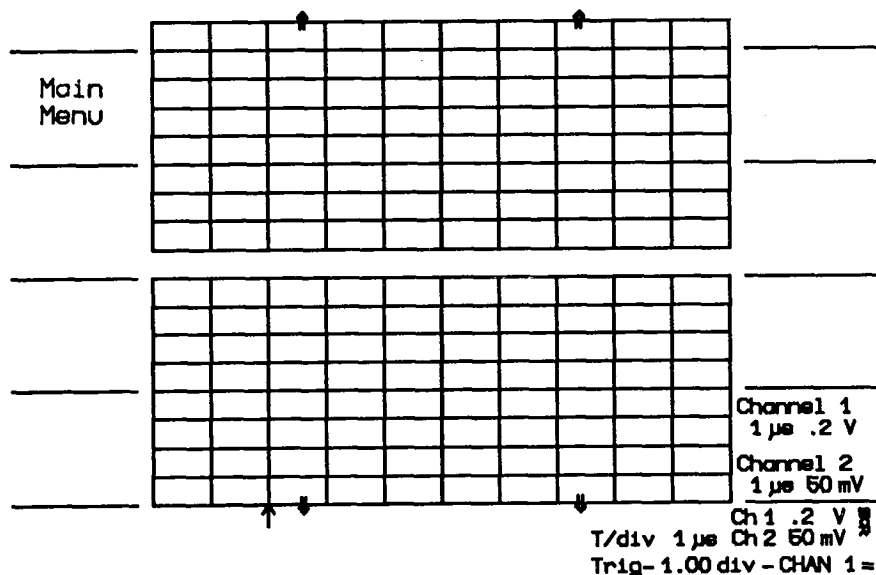

UPWARD and DOWNWARD POINTING, DOUBLE SHAFT ARROWS
INDICATING THAT CHANNEL 1 and 2 ARE OFF SCREEN

Figure 5.3

PROBES - Two Model P9010 passive probes are supplied with the 9400A. These probes have 10 M Ω input impedance and 6 pF capacitance. The system bandwidth with P9010 probes is DC to 100 MHz in 1 M Ω DC coupling, and < 10 Hz to 100 MHz in AC coupling. Active FET probes (Tektronix models P6201, P6202a and P6230) may be powered via probe power connectors on the rear panel.

PROBE CALIBRATION (19, 20) - To calibrate the P9010 Probe, connect it to the CHAN 1 or CHAN 2 BNC connector (21). Connect the probe's grounding alligator clip to the front panel ground lug (20) of the oscilloscope and the tip to lug (19).

Adjust the 9400A's front panel controls as described in Section 8.1. In case of over- or undershooting of the displayed signal, it is possible to adjust the P9010 Probe by inserting the small screwdriver, supplied with the probe package, into the trimmer on the probe's barrel and turning it clockwise or counter-clockwise to achieve an optimal square wave contour.

BANDWIDTH LIMIT (50) - By setting the **BANDWIDTH LIMIT** button to ON the bandwidth can be reduced from 175 MHz to 30 MHz (-3 dB). Bandwidth limiting may be useful in reducing signal and system noise or preventing high-frequency aliasing for single-shot events at time bases below 50 μ sec/division.

5.1.2 Time Base

TIME/DIVISION (36) - This control selects the time per division in a 1-2-5 sequence from 2 nsec to 100 sec. The time base is displayed in the Abridged Panel Status field (IV) as well as in the Displayed Trace field (V). The time base is crystal-controlled and features an overall accuracy better than 10^{-5} .

SAMPLING MODES

Three sampling modes are possible with the 9400A depending on the time-base setting selected by the user. They are:

- * Random Interleaved Sampling (RIS)
- * Single Shot (SS)
- * Roll Mode

Random Interleaved Sampling (RIS)

At time-base settings from 2 to 20 nsec/div, the 9400A automatically uses the RIS mode for signal acquisition. Repetitive waveforms and a stable trigger are required. Waveforms can be digitized with sampling intervals as small as 200 psec for an equivalent sampling rate of up to 5 gigasamples/sec.

Between the 50 nsec and 2 μ sec/div range of time base settings, the user may select the RIS acquisition mode by pressing the **INTERLEAVED SAMPLING** button (37).

Single Shot

For time base settings from 50 nsec to 200 msec/div the 9400A records the waveform in a single acquisition. Sampling rates up to 100 megasamples/sec are possible in the Single Shot mode.

Roll

From 500 msec to 100 sec/div, the 9400A samples continuously. Each digitized point updates the display, resulting in a trace moving from right to left similar to that produced by a strip-chart recorder.

TIME BASE (TIME/DIV)	SAMPLING RATE TIME/POINT		DISPLAYED RECORD LENGTH (Points)*	
	RIS	SS	RIS	SS
2.0 nsec	200 psec	---	100	---
5.0 nsec	200 psec	---	250	---
10.0 nsec	200 psec	---	500	---
20.0 nsec	200 psec	---	1000	---
50.0 nsec	200 psec	10.0 nsec	2500	50
0.1 μ sec	200 psec	10.0 nsec	5000	100
0.2 μ sec	200 psec	10.0 nsec	10000	200
0.5 μ sec	200 psec	10.0 nsec	24000	500
1.0 μ sec	400 psec	10.0 nsec	24800	1000
2.0 μ sec	800 psec	10.0 nsec	25000	2000
5.0 μ sec	---	10.0 nsec	---	5000
10.0 μ sec	---	10.0 nsec	---	10000
20.0 μ sec	---	10.0 nsec	---	20000
50.0 μ sec	---	20.0 nsec	---	25000
0.1 msec	---	40.0 nsec	---	25000
0.2 msec	---	80.0 nsec	---	25000
0.5 msec	---	0.2 μ sec	---	25000
1.0 msec	---	0.4 μ sec	---	25000
2.0 msec	---	0.8 μ sec	---	25000
5.0 msec	---	2.0 μ sec	---	25000
10.0 msec	---	4.0 μ sec	---	25000
20.0 msec	---	8.0 μ sec	---	25000
50.0 msec	---	20.0 μ sec	---	25000
0.1 sec	---	40.0 μ sec	---	25000
0.2 sec	---	80.0 μ sec	---	25000

TIME BASE (TIME/DIV)	SAMPLING RATE TIME/POINT		DISPLAYED RECORD LENGTH (Points)*	
	RIS	SS	RIS	SS
ROLL MODE				
0.5 sec	---	0.2 msec	---	25000
1.0 sec	---	0.4 msec	---	25000
2.0 sec	---	0.8 msec	---	25000
5.0 sec	---	2.0 msec	---	25000
10.0 sec	---	4.0 msec	---	25000
20.0 sec	---	8.0 msec	---	25000
50.0 sec	---	20.0 msec	---	25000
100.0 sec	---	40.0 msec	---	25000

* Note: When the 9400A is remotely read out, the entire memory content of 32,000 words is available at all time base speeds for single shot and roll modes. 24,000 samples are available for all RIS settings except at 1 and 2 μ sec/div, when 24,800 and 25,000 samples respectively are available.

LIST of SAMPLING MODES, SAMPLING RATE,
and DISPLAYED RECORD LENGTH

Table 5.1

5.1.3 Trigger

EXTERNAL Trigger Input (24) - This BNC connector input accepts an external trigger signal of up to 250 V (DC + peak AC). Input impedance is 1 M Ω in parallel with < 30 pF. The triggering frequency is >200 MHz.

Trigger SOURCE (23) - Selects the trigger signal source as follows:

CHAN 1 - Selects the Channel 1 input signal.

CHAN 2 - Selects the Channel 2 input signal.

LINE - Selects the line voltage powering the oscilloscope in order to provide a stable display of signals synchronous with the power line.

EXT - With the Trigger SOURCE set to EXT, a signal applied to the BNC connector labeled EXTERNAL can be used to trigger the scope within a range of ± 2 V.

EXT/10 - With the Trigger SOURCE set to EXT/10, a signal applied to the BNC connector labeled EXTERNAL, can be used to trigger the scope within a range of ± 20 V.

Trigger COUPLING (30) - Selects the type of signal coupling to the trigger circuit:

AC Trigger - Signals are capacitively coupled; DC levels are rejected and frequencies below 60 Hz are attenuated.

LF REJ - Signals are coupled via a capacitive high-pass filter network. DC is rejected and signal frequencies below 50 kHz are attenuated. The LF REJ trigger mode is used whenever triggering on high frequencies is desired.

HF REJ - Signals are DC-coupled to the trigger circuit and a low-pass filter network attenuates frequencies above 50 kHz. The HF REJ trigger mode is used when triggering on low frequencies is desired.

DC - All of the signal's frequency components are coupled to the trigger circuit. This coupling mode is used in the case of high frequency bursts, or where the use of AC coupling would shift the effective trigger level.

Trigger LEVEL (33) - Adjusts the level of the signal required to generate a trigger.

The trigger range is as follows:

± 5 screen divisions - with CHAN 1 or CHAN 2 as trigger source

None (zero-crossing) with LINE as trigger source

± 2 V with EXT as trigger source

± 20 V with EXT/10 as trigger source

SLOPE (25) - Selects the signal edge used to activate the trigger circuit.

POS - Requires a positive-going edge of the trigger signal.

NEG - Requires a negative-going edge.

(POS/NEG) - Permits "window" triggering, i.e. triggering on either a positive- or negative-going signal edge, whichever occurs first.

When the POS/NEG trigger slope is selected, the Trigger LEVEL control (33) is turned counter-clockwise for bi-slope triggering at base line level. Turning the Trigger LEVEL control (33) clockwise generates a variable amplitude trigger window which is symmetrical with respect to the center of the screen (internal trigger source) and to ground (external trigger source). When using an internal trigger source, the user may produce an asymmetrical window by offsetting the base line with respect to ground via Vertical OFFSET control (32).

In the window triggering mode no trigger will occur while the signal remains within the window. A signal which exceeds the pre-selected limits will generate a trigger and the signal is stored into the memory, as shown in the following figure.

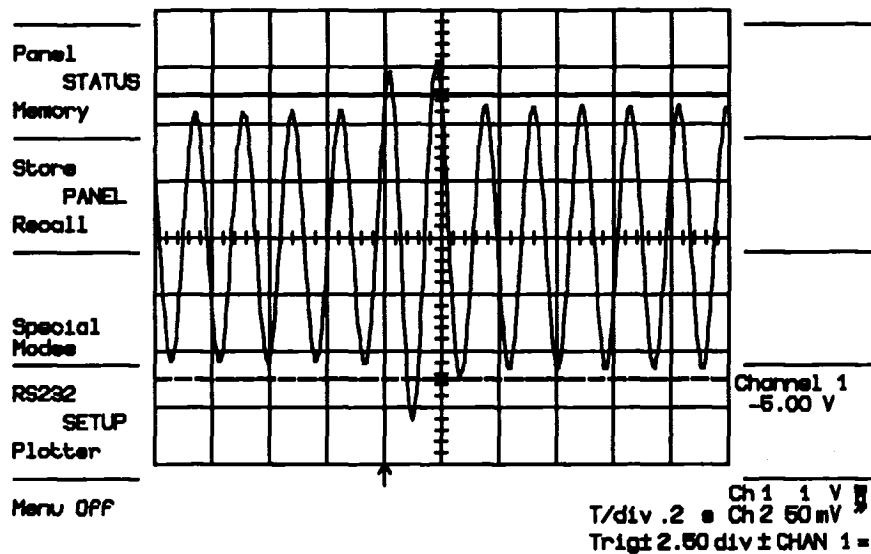

WINDOW TRIGGERING

Figure 5.4

In the above figure the trigger level is ± 3 divisions as indicated in the Abridged Panel Status field.

Trigger MODE (29) - Selects the mode of trigger operation as follows:

SINGLE (HOLD) - Selected using the lower button (29).

In this mode the 9400A digitizes until a valid trigger is received. After the waveform has been acquired and displayed, no further signals can be acquired until the **SINGLE (HOLD)** button has been pressed again to re-arm the trigger circuit in preparation for the next trigger signal. This type of acquisition provides a simple means of recording a wide variety of transient events.

When the 9400A is in the Random Interleaved Sampling (RIS) mode, a sufficient number of triggers must be obtained to complete waveform reconstruction, after which the waveform will be displayed. No further signals can be acquired until the **SINGLE (HOLD)** button has been pressed again.

When the 9400A is in the Roll mode (≥ 500 msec/div), pressing the **SINGLE (HOLD)** button causes data acquisition to immediately halt and the display to freeze.

NORM - Selected using button (29).

When in the normal (**NORM**) trigger mode, the 9400A continuously digitizes the input signal. Whenever a valid trigger is received, the acquired waveform is displayed on the CRT, digitization starts again and the trigger circuit is re-armed. If no subsequent trigger is received within 2 seconds, previously acquired waveforms are erased from the screen. The absence of a valid trigger will thus result in a blank screen.

To retain the last acquired waveform indefinitely in the **NORM** mode, the 9400A's Auto-store feature is used. Auto-store can be called via the Special Modes menu described in Section 5.2.5.

When the 9400A is in the RIS mode, a sufficient number (typically 200) of valid triggers is required for each display of a complete waveform.

In the Roll mode (≥ 500 msec/div), the 9400A samples the input signals continuously. Each point is immediately updated on the display. This results in a trace which moves from right to left across the CRT. In the **NORM** mode, triggers are ignored. The only way to halt data acquisition is to select the **SINGLE (HOLD)** mode or switch the 9400A into **AUTO** mode and provide a trigger.

AUTO - Selected using button (29).

This mode resembles the **NORM** mode, except that it automatically generates an internal trigger and forces a waveform to appear on the screen whenever the selected trigger is not present for more than 500 msec. When the 9400A auto-triggers, the display usually moves in time as the trigger is not time-correlated with the input signal.

Auto trigger can not be used when the 9400A is in the **RIS** mode.

When the 9400A is in the **Roll** mode (≥ 500 msec/div), it samples input signals continuously. In the **AUTO** mode any valid trigger will halt data acquisition once the trigger delay requirements have been satisfied.

SEQNCE - Selected using the upper button (29).

Sequence triggering enables the 9400A's acquisition memories to be partitioned into up to 250 segments.

Possible settings are: 8, 15, 31, 62, 125, or 250 segments.

Waveform acquisition in **SEQNCE** mode is particularly useful in the case of short-lived or echoed signals, such as those typically encountered in **RADAR**, **SONAR**, **LIDAR** and **NMR**.

In this mode, the time base setting determines the total duration ($\text{TIME/DIV} \times 10$) of each segment. Changing the number of required segments does not change the time base; it only affects the number of digitized points (record length) per segment. The number of data points per division is shown in the Acquisition Parameters display, called by pressing **Panel STATUS** button (2).

The display is only updated after a sufficient number of sweeps has been acquired. If less than the required number of triggers is available the **SEQNCE** acquisition may be aborted by pushing the **SEQNCE** button (29) again.

The 9400A then completes the missing sweeps by auto-triggering a sufficient number of times while setting its input coupling temporarily to **GND**. Thus the artificially completed sweeps will appear on the display as **GND** lines.

Number of Segments	Points/Segment
8	2501
15	2001
31	1001
62	497
125	241
250	101

SEQUENCE TRIGGER MODE
NUMBER OF SEGMENTS VS. RECORD LENGTH (TIME BASE: 20 μ sec)

Table 5.2

Neither the CHAN 1 nor CHAN 2 display is updated when the 9400A is in the SINGLE or SEQNCE trigger mode, i.e. when no further data are acquired. Vertical positioning of the displayed trace may nevertheless be modified via the **OFFSET** control (32). The **VAR** vernier (28) also remains active. However, no other parameter modifications, such as vertical sensitivity or time changes, will alter the display of a currently acquired waveform in CHAN 1 or CHAN 2.

Of course, all parameters may be modified during this time by manipulating the appropriate front panel controls, but such modification - indicated by parameter changes in the Abridged Front Panel Status field (IV) - will only be used when acquiring the next trace.

Whenever the 9400A is in the NORM or AUTO trigger mode, data are continuously acquired and the display rapidly updated. All modifications in acquisition parameters are thus followed quickly by subsequent waveform acquisition which results in their appearing to the user as changes to the CHAN 1 or CHAN 2 display.

TRIG'D and **READY** LEDs (31) - The **TRIG'D** LED indicates whenever the digitizing has stopped (normally after a valid trigger). The **READY** LED indicates that the trigger circuit has been armed and the 9400A is currently digitizing input signals. Upon receiving a valid trigger signal, it will continue digitization until the trigger conditions have been satisfied and will then display the acquired waveform.

DELAY (34) - Adjusts the degree of pre- or post-trigger delay when recording signals in the acquisition memories. Delay operation is via a single continuously rotating knob. Turning this knob slowly allows minute adjustment of the trigger point; turning it quickly results in rapid trigger point movement. The **DELAY** control enables pre-trigger adjustment, displayed in %. Pre-trigger adjustment up to 100% full scale, and post-trigger adjustment up to 10,000 divisions in 0.02 division increments are available.

The pre-trigger indicator is displayed by an upward pointing arrow on the bottom graticule line; the post-trigger indicator is displayed in decimal fractions of a second, preceded by a leftward-pointing arrow, in the left-hand corner of the Trigger Delay field (III).

ZERO (35) - Resets the trigger delay from previously set positions to the leftmost graticule line (i.e. 0.0% Pre-trigger position).

5.1.4 Displaying Traces

Up to four different waveforms (out of a total of eight) may be simultaneously displayed. Whenever a trace is displayed by pressing one of the **TRACE ON/OFF** buttons ((46)-(49)), the corresponding waveform will appear on the screen together with a short description in the Displayed Trace field (V). When several signals are being displayed simultaneously, buttons (46)-(49) can be used as convenient trace identifiers by repeatedly pressing one of these buttons and simply seeing which of the displayed traces is turned ON and OFF by this operation.

EXPAND A, B buttons (46) - Turn the displayed expansion of a waveform ON or OFF. The expanded portion of the waveform is displayed on the source trace as an intensified region. The default settings are; **EXPAND A** operates on **CHANNEL 1** and **EXPAND B** operates on **CHANNEL 2**. They may be changed to allow expansion on any other source trace, by using the **REDEFINE** button (48).

MEMORY C, D buttons (47) - Turn the display of a waveform in reference Memories C or D ON or OFF. Acquired data may be stored into these memories via the **STORE** button (1), as described in Section 5.2.1.

FUNCTION E, F buttons (48) - If your 9400A is equipped with a waveform processing firmware option, pressing these buttons will turn the display of a computed waveform ON or OFF. The type of computation may be defined by pressing the **REDEFINE** button (45). See WP01 Waveform Processing Option, Section 10.

CHANNEL 1, 2 buttons (49) - Turn the display of signals applied to either of the input connectors (21) ON or OFF. Recording of data into CHAN 1 and CHAN 2 acquisition memories always occurs simultaneously and irrespective of whether the trace display is ON or OFF.

5.1.5 Display Control

Displayed traces may be modified within certain limits following waveform acquisition.

The **CHAN 1** and **CHAN 2** traces are controlled by the **VERTICAL** and **Time Base** controls ((27), (28), (32) and (36), (37), respectively).

Six traces, **EXPAND A, B** (46), **MEMORY C, D** (47), and **FUNCTION E, F** (48) are controlled by the **Display Control** knobs and buttons (39)-(45). Only one trace is controllable at a time. The identity of the controlled trace is indicated by a rectangular frame around the waveform descriptor in the **Displayed Trace** field (V).

Whenever more than one of the six traces listed above are currently displayed, the frame may be moved to the next trace by pressing the **SELECT** button (44).

Horizontal POSITION knob (39) - Horizontally positions an expanded waveform and the intensified region along the source trace. This control is activated only after the **EXPAND A** and/or **B** buttons (46) have been pressed to display the expanded trace. The **Horizontal POSITION** knob allows the user to scroll continuously through a displayed waveform. However, if the source trace was recorded in sequence mode (i.e. a number of sequentially acquired traces was stored in partitioned memory blocks), the movement of the **Horizontal POSITION** knob will be discrete allowing any single segment to be selected.

The **Horizontal POSITION** control affects only **EXPAND A, B**.

Vertical POSITION knob (40) - Vertically repositions the trace.

RESET button (41) - Serves to reset previously adjusted **VERT GAIN**, **Vertical** and/or **Horizontal POSITION** to the following default values:

VERT GAIN	- Same as the original trace
Vertical POSITION	- Same as the original trace
Horizontal POSITION	- Center of the original trace

In the Common Expand mode (See Section 5.2.5.2), this button is used to synchronize the two intensified regions of **EXPAND A** and **B**.

VERT GAIN knob (42) - Turning the knob clockwise allows vertical expansion by a factor of up to 2.5. Counterclockwise rotation allows vertical contraction by a factor of up to 2.5. If the vernier knob is not in the detent position it is possible to achieve vertical expansion by a factor of up to 5.

Pressing **RESET** (41) returns gain control to a mid-range plateau corresponding to a gain of 1. If the 9400A is equipped with WP01, the vertical gain is increased from 2.5 to 10 for averages, mathematics and functions.

TIME MAGNIFIER knob (43) - This control horizontally expands waveforms up to 100 times.

Overall timing accuracy is improved at higher magnification factors, since the expand function is controlled digitally and makes use of the scope's high number of recorded data points. This control has no effect on **MEMORY C, D** or **FUNCTION E, F**.

SELECT button (44) - Chooses one of the traces - **EXPAND A** through **FUNCTION F** - to be controlled via **Display Control** knobs and buttons ((39)-(45)). The selected trace is indicated by a rectangular frame around the waveform descriptor in the **Displayed Trace field (V)**. Pressing the **SELECT** button (44) moves the rectangle to the next displayed trace in a rolling sequence.

REDEFINE button (45) - Used to redefine the identity of the selected waveform. **EXPAND A, B** traces may be redefined to be the expansion of **CHAN 1** or **CHAN 2**, **MEMORY C** or **D** or **FUNCTION E** or **F** (for 9400A's equipped with the **Waveform Processing Option**).

Pressing the **REDEFINE** button (45) calls a menu on the left-hand side of the screen enabling selection of the desired source redefinition. When the button corresponding to this redefinition is pressed, **EXPAND A** or **B** will be temporarily selected as the new source trace until subsequent redefinition is performed. The default signal sources are **CHAN 1** for **EXPAND A** and **CHAN 2** for **EXPAND B**.

It is not possible to redefine Memories C and D; Function E and F may only be redefined if your 9400A is equipped with the **Waveform Processing Option**. For scopes with this option installed, see Section 10 which deals with the **Waveform Processing Option**.

5.1.6 Screen Adjustments

INTENSITY knob (12) - Adjusts the intensity of the displayed trace and all alphanumeric readouts and messages. The **INTENSITY** control may be adjusted in either manual or remote control mode.

GRID INTENSITY knob (13) - Controls grid and graticule intensity independently of displayed trace intensity.

DUAL GRID button (14) - This button switches between single and dual grid modes. The dual grid is useful when displaying multiple traces, in which case the **CHAN 1** display is permanently assigned to the upper grid and **CHAN 2** to the lower grid. All other displayed traces may be repositioned anywhere on the screen via the **Vertical POSITION** control (40).

SCREEN DUMP button (11) - Dumps the contents of the screen to an on-line digital plotter via the 9400A's rear panel RS-232-C interface port or optional GPIB port to provide color or monochrome hard copy archiving of the display. All of the screen illustrations included in this manual were produced using the **SCREEN DUMP** function.

5.1.7 **Cursors**

Cursor measurements can be made simultaneously on up to 4 traces on the 9400A's CRT.

MARKER Cursor button (18) - Pressing this button generates a + cross-hair marker for precise time measurements relative to the point of triggering, as well as absolute voltage measurements along the displayed waveform irrespective of the vertical offset of the trace displayed on the grid.

Note that setting the marker cursor to 0 time interval provides a visual indication of the trigger point.

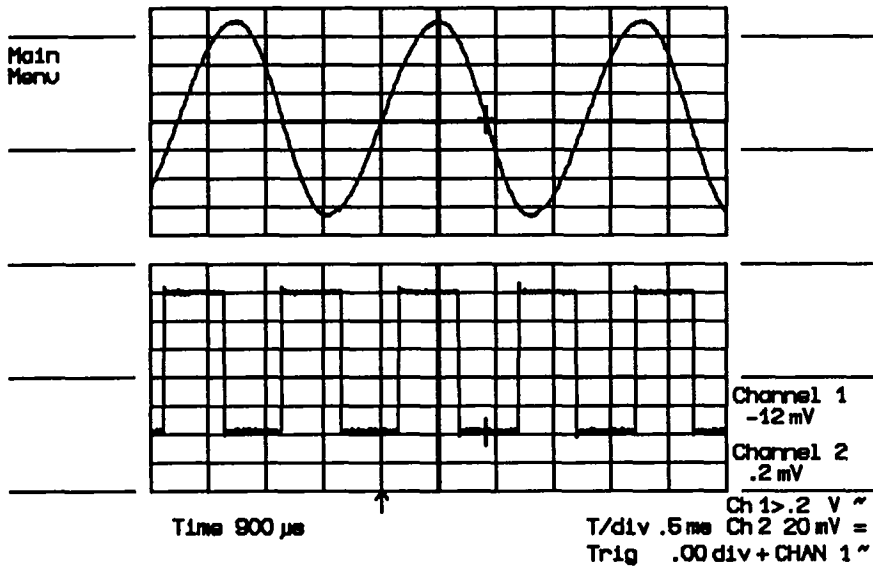

DISPLAYED TRACES SHOWING MARKER CURSOR,
INTERVAL BETWEEN TRIGGER POINT and CURSOR,
well as ALPHANUMERIC READOUT of the AMPLITUDE of the TRACES

Figure 5.5

TIME Cursors button (17) - Generate a downward-pointing and an upward-pointing arrow on the currently displayed traces, permitting accurate differential time, voltage and frequency measurements. Time cursors are displayed as follows:

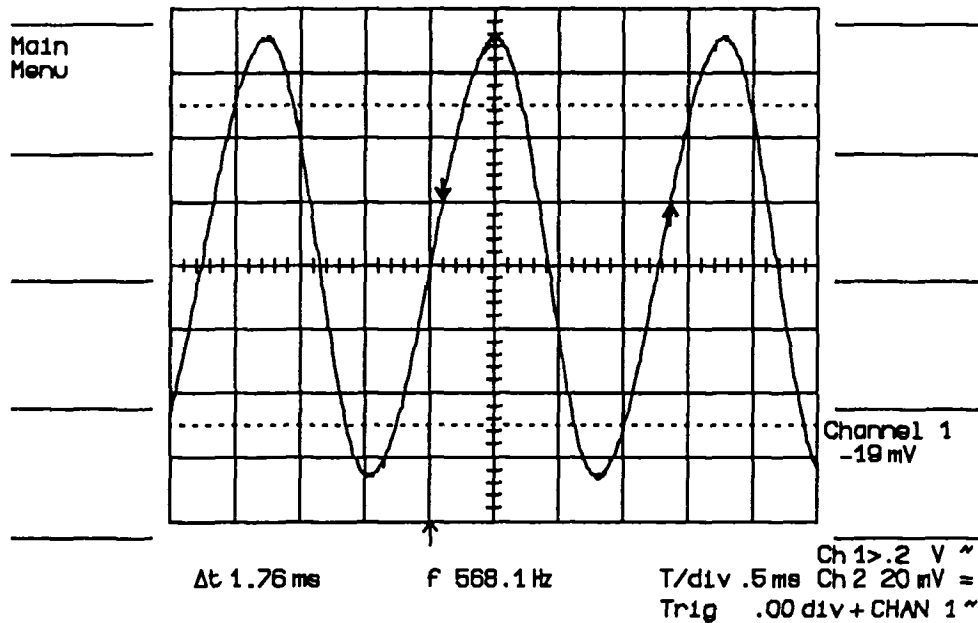

DISPLAYED TRACE SHOWING TIME CURSORS,
their VOLTAGE DIFFERENCE their TIME DIFFERENCES
and the CORRESPONDING FREQUENCY.

Figure 5.6

Note: Measurement resolution with Time cursors is 0.2% of full scale (10 divisions).

In the case of expanded traces, time cursors are displayed on the trace, providing up to $\times 100$ higher resolution measurement (0.002% maximum, depending on the setting of **TIME MAGNIFIER** control(43)).

Use of the waveform expansion facility is therefore recommended to ensure the most accurate time measurements.

VOLTAGE Cursors button (16) - Generates two linear cursor bars which provide accurate differential voltage measurements when adjusted vertically on the currently displayed waveform. The **REFERENCE** and **DIFFERENCE** controls (38) serve to position the Reference and the Difference cursor bars.

Voltage cursor bars are displayed as follows:

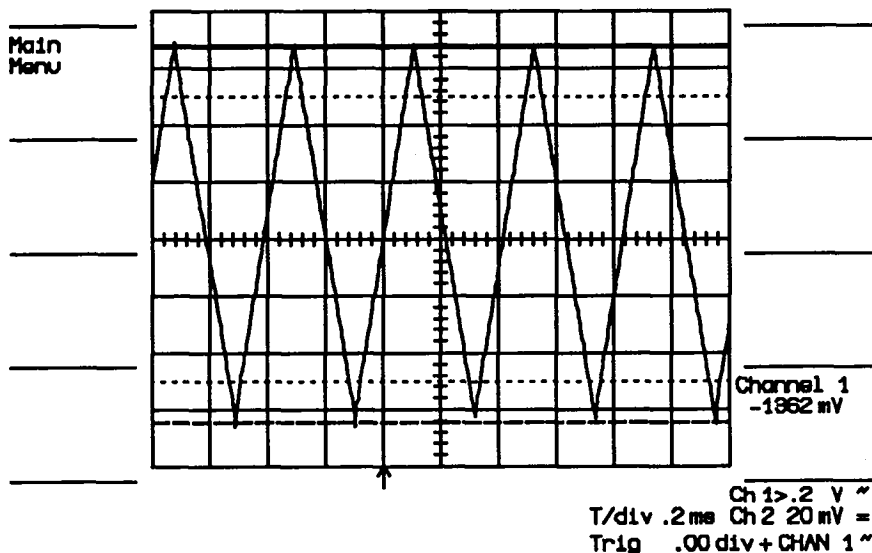

DISPLAYED TRACE SHOWING REFERENCE and DIFFERENCE VOLTAGE CURSORS, and ALPHANUMERIC READOUT of TRACE AMPLITUDE

Figure 5.7

Note that measurement resolution with the **VOLTAGE** cursors is 0.2% of full scale (8 divisions).

CURSOR POSITIONING knobs (38) - In the case of Time and Voltage cursors, the **REFERENCE** control adjusts the Time and Voltage Reference cursor to the point used as measurement reference. The **DIFFERENCE** control is then adjusted to move the Difference cursor to the desired position along the trace.

The + Marker cursor is moved along the displayed waveform by means of the **REFERENCE** cursor positioning knob alone.

Pressing the **TRACKING** button causes the Difference cursor to track the Reference cursor at a fixed interval as determined by the **DIFFERENCE** control (in the case of Voltage and Time cursors).

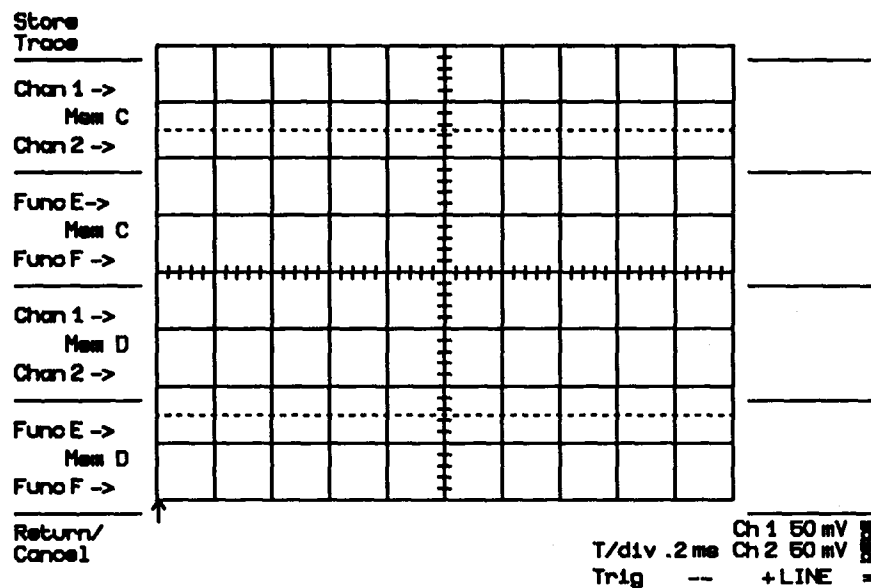

STORE TRACE MENU

Figure 5.9

Pressing buttons (2), (3), (6) or (7) causes an identical copy of the displayed waveform (or waveforms) to be stored into reference Memories C and/or D.

If acquisition is taking place when the store button (1) is pressed, the user is prompted with the message:

STOP ACQUISITION IN ORDER TO STORE

5.2.2 Panel Status Menu

The Panel Status menu provides a complete report of front panel control settings and permits on-screen adjustment of acquisition parameters.

ACQUISITION PARAMETERS			
	Chan 1	Chan 2	
VERTICAL			
Fixed V/div	50 mV	50 mV	
Total V/div	50.0 mV	50.0 mV	
Offset	.0 mV	.0 mV	
Coupling	AC 1 MΩ	AC 1 MΩ	
TRIGGER			
Delay	10.0X Pre	Time/div	.5 ms
Level	.00 div	Time/prt	200 ns
Coupling	DC	Points/div	2500
Source	CHAN 1	Interleaved	OFF
Slope	+	Sampling	OFF
Mode	NORMAL	BW-Limit	OFF
		# Segments	15
		For SEGNC	

Trigger Level has absolute meaning with DC-Coupling only

PANEL STATUS MENU

Figure 5.10

Vertical parameters:

Fixed V/div

The current setting of the front panel Vertical Sensitivity control (27) with the VAR vernier in the fully clockwise position is indicated.

Total V/div

The current setting of the front panel Vertical Sensitivity control (27) plus the additional sensitivity range (up to $\times 2.5$ of the Fixed V/div setting) is provided by turning the VAR vernier (28) counterclockwise.

Trigger parameters:

Delay

In Figure 5.10 the indicated trigger delay is 10% Pre, meaning that when in Main Menu the Delay arrow is positioned one division to the left of the center of the grid. In the case of a post-trigger delay setting, this would be indicated in decimal fractions of a second (i.e. ← 4.00 msec).

Level

The trigger level indicated in Figure 5.10 is displayed in terms of grid divisions. The 9400A displays the current trigger level setting in divisions when in the internal trigger mode. It displays the setting in Volts when in the external trigger mode.

Time/point

Indicates the time between digitized points for the corresponding time base setting.

Points/div

This parameter indicates the number of digitized points per division on any non-expanded waveforms displayed.

Segments for SEQNCE

This parameter indicates the number of segments selected for sequential acquisition. On-screen modification of this parameter is possible by pressing the **Modify # Segments** button (4) to change the indicated segment number from 8 to 250 in a rolling sequence.

Set CHAN 1 Attenuator (6) and set CHAN 2 Attenuator (7)

allow the user to enter probe attenuation factors of 10, 100 and 1000.

Press the **Return** key (10) to list the available menus.

For information concerning the other parameters displayed on the Panel Status menu, see Section 5.1.

5.2.3 Memory Status

The Panel Status menu displays acquisition parameters for waveforms to be acquired after receiving a trigger signal. On the other hand, the Memory Status menu displays all acquisition parameters for waveforms currently stored in the various memories of the 9400A.

The annotation used for Memory Status is similar to that of the Panel Status menu. Pressing the Memory Status button (3) displays the Memory Status menu in Figure 5.11.

Memory Status	MEMORY STATUS		V 2.08FT
		Expand A	Expand B
Ch 1+2 STATUS	Total V/div	50.0 mV	50.0 mV
Exp A+B	Offset	.0 mV	.0 mV
Mem C+D STATUS	Coupling+BW-Limit	AC 1 MO, OFF	AC 1 MO, OFF
Fun E+F	Time(Freq)/div	.5 ms	.5 ms
	T(F)/pnt + Pts/div	200 ns, 2500	200 ns, 2500
	Trig-Delay	9.8X Pre	9.8X Pre
	Tr-Level + Slope	.00 div, +	.00 div, +
	Tr-Source + Coupl	CHAN 1, DC	CHAN 1, DC
	Memory Limite	-7000,25000	-7000,25000
	Record-Type	SINGLE	SINGLE
Return			
PLOTTING			

MEMORY STATUS CHAN 1 and CHAN 2
Figure 5.11

Pressing button (2), (3) or (4) while in the memory status menu will display the acquisition parameters of waveforms stored in acquisition, expansion and storage memories respectively.

Memory Status	MEMORY STATUS		V 2.08FT
Ch 1+2 STATUS Exp A+B		Memory C	Memory D
	Total V/div	500 mV	50.0 mV
	Offset	4000 mV	.0 mV
	Coupling+BW-Limit	DC 50 Ω, OFF	DC 50 Ω, OFF
	Time(Freq)/div	.2 ms	.5 ms
Mem C+D STATUS	T(F)/pnt + Pts/div	80 ns, 2500	200 ns, 2500
Fun E+F	Trig-Delay	.4X Pre	.0X Pre
	Tr-Level + Slope	-- , --	-20.0 V , --
	Tr-Source + Coupl	LINE , DC	EXT/10, DC
	Memory Limite	0,25000	-7000,25000
	Record-Type	SINGLE	SINGLE
	Processing	Avg(1)s	-
	# Points + Intval	1252, 20	
	# Sweeps	1	
Return			
PLOTTING			

TRACE A, B EXPAND STATUS MENU

Figure 5.12

Memory Status	MEMORY STATUS		V 2.08FT
Ch 1+2 STATUS Exp A+B		Memory C	Memory D
	Total V/div	500 mV	50.0 mV
	Offset	4000 mV	.0 mV
	Coupling+BW-Limit	DC 50 Ω, OFF	DC 50 Ω, OFF
	Time(Freq)/div	.2 ms	.5 ms
Mem C+D STATUS	T(F)/pnt + Pts/div	80 ns, 2500	200 ns, 2500
Fun E+F	Trig-Delay	.4X Pre	.0X Pre
	Tr-Level + Slope	-- , --	-20.0 V , --
	Tr-Source + Coupl	LINE , DC	EXT/10, DC
	Memory Limite	0,25000	-7000,25000
	Record-Type	SINGLE	SINGLE
	Processing	Avg(1)s	-
	# Points + Intval	1252, 20	
	# Sweeps	1	
Return			
PLOTTING			

MEMORY STATUS C and D

Figure 5.13

The indication in the upper right-hand corner of Figures 5.12, 5.13, 5.14 corresponds to the software version implemented in the scope.

5.2.4 Storage and Recall of Front Panel Setups

Pressing the **Store PANEL** or **Recall PANEL** buttons ((4) and (5), respectively) enables storage or recall of up to seven different front panel acquisition parameter settings.

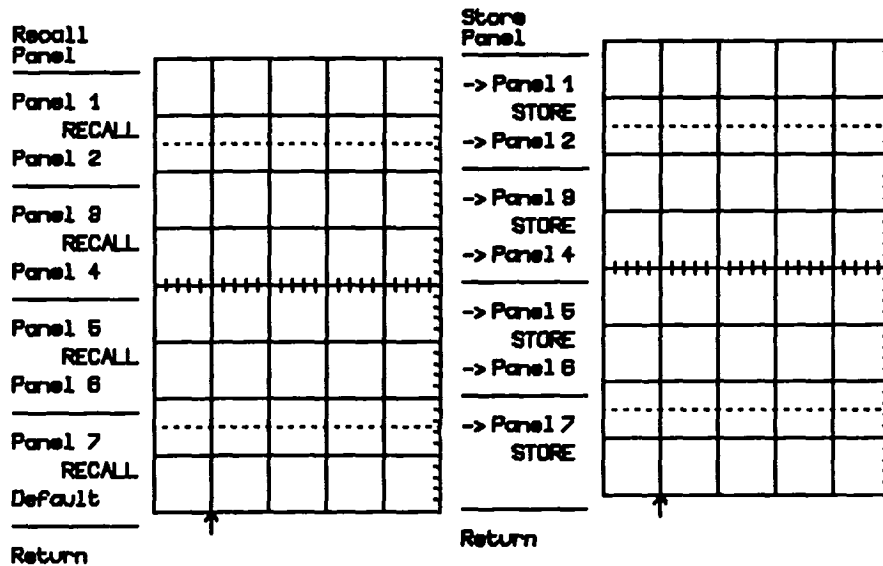

STORE and RECALL FRONT PANEL SETUP MENUS

Figure 5.14

Once you have obtained a satisfactory front panel setup, simply call the **Store PANEL** menu by pressing button (4); then press any one of the buttons (2) through (8) to store this front panel setup where required. Press the **Return** button (10) to go back to the Main Menu and continue normal scope operation.

To recall a previously stored front panel setup, press the Recall PANEL button (5) while in the Main Menu. A list of the seven stored front panel setups which are available will be displayed. Press the button ((2) through (8)) which corresponds to the desired setup, and the front panel settings will automatically be configured according to the acquisition parameters recalled.

5.2.5 Special Modes (7)

<u>SPECIAL MODES</u>	
Modify Auto-Store	AUTO-STORE OFF In NORM and AUTO, the oscilloscope may be forced to automatically store one or both channels in either memory C or D after the acquisition of each waveform. This mode slows down the display repetition rate, since a storage operation takes as much as 200 ms.
Mod. Common Expand	COMMON EXPAND OFF When ON, the horizontal position and time magnifier control knobs act on both expanded traces A AND B for a simultaneous horizontal scan. The vertical gain and position remain individually controlled.
Return	
PLOTTING	

SPECIAL MODES MENU

Figure 5.15

5.2.5.1 Auto-store Mode

Pressing the Special Modes button (7) while in the Main Menu allows the user to automatically store - following acquisition - CHAN 1 or CHAN 2 into the unit's two reference memories.

Pressing the Modify Auto-store button (2) allows the user to choose from among the following possible storage modes: CHAN 1 into Memory C or D; CHAN 2 into Memory C or D, or, alternatively, CHAN 1 into Memory C and CHAN 2 into Memory D.

This is a useful feature for very low repetition rate signals acquired in the **NORMAL** trigger mode. Subsequent display of the selected reference memory provides the user with a lasting waveform display which can be studied long after the originally acquired signal has been erased. In the **NORMAL** trigger mode the **CHAN 1** and **CHAN 2** displays are automatically erased after a two second interval to warn the user that a proper trigger is not available.

5.2.5.2 Common Expand Mode

Section 5.1.4 discusses independent expansion of single traces to display a magnified portion of the waveform from **CHAN 1** and/or **CHAN 2**, Memories **C** and/or **D**, or of Function **E** and/or **F** if the 9400A is equipped with **WP01** Waveform Processing firmware. However, in certain applications, it is convenient to be able to move the intensified region along two different traces simultaneously. This is the purpose of the Common Expand mode.

In this mode it is possible to either synchronize the intensified regions of the two source signals, or to maintain a fixed time interval between them, in which case the intensified regions for each trace will move horizontally at a fixed interval. (See Section 8.11 for an example of intensified regions shifting on two traces expanded in the Common Expand mode).

In the Common Expand mode, when the user is examining two expansions at a fixed interval (he may re-synchronize them by pressing the **RESET** button (41)) both expansions are shifted to the center of the grid. Turning the **Horizontal POSITION** control (39) until both of the intensified regions move off the screen will also re-synchronize them.

In the Common Expand mode, only the **Horizontal POSITION** control (39) and **TIME MAGNIFIER** control (43) act simultaneously on the intensified regions on both the **EXPAND A** and **B** signal source, while the **VERT GAIN** control (42) and **Vertical POSITION** control (40) act independently on each expanded waveform.

Note that when the Common Expand mode is called, the **EXPAND A** magnification factor applies to both **A** and **B** expansion.

5.2.6 RS-232-C Setup (8)

Two **RS-232-C** ports are available on the rear panel of the 9400A permitting remote oscilloscope operation and data transfer, as well as convenient plotter interfacing.

When in the main menu, pressing **RS-232-C SETUP** button (8) calls an interactive menu enabling configuration of both of the 9400A's RS-232-C ports for a particular application. Parameters for the plotter-dedicated RS-232-C port (57) are displayed in the lower portion of the screen, while those for the remote RS-232-C port (56) are presented in the upper portion of the screen.

<hr/> Previous FIELD Next <hr/>	<u>RS232 - Remote control port</u> Baud rate: 9600 Character length (bits): 8 Parity: none Number of stop bits: 1
<hr/> Previous VALUE Next <hr/>	<u>RS232 - Plotter port</u> Baud rate: 9600 Character length (bits): 8 Parity: none Number of stop bits: 1
<hr/> Return PLOTTING	

RS-232-C SETUP MENU

Figure 5.16

To modify any of the parameters displayed, first select the field to be modified. The rectangular frame around parameter values indicates the currently selected field. Pressing the **Previous FIELD** button (2) will cause the frame to move towards the top of the list, whereas pressing the **Next FIELD** button (3) will move the frame downwards.

Following field selection, the current value of the field may be modified by pressing either the **Previous** (6) or **Next VALUE** (7). The Baud rate is selected from a set of values in the range 110 through 19,200 baud. The possible settings of character length are 6, 7, and 8; parity, none, even or odd; and number of stop bits, 1 and 2.

5.2.7 Plotter Setup (9)

The 9400A has been designed to permit direct interfacing of the oscilloscope with four of the most popular plotters via the rear panel RS-232-C dedicated plotter port or the optional GPIB (IEEE-488) port.

When the 9400A is connected to a plotter via the GPIB port, with no host computer in the configuration, the oscilloscope's rear panel thumb-wheel switch must be set to the Talk Only mode (address ≥ 31 decimal) and the plotter to the Listen Only mode.

Plotter setup configuration is similar to configuration of the RS-232-C ports (see Section 5.2.6 above).

	<u>PLOTTER</u>
Previous	Plotter: <u>HEWLETT PACKARD 7470A or compatible</u>
FIELD	
Next	Plotter port: RS232
	Plot speed: NORMAL
	Number of installed pens: 2
Previous	<u>PLOT SIZE</u>
VALUE	Paper size: A4 (ISO) - US 11"/8.5"
Next	The plot area will be less than: 229 mm * 160 mm
Return	
PLOTTING	

PLOTTER SET-UP MENU

Figure 5.17

The user can choose the following parameters:

Plotter Type: HP7470A (or compatible), Philips PM8151
(or compatible), Tektronix or Graphtec FP 5301

Plotter Port: RS-232-C or GPIB (IEEE-488)*

Plot Speed: Normal or Low Speed

Number of
Installed Pens: 1 to 9

Plot Size: ISO A5 (US 8.5" × 5.5"), ISO A4 (US 11" ×
8.5"), ISO A3 (US 17" × 11") or non-standard

Non-standard: In the case of non-standard paper sizes, the size of
the grid square can be chosen between 0 to 99.9 mm in
0.1 mm steps; lower left corner position from 0 to
999 mm (for both X and Y coordinates) in 1 mm steps.

* If GPIB is selected by no GPIB board is installed (basic 9400A), the
instrument may lock up when the screen dump button is pressed.



SECTION 6

REAR PANEL CONTROLS AND CONNECTORS

6.1 Fuse Protection

The power supply of the 9400A is protected against short circuits and overload by means of a T(slow) 1.6/ 250 V fuse for units which can operate on 220 V or 115 V mains voltage (switch selected) or a T (slow) 3.15/ 250 V fuse for units operating only on 115 V mains voltage. The fuse is located under the 115 to 220 V mains voltage selector drum cover.

6.2 Accessory Power Connectors (51)

Two LEMO RA 0304 NYL connectors have been provided to permit use of FET type probes with the 9400A. These connectors provide output voltages of + 5 V, \pm 15 V and GND connection, suitable for most FET probes.

The maximum output current per connector must be limited to 150 mA for each of the three voltages.

6.3 Battery Pack (52)

The battery pack consists of two KR 15/51, 1.2 V rechargeable NiCd batteries enabling retention of front-panel setups for 6 months in case of power failure or whenever the 9400A is switched off. The battery pack is automatically recharged during operation.

The battery pack can be accessed by pressing the plastic latch at the top of the cover and pulling it downward and toward the user.

6.4 GPIB and RS-232-C Port Selection (54)

The 9400A's rear panel thumbwheel switch is used to set addresses for programmed or remote oscilloscope operation. Any one of addresses 31-99 selects the RS-232-C port. Addresses 0-30 define the 9400A's address when using the optional GPIB (IEEE-488) port.

GPIB and RS-232-C pin assignments are clearly indicated on the rear panel next to each connector.

6.5 Plotter Connector (57)

In addition to the RS-232-C port (56) used for remote 9400A operation, a second RS-232-C port (57) has been incorporated to facilitate direct interfacing of the 9400A with a digital plotter. Plotters are used for hard copy archiving of displayed waveforms and other screen data. Pin assignments for the plotter connector are identical to those of the remote RS-232-C port (56).

While a plotter unit connected to the 9400A's RS-232-C port can be computer controlled from a host computer via the optional GPIB port, the oscilloscope's on-board digital plotter drivers permit hard copies to be made without an external computer.

Plotter connector pin assignments:

Pin #		Description
2	T x D	Transmitted Data (from the 9400A)
3	R x D	Received Data (to the 9400A)
4	RTS	Request To Send (always on) (from the 9400A)
5	CTS	Clear To Send (to the 9400A) When TRUE, the 9400A can transmit. When FALSE, transmission stops. Used for 9400A output hardware handshake.
20	DTR	Data Terminal Ready (from the 9400A) Always TRUE.
6	DSR	Data Set Ready (to the 9400A)
1	GND	Protective Ground
7	SIG GND	Signal Ground

This corresponds to a DTE (Data Terminal Equipment) configuration.

SECTION 7

REMOTE OPERATIONS

7.1 Programmed Control

Most of the front panel and internal functions of the 9400A can be remotely controlled using a set of high-level, English-like commands and mnemonics. For example, a command followed by <?> tells the scope to transfer to the host computer the value of the control setting defined by the command. It is thus possible to read the complete status of the instrument by repeated queries. It is also possible to save the entire status of the instrument in binary format with a single command. The 9400A's remote control facility allows complex measurement procedures and instrument setups, a particularly useful feature in experimental and automated testing environments.

The 9400A can be programmed via the rear panel RS-232-C port interfaced with a computer terminal or a computer. Remote control is also possible via GPIB (IEEE-488 bus) if the 9400A has been fitted with the option OP02. In this case data transfer rates are relatively faster.

To help users who wish to remotely control the Models 9400 (125 MHz bandwidth) and 9400A (175 MHz bandwidth) oscilloscopes, LeCroy have published the following application notes which are available on request:

- ITI 002: Linking the LeCroy 9400 to an IBM^R PC-AT via the RS-232-C Asynchronous Interface.
- ITI 005: Linking the LeCroy 9400 to an IBM PC-AT via GPIB.
- ITI 006: Linking the LeCroy 9400 to an HP 9000 Model 216 controller.

7.2 RS-232-C Ports (56 and 57)

The 9400A has two RS-232-C ports. One is available for computer or terminal controlled oscilloscope operation, the other for plotter interfacing. The RS-232-C ports provide an asynchronous data transfer rate of up to 19,200 baud.

RS-232-C Pin Assignments

The remote RS-232-C pin Assignments (indicated on the rear panel) are as follows:

Pin #		Description
2	T x D	Transmitted Data (from the 9400A)
3	R x D	Received Data (to the 9400A)
4	RTS	Request To Send (always on) (from the 9400A)
5	CTS	Clear To Send (to the 9400A) When TRUE, the 9400A can transmit. When FALSE, transmission stops. It is used for the 9400A output hardware handshake.
20	DTR	Data terminal ready (from 9400A). If the software Xon/Xoff handshake is selected it is always TRUE. Otherwise (hardware handshake) it is TRUE when the 9400A is able to receive characters and FALSE when the 9400A is unable to receive characters.
6	DSR	Data Set Ready (to the 9400A)
1	GND	Protective Ground
7	SIG GND	Signal Ground

This corresponds to a DTE (Data Terminal Equipment) configuration.

Although descriptions vary slightly, pin assignments for the dedicated plotter interface (Section 6.6) are identical to those for the remote RS-232-C connector above.

7.3 GPIB Port (Option OP02 only) (55)

The 9400A's GPIB interface (optional) complies with IEEE-488 (1978) standards, and is intended to provide high-speed data transfer in either the ASCII or binary format between the 9400A and the computer to which it is interfaced. The maximum data transfer rate, depending on the controller used, may be as high as 400 kilobytes/sec.

GPIB Port Selection (54)

As mentioned in Section 6.5, the 9400A's rear panel thumbwheel switch is used to set addresses for programmed or remote oscilloscope operation. Addresses 0-30 define the 9400A's address when using the GPIB (IEEE-488) port; using any one of addresses 31-99 selects the RS-232-C port. The thumbwheel is read at power ON only. Whenever the GPIB address is changed, the power must be turned off and on again.

GPIB functions are clearly indicated on the rear panel next to the GPIB connector.

GPIB Functions

The following is a list of the various functions provided via the 9400A's rear panel GPIB connector:

AH1	Complete Acceptor Handshake
SH1	Complete Source Handshake
L4	Partial Listener Function
T5	Complete Talker Function
SR1	Complete Service Request Function
RL2	Partial Remote/Local Function
DC1	Complete Device Clear Function
DT1	Complete Device Trigger
PP1	Parallel Polling: remote configuration
CO	No Controller Functions
E2	Tri-state Drivers

7.4 GPIB and RS-232-C Command Format

7.4.1 Introduction

All the remote control commands apply equally to communication via the GPIB and RS-232-C ports. (Note that GPIB commands should not be used when Option OPO2 is not fitted in the 9400A.) Certain functions, however, which are part of the GPIB standard (such as Device Clear or Group Execute Trigger) must be implemented as separate commands for the RS-232-C interface (see Section 7.6.10). The command syntax is compatible with IEEE Recommended Practice for Code and Format Conventions (IEEE Standard 728-1982).

In GPIB, the predefined control commands, such as Device Clear, Group Execute Trigger, Set Remote or Set Local, are part of the device driver commands. Therefore the 9400A only has English-like commands for these functions in RS-232-C interfacing applications. The user must consult the manual for his GPIB-interface driver in order to determine the form of these special commands.

Commands are formed of easy-to-read, unambiguous English words, with abbreviations (typically 2 to 4 characters) being used to achieve higher throughput. Short and long formats may be freely substituted for one another.

The execution of certain commands depends on whether the 9400A is in the REMOTE or LOCAL state.

When the 9400A is in LOCAL:

- All the front panel controls are active.
- Reading the 9400A by remote control is possible.
- The status byte masks (see MASK command) and the communications protocol (see COMM command) may be written, status bytes may be cleared.

When the 9400A is in REMOTE:

- All the front-panel controls are deactivated, except the two display intensity controls and the left-hand side menu buttons.
- All the remote commands are executed.
- A special command (SCREEN) exists to deactivate the front panel display intensity controls and allows them to be set remotely.

7.4.2 Compound Commands

One or several commands can be sent to the 9400A in a message ending with <END>. In GPIB transfers, <END> is the line which marks the EOI (End of Information). In this case, <END> is < ;>, <CR> or <LF>. In RS-232-C transfers, <END> is a user-selectable string; the default is <CR>.

Where multiple commands are used to compose a message, each command is separated from the following one with a < ;>, a <CR> or a <LF> or with any combination of these characters.

Example:

```
TRIG_SLOPE POS; TIME/DIV 50 NS <END>
```

represents 2 commands where < ;> is used to separate them.

Commands are executed only after <END> is received. Exceptions to this rule are mentioned later (see Section 7.4.6).

7.4.3 Command Format

Simple commands consist of a header, indicating the desired operation. The header is usually followed by one or more parameters used to describe the desired operation in greater detail.

```
HEADER (<SPACE>, <,> or <=>) Parameter 1, Parameter 2, etc.
```

The header may be separated from Parameter 1 by either a space, comma, equals sign or any combination of these. Parameters MUST be separated from one another using a comma.

Headers and key-word parameters may be transmitted using either the full or an abridged format. Both upper and lower case characters are valid and may be used interchangeably.

Numbers must be in accordance with ANSI X3.42-1975 standards and may be transmitted as integers, or in scientific notation, with or without exponents. Waveform data values, however, can only be transferred as integers (8- or 16-bits). Suffixes are optional (but acceptable only when specifically mentioned).

Example:

The following commands are all legal ways of setting the vertical gain of CHANNEL 1 to 100 mV/div:

```
CHANNEL_1_VOLT/DIV .1
CHANNEL_1_VOLT/DIV,100 MVOLT
C1VD=100E-03 VOLT
C1VD 100 MV
```

The expression <100 MV> is considered as a single parameter with a suffix; therefore no comma is allowed to separate them. The space separating the parameter value and the suffix is optional.

7.4.4 Answers from the 9400A

As well as specifying a new parameter setting, it is also possible to query the 9400A in order to obtain a current value. Such queries are always indicated by a question mark.

Example:

```
TIME/DIV ?
```

instructs the 9400A to transmit a character string representing its current time base value.

Answers from the 9400A are sent in a message followed by the TRAILER (see COMM_TRAILER command) and <END>.

Example:

When set to 100 nsec/div, the answer to the query would be:

TD 100E-09<CR><LF><END> ,

where <CR><LF> is the default TRAILER, and
<END> = another <CR>, when using RS-232-C (unless modified with
the command RS CONF).
= EOI-line ACCOMPANYING <LF>, when using GPIB.

If the 9400A generates multiple responses to a single message containing queries, it will send a separate response for each query.

7.4.5 Flushing of the 9400A's Output Buffer

When the 9400A generates an answer to a query or outputs a data stream in response to a transfer command, the host computer should read the data. If it fails to do so, the 9400A may become blocked when trying to output data (this does not occur with a response of less than 80 characters, since the output is buffered).

Whenever the 9400A receives a new command message, upon detection of the <END> of this message, it flushes the output buffer of all responses due to the previous command message. If the 9400A detects a new <END> from a new command message while still treating a previous command message, it aborts those (previous) commands which generate output data, but not the new commands. The 9400A assumes that the user is not interested in the answers to previous commands since he is sending another command message rather than reading the responses.

7.4.6 Command Synchronization with Data Acquisition

Some remote commands cannot be executed at all times, e.g. it is not possible to read channel 1 or channel 2 while the oscilloscope is armed and waiting for a trigger, since the memories of the two channels are continuously being written into.

The user can avoid such situations entirely by only executing single-shot acquisitions (TRIG MODE SINGLE) and by checking that bit 0 of status byte 4 (TRIGGERED bit) is set to one (indicating that the acquisition is complete) before sending the READ command.

Another way is to send the command to read channel 1 or channel 2. The 9400A automatically defers the execution of this command until a waveform has been acquired. It is thus possible to also read waveforms while the instrument is in the trigger modes NORM or AUTO, i.e. practically "on-the-fly".

Execution of the command is also deferred when using some other remote control commands, in particular the command STORE channel 1 or channel 2, and the special command WAIT whose sole purpose is to force such a synchronization. (See Section 7.6.6 "Other Remote Commands".)

7.4.7 Character Strings

Strings may be displayed (see MESSAGE and KEY commands), sent to a plotter (see the TRANSMIT command) or used as Prompt (see COMM_PROMPT command). The string must be delimited by string delimiters. The default string delimiter is <"> and may be changed (see the COMM_STRDELIM command).

Example:

```
COMM_STRDELIM 47; MSG /OKAY/
```

Defines </> (decimal ASCII 47) as the string delimiter and will display OKAY on the screen.

The TRANSMIT command also outputs characters that are specified in decimal ASCII using a \nnn format.

Example:

```
TRANSMIT "\027AB"
```

Can be used to transmit to the plotter the character ESC (decimal ASCII 27) followed by <A> and .

If the backslash character <\> is to be transmitted along with other characters, then <\\> is to be used.

Example:

```
TRANSMIT "A1\\A2"
```

Instructs the 9400A to transmit the string A1\A2 to the plotter.

Note:

"\nnn" or "\\\" represent only one character of the ASCII string count.

7.4.8 Prompt

The 9400A may generate a PROMPT (see COMM-PROMPT command) when it decodes the <END> message in a command message. This PROMPT will be put into a message as is done with all other 9400A responses (see Section 7.6.7 7)).

7.4.9 Errors and Adapted Values

When it treats a command, the 9400A checks its validity. The list of errors is presented in Section 7.6.8 (ERROR status byte).

In general:

- A SYNTAX ERROR is produced when the structure of a command is wrong, or if a command, a key-word parameter or a suffix is not recognized.
- A SEMANTIC ERROR is produced when the command is composed of a wrong combination of parameters or if a numerical parameter is not valid.
- An ENVIRONMENT ERROR is produced when the command, although it is valid, cannot be accepted, the 9400A not being in the state to do so.

When an error is detected, the corresponding code is loaded into status byte 6, and the bit # 5 of status byte 1 is set.

Some commands cause bit 0 of status byte 1 (VALUE ADAPTED bit) to be set when the 9400A detects a numerical value or a parameter out of range. The value is always modified to the closest legal value.

7.5 Data Block Transfers

Data (9400A setup values, waveform values, waveform descriptor) are transferred between the 9400A and the Host Computer (see the READ or SETUP commands, Section 7.6.5) or between the Host and the 9400A (see WRITE or SETUP commands) in one or several blocks. Data blocks are never contained within a read or write command, but are always separate. This section explains only the overall block structure. For the interpretation of the data, see Section 7.10.

Examples:

Reading a waveform from channel 1 of the 9400A:

- Host sends the command READ,CHANNEL_1.DATA<END> to 9400A.
- 9400A responds with one (or several) data blocks in one of the formats described below, and terminates with <TRAILER> and <END>.

Thus, the overall command sequence and data structure is the same as for queries.

Sending a new setup block to the 9400A:

- Host sends the command SETUP<END> to 9400A.
- Host sends the data blocks to the 9400A. Each data block is composed of a preamble, the data, an optional postscript and <END>.

Here, the setup data cannot be directly appended to the setup command, but must be separated by <END>.

Several block formats are available for read and write; they are distinguished from each other by the preamble. The command COMM_FORMAT selects the format.

Format A: GPIB only, binary format, no checksum.

Preamble: #Abb where bb is the number of data values that will be sent (2 binary bytes).

Data: One binary byte for each 8-bit value, two binary bytes for each 16-bit value.

Postscript: None.

Format L: GPIB or RS-232-C, ASCII format.

Preamble: #L<count>, where <count> is the number of data values that will be sent.

Data: <data>, where <data> are data values in ASCII.

Postscript: None.

<count> and <data> are in the same format but do not necessarily have the same number of characters. However, <count> is always treated as a WORD (16 bits), whereas <data> may be chosen as a BYTE (8 bits) or as a WORD. The choice of formats (see COMM_FORMAT command) is the following:

	BYTE (8 bits value)	WORD (16 bits value)
HEX:	xx (2 hex digits)	xxxx (4 hex digits)
UNSIGNED_FIXED:	nnn (3 decimal digits)	nnnnn (5 decimal digits)
UNSIGNED_SHORT:	,n (1 to 3 decimal digits)	,nnnnn (1 to 5 decimal digits)

Remote Operations

The HEX and UNSIGNED_FIXED are fixed size formats, whereas UNSIGNED_SHORT is a variable size format. Therefore, it requires commas to separate the values.

Examples:

HEX format: #L000A0102030405060708090A
UNSIGNED_FIXED: #L...10..1..2..3..4..5..6..7..8..9.10 Each dot represents a space character
UNSIGNED_SHORT: #L,10,1,2,3,4,5,6,7,8,9,10

Note:
The conversion type and the size must be fixed before reading AND writing data.
Data transfers via RS-232-C can only be made in ASCII formats.

If the host computer allows only small amounts of data to be sent or read, the transfer may be partitioned into several blocks of the selected format. The maximum length of each block is determined by the COMM_BLOCKSIZE command. The length includes all bytes or characters of the block as well as characters which may compose the <TRAILER> and <END>.

The transfer will be structured as follows:

1st Block -- <TRAILER><END> -- 2nd Block -- <TRAILER><END> --
.... -- Last Block -- <TRAILER><END> -- END block -- <TRAILER><END>

Where the END block is:

#I

When reading data from the 9400A, the exact form of the TRAILER is determined by the command COMM_TRAILER. <END> is:

<END> = <CR> when using RS-232-C (unless modified with the command RS_CONF).
= EOI ACCOMPANYING the last character of TRAILER, when in GPIB.

If the 9400A receives another command message, terminated with <END>, while sending data, the transfer is aborted and status byte 6 (ERROR) is set to the value 1.

Data may be lost if the readout sequence is interrupted with a Serial Poll or by the untalk command.

Thus, the overall command sequence and data structure is the same as for queries.

Sending a new setup block to the 9400A:

- Host sends the command SETUP<END> to 9400A.
- Host sends the data blocks to the 9400A. Each data block is composed of a preamble, the data, an optional postscript and <END>.

Here, the setup data cannot be directly appended to the setup command, but must be separated by <END>.

Several block formats are available for read and write; they are distinguished from each other by the preamble. The command COMM_FORMAT selects the format.

Format A: GPIB only, binary format, no checksum.

Preamble: #Abb where bb is the number of data values that will be sent (2 binary bytes).

Data: One binary byte for each 8-bit value, two binary bytes for each 16-bit value.

Postscript: None.

Format L: GPIB or RS-232-C, ASCII format.

Preamble: #L<count>, where <count> is the number of data values that will be sent.

Data: <data>, where <data> are data values in ASCII.

Postscript: None.

<count> and <data> are in the same format but do not necessarily have the same number of characters. However, <count> is always treated as a WORD (16 bits), whereas <data> may be chosen as a BYTE (8 bits) or as a WORD. The choice of formats (see COMM_FORMAT command) is the following:

	BYTE (8 bits value)	WORD (16 bits value)
HEX:	xx (2 hex digits)	xxxx (4 hex digits)
UNSIGNED_FIXED:	nnn (3 decimal digits)	nnnnn (5 decimal digits)
UNSIGNED_SHORT:	,n (1 to 3 decimal digits)	,nnnnn (1 to 5 decimal digits)

The HEX and UNSIGNED FIXED are fixed size formats, whereas UNSIGNED SHORT is a variable size format. Therefore, it requires commas to separate the values.

Examples:

HEX format: #L000A0102030405060708090A
UNSIGNED_FIXED: #L...10..1..2..3..4..5..6..7..8..9.10 Each dot represents a space character
UNSIGNED_SHORT: #L,10,1,2,3,4,5,6,7,8,9,10

Note:

The conversion type and the size must be fixed before reading AND writing data.
Data transfers via RS-232-C can only be made in ASCII formats.

If the host computer allows only small amounts of data to be sent or read, the transfer may be partitioned into several blocks of the selected format. The maximum length of each block is determined by the COMM_BLOCKSIZE command. The length includes all bytes or characters of the block as well as characters which may compose the <TRAILER> and <END>.

The transfer will be structured as follows:

1st Block -- <TRAILER><END> -- 2nd Block -- <TRAILER><END> --
.... -- Last Block -- <TRAILER><END> -- END block -- <TRAILER><END>

Where the END block is:

#I

When reading data from the 9400A, the exact form of the TRAILER is determined by the command COMM_TRAILER. <END> is:

<END> = <CR> when using RS-232-C (unless modified with the command RS_CONF).
= EOI ACCOMPANYING the last character of TRAILER, when in GPIB.

If the 9400A receives another command message, terminated with <END>, while sending data, the transfer is aborted and status byte 6 (ERROR) is set to the value 1.

Data may be lost if the readout sequence is interrupted with a Serial Poll or by the untalk command.

7.6 Commands

7.6.1 Notation

In this section the following notation is used to explain the commands. However, these symbols must not be sent to the 9400A as part of a command.

[to] denotes the range of a numerical value.

< > denotes the choice of parameters.
The options are listed vertically.

() denotes the abridged format of a keyword.

, denotes a separator which may be <,> or a space or <=>.
The last two are only acceptable between the header and the first parameter, not between parameters.

* indicates commands which can be executed in REMOTE only.
Queries (terminated with a <?>) are always allowed.

** indicates commands which can only be executed in REMOTE when the display intensity controls have also been set to REMOTE.

Example:

```
TIME/DIV (TD) , < ? >
                  < [ 2 NS to 100 S ] > *
```

"TIME/DIV" is the long format of the command for controlling the time base.

"TD" is the short form equivalent of "TIME/DIV". Either form may be used at all times.

The comma is the separator between the header and the first parameter. It may be replaced by a space or by an equal sign <=>, or by any combination of these. Note that subsequent parameters MUST be separated from each other by commas only.

The parentheses < > show that the choice of the first (and only) parameter is either <?> or a time base value in the range of 2 nsec to 100 sec.

The asterisk <*> indicates that this command can only be executed when the 9400A is in the REMOTE state. However the query "TIME/DIV ?", can be executed at any time.

7.6.2 Acquisition Parameter Commands

1) TIME/DIV (TD) , < ? >
 < [2 NS to 100 S] > *

Other available suffixes are: US (μ sec, microseconds) and MS (msec, milliseconds).

The 9400A sets the VALUE ADAPTED bit:

- if an out-of-range value is given.
- if a value outside the incremental steps of 1, 2, 5 is given.

Examples:

TD = ? Instructs the 9400A to send the current time base value.
TD 20 US Sets the 9400A to 20 μ sec per division.
TIME/DIV 12 MS Sets the 9400A to 12 msec; since the value is modified from 12 msec to 10 msec, the VALUE ADAPTED bit in status byte 1 is set.

2) INTERLEAVED (IL) , < ? >
 < ON > *
 < OFF > *

Enables or disables Interleaved Sampling.

The 9400A sets the ENVIRONMENT ERROR:

- if ON command is sent while the time base is greater than 2 US.
- if OFF command is sent while the time base is less than 50 NS.

3) TRIG_DELAY (TRD) , < ? >
 < [0.00 % to 100.00 %] > *
 < [-0.04 NS to -1000000 S] > *

Positive format: pre-trigger.
Negative format: post-trigger delay.

Valid delay values correspond to 0 to 10000 time base divisions in steps of $1/50^{\text{th}}$ of a division. If the TIME BASE is changed, the delay remains the same or may change just slightly due to rounding, provided that it does not exceed 10000 divisions.

Note:

In the case of post-trigger delay, the remote value is negative while the corresponding value displayed on the screen is positive.

The 9400A sets the VALUE ADAPTED bit:

- if a positive out-of-range value is given.
- if a negative value corresponding to more than 10000 divisions is given.

- 4) TRIG_LEVEL (TRL) , < ? >
- , < [-5.00 DIV to 5.00 DIV] > *
- when the oscilloscope is set to one of the internal trigger sources (CHANNEL_1 or CHANNEL_2).
- , < [-2.00 V to 2.00 V] > *
- when the oscilloscope is set to in the EXT trigger source.
- , < [-20.0 V to 20.0 V] > *
- when the oscilloscope is set to the EXT/10 trigger source.

When the oscilloscope is set to LINE trigger source, this command has no meaning and no error will be reported. In the case of POS_NEG triggering, only a positive value is meaningful.

The 9400A sets the VALUE ADAPTED bit:

- if an out-of-range value is given.

The 9400A sets the ENVIRONMENT ERROR:

- if the DIV suffix is sent instead of V or if the V suffix is sent instead of DIV.

- 5) TRIG_COUPLING (TRC) , < ? >
- < AC > *
- < DC > *
- < LF_REJ (LF) > *
- < HF_REJ (HF) > *
-
- 6) TRIG_MODE (TRM) , < ? >
- < SEQNCE (SE) > *
- < AUTO (AU) > *
- < NORM (NO) > *
- < SINGLE (SI) > *

The 9400A sets the ENVIRONMENT ERROR:

- if SEQNCE is sent while the 9400A is in Interleaved Sampling.

- 7) TRIG_SOURCE (TRS) , < ? >
- < CHANNEL 1 (C1) > *
- < CHANNEL_2 (C2) > *
- < LINE (L \bar{I}) > *
- < EXT (EX) > *
- < EXT/10 (E/10) > *

Remote Operations

- 8) TRIG_SLOPE (TRP) , < ? >
 < POS (PO) > *
 < NEG (NE) > *
 < POS_NEG (PN) > *
- 9) SEGMENTS (SEG) , < ? >
 < 8 > *
 < 15 > *
 < 31 > *
 < 62 > *
 < 125 > *
 < 250 > *

Indicates or selects the number of segments for waveforms acquired in SEQNCE mode.

- 10) CHANNEL_1_VOLT/DIV (C1VD) , < ? >
 CHANNEL_2_VOLT/DIV (C2VD) < [5.000 MV to 12.500 V] > *

The range of the Volts/div setting is limited to 2.5 Volts per division in the case of 50 Ω coupling.

Note that this value corresponds to the 9400A input gain. It does not take probe attenuation factors into account.

The 9400A sets the VALUE ADAPTED bit:
 - if an out-of-range value is given.

Examples:

CHANNEL_2_VOLT/DIV,500 MV Sets channel 2 to 500 mV/div
 C1VD=.5 Sets channel 1 to 500 mV/div
 C2VD 120 MV Sets channel 2 to 120 mV/div by
 choosing 100 mV/div fixed gain and
 setting the variable gain to the
 required value.

- 11) CHANNEL_1_ATTENUATION (C1AT) , < ? >
 CHANNEL_2_ATTENUATION (C2AT) < 1 > *
 < 10 > *
 < 100 > *
 < 1000 > *

Indicates or selects the attenuation factor of the probe.

- 12) CHANNEL_1_OFFSET (C1OF) , < ? >
 CHANNEL_2_OFFSET (C2OF) < [-8.00 DIV to 8.00 DIV] > *

The 9400A sets the VALUE ADAPTED bit:
 - if an out-of-range value is given.

- 13) CHANNEL_1_COUPLING (C1CP) , < ? >
 CHANNEL_2_COUPLING (C2CP) < AC_1_MOHM (A1M) > *
 < DC_1_MOHM (D1M) > *
 < GND > *
 < DC_50_OHM (D50) > *
- 14) BANDWIDTH (BW) , < ? >
 < ON > *
 < OFF > *
- 15) STOP

Stops the acquisition of a signal. This command may be used to return the 9400A from the "armed" state to the "triggered" state, when the trigger is absent. It generates records similar to those produced in the AUTO trigger mode.

It is also useful to stop a SEQNCE acquisition when the number of triggers available is insufficient to fill all sweeps. Upon receipt of the STOP command, the 9400A displays the artificially completed sweeps as GND lines.

7.6.3 Display Commands

- 1) DUAL_GRID (DG) , < ? >
 < ON > *
 < OFF > *

Examples:

DUAL_GRID ON	Instructs the 9400A to display dual grids.
DG OFF	Instructs the 9400A to display a single grid of 8 x 10 squares.

- 2) TRACE_CHANNEL_1 (TRC1) , < ? >
 TRACE_CHANNEL_2 (TRC2) < ON > *
 TRACE_EXPAND_A (TREA) < OFF > *
 TRACE_EXPAND_B (TREB)
 TRACE_MEMORY_C (TRMC)
 TRACE_MEMORY_D (TRMD)
 TRACE_FUNCTION_E (TRFE)
 TRACE_FUNCTION_F (TRFF)

The 9400A sets the ENVIRONMENT ERROR:
 - if 4 traces are already ON, and a command is received to turn a 5th trace ON.

Adjustment	Reduce Signal Size	Increase Signal Size
Manually	Turn the Vert. Gain knob anti-clockwise. Notice that a ">" symbol appears in the window* on 9400A screen. Read the exact V/div in the memory STATUS menu.	Turn the Vert. Gain knob clockwise. Notice that the volts value in the window* changes, e.g. ".5 V" changes to "> .2 V" Read the exact V/div in the memory STATUS menu.
Query	Enter the command "VG ?" The response is a value between 1 and 2.5. Exact V/div = response × value indicated in the select window on 9400A screen.	
Remote Control	Enter "VG" followed by a value between 1 and 2.5 to attenuate the signal up to 2.5 times.	Not possible

* assumes that cursors are not being used

The 9400A sets the VALUE ADAPTED bit:

- if an out-of-range value is given.

The 9400A sets the ENVIRONMENT ERROR:

- if the SELECTed trace is OFF.

5) VERT_POSITION (VP) , < ? >
 < [-16.00 DIV to 16.00 DIV] > *

VERT_POSITION is applied to the SELECTed trace. This command instructs the 9400A to modify the display position (not the acquisition offset) of the selected trace by up to ± 16 divisions, relative to the original position at acquisition.

The 9400A sets the ENVIRONMENT ERROR:

- if the SELECTed trace is OFF.
- if the SELECTed trace is neither EXPAND_A nor EXPAND_B.

```
8) REDEFINE (RDF)      , < ?                >
                        < CHANNEL_1 (C1)     >          *
                        < CHANNEL_2 (C2)     >          *
                        < MEMORY_C (MC)      >          *
                        < MEMORY_D (MD)      >          *
```

Redefines the source of the SELECTed trace to be CHANNEL_1, CHANNEL_2, MEMORY_C, or MEMORY_D. The SELECTed trace must be EXPAND_A or EXPAND_B.

The 9400A sets the ENVIRONMENT ERROR:

- if the SELECTed trace is OFF.
- if the SELECTed trace is neither EXPAND_A nor EXPAND_B.

```
9) MESSAGE (MSG)      , <String to be displayed>          *
```

The string may be up to 43 characters in length. The message is displayed in the Message Field above the graticule (see Section 4.6).

Example:

```
MESSAGE "Apply probe to J11.5, then press READY"
```

Instructs the 9400A to display the message between the string delimiters " on the line above the graticule. The push button READY does not exist on the 9400A, but any of 9 soft keys may be defined as such with the command KEY.

```
10) KEY , < [1 to 9] > , <String to be displayed>          *
```

The string is displayed in the Menu Field (see Section 4.1) next to the soft key selected with the first parameter. The string may be up to 11 characters in length.

Examples:

```
KEY 3,!READY!
```

Instructs the 9400A to display the message "READY" next to the third (from the top) soft key on the left hand side of the graticule. This command is only accepted if the string delimiter has been changed from the default value <"> to <!> with the command COMM STRDELIM=33. The default value <"> = 34 (see Section 7.6.7).

KEY 1, "Restart"

Instructs the 9400A to display the message "Restart" next to the first soft key. Here, the default string delimiter is used.

```
11) SCREEN (SCR) , < ?           >
      < REMOTE (RM) >             *
      < LOCAL (LC)  >             *
```

or

```
SCREEN (SCR) , < ON   >          **
               < OFF  >          **
```

or

```
SCREEN (SCR) , < INTENSITY (INT) > , [0 to 170]  **
               < GRID_INTENSITY (GI)>           **
```

"?" allows the user to know the status of the screen.

"REMOTE" and "LOCAL" select the control mode of the screen. When the 9400A is set to REMOTE, the screen remains under LOCAL control allowing the operator to adjust the display intensity. The screen itself must be put into the REMOTE state using the command SCREEN (SCR) , <ON> before the commands marked with "***" are valid.

"ON" and "OFF" turn the screen ON and OFF respectively.

When the 9400A is being used to capture transients automatically without a user looking at the display, the display may be turned off. This improves the response time of the instrument since display generation, which may take up to 100 msec, is suppressed.

"INTENS" and "GRID_INT" set the display intensity.

The 9400A sets the VALUE ADAPTED bit:
- if a value greater than 170 is given.

7.6.4 Plotter Commands

```
1) PLOTTER (PT) , < ?   >
```

or

```
PLOTTER (PT) , <name> , <port> , <speed> , <pens> *
```



```

<name>      =      < GRAPHTEC (GR)          >
                < HEWLETT_PACKARD (HP)     >
                < PHILIPS (PH)              >
                < TEKTRONIX (TEK)          >

<port>      =      < RS232 (RS) >
                < GPIB (GP) >

<speed>     =      < NORMAL_SPEED (NS) >
                < LOW_SPEED (LS) >

<pens>      =      [ 1 to 9 ]

```

Configures the 9400A for a predefined plotter.

Examples:

```
PLOTTER HP,RS,NS,2
```

Configures the 9400A for a Hewlett-Packard plotter, connected to the RS-232-C plotter port, running at normal speed, with 2 pens. This is how the 9400A must be configured for the HP7470 and HP7475 or compatible plotters.

```
PT,GR,GP,LS,4
```

Configures the 9400A for a Graphtec FP5301 or compatible plotter, connected through GPIB, running at low speed (for plotting on transparencies), with 4 pens.

```

2) PLOT_SIZE (PS) , < ? >
                    < A5 > *
                    < A4 > *
                    < A3 > *

```

Configures the 9400A to plot onto a predefined paper size.

```

A5 = 148 mm by 210 mm, compatible with U.S. 5 1/2" by 8 1/2"
A4 = 210 mm by 297 mm, compatible with U.S. 8 1/2" by 11"
A3 = 297 mm by 420 mm, compatible with U.S. 11" by 17"

```

or

```
PLOT_SIZE (PS) , NON_STANDARD (NSTD) , <grid> , <x> , <y> *
```

Configures the 9400A to plot onto a non-standard paper size.

```
<grid> = [ 00.0 MM to 99.9 MM ]
```

<x> = [0 MM to 999 MM]

<y> = [0 MM to 999 MM]

<grid> is the size (length of a side) of the standard square within the 8 times 10 squares grid.

<x>, <y> are the positions of the lower left hand corner of the graticule with respect to the origin of the plotter.

The 9400A sets the VALUE ADAPTED bit:

- if an out-of-range positive value is given. Negative values generate a semantic error.

3) SCREEN_DUMP (SD) *

Instructs the 9400A to dump the screen display onto the plotter.

4) TRANSMIT (TX) , <String to be transmitted to the plotter> *

Instructs the 9400A to transmit a character string to the plotter. The string may be up to 43 characters in length and may include commands such as "paper advance" or "print string". This enables the user to add comments to a plot, or generate multiple plots by remote control.

The 9400A sets the ENVIRONMENT ERROR:

- if the 9400A is controlled through GPIB and if the plotter access port is the GPIB port.

7.6.5 Transfer Commands

1) STORE (STO) , [1 to 7] *

instructs the 9400A to store the current front panel configuration in one of 7 non-volatile storage areas for later recall.

or

STORE (STO) , < CHANNEL_1 (C1) > , < MEMORY_C (MC) > *
< CHANNEL_2 (C2) > < MEMORY_D (MD) >

instructs the 9400A to store the waveform and the waveform descriptor of either Channel 1 or 2 into reference memories C or D.

Notes:

If the 9400A receives a command to store Channel 1 or 2 while it is acquiring data, the execution of the command is delayed until the trigger has arrived.

No message will be displayed on the screen when the operation is performed.

2) RECALL (REC) , [1 to 8]

*

instructs the 9400A to recall one of 8 front-panel configurations stored in non-volatile memory. The value "8" corresponds to the default setup.

3) SETUP (SU) , ?

or

SETUP (SU)

*

The first form permits the complete setup to be read in internal data representation. Transmission format depends on the selected forms by the COMM_FORMAT command. The setup data block corresponds to 257 binary bytes.

The second form permits setup data to be sent to the 9400A in the same form as they were read from the 9400A. This command must be terminated with <END>, i.e. it must be the last of a list of commands. The data transferred to the 9400A must be contained in a separate block (see Section 7.5).

Note:

The serial port parameters can not be transmitted. In particular, if the transfers are by RS-232-C, modification of the serial port parameters by this command would bring about some strange results.

The 9400A sets the VALUE ADAPTED bit:

- if a data value in the block is incorrect. The DEFAULT setup will be used in this case.

The 9400A sets the INVALID BLOCK ERROR:

- if the received block(s) is incorrect.

4) READ (RD) , < CHANNEL_1.DESC (C1.DE) >
< CHANNEL_2.DESC (C2.DE) >
< MEMORY_C.DESC (MC.DE) >
< MEMORY_D.DESC (MD.DE) >

transfer the descriptor of the indicated waveform from the 9400A to the host computer. See Section 7.7 for the format of this data block.

or

```

READ (RD) , < CHANNEL_1.DATA (C1.DA) > , <Parameter list>
           < CHANNEL_2.DATA (C2.DA) >
           < MEMORY_C.DATA (MC.DA) >
           < MEMORY_D.DATA (MD.DA) >

```

<Parameter list> = <intval> , <# values> , <addr> , <sweep #>

transfer the data values of the indicated waveform from the 9400A to the host computer. An explanation of the optional parameter list is given below.

or

```

READ (RD) , < CHANNEL_1.TIME (C1.TI) >
           < CHANNEL_2.TIME (C2.TI) >
           < MEMORY_C.TIME (MC.TI) >
           < MEMORY_D.TIME (MD.TI) >

```

transfer the trigger time(s) of the indicated waveform from the 9400A to the host computer. See Section 7.8 for the format of this data block.

or

```

READ (RD) , < CHANNEL_1.* (C1.*) > , <Parameter list>
           < CHANNEL_2.* (C2.*) >
           < MEMORY_C.* (MC.*) >
           < MEMORY_D.* (MD.*) >

```

transfer ALL visible data of the indicated waveform from the 9400A to the host computer. Data are transferred in the order descriptor, data, time(s).

<Parameter list> = <intval> , <# values> , <addr> , <sweep #>

<intval> = [1 to 16000] Interval between data points to be read, for example:
 1 = read all points
 4 = leave out 3 of 4 data values

<# values>= [0 to 32000] Number of data values to read

<addr> = [-32000 to 32000] Address of first data point relative to the left hand side of the screen

<sweep #> = [0 to 250] Sweep number in SEQNCE waveforms, numbered from
 1 to max. # sweeps
 0 = read all sweeps

The parameter list is optional. Any omitted parameter is set to a default value:

<intval> = 1, i.e. leave no values out
<# values> = # values on the screen
<addr> = address of left-most value on the screen
<sweep #> = 0, i.e. read all sweeps

Thus, the omission of all parameters results in all the data values on the screen being read. A detailed explanation of the data addressing conventions is given in Section 7.9.

If the user does not specify the number of data values, READ DATA transfers are executed over the number of data values displayed on screen + 1, i.e. if the screen shows nominally 25000 data values, 25001 values are transferred.

Data formats:

- The descriptor (.DESC), the data (.DATA) and the time(s) (.TIME) are each transmitted as a single block unless a maximum block size has been specified with the command COMM_BLOCKSIZE.
- When all data are read (.*), they are transmitted as three blocks in the order: descriptor, data, time(s).
- When all sweeps of a SEQNCE data record are read (sweep # = 0), each sweep is transmitted as a separate block.
- The parameter <# values> applies to the number of data values per sweep in the case of SEQNCE data.

Note:

If the 9400A receives a command to read CHANNEL_1 or CHANNEL_2 while it is acquiring data, the execution of the command will be delayed until the TRIGGER has arrived.

The 9400A sets the VALUE ADAPTED bit:

- if <intval> is greater than 16000 (it is adapted to 16000).
- if <# values> corresponds to too large a value (it is adapted to the number corresponding to the last accessible value).
- if <addr> is out of range (it is adapted to the nearest legal address).
- if <sweep #> is higher than the selected number of sweeps (it is adapted to the last sweep number).

Examples:

READ,C1.DE

Instructs the 9400A to transmit the waveform descriptor of Channel 1 in the format described in Section 7.7. If the 9400A is armed and waiting for a trigger, the execution is deferred until the waveform is acquired.

READ,MC.DA

Instructs the 9400A to transmit all data values of Memory C which would appear on the screen, but no descriptor or trigger time(s).

READ,MC.DA,,, -7000

Instructs the 9400A to transmit all data points of Memory C, starting -7000 (invisible) points before the left hand side of the screen, up to the last value at the right hand side.

READ,C1.DA,5,100,1000

Instructs the 9400A to transmit 100 data values of Channel 1, starting 1000 values to the right of the beginning of the screen. Only every 5th data value is transmitted, i.e. 4 out of 5 values are omitted.

READ,MD.DA,,,5

Instructs the 9400A to transmit all data values of sweep #5 from the SEQNCE data record in memory D. If memory D is not a SEQNCE record, the last parameter is ignored, and the command would be interpreted as READ,MD.DA, resulting in the transmission of all (visible) data of the memory D.

READ,CHANNEL_2.*

Instructs the 9400A to transmit the waveform descriptor, data and time(s) of Channel 2. This is the most complete (and safest) way to archive the visible part of a waveform. The host computer can restore the complete waveform in memories C or D with the command WRITE MC.*, followed by the transmission of the data records.

READ, CHANNEL_2.*,,, -32000 Instructs the 9400A to transmit the waveform descriptor, data and time(s) of Channel 2, including all invisible data values on the left-hand side of the screen. The address -32000 is usually out of range, but the 9400A automatically adapts to the closest legal value. This complete data record is restored in memory C with the command WRITE MC.*,,, -32000.

5) WRITE (WT) , < MEMORY_C.DESC (MC.DE) > *
 < MEMORY_D.DESC (MD.DE) > *

transfer the waveform descriptor from the host computer to the indicated memory location of the 9400A. This command must be followed by the descriptor block(s). The 9400A checks the limits of each parameter transmitted. If any value is out of range, or the number of values transmitted is incorrect, the entire descriptor block is considered invalid and is discarded.

WRITE (WT) , < MEMORY_C.DATA (MC.DA) > , <Param.list> *
 < MEMORY_D.DATA (MD.DA) > *

<Parameter list> = <intval> , <# values> , <addr> , <sweep #>

transfer data values from the host computer to the indicated memory location of the 9400A. This command must be followed by the data value block(s). See the READ command for an explanation of <Parameter list>.

or

WRITE (WT) , < MEMORY_C.TIME (MC.TI) > *
 < MEMORY_D.TIME (MD.TI) > *

transfer trigger time(s) from the host computer to the indicated memory location of the 9400A. This command must be followed by the trigger time block. If the number of values transmitted is incorrect, the entire block is discarded.

When transferring WRITE DATA without specifying the number of data values, the nominal number + 1 data values must be sent to the 9400A (25000 + 1 data values for example). This additional value may be needed for the generation of the last displayed point at the right hand side of the screen.

or

WRITE (WT) , < MEMORY_C.* (MC.*) > , <Parameter list> *
 < MEMORY_D.* (MD.*) > *

<Parameter list> = <intval>,<# values>,<addr>,<sweep #>

transfer ALL data from the host computer to the indicated memory location of the 9400A. This command must be followed by the data blocks in the order: descriptor, data, trigger time(s).

See the READ command for an explanation of <Parameter list>.

In general, the 9400A decodes and checks each WRITE command it receives and verifies the optional parameters. If it receives a WRITE command for a complete waveform (WRITE xx.*), the parameters are only checked after the DESCRIPTOR block has been transmitted. If the <intval> parameter is not 1, intermediate points will be computed with a linear interpolation.

DESCRIPTOR values are checked for consistency after the entire block has been received. If an error is detected, the entire block is discarded and the invalid data block has no effect on the currently stored descriptor. The same is true for the time block.

However the waveform DATA values are directly stored into the final buffer during transmission. If an error occurs during the transfer, the data memory might be only partially filled with the new data.

The 9400A sets the VALUE ADAPTED bit:

- if a numerical parameter had to be modified during checking.
- if less or more DATA values have been received than were indicated by the numerical parameters (after checking) and only if the number of DATA values is not greater than the number of values remaining until the end of the sweep buffer.

The 9400A sets the INVALID BLOCK ERROR if an error in a block has been detected, i.e. if:

- The preamble is incorrect (is not #A, #L or #I)
 - The preamble number (indicating how many values the block has) is greater than the number of values that are allowed (SETUP, DESCRIPTOR or TIME) or greater than the number of values remaining until the end of the sweep buffer (DATA).
 - The number of received values does not correspond to the number in the preamble.
 - In the case of ASCII blocks (#L format), there are characters which are neither separator characters (" ", CR or LF) nor digits.
 - In the case of ASCII blocks, a value is greater than 255 (BYTE or 8 bits transfer) or greater than 65535 (WORD or 16 bits transfer).
- Other errors:
- Too many or too few values have been received (SETUP, DESCRIPTOR or TIME).

READ,CHANNEL_2.*,,,-32000 Instructs the 9400A to transmit the waveform descriptor, data and time(s) of Channel 2, including all invisible data values on the left-hand side of the screen. The address -32000 is usually out of range, but the 9400A automatically adapts to the closest legal value. This complete data record is restored in memory C with the command WRITE MC.*,,,-32000.

5) WRITE (WT) , < MEMORY_C.DESC (MC.DE) > *
 < MEMORY_D.DESC (MD.DE) > *

transfer the waveform descriptor from the host computer to the indicated memory location of the 9400A. This command must be followed by the descriptor block(s). The 9400A checks the limits of each parameter transmitted. If any value is out of range, or the number of values transmitted is incorrect, the entire descriptor block is considered invalid and is discarded.

WRITE (WT) , < MEMORY_C.DATA (MC.DA) > , <Param.list> *
 < MEMORY_D.DATA (MD.DA) > *

<Parameter list> = <intval> , <# values> , <addr> , <sweep #>

transfer data values from the host computer to the indicated memory location of the 9400A. This command must be followed by the data value block(s). See the READ command for an explanation of <Parameter list>.

or

WRITE (WT) , < MEMORY_C.TIME (MC.TI) > *
 < MEMORY_D.TIME (MD.TI) > *

transfer trigger time(s) from the host computer to the indicated memory location of the 9400A. This command must be followed by the trigger time block. If the number of values transmitted is incorrect, the entire block is discarded.

When transferring WRITE DATA without specifying the number of data values, the nominal number + 1 data values must be sent to the 9400A (25000 + 1 data values for example). This additional value may be needed for the generation of the last displayed point at the right hand side of the screen.

or

WRITE (WT) , < MEMORY_C.* (MC.*) > , <Parameter list> *
 < MEMORY_D.* (MD.*) > *

<Parameter list> = <intval>,<# values>,<addr>,<sweep #>

transfer ALL data from the host computer to the indicated memory location of the 9400A. This command must be followed by the data blocks in the order: descriptor, data, trigger time(s).

See the READ command for an explanation of <Parameter list>.

In general, the 9400A decodes and checks each WRITE command it receives and verifies the optional parameters. If it receives a WRITE command for a complete waveform (WRITE xx.*), the parameters are only checked after the DESCRIPTOR block has been transmitted. If the <intval> parameter is not 1, intermediate points will be computed with a linear interpolation.

DESCRIPTOR values are checked for consistency after the entire block has been received. If an error is detected, the entire block is discarded and the invalid data block has no effect on the currently stored descriptor. The same is true for the time block.

However the waveform DATA values are directly stored into the final buffer during transmission. If an error occurs during the transfer, the data memory might be only partially filled with the new data.

The 9400A sets the VALUE ADAPTED bit:

- if a numerical parameter had to be modified during checking.
- if less or more DATA values have been received than were indicated by the numerical parameters (after checking) and only if the number of DATA values is not greater than the number of values remaining until the end of the sweep buffer.

The 9400A sets the INVALID BLOCK ERROR if an error in a block has been detected, i.e. if:

- The preamble is incorrect (is not #A, #L or #I)
 - The preamble number (indicating how many values the block has) is greater than the number of values that are allowed (SETUP, DESCRIPTOR or TIME) or greater than the number of values remaining until the end of the sweep buffer (DATA).
 - The number of received values does not correspond to the number in the preamble.
 - In the case of ASCII blocks (#L format), there are characters which are neither separator characters ("", CR or LF) nor digits.
 - In the case of ASCII blocks, a value is greater than 255 (BYTE or 8 bits transfer) or greater than 65535 (WORD or 16 bits transfer).
- Other errors:
- Too many or too few values have been received (SETUP, DESCRIPTOR or TIME).

READ,CHANNEL_2.*,,,-32000 Instructs the 9400A to transmit the waveform descriptor, data and time(s) of Channel 2, including all invisible data values on the left-hand side of the screen. The address -32000 is usually out of range, but the 9400A automatically adapts to the closest legal value. This complete data record is restored in memory C with the command WRITE MC.*,,,-32000.

5) WRITE (WT) , < MEMORY_C.DESC (MC.DE) > *
 < MEMORY_D.DESC (MD.DE) > *

transfer the waveform descriptor from the host computer to the indicated memory location of the 9400A. This command must be followed by the descriptor block(s). The 9400A checks the limits of each parameter transmitted. If any value is out of range, or the number of values transmitted is incorrect, the entire descriptor block is considered invalid and is discarded.

WRITE (WT) , < MEMORY_C.DATA (MC.DA) > , <Param.list> *
 < MEMORY_D.DATA (MD.DA) > *

<Parameter list> = <intval> , <# values> , <addr> , <sweep #>

transfer data values from the host computer to the indicated memory location of the 9400A. This command must be followed by the data value block(s). See the READ command for an explanation of <Parameter list>.

or

WRITE (WT) , < MEMORY_C.TIME (MC.TI) > *
 < MEMORY_D.TIME (MD.TI) > *

transfer trigger time(s) from the host computer to the indicated memory location of the 9400A. This command must be followed by the trigger time block. If the number of values transmitted is incorrect, the entire block is discarded.

When transferring WRITE DATA without specifying the number of data values, the nominal number + 1 data values must be sent to the 9400A (25000 + 1 data values for example). This additional value may be needed for the generation of the last displayed point at the right hand side of the screen.

or

WRITE (WT) , < MEMORY_C.* (MC.*) > , <Parameter list> *
 < MEMORY_D.* (MD.*) > *

<Parameter list> = <intval>,<# values>,<addr>,<sweep #>

transfer ALL data from the host computer to the indicated memory location of the 9400A. This command must be followed by the data blocks in the order: descriptor, data, trigger time(s).

See the READ command for an explanation of <Parameter list>.

In general, the 9400A decodes and checks each WRITE command it receives and verifies the optional parameters. If it receives a WRITE command for a complete waveform (WRITE xx.*), the parameters are only checked after the DESCRIPTOR block has been transmitted. If the <intval> parameter is not 1, intermediate points will be computed with a linear interpolation.

DESCRIPTOR values are checked for consistency after the entire block has been received. If an error is detected, the entire block is discarded and the invalid data block has no effect on the currently stored descriptor. The same is true for the time block.

However the waveform DATA values are directly stored into the final buffer during transmission. If an error occurs during the transfer, the data memory might be only partially filled with the new data.

The 9400A sets the VALUE ADAPTED bit:

- if a numerical parameter had to be modified during checking.
- if less or more DATA values have been received than were indicated by the numerical parameters (after checking) and only if the number of DATA values is not greater than the number of values remaining until the end of the sweep buffer.

The 9400A sets the INVALID BLOCK ERROR if an error in a block has been detected, i.e. if:

- The preamble is incorrect (is not #A, #L or #I)
 - The preamble number (indicating how many values the block has) is greater than the number of values that are allowed (SETUP, DESCRIPTOR or TIME) or greater than the number of values remaining until the end of the sweep buffer (DATA).
 - The number of received values does not correspond to the number in the preamble.
 - In the case of ASCII blocks (#L format), there are characters which are neither separator characters ("", CR or LF) nor digits.
 - In the case of ASCII blocks, a value is greater than 255 (BYTE or 8 bits transfer) or greater than 65535 (WORD or 16 bits transfer).
- Other errors:
- Too many or too few values have been received (SETUP, DESCRIPTOR or TIME).

- The string beginning with a character other than "#" is received while the 9400A expects a block.
Such an error happens if the 9400A, previously configured to work without the END block (#I), receives less data than expected, followed by a command.
- Too many blocks have been received.

If the 9400A detects an error while receiving data blocks, any remaining values in the block, as well as the following blocks are purged until END block (#I) or a command is received.

When a command is received instead of a block, block transfer is aborted, but the command will be decoded like any other command.

When a block is received without being preceded by the WRITE command, the block will be purged and syntax error 11 will be produced (Invalid Header).

Note: Block data must end with a legal Trailer such as <CR>, <LF> or <CRLF>.

```
6) INSPECT (INS) , < CHANNEL_1.LIMIT (C1.LI) >
                  < CHANNEL_2.LIMIT (C2.LI) >
                  < MEMORY_C.LIMIT (MC.LI) >
                  < MEMORY_D.LIMIT (MD.LI) >
```

instructs the 9400A to return a character string containing the lower and upper address limits of the current waveform,

or

```
INSPECT (INS) , < CHANNEL_1.NSWEEPS (C1.NS) >
                < CHANNEL_2.NSWEEPS (C2.NS) >
                < MEMORY_C.NSWEEPS (MC.NS) >
                < MEMORY_D.NSWEEPS (MD.NS) >
```

instructs the 9400A to return a character string containing the number of sweeps (in averaging and extrema),

or

```
INSPECT (INS) , < MEMORY_C.INTVAL (MC.IV) >
                < MEMORY_D.INTVAL (MD.IV) >
```

instructs the 9400A to return a character string, containing the interval between data points used by a waveform processing function. This value may be used as the <intval> parameter in the readout of such waveforms if the user wishes to read only the computed data points and none of the interpolated points.

7.6.6 Other Remote Commands

1) CALIBRATE (CAL)

forces the 9400A to do a calibration of the interpolator and of both input channels at the current gain and bandwidth settings.

or

```
CALIBRATE (CAL) , < ? >
                  < ON >      *
                  < OFF >     *
```

allows automatic calibration (ON), disables automatic calibration (OFF), or queries the state of the automatic calibration. See Section 9.4 for the conditions under which the 9400A calibrates itself.

2) PROBE_CAL (PC) , < AC > , [0.000 V to 5.000 V] *

< DC >

This command permits generation of a square signal (AC) with a period of 1.024 msec, or a continuous (DC) level at the specified voltage at the probe test output.

When the 9400A returns to LOCAL, the default calibrator signal of 1 V (AC) is generated.

The 9400A sets the VALUE ADAPTED bit:
- if a positive out-of-range value is given.

3) AUTO_STORE (AS) , < ? > *

< [0 to 5] >

This command allows the user to query the 9400A on its AUTOSTORE state or setting of the AUTOSTORE mode:

- 0: AUTOSTORE off
- 1: automatic storage of CHANNEL_1 into MEMORY_C
- 2: automatic storage of CHANNEL_1 into MEMORY_D
- 3: automatic storage of CHANNEL_2 into MEMORY_C
- 4: automatic storage of CHANNEL_2 into MEMORY_D
- 5: automatic storage of CHANNEL_1 into MEMORY_C
and of CHANNEL_2 into MEMORY_D

The 9400A sets the ENVIRONMENT ERROR:

- if command is CTRL OFF, while controlling via GPIB.

- 3) COMM_HELP (CHLP) , < OFF >
< REM_PORT (RPO) >
< PLOT_PORT (PPO) >

Allows a HELP feature for the setup of remote control programs to be turned on. When the HELP feature has been turned on, the 9400A transmits character strings reflecting the message exchange between the host computer and the oscilloscope to the REMOTE or to the PLOTTER RS-232-C ports. These HELP messages can be viewed on a normal display terminal.

- 4) COMM_FORMAT (CFMT),A, <BYTE>
<WORD>

or

- COMM_FORMAT (CFMT),L, <BYTE>, <HEX>
<WORD>, <UNSIGNED_FIXED(UFIX)>

or

- COMM_FORMAT(CFMT),L, <BYTE>, <UNSIGNED_SHORT(USHO)>, <COMMA>
<WORD>, " " " <CR>
<LF>
<CRLF>

Selects a block transfer format, as described in Section 7.5. In RS-232-C remote control, only format L is available.

BYTE is for 8-bit data.

WORD is for 16-bit data. This format is normally used for 16-bit data being read from Memory C, Memory D, Function E or Function F. Raw data in Channel 1 and Channel 2 are always 8-bit data. It is possible to read raw or processed data as 16-bit words. Raw data have the measured 8-bit value in the most significant byte (transmitted first), and zero in the least significant byte (transmitted after).

HEX results in 2 hexadecimal digits for each 8-bit value and in 4 hexadecimal digits for 16-bit value.

UNSIGNED_FIXED uses 3 digits for BYTE data and 5 digits for WORD data.

UNSIGNED_SHORT uses only as many digits as required but separates data values with a sign. The last parameter selects the separator between numbers.

The default is <COMMA>.

Example:

With "COMM_FORMAT L,BYTE,UNSIGNED_SHORT,CRLF", a block will be:

```
#L
2
123
34
```

Whereas with "COMM_FORMAT L,BYTE,UNSIGNED_SHORT" it is:

```
#L,2,123,34
```

The 9400A sets the ENVIRONMENT ERROR:

- if the A format is selected while the 9400A is controlled through RS-232-C.

5) COMM_BLOCKSIZE (CBLS) , -1

The data is transmitted in one block only, and the END block (#I) is neither sent nor received.

COMM_BLOCKSIZE (CBLS) , 0

The data is transmitted in one block only. The END block (#I) will be sent and must be received. This is the default block size.

COMM_BLOCKSIZE (CBLS) , [40 to 32000]

The data is transmitted in one or more blocks. The END block (#I) will be sent and must be received with the purpose of marking the end of the block transfer.

This command selects the maximum block size for data block transfers (READ,WRITE,SETUP). The specified block size includes all data bytes, including preamble and postscript.

The 9400A sets the VALUE ADAPTED bit:

- if the numerical parameter is positive but less than 40 (it will be adapted to 40) or if it is greater than 32000 (it will be adapted to 32000).

6) COMM_STRDELIM (CSDE) , [1 to 127]

Defines the ASCII character that the 9400A recognizes as a string delimiter. The default is the character "<>", whose decimal value is 34.

7) COMM_PROMPT (CPRM) , < OFF >
< prompt string >

Defines the 9400A prompt string which may be up to 10 characters long. The default is OFF. This feature simplifies interactive programming of the 9400A. When set, the host computer must read the 9400A after every command, even when no response is normally expected. The 9400A responds either with the prompt string alone or with its response, followed by the prompt, indicating that it is ready for another command.

Summary of COMM default values:

COMM_HEADER	:	SHORT
COMM_TRAILER	:	CRLF
COMM_HELP	:	OFF
COMM_FORMAT	:	GPIB: A format, BYTE RS232: L format, BYTE, UFIX, COMMA
COMM_BLOCKSIZE	:	0
COMM_STRDELIM	:	" (Decimal value: 34)
COMM_PROMPT	:	OFF

7.6.8 Status Byte and Mask Register Commands

The 9400A contains a Main Status Byte (STB 1) and 5 additional status bytes, numbered from 2 to 6. Each status byte has an associated mask register, also numbered from 1 to 6. The purpose of the status bytes is to keep track of the internal conditions of the 9400A. The user can use 2 methods of staying informed:

- The status bytes can be read at any time, one by one or in a single block, with or without simultaneous clearing. This method ignores all mask registers. The host computer program is required to continue testing a status bit of interest, e.g., bit #0 of the OPERATION COMPLETE status byte (STB 5) after the SCREEN_DUMP command.
- The user can configure the 9400A to generate an interrupt to the host computer upon the occurrence of one or several conditions. The user must demask the bit(s) of the status byte which corresponds to the condition(s), by setting 1's into the corresponding bit of the mask in question. In addition, the corresponding bit in the Main Status Byte (STB 1) must also be demasked in order to allow the generation of the Service Request. This method is much more efficient timewise, but requires a more complex setup. In addition, the host computer must be configured to handle an interrupt by the GPIB SRQ-line. See Section 7.11 for more explanations and examples.

Status bytes are cleared (except STB 4) when reading them with the command STB, but not with TSTB. They are also cleared on POWER ON and by a Device Clear command. Mask registers are cleared on POWER ON, with a Device Clear command, or by writing 0 into them.

Main Status Byte (STB 1):

DIO # (1-8)	Bit # (0-7)	Associated data byte	Significance (to generate an SRQ)
DIO-1	0	none	VALUE ADAPTED
DIO-2	1	STB 2	unspecified
DIO-3	2	STB 3	SOFTKEY PRESSED or CALL TO HOST
DIO-4	3	STB 4	INTERNAL STATE has CHANGED
DIO-5	4	STB 5	OPERATION COMPLETE
DIO-6	5	STB 6	ERROR detected
DIO-7	6	none	RQS (request for service)
DIO-8	7	none	MESSAGE READY

If one of the bits DIO-1 to DIO-6 or DIO-8 becomes 1 and the corresponding bit is set in the Main Mask register (MASK 1), the RQS bit is set to 1, and a service request (SRQ) is generated if it is not already pending. The bits associated with the lower status bytes (STB 2 to 6) are only set inside STB1 if their masks allow the propagation of the bits to STB1 (see description of the individual status bytes below).

VALUE ADAPTED: set if a value associated with a remote control command is out of range, and adapted to the closest legal value.

Bit 1 (DIO-2): reserved.

SOFTKEY PRESSED: set if one of the 9 soft keys (in REMOTE) or if the key CALL TO HOST (in LOCAL) has been pressed. The last key is only active after being setup by the command CALL HOST. The identity of the soft key is coded in the SOFTKEY PRESSED status byte (STB3).

INTERNAL STATE CHANGE: set if an internal state within the 9400A has changed. The identity of the internal state is recorded in the INTERNAL STATE status byte (STB 4).

OPERATION COMPLETE: set if an operation in the 9400A has been completed. The associated OPERATION COMPLETE status byte (STB5) contains the information about which operation has been completed.

ERROR: set if an error condition has been detected. The error is coded in the associated ERROR status byte (STB 6).

RQS: GPIB RQS bit, indicating if a service request is pending.

MESSAGE READY: set to indicate that a message is ready for transmission to the remote controller.

STB 2:

This status byte is unused and has no significance. However, it exists and has an associated mask. The commands STB, MASK and TSTB act on all 6 status bytes or masks, including STB 2.

SOFTKEY PRESSED Status Byte (STB 3):

This status byte contains the coded value of the most recently pressed soft key. Whenever the MASK 3 is non-zero, and the code in STB 3 is set to a non-zero value, the SOFTKEY PRESSED bit (DIO-3) in STB 1 is set.

Codes:

- 0: No soft key pressed.
- 1 - 9: One of soft keys 1 - 9 pressed (in REMOTE)
- 10: CALL TO HOST soft key pressed (in LOCAL)

INTERNAL STATE Status Byte (STB 4):

This status byte contains status bits, reflecting the internal state of the 9400A. Since the internal states cannot be directly controlled, reading this byte does NOT reset it. Whenever a bit of this status byte gets set, and the corresponding bit in MASK 4 is also set, the INTERNAL STATE bit (DIO-4) in STB 1 is set.

Bits:

- 0: TRIGGERED: cleared when the 9400A is armed, i.e. acquiring data, and set when the 9400A is triggered, i.e. not acquiring data.
- 1: OVERLOAD1: set when channel 1 is in overload, reset otherwise.
- 2: OVERLOAD2: set when channel 2 is in overload, reset otherwise.
- 3: FIRST SEQNCE sweep triggered

Note:

Overloads are cleared by removing the overloading signal from the input and by returning the input coupling to 50 Ω . Overloads never occur with 1 M Ω coupling.

OPERATION COMPLETE Status Byte (STB 5):

This status byte contains status bits reflecting the identity of the operation which has been completed. Whenever a bit of this status byte gets set, and the corresponding bit in MASK5 is also set, the OPERATION COMPLETE bit (DIO-5) in STB1 is set.

Bits:

- 0: Set when a screen dump (in REMOTE only) is finished
- 2: Set when calibration is done (in REMOTE only)
- 3: Average END

ERROR Status Byte (STB 6):

This status byte contains the coded value of the most recently detected error. The individual bits have no well defined meaning. Whenever MASK 6 is non-zero, and the code in STB 6 is set to a non-zero value, the ERROR bit (DIO-6) in STB1 is set.

Code:

- 0: No error
- 1: Not all 9400A responses have been read upon receipt of a new command string, terminated with <END>. Output buffer has been flushed.

Syntax errors:

- 10: Invalid separator or too many parameters
- 11: Invalid header
- 12: Invalid number format
- 13: Invalid keyword
- 14: Invalid block
- 15: 2 or more strings in the same command
- 20: Command permission error; REMOTE only command has been received while the 9400A is in LOCAL, or SCREEN control command has been received while SCREEN control is LOCAL
- 30: The 9400A has received a command for an option that is not installed
- 40: Semantic error: false number of parameters or false parameter in a command
- 50: Environment error: the 9400A is not set to the proper status to accept the received command (trace OFF, false format...)
- 60: Descriptor error; an inconsistency has been detected in the data received with a WRITE descriptor command
- 100: Command not yet implemented

1) STB , [1 to 6] , ?

Reads the contents of one of the 6 status bytes and clears it. STB1 is the Main Status Byte. STB 4 is not cleared.

or

STB , ?

Reads all 6 status bytes in the order 1 to 6 and clears them (except STB 4).

2) MASK , [1 to 6] , ?

Reads the contents of one of the 6 mask registers. Mask register 1 is the mask register corresponding to the Main Status Byte.

or

MASK , ?

Reads the contents of the 6 mask registers in the order 1 to 6.

or

MASK , [1 to 6] , [0 to 255]

Sets the contents of one of the 6 mask registers to a decimal value between 0 to 255.

3) TSTB , [1 to 6] , ?

Reads the contents of one of the 6 status bytes but does not clear it. Status Byte 1 is the Main Status Byte.

or

TSTB , ?

Reads the contents of all status bytes in the order 1 to 6, but does not clear them.

7.6.9 GPIB Interface Message Interpretation

1) Device clear: DCL (GPIB hexa code: 14) or SDC (GPIB hexa code: 4)

Clears the input and output buffers, terminates plotting and data transmission. All the status bytes, except STB 4, and all the corresponding masks as well as the SRQ line are reset.

THIS COMMAND IS IMMEDIATELY EXECUTED.

2) Trig: GET (GPIB hexa code: 8)

Re-arms the oscilloscope. Valid only in SINGLE or SEQNCE mode and only when the 9400A is in REMOTE.

3) REMOTE/LOCAL commands:

If the 9400A receives a command to go into REMOTE or go back to LOCAL while it is acquiring a signal, the front panel REMOTE LED doesn't change, although the internal state as well as the display will change.

7.6.10 RS-232-C Only Commands

The following commands are only valid when the 9400A is controlled via the RS-232-C ports. <ESC> stands for the ASCII ESCAPE character.

1) RS_CONF , <duplex> , <end1> , <end2> , <echo> , <delay>

Configures the RS-232-C remote control protocol.

<duplex>	=	[0 to 127]	If 0, it selects full duplex mode, otherwise selects half duplex mode. The number represents the decimal ASCII value of the trigger (or talk) character.
<end1>	=	[0 to 127]	Selects <END> message string of 1 or 2 characters in length, as it will be used in commands sent to the 9400A. In transfers from the 9400A to the host computer, messages or data blocks are terminated with <TRAILER> (as defined with the command COMM TRAILER), followed by <END>. Default: <CR>.
<end2>	=	[0 to 127]	
<echo>	=	[0 to 127]	Selects the echo character (in half duplex only). If zero, no echo mode is selected. Default: no echo character.
<delay>	=	[0 to 60,000]	Selects the delay before talk in msec (half duplex only). Default: 0 msec.

The 9400A sets the VALUE ADAPTED bit:

- if an out of range positive value is given for the delay.

The 9400A may be configured to work either in full duplex mode or in half duplex mode. Full duplex mode may be selected if the host computer does not echo the characters it receives from the 9400A and if it is able to store the received characters in a buffer. In half duplex mode, the host computer tells the 9400A to talk by sending a trigger character to the 9400A.

In full duplex mode, the 9400A sends its message(s) immediately.

In half duplex mode, after it has received the trigger character, and the selected delay has elapsed the 9400A sends its messages one at a time until <END> message. It needs a trigger for each message. If the host echoes received characters, echo mode must be selected. In that case, the 9400A discards any received characters (except those of Device Clear Command) until it receives the <echo> character.

The 9400A may be configured for Half Duplex mode in two situations:

- a) If the computer which controls the 9400A through the RS-232-C Remote port, does not support full duplex communication and cannot support data flow between the 9400A and itself in both directions simultaneously (e.g. if the port on the computer can only be open in one direction at a time).
- b) If the computer, which controls the 9400A, echoes characters it receives from the 9400A (the port acting as a terminal port).

In the first case, the 9400A can be configured with the following sequence of commands:

<ESC>	disables echoing of characters received by the 9400A.
COMM TRAILER OFF	disables trailer.
RS_CONF 9,13,10,0,0	selects half duplex mode with <TAB> (decimal 9) as a talk character, <CR> <LF> (decimal 13 and 10) as <END> message string, no echo character and no turnaround delay.

Whenever the computer interrogates the 9400A to get one or several responses, or to get one more blocks of data, it sends the command followed by <CR> (optional) and <LF> and then by <TAB>. <TAB> puts the 9400A into the talker mode and instructs the 9400A to send one response or one block of data to the computer. To get more information or more blocks, <TAB> must be re-sent.

Example:

The computer wants to know time base and bandwidth limit settings.

Computer sends:	TIME/DIV ?; BANDWIDTH ?<CR><LF><TAB>
9400A answers:	TIME/DIV 2.00E-03<CR><LF>
Computer sends:	<TAB>
9400A answers:	BANDWIDTH ON<CR><LF>

The characters which put the 9400A into a talker mode and the characters of the <END> message string must not be the same. If they were, <END> would purge the second part of the output.

If turnaround delay is necessary, i.e. if a certain amount of time is necessary between the time the 9400A receives the trigger character and the time it sends the first character, the last parameter of the RS_CONF must be non-zero.

Example: RS_CONF 9,13,10,0,1000 with a turnaround delay of 1 second.

The turnaround delay is given in msec, therefore the value of 1000 corresponds to 1 sec. Note that during this delay the 9400A may appear as dead.

In the second case, i.e. when the controller echoes characters, the 9400A can be configured with the following sequence of commands:

<ESC>	disables echoing of characters received by the 9400A.
COMM_TRAILER OFF	disables trailer.
RS_CONF 9,13,10,10,0	selects half duplex mode with <TAB> (decimal 9) as trigger (or talk) character, <CR> <LF> (decimal 13 and 10) as <END> message string, <LF> as echo character and no turnaround delay.

Whenever the controller interrogates the 9400A to get one or several responses or to get one or more blocks of data, it sends the command followed by <CR> (optional) and <LF> and then by <TAB>. This last character instructs the 9400A to send one response or one block of data. To get more information or more blocks <TAB> must be re-sent.

Example:

The computer wants to get the setup configuration. If the 9400A has been configured to send blocks of data in hex format in blocks of 300 characters, the computer will receive 3 blocks.

Computer sends:	SU ?<CR><LF><TAB>
9400A answers:	#L.....<CR><LF>
	Each character including <LF> will be echoed by the computer.
Computer sends:	<TAB>
9400A answers:	#L.....<CR><LF>
	Each character including <LF> will be echoed by the computer.
Computer sends:	<TAB>
9400A answers:	#I<CR><LF>
	#I<CR><LF> will be echoed by the computer.

Notice that <LF> is used both as the last character of <END> message string and as the <ECHO> character. Character strings (except <ESC> C string for DEVICE CLEAR and <ESC>, <ESC>, <ESC>, <ESC>) will be lost if sent between <TAB> and <LF>.

In both cases, if a service request has been activated, the string will be sent only when the trigger character is received.

In both cases, DEVICE CLEAR (<ESC>C) resets the RS-232-C remote port to the DEFAULT setting, i.e.:

- ECHO ON
- full duplex mode with <CR> as <END> message string.
- Overwrite mode if the output buffer becomes full.

2) RS_SRQ , [0 to 127] , [0 to 127] , [0 to 127]

Defines a 3-character service request (SRQ) string that is sent by the 9400A each time the RQS bit (bit 6) of the Main Status Byte (STB 1) is set to 1. A null character (value 0) terminates the string, i.e. a string of 1 or 2 characters may be defined by setting the rest of the characters to 0. If the first character is set to null (value 0), the default string is selected. Default is the bell (value 7). If half duplex mode is selected, the transmission of this string may be delayed until the trigger character has been received. The 9400A appends <END> to the SRQ-string, but not the <TRAILER>.

3) <ESC> (

Selects DTR / CTS hardwire handshake protocol.

THIS COMMAND IS IMMEDIATELY EXECUTED.

4) <ESC>)

Selects XON (ASCII DC1 character) / XOFF (ASCII DC3 character) handshake protocol. (DEFAULT)

THIS COMMAND IS IMMEDIATELY EXECUTED.

5) <ESC>[

The 9400A does not echo characters received.

THIS COMMAND IS IMMEDIATELY EXECUTED.

6) <ESC>]

The 9400A echoes characters received. (DEFAULT).

THIS COMMAND IS IMMEDIATELY EXECUTED.

7) <ESC> <

When its output buffer is full, the 9400A stops until more space is created in the output buffer (i.e. until the host computer has read some characters).

THIS COMMAND IS IMMEDIATELY EXECUTED.

8) <ESC> >

If the output buffer becomes full, the 9400A overwrites the last character. (DEFAULT).

THIS COMMAND IS IMMEDIATELY EXECUTED.

9) <ESC> R

Sets the 9400A to REMOTE.

10) <ESC> L

Sets the 9400A to LOCAL.

11) <ESC> C

The 9400A executes a DEVICE CLEAR command, clears the input and output buffers, all the status bytes except STB 4, and all the corresponding masks. It then terminates plotting and data transmission and resets the RS-232-C REMOTE port to DEFAULT setting.

THIS COMMAND IS IMMEDIATELY EXECUTED.

12) <ESC> T

The 9400A executes a TRIGGER command (see Section 7.6.9).

7.7 Binary Format of Waveform Descriptors

The waveform descriptor contains all information needed to correctly interpret the waveform data. In addition, there are some values that apply only to some records, in particular to waveforms that are the result of data processing.

The descriptor contains 8-bit values, 16-bit values and 32-bit integer values. There are no floating point values. Multi-byte values are always transferred with the most significant byte first. In the following list, each parameter is identified by its (decimal) address relative to the beginning of the descriptor, and by the number of bits. Data values shown are always in decimal.

Note: The first 4 bytes are header information in agreement with IEEE-488 specifications. The 5th byte is POS 0.

Pos	Size	Meaning										
0	8-bit	<p>Fixed vertical gain, coded as an integer.</p> <table> <tr> <td>22 = 5 mV/div</td> <td>23 = 10 mV/div</td> </tr> <tr> <td>24 = 20 mV/div</td> <td>25 = 50 mV/div</td> </tr> <tr> <td>.....</td> <td>31 = 5 V/div</td> </tr> </table> <p>Values below 22 and above 31 may occur on processed data records. See Section 7.10.1 for an example of how data values are converted to volts in processed data records.</p>	22 = 5 mV/div	23 = 10 mV/div	24 = 20 mV/div	25 = 50 mV/div	31 = 5 V/div				
22 = 5 mV/div	23 = 10 mV/div											
24 = 20 mV/div	25 = 50 mV/div											
.....	31 = 5 V/div											
1	8-bit	<p>Variable vertical gain, in units of 0.005 of unity.</p> <p>0 = gain of 0.4, 120 = gain of 1.000.</p> <p>See Section 7.10.1 for an example of how data values are converted to volts in processed data records.</p>										
2	16-bit	Unused										
4	16-bit	<p>Vertical offset in units of 0.04 of the vertical deflection factor, i.e. 0.04 V/div.</p> <table> <tr> <td>0 = - 8 div</td> <td>25 = - 7 div</td> </tr> <tr> <td>50 = - 6 div</td> <td>.....</td> </tr> <tr> <td>200 = 0 div</td> <td>225 = 1 div</td> </tr> <tr> <td>250 = 2 div</td> <td>.....</td> </tr> <tr> <td>400 = 8 div</td> <td></td> </tr> </table> <p>See Section 7.10.1 for an example of how data values are converted to volts in processed data records.</p>	0 = - 8 div	25 = - 7 div	50 = - 6 div	200 = 0 div	225 = 1 div	250 = 2 div	400 = 8 div	
0 = - 8 div	25 = - 7 div											
50 = - 6 div											
200 = 0 div	225 = 1 div											
250 = 2 div											
400 = 8 div												
6	8-bit	<p>Input channel coupling at acquisition.</p> <table> <tr> <td>0 = DC, 50 Ω</td> <td>1 = Ground</td> </tr> <tr> <td>2 = DC, 1 MΩ</td> <td>3 = Ground</td> </tr> <tr> <td>4 = AC, 1 MΩ</td> <td></td> </tr> </table>	0 = DC, 50 Ω	1 = Ground	2 = DC, 1 M Ω	3 = Ground	4 = AC, 1 M Ω					
0 = DC, 50 Ω	1 = Ground											
2 = DC, 1 M Ω	3 = Ground											
4 = AC, 1 M Ω												
7	8-bit	<p>Attenuation of external probe (must have been set up manually or by remote control)</p> <table> <tr> <td>0 = *1</td> <td>1 = *10</td> </tr> <tr> <td>2 = *100</td> <td>3 = *1000</td> </tr> </table> <p>This value is already absorbed into the fixed vertical gain (position 0), it serves only as a reminder here.</p>	0 = *1	1 = *10	2 = *100	3 = *1000						
0 = *1	1 = *10											
2 = *100	3 = *1000											
8	8-bit	<p>Bandwidth limit at acquisition.</p> <table> <tr> <td>0 = off</td> <td>1 = on</td> </tr> </table>	0 = off	1 = on								
0 = off	1 = on											
9	8-bit	<p>Time base at acquisition, coded as an integer.</p> <table> <tr> <td>4 = 2 nsec/div</td> <td>5 = 5 nsec/div</td> </tr> <tr> <td>6 = 10 nsec/div</td> <td>7 = 20 nsec/div</td> </tr> <tr> <td>.....</td> <td>34 = 20 sec/div</td> </tr> <tr> <td>35 = 50 sec/div</td> <td>36 = 100 sec/div</td> </tr> </table>	4 = 2 nsec/div	5 = 5 nsec/div	6 = 10 nsec/div	7 = 20 nsec/div	34 = 20 sec/div	35 = 50 sec/div	36 = 100 sec/div		
4 = 2 nsec/div	5 = 5 nsec/div											
6 = 10 nsec/div	7 = 20 nsec/div											
.....	34 = 20 sec/div											
35 = 50 sec/div	36 = 100 sec/div											

8) <ESC> >

If the output buffer becomes full, the 9400A overwrites the last character. (DEFAULT).

THIS COMMAND IS IMMEDIATELY EXECUTED.

9) <ESC> R

Sets the 9400A to REMOTE.

10) <ESC> L

Sets the 9400A to LOCAL.

11) <ESC> C

The 9400A executes a DEVICE CLEAR command, clears the input and output buffers, all the status bytes except STB 4, and all the corresponding masks. It then terminates plotting and data transmission and resets the RS-232-C REMOTE port to DEFAULT setting.

THIS COMMAND IS IMMEDIATELY EXECUTED.

12) <ESC> T

The 9400A executes a TRIGGER command (see Section 7.6.9).

7.7 Binary Format of Waveform Descriptors

The waveform descriptor contains all information needed to correctly interpret the waveform data. In addition, there are some values that apply only to some records, in particular to waveforms that are the result of data processing.

The descriptor contains 8-bit values, 16-bit values and 32-bit integer values. There are no floating point values. Multi-byte values are always transferred with the most significant byte first. In the following list, each parameter is identified by its (decimal) address relative to the beginning of the descriptor, and by the number of bits. Data values shown are always in decimal.

Note: The first 4 bytes are header information in agreement with IEEE-488 specifications. The 5th byte is POS 0.

Pos	Size	Meaning										
0	8-bit	<p>Fixed vertical gain, coded as an integer.</p> <table border="0"> <tr> <td>22 = 5 mV/div</td> <td>23 = 10 mV/div</td> </tr> <tr> <td>24 = 20 mV/div</td> <td>25 = 50 mV/div</td> </tr> <tr> <td>.....</td> <td>31 = 5 V/div</td> </tr> </table> <p>Values below 22 and above 31 may occur on processed data records. See Section 7.10.1 for an example of how data values are converted to volts in processed data records.</p>	22 = 5 mV/div	23 = 10 mV/div	24 = 20 mV/div	25 = 50 mV/div	31 = 5 V/div				
22 = 5 mV/div	23 = 10 mV/div											
24 = 20 mV/div	25 = 50 mV/div											
.....	31 = 5 V/div											
1	8-bit	<p>Variable vertical gain, in units of 0.005 of unity.</p> <table border="0"> <tr> <td>0 = gain of 0.4,</td> <td>120 = gain of 1.000.</td> </tr> </table> <p>See Section 7.10.1 for an example of how data values are converted to volts in processed data records.</p>	0 = gain of 0.4,	120 = gain of 1.000.								
0 = gain of 0.4,	120 = gain of 1.000.											
2	16-bit	Unused										
4	16-bit	<p>Vertical offset in units of 0.04 of the vertical deflection factor, i.e. 0.04 V/div.</p> <table border="0"> <tr> <td>0 = - 8 div</td> <td>25 = - 7 div</td> </tr> <tr> <td>50 = - 6 div</td> <td>.....</td> </tr> <tr> <td>200 = 0 div</td> <td>225 = 1 div</td> </tr> <tr> <td>250 = 2 div</td> <td>.....</td> </tr> <tr> <td>400 = 8 div</td> <td></td> </tr> </table> <p>See Section 7.10.1 for an example of how data values are converted to volts in processed data records.</p>	0 = - 8 div	25 = - 7 div	50 = - 6 div	200 = 0 div	225 = 1 div	250 = 2 div	400 = 8 div	
0 = - 8 div	25 = - 7 div											
50 = - 6 div											
200 = 0 div	225 = 1 div											
250 = 2 div											
400 = 8 div												
6	8-bit	<p>Input channel coupling at acquisition.</p> <table border="0"> <tr> <td>0 = DC, 50 Ω</td> <td>1 = Ground</td> </tr> <tr> <td>2 = DC, 1 MΩ</td> <td>3 = Ground</td> </tr> <tr> <td>4 = AC, 1 MΩ</td> <td></td> </tr> </table>	0 = DC, 50 Ω	1 = Ground	2 = DC, 1 MΩ	3 = Ground	4 = AC, 1 MΩ					
0 = DC, 50 Ω	1 = Ground											
2 = DC, 1 MΩ	3 = Ground											
4 = AC, 1 MΩ												
7	8-bit	<p>Attenuation of external probe (must have been set up manually or by remote control)</p> <table border="0"> <tr> <td>0 = *1</td> <td>1 = *10</td> </tr> <tr> <td>2 = *100</td> <td>3 = *1000</td> </tr> </table> <p>This value is already absorbed into the fixed vertical gain (position 0), it serves only as a reminder here.</p>	0 = *1	1 = *10	2 = *100	3 = *1000						
0 = *1	1 = *10											
2 = *100	3 = *1000											
8	8-bit	<p>Bandwidth limit at acquisition.</p> <table border="0"> <tr> <td>0 = off</td> <td>1 = on</td> </tr> </table>	0 = off	1 = on								
0 = off	1 = on											
9	8-bit	<p>Time base at acquisition, coded as an integer.</p> <table border="0"> <tr> <td>4 = 2 nsec/div</td> <td>5 = 5 nsec/div</td> </tr> <tr> <td>6 = 10 nsec/div</td> <td>7 = 20 nsec/div</td> </tr> <tr> <td>.....</td> <td>34 = 20 sec/div</td> </tr> <tr> <td>35 = 50 sec/div</td> <td>36 = 100 sec/div</td> </tr> </table>	4 = 2 nsec/div	5 = 5 nsec/div	6 = 10 nsec/div	7 = 20 nsec/div	34 = 20 sec/div	35 = 50 sec/div	36 = 100 sec/div		
4 = 2 nsec/div	5 = 5 nsec/div											
6 = 10 nsec/div	7 = 20 nsec/div											
.....	34 = 20 sec/div											
35 = 50 sec/div	36 = 100 sec/div											

Pos	Size	Meaning
10	8-bit	<p>Sampling interval at acquisition, coded as an integer.</p> <p>In interleaved sampling,</p> <p>11 = .2 nsec 12 = .4 nsec</p> <p>13 = .8 nsec</p> <p>In non-interleaved sampling,</p> <p>16 = 10 nsec 17 = 20 nsec</p> <p>18 = 40 nsec 19 = 80 nsec</p> <p>20 = 200 nsec 21 = 400 nsec</p> <p> 34 = 8 msec</p> <p>35 = 20 msec 36 = 40 msec</p> <p>In addition to the intervals of the non-interleaved sampling, SEQNCE mode also uses</p> <p>40 = 100 nsec 41 = 1 µsec</p> <p>42 = 10 µsec 43 = 100 µsec</p> <p>44 = 1 msec 45 = 10 msec</p>
11	8-bit	<p>Record type</p> <p>0 = non-interleaved</p> <p>3 = interleaved with 25 sweeps at .8 nsec interval</p> <p>4 = interleaved with 50 sweeps at .4 nsec interval</p> <p>5 = interleaved with 100 sweeps at .2 nsec interval</p> <p>-3 = SEQNCE with 8 segments</p> <p>-4 = SEQNCE with 15 segments</p> <p>-5 = SEQNCE with 31 segments</p> <p>-6 = SEQNCE with 62 segments</p> <p>-7 = SEQNCE with 125 segments</p> <p>-8 = SEQNCE with 250 segments</p>
12	8-bit	<p>Trigger coupling at acquisition</p> <p>0 = DC 1 = HF REJ</p> <p>2 = LF REJ 3 = AC</p>
13	8-bit	<p>Trigger mode at acquisition</p> <p>0 = SINGLE 1 = NORM</p> <p>2 = AUTO 3 = SEQNCE</p>
14	8-bit	<p>Trigger source at acquisition</p> <p>0 = EXT/10 1 = EXT</p> <p>2 = LINE 3 = CHAN 2</p> <p>4 = CHAN 1</p>
15	8-bit	<p>Trigger slope at acquisition</p> <p>0 = negative 1 = positive</p> <p>2 = window</p>
16	16-bit	<p>Trigger level at acquisition</p> <p>The coding depends on the trigger slope and on the trigger source.</p>

Pos Size Meaning

Positive or negative trigger slope

Parameter		CHAN 1,2		EXT	
0	-	5.00 div	-	2.00	V
25	-	4.00 div	-	1.60	V
50	-	3.00 div	-	1.20	V
100	-	1.00 div	-	.40	V
125		0 div		0	V
150	+	1.00 div	+	.40	V
200	+	3.00 div	+	1.20	V
250	+	5.00 div	+	2.00	V

In EXT/10, the trigger voltages are multiplied by 10.

Window trigger

Parameter		CHAN 1,2		EXT	
<25	±	.50 div	±	.20	V
25	±	.50 div	±	.20	V
50	±	1.00 div	±	.40	V
100	±	2.00 div	±	.80	V
125	±	2.50 div	±	1.00	V
150	±	3.00 div	±	1.20	V
200	±	4.00 div	±	1.60	V
250	±	5.00 div	±	2.00	V

In EXT/10, the trigger voltages are multiplied by 10. Note that the window size is limited to ±.5 div (or ±.20 V), due to the nature of the trigger hardware.

- 18 32-bit Trigger delay at acquisition, in units of .02 of TIME/DIV, relative to the left hand side of the screen.
 500 = + 10 div, i.e. 100 % pre-trigger
 0 = 0 div, i.e. 0 % pre-trigger
 -50 = - 1 div, i.e. post-trigger of 1 TIME/DIV
 -500000 = -10000 div, i.e. maximum post-trigger of 10000 divisions
- 22 16-bit Number of measured data points per division, at the time of acquisition. This number is independent of whether the user reads all or a fraction of the data values, by specifying <intval> larger than 1 (See READ command).
- 24 16-bit Address of first measured data point, relative to the left-hand edge of the screen.
- 26 16-bit Address of last measured data point, relative to the left-hand edge of the screen.
- 28 16-bit Internal use.

Pos	Size	Meaning
30	16-bit	Internal use.
32	16-bit	Internal use.
34	8-bit	Data processing of this record 99 = no processing, raw data 0 = averaging 1 = extrema 2 = arithmetic 3 = functions 4 = smoothing
35	8-bit	Unused
36 - 149		Additional parameters, reserved for the description of the waveform processing (if any).

7.8 Format of Trigger Time(s)

The trigger time is the time interval between the occurrence of the trigger and the measurement of the next data sample. This time is always expressed in units of $2^{(-14)}$ of the nominal sampling interval, and spans integer values from 0 to $2^{(14)}-1 = 16383$. The transmission format is a 16-bit integer, with the most significant byte sent before the least significant byte.

In single-shot acquisition (INTERLEAVED OFF), there is a single time value.

In SEQNCE acquisition, there are as many trigger times as there are sweeps. The trigger times are transmitted in the order 1 to N, where N is the number of sweeps.

In INTERLEAVED acquisition, there are as many trigger times as there are interleaved sweeps making up the acquired trace:

- At 2 μ sec/div, there are 25 sweeps at a nominal interval of 800 psec.
- At 1 μ sec/div, there are 50 sweeps at a nominal interval of 400 psec.
- At 500 nsec/div and below, there are 100 sweeps at a nominal interval of 200 psec.

The times are transmitted in the order 0 to N-1, where N is the number of sweeps. Note that time i ($0 \leq i < N$) corresponds to the data points at address i, N + i, 2N + i, 3N + i, etc., i.e. to all data points of a single sweep.

In many data analyses, the trigger times may be ignored, especially if relative time measurements are made. In INTERLEAVED acquisition, however, ignoring the trigger times results in the interleaved sweeps being put on an equidistant timing grid, although they are not necessarily equidistant at acquisition. This is equivalent to introducing an acquisition jitter of up to 0.5 nominal sampling interval, i.e. degrading the (apparent) dynamic behavior of the ADC.

7.9 Data Addressing Conventions

Data values are always addressed in a screen-oriented manner. Address 0 always corresponds to the data value at the left hand edge of the display screen. Although the 9400A always digitizes 32000 points (except in interleaved sampling or in SEQNCE mode), it is not possible to display all of them on the screen, because of the ratio TIME/DIV to sampling interval. Points which are inaccessible on the screen are always positioned to the LEFT of the display screen, and can be read by remote control (using negative address values).

Examples:

- (a) At 0.5 msec/div, a sampling interval of 200 nsec is used, which covers a total time of $32000 * 200 \text{ nsec} = 6.4 \text{ msec}$. However, only $10 * 0.5 \text{ msec} = 5 \text{ msec}$ can be shown on the screen. Thus, only 25000 out of 32000 acquired points are shown. The other 7000 points cannot be displayed on the screen, but are accessible by remote control with the READ command (using negative addresses).

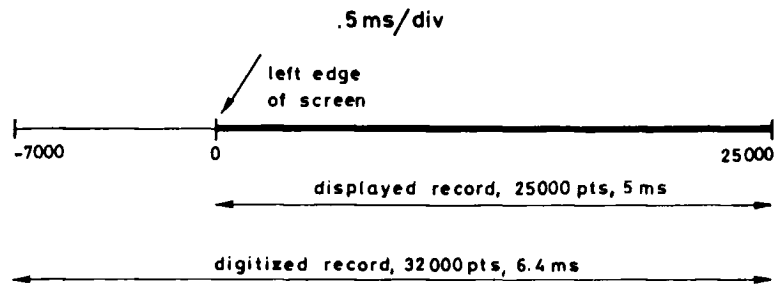

- (b) At 5 $\mu\text{sec/div}$, a sampling interval of 10 nsec is used, covering a total time of $32000 * 10 \text{ nsec} = 320 \mu\text{sec}$. However, only $10 * 5 \mu\text{sec} = 50 \mu\text{sec}$ can be shown on the screen at this time-base setting. Only 5000 out of 32000 acquired points are shown. The other 27000 values are not displayed, but are accessible by remote control.

5 μ s/div

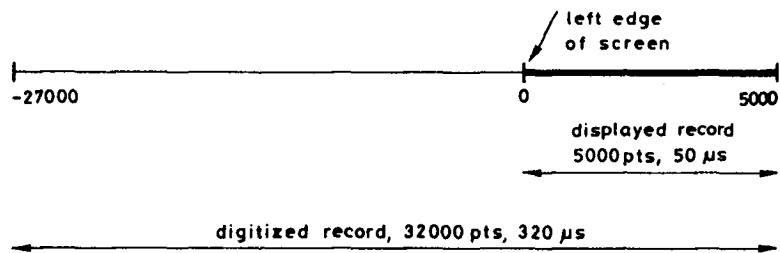

It is important to realize that at the fastest sampling rate of 10 nsec per point, a record always covers a time interval of 320 μ sec, regardless of the time base (which can range from 50 nsec/div to 20 μ sec/div). However, the trigger point is always interpreted relative to the left hand edge of the screen, i.e. relative to the address point 0 of the record.

Example:

Compare a time base of 20 μ sec/div to a time base of 1 μ sec/div, both with a pre-trigger of 10 percent, i.e. 1 division to the right of the left edge of the screen.

20 μ s/div

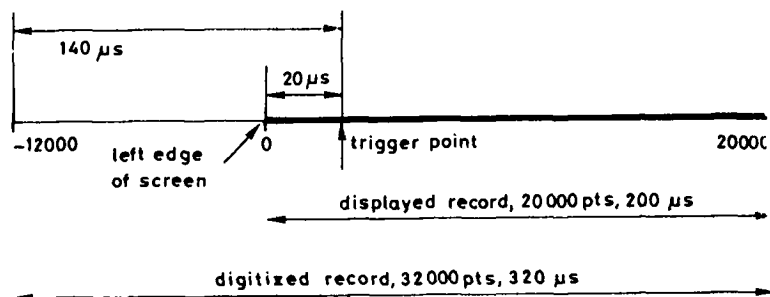

1 μ s/div

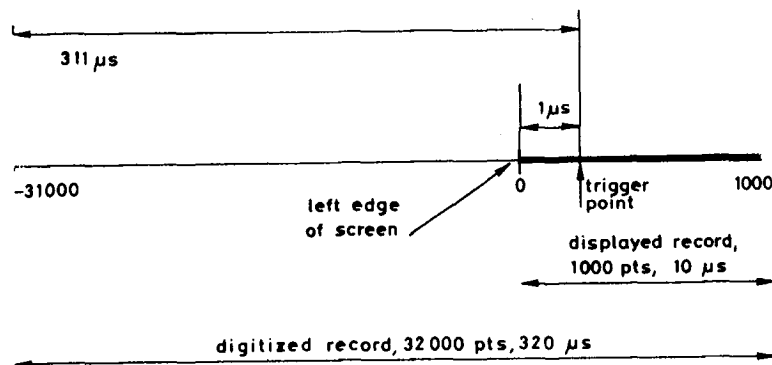

Remote Operations

In RIS, the 9400A digitizes 24000 data points (except: 24800 at 1 μ sec/div and 25000 at 2 μ sec/div; see Section 5.1.2). In this mode and in SEQNCE mode, it may happen that the memory is slightly too small to cover the entire screen. In this case, the waveform does not extend all the way to the left hand side of the display screen, and the address of the first valid data point of the record is a positive number. The principle is still maintained, that address 0 corresponds to the data point at the left edge of the screen, even if it refers to a virtual data point. This case occurs in interleaved sampling at 0.5 μ sec/div:

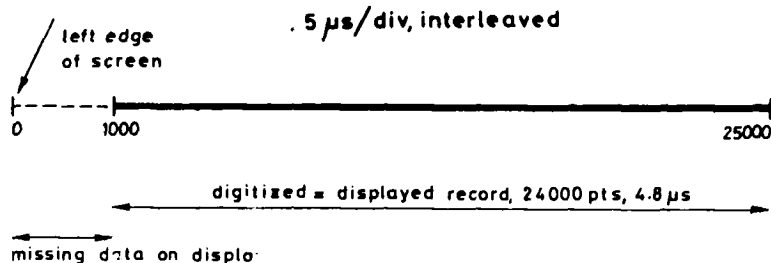

As the data-record limits depend on the time base and on the acquisition mode, the 9400A allows the user to read these address limits with the command "INSPECT xx.LIMIT". The response is a data block of 2 16-bit words, corresponding to the lowest and the highest address of the data record in question. If the user specifies larger limits than valid, the 9400A automatically replaces them with the legal ones (and sets the VALUE ADAPTED bit in the Main Status Byte STB 1).

7.10 Interpretation of Waveform Data Values

The conversion of the integer waveform data into volts requires the use of three scale and offset parameters found in the descriptor (see Section 7.7):

- Fixed gain, transmitted as an 8-bit BYTE at address 0 relative to the beginning of the descriptor. This coded value can be transformed into a number of VOLTS/DIV with a user-defined table. This transformed value is called 'gain' in the formula.
- Variable gain, transmitted as an 8-bit BYTE at address 1 relative to the beginning of the descriptor. This value is called 'vgain' in the formula below.
- Offset, transmitted as a 16-bit (signed) WORD at address 4 relative to the beginning of the descriptor. This value is called 'offset' in the formula below.

7.10.1 Waveform Data in 8-bit Format

This is the default format of all data records (if the Waveform Processing option is installed, it is possible to modify it to 16 bits with the command COMM FORMAT). The unsigned 8-bit "data" values in the numerical range 0....255 are transformed to volts as follows:

$$V = \text{gain} \left(\frac{\text{data} - 128}{32} - \frac{\text{offset} - 200}{25} \right) \left(\frac{200}{\text{vgain} + 80} \right)$$

- The first expression "(data - 128)/32" transforms the unsigned data value to a signed value, in units of vertical divisions.
- The second expression "(offset - 200)/25" translates the internal coding of the offset into a signed offset, units: vertical divisions.
- The third expression "200/(vgain + 80)" takes into account the variable gain. It reduces, to the value 1 when "vgain" assumes the "calibrated" value of 120.

Examples:

gain = 100 mV byte 0 of descriptor = 26
 offset = 200 no offset
 vgain = 120 calibrated gain

The formula reduces to

$$V = 100 \text{ mV} (\text{data} - 128)/32$$

data	volts
0	-400 mV
128	0 mV
129	3.12 mV
160	+100 mV
240	+350 mV
255	+396.88 mV

gain = 500 mV byte 0 of descriptor = 28
 offset = 250 offset = + 2 div
 vgain = 20 variable gain = .500 (equivalent to
 MULTIPLYING the
 vertical scale by 2)

The formula reduces to

$$V = 500 \text{ mV} ((\text{data} - 128)/32 - 2) * 2.0$$

data	volts
0	-6.0 V
64	-4.0 V
128	-2.0 V
192	0 V
193	31.25 mV
200	.25 V
240	1.5 V
255	1.969 V

7.10.2 Waveform Data in 16-bit Format

This format is only possible if the Waveform Processing option is installed. The 9400A must be set to this format with the command `COMM_FORMAT`. In this format, raw data, i.e. 8-bit ADC output, are represented in the most significant byte. The least significant byte consists of 8 bits of zeros. The unsigned 16-bit data values in the range 0 - 65535 are transformed into volts as follows:

$$V = \text{gain} * ((\text{data} - 32768)/8192 - (\text{offset} - 200)/25) * 200/(\text{vgain} + 80)$$

The terms are identical to those of Section 7.10.1, except that the factors of the first expression are multiplied by 256.

7.11 Use of the Service Request (SRQ) Interrupts

A Service Request (SRQ) is generated whenever the RQS bit of the Main Status Byte (STB 1) becomes 1. The user must demask the condition bits of interest in order to allow the generation of SRQ, e.g., to make the 9400A generate an interrupt upon the occurrence of an overload in either channel 1 or 2:

MASK 4,6 Sets the mask of the INTERNAL STATE byte (STB 4) to the binary value 00000110, i.e. it demasks the 2 overload bits. If an overload occurs, the mask now allows the propagation of the bit to the INTERNAL STATE CHANGE bit of the Main Status Byte (STB 1).

MASK 1,8 Sets the mask of the Main Status Byte (STB 1) to the binary value 00001000, i.e. it demasks the bit INTERNAL STATE CHANGE. This now allows the propagation of this bit to the RQS bit of STB 1. Note that the RQS bit need not be demasked; it always generates an SRQ when set.

7.11.1 Service Request in GPIB

The Service Request (SRQ) is a dedicated interrupt line on the GPIB bus. The handling of this interrupt is the responsibility of the user's GPIB driver on the host computer. The driver may allow the linking of a user-written service routine to the interrupt. The GPIB protocol allows an alternative way of reading the Main Status Byte (STB 1) through the Serial Poll. The execution of the serial poll is again a GPIB driver routine on the host computer. Normally, the value of STB1 is identical, whether it is read by Serial Poll or with the explicit read command "STB 1,?". A difference occurs, however, when more than one condition occurs that may set the RQS-bit:

- The Main Status Byte (STB 1), as read with "STB 1,?", keeps accumulating further bits as they get set.
- The Main Status Byte (STB 1), as read with the Serial Poll, only shows the bits that were set at the time the RQS was set. Any bits that should get set due to subsequent events are not taken into account (but are remembered), until a Serial Poll reads STB 1 and clears it; at this point in time, any remembered bit is set in STB 1 and may again generate an SRQ. The principle in Serial Poll is that SRQ may be generated by one event at a time.

Example:

- MASK 1,48 Sets the mask of the Main Status Byte (STB 1) to the binary value 00110000, allowing the ERROR bit or the OPERATION COMPLETE bit to generate an RQS bit, i.e. to generate a Service Request.
- MASK 5,4 Sets the mask of the OPERATION COMPLETE byte (STB 5) to the binary value 00000100, allowing the propagation of the "calibration done" bit to the OPERATION COMPLETE bit of STB 1.
- MASK 6,1 Sets the mask of the ERROR byte (STB 6) to a non-zero value, allowing the propagation of errors to the ERROR bit of STB 1.
- CAL Instructs the 9400A to calibrate itself. After approximately 500 msec, the 9400A sets the "calibration done" bit in the OPERATION COMPLETE byte (STB 5). Since this bit is demasked, it is propagated to the OPERATION COMPLETE bit of STB 1. And because this bit is also demasked, it sets the RQS bit and generates a Service Request interrupt on the GPIB bus.
- TRIG_LEVEL Instead of responding to the Service Request, the host computer sends this illegal command. It generates a semantic error and sets the ERROR byte (STB 6) to the value 40. Since this byte is demasked, the ERROR bit in STB 1 is also set, and because this bit is also demasked, it may set the RQS bit. However, the RQS bit is already set.

At this point, the host computer may choose to respond to the Service Request in either of the following ways:

If it responds with a Serial Poll, it will read the binary value 01010000, i.e. the RQS bit and the OPERATION COMPLETE bit. Upon execution of the Serial Poll, these two bits are reset in STB 1. However, the 9400A remembers that another bit, capable of setting RQS, was set, in this case the ERROR bit. Thus, it generates a second Service Request. When the host computer executes a second Serial Poll, it will read the binary value 01100000, i.e. the RQS bit and the ERROR bit. Upon execution of the second Serial Poll, STB 1 will be cleared completely. Thus, 2 different bits of STB 1 (when demasked) always generate two different Service Requests, provided that STB 1 is read by Serial Poll. This follows the principle that SRQ should be generated by one event (at the level of STB 1) at a time.

If the host computer responds by reading the status byte(s) with "STB 1,?" or "STB ?", it will read the binary value 01110000 in STB 1. The Main Status Byte (STB 1) is cleared, and no more Service Requests are generated. Thus, STB 1, when read explicitly, keeps accumulating other status bits, and there might be fewer Service Requests than events (at the level of STB 1).

Another Example:

MASK 1,32 Sets the mask of the Main Status Byte (STB 1) to the binary value 00100000, allowing the ERROR bit to generate an RQS bit, i.e. to generate a service request.

MASK 6,1 Sets the mask of the ERROR byte (STB 6) to a non-zero value, allowing the propagation of errors to the ERROR bit of STB 1.

TIME/DIV? This legal command generates a response message which can (and should) be read by the host computer. In addition, the MESSAGE READY bit is set in STB 1. Because this bit is not demasked it does not generate an SRQ. However, if STB 1 is now read explicitly or by Serial Poll, the binary value 10000000 (= 80 in hexadecimal) would be read.

AAA ? This illegal command generates a syntax error and sets the ERROR byte (STB 6) to the value 11. Simultaneously, the ERROR bit of STB 1 is set. Since this bit is demasked in STB 1, it sets the RQS bit and generates a service request SRQ.

CALL_HOST This command is illegal, since the required parameter is missing. It generates a semantic error and sets the ERROR byte (STB 6) to the value 40. This error should again be propagated to the ERROR bit of STB 1, but it cannot generate a service request, since it is still pending.

If the host computer executes a Serial Poll at this moment, the binary value 11100000 (= E0 in hexadecimal) is read, i.e. the MESSAGE READY bit from the previous command "TIME/DIV?" and the ERROR bit + RQS bit from the command "AAA?" are set. Upon the execution of the Serial Poll, these bits are reset. Since no DIFFERENT bit, capable of setting RQS, was generated in the intervening time, no more Service Requests are generated. If the host computer reads the ERROR byte (STB 6) with the command "STB 6,?", it will receive the value 40, corresponding to the second error. Thus, if several errors occur before the host computer responds, only the last error is retained by the 9400A.

7.11.2 Service Request in RS-232-C

The Service Request must be simulated on a RS-232-C connection, since it is not predefined. On the 9400A, the RS-232-C Service Request consists of 1 to 3 characters, followed by the RS-232-C version of <END> (as defined by the command RS_CONF in Section 7.6.10, default is CR), sent by the 9400A to the host computer. It is the responsibility of the programs on the host computer to recognize them. By default, they consist of 1 bell character (binary value 7).

Since transfers over RS-232-C can only be in ASCII, the bell character is rather easily recognized as a special message. Also, the user may redefine the SRQ characters to some other sequence with the command "RS SRQ". The Serial Poll does not exist on an RS-232-C connection either. The only way to get more information about the status of the 9400A, or the reasons for an "interrupt", is to read the value of STB 1 or the other status bytes.

Of course, the user always has the choice of working without any Service Requests by "polling" the Main Status Byte (STB 1) with the command "STB 1,?" (See Section 7.6.8).

Example:

- MASK 1,40 Sets the mask of the Main Status Byte (STB 1) to the binary value 00101000, allowing the ERROR bit or the INTERNAL STATE CHANGE to generate an RQS bit, i.e. to generate a service request.
- MASK 4,6 Sets the mask of the INTERNAL STATE byte (STB 4) to the binary value 00000110, i.e. it demasks the 2 overload bits. If an overload occurs, the mask now allows the propagation of the bit to the INTERNAL STATE CHANGE bit of STB 1.
- MASK 6,1 Sets the ERROR byte (STB 6) to a non-zero value, allowing the propagation of errors to the ERROR bit of STB 1.

- TIME/DIV ? This legal command generates a response message which should be read by the host computer. In addition, the MESSAGE READY bit is set in STB 1. Because this bit is not demasked, it does not generate a Service Request. However, if STB 1 were now read with "STB 1,?", the binary value 10000000 (= 80 in hexadecimal or = 128 in decimal) would be read, and this bit would be cleared.
- Overload 1 This event, internal to the 9400A (but due to too large a signal at input 1 with 50 Ω coupling), sets the OVERLOAD1 bit of STB 4. Since this bit is demasked, the INTERNAL STATE CHANGE bit of STB 1 is also set. And because this bit is also demasked, the RQS bit is set and the Service Request is generated. If set to the default string, it consists of sending 1 bell character (decimal 7), followed by the carriage return character (default value of <END>), via RS-232-C to the host computer.
- AAA ? This illegal command generates a syntax error, and sets the ERROR byte (STB 6) to the value 11. Since this byte is demasked, the ERROR bit in STB 1 is also set. And because this bit is also demasked, it should also set the RQS bit and generate a Service Request. However, it cannot since it is already pending.

If the host computer reads the Main Status byte with the command "STB 1,?" at this moment, it will read the binary value 11110000, coded as the decimal value 240 = 128+64+32+16. The Main Status Byte (STB 1) acts as an accumulator of all condition bits. Thus several bits are set. After reading STB 1, all bits will be cleared and no more Service Requests are generated until some new event occurs.

SECTION 8

BASIC 9400A WAVEFORM MEASUREMENTS AND OPERATING PROCEDURES

The purpose of this section is to provide the user with a concise overview of the wide range of measurement capabilities offered by the LeCroy 9400A. While you may already be familiar with traditional oscilloscope operation, this brief outline will help to acquaint you with the many powerful features of the 9400A.

NOTE

In the following section we have chosen to set all acquisition parameters from the Panel Status menu; however, it is not necessary to be in this menu to make front panel setting changes. In the majority of cases, viewing the Abridged Panel Status Field (IV) will provide all necessary indications.

8.1 Repetitive Signal Acquisition

I. Applying Probe Calibration Signal

- 1) Connect the P9010 probe connector to CHAN 1 input (21).
- 2) Connect the probe's grounding clip to lug (20) and touch the tip to lug (19).
- 3) In the Main Menu, press the Recall PANEL push button (5).
- 4) Recall the Default panel setup (9).
- 5) Return to the Main Menu by pressing the Return push button (10).
- 6) Call the Panel Status menu (2).
- 7) Set CHAN 1 Fixed VOLTS/DIV to 10 mV (27).
- 8) Adjust CHAN 1 VAR vernier (28) for a Total V/div of 13.0 mV.
- 9) Set CHAN 1 OFFSET to -50 mV (32).
- 10) Set CHAN 1 COUPLING to DC 1 M Ω
- 11) Adjust TRIGGER DELAY control (34) to 20.0% Pre.
- 12) Adjust TRIGGER LEVEL control (33) to .00 division.
- 13) Set TRIGGER COUPLING to AC (30).
- 14) Set TRIGGER SOURCE to CHAN 1 (23).
- 15) Set TRIGGER SLOPE to POS (25).
- 16) Set TRIGGER MODE to AUTO (29).
- 17) Set TIME/DIV control (36) to .5 msec.
- 18) Note that at this TIME/DIV setting, INTERLEAVED SAMPLING (RIS) is OFF.
- 19) Set BANDWIDTH LIMIT to OFF (50).

- 20) Return to the Main Menu by pressing the Return push button (10).
- 21) Set CHAN 1 to ON and CHAN 2 OFF (49).
- 22) Set DUAL GRID mode to OFF (14).

Resulting Display:

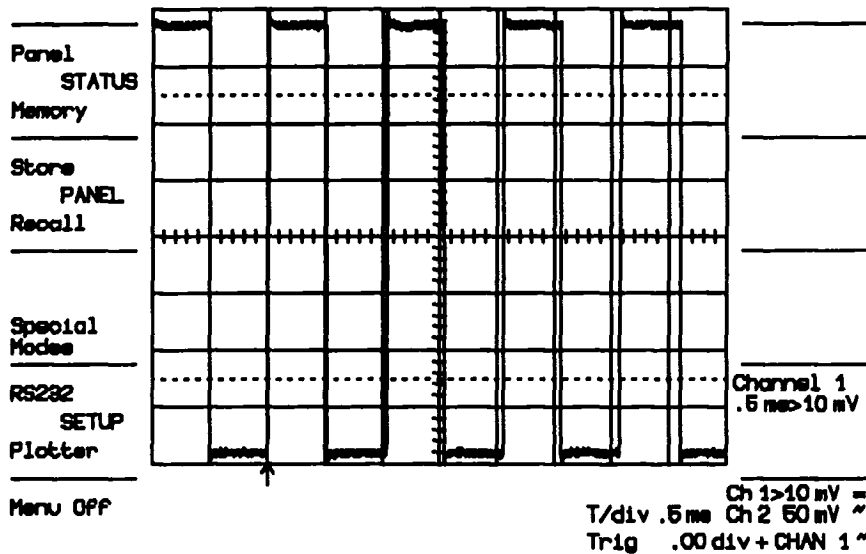

Figure 8.1

The P9010 probe has a $\times 10$ attenuation factor. Thus, the 1 V, 976 Hz output calibration signal is displayed with a total amplitude of approximately 7.7 divisions at a Total V/div setting of 130 mV. In case of over- or under-shoot, adjust the probe compensation trimmer, located on the barrel of the P9010, for a clean square wave contour.

II. Acquisition of a 10-20 nsec Repetitive Signal

- 1) Connect a fast pulse generator providing an output signal having a 10 to 20 nsec period to CHAN 2 input (21).
- 2) In the Main Menu, press the Recall PANEL push button (5).
- 3) Recall the Default panel setup (9).
- 4) Return to the Main Menu by pressing the Return push button (10).
- 5) Call the Panel Status menu (2).
- 6) Set CHAN 2 Fixed VOLTS/DIV as appropriate (27).
- 7) Set CHAN 2 OFFSET to .0 mV.
- 8) Set CHAN 2 COUPLING to DC 50 Ω
- 9) Adjust CHAN 2 VAR vernier (28) as appropriate.
- 10) Adjust TRIGGER DELAY control (34) to 40.0% Pre.
- 11) Adjust TRIGGER LEVEL control (33) to .00 division.
- 12) Set TRIGGER COUPLING to AC (30).

- 13) Set TRIGGER SOURCE to CHAN 2 (23).
- 14) Set TRIGGER SLOPE to POS (25).
- 15) Set TRIGGER MODE to NORM (29).
- 16) Set TIME/DIV control (36) to 5 nsec/div (36).
- 17) At this point INTERLEAVED SAMPLING (RIS) is ON.
- 18) Set BANDWIDTH LIMIT to OFF (50).
- 19) Return to the Main Menu by pressing the Return push button (10).
- 20) Set CHAN 2 to ON and CHAN 1 to OFF (49).
- 21) Set DUAL GRID mode to OFF (14).

Resulting Display:

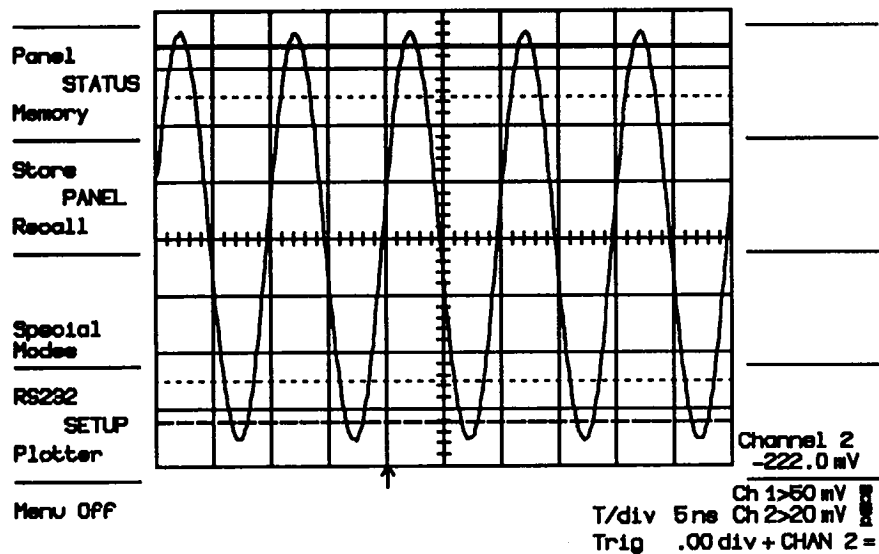

Figure 8.2

A waveform is displayed in the center of your screen. Signal acquisition is performed in the Random Interleaved Sampling mode.

8.2 Single Shot Acquisition

Acquisition of a single 100 nsec wide pulse.

In this case the pulse generator is not free-running. It must be in external or manual trigger, and set to provide a 100 nsec wide pulse with an amplitude of your choice.

- 1) Connect signal source to CHAN 1 input (21).
- 2) In the Main Menu, press the Recall PANEL push button (5).

- 3) Recall the Default panel setup (9).
- 4) Return to the Main Menu by pressing the Return push button (10).
- 5) Call the Panel Status menu (2).
- 6) Set CHAN 1 Fixed VOLTS/DIV as appropriate (27) to match the generator.
- 7) Adjust CHAN 1 VAR vernier (28) as appropriate to match the generator.
- 8) Set CHAN 1 OFFSET as appropriate.
- 9) Set CHAN 1 COUPLING to DC 50 Ω
- 10) Adjust TRIGGER DELAY control (34) to 20.0% Pre.
- 11) Adjust TRIGGER LEVEL control (33) to .00 division.
- 12) Set TRIGGER COUPLING to AC (30).
- 13) Set TRIGGER SOURCE to CHAN 1 (23).
- 14) Set TRIGGER SLOPE to POS (25).
- 15) Arm the trigger by setting the TRIGGER MODE (29) to single.
- 16) Set TIME/DIV control (36) to 50 nsec/div (36).
- 17) Set INTERLEAVED SAMPLING to OFF (37).
- 18) Set BANDWIDTH LIMIT to OFF (50).
- 19) Return to the Main Menu by pressing the Return push button (10).
- 20) Set CHAN 1 to ON and CHAN 2 to OFF (49).
- 21) Set DUAL GRID mode to OFF (14).
- 22) Now trigger the signal source.

Resulting Display:

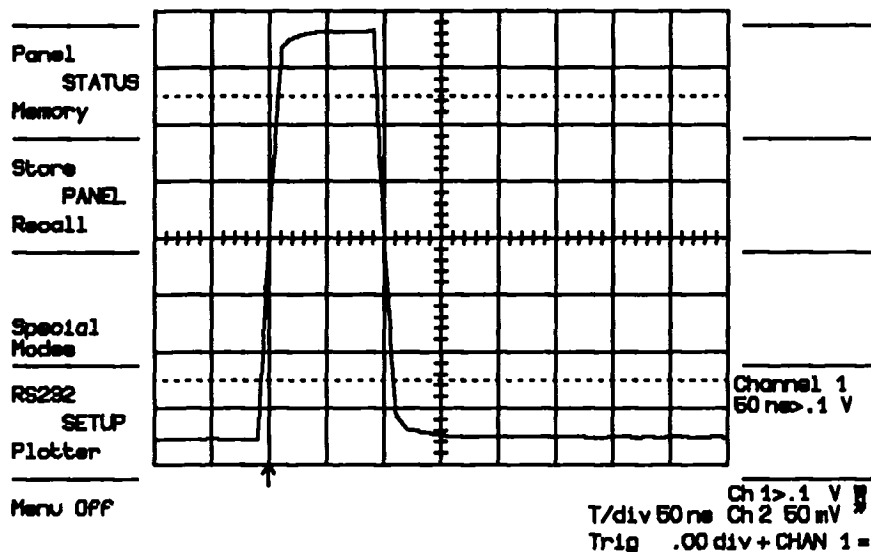

Figure 8.3

8.3 Trace Expansion - Expand A/B

Using the same 100 nsec signal and front panel settings described in Section 8.2, but with your pulse generator free-running this time, perform the following procedure:

- 1) Set push button (14) to DUAL GRID mode.
- 2) Press EXPAND A (46) in order to expand CHAN 1 trace.

If the source for signal expansion shown in the Displayed Trace field (V) is not X-Chan 1, you must perform the following procedure to redefine the expansion signal source to CHAN 1.

- a) Press the REDEFINE push button (45) to display the Redefine Source menu in the Menu Field (I).
- b) Press push button (1) in order to redefine CHAN 1 as the new source for the expanded (X-Chan 1) display.

At this point the new source for the expanded (X-Chan 1) line in the Displayed Trace Field (V) is updated to X-Chan 1 and all or a portion of CHAN 1 trace is intensified.

- 3) Turn the TIME MAGNIFIER control (43) to adjust the magnification factor (length of the intensified section) as desired (e.g. 5 nsec).
- 4) Displace the intensified section by adjusting Horizontal POSITION control (39) and position it on the risetime of your pulse.
- 5) Position the expanded trace in lower grid by adjusting the Vertical POSITION control (40).
- 6) Adjust VERT GAIN control (42) if required.

At this point the digitized points are clearly seen every 10 nsec.

- 7) Set INTERLEAVED SAMPLING to ON.

The equivalent sampling frequency is now 5 gigasamples/sec and the risetime of the pulse is very clearly defined.

Note: The procedure to follow for Expand B is identical to the above, except that in Step 2 the EXPAND B push button (46) is pressed rather than the EXPAND A push button.

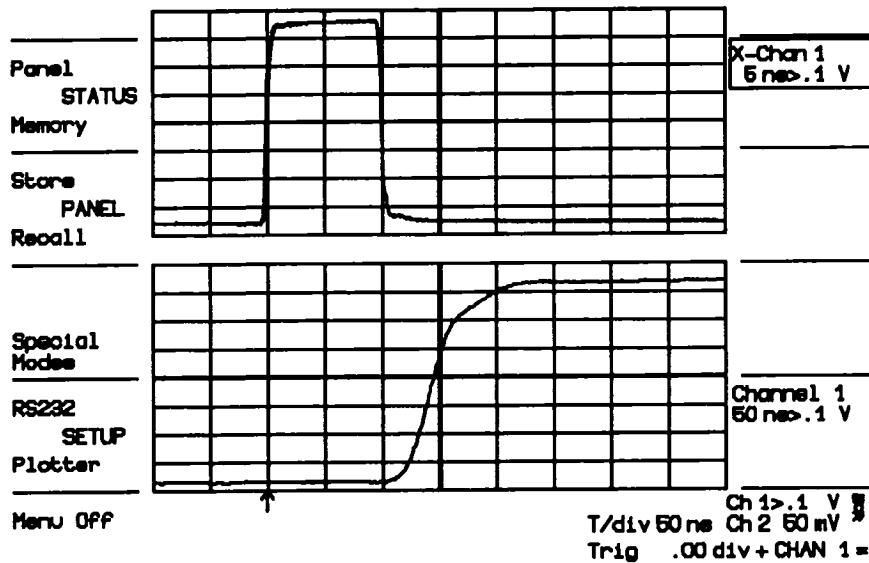

Figure 8.4

8.4 Sequential Recording of Single Events in Segmented Memory

I. 31 Segment Memory Partitioning

Using the same 100 nsec signal and front panel settings described in Section 8.2, and with your pulse generator in external or manual trigger, perform the following procedure:

- 1) Call the Panel Status menu by pressing push button (2).
- 2) Press **Modify # Segments** push button (4) as often as necessary to display the value 31 in the **# Segments for SEQNCE** line.
- 3) Set **RANDOM INTERLEAVED SAMPLING** to OFF.
- 4) Set the Time Base to .1 μ sec/division.
- 5) Select **SEQNCE** trigger mode (29).
- 6) Press the **Return** push button (10) to return to the main menu.
- 7) Set **DUAL GRID** (14) to ON.
- 8) Actuate your generator external trigger a total of 31 times in order to generate 31 signals to be recorded.

At this point a compacted trace of 31 segments is displayed in the upper grid. Trace expansions **EXPAND A** and **EXPAND B** must be used to display details of one or two selected segments.

- 9) Press **EXPAND A** (46) in order to expand CHAN 1.

If the source for signal expansion shown in the Displayed Trace field (V) is not X-Chan 1, you must redefine the expansion signal source to CHAN 1 (see Section 8.3).

- 10) Press EXPAND B (46) in order to expand a second portion (segment) of CHAN 1.
- 11) Select EXPAND B for display control by pressing the SELECT push button (44). Redefine EXPAND B to be an expansion of channel 1 if necessary.
- 12) Choose the segment of interest by adjusting Horizontal POSITION control (39). The number of the selected segment is displayed in the upper right corner of the Displayed Trace field.
- 13) Position the expanded trace in lower grid by adjusting the vertical POSITION control (40).
- 14) Select EXPAND A for display control.
- 15) Choose another segment of interest (39).

II. 125 Segment Memory Partitioning

To make a sequential recording of 125 single events, you need only modify the value displayed in the # Segments for SEQNC line of the Panel Status menu by pressing Modify # Segments push button (4) until the value 125 appears in the # Segments for SEQNC line.

Keeping all other settings as above, generate 125 triggers. The resulting display shows the same waveform but the number of digitized points per segment has changed from 1024 to 256.

Resulting display with 31 segments:

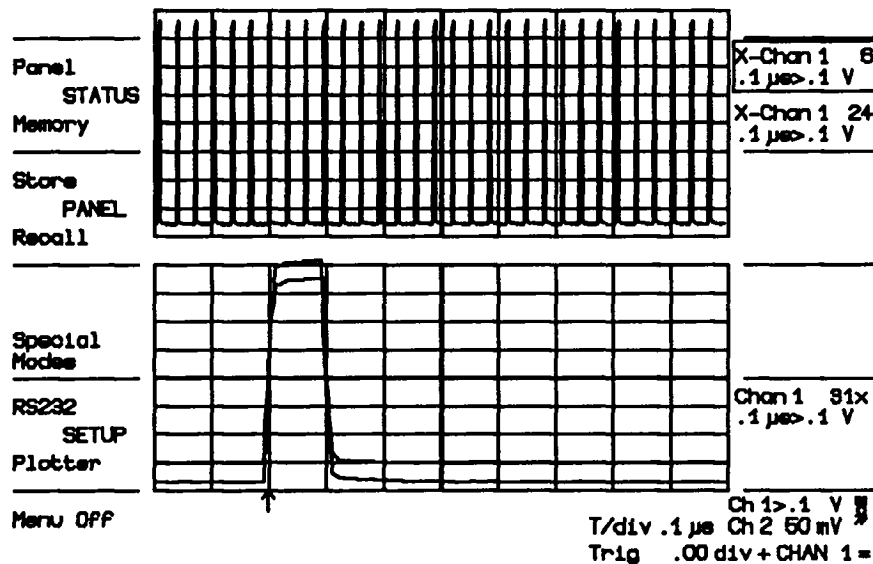

Figure 8.5

With 125 segments:

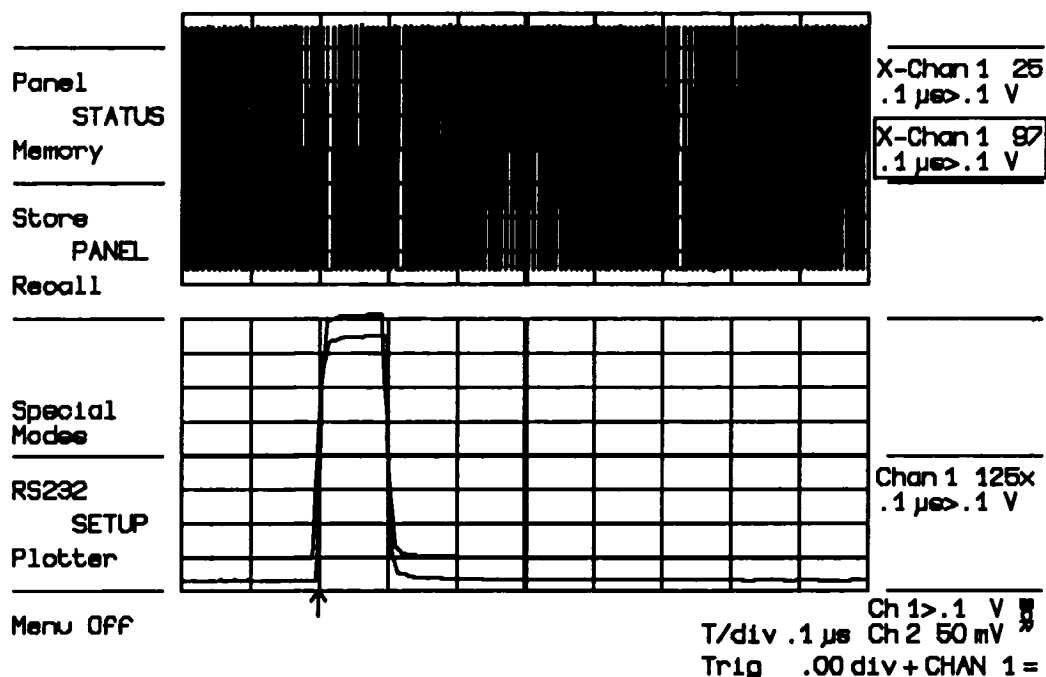

Figure 8.6

8.5 Slow Signal Recording

Acquisition of a 1 Hz sine wave signal.

- 1) Connect a 1 Hz signal source to CHAN 2 input connector (21).
- 2) Call the Panel Status menu by pressing push button (2).
- 3) Set CHAN 2 sensitivity to 1 V/div (27).
- 4) Adjust CHAN 2 OFFSET to .00 V (32).
- 5) Set CHAN 2 COUPLING (22) to DC 1 MΩ
- 6) Set the Time Base to 1 sec/div (36).
- 7) Set the TRIGGER SLOPE to POS (25).
- 8) Set the TRIGGER LEVEL to 1.00 div (33).
- 9) Set the TRIGGER DELAY to 50% Pre (34).
- 10) Set the TRIGGER MODE to NORM (29).
- 11) Set the TRIGGER SOURCE to CHAN 2 (23).
- 12) Press Return push button (10) to return to the Main Menu.
- 13) Set CHAN 1 to OFF and CHAN 2 to ON by pressing push button (49).
- 14) Set DUAL GRID mode to OFF (14).

Resulting Display:

A sine wave signal will be displayed, rolling from right to left across the screen. The display can be halted by pressing the SINGLE push button (29) when in NORMAL trigger mode. When in AUTO trigger mode, the display is halted upon receipt of an external trigger signal.

8.6 Window Triggering

Window triggering allows the user to capture signals exceeding the positive or negative limits set around the base line (in internal trigger) or ground (in external trigger) with the **TRIGGER LEVEL** control (33).

Using the same basic acquisition parameters and signal used in Section 8.5, it is possible to halt the rolling signal by increasing its amplitude until it crosses the positive or negative "window" which defines the trigger conditions.

Procedure:

- 1) Set the **TRIGGER SLOPE** push button (25) to POS/NEG. (Both the POS and NEG LEDs will light up when push button (25) has been pressed the correct number of times).
- 2) Set the **COUPLING MODE** push button (30) to the AUTO Trigger Mode.
- 3) Adjust the **CHAN 2 OFFSET** control (32) in order to center the sine wave display at mid-screen.
- 4) Select a trigger "window" just beyond the positive or negative half cycle of the currently displayed sine wave by adjusting the **TRIGGER LEVEL** control (33) to approximately ± 3.0 divisions.

Note that when Window Triggering has been selected via push button (25), a corresponding message is displayed below the bottom graticule line on the right-hand portion of the screen in the abridged Panel Status field. This field enables you to adjust the positive/negative trigger window desired without having to call the Panel Status menu.

- 5) Gradually increase the amplitude of the output signal from your signal generator until the positive and negative half-cycle of the displayed sine wave exceeds 3.0 divisions with reference to the zero base line.

Resulting Display:

Rolling will cease when the rolling waveform reaches ± 3 divisions in amplitude.

8.7 Storing and Recalling Front Panel Setups

Storing repetitive signals.

- 1) Follow the same procedure as in Section 8.1 applying the probe calibrator signal.
- 2) Press the **STORE PANEL** (4) push button.

At this point the listing of 7 possible front panel storage locations appears in the MENU FIELD.

- 3) Press the push button adjacent to the storage location you have selected (e.g. 2).

All the front panel settings are now stored.

- 4) Set CHAN 1 Fixed VOLTS/DIV to 20 mV (28) and TIME/DIV (36) to .2 msec.

Your display is now half the amplitude and the sweep speed 2.5 times faster.

- 5) Press the STORE PANEL push button (4).
- 6) Press push button 3 to store the new panel settings.
- 7) Press the RECALL PANEL (5) push button.
- 8) Press push button 2.

At this point the first setting stored is recalled with the corresponding display.

Pressing push button (3) will recall the second setup.

8.8 Signal Storage in Memories C, D

I. Storage of CHAN 1 Waveform into Memory C

Apply the same signal as in Section 8.1-I, and recall the front panel setup by pressing push buttons (5) and (2) in that order.

Procedure:

- 1) Stop acquisition by setting the TRIGGER MODE (29) to single.
- 2) Press STORE push button (1) to call the Store Trace menu.
- 3) Store CHAN 1 into Memory C (2).
- 4) Set CHAN 1 to OFF by pressing push button (49).
- 5) Set MEMORY C to ON by pressing push button (47).

II. Storage of CHAN 2 Waveform into Memory D

Apply a second signal, as in Section 8.3, from your pulse generator to CHAN 2 BNC connector (21).

Procedure:

- 1) Press STORE push button (1) to call the Store Trace menu.
- 2) Store CHAN 2 into Memory D (5).

- 3) Set CHAN 2 to OFF (49).
- 4) Set MEMORY D to ON (47).
- 5) Set DUAL GRID to ON by pressing push button (14).
- 6) Select Memory D by pressing **SELECT** push button (44).
- 7) Adjust **VERT GAIN** control (42) and **Vertical POSITION** control (40) to center the trace.

The above procedure enables two independent waveforms to be simultaneously stored and displayed. Calling the Memory Status menu (3) enables the user to review all the acquisition parameters.

Note that instead of storing the currently acquired CHAN 1 waveform into Memory C and CHAN 2 waveform into Memory D, the Store Trace menu also allows the user to inverse this configuration, and to store the CHAN 1 waveform into Memory D and the CHAN 2 waveform into Memory C.

8.9 Redefinition Function - Expand Memories C, D

As mentioned in Section (5.2.4), the default signal sources for Expand A and B are CHAN 1 and 2, respectively. It is possible, however, to expand a waveform stored in reference Memories C and/or D by redefining these memories to be the new signal expansion source.

I. Expansion of MEMORY C with EXPAND A

Just as Expand A and B enabled the user to expand the signals contained in CHAN 1 and 2 (Section 8.3), the signals in reference Memories C and/or D can be expanded as described below.

Procedure:

- 1) Store the signal into Memory C as described in Section 8.8.
- 2) Press **EXPAND A** push button (46).
- 3) Use the **Vertical POSITION** knob to separate the traces on the screen.
- 4) Set **CHAN 1** to ON.
- 5) Press **SELECT** push button (44) to frame the X-Chan 1 message.
- 6) Press **REDEFINE** push button (45).
- 7) Press push button (4) to define Memory C as the new signal source for Expand A.

From this step on, the procedure to follow is identical to that described in Section 8.3 for CHAN 1, 2 expansion (steps 3 through 6).

II. Expansion of Memory D with Expand B

The procedure used here is identical to that detailed above, except that Expand B is substituted for Expand A in Step 1, and Memory D is redefined as the new source for expansion (Step 4).

It is possible while studying these reference waveforms to simultaneously acquire signals via the CHAN 1 and CHAN 2 acquisition memories in real time. Note that you cannot display more than 4 traces on the 9400A's screen at any time.

8.10 Auto-store in Memory C, D

As mentioned in Section 5.2.5, pressing the **Special Modes** push button (7) permits the user to automatically store the current CHAN 1 and/or CHAN 2 display into the unit's two 32K reference memories following acquisition of each waveform.

The Auto-store mode is particularly useful whenever the user wishes to acquire single events in the Normal trigger mode appearing at intervals > 2 sec. (As explained in Section 5.2.5, in the Normal trigger mode the trigger circuit automatically re-arms after 2 sec, causing the currently stored waveform to be erased from memory).

pressing the **Modify Auto-store** push button (2) once causes the waveform currently contained in the 9400A's CHAN 1 acquisition memory to be stored automatically into Memory C. Continue pressing the **Modify Auto-store** push button (2) to see all the possibilities:

CHAN 1 into Memory C
CHAN 1 into Memory D
CHAN 2 into Memory C
CHAN 2 into Memory D
CHAN 1 into Memory C and CHAN 2 into Memory D.

Auto-store in Memory C

Procedure:

- 1) Using the same signal as in measurement example 8.2, set **TRIGGER MODE** push button (29) to NORM rather than SINGLE (HOLD).
- 2) With the Main Menu displayed on the CRT, press the **Special Modes** push button (7).
- 3) Press **Modify Auto-store** push button (2) once in order to cause the signal input to CHAN 1 to be automatically stored into Memory C with each new trigger cycle.
- 4) Return to the Main Menu by pressing **Return** push button (10).
- 5) Call Memory C by pressing **MEMORY C** push button (47).
- 6) Trigger the signal source.

Note that Memory C contains an exact copy of the most recent waveform stored in CHAN 1. The display of CHAN 1 waveform disappears about 2 seconds after a valid trigger is detected.

8.11 Common Expand Mode

Sections 8.3 and 8.8 describe the expansion of displayed traces independently, in order to provide a magnified version of a portion of the waveform currently in CHAN 1, CHAN 2 or those stored in reference Memories C or D. However, in certain applications it is convenient to be able to move the intensified region along two traces simultaneously.

Procedure:

- 1) Using the same front panel setup and the 100 nsec signal described in Section 8.2, connect one of the outputs of your pulse generator to the CHAN 1 input connector (21).
- 2) Connect a second output of your pulse generator to the CHAN 2 input connector (21).
- 3) With the Main Menu displayed on the left-hand side of the CRT, press push button (7) to call the **Special Modes** menu.
- 4) Press **Modify Common Expand** push button (4) to set the oscilloscope to the Common Expand mode.
- 5) Return to the Main Menu by pressing **Return** (10).
- 6) Press **DUAL GRID** (14).
- 7) Press **EXPAND A** and **EXPAND B** (46).
- 8) Press **RESET** (41), to synchronize the intensified sections along the CHAN 1 and 2 trace.

Note that at this point two sets of overlapping traces will be displayed on the screen. Separate CHAN 1 and CHAN 2 by adjusting the CHAN 1 or 2 **OFFSET** controls (32).

Separate expanded traces A and B by first selecting the X-CHAN 1, push button (44), and then adjusting **Vertical POSITION** control (40). To ensure easy display readability repeat this step, if necessary, selecting X-CHAN 2 instead of X-CHAN 1, with the **SELECT** push button (44).

In the Common Expand mode, only the **Horizontal POSITION** control (39) and the **TIME MAGNIFIER** control (43) act simultaneously on both the Expand A and B signal source, while the **VERT GAIN** control (42) and the **Vertical POSITION** control (40) act independently on each expanded waveform.

When input signals to the 9400A are to be observed at different points in time, it is possible to independently adjust the time difference between the two intensified regions prior to calling the Common Expand mode.

When the Common Expand mode is subsequently called by pressing push buttons (7) and (4) in that order, the intensified regions for the two expansion sources may then be magnified by means of the **TIME MAGNIFIER** control (43) and moved horizontally at a fixed time interval by means of the **Horizontal POSITION** control (39).

The time cursors may be called by pressing push button (17) for high-precision measurement of the time interval between the two displayed regions.

Note that at any time the user may eliminate the time interval separating the intensified regions by pressing **RESET** push button (41).

8.12 Remote Control Via the RS-232-C Port

The 9400A has been designed to permit control of all of the scope's functions by means of a computer/terminal. For a complete listing of the various commands used to program the 9400A see Section 7.6.

The following examples are given to present the 9400A's remote control from a computer. To disable the character echoing from the 9400A issue the following command:

<ESC> [

Preliminary Hardware Setup:

- 1) Set the thumbwheel switch (54) on the rear panel of the 9400A to a value greater than 31.
- 2) Power up the 9400A.
- 3) Connect a computer through an RS-232-C cable to the Remote port connector (56) on the rear panel of the 9400A.
- 4) Call the RS-232-C menu by pressing push button (8). Then match the data transfer speed and character formats of the computer and oscilloscope (See Section 5.2.6).

I. Remote Operation in the Interrogation Mode

Programming Example: Terminal Display of Current Time Base Setting.

Programming Procedure:

- 1) Using any combination of upper or lower case characters, enter the letters TD on your keyboard, followed by a space, comma or by the equal sign, followed by a question mark, followed by <CR> as follows:

TD ? <CR>

Resulting Display:

Immediately upon execution of the above sequence you will see the 9400A's current time base setting displayed on your terminal, e.g.:

TIME/DIV 100 S

II. Remote Operation in the Control Mode

To modify the currently selected oscilloscope parameters, the user must first set the 9400A to remote use. This is done by entering <ESC>R (i.e. the character <ESC> followed by upper case "R").

Programming Example: Set the Time Base to 2 msec.

Programming Procedure:

- 1) Enter TD 2MS <CR> (upper or lower case characters). Other possible character formats are:

TIME/DIV 2 MS <CR>	(upper or lower case characters)
TD 2E-3 <CR>	(upper or lower case characters)
TD .002 <CR>	(upper or lower case characters)

Resulting Display:

Observe the Abridged Panel Status field in the lower right-hand portion of the screen while the above character sequence is entered via the terminal keyboard. When (<CR> is pressed, you will see the currently displayed time base setting change to 2 msec.

In order to return the 9400A to Local use, type <ESC>L (i.e. the character <ESC> followed by upper case "L"), at which point you will be returned to the 9400A's initial menu (i.e. the menu which appears at unit power up).

III. Example of a Typical Program

A short BASICA interactive program showing how to initialize communication between a 9400A and an IBM PC-AT is given below:

```
100 'SAMPLE PROGRAM FOR LINKING THE LECROY 9400A DSO TO AN IBM PC-AT'
105 'VIA THE RS232C ASYNCHRONOUS COMMUNICATIONS INTERFACE'
110 '
115 'AUTHOR : M. SCHUMACHER
120 '
125 CLS: ON ERROR GOTO 575
130 TRUE = 1: FALSE = 0: LOOP = TRUE: EXIT = FALSE: ECHO = TRUE: STORE =FALSE
135 CPRM$="%"
140 '
145 OPEN "COM1:9600,N,8,1" AS #1
150 OPEN "SCRN:" FOR OUTPUT AS #2
155 PRINT #2,"SAMPLE INTERACTIVE PROGRAM FOR LINKING THE LECROY 9400A DSO TO AN"
160 PRINT #2,"IBM PC-AT VIA THE RS232C ASYNCHRONOUS COMMUNICATIONS INTERFACE"
165 PRINT #2, "":PRINT #2, "Settings : 9600 Bd, no parity, 8 bits, 1 stop bit"
170 PRINT #2, "": PRINT #2, "Commands : " : X$=STRING$(15,32)
175 PRINT #2, X$"REM   : Remote,      LOC   : Local"
180 PRINT #2, X$"STORE : Store to disk, RECALL : Retrieve from disk"
185 PRINT #2, X$"Any valid command described in the User's Manual"
190 PRINT #1, CHR$(27);"["
195 PRINT #1, "CHLP PPO"
200 PRINT #1, "CTRL OFF"
205 PRINT #1, "CFMT,L,BYTE,UNSIGNED_SHORT"
210 PRINT #1, "CBLS 70"
215 PRINT #1, "MASK 6,1" 'Enable STB 1
220 PRINT #1, "RS_CONF 6,13,0,0,0" '<ACK>,<CR>
225 PRINT #1, "CPRM "+CHR$(34)+CPRM$+CHR$(34)
230 '
235 WHILE LOOP
240   PRINT #2,""
245   LINE INPUT "Enter command (EX --> exit) : ", C$
250   IF LEN(C$) < 2 THEN 245
255   IF C$ = "EX" THEN LOOP=FALSE: GOTO 285
260   IF C$ = "REM" THEN C$ = CHR$(27)+"R"
265   IF C$ = "LOC" THEN C$ = CHR$(27)+"L"
270   IF C$ = "STORE" THEN GOSUB 380: GOTO 285
275   IF C$ = "RECALL" THEN GOSUB 460: GOTO 285
280   IF C$<>" " THEN PRINT #1,C$: GOSUB 300
285 WEND
290 CLOSE
295 SYSTEM
300 '
305 'SUBROUTINE GET_STRING_FROM_DSO
310 '
315 ON TIMER(2) GOSUB 595: TIMER ON
320 CYCLE=TRUE
325 WHILE CYCLE
330   PRINT #1,CHR$(6);
```

```

335 IF EOF(1) THEN 335
340 TIMER STOP
345 A$ = INPUT$(LOC(1),#1) : C$=MID$(A$,1,LEN(A$))
350 L=INSTR(C$,CPRM$): IF L>0 THEN L=L-1: C$=MID$(A$,1,L): CYCLE=FALSE
355 IF ECHO THEN PRINT #2,C$;
360 IF STORE THEN FOR I=1 TO LEN(C$): PRINT #3, MID$(C$,I,1); : NEXT I
365 WEND
370 TIMER OFF
375 RETURN
380 '
385 'SUBROUTINE OPEN_DISK_FILE
390 '
395 CLOSE #3
400 LINE INPUT "Specify dir and disk file name : ",A$
405 OPEN A$ FOR OUTPUT AS #3
410 STORE=TRUE
415 LINE INPUT "Enter READ command (A --> abort) : ", C$
420 IF C$="A" THEN 450
425 IF INSTR(C$,"R")<>1 THEN PRINT #2,"Wrong syntax" : GOTO 450 ELSE PRINT #3,C$:
    PRINT #1,C$
430 L=INSTR(C$,"."): IF L=0 THEN PRINT #3,"" ELSE PRINT #3,MID$(C$,L)
435 LINE INPUT "Echo data to screen (Y/N) : ",A$
440 IF A$="N" THEN ECHO=FALSE: PRINT #2,"Uploading ..." ELSE ECHO=TRUE
445 GOSUB 300
450 STORE=FALSE: ECHO=TRUE: CLOSE #3
455 RETURN
460 '
465 'SUBROUTINE READ_DISK_FILE
470 '
475 CLOSE #3
480 LINE INPUT "Specify dir. and disk file name : ",A$
485 OPEN A$ FOR INPUT AS #3
490 A$=CHR$(27)+"R": PRINT #1,A$
495 LINE INPUT "Specify target memory (C/D) : ",B$: IF B$<>"D" THEN B$="C"
500 LINE INPUT #3,C$: PRINT #2,"Read command was :";C$
505 LINE INPUT #3,C$
510 A$="WT M"+B$+C$+CHR$(13): PRINT #1,A$;
515 LINE INPUT "Echo data to screen (Y/N) : ",A$
520 IF A$="N" THEN ECHO=FALSE: PRINT #2,"Downloading ..." ELSE ECHO=TRUE
525 WHILE NOT EOF(3)
530 A$=INPUT$(1,#3)
535 IF ECHO THEN PRINT #2,A$;
540 PRINT #1,A$;
545 WEND
550 CLOSE #3
555 GOSUB 300
560 A$=CHR$(27)+"L": PRINT #1,A$: GOSUB 300
565 ECHO=TRUE
570 RETURN
575 '
580 'DOS ERROR AND TIMEOUT HANDLER
585 '
590 PRINT #2, "Error no. "; ERR: GOTO 235
595 PRINT #2, "Timeout": TIMER OFF: GOTO 235

```

Basic 9400A Waveform Measurements
and Operating Procedures

8.13 Remote Control Via GPIB (Option OP02 only)

If the 9400A has been equipped with option OP02, it is also possible to control the various functions of the 9400A via the General Purpose Interface Bus (GPIB).

Example: Set the Time Base to 1 msec.

This example is given to present the different steps necessary to use a GPIB bus. Note that most languages offer high-level routines that perform these steps automatically.

In this example an IBM PC, or compatible computer equipped with a National Instruments GPIB PC2 or PC2A GPIB adapter and National Instruments IBIC^R program (default settings are selected), is used.

Preliminary Hardware Setup:

- 1) Before powering up the 9400A, select GPIB operation by setting the thumbwheel address switch (54) to 4.
- 2) Connect a GPIB cable to the 9400A's rear panel GPIB connector (55) and to the GPIB connector of the PC.

Note that upon system initialization, the PC must be at address 0.

- 3) In the Handler default configuration and with the prompt A> displayed on your PC's CRT, enter:

IBIC <CR> (upper or lower case letters)

The following message will be displayed on your CRT:

```
National Instruments
Interface Bus Interactive Control Program (IBIC Rev C.0)
Copyright (C) 1984 National Instruments, Inc.
All rights reserved
```

In the following description the commands which must be sent are in upper case letters. Answers or comments are in lower case. Each command must be followed by <CR>.

4) Enter IBFIND GPIB0 (in upper or lower case), at which point the following program will be executed:

Meaning:

IBSIC Status Message Returned	PC acts as controller
IBTMO 12 Status Message Returned	3 sec time-out
IBEOT 1 Status Message Returned	PC automatically enables <EOI> line on final character of message
IBSRE 1 Status Message Returned	Enable Remote 9400A operation
IBCMD "?_@\$" Status Message Returned	PC Talker; 9400A Listener 9400A enters REMOTE
IBWRT "TD 1MS;TD ?" Status Message Returned	TIME/DIV set to 1 msec; read current value
IBCMD "?_D" Status Message Returned	PC Listener; 9400A Talker
IBRD 120 Status Message Returned	PC to read ≤ 120 characters and stop when it encounters <EOI>

At this point the following message will be displayed
(with corresponding Hexadecimal ASCII codes to the left):

54 44 20 31 2E 30 30 45	T D 1 . 0 0 E
2D 30 33 20 53 0D 0A	- 0 3 S

IBONL Status Message Returned	Disconnect PC from GPIB; set 9400A to Local operation
----------------------------------	--

E	Exit IBIC program
---	-------------------

8.14 Making a Plot when the Computer, the 9400A, and the Plotter are all Connected Together on a GPIB Bus (Option OP02 only)

In this configuration, the computer controls the GPIB bus and the devices that are on the bus, such as the 9400A and the plotter. The 9400A cannot directly send plot data to the plotter even when it is in LOCAL. It is the task of the computer to organize the data transfer. The following sequence should be followed.

Basic 9400A Waveform Measurements
and Operating Procedures

- 1) The computer sets the 9400A into REMOTE.
- 2) The computer sets itself to Talker and the 9400A to Listener and sends the command:
 "SCREEN_DUMP"
- 3) The computer organizes the transfer between the 9400A and the plotter in one of the ways described below. The choice depends on the computer GPIB controller software.

The computer tells the 9400A to talk and the plotter to listen. It puts itself in Standby Mode while waiting for EOI that will be set by the 9400A when the plot is finished.

or

The computer tells the 9400A to talk and the plotter to listen. It puts itself in Listener mode while reading but NOT while storing the plot data.

or

The computer tells the 9400A to talk and sets itself to Listener. It reads AND stores the plot data. Afterwards it sets itself to Talker and tells the plotter to Listen and sends the stored data to the plotter.

Notice that a larger amount of data has to be stored: up to 50 kilobytes if all the traces are on.

- 4) The computer terminates the transfer by sending UNT (UNTalk) and UNL (UNListen) and setting the 9400A into LOCAL.

8.15 Configuring the Parallel Polling (Option OP02 only)

Send the following sequence of GPIB commands to the 9400A:

- listen address of the 9400A.
- PPC (Parallel Poll Configure).
- PPE (Parallel Poll Enable).
 in binary : 0 1 1 0 S P3 P2 P1
 Where P3 to P1 represents DIO line number - 1
 S = 1 if 1 must be sent while Service Request is active.
 = 0 otherwise.
- UNT (UNTalk) and UNL (UNLlisten) non obligatory.

To "unconfigure" the parallel polling, send the following sequence of GPIB commands to the 9400A:

- Listen address of the 9400A.
- PPD (Parallel Poll Disable).
in binary : 0 1 1 1 S P3 P2 P1
as mentioned above.
- PPU (Parallel Poll Unconfigure).
- UNT or UNL non obligatory.

Other sequences of commands are also possible.



SECTION 9

GETTING THE MOST OUT OF YOUR 9400A

The 9400A is a highly accurate digital oscilloscope which achieves optimum precision when handled properly.

The purpose of this section is to familiarize the user with operations and functional hints that will ensure the best possible operation of the instrument.

9.1 Front Panel Controls

All front panel controls are fully remotely controllable and are therefore constantly monitored by the 9400A's internal processor.

Any action performed on the front panel is detected by the processor and the requested changes are implemented very rapidly.

During data acquisition (measurement of input signals), the internal processor is also busy with the data-taking controls, calculations and display generation. Under certain conditions, (e.g. RIS mode or slow time base), the response time of the front panel controls increases. When for example, the user tries to move a trace up or down on the screen, it tends to move with a jumping motion.

Whenever slow response to the control knobs is noticed, set the trigger mode to SINGLE. Acquisition is stopped, the display of the waveform is frozen and the response time of control knobs returns to normal. Once waveform manipulations are done, return to NORMAL or AUTO trigger.

9.2 Accurate Amplitude Measurements

The 9400A digitizers are 8-bit analog-to-digital converters that measure the amplitude of input signals by subdividing them into 256 levels.

You can ensure maximum measurement accuracy by using the full dynamic range of the converters, i.e. using input signals close to full scale. Half-scale signals are in 128 levels only, reducing measurement accuracy by a factor of two.

To facilitate the adjustment of a full-scale ADC signal, the 9400A display has been designed to represent the zero level of the ADC as the bottom line of the grid. Full scale, level 256, is represented by the top line of the grid.

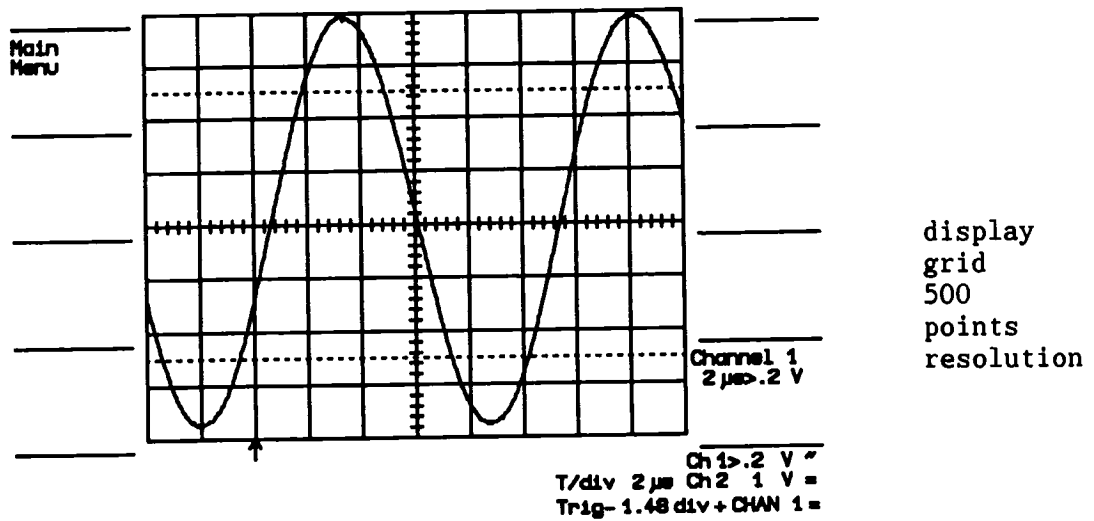

Figure 9.1

To make the best use of the ADC's dynamic range, and therefore the most accurate amplitude measurements, the displayed signal should completely fill the display grid.

The fully calibrated and continuously adjustable input-signal conditioning permits you to meet this requirement easily without loss of calibration.

As an overlapping display of two full scale waveforms could become quite confusing, the 9400A provides a dual grid option to be used in applications where both channels are used simultaneously.

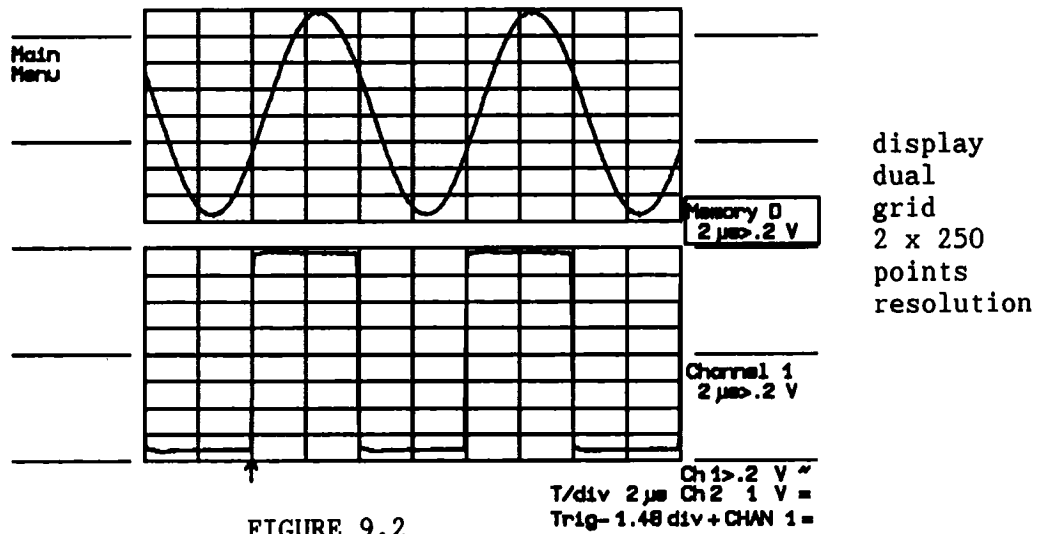

FIGURE 9.2

9.3 Accurate Time Measurements

Two deep acquisition memories, each storing 32000 points, provide the unprecedented time resolution of the 9400A.

In order to match the time base settings, a maximum of 25000 digitized points are displayed on the screen with a resolution of 500 display points. A compacting algorithm showing all minimum and maximum values ensures that no information is lost in the display of a trace.

Time cursors can be positioned accurately on any one of the 500 display points of a compacted trace. The corresponding measurement accuracy is $1/500$ or 0.2%.

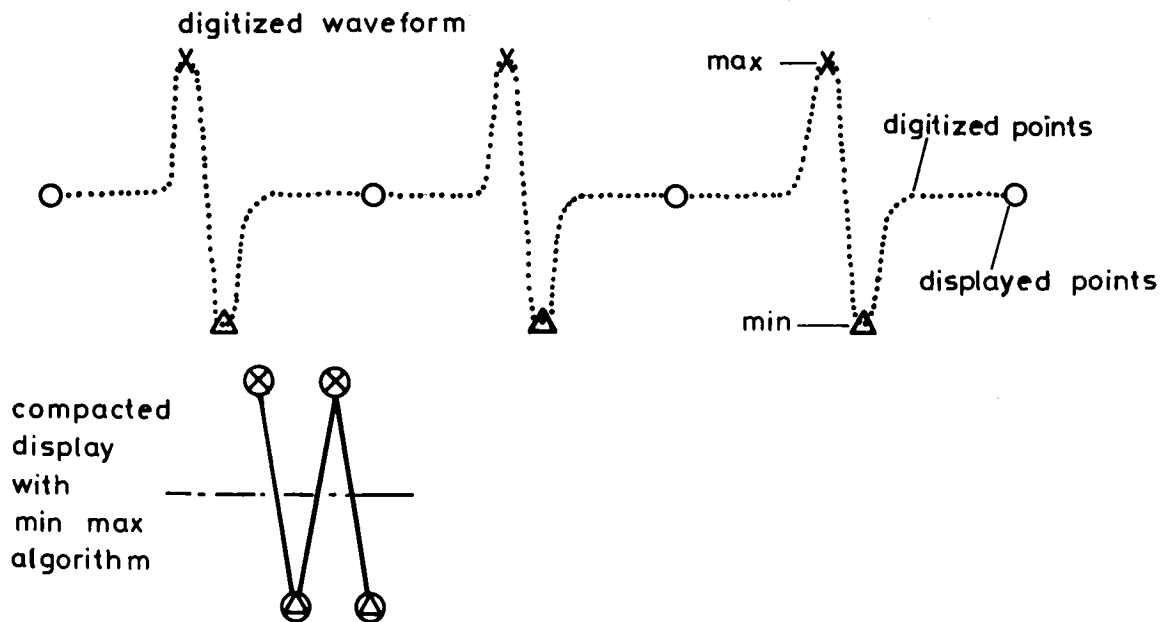

To improve measurement accuracy, two expansion functions, EXPAND A and EXPAND B are provided to display every digitized point trace. When the expansion factor is such that 500 measured points are to be displayed, every display point corresponds to a digitized point.

When the time base requires that less than 500 digitized points fill the screen, the 9400A interpolates using straight line segments between the actual points.

In the example below, the compacted trace of a 25000 point waveform is expanded by a factor of 100 with EXPAND A and B to provide maximum time measurement accuracy.

Under these conditions, each expanded trace displays 250 digitized points.

Every other display point is interpolated and the time measurement accuracy is $1/50000 = 0.002\%$.

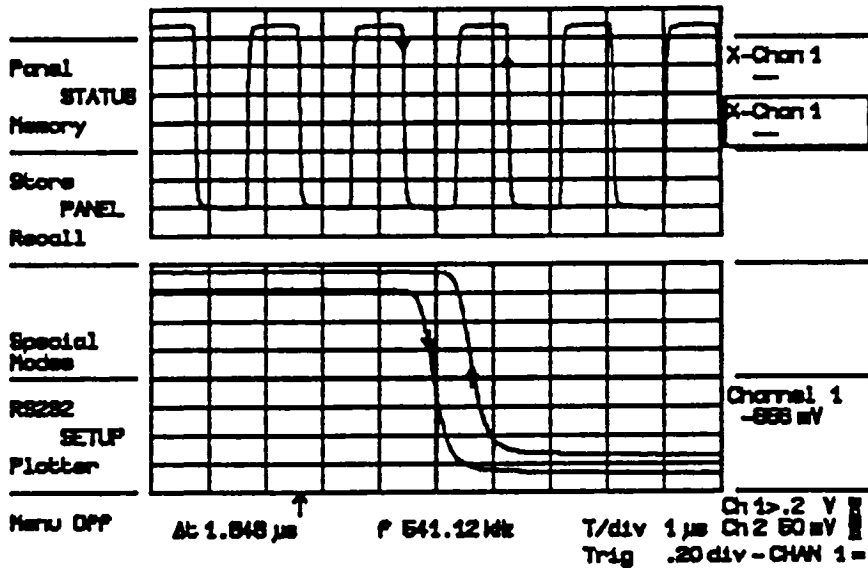

Figure 9.3

9.4 Auto-calibration

As described in Section 2.5, the 9400A calibrates its time interpolator relative to the internal 100 MHz crystal-controlled clock generator every time the time base is modified by front panel operation or by remote control.

The vertical gain and offset of an input channel are calibrated by means of a very stable internal 12-bit digital-to-analog converter every time the fixed gain control of this channel is modified. Calibration of both channels also takes place whenever the bandwidth limit is changed.

These calibrations are necessary largely because of drifts caused by temperature changes which could arise if the 9400A is left in the same state for a very long time. To avoid measurement errors due to potential drifts, an internal timer of the 9400A forces a complete auto-calibration every minute during the first 10 minutes after power-up and every 20 minutes thereafter. This operation is transparent to the user, but is audible due to relay switching. Note that auto-calibration does not occur in SINGLE or SEQNCE trigger mode.

In remote control, all auto-calibration can be turned off. It may be executed whenever requested (see the CALIBRATE command in Section 7.6.6)

SECTION 10

WPO1 WAVEFORM PROCESSING OPTION

10.1 Processing Capabilities

The WPO1 Waveform Processing Option includes an additional 0.5 megabytes random access memory for accumulation, computation and waveform buffers. This allows accumulation of averaged waveforms of 32000 data points in 32-bit form.

All waveform processing occurs through the waveforms E and F which may be displayed on the screen by pressing the corresponding FUNCTION E, F (48) push button. Whenever the FUNCTION E or F trace or an expansion of one or both of these traces (in EXPAND A or B) is turned ON, the corresponding waveform processing is executed. Whenever the trace (and its expansion) is turned OFF, the processing is suspended. This is true even for remote control. The display can be turned off by remote control in order to gain speed (command SCREEN OFF, Section 7.6.3); however, even in this case the corresponding function trace must be turned ON although nothing is displayed on the screen.

FUNCTIONS E and F are waveforms that exist independently of (i.e. in addition to) the acquisition memories of CHANNELS 1 and 2 and of the reference memories C and D. On the display, they are treated similarly to memories C and D, i.e. the vertical display gain and the vertical position can be modified, but not the horizontal position and the time magnifier. Of course, they can be expanded by redefining the source waveform of the traces EXPAND A or B.

Two different processing functions can be executed simultaneously. FUNCTIONS E and F may be read by remote control just like the other traces, with the additional option of reading 16-bit data values, and, as with Channels 1 or 2, they may be stored in reference memories C or D by pressing the STORE push button (1). Waveform processing functions operate on one or two source waveforms which may be CHANNEL 1 or 2, Memory C or D. FUNCTION F may also operate on FUNCTION E. Since the results of the processing functions can be stored in the reference memories, and since FUNCTIONS E and F may operate on these reference memories (and F may operate on E), chaining of operations is possible.

Waveform processing can take an appreciable execution time when operating on many data points. The user has the option of reducing the execution time by limiting the number of data points which are used in the computation.

The 9400A then executes the waveform processing function on the entire waveform (as displayed on the screen) by taking every N^{th} point, N depending on the time base. The first point of such a reduced record is always the data value at address 0 (i.e. the point on the left hand edge of the screen). For readout and display, the data record is re-expanded to the original number of data points by linear interpolation. By remote control the user can read either the entire expanded record or the reduced record. In the second case, the user must know the "skip factor", i.e. the value of $\langle \text{intval} \rangle$ in the read command (see section 7.6.5). This factor can be inspected on the memory status display screen, or by the inspect command.

10.2 Setting Up a Waveform Processing Function Manually

It is generally good practice to stop data acquisition while preparing new conditions for waveform processing (by setting the trigger mode to SINGLE) because the response time might otherwise be slow, depending on the current function setup. In order to prepare FUNCTION E or F for new conditions, or to inspect the current setup, the trace FUNCTION E or F (48) must be turned ON. Select this trace for display control with the SELECT (44) push button and press REDEFINE (45). A full page setup menu for this function appears on the screen. Return to the normal waveform display by either pressing the "Return" soft key (10) or the REDEFINE (45) push button.

The currently selected processing function and its parameters may be modified with the soft keys. First select the field to be modified. The rectangular frame around parameter values indicates the currently selected field. Pressing the Previous FIELD push button (2) will cause the frame to move towards the top of the list, whereas pressing the Next FIELD push button (3) will cause the frame to move downwards.

Following field selection, the current value of the field may be modified by pressing either the Previous or Next VALUE push button (6 or 7). Since the identity of the lower fields may depend on the function chosen, modify the parameters from top to bottom.

The following waveform processing functions are available:

- Average: summed and continuous averaging
- Extrema: "Roof" for maxima, "Floor" for minima
- Arithmetic: Sum, Difference, Product and Ratio
- Functions: Negation, Integral, Differentiation, Square and Square Root
- Smoothing: 1-, 3-, 5-, 7- and 9-point smoothing

10.2.1 Summed Average

Summed averaging consists of the repeated addition, with equal weight, of recurrences of the source waveform. Whenever the maximum number of waveforms is reached, the averaging process stops. The averaging process may be interrupted by switching the trigger mode from NORM to SINGLE (29) or by turning the function trace OFF (48). Averaging will continue when these actions are reversed.

The currently accumulated average may be reset either by changing an acquisition parameter, such as input gain, offset or coupling, trigger condition or time base, or by pressing the RESET push button (41) twice in quick succession (remember that FUNCTION E or F must be selected). The number of currently averaged waveforms is displayed in the Displayed Trace Field (V in Figure 4.1) of the corresponding function or of its expansion.

Whenever the maximum number of sweeps is reached, a larger number of sweeps may be accumulated by simply changing the maximum number of sweeps in the setup menu. In this case care must be taken to leave the other parameters unchanged, otherwise a new averaging calculation is started.

Summed averaging may be performed over CHANNEL 1 or 2. FUNCTION F may also average over FUNCTION E, therefore allowing averaging over functions.

Whenever a waveform containing overflow or under-flow values is to be added to an average, unknown values will be added. The user may choose the action to be taken:

- If "Artifact Rejection" is OFF, any overflows are set to the maximum (256) possible value of the ADC and any under-flows to the minimum (0). The waveform is then added to the average. Of course, the average will be incorrect at the overflow positions.
- If "Artifact Rejection" is ON, waveforms containing at least one overflow or under-flow are rejected from the average, i.e. not added at all. If waveforms consistently contain overflows or under-flows, averaging cannot proceed and the number of accumulated sweeps may stay at zero indefinitely.

In order to improve the signal to noise ratio even further, the 9400A offers the possibility of performing "offset dithering". When turned on (i.e. when set to > 0 least significant bits of the ADC), the 9400A adds a small "hardware" offset to each acquired waveform. This offset is different for different waveforms, and the values are chosen such that their average is negligibly small. The function setup menu allows a choice of the maximum excursion of this offset.

When set to the largest possible value of 6 LSB, the waveforms are offset by up to ± 2 vertical divisions (remember that a vertical division corresponds to 32 least significant bits of the ADC). In this case, care must be taken that the waveform to be averaged is contained within 1/5 of a vertical division from the top and the bottom of the display grid; otherwise overflows or under-flows might occur. Whenever dithering is ON, the displays of CHANNELS 1 or 2 vary vertically with the dithering offset. Their waveform descriptors take the additional offset into account so that waveforms, as read out by remote control, and cursor measurements are always correct.

Offset dithering is of interest when the waveform to be averaged is already relatively "clean", i.e. contains noise variations of the order of 1/5 of a division or less. In this case, dithering makes the sequentially acquired waveforms use slightly different portions of the ADC. Thus the differential non-linearities (that any flash ADC has) are averaged out. It can be expected that the differential non-linearities are reduced by up to a factor of 4 when using 6 LSB dithering. Waveforms which have high levels of noise ($>1/5$ of a vertical division) do their own "dithering", making artificial offset variations unnecessary.

10.2.2 Continuous Average

Continuous averaging (sometimes called exponential averaging) consists of the repeated addition, with UNEQUAL weight, of recurrences of the source waveform. Each newly acquired waveform is added to the accumulated average according to the formula:

$$S(i,new) = \frac{(N-1)}{N} \left[S(i,old) \right] + \frac{1}{N} \left[W(i) \right]$$

Where

i	Index over all data points of the waveforms
W(i)	Newly acquired waveform
S(i,old)	"old" accumulated average
S(i,new)	"new" accumulated average
N	May be 2, 4, 8, 16, 32, 64 or 128

The coefficients $(N-1)/N$ and $1/N$ are the weighting factors which determine the speed at which the continuous average follows any modification of the source waveform. Note that they add up to the value of 1, so that the continuous average of noisy, but otherwise unmodified, waveforms resembles the summed average of such waveforms.

However, the statistical significance of a continuous average is less good, since the last acquired waveform has more weight than all previously acquired ones. Thus the continuous average is dominated by the statistical fluctuations of the most recently acquired waveforms.

The continuous average never stops at a maximum number of sweeps. The weight of "old" waveforms gradually tends to zero, but they are theoretically never completely forgotten. The averaging process may be interrupted by switching the trigger mode from NORM to SINGLE (29) or by turning the function trace OFF (48). Averaging will continue when these actions are reversed. The currently accumulated average may be reset by either changing an acquisition parameter, such as input gain, offset or coupling, trigger condition or the time base, or by pressing the RESET push button (41) twice in quick succession (remember that FUNCTION E or F must be selected).

Continuous averaging may be performed over CHANNEL 1 or 2. FUNCTION F may also average over FUNCTION E, therefore allowing averaging over functions.

10.2.3 Extrema

The computation of extrema consists of a repeated comparison of recurrences of the source waveform with the already accumulated extrema waveform. Whenever a given data point of the new waveform exceeds (either positively or negatively) the corresponding data point of the accumulated extrema waveform, it replaces the former value in the extrema waveform. Thus a maximum (called "roof") or a minimum (called "floor") envelope of all waveforms is accumulated.

Whenever the maximum number of waveforms is reached, the accumulation process stops. The accumulation process may be interrupted by switching the trigger mode from NORM to SINGLE (29) or by turning the function trace OFF (48). Accumulation will continue when these actions are reversed. The currently accumulated extrema waveform may be reset by either changing an acquisition parameter, such as input gain, offset or coupling, trigger condition or the time base, or by pressing the RESET push button (41) twice in quick succession (remember that FUNCTION E or F must be selected). The number of currently accumulated waveforms is displayed in the Displayed Trace Field (V in Figure 4.1) of the corresponding function or of its expansion.

Whenever the maximum number of sweeps is reached, a larger number of sweeps may be accumulated by simply changing the maximum number of sweeps in the setup menu. In this case, care must be taken to leave the other parameters unchanged, otherwise the extrema calculation is started again.

Extrema may be performed over CHANNEL 1 or 2. FUNCTION F may also generate extrema over FUNCTION E, therefore allowing extrema over functions.

10.2.4 Arithmetic

The arithmetic waveform processing options consist of the basic arithmetic functions performed on two source waveforms on a data point per data point basis. Different vertical gains and offsets of the two sources are automatically taken into account. However, both source waveforms must have the same time base, and both must have either INTERLEAVED OFF or INTERLEAVED ON. The trigger point may be different in the two source waveforms, although such a case would usually give results that are difficult to interpret.

The first source waveform may be multiplied by a constant factor in the range .01 to 9.99 and be offset by an additional constant in the range of ± 9.99 times the volts/division setting (of the first source waveform).

10.2.5 Functions

This option consists of the following mathematical functions on single waveform sources: negation, square, square root, integral and differentiation. The first source waveform may be multiplied by a constant factor in the range .01 to 9.99 and be offset by an additional constant in the range of ± 9.99 times the volts/division setting (of the first source waveform).

10.2.6 Smoothing

Five options are available: 1-,3-,5-,7- and 9-point smoothing.

1-point smoothing consists of adding adjacent data points to each other with equal weight. The data points of the source waveform are considered as members of adjacent bins, each containing $N1/N2$ data points. $N1$ is the number of data points in the source waveform whereas $N2$ is the number of data points specified by the third line of the setup menu. The data points within each bin are averaged, resulting in a waveform consisting of $N2$ data points. For readout and display this reduced record is then re-expanded to the original number of data points by linear expansion.

3-point smoothing consists of computing each data point of the source waveform according to the formula:

$$Y(i) = \frac{W(i-1)}{4} + \frac{W(i)}{2} + \frac{W(i+1)}{4}$$

where $W(i)$ is the i^{th} point of the source waveform and $Y(i)$ is the i^{th} point of the computed waveform. If the maximum number of data points, specified in the third line of the setup menu, is smaller than the original number of points, the smoothing is applied to the reduced data record.

5-point smoothing consists of the application of 3-point smoothing twice in sequence. Similarly, 7-point and 9-point smoothing are computed by applying 3-point smoothing 3 and 4 times.

The resulting averaging formula for 5-point smoothing is:

$$Y(i) = \frac{W(i-2)}{16} + \frac{W(i-1)}{4} + \frac{W(i)*6}{16} + \frac{W(i+1)}{4} + \frac{W(i+2)}{16}$$

Whereas, for 7-point smoothing, it is:

$$Y(i) = \frac{W(i-3)}{64} + \frac{W(i-2)*6}{64} + \frac{W(i-1)*15}{64} + \frac{W(i)*20}{64} + \frac{W(i+1)*15}{64} + \frac{W(i+2)*6}{64} + \frac{W(i+3)}{64}$$

And for 9-point smoothing:

$$Y(i) = \frac{W(i-4)}{256} + \frac{W(i-3)*8}{256} + \frac{W(i-2)*28}{256} + \frac{W(i-1)*56}{256} + \frac{W(i)*70}{256} + \frac{W(i+1)*56}{256} + \frac{W(i+2)*28}{256} + \frac{W(i+3)*8}{256} + \frac{W(i+4)}{256}$$

10.3 Remote Control of Waveform Processing Functions

Remote control of the waveform processing is essentially achieved with extensions of existing commands. No processing occurs if the corresponding TRACE FUNCTION E (TRFE) or TRACE FUNCTION F (TRFF) is OFF (see Section 7.6.3). This is also true even if the SCREEN has been turned OFF. Averaging can be stopped and continued by switching from TRIG_MODE NORM to TRIG_MODE SINGLE and vice versa. Of course, it can also be stopped by turning its corresponding trace OFF. An average or an accumulation of extrema can be reset by a new command, AVERAGE_RESET. A new function or new processing parameters are defined with extensions to the command REDEFINE. In addition, the command INSPECT allows some characteristics of the waveform to be known before it is read out.

1) AVERAGE_RESET (ARST) *

The accumulated average or extrema of the SELECTed trace is reset. This command can only be applied to FUNCTION_E or to FUNCTION_F.

The 9400A sets the ENVIRONMENT ERROR:

- if the SELECTed trace is OFF.
- if the SELECTed trace is neither FUNCTION_E nor FUNCTION_F.

The INSPECT commands of Section 7.6.5 have been extended to cover the inspection of FUNCTIONS E and F by including the following mnemonics:

2) INSPECT (INS) , < FUNCTION_E.LIMIT (FE.LI) > < FUNCTION_F.LIMIT (FF.LI) >

instructs the 9400A to return a character string containing the lower and upper address limits of the current waveform,

or

INSPECT (INS) , < FUNCTION_E.NSWEEPS (FE.NS) > < FUNCTION_F.NSWEEPS (FF.NS) >

instructs the 9400A to return a character string containing the number of acquired sweeps (in averaging and extrema),

or

INSPECT (INS) , < FUNCTION_E.INTVAL (FE.IV) > < FUNCTION_F.INTVAL (FF.IV) >

instructs the 9400A to return a character string containing the interval between data points used by a waveform processing function. This value may be used as the <intval> parameter in the readout of such waveforms if the user wishes to read only the computed data points and none of the re-interpolated points.

3) REDEFINE (RDF) , ?

Instructs the 9400A to report the current configuration of the SELECTed trace,

or

REDEFINE (RDF) , AVERAGE (AVG) , SUMMED , <maxpts> , *
<source> , <maxswps> , <reject> , <dither>

configures the SELECTed trace for a summed average,

or

REDEFINE (RDF) , AVERAGE(AVG) , CONTINUOUS(CONT) , <maxpts> , *
<source> , <weight>

configures the SELECTed trace for a continuous average,

or

REDEFINE (RDF) , EXTREMA (EXTR) , <e-type> , <maxpts> , *
<source> , <maxswps>

configures the SELECTed trace for an extrema accumulation,

or

REDEFINE (RDF) , ARITHMETIC (ARI) , <a-type> , <maxpts> , *
<source1> , <source2> , <m-fact> , <a-const>

configures the SELECTed trace for waveform arithmetic on two sources,

or

REDEFINE (RDF) , FUNCTIONS (FNC) , <f-type> , <maxpts> , *
 <source1> , <m-fact> , <a-const>

configures the SELECTed trace for a mathematical waveform function
on a single source,

or

REDEFINE (RDF) , SMOOTHING (SMO) , <s-type> , <maxpts> , *
 <source1>

configures the SELECTed trace for a smoothing operation.

The parameters have the following options:

<maxpts>	=	< 50 >	Maximum number of data
		< 125 >	points to be used in the
		< 250 >	computation
		< 625 >	
		< 1250 >	Default: 1250
		< 2500 >	
		< 6250 >	
		< 12500 >	
		< 25000 >	
		< 32000 >	

Any other number generates a semantic error.

<source>	=	< CHANNEL_1	(C1) >	Source waveform
		< CHANNEL_2	(C2) >	
		< FUNCTION_E	(FE) >	Default: CHANNEL_1

<source1>	=	< CHANNEL_1	(C1) >	Source waveform(s)
<source2>		< CHANNEL_2	(C2) >	
		< MEMORY_C	(MC) >	Default: CHANNEL_1
		< MEMORY_D	(MD) >	
		< FUNCTION_E	(FE) >	

NOTE: a distinction is made between <source> and <source1> to
indicate the fact that averaging and extrema cannot be executed on
MEMORY_C or MEMORY_D, whereas all the other functions can.
FUNCTION_E can only be a source for waveform FUNCTION_F.

<s-type> = < 1 > Smoothing type
< 3 >
< 5 > Default: 3-pt smoothing
< 7 >
< 9 >

Any other number generates a semantic error.

<m-fact> = [0.01 to 9.99] Multiplication factor
Default: 1.00

Any value smaller than 0.01 or greater than 9.99 is adapted to the nearest legal value.

<a-const> = [-9.99 to 9.99] Additive constant
Default: 0.00

Any value smaller than 0.01 or greater than 9.99 is adapted to the nearest legal value.

NOTE: <a-const> is interpreted as the number of vertical divisions of <source1>

Whenever a parameter is not specified, the default value is substituted.

Examples:

RDF,AVG,SUMMED,,C2 Configures the SELECTed trace (which must be FUNCTION_E or FUNCTION_F) for the summed averaging of CHANNEL 2 with a maximum of 1250 data points over 1000 sweeps. By default, overflow rejection and dithering are off.

RDF,ARI,PRD,2500,C1,MD,2.00,1.00

Configures the SELECTed trace to compute the waveform $2.00 * (\text{CHANNEL}_1 + 1 \text{ div}) * \text{Memory}_D$. A maximum of 2500 of data points (equidistantly distributed over the screen) are to be used.

REDEFINE,FNC,INTEG,25000,FE

Configures the SELECTed trace (which must be FUNCTION_F, since FUNCTION_E is specified as source waveform) to compute the integral over the waveform in FUNCTION_E, using a maximum of 25000 data points. Note that the use of 25000 data points implies that all data points on the screen are to be used, regardless of the time-base setting.

- 4) The READ commands of Section 7.6.5 have been extended to read FUNCTIONS E and F:

```
READ (RD) , < FUNCTION_E.DESC (FE.DE) >  
          < FUNCTION_F.DESC (FF.DE) >
```

```
READ (RD) , < FUNCTION_E.DATA (FE.DA) > , <Parameter list>  
          < FUNCTION_F.DATA (FF.DA) >
```

```
READ (RD) , < FUNCTION_E.TIME (FE.TI) >  
          < FUNCTION_F.TIME (FF.TI) >
```

```
READ (RD) , < FUNCTION_E.* (FE.*) > , <Parameter list>  
          < FUNCTION_F.* (FF.*) >
```

<Parameter list> = <intval> , <# values> , <addr> , <sweep #>

See Section 7.6.5 for more detailed explanations.

10.4 Additional Values in the Descriptors of Processed Waveforms

The waveform descriptor contains all the information needed to correctly interpret the waveform data. The parameters which describe the raw data records are explained in Section 7.7; they are still valid for processed waveforms. However, some additional parameters describe the processing which was applied to obtain the current waveform.

IMPORTANT: The parameters in the following list have NO meaning if the "Data Processing" byte (number 34 of the descriptor record) is set to 99 (raw data).

In the following list, each parameter is identified by its (decimal) address relative to the beginning of the descriptor, and by the number of bits. Data values shown are always in decimal.

Pos.	Size	Meaning
36	16-bit	256*Power of volts (see explanation in Section 10.5).
38	16-bit	256*Power of seconds (see explanation in Section 10.5).
40 - 63		Reserved
64	8-bit	Identity of function waveform; 4 = E, 5 = F.

- 65 8-bit Function type.
 0 = Average 1 = Extrema
 2 = Arithmetic 3 = Functions
 4 = Smoothing
- 66 8-bit Sub-function type, depending on function type. Takes on values between 0 and (n-1), where n is the number of sub-functions possible. The order is the same as in the sub-function lists of Section 10.3.
- 67 8-bit Primary source of this waveform.
 0 = CHANNEL 1 1 = CHANNEL 2
 2 = Memory C 3 = Memory D
 4 = FUNCTION E
- 68 8-bit Secondary source of this waveform (arithmetic only), with the same interpretation as the previous byte (67).
- 69 8-bit Continuous averaging weight.
 0 = 1 : 1 1 = 1 : 3
 2 = 1 : 7 3 = 1 : 15
 4 = 1 : 31 5 = 1 : 63
 6 = 1 : 127
- 70 32-bit Maximum number of sweeps (summed averaging and extrema).
- 74 16-bit Multiplication factor * 100
- 76 16-bit Additive constant * 100
- 78 16-bit Maximum number of data points = <maxpts> in the REDEFINE command.
- 80 8-bit Reject (summed averaging only).
 0 = Reject off 1 = Reject on
- 81 8-bit Dithering (summed averaging only).
 0 = No dithering
 Otherwise = approximate number of ADC least significant bits, corresponding to the maximum dithering excursion.
- 82 - 97 Reserved
- 98 32-bit Actually acquired number of sweeps (summed averaging and extrema).
- 102 32-bit Number of acquired waveforms with overflows (summed averaging).

- 106 32-bit Number of acquired waveforms with under-flows (summed averaging).
- 110 32-bit Number of rejected waveforms (summed averaging with Reject ON).
- 114 16-bit Number (+ 1) of data points used in the computation of this data record (may be less than <maxpts>).
- 116 16-bit Ratio of the number of data points in the source waveform over the number of data points used.
- 118 - 149 Reserved

10.5 Vertical Scaling Units

With the introduction of waveform processing functions, such as multiplication, division, square-root, integration and differentiation, which alter the vertical scaling units, a more general system for the vertical scales must be introduced. Three variables are now involved:

"fgain" (byte 0) = "fixed vertical gain" is now interpreted slightly differently, by dropping the notion of volts (Compare with Section 7.7).

22 = 5 mU/div	23 = 10 mU/div
24 = 20 mU/div	25 = 50 mU/div
.....	31 = 5 U/div

Where U now stands for a general unit, which may be a product of a power of volts and of a power of seconds.

"P_V" (bytes 36 + 37) = 256*power of volts
 "P_s" (bytes 38 + 39) = 256*power of seconds

Thus, $U = \text{Volts}^{*(P_V/256)} * \text{Seconds}^{*(P_s/256)}$.

NOTE: Whenever the WP01 waveform processing option is installed, "P_V" and "P_s" are always valid, even in raw data records (see the following example). However, in software versions without waveform processing, they cannot be relied upon. (Of course, in these cases the vertical scales are always in volts).

Examples:

"fgain" = 22 corresponding to 5 mU/div
"P_V" = 256 corresponding to power of 1
"P_s" = 0 corresponding to power of 0

The resulting vertical scale is thus 5 mV/div. Such a scale might occur in raw data records, in averaging, extrema or sums of raw data records.

"fgain" = 17 corresponding to 100 μ U/div
"P_V" = 512 corresponding to power of 2
"P_s" = 0 corresponding to power of 0

The resulting vertical scale is thus 100 μ V²/div. Such a scale would result from the multiplication of two raw data records.

"fgain" = 26 corresponding to 100 mU/div
"P_V" = 64 corresponding to power of 1/4
"P_s" = 0 corresponding to power of 0

The resulting vertical scale is thus 100 mV^{1/4}/div (i.e. one-tenth of the fourth root of volts per division). Such a scale might result from the double application of the square-root operation on a raw data record.

"fgain" = -2 corresponding to 50 pU/div
"P_V" = 256 corresponding to power of 1
"P_s" = 256 corresponding to power of 1

The resulting vertical scale is thus 50 pVsec/div. This scale might result from an integration over a raw data record.

The following cases can also occur:

- Both powers may be zero, corresponding to a dimensionless record, e.g. resulting from a division of raw data records.
- Powers may be negative, e.g. due to a division of raw data records, followed by another division. Differentiation also gives negative powers of the time unit.

10.6 Index of Topics

<u>Paragraph</u>	<u>Topic</u>
10.2.4	Arithmetic options
10.3 1)	AVERAGE RESET (ARST)
10.2.2	Averaging, continuous
10.2.1	Averaging, summed
10.2.3	Extrema
10.1	Function E
10.3 2)	INSPECT (INS)
10.2.5	Mathematical functions
10.3 3)	REDEFINE (RDF)
10.3	Remote control of waveform processing functions
10.2	Setting up a waveform processing function manually
10.2.6	Smoothing, N-point
10.5	Vertical scaling units
10.4	Waveform descriptor syntax
10.1	WP01 waveform processing capabilities



SECTION 11

FAST FOURIER WAVEFORM PROCESSING OPTION (WPO2, V 2.06FT)

11.1 Processing Capabilities

The FFT option (WPO2) adds a spectrum analysis capability to a 9400A already equipped with the waveform processing option WPO1.

The 9400A's Functions E and F can be defined as the fast Fourier transform of one of the source waveforms - Channel 1, Channel 2, Memory C, Memory D, and Function E (for Function F only). A glossary of the terms used in this chapter is given in Section 11.6.

Values of the following FFT processing parameters can be selected in the FFT redefine menu or with remote control commands.

```
=====
Function Type:          Fourier Transform

Display Type:          Power Spectrum (dBm)
                      Power Density (dBm)
                      Magnitude
                      Phase
                      Real Part
                      Imaginary Part

Transform size:        50 to 25000

Source Trace:          Channel 1
                      Channel 2
                      Memory C
                      Memory D
                      Function E (for Function F only)

Window Type:           Rectangular
                      von Hann (Hanning)
                      Hamming
                      Flat Top
                      Blackman-Harris

Multiplication Factor: 0.01 to 9.99

Additive Constant:     -9.99 to +9.99

Zero Suppression:     OFF or ON.
=====
```

Fast Fourier Waveform Processing
Option (WPO2, V 2.06FT)

The 9400A's Function F can also be defined as the Power Average of the FFT computed by Function E.

Values of the following FFT processing parameters can be selected in the FFT Power Average redefine menu or with remote control commands:

```
=====
Function Type:          FFT Power Average
Display Type:          Power Spectrum (dBm)
                      Power Density (dBm)
                      Magnitude
Transform Size:        same as Function E
Source Trace:          Function E
Max number of sweeps:  10 to 200
=====
```

All WPO1 functions (Averaging, Extrema, Arithmetic, Functions and Smoothing) can be applied to waveforms either before or after the FFT processing.

Menus and front panel controls related to FFT are similar to the corresponding WPO1 controls (see Section 10.1).

Remote control commands related to FFT provide for the definition of processing and the readout of waveform data and status, as well as the loading of reference waveforms into the 9400A's memories (C, D). The commands are similar to the corresponding WPO1 commands (see Sections 7, 10.3 and 11.3).

Spectra are computed over the full length of the source time domain waveform.

Sub-sampling of the source waveform is available (with the Transform Size option in the FFT menu), so that the computation speed can be traded against the frequency range.

Spectra are displayed with frequency axes running from zero to Nyquist frequency, over 5 or 6.25 divisions, with the frequency scale factor in a 1-2-5 sequence.

The Time Magnifier operates on the FFT output traces as a Frequency Magnifier (up to 100 times).

The Display Control knobs provide vertical expansion (up to 10 times) and vertical position control.

To read the amplitude and frequency of the data point, the Marker can be moved over into the frequency domain by going beyond the right hand edge of the time domain waveform.

The Time Cursors can be moved beyond the right hand edge of the time domain waveform and thus become Frequency Cursors, providing simultaneous readout of frequency difference and of amplitude difference between two points on each frequency domain trace.

Table 11.1 Display Types

Display type	Unit	Vertical position of zero
Power Spectrum	dBm	(mark)
Power Density spectrum	dBm	(mark)
Magnitude	V	-3 div
Phase	degree	0 div
Real Part	V	0 div
Imaginary Part	V	0 div

Note: Vertical position of 0 dBm varies with the source waveform's gain. A mark at the left hand edge of the screen indicates the dBm level of a trace. Generally, a sinusoidal source waveform of 8 div peak-peak will give a spectrum point of about +3 div at any gain.

Since the computation of FFT may take up to 1 minute (for a Transform Size of 25000 points), it is possible to interrupt an undesired FFT either by turning off the corresponding trace(s) or by pushing the Redefine button, if the FFT trace is the selected trace.

11.2 Modification to WPO1 Functions

With the option WPO2 (FFT) installed, the WPO1 functions are modified as follows:

When any WPO1 function operates on a frequency domain waveform (a result of FFT processing), the Max # of Points value selected in the menu of the function is ignored. Instead, the number of points of the frequency domain waveform is used for further processing.

11.3 FFT Processing Examples

Example: spectrum of the 9400A Probe Calibrator waveform.

- 1) Connect the 9400A calibration signal (976.6 Hz, 1.0 V pp square wave) to the channel 1 input.
- 2) If you use a $\times 10$ probe, select Panel STATUS and adjust the Set Ch1 Attenuator to $\times 10$.

Set Channel 1 volts/div to 20 mV/div (for $\times 10$ probe), AC, 1 M Ω .

Set the Channel 1 offset to a value near 0.

- 3) Select a time base of 1 msec/div.
- 4) Adjust the triggering conditions as follows: Ch1, AC coupling, normal; trigger level about 0 div.

You should obtain a repetitive display of almost 10 periods of a square wave, 5 divisions peak-to-peak.

- 5) Turn on and Select Function E

- 6) Redefine Function E as follows:

Function Class:	Fourier Transform
Display Type:	Magnitude
Transform Size:	1250
Source Trace:	Chan 1
Window Type:	Rectangular
Multiplication Factor:	1.00
Additive Constant:	+0.00 div
Zero Suppression:	ON

Notice that at the bottom of the menu page the effective number of points, $N = 1250$, and the Nyquist frequency = 62.5 kHz are displayed.

- 7) Start computing the FFT (press either Return or Redefine button)

Note the message COMPUTING in the lower left corner of the screen. After 2 seconds, the computed Magnitude spectrum is displayed.

If you are using the Normal or Auto trigger mode, you will get a new spectrum about every 1.7 seconds.

Note the frequency scale factor of 10 kHz/div and the frequency range of 6.25 divisions, from zero to 62.5 kHz, the Nyquist frequency. The zero frequency is always displayed at the left hand edge of the screen.

The frequency interval, Δf , between two computed points equals $1/T$, where T is the duration of the time domain record (10 msec). In this case,

$$\Delta f = 100 \text{ Hz.}$$

Observe that the signal spectrum has a prominent peak - the fundamental harmonic - at about 1 kHz, followed by the peaks of the odd harmonics, of decreasing amplitude.

- 8) Freeze the spectrum by selecting the Single Trigger mode

You can use the Marker to check the exact frequency and amplitude of the 1 kHz peak. You may use trace expansion (A or B) to view details of the peaks and to adjust the Marker.

Note that the step size with which you can advance the Marker is not related to the interval between the computed points. The step becomes finer when you increase the expansion factor.

With the Rectangular Window, the amplitude of the 1 kHz peak may be inexact ("picket fence effect"). In the example above, with 0.50 V peak square wave, you would expect $0.50 \text{ V} * 4/\pi = 0.636 \text{ V}$ for the first harmonic but you will find about 0.43 V.

- 9) Redefine the Window Type to the Flat Top, press the Return button.

The amplitude of the 1 kHz peak should now be very close to the expected 0.636 V, but at the cost of a broader peak and a reduced frequency resolution.

- 10) Increase the time record duration

Switch to the slower time base of 2 msec/div.

To repeat the acquisition of input and the spectrum computation, push the Single Trigger button.

The frequency resolution is now increased (the harmonic peaks are further apart), but the frequency range is reduced.

You can use the Marker to check the Nyquist frequency of 25.0 kHz at the right hand edge of the spectrum trace, which agrees with the value displayed in the FFT menu.

- 11) Switch to 10 msec/div and push the Single Trigger button to further increase the time record duration.

The Nyquist frequency is now 6.25 kHz, so that only the harmonics 1, 3 and 5, at approximately 1, 3 and 5 kHz fit into the frequency range. The 7th harmonic, at about 7 kHz, has been aliased (folded back) into the peak visible at $2 * 6.25 - 7 = 5.5$ kHz. Further aliased harmonics of decreasing amplitude are also visible between the original peaks.

- 12) Redefine the Display Type to Power Spectrum, and the Window Type back to Rectangular.

You now see the harmonics on the logarithmic scale, at 10 dB/div.

Look at the broad skirts exhibited by the peaks: this is the leakage of the signal energy of each peak into the neighboring frequency bins.

- 13) Redefine the Window Type to von Hann (also called Hanning)

The skirts are reduced considerably; the leakage is diminished.

- 14) Redefine the Transform size to 2500

You will obtain $N = 2500$ and the Nyquist frequency of 125 kHz, while the interval between the points (bins) will remain unchanged at $1/0.01 \text{ sec} = 100 \text{ Hz}$.

- 15) Define Function F as the FFT Power Average of Function E

Using the Normal or Auto trigger mode, you can average up to 200 spectra and see the intermediate or final average on a linear scale (Magnitude) or dBm scale (Power Spectrum or Power Density).

16) Experiment

Try other time-base settings, display modes, numbers of points, window types and signals, to become familiar with the system. Try combinations of FFT and the WPO1 processing functions.

You can define both Functions E and F as FFT of the same source waveform, but with different parameters, and compare the resulting traces.

11.4 Remote Control of FFT Processing

Consult Sections 7 and 10.3 - 10.4 for general information on remote control using either the GPIB or the RS-232-C interface. The additional forms of commands specific to the FFT option and the related fields of the Waveform Descriptor are described below.

11.4.1 Remote Commands

The 'Redefine' command has been extended to accept the parameters related to FFT:

```
REDEFINE (RDF), FFT, <disp_type>, <maxpts>, <source>, <window>,
<m_fact>, <a_const>, <z_suppr>
```

The parameters have the following options:

```
<disp_type> = < POWER SPECTRUM (PWS) > (default)
               < POWER DENSITY (PWD) >
               < MAGNITUDE (MAG) >
               < PHASE (PHASE) >
               < REAL PART (REAL) >
               < IMAGINARY_PART (IMAG) >
```

```
<maxpts> = < 50 >
            < 125 >
            < 250 >
            < 625 >
            < 1250 > (default)
            < 2500 >
            < 6250 >
            < 12500 >
            < 25000 >
```

Any other number generates a semantic error.

<source> = < CHANNEL 1 (C1) > (default)
< CHANNEL_2 (C2) >
< MEMORY_C (MC) >
< MEMORY_D (MD) >
< FUNCTION_E (FE) >

NOTE: FUNCTION_E can be a source only for FUNCTION_F.

<window> = < RECTANGULAR (RECT) > (default)
< VON HANN (HANN) >
< HAMMING (HAMM) >
< FLAT TOP (FLT) >
< BLACKMAN_HARRIS (BH) >

<m_fact> = 0.01 to 9.99 (default = 1.0)

Multiplication factor applied to the source waveform before FFT computation.

<a_const> = -9.99 to 9.99 (default = 0.0)

Additive constant (divisions) applied to the source waveform before multiplication.

<z_suppr> = <OFF>
<ON> (default)

If ON, the DC component of the source waveform is forced to 0.

The 'redefine' command has also been extended to accept the parameters related to the FFT Power Average:

REDEFINE (RDF), FFT_AVG (FFTA), <disp_type>, <nsweeps>

The parameters have the following options:

<disp_type> = < POWER_SPECTRUM (PWS) > (default)
< POWER_DENSITY (PWD) >
< MAGNITUDE (MAG) >

<nsweeps> = < 10 >
< 20 >
< 50 >
< 100 >
< 200 > (default)

Any other number generates a semantic error.

NOTE: This definition can be applied only to Function F. It will be executed only if Function E is defined as FFT (any display mode). The number of points will be that of the output of the FFT (i.e. N/2).

Examples:

RDF,FFT,MAG,1250,C1

Redefines the SELECTed trace (E or F) for the FFT of Channel 1 with maximum 1250 points, displaying the Magnitude on a linear scale.

Default settings are applied to the remaining parameters (Rectangular window, m_fact = 1.0, a_const = 0.0, zero suppression is ON).

RDF,FFT,PWS,625,C2,BH,2.0,,OFF

Redefines the SELECTed trace (E or F) for the FFT of Channel 2 with maximum 625 points, displaying the Power Spectrum on a logarithmic (dBm) scale. Window Type is Blackman-Harris, m_fact = 2.0, a_const = 0.0, zero suppression is OFF.

RDF,FFTA,PWD,20

Redefines the SELECTed trace (must be F) for the FFT Power Average of the FFT computed simultaneously by Function E. Number of sweeps is 20.

11.4.2 Additional Values in the Descriptors of FFT Processed Waveforms

The oscilloscope waveform and descriptors can be read into a host computer (see Section 7.6.5).

With the WPO2 option, the Waveform Descriptor length is unchanged (150 bytes). However, in addition to the Descriptor field values defined in Section 7.7 and 10.4, the following fields have new or additional values pertaining to the results of FFT processing:

Pos	Size	Meaning
9	8-bit	Time base (sec/div): 4 .. 36: see Section 7.7 Frequency base (Hz/div): 59 = 5 mHz 60 = 10 mHz 61 = 30 mHz 62 = 50 mHz ... 86 = 5 MHz 87 = 10 MHz 88 = 20 MHz ... 91 = 0.2 GHz 92 = 0.5 GHz Displayed Record Length 59 .. 86 = 12500 points 87 = 10000 points 88 .. 92 = 12500 points
10	8-bit	Sampling interval (sec/point): 11 .. 45: see Section 7.7 Frequency interval (Hz/point): 59 = 2.0 μ Hz 60 = 5.0 μ Hz 61 = 10.0 μ Hz 62 = 20.0 μ Hz ... 91 = 0.1 MHz 92 = 0.2 MHz
34	8-bit	Data processing of this record 5 = FFT 6 = FFT_AVERAGE
36	16-bit	Units: code for power of volts code = 256 * power
38	16 bit	Units: code for power of seconds

			code = 256 * power
40	16 bit	Units:	code for power of arbitrary unit
			code = 256 * power
42	8 bit	Units:	identity of arbitrary unit
			0 = undefined
			1 = dB
			4 = degrees
66	8 bit	Display Type:	
			0 = dBm Power Spectrum
			1 = dBm Power Density
			2 = Magnitude
			3 = Phase
			4 = Real Part
			5 = Imaginary Part
82	8 bit	Window Type:	
			0 = rectangular
			1 = von Hann
			2 = Hamming
			3 = Flat Top
			4 = Blackman-Harris
89	8 bit	Zero Suppression:	
			0 = OFF
			1 = ON
118-119	16 bit	Ratio of the number of data points of the expanded waveform over the number of data points computed.	

11.5 FFT Application Hints

11.5.1 Some practical suggestions:

- (1) To increase the frequency resolution, increase the length of the time domain waveform record (i.e. use a slower time base).
- (2) To increase the frequency range, increase the effective sampling frequency (i.e. increase the Transform Size).

- (3) With transient signals use the Rectangular window. You should adjust the time base and the triggering conditions so that the transient is completely contained in the time domain window (i.e. on the screen).
- (4) For the best amplitude accuracy of isolated spectrum peaks, use the Flat Top window.
- (5) For the best reduction of leakage and good detection of small peaks several bins away from a large peak, use the Blackman-Harris window.
- (6) For moderate improvement of amplitude accuracy and of leakage rejection, use the von Hann or Hamming window.
- (7) If your time domain signal is repetitive but noisy, preventing you from having a stable trigger, you can define Function E as the FFT of the signal channel and Function F as the FFT Power Average of Function E to obtain a stable spectrum of the input signal.
- (8) You can display the FFT Power Average either on a linear scale (Magnitude) or on a dBm scale (Power Spectrum or Power Density).

11.5.2 Relationships of 9400A FFT output waveforms to the FFT computation steps

For comparison of the 9400A's FFT results with those obtained from other FFT instruments the following information may be useful:

- (1) In the 9400A's FFT computation, the first step is the sub-sampling of the source waveform. Data points for the FFT calculation are measured at regular intervals over the full length of the waveform displayed on the screen.

You can select the maximum transform size in the FFT menu or via remote control. The actual transform size, N, is selected to be equal to or smaller than the Displayed Record Length (see Table 5.1). Exception: you may get a 125 point transform when you have specified 50 points.

The sub-sampling interval and the actual transform size selected provide the frequency scale factor in a 1-2-5 sequence.

- (2) The second step is the addition of the selected constant to the sub-sampled source waveform, followed by multiplication by the selected factor.
- (3) The third step is the multiplication of the source waveform by the selected window function.
- (4) The fourth step is the computation of FFT, using a fast implementation of the DFT (Discrete Fourier Transform)

$$X_n = \frac{1}{N} \sum_{k=0}^{N-1} x_k * W^{n*k}$$

where x_k is a complex array whose real part is the modified source time domain waveform, and whose imaginary part is 0

X_n is the resulting complex frequency domain waveform

$W = e^{(-j * 2 * \pi / N)}$

N is the number of points in x_k and X_n

The generalized FFT algorithm, implemented in the 9400A, works on N which need not be a power of 2.

- (5) The fifth step is the division of the resulting complex vector X_n by the coherent gain of the window function, to compensate for the loss of the signal energy due to windowing. This compensation provides accurate amplitude values for isolated spectrum peaks.

The real part of X_n is symmetric about the Nyquist frequency, that is:

$$R_n = R_{N-n}$$

while the imaginary part is anti-symmetric, that is

$$I_n = -I_{N-n}$$

It can be considered that the energy of the signal at some frequency n is distributed 50/50 between the first half and the second half of the spectrum; the energy at frequency 0 is completely contained in the 0 term.

- (6) The sixth step is the elimination of the redundant part of the results. Only the first half of the spectrum (Re, Im), 0 to the Nyquist frequency is kept:

$$\begin{aligned} R'_n &= 2 * R_n & 0 \leq n < N/2 \\ I'_n &= 2 * I_n & 0 \leq n < N/2 \end{aligned}$$

- (7) The seventh and last step is the computation of the waveform to be displayed.

If you select the Real Part or Imaginary Part Display Type, no further computation is done: the displayed waveform is R' or I' as defined above.

If you select Magnitude mode, the magnitude is computed as:

$$M_n = \sqrt{R_n'^2 + I_n'^2}$$

In practice, the steps described above lead to the following result:

An AC sine wave of amplitude 1.0 V and an integral number of periods in the time window, transformed with the rectangular window, results in a fundamental peak of 1.0 V magnitude in the spectrum.

However, a DC component of 1.0 V, transformed with the rectangular window, results in a fundamental peak of 2.0 V magnitude in the spectrum.

The displayed waveforms for the other available modes are computed as follows:

$$\begin{aligned} \text{Phase: } \text{angle} &= \arctan (I_n / R_n) & M_n &> M_{\min} \\ \text{angle} &= 0 & M_n &\leq M_{\min} \end{aligned}$$

where M_{\min} is the minimal magnitude, fixed at about 10^{-3} of the full scale (i.e. 64 units on the scale of 65536, 16 bits), at any gain setting.

dBm Power Spectrum:

$$\text{Log PS}_n = 10 * \log_{10} \left(\frac{M_n^2}{M_{\text{ref}}^2} \right) = 20 * \log_{10} \left(\frac{M_n}{M_{\text{ref}}} \right)$$

where $M_{\text{ref}} = 0.316 \text{ V}$ (that is, 0 dBm is defined as the sine wave of 0.316 V _{peak} or 0.224 V RMS, giving 1.0 mW into 50 Ω).

Note that the "dBm Power Spectrum" could also be called the "dBm Magnitude" as suggested by the formula above.

dBm Power Density:

$$\text{Log PD}_n = \text{Log PS}_n - 10 * \log_{10} (\text{ENBW} * \Delta f)$$

where ENBW is the equivalent noise bandwidth of the filter corresponding to the selected window

Δf is the current frequency resolution (bin width)

The FFT Power Average (Function F only) takes the complex frequency domain data R'_n , I'_n , generated by Function E in step 6 above, computes the square of the magnitude

$$M_n^2 = R_n'^2 + I_n'^2$$

and collects the result in a buffer.

- (8) In the case of an FFT Power Average the final step is the computation of the selected Display Type format (Magnitude, Power Spectrum, Power Density).

11.5.3 Computation speed of FFT

In the 9400A the Fourier transform computation takes about 1.7 sec for a 1250 point FFT and just under one minute for a 25000 point FFT. These times depend somewhat on the Window Type and the Display Type selected.

You can speed up the computation by selecting a Transform Size smaller than 25000. The 9400A will select for you the effective Transform Size, N, equal to or smaller than your selected value, depending on the actual number of points in the time domain record.

11.6 FFT/9400A Glossary

Aliasing

If the input signal to a sampling acquisition system contains components whose frequency is greater than the Nyquist frequency (half the sampling frequency) which results in less than two samples per signal period, these components will be aliased. That is, their contribution to the sampled waveform will be indistinguishable from that of the components below the Nyquist frequency.

In the 9400A, the FFT definition menu displays the effective Nyquist frequency. You should select the time base and Transform Size resulting in a Nyquist frequency higher than the highest significant component in the time domain record.

To help you choose suitable settings for FFT analysis, a table of Nyquist frequencies is given in Section 11.8.

Coherent Gain

The coherent gain of a filter corresponding to each window function is 1.0 (0 dB) for the Rectangular window and less for other windows. It defines the loss of signal energy due to the multiplication by the window function. In the 9400A this loss is compensated. Table 11.3 lists the values for the windows implemented.

ENBW (Equivalent Noise Bandwidth)

For a filter associated with each frequency bin, ENBW is the bandwidth of an equivalent rectangular filter (having the same gain at the center frequency) which would collect the same power from a white noise signal as the filter considered. In Table 11.3, ENBW is listed for each window function implemented and is given in bins.

Filters

Computing an N-point FFT is equivalent to passing the time domain input signal through N/2 filters and plotting the outputs of the filters along the frequency axis. The spacing of filters is $\Delta f = 1/T$ and the bandwidth depends on the window function used (see Frequency bins).

Frequency bins

The FFT algorithm takes a discrete source waveform, defined over N points, and computes N complex Fourier coefficients, which are interpreted as harmonic components of the input signal.

For a real source waveform (imaginary part equals 0), there are only N/2 independent harmonic components.

The FFT corresponds to analyzing the input signal with a bank of N/2 filters, all having the same shape and width, and centered at N/2 discrete frequencies. Each filter collects the signal energy falling into the immediate neighborhood of its center frequency, and thus it can be said that there are N/2 "frequency bins".

The distance, in Hz, between the center frequencies of the bins is always

$$\Delta f = 1/T$$

where T is the duration of the time domain record in seconds.

The width of a bin is equal to Δf .

The width of the main lobe of the filter centered at each bin depends on the window function used. With the Rectangular window, the width at -3.92 dB is 1.0 bins. Other windows have wider main lobes (consult Table 11.3).

Frequency Range

The range of frequencies computed and displayed in the 9400A is from 0 Hz at the left hand edge of the screen to the Nyquist frequency at 5 or 6.25 divisions.

Frequency Resolution

In a narrow sense, the frequency resolution is equal to the bin width, Δf . That is, if the input signal changes its frequency by Δf , the corresponding spectrum peak will be displaced by Δf . For smaller changes of frequency, only the shape of the peak will change.

However, the effective frequency resolution (i.e. the ability to actually resolve two signals having close frequencies) is further limited by the use of window functions. The ENBW value of all windows other than the rectangular is greater than Δf , i.e. greater than the bin width. Table 11.3 lists the ENBW value for the windows implemented.

Leakage

Observe the Power Spectrum of a sinusoidal waveform having an integral number of periods in the time window (i.e. the source frequency equals one of the bin frequencies), using the Rectangular window. The spectrum contains a sharp component whose value reflects accurately the source waveform's amplitude. For other input frequencies this spectral component is lower and broader.

The broadening of the base of the peak, stretching out into many neighboring bins is termed the leakage. It is due to the relatively high side lobes of the filter associated with each frequency bin.

The filter side lobes and the resulting leakage are reduced when one of the available window functions is applied. The best reduction is provided by the Blackman-Harris and the Flat Top windows. However, this reduction is offset by a broadening of the main lobe of the filter.

Numbers of Points

In the 9400A, FFT is computed over the number of points (Transform Size) selected in the Redefine Menu. The effective number of points, N , is displayed at the bottom of the FFT Redefine Menu screen. It is always a sub-multiple of the number of points actually displayed in the time domain.

FFT generates $N/2$ spectrum points as output. These points are expanded by linear interpolation to 12500 points (10000 points in the case of 10 MHz/div).

Nyquist Frequency

Equal to one half of the total sampling frequency.

Also, $f_{\text{Nyquist}} = \Delta f * N/2$.

In the 9400A, the value of Nyquist frequency is displayed at the bottom of the FFT Redefine Menu screen.

Picket Fence Effect

Observe again the Power Spectrum of a sinusoidal waveform having an integral number of periods in the time window (i.e. the source frequency equals one of the bin frequencies), using the Rectangular window. The spectrum is a sharp peak whose value reflects accurately the source waveform's amplitude. For other input frequencies the spectrum peak is lower and broader.

Its highest point can be lower by 3.92 dB (1.57 times) when the source frequency is half way between two bin frequencies. This variation of the spectrum magnitude is called the Picket Fence Effect (the loss is called the Scallop Loss).

All window functions compensate this loss to some extent but the Flat Top window provides the best correction (see Table 11.3).

Power Spectrum

The Power Spectrum (V^2) is the square of the Magnitude spectrum.

The 9400A displays the Power Spectrum on the dBm scale, with 0 dBm corresponding to $(0.316 V_{\text{peak}})^2$.

Power Density spectrum

The Power Density Spectrum (V^2/Hz) is the Power Spectrum divided by the product of the equivalent noise bandwidth of the filter and the frequency bin width in Hz.

The 9400A displays the Power Density spectrum on the dBm scale, with 0 dBm corresponding to $(0.316 V_{\text{peak}})^2/\text{Hz}$.

Sampling Frequency

In the 9400A the time domain records are acquired at sampling frequencies which depend on the selected time base (consult Table 5.1).

Before FFT, the time domain record may be sub-sampled. If the selected number of points is lower than the displayed record length (Table 5.1), the total sampling frequency will be reduced.

The total sampling frequency equals twice the Nyquist frequency (displayed in the FFT Redefine Menu).

Scallop Loss

Loss associated with the picket fence effect (listed in Table 11.3 for windows implemented).

Window Functions

All window functions implemented in the WPO2 package belong to the sum of cosines family with one to three non-zero cosine terms:

$$w_k = \sum_{m=0}^{m=M-1} a_m \cos \left(\frac{2 * \pi * j * k}{N} \right) \quad 0 \leq k < N$$

where $M = 3$ is the maximum number of terms
 a_m are the coefficients of the terms
 N is the number of points of the source waveform
 k is the time index

Table 11.2 lists the a_m coefficients.

The window functions, seen in the time domain are symmetric about the point $k = N/2$, (mid-screen on the 9400A) where they all have a peak amplitude of 1.0.

Table 11.2 Coefficients of window functions

Window type	a_0	a_1	a_2
Rectangular	1.0	0.0	0.0
von Hann	0.5	-0.5	0.0
Hamming	0.54	-0.46	0.0
Flat-Top	0.281	-0.521	0.198
Blackman-Harris	0.423	-0.497	0.079

Table 11.3 Window frequency domain parameters

Window type	Highest side-lobe loss (dB)	Scallop loss (dB)	ENBW (bins)	Coherent gain (dB)
Rectangular	- 13	3.92	1.0	0.0
von Hann	- 32	1.42	1.5	- 6.02
Hamming	- 43	1.78	1.37	- 5.35
Flat-Top	- 44	0.01	2.96	-11.05
Blackman-Harris	- 67	1.13	1.71	- 7.53

11.7 Errors and Warnings

Certain combinations of source waveform properties and processing functions may result in an error or raise a warning. The appropriate message is displayed at the top of the 9400A screen.

On Error, processing is abandoned.

On Warning, processing is performed, but the results are corrupted.

ERROR: FFT src wfm is in sequence mode.

FFT of sequence mode waveform has not been implemented. Processing abandoned.

ERROR: FFT src wfm is in frequency domain.

FFT of a frequency domain waveform has not been implemented. Processing abandoned.

ERROR: FFT AVG src wfm not in freq domain.

FFT Power Average mode (Function F only) is active only if Function E is defined as FFT. Processing abandoned.

You should define Function E as FFT.

WARNING: FFT src wfm (ils mode) extended.

In the Interleaved Sampling Mode, there are two time-base settings (1 μ sec/div and 0.5 μ sec/div) in which the record of 25000 points shown on the screen is incomplete. Starting at the left hand edge of the screen, 0.08 and 0.4 div respectively are blank. Before computing the FFT, the leftmost valid point of such records is copied leftward, through to the left edge of the screen. This will generate harmonic components not present in the original record.

If possible, you should use the Single-shot mode before FFT at these time-base settings.

WARNING: FFT src wfm (roll mode) incomplete.

In the Roll Mode (time/div \leq 0.5 sec), you can stop the acquisition of a trace before it fills the entire width of the screen. The remaining portion of the record is blank on the display, but the memory contents remain undefined. FFT is computed on this partially undefined record.

You should avoid stopping the acquisition in this manner if you wish to obtain meaningful FFT results.

WARNING: FFT src wfm over/underflow.

The source waveform has been clipped in amplitude, either in the acquisition (too high gain or inappropriate offset) or in the previous processing. The resulting FFT contains harmonic components which were not present in the unclipped waveform.

You should repeat the acquisition or previous processing of the source waveform, with changed settings.

11.8 Table of Nyquist Frequencies

F_{Nyquist}		Number of Points	SS/RIS	Time/div	
25.000	mHz	50	SS	100	sec
62.500	mHz	125	SS	100	sec
0.125	Hz	50	SS	20	sec
0.125	Hz	125	SS	50	sec
0.125	Hz	250	SS	100	sec

F_{Nyquist}		Number of Points	SS/RIS	Time/div	
0.250	Hz	50	SS	10	sec
0.250	Hz	100	SS	20	sec
0.250	Hz	250	SS	50	sec
0.250	Hz	500	SS	100	sec
0.625	Hz	125	SS	10	sec
0.625	Hz	250	SS	20	sec
0.625	Hz	625	SS	50	sec
0.625	Hz	1250	SS	100	sec
1.250	Hz	50	SS	2	sec
1.250	Hz	125	SS	5	sec
1.250	Hz	250	SS	10	sec
1.250	Hz	500	SS	20	sec
1.250	Hz	1250	SS	50	sec
1.250	Hz	2500	SS	100	sec
2.500	Hz	50	SS	1	sec
2.500	Hz	100	SS	2	sec
2.500	Hz	250	SS	5	sec
2.500	Hz	500	SS	10	sec
2.500	Hz	1000	SS	20	sec
2.500	Hz	2500	SS	50	sec
2.500	Hz	5000	SS	100	sec
6.250	Hz	125	SS	1	sec
6.250	Hz	250	SS	2	sec
6.250	Hz	625	SS	5	sec
6.250	Hz	1250	SS	10	sec
6.250	Hz	2500	SS	20	sec
6.250	Hz	6250	SS	50	sec
6.250	Hz	12500	SS	100	sec
12.500	Hz	50	SS	200	msec
12.500	Hz	125	SS	0.5	sec
12.500	Hz	250	SS	1	sec
12.500	Hz	500	SS	2	sec
12.500	Hz	1250	SS	5	sec
12.500	Hz	2500	SS	10	sec
12.500	Hz	5000	SS	20	sec
12.500	Hz	12500	SS	50	sec
12.500	Hz	25000	SS	100	sec

Fast Fourier Waveform Processing
Option (WP02, V 2.06FT)

F _{Nyquist}		Number of Points	SS/RIS	Time/div	
25.000	Hz	50	SS	100	msec
25.000	Hz	100	SS	200	msec
25.000	Hz	250	SS	0.5	sec
25.000	Hz	500	SS	1	sec
25.000	Hz	1000	SS	2	sec
25.000	Hz	2500	SS	5	sec
25.000	Hz	5000	SS	10	sec
25.000	Hz	25000	SS	50	sec
62.500	Hz	125	SS	100	msec
62.500	Hz	250	SS	200	msec
62.500	Hz	625	SS	0.5	sec
62.500	Hz	1250	SS	1	sec
62.500	Hz	2500	SS	2	sec
62.500	Hz	6250	SS	5	sec
62.500	Hz	12500	SS	10	sec
62.500	Hz	25000	SS	20	sec
0.125	kHz	50	SS	20	msec
0.125	kHz	125	SS	50	msec
0.125	kHz	250	SS	100	msec
0.125	kHz	500	SS	200	msec
0.125	kHz	1250	SS	0.5	sec
0.125	kHz	2500	SS	1	sec
0.125	kHz	5000	SS	2	sec
0.125	kHz	12500	SS	5	sec
0.125	kHz	25000	SS	10	sec
0.250	kHz	50	SS	10	msec
0.250	kHz	100	SS	20	msec
0.250	kHz	250	SS	50	msec
0.250	kHz	500	SS	100	msec
0.250	kHz	1000	SS	200	msec
0.250	kHz	2500	SS	0.5	sec
0.250	kHz	5000	SS	1	sec
0.250	kHz	25000	SS	5	sec
0.625	kHz	125	SS	10	msec
0.625	kHz	250	SS	20	msec
0.625	kHz	625	SS	50	msec
0.625	kHz	1250	SS	100	msec
0.625	kHz	2500	SS	200	msec
0.625	kHz	6250	SS	0.5	sec
0.625	kHz	12500	SS	1	sec
0.625	kHz	25000	SS	2	sec

Fast Fourier Waveform Processing
Option (WP02, V 2.06FT)

F_{Nyquist}	Number of Points	RIS/SS	Time/div
1.250 kHz	50	SS	2 msec
1.250 kHz	125	SS	5 msec
1.250 kHz	250	SS	10 msec
1.250 kHz	500	SS	20 msec
1.250 kHz	1250	SS	50 msec
1.250 kHz	2500	SS	100 msec
1.250 kHz	5000	SS	200 msec
1.250 kHz	12500	SS	0.5 sec
1.250 kHz	25000	SS	1 sec
2.500 kHz	50	SS	1 msec
2.500 kHz	100	SS	2 msec
2.500 kHz	250	SS	5 msec
2.500 kHz	500	SS	10 msec
2.500 kHz	1000	SS	20 msec
2.500 kHz	2500	SS	50 msec
2.500 kHz	5000	SS	100 msec
2.500 kHz	25000	SS	0.5 sec
6.250 kHz	125	SS	1 msec
6.250 kHz	250	SS	2 msec
6.250 kHz	625	SS	5 msec
6.250 kHz	1250	SS	10 msec
6.250 kHz	2500	SS	20 msec
6.250 kHz	6250	SS	50 msec
6.250 kHz	12500	SS	100 msec
6.250 kHz	25000	SS	200 msec
12.500 kHz	50	SS	0.2 msec
12.500 kHz	125	SS	0.5 msec
12.500 kHz	250	SS	1 msec
12.500 kHz	500	SS	2 msec
12.500 kHz	1250	SS	5 msec
12.500 kHz	2500	SS	10 msec
12.500 kHz	5000	SS	20 msec
12.500 kHz	12500	SS	50 msec
12.500 kHz	25000	SS	100 msec
25.000 kHz	50	SS	0.1 msec
25.000 kHz	100	SS	0.2 msec
25.000 kHz	250	SS	0.5 msec
25.000 kHz	500	SS	1 msec
25.000 kHz	1000	SS	2 msec
25.000 kHz	2500	SS	5 msec
25.000 kHz	5000	SS	10 msec
25.000 kHz	25000	SS	50 msec

Fast Fourier Waveform Processing
Option (WP02, V 2.06FT)

F_{Nyquist}	Number of Points	SS/RIS	Time/div
62.500 kHz	125	SS	0.1 msec
62.500 kHz	250	SS	0.2 msec
62.500 kHz	625	SS	0.5 msec
62.500 kHz	1250	SS	1 msec
62.500 kHz	2500	SS	2 msec
62.500 kHz	6250	SS	5 msec
62.500 kHz	12500	SS	10 msec
62.500 kHz	25000	SS	20 msec
125.000 kHz	50	SS	20 μ sec
125.000 kHz	125	SS	50 μ sec
125.000 kHz	250	SS	0.1 msec
125.000 kHz	500	SS	0.2 msec
125.000 kHz	1250	SS	0.5 msec
125.000 kHz	2500	SS	1 msec
125.000 kHz	5000	SS	2 msec
125.000 kHz	12500	SS	5 msec
125.000 kHz	25000	SS	10 msec
250.000 kHz	50	SS	10 μ sec
250.000 kHz	100	SS	20 μ sec
250.000 kHz	250	SS	50 μ sec
250.000 kHz	500	SS	0.1 msec
250.000 kHz	1000	SS	0.2 msec
250.000 kHz	2500	SS	0.5 msec
250.000 kHz	5000	SS	1 msec
250.000 kHz	25000	SS	5 msec
625.000 kHz	125	SS	10 μ sec
625.000 kHz	250	SS	20 μ sec
625.000 kHz	625	SS	50 μ sec
625.000 kHz	1250	SS	0.1 msec
625.000 kHz	2500	SS	0.2 msec
625.000 kHz	6250	SS	0.5 msec
625.000 kHz	12500	SS	1 msec
625.000 kHz	25000	SS	2 msec
1.250 MHz	50	SS/RIS	2 μ sec
1.250 MHz	125	SS	5 μ sec
1.250 MHz	250	SS	10 μ sec
1.250 MHz	500	SS	20 μ sec
1.250 MHz	1250	SS	50 μ sec
1.250 MHz	2500	SS	0.1 msec
1.250 MHz	5000	SS	0.2 msec
1.250 MHz	12500	SS	0.5 msec
1.250 MHz	25000	SS	1 msec

Fast Fourier Waveform Processing
Option (WP02, V 2.06FT)

F_{Nyquist}		Number of Points	SS/RIS	Time/div
2.500	MHz	50	SS/RIS	1 μsec
2.500	MHz	100	SS/RIS	2 μsec
2.500	MHz	250	SS	5 μsec
2.500	MHz	500	SS	10 μsec
2.500	MHz	1000	SS	20 μsec
2.500	MHz	2500	SS	50 μsec
2.500	MHz	5000	SS	0.1 msec
2.500	MHz	25000	SS	0.5 msec
6.250	MHz	125	SS/RIS	1 μsec
6.250	MHz	250	SS/RIS	2 μsec
6.250	MHz	625	SS	5 μsec
6.250	MHz	1250	SS	10 μsec
6.250	MHz	2500	SS	20 μsec
6.250	MHz	6250	SS	50 μsec
6.250	MHz	12500	SS	0.1 msec
6.250	MHz	25000	SS	0.2 msec
12.500	MHz	50	SS/RIS	0.2 μsec
12.500	MHz	125	SS/RIS	0.5 msec
12.500	MHz	250	SS/RIS	1 μsec
12.500	MHz	500	SS/RIS	2 μsec
12.500	MHz	1250	SS	5 μsec
12.500	MHz	2500	SS	10 μsec
12.500	MHz	5000	SS	20 μsec
12.500	MHz	12500	SS	50 μsec
12.500	MHz	25000	SS	0.1 msec
25.000	MHz	50	SS/RIS	0.1 μsec
25.000	MHz	100	SS/RIS	0.2 μsec
25.000	MHz	250	SS/RIS	0.5 μsec
25.000	MHz	500	SS/RIS	1 μsec
25.000	MHz	1000	SS/RIS	2 μsec
25.000	MHz	2500	SS	5 μsec
25.000	MHz	5000	SS	10 μsec
25.000	MHz	25000	SS	50 μsec
50.000	MHz	50	SS/RIS	50 nsec
50.000	MHz	100	SS/RIS	0.1 μsec
50.000	MHz	200	SS/RIS	0.2 μsec
50.000	MHz	500	SS/RIS	0.5 μsec
50.000	MHz	1000	SS/RIS	1 μsec
50.000	MHz	2000	SS	2 μsec
50.000	MHz	5000	SS	5 μsec
50.000	MHz	10000	SS	10 μsec
50.000	MHz	20000	SS	20 μsec

Fast Fourier Waveform Processing
Option (WP02, V 2.06FT)

F_{Nyquist}		Number of Points	SS/RIS	Time/div
125.000	MHz	50	RIS	20 nsec
125.000	MHz	125	RIS	50 nsec
125.000	MHz	250	RIS	0.1 μ sec
125.000	MHz	500	RIS	0.2 μ sec
125.000	MHz	1250	RIS	0.5 μ sec
125.000	MHz	2500	RIS	1 μ sec
125.000	MHz	5000	RIS	2 μ sec
250.000	MHz	50	RIS	10 nsec
250.000	MHz	100	RIS	20 nsec
250.000	MHz	250	RIS	50 nsec
250.000	MHz	500	RIS	0.1 μ sec
250.000	MHz	1000	RIS	0.2 μ sec
250.000	MHz	2500	RIS	0.5 μ sec
250.000	MHz	5000	RIS	1 μ sec
625.000	MHz	125	RIS	10 nsec
625.000	MHz	250	RIS	20 nsec
625.000	MHz	625	RIS	50 nsec
625.000	MHz	1250	RIS	0.1 μ sec
625.000	MHz	2500	RIS	0.2 μ sec
625.000	MHz	6250	RIS	0.5 μ sec
625.000	MHz	12500	RIS	1 μ sec
625.000	MHz	25000	RIS	2 μ sec
1250.000	MHz	50	RIS	2 nsec
1250.000	MHz	125	RIS	5 nsec
1250.000	MHz	250	RIS	10 nsec
1250.000	MHz	500	RIS	20 nsec
1250.000	MHz	1250	RIS	50 nsec
1250.000	MHz	2500	RIS	0.1 μ sec
1250.000	MHz	5000	RIS	0.2 μ sec
1250.000	MHz	12500	RIS	0.5 μ sec
1250.000	MHz	25000	RIS	1 μ sec
2500.000	MHz	100	RIS	2 nsec
2500.000	MHz	250	RIS	5 nsec
2500.000	MHz	500	RIS	10 nsec
2500.000	MHz	1000	RIS	20 nsec
2500.000	MHz	2500	RIS	50 nsec
2500.000	MHz	5000	RIS	0.1 μ sec
2500.000	MHz	25000	RIS	0.5 μ sec

11.9 References

Bergland, G. D., "A Guided Tour of the Fast Fourier Transform", IEEE Spectrum, July 1969, pp. 41 - 52.

A general introduction to FFT theory and applications.

Harris, F. J., "On the Use of Windows for Harmonic Analysis with the Discrete Fourier Transform", Proceedings of the IEEE, vol 66, No 1, January 1978, pp. 51 - 83.

Classical paper on window functions and their figures of merit, with many examples of windows.

Brigham, E. O., "The Fast Fourier Transform", Prentice Hall, Inc., Englewood Cliffs, N. J., 1974.

Theory, applications and implementation of FFT. Includes discussion of FFT algorithms for N not a power of 2.

Ramirez, R. W., "The FFT Fundamentals and Concepts", Prentice Hall, Inc., Englewood Cliffs, N. J., 1985.

Practice oriented, many examples of applications.

11.10 Index of Topics

<u>Paragraph</u>	<u>Topic</u>
11.6	Aliasing
11.6	Coefficients of window functions in tabular form
11.6	Coherent gain
11.5.2	Computation of dBm power spectrum
11.5.2	Computation of magnitude
11.5.2	Computation of real/imaginary parts
11.5.3	Computation speed of FFT
11.4.2	Description of additional values of FFT descriptors
11.4.1	Description of remote FFT commands
11.6	Equivalent Noise Bandwidth (ENBW)
11.7	Error and warning messages
11.5	FFT processing, application hints
11.4.1	FFT processing, description of remote control commands
11.3	FFT processing, examples
11.5.1	FFT processing, practical rules for using FFT processing
11.5.2	FFT processing, steps involved in calculating the FFT
11.6	FFT/9400A Glossary
11.6	Filters
11.6	Frequency bins
11.6	Frequency range
11.6	Frequency resolution
11.6	Leakage
11.2	Modification to WPO1 functions
11.6	Number of points used for computing the FFT
11.6	Nyquist frequency
11.8	Nyquist frequency table
11.6	Picket fence effect
11.6	Power spectrum
11.6	Power density spectrum
11.1	Processing capabilities of FFT option
11.9	References
11.6	Sampling frequency
11.6	Scallop loss
11.6	Window frequency domain parameters in tabular form
11.6	Window functions

A P P E N D I X

Index of remote commands (GPIB and RS-232-C)

This index groups all remote commands described in sections 7, 10 and 11 of this manual. All commands listed in this index are common to both the GPIB and the RS-232-C interfaces.

For convenience, the commands as well as their abridged forms have been arranged in alphabetical order. The number on the right hand side refers to the paragraph section where the command is defined.

AUTO_STORE(AS)	7.6.6	3)
AVERAGE_RESET (ARST)	10.3	1)
BANDWIDTH (BW)	7.6.2	14)
CALIBRATE (CAL)	7.6.6	1)
CALL_HOST (CH)	7.6.6	4)
CHANNEL_1_ATTENUATION (C1AT)	7.6.2	11)
CHANNEL_2_ATTENUATION (C2AT)	7.6.2	11)
CHANNEL_1_COUPLING (C1CP)	7.6.2	13)
CHANNEL_2_COUPLING (C2CP)	7.6.2	13)
CHANNEL_1_OFFSET (C1OF)	7.6.2	12)
CHANNEL_2_OFFSET (C2OF)	7.6.2	12)
CHANNEL_1_VOLT/DIV (C1VD)	7.6.2	10)
CHANNEL_2_VOLT/DIV (C2VD)	7.6.2	10)
COMM_BLOCKSIZE (CBL5)	7.6.7	5)
COMM_FORMAT (CFMT)	7.6.7	4)
COMM_HEADER (CHDR)	7.6.7	1)
COMM_HELP (CHLP)	7.6.7	3)
COMM_PROMPT (CPRM)	7.6.7	7)
COMM_STRDELIM (CSDE)	7.6.7	6)
COMM_TRAILER (CTRL)	7.6.7	2)

DUAL_GRID (DG)	7.6.3	1)
HOR_POSITION (HP)	7.6.3	7)
IDENTIFY (ID)	7.6.6	5)
INSPECT, CHANNEL_1 (INS C1)	7.6.5	6)
CHANNEL_2 (INS C2)	7.6.5	6)
FUNCTION_E (INS FE)	10.3	2)
FUNCTION_F (INS FF)	10.3	2)
MEMORY_C (INS MC)	7.6.5	6)
MEMORY_D (INS MD)	7.6.5	6)
INTERLEAVED (IL)	7.6.2	2)
KEY	7.6.3	10)
MASK	7.6.8	2)
MESSAGE (MSG)	7.6.3	9)
PLOTTER (PT)	7.6.4	1)
PLOT_SIZE (PS)	7.6.4	2)
PROBE_CAL (PC)	7.6.6	2)
READ, CHANNEL_1 (RD C1)	7.6.5	4)
CHANNEL_2 (RD C2)	7.6.5	4)
FUNCTION_E (RD FE)	10.3	4)
FUNCTION_F (RD FF)	10.3	4)
MEMORY_C (RD MC)	7.6.5	4)
MEMORY_D (RD MD)	7.6.5	4)
RECALL (REC)	7.6.5	2)
REDEFINE, ARITHMETIC (RDF ARI)	10.3	3)
AVERAGE (RDF AVG)	10.3	3)
CHANNEL_1 (RDF C1)	7.6.3	8)
CHANNEL_2 (RDF C2)	7.6.3	8)
EXTREMA (RDF EXTR)	10.3	3)
FFT (RDF FFT)	11.4.1	
FUNCTIONS (RDF FNC)	10.3	3)
MEMORY_C (RDF MC)	7.6.3	8)
MEMORY_D (RDF MD)	7.6.3	8)
SMOOTHING (RDF SMO)	10.3	3)
SCREEN_DUMP (SD)	7.6.4	3)

SEGMENTS (SEG)	7.6.2	9)
SELECT (SEL)	7.6.3	3)
SETUP (SU)	7.6.5	3)
STB	7.6.8	1)
STOP	7.6.2	15)
STORE (STO)	7.6.5	1)
TIME/DIV (TD)	7.6.2	1)
TIME_MAGNIFIER (TM)	7.6.3	6)
TRACE_CHANNEL_1 (TRC1)	7.6.3	2)
TRACE_CHANNEL_2 (TRC2)	7.6.3	2)
TRACE_EXPAND_A (TREA)	7.6.3	2)
TRACE_EXPAND_B (TREB)	7.6.3	2)
TRACE_MEMORY_C (TRMC)	7.6.3	2)
TRACE_MEMORY_D (TRMD)	7.6.3	2)
TRACE_FUNCTION_E (TRFE)	7.6.3	2)
TRACE_FUNCTION_F (TRFF)	7.6.3	2)
TRANSMIT (TX)	7.6.4	4)
TRIG_COUPLING (TRC)	7.6.2	5)
TRIG_DELAY (TRD)	7.6.2	3)
TRIG_LEVEL (TRL)	7.6.2	4)
TRIG_MODE (TRM)	7.6.2	6)
TRIG_SLOPE (TRP)	7.6.2	8)
TRIG_SOURCE (TRS)	7.6.2	7)
TSTB	7.6.8	3)
VERT_GAIN (VG)	7.6.3	4)
VERT_POSITION (VP)	7.6.3	5)
WAIT	7.6.6	6)
WRITE, MEMORY_C (WT,MC)	7.6.5	5)
MEMORY_D (WT,MD)	7.6.5	5)

Additional RS-232-C only remote commands

This subsection contains only those remote commands which are specific to RS-232-C communication.

<ESC> <	7.6.10 7)
<ESC> L	7.6.10 10)
<ESC> (7.6.10 3)
<ESC>)	7.6.10 4)
<ESC> C	7.6.10 11)
<ESC> R	7.6.10 9)
<ESC> T	7.6.10 12)
<ESC> [7.6.10 5)
<ESC>]	7.6.10 6)
RS_CONF	7.6.10 1)
RS_SRQ	7.6.10 2)