

Operator's Manual

LeCroy

9300C Series

Digital Oscilloscopes

Revision A — January 1998





LeCroy

LeCroy Corporation

700 Chestnut Ridge Road
Chestnut Ridge, NY 10977-6499
Tel: (845) 578 6020, Fax: (845) 578 5985

LeCroy SA

2, rue du Pré-de-la-Fontaine
1217 Meyrin 1/Geneva, Switzerland
Tel: (41) 22 719 21 11, Fax: (41) 22 782 39 15

Internet: www.lecroy.com

Copyright © January 1998, LeCroy. All rights reserved. Information in this publication supersedes all earlier versions. Specifications subject to change.

LeCroy, ProBus and SMART Trigger are registered trademarks of LeCroy Corporation. MathCad is a registered trademark of MATHSOFT Inc. Centronics is a registered trademark of Data Computer Corp. Epson is a registered trademark of Epson America Inc. PowerPC is a registered trademark of IBM Microelectronics. MATLAB is a registered trademark of The MathWorks, Inc. DeskJet, ThinkJet, QuietJet, LaserJet, PaintJet, HP 7470 and HP 7550 are registered trademarks of Hewlett-Packard Company. I²C is a trademark of Philips.

<p>Manufactured under an ISO 9000 Registered Quality Management System Visit www.lecroy.com to view the certificate.</p>		<p>This electronic product is subject to disposal and recycling regulations that vary by country and region. Many countries prohibit the disposal of waste electronic equipment in standard waste receptacles. For more information about proper disposal and recycling of your LeCroy product, please visit www.lecroy.com/recycle.</p>
--	--	--





Chapter 1 – Read This First!
Product and Client Care.....1-1

Chapter 2 – Instrument Architecture
General Designed Capabilities2-1
Block Diagrams.....2-4

Chapter 3 – Installation and Safety 
Installation for Safe and Efficient Operation.....3-1

Chapter 4 – Introduction to the Controls
The Front Panel.....4-1
The Main Controls4-3
Choosing and Navigating in Menus4-4
System Setup and Menu Controls4-6
Screen Topography4-8

Chapter 5 – CHANNELS, Coupling and Probes
Channel Controls..... 5-1
Coupling.....5-3
Probes and Probe Calibration5-4

Chapter 6 – TIMEBASE + TRIGGER
TIMEBASE + TRIGGER Controls.....6-1

Chapter 7 – Timebase Modes and Setup
Timebase Sampling Modes7-1
Timebase Setup.....7-5





Chapter 8 – Triggers and When to Use Them

Choosing the Right Trigger8-1
Edge or SMART?8-2
Edge Trigger8-3
TRIGGER SETUP: Edge8-9
SMART Triggers8-10
TRIGGER SETUP: SMART 8-29

Chapter 9 – ZOOM + MATH

Zoom and Math Controls 9-1

Chapter 10 – Zoom, Mathematics and Math Setup

Zooming for Precise Waveform Measurements 10-1
Math Functions and Options 10-2
Using Waveform Mathematics 10-5
Configuring for Zoom and Math..... 10-6
Setting Up FFT Span and Resolution10-17

Chapter 11 – Display

Setting Up the Display 11-1

Chapter 12 – UTILITIES

Printing, Storing, Using Special Modes 12-1
Hardcopy Setup 12-2
Time/Date Setup 12-4
GPIB/RS232 Setup 12-5
Mass Storage Utilities 12-7
Special Modes 12-19
CAL BNC Setup 12-21

Chapter 13 – WAVEFORM STORE & RECALL

Waveform Store 13-1
Waveform Recall 13-4

Chapter 14 – CURSORS/MEASURE & Parameters

Cursors: Tools for Measuring Signal Values..... 14-1
Parameters: Automatic Measurements 14-4
Pass/Fail Testing.....14-13

Chapter 15 – PANEL SETUPS

Saving and Recalling Panel Setups..... 15-1

Chapter 16 – SHOW STATUS

The Complete Picture – Summarized..... 16-1

Appendix A – Specifications



Appendix B – Enhanced Resolution

Appendix C – Fast Fourier Analysis (FFT)

Appendix D – Parameter Measurement

Appendix E – ASCII-Stored Files

Product and Client Care

We recommend you thoroughly inspect the contents of the scope packaging at once. Check all the contents against the packing list/invoice copy shipped with the instrument and the list on page 1–3 of this manual. Unless LeCroy is notified promptly of a missing or damaged item, we cannot accept responsibility for its replacement. Contact your national LeCroy Customer Service Department or local office immediately (*contact numbers follow index*).

Warranty

LeCroy warrants its oscilloscope products for normal use and operation within specifications for a period of three years from the date of shipment. Calibration each year is recommended to ensure in-spec performance. Spares, replacement parts and repairs are warranted for 90 days. The instrument's firmware has been thoroughly tested and is thought to be functional, but is supplied without warranty of any kind covering detailed performance. Products not made by LeCroy are covered solely by the warranty of the original equipment manufacturer.

In exercising its warranty, LeCroy will repair or, at its option, replace any product returned within the warranty period to the Customer Service Department or an authorized service center. However, this will be done only if the product is determined by LeCroy's examination to be defective due to workmanship or materials, and the defect has not been caused by misuse, neglect or accident, or by abnormal conditions or operation.

Note: This warranty replaces all other warranties, expressed or implied, including but not limited to any implied warranty of merchantability, fitness, or adequacy for any particular purpose or use. LeCroy shall not be liable for any special, incidental, or consequential damages, whether in contract or otherwise. The client will be responsible for the transportation and insurance charges for the return of products to the service facility. LeCroy will return all products under warranty with transport prepaid.



Product Assistance

Help on installation, calibration, and the use of LeCroy equipment is available from the LeCroy Customer Service Department in your country (see *contact numbers following the index*).

Maintenance Agreements

We provide a variety of customer support services. Maintenance agreements give extended warranty and allow our clients to budget maintenance costs after the initial three-year warranty has expired. Other services such as installation, training, enhancements and on-site repairs are available through special Supplemental Support Agreements.

Staying Up to Date

LeCroy is dedicated to offering state-of-the-art instruments, continually refining and improving the performance of our products. Because of the speed with which physical modifications may be implemented, this manual and related documentation may not agree in every detail with the products they describe. For example, there might be small discrepancies in the values of components affecting pulse shape, timing or offset, and — infrequently — minor logic changes.

However, be assured the scope itself is in full order and incorporates the most up-to-date circuitry.

We frequently update firmware or software during servicing to improve scope performance, free of charge during warranty. We will keep you up to date with such changes, through new or revised manuals and other publications.

But you should retain this, the original manual, for future reference to your scope's unchanged hardware specifications.

Service and Repair

Please return products requiring maintenance to the Customer Service Department in your country or to an authorized service facility. LeCroy will repair or replace any product under warranty free of charge. The customer is responsible for transportation charges to the factory, whereas all in-warranty products will be returned to you with transportation prepaid. Outside the warranty period, you will need to provide us with a purchase order number before we can repair your LeCroy product. You will be



billed for parts and labor related to the repair work, and for shipping.



How to Return a Product Contact your country's Customer Service Department or local field office to find out where to return the product. All returned products should be identified by model and serial number. You should describe the defect or failure, and provide your name and contact number. And in the case of products returned to the factory, a Return Authorization Number (RAN) should be used. The RAN can be obtained by contacting the Customer Service Department.

Return shipments should be made prepaid. We cannot accept COD (Cash On Delivery) or Collect Return shipments. We recommend air-freighting.

It is important that the RAN be clearly shown on the outside of the shipping package for prompt redirection to the appropriate LeCroy department.

What Comes with Your Scope

The following items are shipped together with the standard configuration of this oscilloscope:

- Front Scope Cover
- 10:1 10 M Ω Passive Probe — *one per channel*
- ProBus™ Single-Channel Adapter (**9354C, 9374C, 9384C SERIES ONLY**)
- Two 250 V T-rated Fuses (5 A or 6.3 A depending on model — *see Chapter 3*)
- AC Power Cord and Plug
- *Operator's Manual* (this manual)
- *Remote Control Manual*
- *Hands-On Guide*
- Performance Certificate
- Declaration of Conformity
- Warranty

Note: Wherever possible, please use the original shipping carton. If a substitute carton is used, it should be rigid and packed so that that the product is surrounded by a minimum of four inches or 10 cm of shock-absorbent material.

General Designed Capabilities

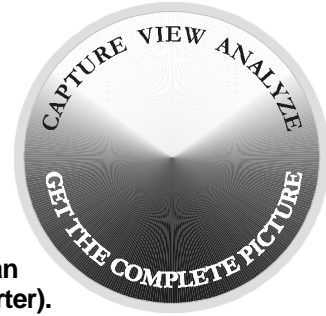

Your oscilloscope is the newest version of a series that set the standard for monochrome DSOs (Digital Storage Oscilloscopes). Each of the scope's channels has an 8-bit ADC (Analog-to-Digital Converter).

On the higher-range models, combining two channels doubles the scope's sampling rate. While on high-range, four-channel models, combining all channels increases the original rate by four times.

Processors

The central microprocessor performs the scope's computations and controls its operation. A wide range of peripheral interfaces allow remote control, storage and printing. A support processor constantly monitors the front-panel controls, rapidly reconfiguring setups. Data processing is also rapid, with data being transferred to the display memory for direct waveform display or stored in the reference memories (see below).

Note: Wherever a feature is specific to a particular model, or not included with a model, it is indicated thus: 9314C ONLY, for example. For the complete list of specifications for each model, see the section on that model or its series in Appendix A.

ADCs

The instrument's multiple-ADC architecture ensures absolute amplitude and phase correlation, maximum ADC performance for multi-channel acquisitions, large record lengths and excellent time resolution.

Memories

The copious acquisition memories simplify transient capture by producing long waveform records that capture even when trigger-timing or signal-speed is uncertain. Combining channels also increases the acquisition memory length. There are four memories for temporary storage, and four more for waveform zooming and processing.

RIS

Repetitive signals can be acquired and stored at a Random Interleaved Sampling (RIS) rate of 10 GS/s. RIS is a high-precision digitizing technique that enables measurement of repetitive signals to the instrument's full bandwidth, with an effective sampling interval of 100 ps and measurement resolution of 10 ps. (See *Chapter 7*).

Trigger System

The Trigger System offers an extensive range of capabilities, selected according to the character of the signal, using on-screen menus and front-panel controls. In standard trigger mode these menus and controls enable the selection and setting of parameters such as pre- and post-trigger recording, as well as special modes. The trigger source can be any of the input channels, line (synchronized to the scope's main input supply) or external. The coupling is selected from AC, LF REJect, HF REJect, HF, and DC; the slope from positive and negative. (See *Chapter 8*.)

Automatic Calibration

The oscilloscope's automatic calibration ensures an overall vertical accuracy of typically 1% of full scale. Vertical gain and offset calibration take place each time the volts/div setting is modified. In addition, periodic calibration is performed to ensure long-term stability at the current setting.

Display System

The display's interactive, user-friendly interface is controlled by push-buttons and knobs (see *Chapter 4*).

The large, 12.5 × 17.5 cm (nine-inch diagonal) screen shows waveforms and data with enhanced resolution on a variety of grid styles (see *Chapter 11*). Up to four waveforms can be displayed at once, while the parameters controlling signal acquisition are simultaneously reported. The screen presents internal status and measurement results, as well as operational, measurement, and waveform-analysis menus.

Printing or copying the screen on plotter, printer or to a recording medium is done by pressing the front-panel SCREEN-DUMP button (See *Chapter 12*).

Manual or Remote Control

Despite being a truly digital instrument, the scope has a front-panel layout and controls that will be familiar to users of analog oscilloscopes. Rapid instrument response and instant representation of waveforms on the high-resolution screen add to this impression.

Four front-panel setups can be stored internally and recalled either manually or by remote control, thus ensuring rapid front-panel configuration. When the power is switched off, the current front-panel settings are automatically stored for subsequent recall at the next power-on.

The oscilloscope has also been designed for remote control operation in automated testing and computer-aided measurement applications — operations described in the *Remote Control Manual*. The entire measurement process, including cursor and pulse-parameter settings, dynamic modification of front-panel settings, and display organization, is controlled through the rear-panel GPIB (IEEE-488) and RS-232-C ports (see *Chapter 12*).

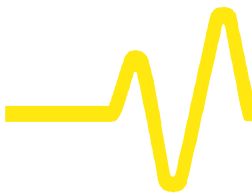

Block Diagrams

➤ **9304C, Series** **9310C,** **9314C**

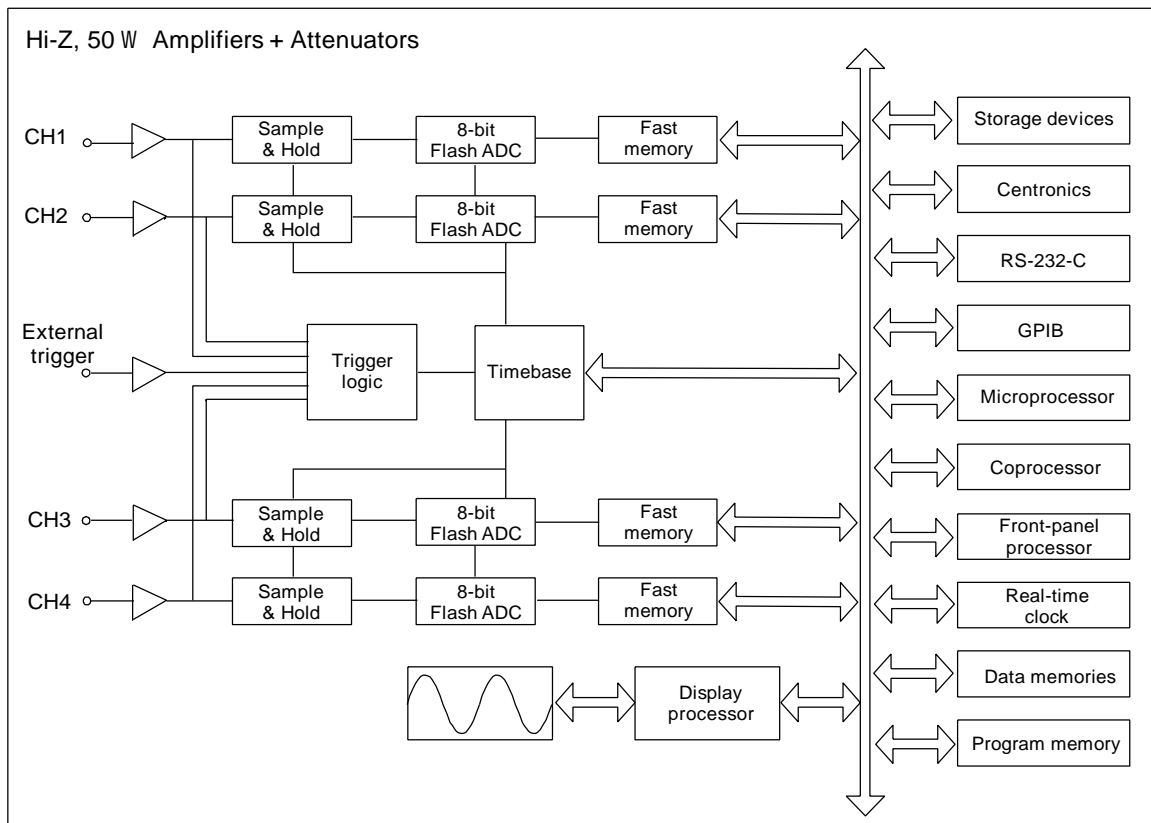

➤ **9344C, 9350C, 9354C Series**

➤ **9370C, 9374C Series**

➤ **9384C Series**

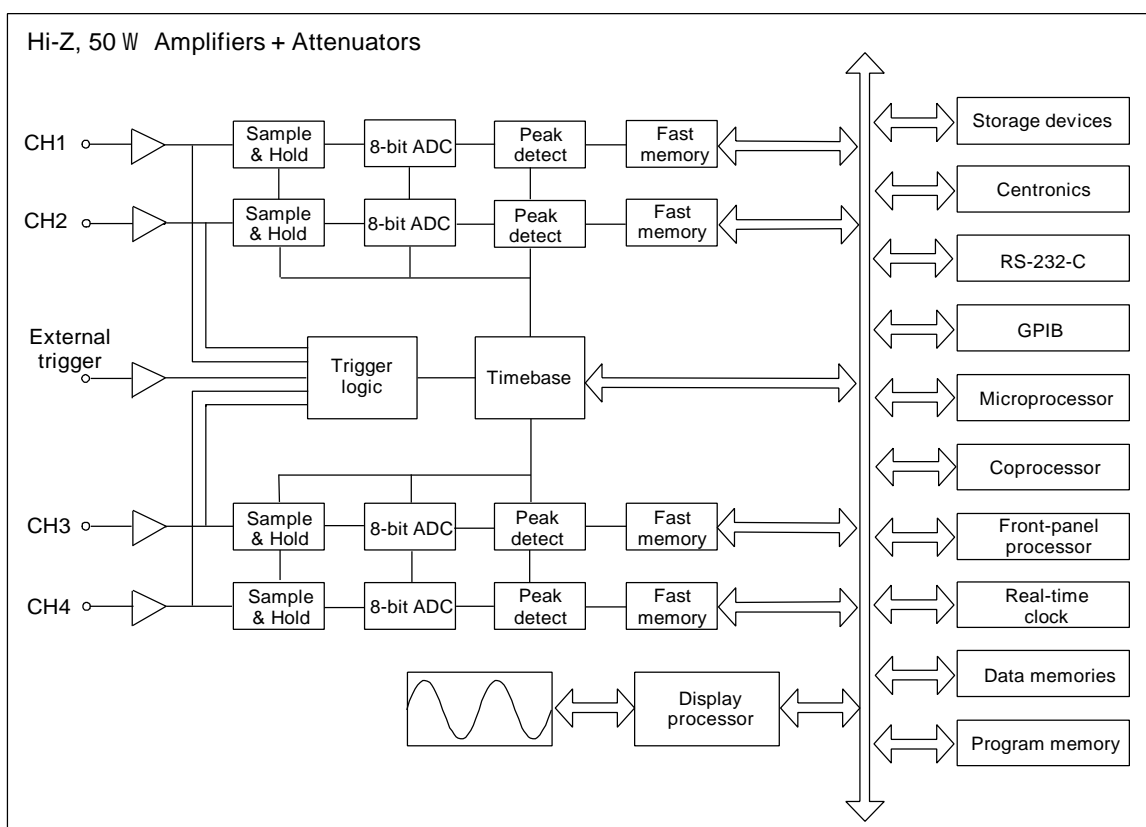

Installation for Safe and Efficient Operation

The oscilloscope will operate to its specifications if the operating environment is maintained within the following parameters:



- Operating Environment**
- Temperature..... 5 to 40 °C (41 to 104 °F) rated.
 - Humidity Maximum relative humidity 80 % RH (non-condensing) for temperatures up to 31 °C decreasing linearly to 50% relative humidity at 40 °C
 - Altitude < 2000 m (6560 ft)

The oscilloscope has been qualified to the following EN61010-1 category:





- Protection ClassI
- Installation (Overvoltage) CategoryII
- Pollution Degree.....2

Safety Symbols

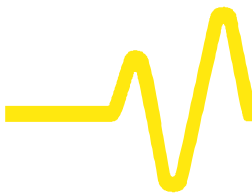
Where the following symbols or indications appear on the instrument's front or rear panels, or elsewhere in this manual, they alert the user to an aspect of safety.

Symbol	Meaning
	CAUTION: Refer to accompanying documents (for Safety-related information). <i>See elsewhere in this manual wherever the symbol is present, as indicated in the Table of Contents.</i>
	CAUTION: Risk of electric shock.
	On (Supply).

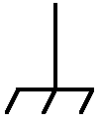

Symbol	Meaning
	Off (Supply)
	Earth (Ground) Terminal
	Protective Conductor Terminal
	Chassis Terminal
	Earth (Ground) Terminal on BNC Connectors
WARNING	Denotes a hazard. If a WARNING is indicated on the instrument, do not proceed until its conditions are understood and met.



WARNING

Any use of this instrument in a manner not specified by the manufacturer may impair the instrument's safety protection. The oscilloscope has *not* been designed to make direct measurements on the human body. Users who connect a LeCroy oscilloscope directly to a person do so at their own risk. Use only indoors.



Power Requirements The oscilloscope operates from a 115 V (90 to 132 V) or 220 V (180 to 250 V) AC power source at 45 Hz to 66 Hz.

No voltage selection is required, since the instrument automatically adapts to the line voltage present.

Fuses

The oscilloscope's power supply is protected against short-circuit and overload by means of two "T"-rated fuses of type according to scope model:

- **6.3 A/250 V AC** **9344C, 9350C, 9354C, 9370C, 9374C, 9384C Series**
- **5 A/250 V AC** **9304C, 9310C, 9314C Series.**

The fuses are located above the mains plug. Disconnect the power cord before inspecting or replacing a fuse. Open the fuse box by inserting a small screwdriver under the plastic cover and prying it open. For continued fire protection at all line voltages, replace only with fuses of the specified type and rating (*see above*).

Ground

The oscilloscope has been designed to operate from a single-phase power source, with one of the current-carrying conductors (neutral conductor) at ground (earth) potential. Maintain the ground line to avoid an electric shock. None of the current-carrying conductors may exceed 250 V rms with respect to ground potential. The oscilloscope is provided with a three-wire electrical cord containing a three-terminal polarized plug for mains voltage and safety ground connection. The plug's ground terminal is connected directly to the frame of the unit. For adequate protection against electrical hazard, this plug must be inserted into a mating outlet containing a safety ground contact.

Cleaning and Maintenance

Maintenance and repairs should be carried out exclusively by a LeCroy technician (*see Chapter 1*). Cleaning should be limited to the exterior of the instrument only, using a damp, soft cloth. Do not use chemicals or abrasive elements. Under no circumstances should moisture be allowed to penetrate the oscilloscope. To avoid electric shocks, disconnect the instrument from the power supply before cleaning.



CAUTION

Risk of electrical shock: No user-serviceable parts inside. Leave repair to qualified personnel.

Power On

Connect the oscilloscope to the power outlet and switch it on by pressing the power switch located on the rear panel. After the instrument is switched on, auto-calibration is performed and a test of the oscilloscope's ADCs and memories is carried out. The full testing procedure takes approximately 10 seconds, after which time a display will appear on the screen.

Two-Channel Front Panel

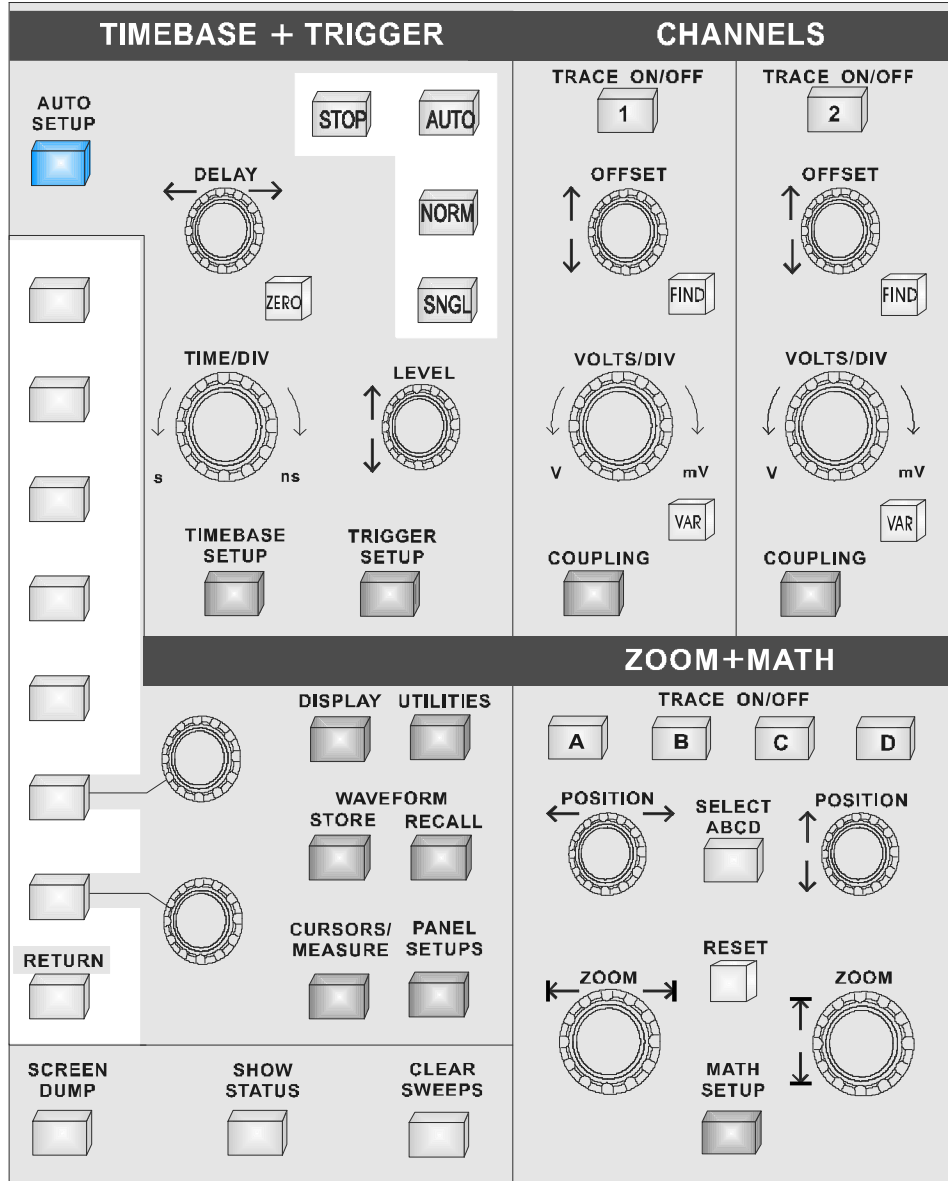



Four-Channel Front Panel

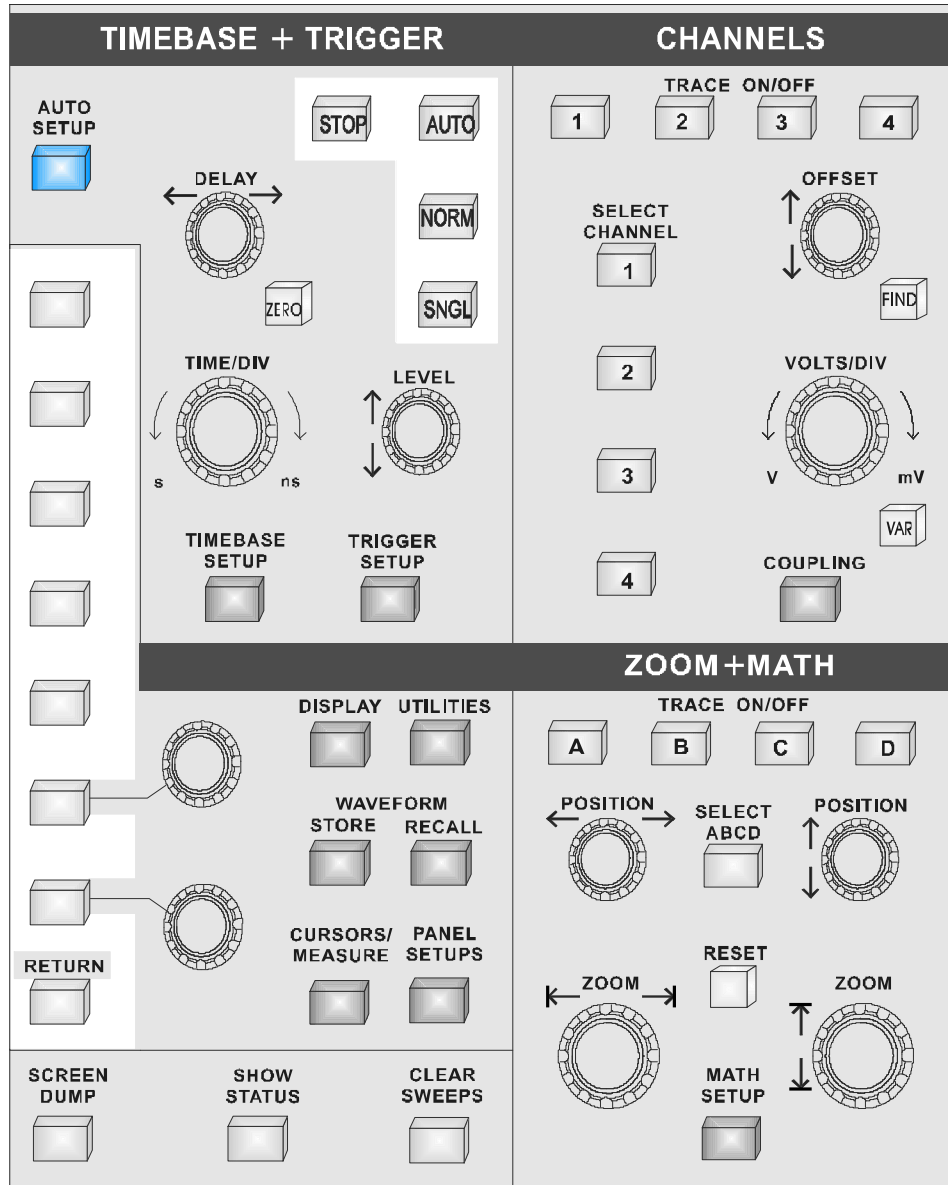

The Main Controls

The front panel controls are divided into four main groups of buttons and knobs: the System Setup and menu controls, CHANNELS, TIMEBASE + TRIGGER and ZOOM + MATH.

System Setup

Dark-gray, menu-*entry* buttons, also represented in the other groups of controls, provide access to the main on-screen menus and the acquisition, processing and display modes of the instrument.

The SCREEN DUMP, SHOW STATUS and CLEAR SWEEPS buttons, respectively: copy or print the screen display, show on-screen summaries of the scope's status, and restart operations that require several acquisitions. See page 4–6.

Menu Buttons & Knobs

The seven untitled buttons vertically aligned beside the screen, RETURN and the two linked rotary knobs enable on-screen menu selection. See following pages.

CHANNELS

This group offers selection of displayed traces and adjustment of vertical sensitivity and offset. See Chapter 5.

AUTO SETUP

This singular blue button automatically adjusts the scope to acquire and display signals on the input channels. See Chapter 6.

TIMEBASE + TRIGGER

These controls allow direct adjustment of time/division, trigger level and delay, as well as access to the “TIMEBASE” and “TRIGGER” menu groups. See Chapters 6, 7 and 8.

ZOOM + MATH

And this group controls trace selection, movement, definition, and expansion with Zoom and Math functions. See Chapters 9 and 10.

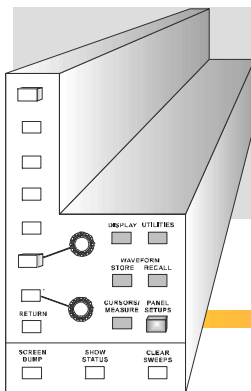

See also “Getting Started”, Part 2 of the Hands-On Guide, for more on the front-panel and a complete run-through of the controls...

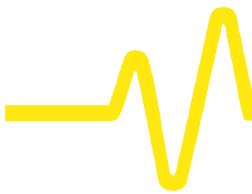

Choosing and Navigating in Menus

On-screen menus — the panels running down the right-hand side of the screen — are used to select specific scope actions and settings. All other on-screen text is for information only. The menus are broadly grouped according to function. The name of each menu group is shown at the top of the column of menus. Individual menus also have names in the top of their frames.

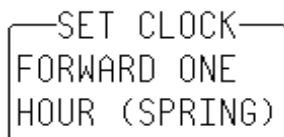

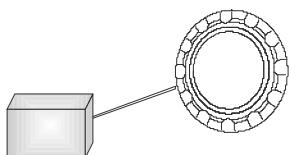

Each menu either contains a list of items or options — functions to be selected or variables modified — or when selected performs a specific action. Menus that perform certain actions are indicated by capitalized text, as in the example shown at left.

Going to Menus and Selecting from them

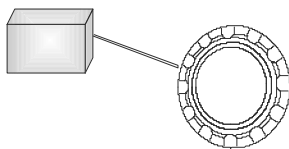

When a menu-entry button  is pressed, the set-up configuration for its particular group of functions is immediately displayed on-screen as a menu group. Once accessed, these menus are controlled using the menu buttons and the two menu knobs (*illustrated at left*).



A menu button  is active and can be pressed to make selections whenever a menu is visible beside it on-screen.

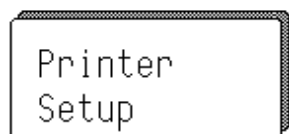

The two menu knobs  work together with the two menu buttons to which they are joined by lines. Both control the menu currently shown beside them. Buttons and knobs are used either for selecting entire menus, particular items from menus, for moving up or down through menu lists, or for changing the values listed in menus.

Some menus, referred to as *primary*, have *secondary* menus beneath them whose existence is indicated by a heavy outline or shadow, as *illustrated at left*. Pressing the corresponding menu button reveals and activates these 'hidden' menus. Pressing the RETURN button again displays the top, or primary, menu.

Changing a menu value normally changes the screen, because the new value is immediately used in acquisition settings, processing or display.

Setting Menu Options

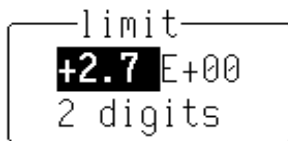
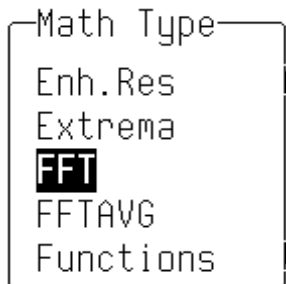

The activated selection is highlighted in the menu. Press the corresponding menu button and the field will advance to highlight and select the next item on the menu. However, if there is only one item on a menu, pressing its button will have no effect.

Where a menu is associated with one of the two menu knobs, turning this knob in one direction or the other will cause the selection to move either up or down the list in the menu.

Menus that extend along the length of two menu buttons can be operated using both buttons. Pressing the lower of the two will move the highlighting forward — down the list — while pushing the upper will move the selector back up the list.

An arrow on the side of a menu frame indicates that by pressing the button beside this arrow, the selection can be moved further up or down the list. The arrow's direction shows whether the highlighting selector will move up or down. Arrows may also indicate items that are not visible, either above or below on the list. The respective arrow will disappear when the selection is at the very beginning or end of the list.

As in the examples at left, some menu button and knob combinations control the value of a continuously adjustable variable. The knob is then used to set its value, while the button either selects a value or makes a simple change in it.

Still other menu button and knob combinations control the value of several continuously adjustable variables, with the knob used to set the value and the button to highlight it.

Note: When the oscilloscope is placed in a remote state, the REMOTE ENABLE menu will be displayed. It will contain the command "GO TO LOCAL", activated by menu button if the action is possible. This is the only manual way to turn off the REMOTE ENABLE menu. The scope need not be in remote state to accept remote commands.



System Setup and Menu Controls

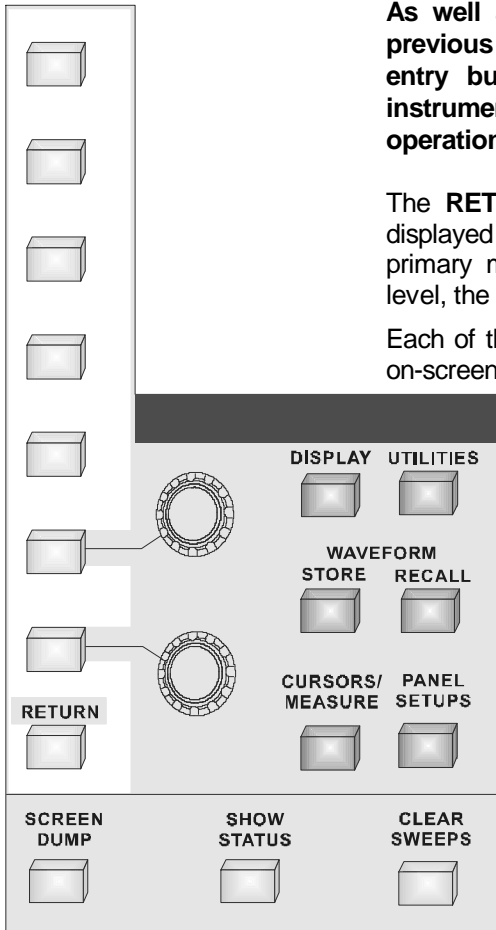



As well as the menu buttons and knobs described on the previous pages, the System Setup controls include the menu-entry buttons and others for copying displays, reporting instrument status and restarting multiple-acquisition operations.

The **RETURN** button  is used to go back to the preceding displayed menu group. Or it returns the display to a higher-level, or primary menu. But when the display is at the highest possible menu level, the button switches off that menu.

Each of the dark-gray menu-entry buttons activates a major set of on-screen menus (*those represented in the other control groups are described in the following chapters, along with the other elements in the groups*).

The **DISPLAY** button  provides entry to the "DISPLAY SETUP" group of menus, controlling display mode, grids, intensities, Dot Join and Persistence menus. *See Chapter 11.*

The **UTILITIES** button  gives access to the "UTILITIES" menus, controlling hardcopy setups, GPIB addresses and special modes of operation. *Chapter 12.*

The **WAVEFORM STORE** button  accesses the "STORE W'FORM" menus, used for storing waveforms to internal or external memory. *Chapter 13.*

Whereas, **WAVEFORM RECALL**  calls up "RECALL W'FORM": menus for retrieving waveforms stored in internal or external memory. *Chapter 13.*

CURSORS/MEASURE  offers up the "CURSORS" Setup menus, used for making precise cursor measurements on traces, and "MEASURE", for precise parameter measurements. *Chapter 14.*

SCREEN
DUMP



SCREEN DUMP

And **PANEL SETUPS**  gives access to the “PANEL SETUPS” menus for saving and recalling a configuration of the instrument. See *Chapter 13*.

— prints or plots the screen display to an on-line hardcopy device, via the GPIB, RS-232-C or Centronics interface ports, or directly to an external thermal graphics printer. Hardcopies can also be generated as data files onto floppy, memory card or portable hard disk.

Once SCREEN DUMP is pressed, *all* displayed information will be copied. However, it is possible to copy the waveforms without the grid by turning the grid intensity to 0 with the “Display Setup” menu.

While a screen dump is taking place — indicated by the on-screen “PRINTING” or “PLOTTING” message — it can be aborted by pressing SCREEN DUMP a second time. It will take a certain amount of time for the buffer to empty before copying stops.

CLEAR
SWEEPS



CLEAR SWEEPS

— restarts operations requiring several acquisitions, or sweeps, including averaging, extrema, persistence and pass/fail testing, by resetting the sweep counter(s) to zero.

SHOW
STATUS



SHOW STATUS

— menu entry to “STATUS”, which shows summaries of the instrument’s status for acquisition, system and other aspects. See *Chapter 16*.



Screen Topography

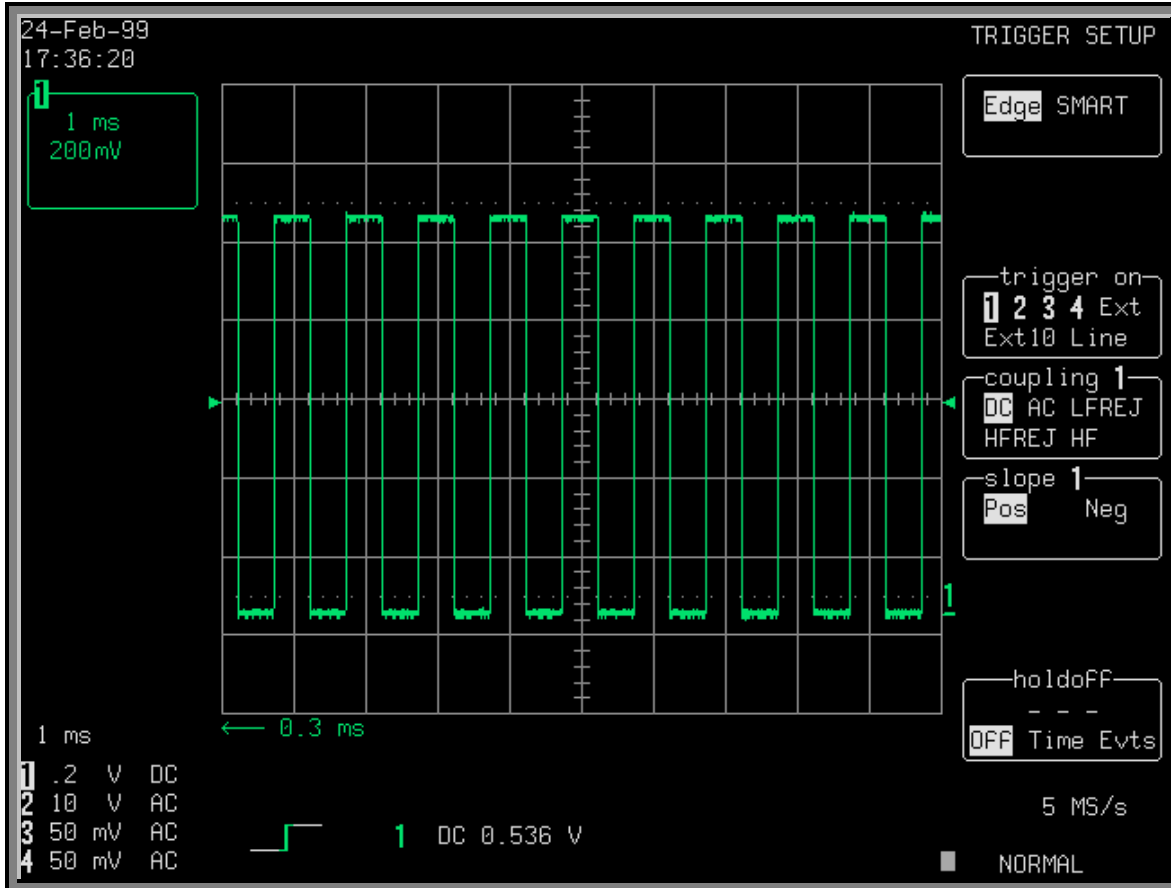

The sections of the screen shown here and described below, which surround the grid, contain a variety of useful information as well as accessing specific commands and functions.

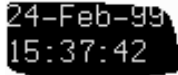

24-Feb-99
15:37:42



1
1 ms
200 mV

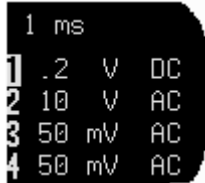

1 ms
1 .2 V DC
2 10 V AC
3 50 mV AC
4 50 mV AC

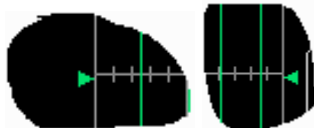

5 MS/s
NORMAL



1 DC 0.536 V



Real-Time Clock field: powered by a battery-backed real-time clock, it displays the current date and time.

Displayed Trace Label indicates each channel or channel displayed, the time/div and volts/div settings, and cursor readings where appropriate. It indicates the acquisition parameters set when the trace was captured or processed, while the Acquisition Summary field (below) indicates the present setting.

Acquisition Summary field: timebase, volts/div, probe attenuation and coupling for each channel, with the selected channel highlighted. It indicates the present setting, while the acquisition parameters set when the trace was captured or processed are indicated in the Displayed Trace label (above).

Trigger Level arrows on both sides of the grid that mark the trigger voltage level relative to ground level.

Trigger Delay: an arrow indicating the trigger time relative to the trace. The delay can be adjusted from zero to ten grid divisions (pre-trigger), or zero to -10 000 (post-trigger) off-screen. Pre-trigger delay appears as the upward-pointing arrow, while post-trigger is given as a delay in seconds.

Trigger Status field shows sample rate and trigger re-arming status (AUTO, NORMAL, SINGLE, STOPPED). The small square icon flashes to indicate that an acquisition has been made.

Trigger Configuration field: icon indicating type of trigger, and information on the trigger's source, slope, level and coupling, and other information when appropriate.

Trace and Ground Level: trace number and ground-level marker.



Introduction to the Controls

Other Fields
(not illustrated here)

Time and Frequency field: displays time and frequency relative to cursors beneath the grid. For example, when the absolute time cursor (the cross-hair) is activated by selection from the “MEASURE” menu group, this field displays the time between the cursor and the trigger point.

Message field: used to display a variety of messages, above the grid, including warnings, indications and titles showing the instrument’s current status.

General Instrument Reset: *Simultaneously press the AUTO SETUP button, the top menu button, and the RETURN button. The scope will revert to its default power-up settings.*

Press:
!



+



+



Channel Controls

These enable selection of displayed traces and adjustment of vertical sensitivity and offset.



Pressing these buttons either displays or switches off the corresponding channel trace. When a channel is switched on, the OFFSET and VOLTS/DIV controls will then be attributed to this, the active channel. On two-channel models (right), each channel has its own set of unique, dedicated controls.

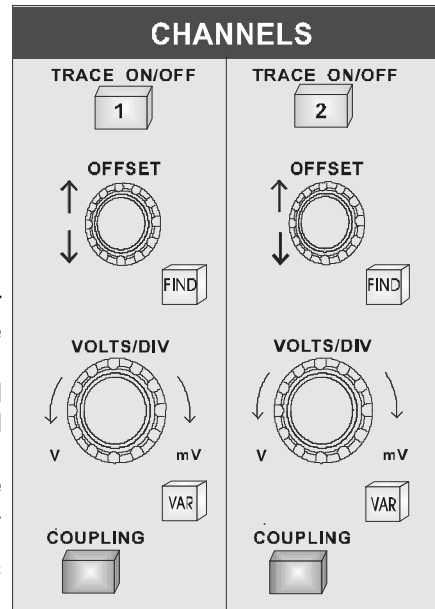

On four-channel models (right), these buttons are used to attribute all the vertical controls to one channel, independent of whether or not it is the channel displayed. The selected channel number is highlighted in the Acquisition Summary field (see previous chapter).

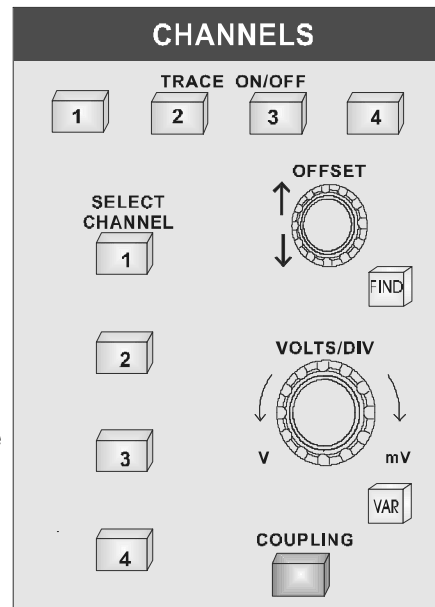

— vertically positions the active channel.

CHANNELS, Coupling & Probes

 **FIND**

— automatically adjusts offset and volts/div to match the active channel's input signal.

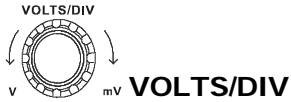

— selects the vertical sensitivity factor either in a 1–2–5 sequence or continuously (see *VAR*, below). The effect of gain changes on the acquisition offset can be chosen from the “SPECIAL MODES” menu.

 **VAR**

— allows the user to determine whether the VOLTS/DIV knob will modify the vertical sensitivity in a continuous manner or in discrete 1–2–5 steps.

The format of the vertical sensitivity in the Acquisition Summary field (bottom left of screen) shows whether the VOLTS/DIV knob is operating in *continuous* or *stepping* mode.

 **COUPLING**

— menu-entry button that accesses the “Coupling” menus (see *next section*).

Coupling

Coupling Menus



COUPLING

Press  for access to selection of:

- Coupling and grounding of each input channel
- ECL or TTL gain, offset and coupling preset for the channel shown
- Bandwidth limiter for all channels
- Probe attenuation of each input channel.

Coupling

Used to select the input channel's coupling. If an overload is detected, the instrument will automatically set the channel to the grounded state: the menu can then be reset to the desired coupling.

V/div Offset

When NORMAL is highlighted, pressing the corresponding menu button sets the offset, Volts/div, and input coupling to display ECL signals. Press the button a second time and the settings for TTL signals are given. And a third time returns the settings to those used at the last manual setup of the channel.

Global BWL

To turn the bandwidth limit "OFF" or "ON". The bandwidth can be reduced from 500 MHz or 1 GHz, to either 200 MHz or 25 MHz, or 30 MHz (−3dB), depending on the model (see Appendix A). Bandwidth limiting can be useful in reducing signal and system noise or preventing high-frequency aliasing, reducing — for example — any high-frequency signals that may cause aliasing in single-shot applications.

Note: This command is global and affects all input channels.

Probe Atten

Sets the probe attenuation factor related to the input channel (see following for probe details).

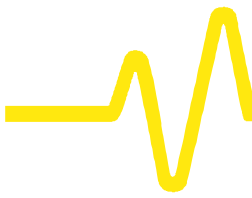

Probes and Probe Calibration

Probe Calibration

To calibrate the probe supplied, connect it to one of the input channels' BNC connectors. Connect the probe's grounding alligator clip to the CAL BNC ground and touch the tip to the inner conductor of the CAL BNC. The CAL signal is a 1 kHz square wave, 1 V p-p.

Set the channel coupling to DC 1 M Ω , turn the trace ON and push AUTO SETUP to set up the oscilloscope. If over- or undershoot of the displayed signal occurs, the probe can be adjusted by inserting the small screwdriver, supplied with the probe package, into the trimmer on the probe's barrel and turning it clockwise or counter-clockwise to achieve the optimal square-wave contour.

More On Coupling

In the AC position, signals are coupled capacitively, thus blocking the input signal's DC component and limiting the signal frequencies below 10 Hz.

In the DC position, all signal frequency components are allowed to pass through, and 1 M Ω or 50 Ω may be chosen as the input impedance.

The maximum dissipation into 50 Ω is 0.5 W and inputs will automatically be grounded whenever this is attained. An overload message will be displayed in the Acquisition Summary Field and "Grounded" will be indicated in the "Coupling" menu. The overload condition is reset by removing the signal from the input and again selecting the 50 Ω input impedance from the menu.

ProBus System

LeCroy's ProBus system provides a complete measurement solution from probe tip to oscilloscope display. This intelligent interconnection between LeCroy oscilloscopes and a growing range of accessories is achieved via a six-wire bus following Philips' I²C protocol. It provides major benefits over standard BNC or even probe-ring connections:

- **Autosensing the probe type**, eliminating all the guesswork — and the errors — from manually setting attenuation or amplification factors, and ensuring proper input coupling.
- **Transparent gain and offset control** right from the front panel — particularly useful for FET (*FET menus shown here*) and current probes.
- **Gain and offset correction factors** are uploaded from the ProBus EPROMS on FET probes and **automatically compensated** to achieve fully calibrated measurements.

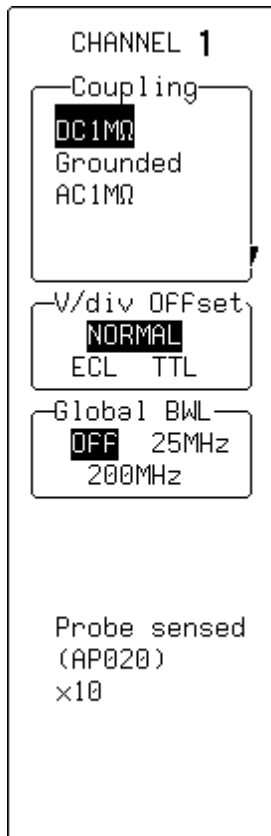

Coupling

Used to select the input channel's coupling. If an overload is detected, the instrument will automatically set the channel to the grounded state: the menu can then be reset to the desired coupling.

V/div Offset

When NORMAL is highlighted, pressing the corresponding menu button sets the offset, Volts/div, and input coupling to display ECL signals. Press the button a second time and the settings for TTL signals are given. And a third time returns the settings to those used at the last manual setup of the channel.

Global BWL

To turn the bandwidth limit "OFF" or "ON". The bandwidth can be reduced from 500 MHz or 1 GHz, to either 200 MHz or 25 MHz, or 30 MHz (−3dB), depending on the model (see Appendix A). Bandwidth limiting can be useful in reducing signal and system noise or preventing high-frequency aliasing, reducing — for example — any high-frequency signals that may cause aliasing in single-shot applications.

When a FET probe is used, "Probe sensed...", automatically appears to indicate settings. When other ProBus probes are used, this is redefined.

TIMEBASE + TRIGGER Controls

These controls allow direct adjustment of time/division, trigger level and delay, and access the “TIMEBASE” and “TRIGGER” menu groups.

AUTO
SETUP

 AUTO SETUP

The blue button automatically scales the timebase, trigger level, offset, and volts/div to provide a stable display of repetitive signals.

AUTO SETUP operates only on channels which are active. If no channels are on, then AUTO SETUP will operate on all channels, switching them all on. Signals detected must have an amplitude between 5 mV and 40 V, a frequency greater than 50 Hz, and a duty cycle greater than 0.1 %.

If signals are detected on several channels, the channel with the lowest number will determine the selection of the timebase and trigger source.

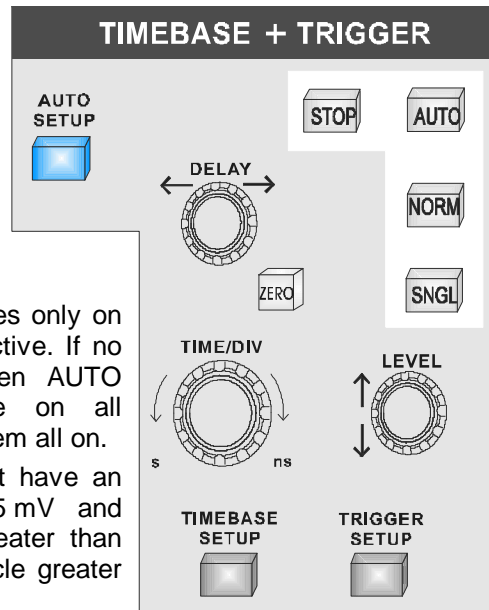

 STOP

This button halts the acquisition in any of the three *re-arming* modes: Auto, Normal or Single.

Pressing the STOP button prevents the oscilloscope acquiring a new signal.

Press STOP while a single-shot (*see next chapter*) acquisition is under way and the last acquired signal will be kept.

Press STOP after an RIS acquisition has been started (*next chapter*) and the acquisition will be halted and a partial waveform reconstruction will be performed.

Press STOP when the acquisition is in Roll Mode (*see next chapter*) and the incomplete acquisition data will be shown as if a trigger had occurred.

In Sequence Mode (*next chapter*), the action will stop the timebase and show all new segments.

AUTO

Pressing this button places the instrument in Auto Mode: the scope automatically displays the signal if *no* trigger occurs within 60 ms.

If a trigger does occur within this time, the oscilloscope behaves as in Normal Mode.

Press AUTO in RIS Mode and the acquisition will be terminated and shown each second (some required segments may be missing).

Press the button in Roll Mode and the oscilloscope will sample the input signals continuously and indefinitely. The acquisition will have no trigger condition but can be stopped as desired.

Press AUTO in Sequence Mode and the acquisition will be terminated if the time between two consecutive triggers exceeds a timeout that can be selected. The next acquisition is then started from Segment 1.

NORM

Pressing this button will continuously update the screen as long as a valid trigger is present. If not, the last signal is preserved and the warning “SLOW TRIGGER” is displayed in the Trigger Status Field.

Press NORM in Roll Mode and the acquisition will be terminated when the last needed data after a trigger have been taken. The display will pause to show the entire waveform. It then goes back into Roll Mode while it waits for the next trigger.

Press this button in Sequence Mode and the acquisition will be terminated after the last segment is acquired. The next acquisition will start immediately. Sequence WRAP in Normal is the same as in Single-Shot Mode.



Pressing this button places the scope in Single-Shot Mode, where it waits for a single trigger to occur, then displays the signal and stops acquiring. If no signal occurs, the button can be pressed again to show the signal being observed without a trigger.

Press SNGL when in RIS Mode and the instrument will wait for all the trigger events required to build up one signal on screen before it stops. This may require as many as 4000 trigger events.

Single-Shot Roll Mode behavior is the same as standard Single-Shot but without the need to press the button a second time to show the signal.



— is used to adjust the pre- or post-trigger delay. Pre-trigger adjustment is available from zero to 100 % of the full time-scale in steps of 1 %. The pre-trigger delay is illustrated by the vertical arrow symbol at the bottom of the grid. Post-trigger adjustment is available from 0 to 10 000 divisions in increments of 0.1 of a division. The post-trigger-delay value is labeled in seconds and is located in the on-screen Trigger Delay field.



— sets the trigger delay at zero, the trigger instant at the left-hand edge of the grid.



— selects the time per division in a 1–2–5 sequence. The time/div setting is displayed in the Acquisition Summary field.



— adjusts the trigger threshold. The amplitude of trigger signals and the range of trigger levels is limited: ± 5 screen divisions with a channel as trigger source; ± 0.5 V with EXT as trigger source; ± 5 V with EXT/10 as trigger source; and Inactive with Line as trigger source. The trigger sensitivity is better than a third-of-a-screen division.

TIMEBASE
SETUP



TIMEBASE SETUP

— menu-entry button that calls up the “TIMEBASE” menus *described in the next chapter.*

TRIGGER
SETUP



TRIGGER SETUP

— menu-entry button that calls up “TRIGGER SETUP” *detailed in Chapter 8.*

Timebase Sampling Modes

Depending on the timebase, any of three sampling modes can be chosen: Single-Shot, Random Interleaved Sampling (RIS) or Roll Mode. Furthermore, for timebases suitable for either Single-Shot or Roll Mode, the acquisition memory can be subdivided into user-defined segments to give Sequence Mode. Channels can also be combined to boost sample rate and record length.

Single-Shot

Single-Shot is the digital oscilloscope's basic acquisition technique and other timebase modes make use it.

An acquired waveform consists of a series of measured voltage values sampled at a uniform rate on the input signal. The acquisition, a single series of measured data values associated with one trigger event, is typically stopped at a fixed time after the arrival of the event, this being determined by the trigger delay. The time of the trigger event is measured using the timebase clock. The horizontal position of a waveform is determined using the trigger event as the definition of time zero. Waveform display is also carried out using this definition.

Because each channel has its own ADC, the voltage on each input channel is sampled and measured at the same instant. This allows very reliable time measurements between different channels.

Trigger delay can be selected anywhere within a range that allows the waveform to be sampled from well before the trigger event up to the moment it occurs (100 % pre-trigger), or at the equivalent of 10 000 divisions (at the current time/div) after the trigger.

For fast timebase settings the ADCs' maximum single-shot sampling rate is used (on one and each channel, with higher sampling rates achieved by combining channels — see page 7–4). For slower timebases, the sampling rate is decreased and the number of data samples maintained. (See Appendix A for details).



Timebase Modes and Setup

Peak Detect
NOT AVAILABLE WITH
9304C, 9310C, 9314C
SERIES

When using slow timebases, sample-rate decreases and very short events such as glitches can be missed if they occur between two samples. To prevent this, a special circuitry called the Peak Detect system can be switched on (see “Channel Use” menu, page 7–5) to capture the signal envelope with a resolution of 2.5 ns. This is done without destroying the underlying, simultaneously captured data, on which a wide range of advanced processing can be performed.

RIS: Random
Interleaved Sampling

RIS is an acquisition technique that allows effective sampling rates higher than the maximum single-shot sampling rate. It is used on repetitive waveforms with a stable trigger.

The maximum effective sampling rate of 10 GS/s can be achieved by acquiring 100 single-shot acquisitions, or bins, at 100 MS/s using the 9304C, 9310C, 9314C Series oscilloscopes; 20 bins at 500 MS/s when using the other models. These bins are positioned approximately 0.1 ns apart. The process of acquiring this number of bins and satisfying the time constraint is random. The relative time between ADC sampling instants and the event trigger provides the necessary variation, measured by the timebase to 10 ps accuracy.

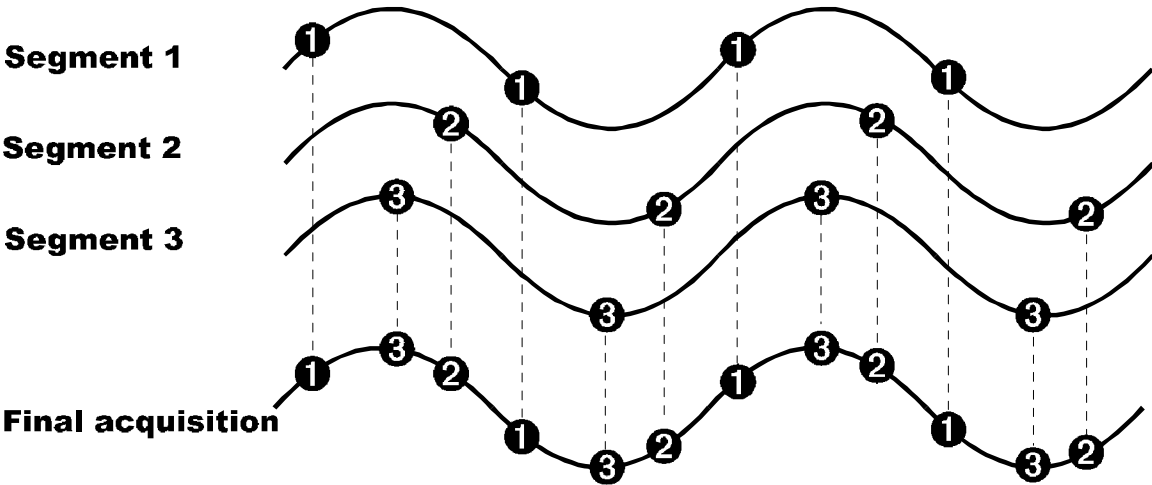

On average, 104 trigger events are needed to complete an acquisition. But sometimes many more are needed. These segments are interleaved to provide a waveform covering a time interval that is a multiple of the maximum single-shot sampling rate. However, the real-time interval over which the waveform data are collected is orders of magnitude longer and depends on the trigger rate and the desired level of interleaving. The oscilloscope is capable of acquiring approximately 40 000 RIS segments per second.

Roll

Single-shot acquisitions at timebase settings slower than 0.5 s/div (10 s/div for traces with more than 50 000 points) have a sufficiently low data rate to allow the display of the incoming points in real time. The oscilloscope shows the incoming data continuously, “rolling” it across the screen, until a trigger event is detected and the acquisition completed. The latest data is used to update the trace display in the same manner as a strip-chart recorder. Waveform Math and Parameter calculations are done on the completed waveforms.

Note: The behavior of **STOP**, **AUTO**, **NORM** and **SNGL** is modified in Roll Mode and Sequence Modes (refer to previous chapter and pages 7–8 and 7–9).

Sequence

Sequence Mode is an alternative to single-shot acquisition that offers many unique features. The complete waveform consists of a number of fixed-size segments acquired in Single-Shot Mode (see Appendix A for the limits), which are able to be selected. .

The dead time between the trigger events for consecutive segments can be kept to under 50 μ s — in contrast to the hundreds of milliseconds normally found between consecutive single-shot waveforms. Complicated sequences of events covering a large time interval can be captured in fine detail,

Note: to ensure low deadtime between segments, button-pushing and knob-turning is to be avoided during sequence acquisition.

ignoring uninteresting periods between events. And time measurements can be made between events on different

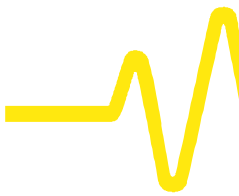

Timebase Modes and Setup

segments of a sequence waveform using the full precision of the acquisition timebase.

Trigger-time stamps are given for each of the segments in the “Text & Times Status” menu. Each individual segment can be displayed by Zoom, or used as input to the MATH functions.

Sequence Mode can be used in remote operation to take full advantage of the scope’s high data-transmission capability: overlapping transmission of one waveform with its successor’s acquisition (*see the Remote Control Manual for details*).

The timebase setting in Sequence Mode is used to determine the acquisition duration of each segment, which will be $10 \times \text{TIME/DIV}$.

Timebase setting, desired number of segments, maximum segment length and total available memory are used to determine the actual number of samples/segment and time/point. The display of the complete waveform with all its segments may not entirely fill the screen.

Sequence Mode is normally for acquiring the desired number of segments and terminating the waveform acquisition. It can also be used to acquire the segments continuously, overwriting the oldest ones as needed, with a manual STOP order or timeout condition being used to terminate the waveform acquisition.

Combining Channels
NOT AVAILABLE WITH
9304C, 9310C, 9314C
SERIES

The ADCs can be interleaved to boost standard sampling rate and record length considerably.

When channels are combined on two-channel models, both channels are paired on Channel 2, while Channel 1 is disabled. On four-channel models, the two pairs of channels are enabled on Channels 2 and 3, while Channels 1 and 4 are disabled. Both maximum sampling rate and record length are doubled using this function, activated by menu selection (*see page 7–9*).

On fast timebases it is even possible to again double the sampling rate by means of a special adapter. With this adapter in place, the oscilloscope interleaves the four ADCs and the acquisition memory to achieve the maximum sampling rate and up to four times the initial record length (*see Appendix A for details*).

Timebase Setup

TIMEBASE

TIMEBASE
SETUP

Press  to access and choose:

- **Single-Shot or Interleaved (RIS) sampling**
- **External clock**
- **Channel pairing (combining) and Peak Detect ..**
- **Sequence Mode**
- **Number of segments in Sequence Mode**
- **Maximum record length.**

The “TIMEBASE” menus also show the number of points acquired, the sampling rate and the total time span.

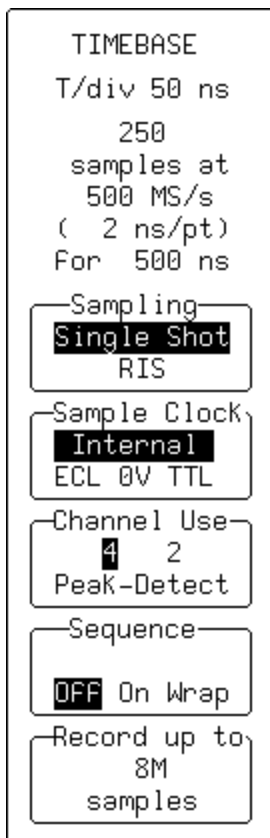

Sampling

For selecting either of the two principal modes of acquisition:

- **“Single Shot”** — displays data collected during successive single-shot acquisitions from the input channels. This mode allows the capture of non-recurring or very low repetition-rate events simultaneously on all input channels.
- **“RIS”** (Random Interleaved Sampling) — achieves a higher effective sampling rate than Single-Shot, provided the input signal is repetitive and the trigger stable.

Sample Clock

To select **“Internal”** or External (**“ECL”**, **“OV”**, **“TTL”**) clock modes (*see next page*).

Channel Use (**NOT AVAILABLE WITH 9304C, 9310C, 9314C SERIES**)

To select for channel pairing and, on models with this feature, to control Peak Detect Mode (*refer page 7–2*).

Sequence

For turning **“Off”** or selecting **“Sequence”** or **“Wrap”** Mode. See *page 7–10*.

Record up to



Timebase Modes and Setup

For selecting the maximum number of samples to be acquired, using the associated menu knob. See *Appendix A for model maximums*.

TIMEBASE EXTERNAL — appears when an External clock mode is chosen.

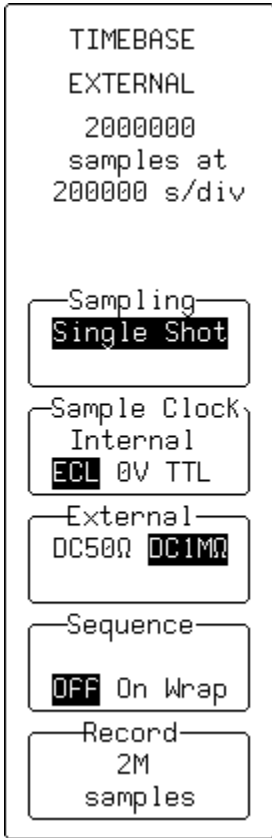

Sampling

This menu is inactive when the external sample clock is being used. Only single-shot acquisition is available (see *below*).

Sample Clock

For selecting a description of the signal applied to the EXT BNC connector for the sample clock up to 100 MHz. The rising edge of the signal is used to clock the ADCs of the oscilloscope. The effective thresholds for sampling the input are :

ECL..... -1.3 V
0V 0.0 V
TTL..... +1.5 V

(With CKTRIG Option ONLY) RP (Rear Panel) specifies that the 50–500 MHz external clock connected to the rear panel be used as the sample clock (see CKTRIG Manual *for details*).

External

To select the input coupling for the external clock signal.

Sequence

Offers Sequence Mode. The corresponding knob is used to adjust the number of segments. Neither the trigger time stamps nor the AUTO sequence time-out feature are available when the external clock is in use. Nor is the inter-segment dead time guaranteed.

Record

To select the desired number of samples for the single-shot acquisition. See *Appendix A for model maximums*.

* External clock modes are available only if the EXT trigger is not the trigger source.

Notes for using External Clock

- *The time/div is expressed in s/div, to be understood to be samples/div.*
- *The trigger delay is also expressed in samples and can be adjusted as normal.*
- *No attempt is made to measure the time difference between the trigger and the external clock. Therefore, successive acquisitions of the same signal can appear to jitter on the screen.*
- *The oscilloscope will require a number of pulses (typically 50) before it recognizes the external clock signal. The acquisition is halted only when the trigger conditions have been satisfied and the appropriate number of data points have been accumulated.*
- *Any adjustment to the time/division knob automatically returns the oscilloscope to normal (internal) clock operation.*

TIMEBASE – Sequence — for operating in Sequence Mode

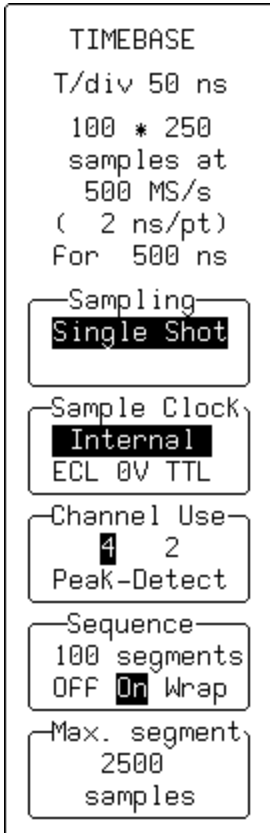

Sampling

This menu is inactive when the external sample clock is being used. Only single-shot acquisition is available (see pages 7–7, 7–1).

Sample Clock

For selecting a description of the signal applied to the EXT BNC connector for the sample clock (7–7).

Channel Use (NOT AVAILABLE WITH 9304C, 9310C, 9314C SERIES)

For combining or pairing channels to achieve more memory and a greater sampling rate by interleaving the ADCs in time. When “2” is selected on two-channel models both channels are combined, or paired. While when the same selection is made on four-channel models either Channels 1 and 2 or 3 and 4 may be combined. But when “1” on two-channel models or “4” on four-channel scopes is selected, none of the channels is combined.

Sequence

When either “On” or “Wrap” are activated, the menu changes to the one shown here. The associated menu knob is used to choose the desired number of segments, here given in example as “100 segments”..

Also, when “Sequence” is “On”:

If the trigger mode is Single  the oscilloscope fills the segments and stops.

But it will wait until  is pressed if there are not enough trigger events to fill the segments.

If the trigger mode is Normal  the oscilloscope fills the segments and then, if more trigger events occur, the acquisition is restarted from Segment 1.

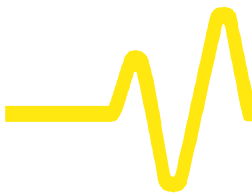

Timebase Modes and Setup

If the trigger mode is Auto  and if the time between two consecutive triggers exceeds a time-out that can be selected, the acquisition is restarted from Segment 1. The time-out is selected in “SPECIAL MODES” “UTILITIES”.

However, when “Wrap” is selected, the segments are filled continuously until the STOP button is pressed. The last n segments will be displayed. An alternative way to stop the WRAP sequence is through AUTO mode; if the time between two consecutive triggers exceeds a time-out that can be selected, the acquisition will stop.

Max. segment

To select using the corresponding button or associated knob the maximum record length for each segment. See *Appendix A for model maximums*.

Note: A summary of the acquisition conditions is displayed above the “TIMEBASE” menus, indicating number of segments, available record length per segment, sampling rate, and timebase setting.

Choosing the Right Trigger

Your oscilloscope offers many distinctive and useful techniques for triggering on and capturing data. These range from the simple *Edge* triggers to the advanced *SMART Trigger* types, which trigger on multiple inputs.

Three triggering modes are available: AUTO, NORM and SNGL. Additionally, STOP enables the acquisition process to be aborted. All are directly accessible by pressing the respective front-panel buttons. (See *Chapter 6*.)

Modifying Trigger Settings Trigger adjustments are made directly using the front-panel controls and with the trigger menus.

Rotating  — for example — causes the scope to adjust the trigger level of the highlighted trace.

Pressing  accesses advanced trigger operations, such as changing the glitch width or the hold-off timeout, which are changed via the TRIGGER SETUP menu group (*Fig. 8-1*). Once the trigger configuration has been modified, changes are stored internally in a non-volatile memory.

This chapter describes the triggering operations and offers hints on how to perform them. Along with the standard menu descriptions, schematics show the trigger-menu structure, and diagrams explain how the main triggers work.

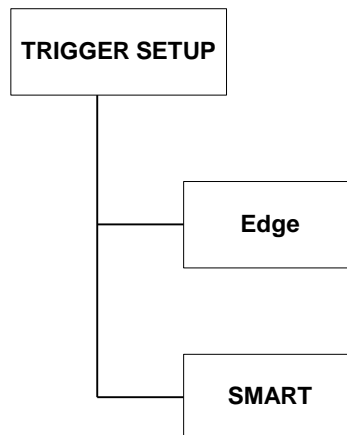

Figure 8-1. Main Trigger Menu.



Edge or SMART

A variety of triggers for different applications can be chosen from the two main trigger groups, the Edge and SMART trigger types.

Edge Triggers

In the Edge group of menus trigger conditions are defined by the vertical trigger level, coupling, and slope. Edge triggers use simple selection criteria to characterize a signal. They are most useful for triggering on simple signals (see page 8–3).

SMART Trigger

The SMART Trigger types allow additional qualifications to be set before a trigger is generated. These qualifications can be used to capture rare phenomena such as glitches or spikes, specific logic states, or missing bits. A qualification might include trigger generation only on a pulse wider or narrower than a user-specified limit. Or it might require — to take but another example — three trigger sources exceeding specific levels for a minimum time.

Generally speaking, SMART Trigger offers various trigger qualifications based on three basic abilities:

1. To count a specified number of events
2. To measure time intervals
3. To recognize a pattern input.

SMART explanations start on page 8–10 and on page menus 8–29.

Trigger Symbols, illustrated throughout this chapter, allow immediate on-screen recognition of the current trigger conditions. There is a symbol for each Edge and SMART Trigger type, with the more heavily-marked transitions on the symbols indicating where a trigger will be generated.

Edge Trigger

Selecting Edge and its menus (*Fig. 8–2*) causes the scope to trigger whenever the selected signal source meets the trigger conditions. The trigger source is defined by the trigger level, coupling, slope or hold-off.

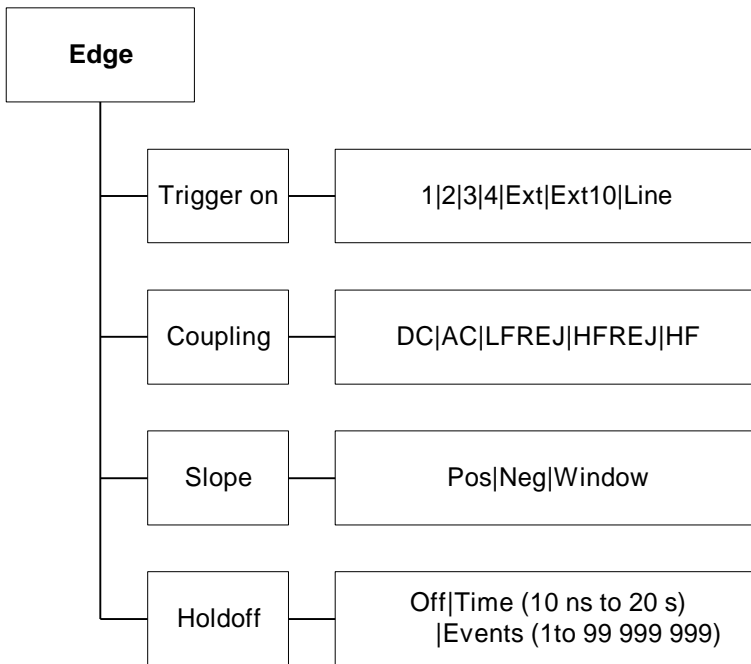

Figure 8–2. Edge Trigger Menu (see page 8–9).



Triggers and When to Use Them

Trigger Source

The trigger source may be:

- The acquisition channel signal (CH 1, CH 2 or CH 3, CH 4 on four-channel models) conditioned for the overall voltage gain, coupling, and bandwidth.
- The line voltage that powers the oscilloscope (LINE). This can be used to provide a stable display of signals synchronous with the power line. Coupling and level are not relevant for this selection.
- The signal applied to the EXT BNC connector (EXT). This can be used to trigger the oscilloscope within a range of ± 0.5 V, or ± 5 V with EXT/10 as trigger source.

Level

Level defines the source voltage at which the trigger circuit will generate an event (a change in the input signal that satisfies the trigger conditions). The selected trigger level is associated with the chosen trigger source. Note that the trigger level is specified in volts and is normally unchanged when the vertical gain or offset is modified.

The Amplitude and Range of the trigger level are limited as follows:

- ± 5 screen divisions with a channel as trigger source
- ± 0.5 V with EXT as trigger source
- ± 5 V with EXT/10 as trigger source
- None with LINE as trigger source (zero crossing is used).

Note: Once specified, Trigger Level and Coupling are the only parameters that pass unchanged from mode to mode for each trigger source.

Coupling

This is the particular type of signal coupling at the input of the trigger circuit. As with the trigger level, the coupling can be independently selected for each source. Thus changing the trigger source can change the coupling. The types of coupling able to be selected are:

-
- **DC:** All the signal's frequency components are coupled to the trigger circuit. This is used in the case of high-frequency bursts, or where the use of AC coupling would shift the effective trigger level.
 - **AC:** Here the signal is capacitively coupled. DC levels are rejected and frequencies below 50 Hz attenuated.
 - **LF REJ:** The signal is coupled via a capacitive high-pass filter network. DC is rejected and signal frequencies below 50 kHz attenuated. This mode is used when stable triggering on medium- to high-frequency signals is desired.
 - **HF REJ:** Signals are DC-coupled to the trigger circuit and a low-pass filter network attenuates frequencies above 50 kHz. The HF REJ trigger mode is used to trigger on low frequencies.
 - **HF:** Used for triggering on high-frequency repetitive signals in excess of 300 MHz. Maximum trigger rates greater than 500 MHz are possible. HF triggering should be used only when needed. It will be automatically overridden and set to AC when incompatible with other trigger characteristics — as is also the case for SMART Trigger. Only one slope is available, indicated by the trigger symbol.

Slope

Slope determines the direction of the trigger voltage transition used for generating a particular trigger event. Like coupling, the selected slope is associated with the chosen trigger source.

Hold-off

Hold-off disables the trigger circuit for a given period of time or a number of events after a trigger event occurs. It is used to obtain a stable trigger for repetitive, composite waveforms. For example, if the number or duration of sub-signals is known they can be disabled by choosing an appropriate hold-off value.

Without Hold-off, the time between each successive trigger event would be limited only by the input signal, the coupling, and the oscilloscope's bandwidth. Sometimes a stable display of complex repetitive waveforms can be achieved by placing a condition on this time. This hold-off is expressed either as a time or an event count, *described on the following pages.*

Triggers and When to Use Them

Hold-off by Time

This is the selection of a minimum time for triggers (*Fig. 8-3*). A trigger is generated when the trigger condition is met after the selected delay from the last trigger. The timing for the delay is initialized and started on each trigger. The hold-off timeout should exceed the duration of the signal displayed on screen. For instance, at a timebase setting of 1 ms/div, the time-out hold-off should at least exceed 10 ms.

Trigger Source: Positive Slope

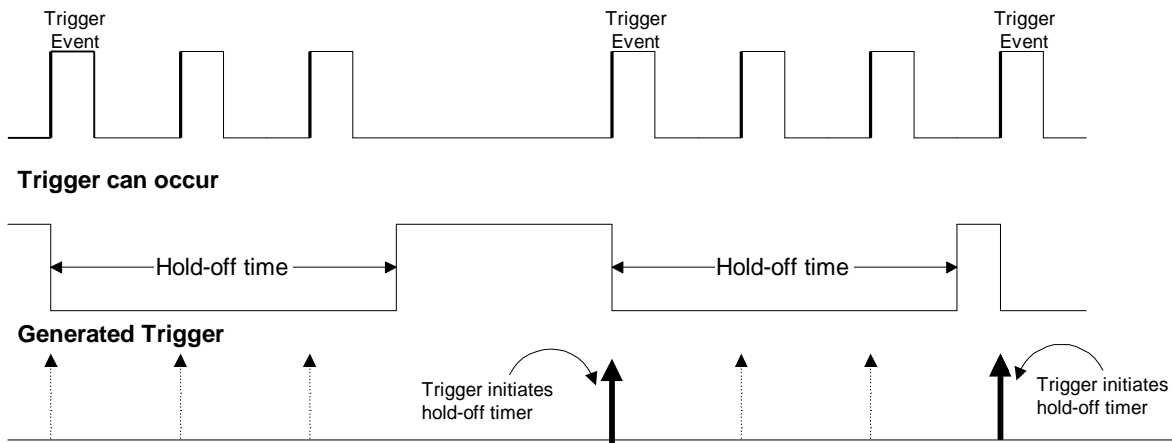

Figure 8-3. Edge Trigger with Hold-off by Time.

1 LFREJ -0.52 V
 H'off 426 μ s
NEGATIVE EDGE WITH HOLDOFF TRIGGER SYMBOL

Hold-off by Events

Hold-off by events is initialized and started on each trigger (Fig. 8-4). A trigger is generated when the trigger condition is met after the selected number of events from the last trigger. Event here refers to the number of times the trigger condition is met after the last trigger. For example, if the number selected is two, the trigger will occur on the third event.

Trigger Source: Positive Slope

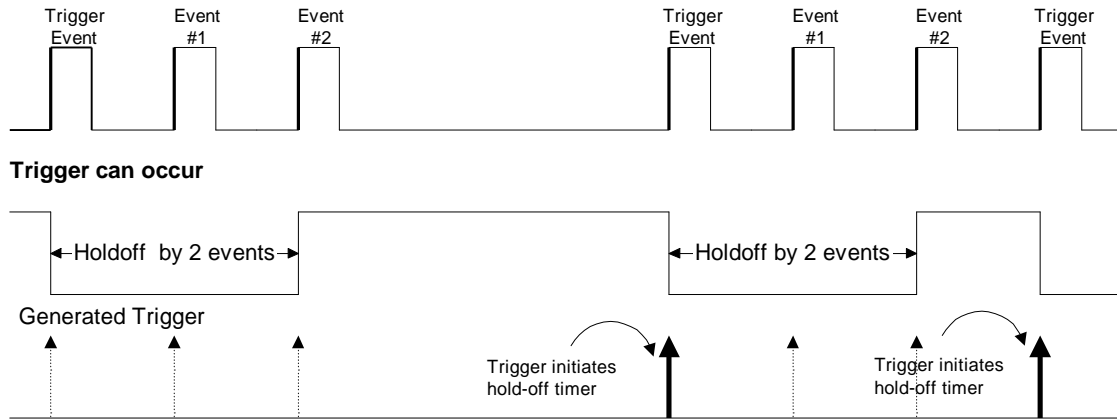
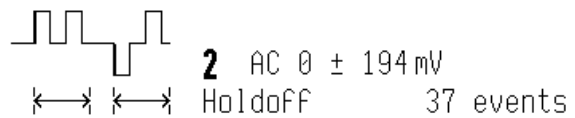

Figure 8-4. Edge Trigger with Hold-off by Events.



WINDOW TRIGGER WITH HOLDOFF SYMBOL

Triggers and When to Use Them

Window Trigger
AVAILABLE ONLY WITH
9304C, 9310C, 9314C
SERIES

On some scope models a “Window” Edge Trigger is also available (Fig. 8–5). Two trigger levels are defined and a trigger event occurs when the signal leaves the window region in either direction.

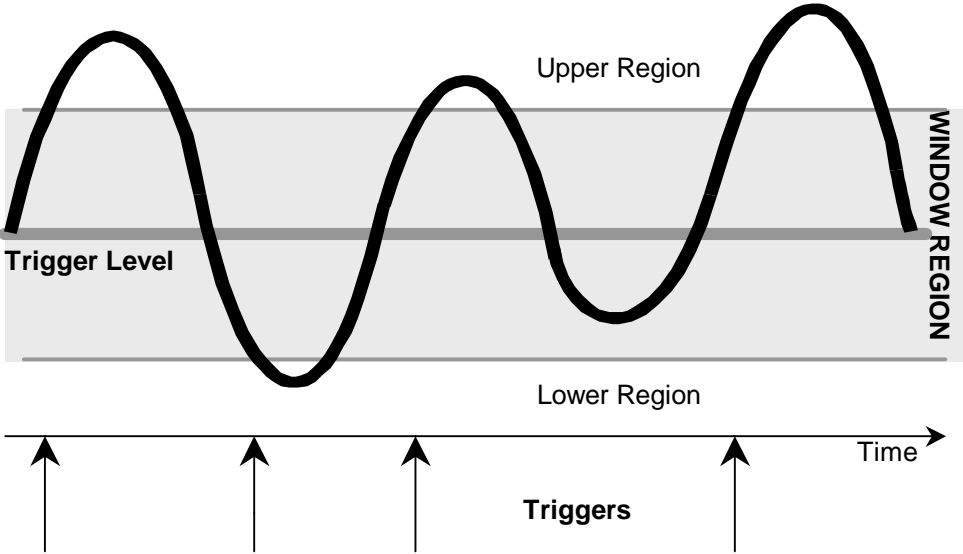
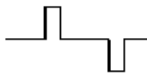

Figure 8–5. Edge Window Trigger.



2 HFREJ 28 ± 222 mV

WINDOW TRIGGER SYMBOL

TRIGGER SETUP: Edge

TRIGGER
SETUP

Press  to access menu selection of:

- Trigger source
- Coupling for each source
- Slope (positive or negative), and
- Hold-off by time or events.

Edge/SMART To select “Edge”

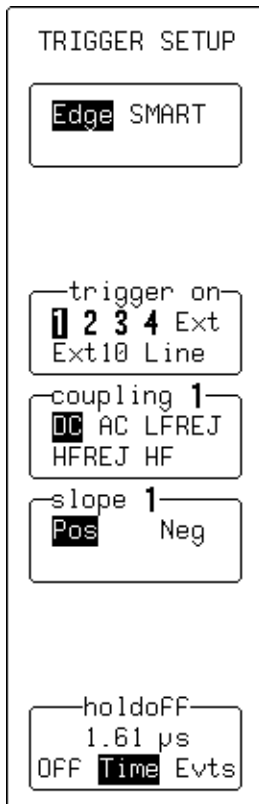

trigger on

For selecting the Edge trigger source (*four-channel menu shown*).

coupling

To select the trigger coupling for the current source.

slope

To place the trigger point on either the “**Pos**”-itive or “**Neg**”-ative slope of the selected source. On those models featuring Window Trigger (**9304C**, **9310C**, **9314C SERIES**), this menu will also include a “Window” option, which allows triggering whenever the input signal leaves a specified voltage window, defined in the “window size” menu. The “window size” menu becomes available on models featuring Window Trigger. It allows adjustment of the window around a level defined using the Trigger LEVEL knob.

holdoff

To allow the disabling of the oscilloscope's trigger circuit for a definable period of time or number of events *after* a trigger event occurs. When activated, “holdoff” can be defined as: a period of “**Time**”, or a number of “**Evts**” (an event being a change in the input signal that satisfies the trigger conditions). The menu knob is used to vary the “holdoff” value. Time hold-off values in the range 10 ns–20 s may be entered. Event counts in the range 1–10⁹ are allowed.

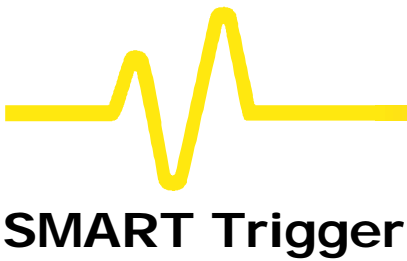

SMART Trigger

Triggers and When to Use Them

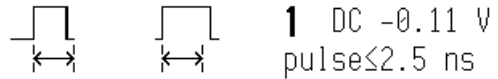

GLITCH TRIGGER SYMBOL

SMART Trigger allows the setting of additional qualifications before a trigger is generated. Depending on the oscilloscope model, this can include triggers adapted for glitches, intervals, abnormal signals, TV signals, state- or edge-qualified events, dropouts and patterns.

Glitch Trigger

Glitch Trigger (*Fig. 8–6*) is used to capture narrow pulses inferior to or exceeding a given time limit. In addition, a width range can be defined to capture any pulse that is comprised within or outside the specified range — an Exclusion Trigger.

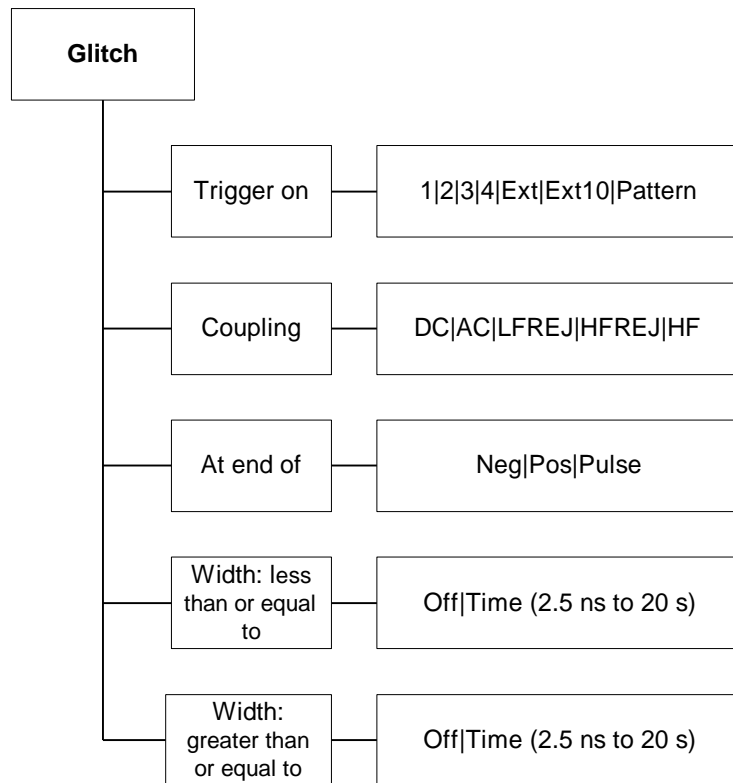

Figure 8–6. Glitch Trigger Menu (see page 8–30).

Applications

In digital electronics circuits normally use an internal clock, and for testing purposes a glitch can be defined as any pulse of width smaller than the clock- or half-period. But generally speaking a glitch is a pulse much faster than the waveform under observation. Glitch Trigger thus has a broad range of applications in digital and analog electronic development, ATE, EMI, telecommunications, and magnetic media studies.

Pulse Smaller than Selected Pulse Width

This Glitch Trigger selects a maximum pulse width (Fig. 8-7). It is generated on the selected edge when the pulse width is less than the selected width. The timing for the width is initialized and restarted on the slope opposite to the edge selected. Widths of between 2.5 ns and 20 s can be selected, but typically triggering will occur on glitches 1 ns wide.

Trigger Source



Trigger can occur

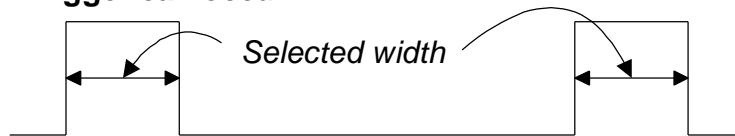

Generated Trigger

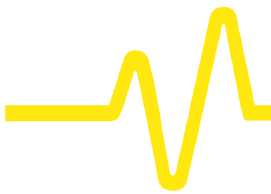

Figure 8-7. Glitch Trigger on pulse width < selected width.



Ext AC 0.18 V 1M Ω
17.5 ns \leq pw \leq 37.5 ns

GLITCH TRIGGER WITH TIME WINDOW SYMBOL



Triggers and When to Use Them

Exclusion Trigger

Exclusion Trigger enables the exclusion of events over a determined time interval. Exclusion Trigger is generated on the selected edge when the pulse width is within or outside the selected width range. For example (Fig. 8-8), only pulses smaller than 25 ns or longer than 27.5 ns will generate the trigger. The timing for the width is initialized and restarted on the slope opposite to the edge selected. Widths of between 2.5 ns and 20 s can be selected.

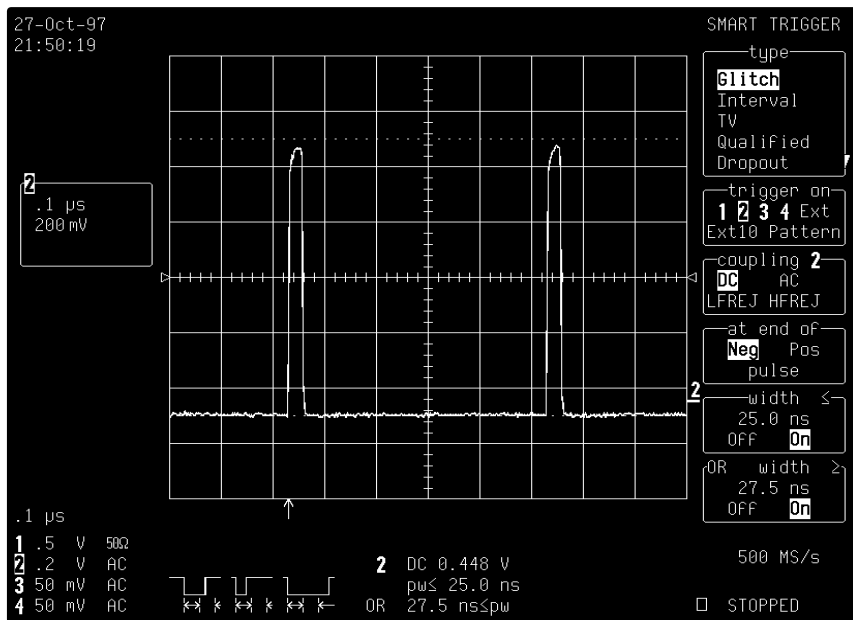
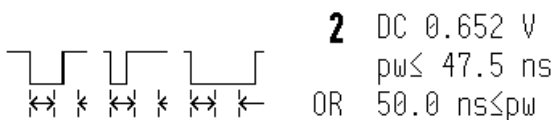

Figure 8-8. Exclusion Trigger. Only pulses within or outside the boundaries of the width range are captured.

Applications

Exclusion Triggers allow a signal's normal width or period to be specified, with the scope instructed to ignore the normally shaped signals and trigger only on abnormal ones. Circuit failures, for instance, can be looked for all the time.



EXCLUSION TRIGGER SYMBOL

Interval Trigger

Whereas Glitch Trigger performs over the width of a pulse, Interval Trigger (*Fig. 8–9*) performs over the width of an interval. An interval corresponds to the signal duration separating two consecutive edges of the same polarity. Interval Trigger is used to capture intervals that are inferior to or exceeding a given time limit. In addition, a width range can be defined to capture any interval that is comprised within or outside the specified range — an Exclusion Trigger by Interval.

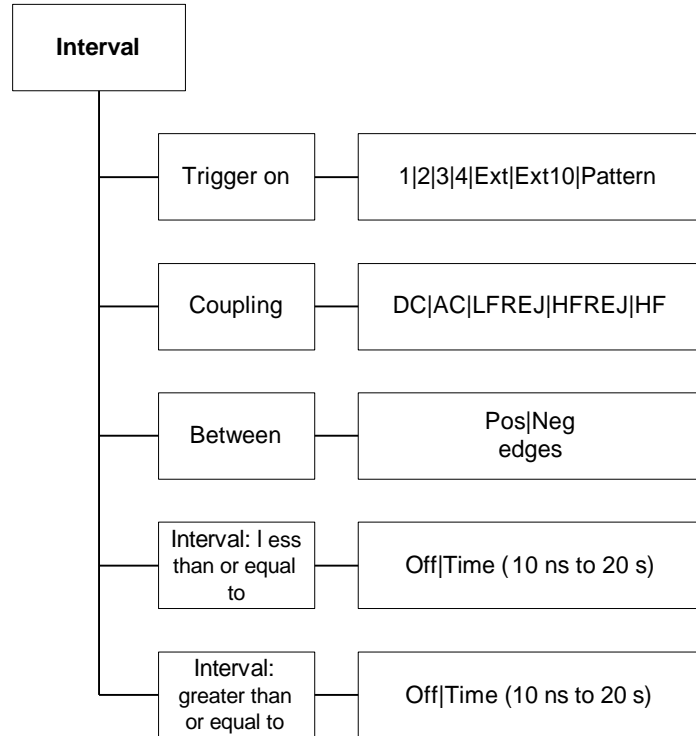
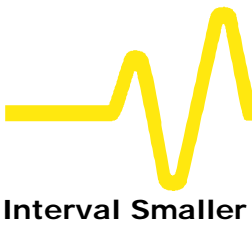

Figure 8–9. Interval Trigger Menu (see page 8–32).

Applications

Interval Trigger is helpful for determining missing cycles or transitions, and for ignoring unwanted signal reflections.



Triggers and When to Use Them

For this Interval Trigger, generated on a time interval *smaller* than the one selected, a *maximum* interval between the two edges of the same slope is chosen (Fig. 8–10). The trigger is generated on the second edge if it occurs within the selected interval. The timing for the interval is initialized and restarted whenever the selected edge occurs. Intervals of between 10 ns and 20 s can be selected.

Trigger Source: Positive Slope

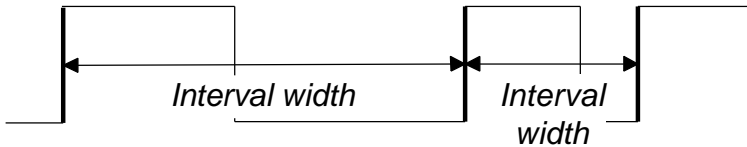

Trigger can occur

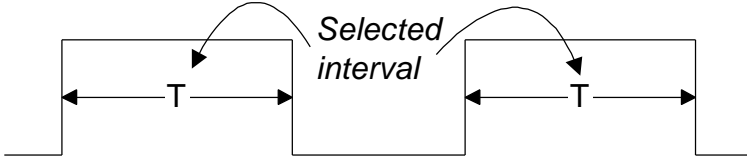

Generated Trigger



Figure 8–10. Interval Trigger: Trigger if the interval is smaller than the selected interval.

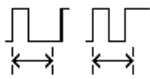

```
Ext10 AC 0.5 V 1MΩ
17.5 ns≤interval
```

INTERVAL TRIGGER SYMBOL

Interval Larger

For this Interval Trigger, generated on an interval *larger* than the one selected, a *minimum* interval between the two edges of the same slope is chosen (Fig. 8–11). The trigger is generated on the second edge if it occurs after the selected interval. The timing for the interval is initialized and restarted whenever the selected edge occurs. Intervals of between 10 ns and 20 s can be selected.

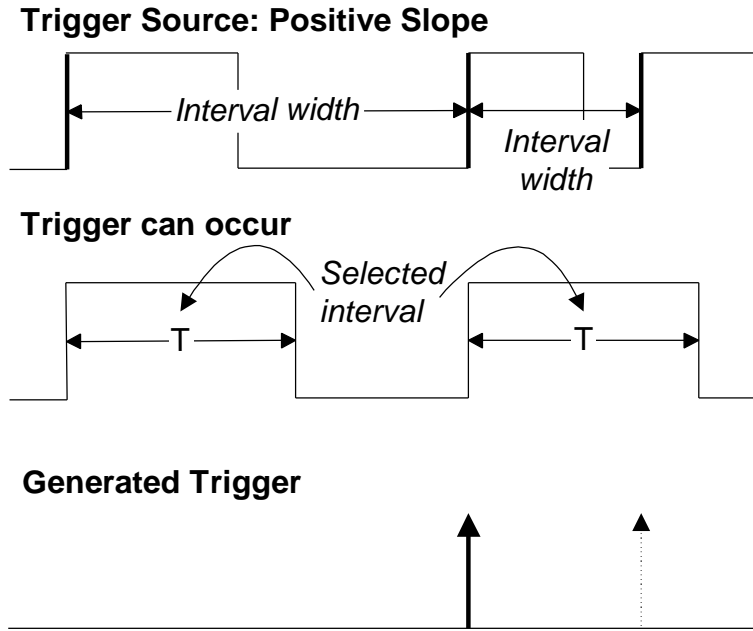

Figure 8–11. Interval Trigger: Trigger if the interval is greater than the selected width.

Triggers and When to Use Them

Interval Between Range

This Interval Trigger selects a maximum interval between the two edges of the same slope (Fig. 8–12). The trigger is generated on the second edge if it occurs within the selected interval range. The timing for the interval is initialized and restarted whenever the selected edge occurs. Intervals of between 10 ns and 20 s can be selected.

Trigger Source: Positive Slope

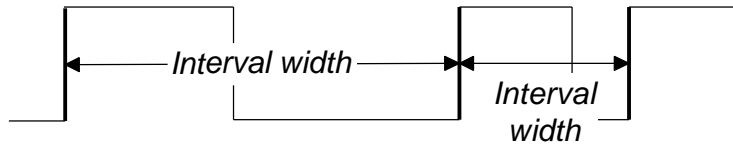

Trigger can occur

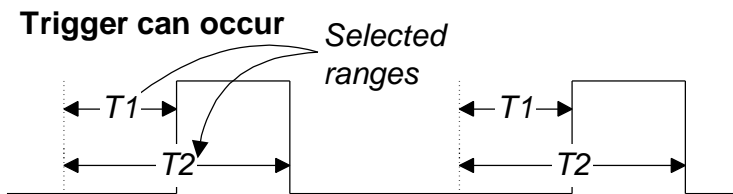

Generated Trigger



Figure 8–12. Interval Trigger: Trigger if the interval is between the selected ranges.

Ext10 AC 0.5 V 50Ω
715 ns ≤ iw ≤ 1.37 μs

INTERVAL TRIGGER WITH TIME WINDOW SYMBOL

Interval Outside Range

This Interval Trigger selects a minimum interval between the two edges of the same slope (*Fig. 8–13*). The trigger is generated on the second edge if it occurs after the selected interval range. The timing for the interval is initialized and restarted whenever the selected edge occurs. Intervals of between 10 ns and 20 s can be selected.

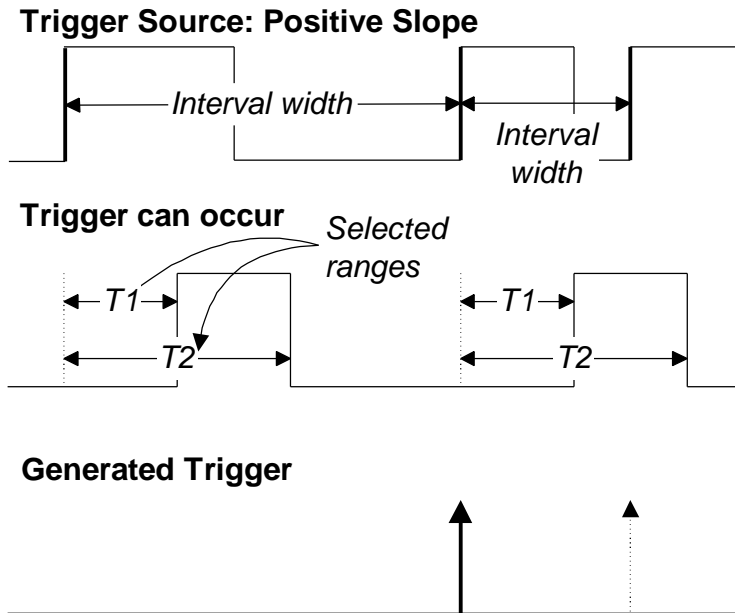

Figure 8–13. Interval Trigger: Trigger if the interval is outside the selected ranges.



Triggers and When to Use Them

Pattern Trigger

**NOT AVAILABLE ON
9304C, 9310C, 9314C SERIES**

Pattern Trigger (*Fig. 8–14*) enables triggering on a logical combination of the inputs CH 1, CH 2 (plus CH 3 and CH 4 on four-channels models) and EXT. This combination, called a pattern, is defined as the logical AND of trigger states. A trigger state is either high or low: high when a trigger source is greater than the trigger level (threshold); low when less than this threshold (*Fig. 8–15*). For example, the pattern could be defined as present when the trigger state for CH 1 is high, CH 2 is low, and EXT is irrelevant (X or don't care). If any of these conditions are not met, the pattern state is considered absent. Limits can be selected from 10 ns to 20 s.

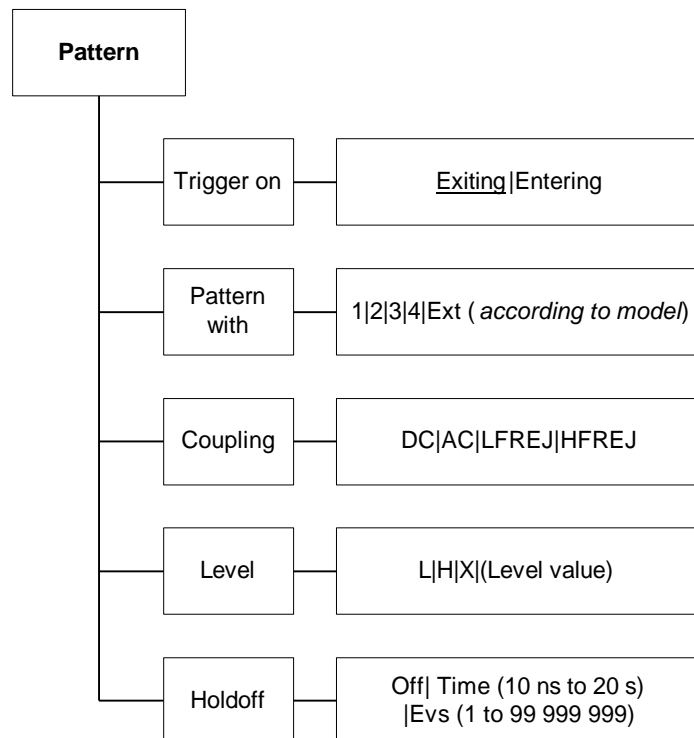

Figure 8–14. Pattern Trigger Menu (see page 8–33).

Applications

Pattern Trigger is useful in digital design for the testing of complex logic inputs or data transmission buses.

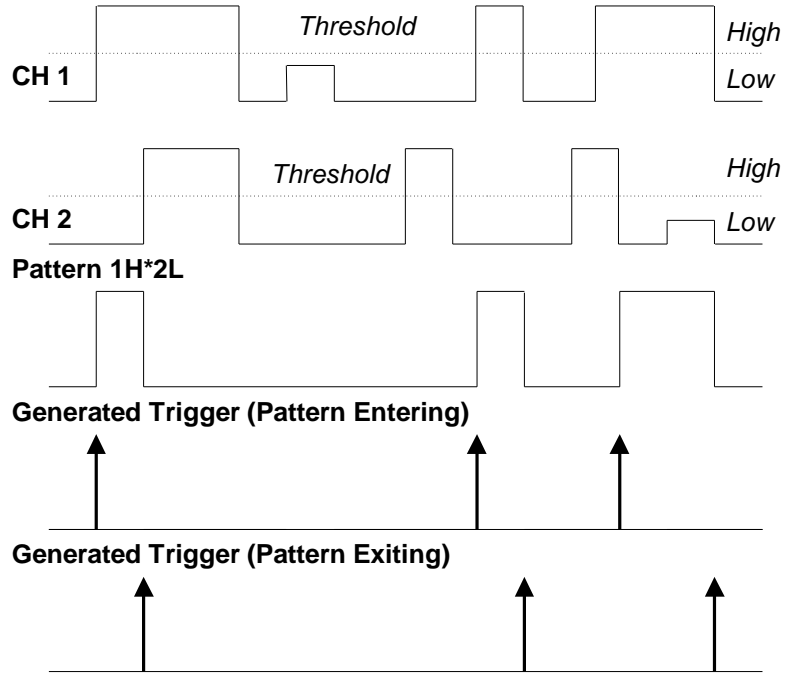
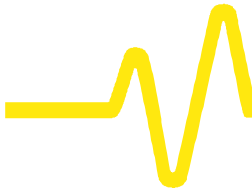

Figure 8–15. Pattern Trigger: Trigger when pattern conditions met.

Enter 1L*2H*3H*4H*EL

PATTERN TRIGGER SYMBOL



Triggers and When to Use Them

More About Pattern Trigger Once the pattern is defined, one of two transitions can be used to generate the trigger. When the pattern begins, called *entering* the pattern, a trigger can be generated. Alternatively, a trigger can be generated when the pattern ends, *exiting* the pattern.

With pattern triggering, as in single source, either of these qualifications can be selected: Hold-off for 10 ns up to 20 s, or Hold-off for 1 to 99 999 999 events.

Set to Pattern Trigger, the oscilloscope always checks the logic AND of the defined input logic states. However, with the help of de Morgan's laws, the pattern becomes far more generalized.

Consider the important example of the Bi-level or Window Pattern Trigger. Bi-level implies the expectation of a single-shot signal on which the amplitude will go in either direction outside a known range. To set up a Bi-level Pattern trigger, connect the signal to two inputs: Channels 1 and 2 or any other pair that can be triggered on. For example, the threshold of CH 1 could be set to +100 mV and that of CH 2 at -200 mV. The Bi-level Trigger will occur if the oscilloscope triggers on CH 1 for any pulse greater than +100 mV, or on CH 2 for any pulse less than -200 mV. For improved precision, the gains of the two channels should be at the same setting.

In Boolean notation we can write:

$$\text{Trigger} = \text{CH 1} + \overline{\text{CH 2}},$$

i.e. trigger when entering the pattern CH 1 = high OR CH 2 = low.

By de Morgan's laws this is equivalent to:

$$\text{Trigger} = \overline{\overline{\text{CH 1}} \cdot \text{CH 2}},$$

i.e. trigger when exiting the pattern CH 1 = low AND CH 2 = high.

This configuration can be easily programmed.

The possibility of setting the threshold individually for each channel extends this method so that it becomes a more general Window Trigger: in order to trigger the input pulse amplitude must lie within or outside a given arbitrary window.

Pattern Trigger has been designed to allow a choice of the trigger point. By choosing *1L*2H entering*, the trigger will occur at the moment the pattern 1L*2H becomes true.

Qualified Triggers

In the case of Qualified Triggers (*Fig. 8–16*), a signal's transition above or below a given level, the *validation*, serves as an enabling, or qualifying, condition for a second signal that is the source of the trigger.

Two Qualified Triggers are available: State-Qualified, where the amplitude of the first signal must remain in the desired state until the trigger occurs, and Edge-Qualified, for which the validation is sufficient and no additional requirement is placed on the first signal.

A Qualified Trigger can occur immediately after the validation or within a set time after it. Or it can occur following a predetermined time delay or number of potential trigger events. The time delay or trigger count is restarted with every validation.

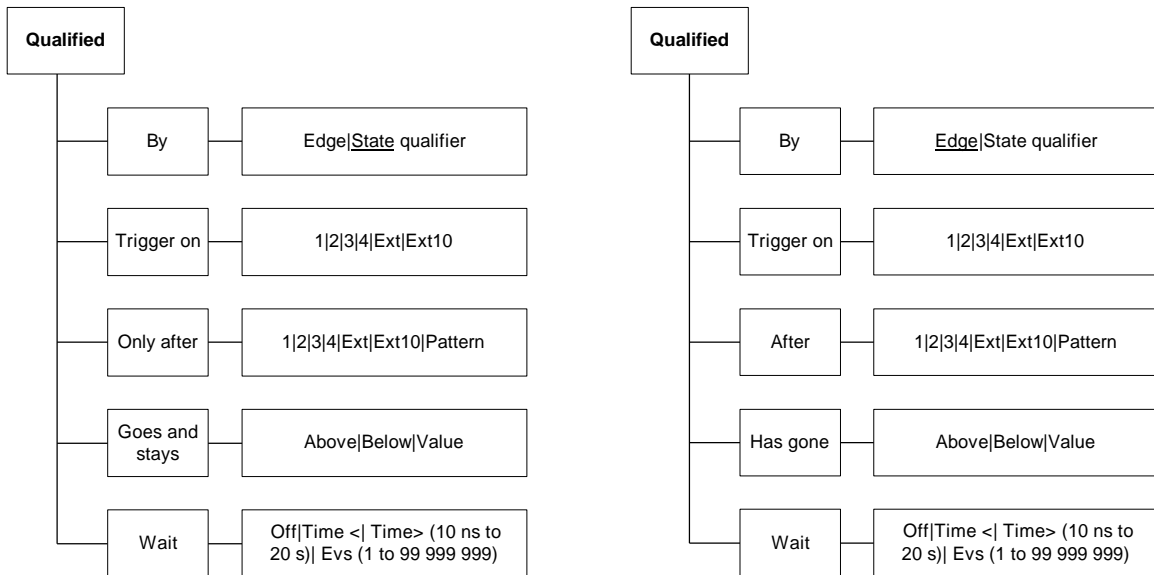

Figure 8–16. State- and Edge-Qualified Trigger Menus (see pages 8–35 and 8–36).



Triggers and When to Use Them

Qualified Triggers offer the choice of generating a trigger either when the selected pattern is present or absent. As with Pattern Trigger, the pattern is defined as a logical AND combination of trigger states that are either high or low: high when a trigger source is greater than the selected trigger level, and low when it is less than. For example, a pattern might be defined as present when the trigger states for Channels 1 and 2 are high and EXT is low. If any of these conditions is not met, the pattern state is considered absent.

Qualified Triggers allow an additional qualification once the selected pattern state occurs. For example: "wait for 10 ns up to 20 s, trigger on CH 1 to the 99 999 999th event". The pattern is used to qualify the trigger without actually generating it. Triggering will occur when another signal, the trigger source, meets its trigger condition while the pattern is present. The trigger source itself is not allowed in the pattern.

Applications

Typical applications can be found wherever time violations occur, such as in micro-processor debugging or telecommunications.

State-Qualified with Wait State-Qualified Trigger with Wait (*Fig. 8-17*) is determined by the parameters of Time and number of Events:

- **Time** selects a delay from the start of the desired pattern. After the delay (timeout) and while the pattern is present, a trigger can occur. The timing for the delay is restarted when the selected pattern begins
- **Events** selects a minimum number of events of the trigger source. An event is generated when a trigger source meets its trigger conditions. On the selected event of the trigger source and while the pattern is present, a trigger can occur. The count is initialized and started whenever the selected pattern begins, and continues while the pattern remains. When the selected count is reached, the trigger occurs.

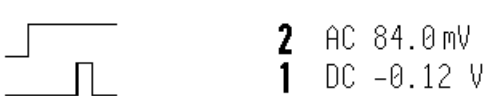

STATE-QUALIFIED TRIGGER SYMBOL

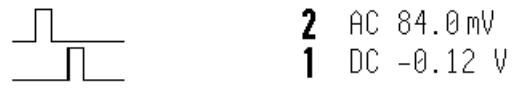

EDGE-QUALIFIED TRIGGER SYMBOL

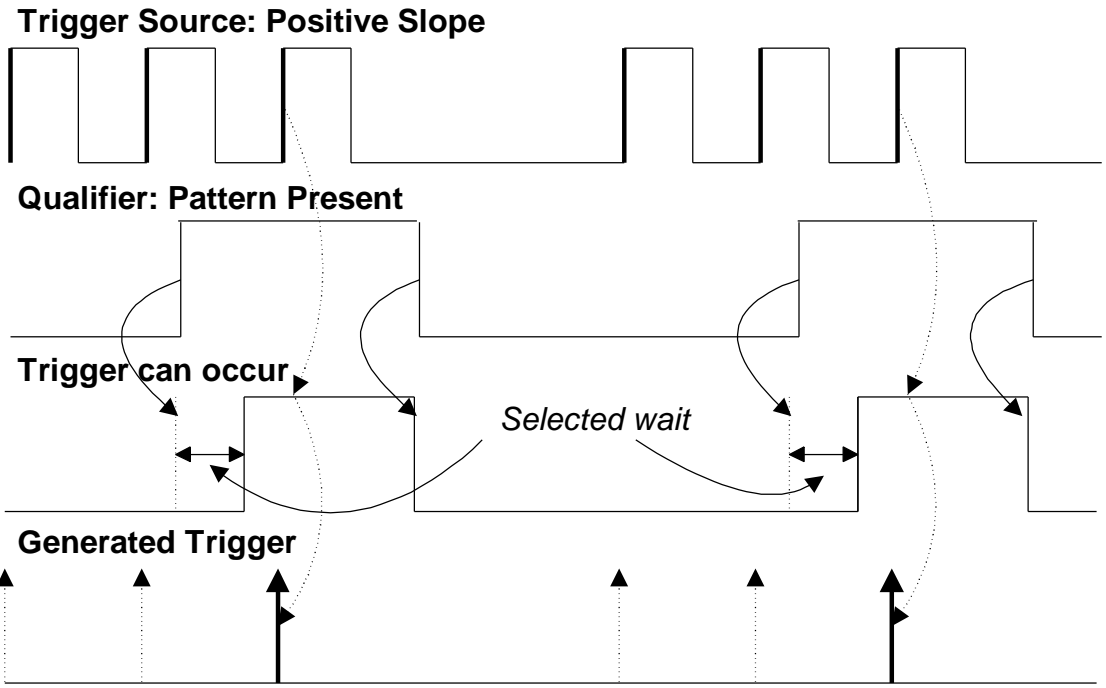
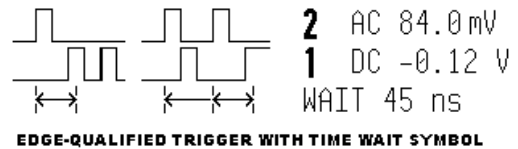
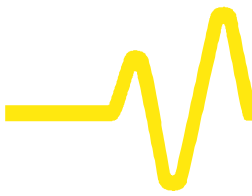

Figure 8–17. State-Qualified by Wait: Trigger after timeout.

As Figure 8–17 illustrates, a trigger is generated on a rising edge whenever the pattern is asserted (pattern present) and the wait timeout has expired. The timeout is, respectively, activated or disabled once the pattern is asserted or absent.





Triggers and When to Use Them

Edge-Qualified with Wait Like its State-Qualified equivalent, Edge-Qualified with Wait (Fig. 8–18) is conditioned by Time and Events:

- **Time** Selects a delay from the start of the desired pattern. After the delay (timeout) and before the end of the pattern, a trigger can occur. The timing for the delay is restarted when the selected pattern begins.
- **Events** selects a minimum number of events of the trigger source. An event is generated when a trigger source meets its trigger conditions. On the selected event of the trigger source and before the end of the pattern, a trigger can occur. The count is initialized and started whenever the selected pattern begins. It continues while the pattern remains. When the selected count is reached, the trigger occurs.

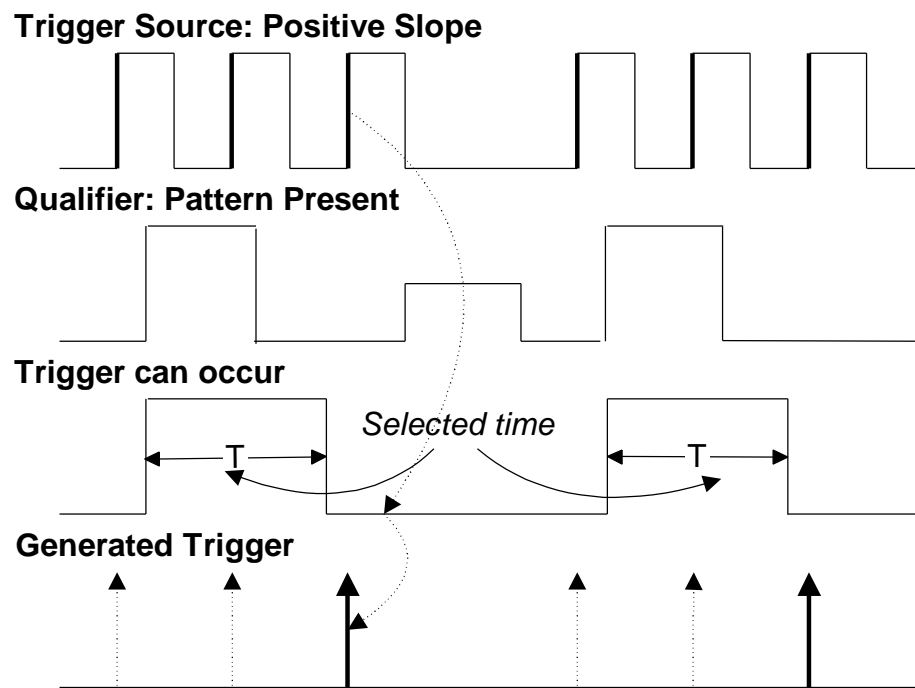

Figure 8–18. Edge-Qualified by Wait: Trigger after timeout.

TV Trigger

A special kind of Edge-Qualified Trigger, TV Trigger allows stable triggering on standard or user-defined composite video signals, on a specific line of a given field. Applications can be found wherever TV signals are present. And TV Trigger can be used on PAL, SECAM or NTSC systems.

A composite video signal on the trigger input is analyzed to provide a signal for the beginning of the chosen field — “any”, “odd” or “even” — and for a signal at the beginning of each line. The field signal provides the starting transition, and the beginnings of line pulses are counted to allow the final trigger on the chosen line.

Each field, the number of fields, the field rate, interlace factor, and number of lines per picture must be specified — although there are standard settings for the most common types of TV signals. TV Trigger can also function in a simple any-line mode.

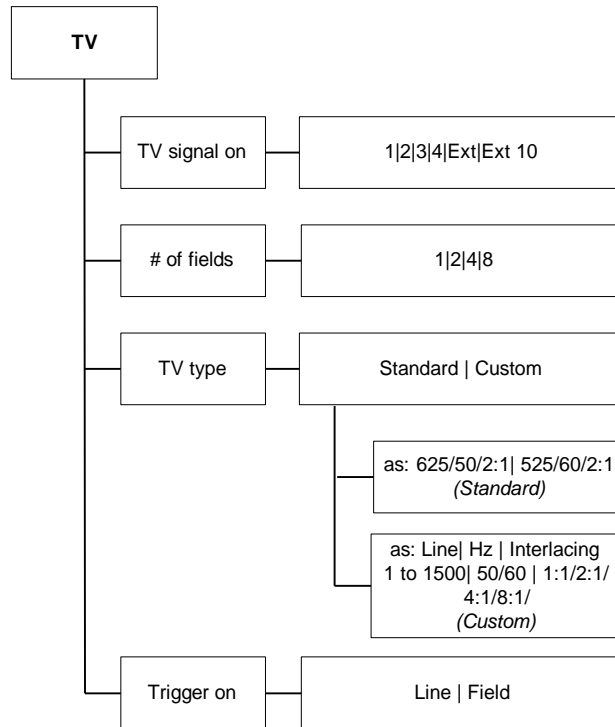
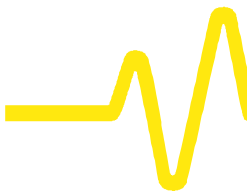

Figure 8–19. TV Trigger Menus (see page 8–34)



Triggers and When to Use Them

Notes for TV Trigger

- *Because most TV systems have more than two fields, the enhanced field-counting capability (FIELDLOCK) allows the oscilloscope to trigger consistently on a chosen line within a chosen field of the signal. The field-numbering system is relative, in that the oscilloscope cannot distinguish between lines 1, 3, 5, and 7 (or 2, 4, 6, and 8) in an absolute way.*
- *For each of the characteristics the following remarks apply:*
 - **625/50/2:1 (PAL and SECAM systems)**
This setting should be used for most of the standard 50-field signals. The lines may be selected in the range 1 to 626 where line 626 is identical to line 1.
Number of fields: eight is most useful for color PAL signals; four for SECAM signals.
 - **525/60/2:1 (NTSC systems)**
This setting should be used for standard 60-field NTSC signals. The lines can be selected in the range 1 to 1051, where line 1051 is identical to line 1.
Number of fields: four is most useful for US-type NTSC systems.
 - **?/50/?, ?/60/?**
In order to allow maximum flexibility, no line-counting convention is used. The line count should be thought of as a line-synchronizing pulse count. It includes the transitions of the equalizing pulses. For certain extreme cases, the field transition recognition will no longer work, and only the “any line” mode will be available.
- *The enhanced field-counting capability cannot be used for RIS acquisitions.*
- *Composite video signals must have negative-going synch to be decoded correctly.*



1 Line 283(20) Field 2,
525/60/2:1

TV TRIGGER SYMBOL

Dropout Trigger

Dropout Trigger (*Fig. 8–20*) provides triggering whenever the signal disappears for a selectable period of time. The trigger is generated at the end of the time-out period following the “last” trigger source transition. Time-outs of between 25 ns and 20 s can be selected.

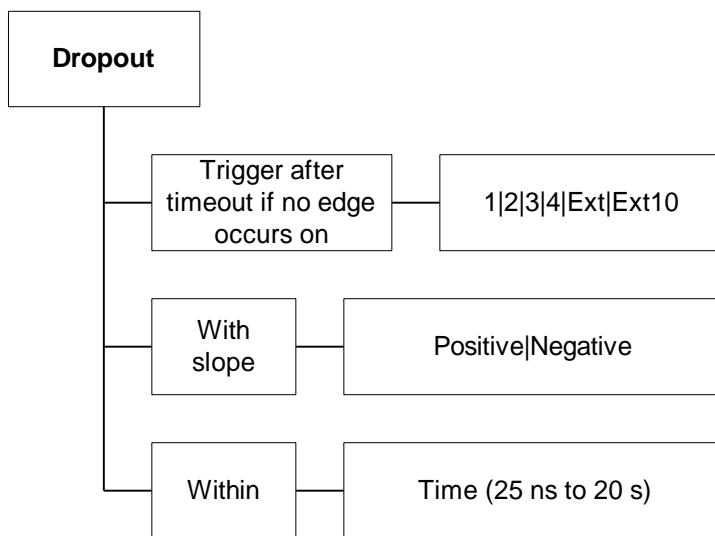

Figure 8–20. Dropout Trigger Menu (see page 8–37)

Applications

Dropout Trigger is useful for detecting interruptions in data streams such as network hang-ups and microprocessor crashes.

A typical application is on the last ‘normal’ interval of a signal that has disappeared completely. This is essentially a single-shot application, usually with a pre-trigger delay. RIS acquisition is not useful here because the timing of the trigger timeout is insufficiently correlated with the input channel signals.

Triggers and When to Use Them

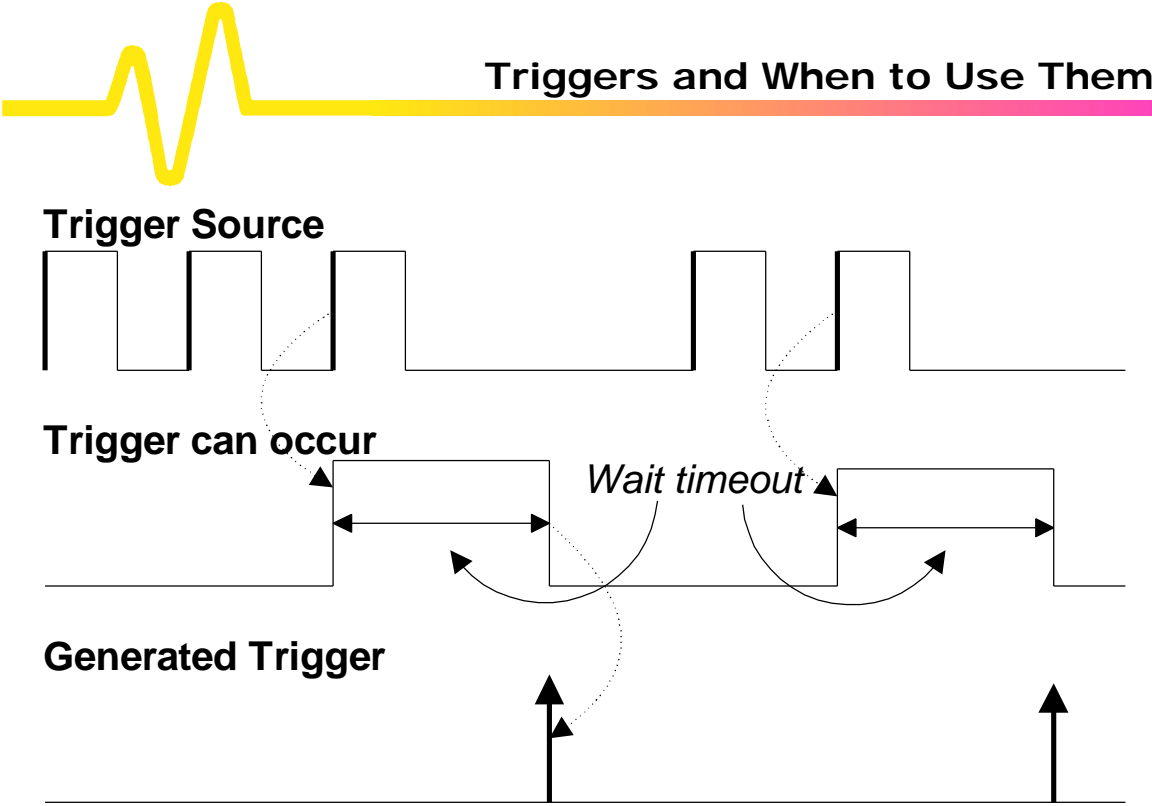



Figure 8-21. Dropout Trigger: A trigger occurs when the timeout has expired.



TRIGGER SETUP: SMART

TRIGGER
SETUP

Press  to access, too, the various SMART Trigger types, to trigger on:

- Glitches
- Intervals
- Abnormal signals (Exclusion Trigger)
- Patterns (*NOT AVAILABLE ON 9304C, 9310C, 9314C SERIES*)
- State- or edge-qualified events
- TV signals
- Dropouts.

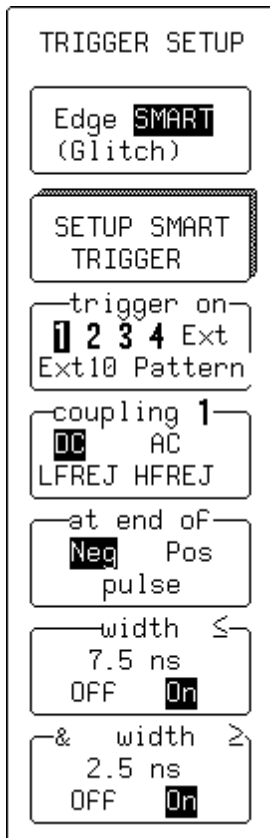

Edge/SMART To select "SMART"

SETUP SMART TRIGGER

This is primary menu that accesses the "SMART TRIGGER" menu group, for choosing the type of SMART Trigger required from the "type" secondary menu. *This and the other SMART menus are described starting page 8–30.*



Triggers and When to Use Them

SMART TRIGGER – Glitch

SMART TRIGGER	
type	Glitch
	Interval
	TV
	Qualified
	Dropout
trigger on	1 2 3 4 Ext
	Ext10 Pattern
coupling 1	DC AC
	LFREJ HFREJ
at end of	Neg Pos
	pulse
width ≤	12.5 ns
	OFF On
& width ≥	2.5 ns
	OFF On

type

To select “Glitch”.

trigger on

For selecting the trigger source (*four-channel menu shown*).

coupling

To select the trigger coupling.

at end of

To define the test on either “Pos”-itive or “Neg”-ative pulses.

width ≤

When “On” instructs the instrument to trigger if the pulse is smaller than the value defined in this field. The value can be adjusted with the associated menu knob, while the test can be turned on or off by pressing the menu button, and used in combination with the “width ≥” test. Width values in the range 2.5 ns to 20 s can be entered.

& width ≥

“On” instructs the instrument to trigger if the pulse is greater than the value defined in that field. The value can be adjusted using the associated menu knob, and the test turned on or off with the menu button in combination with the “width ≤” test menu selection. The two width limits are combined to select glitches within (“&”) a certain range if the “width ≤” value is greater than the “width ≥” value. Otherwise, they are combined to select glitches outside this range.

SMART TRIGGER – Glitch – Pattern

(NOT ON 9304C, 9310C, 9314C SERIES)

SMART TRIGGER

type
Glitch
Interval
TV
Qualified
Dropout

trigger on
1 2 3 4 Ext
Ext10 Pattern

for pattern
Present
Absent

width ≤
12.5 ns
OFF On

& width ≥
2.5 ns
OFF On

When “**Pattern**” is selected in Glitch mode, the instrument triggers on the logic AND of up to five sources.

type

To select “**Glitch**”.

trigger on

To select “**Pattern**” (*four-channel menu shown*).

for pattern

For selecting pattern “**Present**” or “**Absent**”.

width ≤

To trigger if the pattern is present or absent for less than the time value defined in that field. The value can be adjusted with the associated menu knob and the test commuted to “≥” by pressing the corresponding menu button.

& width ≥

To trigger if the pattern is present or absent for more than the time value defined in that field. The value can be adjusted and the test commuted to “≤” as per “width ≤”.



Triggers and When to Use Them

SMART TRIGGER – Interval

SMART TRIGGER

type
Glitch
Interval
TV
Qualified
Dropout

trigger on
1 2 3 4 Ext
Ext10 Pattern

coupling 1
DC AC
LFREJ HFREJ

between
Pos Neg
edges

interval \leq
42.5 ns
OFF **On**

OR interval \geq
0.645 ms
OFF **On**

type

To select "Interval".

trigger on

For selecting the trigger source (*four-channel menu shown*).

coupling

For selecting the trigger coupling.

between

To define the interval between two adjacent "Pos"-itive or "Neg"-ative edges.

interval \leq

To trigger if the interval is smaller than the value defined here, which can be adjusted using the associated knob. The test can be turned on or off with the corresponding menu button, and can be used in combination with the "interval \geq " test. Interval values in the range 10 ns to 20 s may be entered.

OR interval \geq

To trigger if the interval is greater than the value defined here, which can be adjusted using the associated menu knob. The test can be turned on or off using the corresponding menu button, and can be used in combination with the "interval \leq " test. The two interval limits are combined to select intervals within ("&") a range if the "interval \leq " value is greater than the "interval \geq " value. Otherwise they are combined to select intervals outside ("OR") the range.

SMART TRIGGER – Pattern

(NOT ON 9304C, 9310C, 9314C SERIES)

SMART TRIGGER

type
Interval
TV
Qualified
Dropout
Pattern

trigger on
Exiting
Entering

Pattern with
1 2 3 4 Ext

coupling 1
DC AC
LFREJ HFREJ

level
178mV
L H X

holdoff
1.61 μ s
OFF Time Evts

type

To select **"Pattern"**.

trigger on

To select **"Entering"** for the scope to trigger when the pattern starts being *true*, and **"Exiting"** for triggering when it stops being *true*.

Pattern with

For selecting the channel to be modified using the lower menus' corresponding menu buttons (*four-channel menu shown*).

coupling

To select the desired coupling. HF coupling is not available for Pattern Trigger.

level

For modifying these values using the associated knob — adjusts the level — and the corresponding menu button, which chooses **"L"** (low), **"H"** (high), or **"X"** (Don't care).

holdoff

To disable the trigger circuit for a definable period of time or number of events *after* a trigger event (a change in the input signal that satisfies the trigger conditions). When not turned off, holdoff can be defined as a period of **"Time"** or a number of **"Evts"** (events). Use the associated menu knob to vary the "holdoff" value. Time holdoff values in the range 10 ns–20 s may be entered. Event counts in the range 1–10⁹ are allowed.



Triggers and When to Use Them

SMART TRIGGER – TV

SMART TRIGGER	
type	
Glitch	
Interval	
TV	
Qualified	
Dropout	
TV signal on	
1 2 3 4 Ext	
Ext10	
# of Fields	
1 2	
4 8	
TV type	
Standard	
Custom	
as	
625/50/2:1	
525/60/2:1	
trigger on	
Line Field	
315 2	

type

To select “TV” .

TV signal on

For selecting the trigger source (*four-channel menu shown*).

of fields

To define the number of fields — up to eight.

TV type

For selecting either “**Standard**” or “**Custom**” TV decoding.

as

When “**Standard**” is chosen, for selecting either “**625/50/2:1**” (PAL SECAM) or “**525/60/2:1**” (NTSC) standards.

When “**Custom**” is selected, for specifying the number of lines and cycles, and setting the interlacing factor for non-standard TV signals.

trigger on

For selecting the line and field number on which to trigger.

SMART TRIGGER – Qualified – State

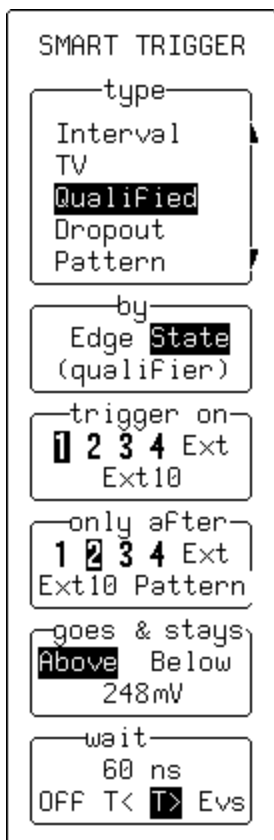

type

To select “Qualified”.

by

To select “State”.

trigger on

For selecting the trigger source — the other conditions for this source can be set up using Edge Trigger (*four-channel menu shown*).

only after

To select the qualifier source — the other conditions can be set up using Edge Trigger.

goes & stays

For selecting the qualifier threshold using the associated knob, and using the menu button to select whether the qualifier signal will be valid either “Above” or “Below” that threshold.

When “Pattern” is selected as the qualifier source, this menu is used to determine whether the pattern should be present or absent.

wait/within

To specify the time limit (“T<”) for accepting the trigger event. And alternatively, to specify how much time (“T>”) or how many trigger events (“Evs”) should be allowed before the acquisition is taken on the next trigger event. The qualifier signal must remain valid until the final trigger has been received. The time value can be chosen in the range 10 ns–20 s. The trigger event count can be chosen in the range 1–10⁹.

Triggers and When to Use Them

SMART TRIGGER – Qualified – Edge

SMART TRIGGER

type
Interval
TV
Qualified
Dropout
Pattern

by
Edge State
(qualifier)

trigger on
1 2 3 4 Ext
Ext10

after
1 2 3 4
Pattern

has gone
Above Below
-133mV

within
130 ns
OFF **T<** T> Evs

type

To select “Qualified”.

by

To select “Edge”.

trigger on

For selecting the trigger source — the other conditions for this source are set up using Edge Trigger (*four-channel menu shown*).

after

For selecting the qualifier source — other setup conditions use Edge Trigger (*four-channel menu shown*).

has gone

To adjust the qualifier threshold and determine whether the qualifier signal is valid once it “has gone” above or below that threshold. “Pattern” selected as the qualifier source determines whether the pattern should be present or absent.

wait/within

To specify the time limit (“T<”) for accepting the trigger event. Or, to specify the delay in time (“T>”) or number of trigger events (“Evs”) after a valid transition has occurred. A trigger can only be accepted after this delay. Any subsequent qualifier event restarts this count. The time value can be chosen in the range 10 ns–20 s. The trigger event count can be chosen in the range 1–10⁹.

SMART TRIGGER – Dropout

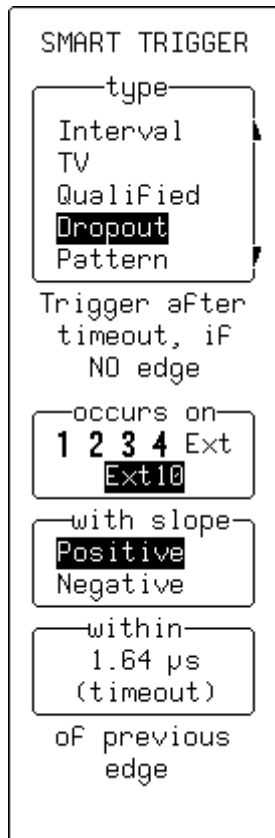

type

To select "Dropout".

trigger after timeout, if NO edge occurs on

For selecting the trigger source (*four-channel menu shown*).

with slope

To define whether the measurement starts on a "Positive" or "Negative" slope of the trigger signal.

Within... of previous edge

For defining the time-out value in the range 25 ns–20 s.

ZOOM + MATH Controls

A wide range of Zoom and Mathematical processing functions (*detailed in the next chapter*) can be performed on acquired waveforms with the controls described here.

Four processed traces are available for straight-forward zooming or for waveform mathematics. Any one of these traces, A, B, C or D, can be set up to zoom a trace acquired on any channel or stored in any of the four reference memories M1–4. Or zoom any of the other three original traces. Thus Trace A, for example, could be set up to zoom Trace B, C, or D, but not itself. The Displayed Trace label at left of screen indicates the source.

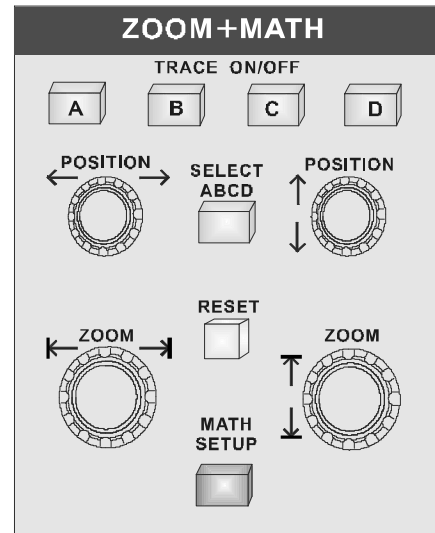

The **TRACE ON/OFF** buttons display the corresponding trace A, B, C or D. When a trace is switched on, the **POSITION** and **ZOOM** knobs and the **RESET** button will then be attributed to this, the *active* trace.

The **SELECT ABCD** button assigns the controls to the active trace for adjustment, as only one trace can be modified at a time. Pressing this button activates the next trace, in A–D sequence.

The four **ZOOM + MATH** knobs adjust the horizontal and vertical positions and expansion factors of the zoomed trace...



The **POSITION** knob repositions zoomed traces *horizontally*. If the source of the expanded waveform is displayed, an intensified region corresponding to the area of expansion is shown.



Whereas the knob *vertically* repositions the active trace.



The **ZOOM** knob *horizontally* expands or contracts the active trace. If the source of the zoomed trace is also displayed, it will show an intensified region corresponding to the area of expansion.



While the knob *vertically* expands or contracts the active trace.



The **RESET** button resets the vertical and horizontal **POSITION** and **ZOOM**.



Finally, the **MATH SETUP** menu-entry button accesses the zoom, math and sequence segment features. *See next chapter for details.*



Zooming for Precise Waveform Measurements

Several traces can be zoomed from a single waveform to obtain precise timing measurements.

For instance, on a waveform composed of two pulses separated by a long delay, Trace A could be made a zoom of the first pulse, and Trace B a zoom of the second.

The combination of long memory and zooming allows extremely accurate time interval measurements. And the time resolution on the viewed trace can be significantly improved.

For example, choosing 50 000 points per channel on a timebase of 0.1 ms/div, traces can be expanded to as much as 50 ns/div — a factor of 2000. Using Relative Time cursors (see *Chapter 14*), a delay of, say, 500 μ s could be measured with resolution as high as 0.5 ns. Even with as many as eight million points acquired, zooming can be done until there are only a few points on the screen.

Using Multi-Zoom

With Multi-Zoom, the zoomed region of the waveform can be moved simultaneously along two or more different traces, or two or more regions of the same trace.

When “Multi-Zoom” “On” is selected from the “ZOOM – MATH” menu (see *page 10–8*), the horizontal zoom and position controls apply simultaneously to all displayed traces — A, B, C and D — allowing similar sections of different traces to be viewed at the same time. The vertical controls still act individually on the traces: switching from one trace to another is done using the TRACE ON/OFF buttons. The highlighting of trace titles in the Displayed Trace label indicates an active Multi-Zoom.

Zooming Math Functions

When Trace A, B, C or D is defined as a mathematical function rather than as a simple zoom (see *next section*), the zoom controls remain operative and defining another trace as a zoom of the math function becomes unnecessary. In order to view the entire

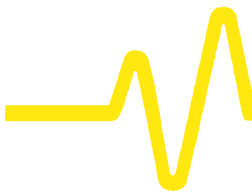

Zoom, Mathematics and Math Setup

mathematical function, simply cancel any expansion or position change by pressing RESET.

Math Functions and Options

Coverage of the Setup menus for configuring zoom, math and waveform processing functions starts page 10–6. Averaging and Extrema are outlined on this and the following pages.
For details on Enhanced Resolution filtering, see Appendix B.
How to Set Up for FFT (Fast Fourier Transform) is explained at the conclusion of this chapter, while a complete description of FFT practice and theory is presented in Appendix C.
Information on each of the Waveform Processing packages on option is to found in Appendix A.

A wide range of standard or optional mathematical and waveform processing functions are available.

The scope's standard waveform mathematics functions consist of waveform negation, identity, addition, subtraction, multiplication and division, summed averaging of up to 1000 waveforms and the $(\sin x)/x$ interpolation function.

Advanced waveform processing features, depending on the options installed, include:

- Continuous Averaging (*menus page 10–11*);
- Summed Averaging of up to 1 000 000 waveforms (*menus 10–11*);
- Enhanced Resolution by up to 3 bits with filtering (*menus 10–12*);
- Extrema — envelope of many waveforms (*menus 10–13*);
- Fast Fourier Transform, including FFT averaging (*menus 10–14 and 10–15*);
- Mathematical Functions such as Integral, Derivative, Logarithm, Exponential, Square, and Square Root (*menus 10–16*);
- Parameter Analysis, histogramming, trending and statistical analysis (*menus page 10–17*).

Continuous Averaging

This is the repeated addition, with *unequal* weight, of successive source waveforms. It is particularly useful for reducing noise on signals that drift very slowly in time or amplitude.

However, the statistics of a continuous average tend to be worse than those from a summed average (*see next page*) on the same number of sweeps. This is because the most recently acquired waveform has more weight than all previously acquired ones: the continuous average is dominated by the statistical fluctuations of the most recently acquired.



Zoom, Mathematics and Math Setup

The weight of 'old' waveforms in the continuous average gradually tends to zero (following an exponential rule) at a rate that decreases as the weight increases.

Summed Averaging

Summed Averaging is the repeated addition, with *equal* weight, of successive source waveform records. If a stable trigger is available, the resulting average has a random noise component lower than that of a single-shot record.

Whenever the maximum number of sweeps is reached, the averaging process stops. An even larger number can be accumulated simply by changing the number in the "SETUP" "for" menu. However, the other parameters must be left unchanged or a new averaging calculation will be started.

The process may be interrupted by changing the trigger mode from NORM to STOP or by turning off the active trace using the respective buttons. Averaging will be resumed when the inverse is done. The accumulated average is reset by pushing the CLEAR SWEEPS button or changing an acquisition parameter such as input gain, offset, coupling, trigger condition, timebase or bandwidth limit. The number of current averaged waveforms of the function or its expansion is shown in the Displayed Trace label.

When summed averaging is selected, the display is updated at a reduced rate — about once every 1.5 s — in order to increase the averaging speed (points and events per second).

Summed averaging can also be done on sequence waveforms to give the average of the segments. And it can be applied to an expansion of a sequence segment, giving the segment's average waveform over many sequence acquisitions.

Extrema Waveforms

These are computed by a repeated comparison of successive source waveform records with the already-accumulated extrema waveform, which consists of a maxima (roof) and a minima (floor) record. Whenever a given data point of the new waveform is greater than the corresponding maximum roof-record value, or less than the corresponding floor value, it replaces it. Thus the maximum and the minimum envelope of all waveform records is accumulated.

Roof and Floor records can be displayed individually or together.

Whenever the selected maximum number of sweeps is reached, the accumulation stops. The same process may be interrupted by changing the trigger mode from Normal to Stopped or by turning off the function trace. Accumulation will continue when these actions are reversed.

The currently accumulated extrema waveform may be reset by either pushing the CLEAR SWEEPS button or by changing an acquisition parameter such as input gain, offset, coupling, trigger condition, or the timebase- or bandwidth-limit. The number of currently accumulated waveforms is displayed in the function's Displayed Trace Label of that of its zoom expansion.

Whenever the maximum number of sweeps is reached, an even larger number can be accumulated simply by changing the number in the "SETUP" "for" menu. However, the other parameters must be left unchanged or the extrema calculation will be restarted.

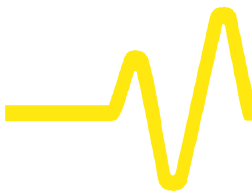

Using Waveform Mathematics

Waveform mathematics can be applied to any channel or reference memory. And any trace of A, B, C or D can be set up as a math function, allowing several computations to be made in sequence.

For example: Trace A could be set up as the difference between Channels 1 and 2; Trace B defined as the average of A, and Trace C made the integral of B — thus displaying the integral of the averaged difference between Channels 1 and 2.

In order to avoid slowing down the instrument with unwanted computations, a particular mathematical function is only computed when its display is turned on. However, using the same example as above, it would be sufficient to display Trace C alone, as the instrument knows it must compute A and B as intermediate steps to C.

Waveform processing can also take time when many data points are involved. This delay can be cut by limiting the number of data points used in the computation. To do this, the instrument will process the entire waveform by taking every Nth point, where N depends on the timebase and the desired maximum number of points, and the first point taken is always the data value at the left-hand edge of the screen.

Combining Channels

Zoom and math functions on Traces A, B, C, D and Reference Memories M1, M2, M3, M4 use the instrument's system memory, which is dynamically allocated to each trace as required. When more acquisition memory is achieved by combining channels, a single long trace can consume all the reference memory or zoom and math trace capacity in the instrument. When this happens, an on-screen warning message will avert accidental storing of a new trace to a reference memory already in use.

Note: A processing title for each displayed trace will be shown in the Displayed Trace Label. If the title is missing, the desired processing cannot be done and the contents of the trace remain unchanged.

Configuring for Zoom and Math

MATH
SETUP

Press  to enable the configuration of any of the four traces and execute any zoom, math function using the “ZOOM + MATH” menus.

Any trace and function can be chained to another trace and function (*not all functions shown are necessarily available*). Trace A, for example, could be configured to average Channel 1, Trace B could be made a Fourier Transform (FFT) of A, and Trace C a zoom of B. All traces can be viewed simultaneously on-screen using the ZOOM + MATH TRACE ON/OFF buttons. Any function can be zoomed directly.

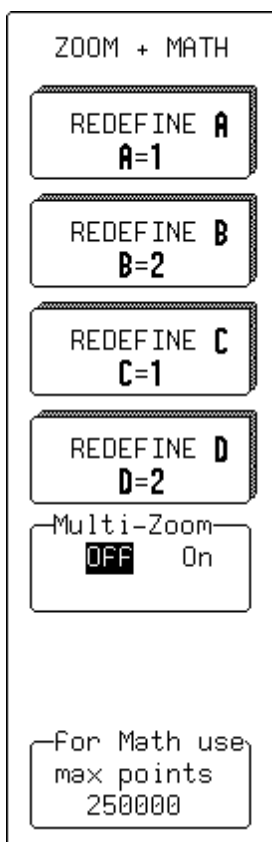

REDEFINE A, B, C, or D

To select the trace to be redefined and accesses the “SETUP” menus (*described in the remainder of this chapter, using A as an example*).

Multi-Zoom

For switching Multi-Zoom “On” or “Off”. When “On”, all displayed traces (A,B,C,D) are simultaneously controlled by the horizontal POSITION and ZOOM knobs. When “OFF”, only the active trace, chosen using the SELECT ABCD button, is controlled by POSITION and ZOOM.

Selected (*NOT SHOWN*)

When a trace with a zoom of a sequence-mode waveform is selected, the “Selected” menu — not shown here — becomes accessible. Pressing the corresponding menu button toggles the selection between display of a single, specific “Segment” and “All Segments”. With the former selected, the associated knob can be used to step through the segments and choose one.

for Math use max points^{1/4}

For selecting the maximum number of points for all math operations — a low number increases computation speed.

Zoom and Math Setup Menus

Zoom

SETUP OF A

use Math?
 No Yes

Trace A is
ZOOM of

1 2 3 4 B C D
M1 M2 M3 M4

use Math?

For toggling between “No” (Zoom only) and “Yes” (Math functions) SETUP.

Trace A, B, C or D is ZOOM of

To select the source trace to be zoomed (*four-channel menu shown*).



Zoom, Mathematics and Math Setup

Arithmetic

— allows addition, subtraction, multiplication and division, as well as choice of the two operands and the operator. The example on this page shows a setup of trace A as the sum of Channels 1 and 2.

SETUP OF A

use Math?
 No Yes

Math Type
 Arithmetic
 Average
 Correlate
 Enh. Res
 Extrema

Sum
 DiFFerence
 Product
 Ratio

1	2	3	4	B	C	D
M1	M2	M3	M4			

plus

1	2	3	4	B	C	D
M1	M2	M3	M4			

use Math?

To choose a math function.

Math Type

To select "Arithmetic".

Sum Difference Product Ratio

For selecting the operator.

1 2 3 4 B C D M1 M2 M3 M4

To select one of two operand source traces (*four-channel menu shown*).

plus 1 2 3 4 B C D M1 M2 M3 M4

To select the other operand source trace (*four-channel menu shown*).

Zoom and Math Setup Menus

Average

```
SETUP OF A
-----
use Math?
No  Yes
-----
Math Type
Arithmetic
Average
Correlate
Enh. Res
Extrema
-----
Avg Type
Summed
Continuous
-----
For
1000
(sweeps)
-----
of
1 2 3 4 B C D
M1 M2 M3 M4
```

— offers Summed (Linear) or Continuous (Exponential) Averaging. Shown here is an example setup of trace A as a Summed Average (over 1000 sweeps) of Channel 1. *See also page 10–3.*

use Math?

To choose a math function.

Math Type

To select, in this case, “**Average**” (other choices in the example menu shown here include options not available on the standard scope).

Avg Type

To select “**Summed**” or “**Continuous Average**”.

for / weight

When “**Summed**” is selected, this menu (“for”) is used to define the number of sweeps. When “**Continuous Average**” is chosen, the same menu becomes “weight” and is used to define the weight, similar to number of sweeps.

In “for” the *first* n sweeps will be taken into account, whereas in “weight” the *last* sweep will be given a weight of 1 and the previous result a weight of n in calculating the new average.

of

For selecting the source trace for averaging (*four-channel menu shown*).



Zoom, Mathematics and Math Setup

Enhanced Resolution*

— allows the selection of low-pass digital filters that increase the resolution of the displayed signal at the expense of its bandwidth. Appendix B gives a detailed explanation.

These digital filters work very much like analog bandwidth-limit ones. In Single-Shot mode, they and the sampling speed affect bandwidth. If high bandwidth is needed at slow timebases, averaging and repetitive sampling should be considered.

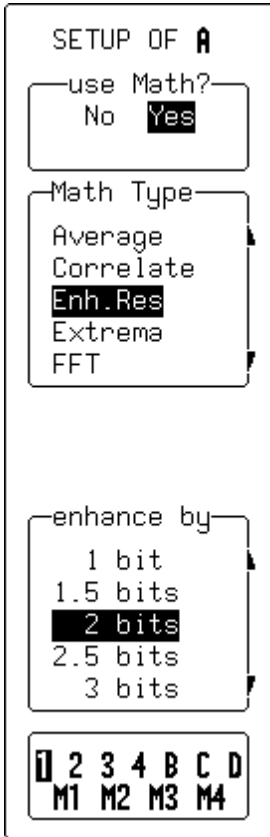

use Math?

To choose a math function.

Math Type

To select "Enhanced Resolution".

enhance by

For selecting the filter that will enhance resolution of the displayed signal from one to three bits in 0.5-bit steps.

1 2 3 4 B C D
M1 M2 M3 M4

To select the source trace for filtering (*four-channel menu shown*).

* Only with WP01 Advanced Math package. See "Signal Analysis" in Appendix A for specifications.

Zoom and Math Setup Menus

SETUP Extrema[†]

— used for acquiring a trace envelope over many acquisitions (see also page 10–4).

```
SETUP OF A
-----
use Math?
No  Yes
-----
Math Type
Correlate
Enh.Res
Extrema
FFT
FFTAVG
-----
limits
Env
Floor  Roof
-----
for
1000
(sweeps)
-----
of
1 2 3 4 B C D
M1 M2 M3 M4
```

use Math?

To choose a math function.

Math Type

To select “Extrema”.

limits

To select either “Envelope”, “Floor” or “Roof”. Floor shows only the lower, and Roof only the upper part of the envelope. Changing the limits does not force the analysis to start again.

for

For selecting the number of sweeps.

of

To select the source trace (*four-channel menu shown*).

[†] Only with WP01 Math package. See “Signal Analysis” in Appendix A for specifications.



Zoom, Mathematics and Math Setup

SETUP – FFT[‡]

— used to display the Fast Fourier Transform (FFT) of a signal and visualize it in the frequency domain. See the final section of this chapter, and Appendix C, for when and how to use FFT.

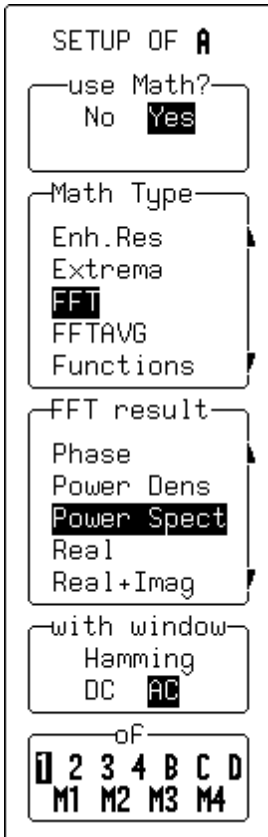

use Math?

To choose a math function.

Math Type

For selecting “FFT”.

FFT result

To select the FFT’s output format: “Imaginary”, “Magnitude”, “Phase”, “Power Dens”-ity, “Power Spect”-rum, “Real” or “Real + Imag”.

with window

Using the corresponding menu button to select the FFT window type from “Rectangular”, “Hanning”, “Hamming”, “Blackman-Harris”, and “Flat-top”. And the associated knob to select “AC” or “DC”.

of

For selecting the source trace (*four-channel menu shown*).

Note: During Fast Fourier Transform computation the FFT sign is displayed in the lower right-hand corner of the screen. The computation of FFT on long time-domain records can take time. The computation can be interrupted or aborted at any time using any front-panel control.

[‡] Only with WP02 Spectral Analysis package. See “Signal Analysis” in Appendix A for specifications.

Zoom and Math Setup Menus

SETUP – FFT Average[§] — used for displaying the FFT power averaging of an FFT source trace, power averaging being useful for characterizing broadband noise or periodic signals without a stable trigger signal. Total power — signal and noise — is measured at each frequency. The source trace must be an FFT function. See the final section of this chapter, and Appendix C, for when and how to use FFT.

```
SETUP OF A
-----
use Math?
  No  Yes
-----
Math Type
  Extrema
  FFT
  FFTAvg
  Functions
  Histogram
-----
FFT result
  Magnitude
  Power Dens
  Power Spect
-----
For
  1000
  (sweeps)
-----
of
  B  C  D
```

use Math?

To choose a math function.

Math Type

To select “**FFT AVG**”.

FFT result

To select the output format of the FFT Average: “**Magnitude**”, “**Power Density**”, “**Power Spectrum**”.

for

For selecting the number of sweeps.

of

To select the FFT source.

Note: *FFT Average can be reset by pressing CLEAR SWEEPS. The number of currently accumulated waveforms is then shown in the Displayed Trace field of the function or its expansion.*

[§] Only with WP02 Spectral Analysis package. See “Signal Analysis” in Appendix A for specifications.

SETUP – Functions** — gives access to a menu offering a variety of Math display functions.

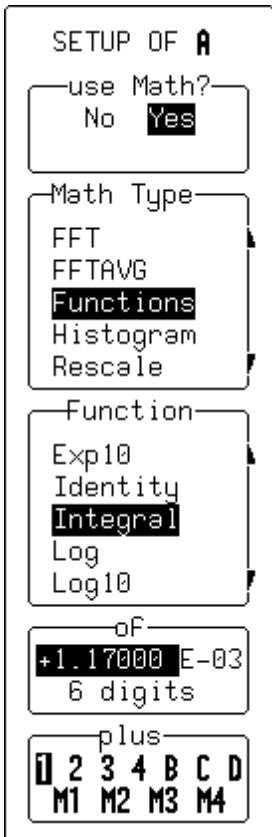

use Math?

To choose a math function.

Math Type

For selecting “Functions”.

Function

To select a function type from this list:

- “Absolute value”
- “Derivative”
- “Exp (base e)”
- “Exp 10 (base 10)”
- “Identity”
- “Integral”
- “Log (base e)”
- “Log 10 (base 10)”
- “Negation”
- “Reciprocal”
- “Sinx/x”
- “Square”
- “Square root”

of

For selecting the signal offset (used to compensate for any DC offset in the signal).

plus

For selecting the source trace (*four-channel menu shown*).

Notes for Math Functions

- *Square root is computed on the absolute value of the source waveform.*
- *For logarithmic and exponential functions the numerical value (without units) of the input waveform is used.*
- *For the integral function the source waveform may be offset by an Additive Constant in the range -10^{16} to $+10^{16}$ times the vertical unit of the source waveform.*

** Functions shown include functions available only with WP01 Math package. See “Signal Analysis” in Appendix A for specifications.

Zoom and Math Setup Menus

SETUP – Histogram^{††} — used to select the histogramming function and set-up for parameter analysis.

```
SETUP OF A
-----
use Math?
No Yes
-----
Math Type
FFTAVG
Functions
Histogram
Rescale
Trend
-----
MORE
HIST SETUP
-----
FIND CENTER
AND WIDTH
-----
Histogram
custom line 1
ampl(1)
-----
using up to
1000
(values)
```

use Math?

To choose a math function.

Math Type

For selecting “Histogram”.

MORE HIST SETUP

To access the secondary menu offering more histogram settings.

FIND CENTER AND WIDTH

To calculate optimal center- and bin-width values for the histogram.

Histogram

To select up to five source parameters for histogramming.

using up to

For limiting the total histogram population.

^{††}Only with WP03 Parameter Analysis or DDM/PRML Disk Drive Measurements/Supplementary Disk Drive Measurements packages. See *these options’ respective Operator’s Manuals*.



Zoom, Mathematics and Math Setup

SETUP – Rescale



— for selecting a waveform and adjusting a, the multiplication factor, and b, the additive constant, in:

$$(a * \text{waveform}) + b,$$

where both constants can have values ranging between -10^{15} and $+10^{15}$.

use Math?

To choose a math function.

Math Type

For selecting “Rescale”.

(a * 1) + b

To select “a” or “b”.

a = or b =

The corresponding menu button for this menu highlights the mantissa, the exponent, or the number of digits, while the associated knob changes the highlighted value.

1 2 3 4 B C D
M1 M2 M3 M4

To select the source trace (*four-channel menu shown*).

Setting Up FFT Span and Resolution

The FFT (Fast Fourier Transform) converts a time domain waveform into frequency domain spectra similar to those of an RF spectrum analyzer display. But unlike the analyzer, which has controls for span and resolution bandwidth, FFT span is determined by sampling rate, while resolution bandwidth is inversely proportional to record length.

Frequency Resolution Δf Correctly setting up an FFT starts with the frequency resolution, or Δf . This parameter is the spacing of samples in the frequency domain display. The Δf is set by inputting the time duration of the time domain signal to the FFT. If an acquisition channel (Channel 1 or 2, or 3 or 4) is the source, then the waveform duration is the capture time: the TIME/DIV setting multiplied by ten. *The relationship between capture time and frequency resolution is illustrated here.*

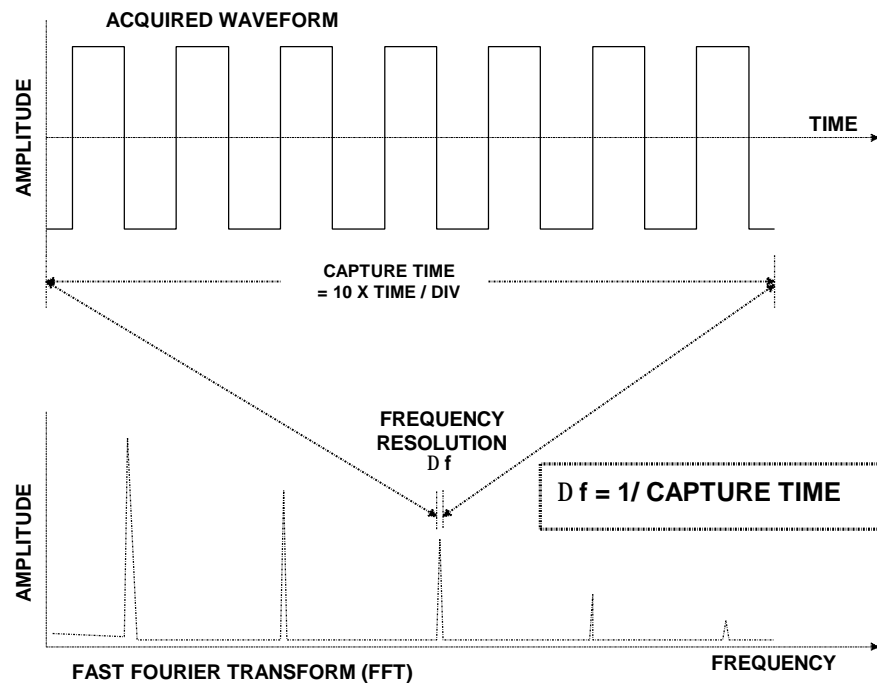



Zoom, Mathematics and Math Setup

Setting the Span

Similarly, if the source waveform is a zoom trace, the frequency resolution is the reciprocal of the displayed waveform's duration.

The frequency span of the FFT is called the Nyquist frequency and is related to the sampling frequency of the time domain waveform. If the math memory size, set using the "for Math use max points" menu (see page 10-8), is identical to the number of samples in the acquired waveform ("TIMEBASE" menus, Chapter 7), then the span will be half the sampling frequency. But if this "max points for math" number is less than the number of points, the waveform and in turn the FFT span will be decimated. *The relationship between the span of the FFT and the sampling rate ($1/DT$) is illustrated here.*

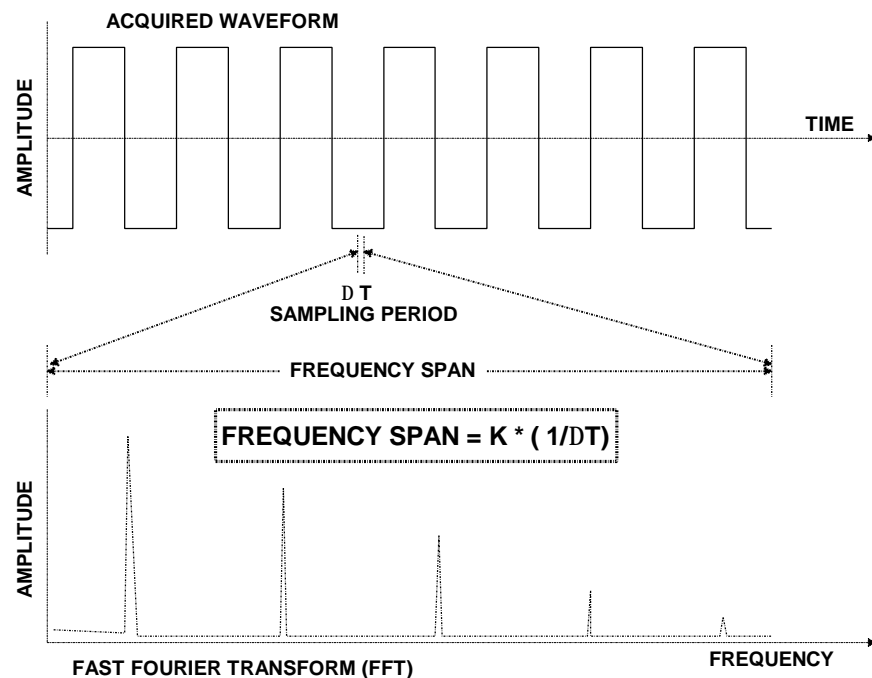

FFT Setup

The constant K in the illustration includes the decimation factor described above, as well as automatic display scaling factors. This scaling is required to ensure that the FFT's horizontal display scale falls into a 1,2, or 5 factor.

In essence, the oscilloscope automatically adjusts the span (and hence the FFT transform size) to account for the user-entered "max points for math" and the display scaling. In some combinations of these factors it also adjusts the length of the displayed trace.

The user can determine the span from the Displayed Trace Label for the math trace containing the FFT. This will show the horizontal calibration in MHz/div. The span is also explicitly shown as the Nyquist frequency in the information field that appears at the bottom of the screen when the "MATH SETUP" menus are displayed, as shown here.

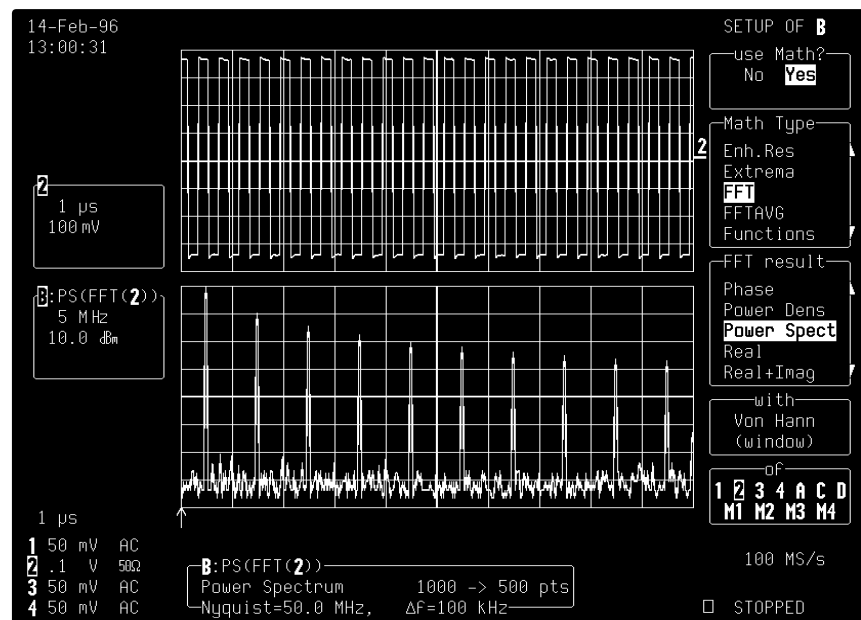



Zoom, Mathematics and Math Setup

Essentially...

To achieve a desired FFT span, first make sure that the sampling rate is more than twice the span desired. Control the sampling rate using the TIME/DIV knob and set the acquisition memory length with the "TIMEBASE" menu. The sampling rate can be further adjusted by limiting the number of points in the "for Math use max points" menu.

Example

Set up the oscilloscope for an FFT with a span of 10 MHz and a frequency resolution of 10 kHz, to analyze a continuous, periodic waveform.

1. The required frequency resolution demands a waveform duration (capture time) of 100 μ s. Setting the TIME/DIV to 10 μ s achieves the necessary Δf of 10 kHz.
2. To obtain the specified 10 MHz span, the effective sampling rate must be > 20 MS/s. On, say, an oscilloscope with a sampling rate of 500 MS/s, the 50 000-sample default memory length and a 10 μ s TIME/DIV setting would be used to first give a 250 MHz span. Now, to obtain a 10 MHz span, the sampling rate must be reduced. This can be done in either of two ways:
 - a) In "TIMEBASE": decreasing the number of samples by setting the "RECORD UP TO" menu to 2500 results in a sampling rate of 25 MS/s.
 - b) With "ZOOM + MATH", by setting the "for Math use max points" menu to 2500. This would leave the sampling rate at 500 MS/s but decimate the waveform data before the FFT by 20 000:1, thus reducing the effective sampling rate to 25 MS/s. This would in turn result in a span of 12.5 MHz, the closest achievable span to > 10 MHz.

Note: The technique described in b) above is to be preferred because it maintains a high input sampling rate and reduces the risk of aliasing the acquired data.

FFT Setup

This example, *illustrated below*, shows how the oscilloscope maintains the display factor. A sampling rate of 25 MS/s would result in a full scale range of 12.5 MHz or 1.25 MHz/Div. To maintain a display scale factor of 1,2, or 5 it decimates the acquired waveform by 25 000:1 and calculates the FFT using a 2000-point transform. This results in a scale factor of 2 MHz/Div. The display is truncated at 6.25 divisions to retain the original 12.5 MHz span.

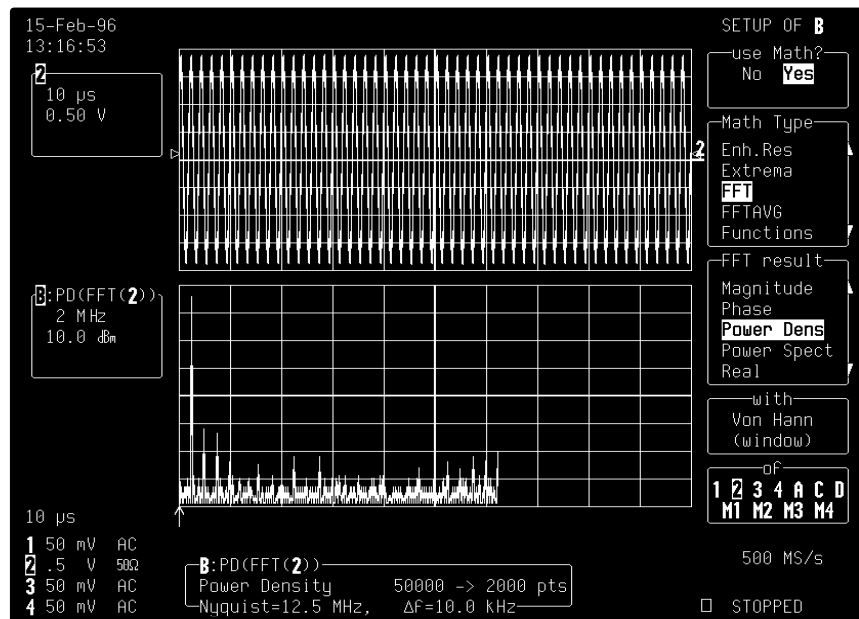

Setting Up the Display

DISPLAY SETUP

Press  to view the DISPLAY SETUP menus (see page 11–6) and select from:

- **Standard or XY Mode**
- **Single, Dual or Quad grids**
- **Persistence**
- **Dot Join**
- **Display and grid intensities**
- **“More Display Setup” menu.**

Standard or XY Display?

Standard Display Mode (*menus page 11–6*) allows presentation of source waveforms versus time (or versus frequency for FFTs).

XY Display Mode (*menus page 11–9*) compares and contrasts one source waveform with another, and is used when selected traces have the same time or frequency span (time/div) and horizontal unit (in seconds or Hertz). XY is automatically generated as soon as two compatible traces are selected. If incompatible traces are selected, a warning message is displayed at the top of the screen. And if compatible traces are not matched in time, their XY diagram will be displayed showing the shifting in time or in frequency between them. (The ΔT or Δf indicator is displayed in the Displayed Trace Label at left-of-screen.)

Persistence

In Persistence Mode, the oscilloscope can display points so that they accumulate on-screen over many acquisitions. Persistence can be used in either Standard or XY display. Eye diagrams and constellation displays can be made using persistence, and the most recent sweep can be displayed as a “vector” trace over the Persistence display. Persistence is activated by selection of the “DISPLAY SETUP” “Persistence” menu (11–6).

See: “Picturing Signal History”, in the Hands-On Guide, for more details on using Persistence.



Which Grid?

All four possible traces can be shown at the same time on separate grids. When Parameters are used, the parameter-style grid comes into play automatically. Other grid styles, illustrated on the following pages, offer the choice of a variety of ways to view one or more traces in either Standard or XY Mode.

Standard and XY Display Grids

Single

DISPLAY SETUP

Standard
XY

Grids
Single Dual
Quad



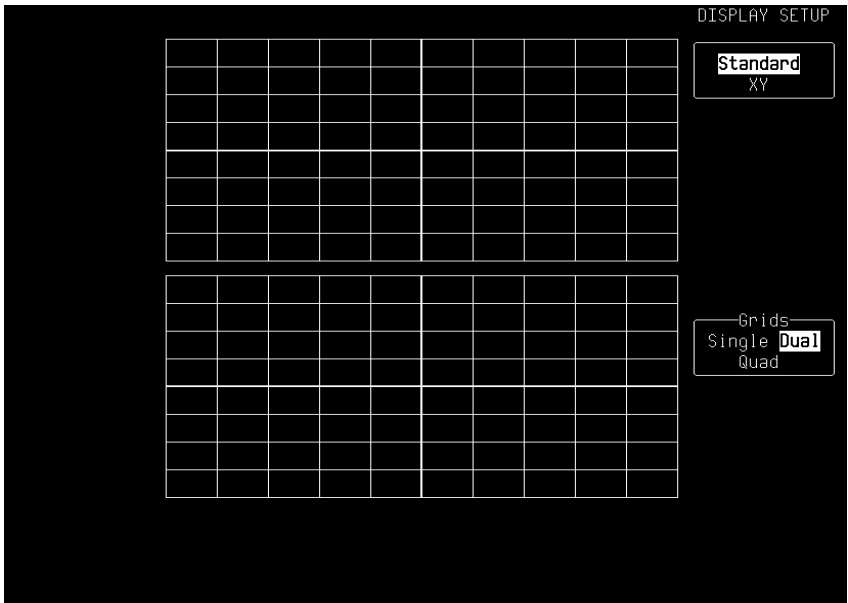
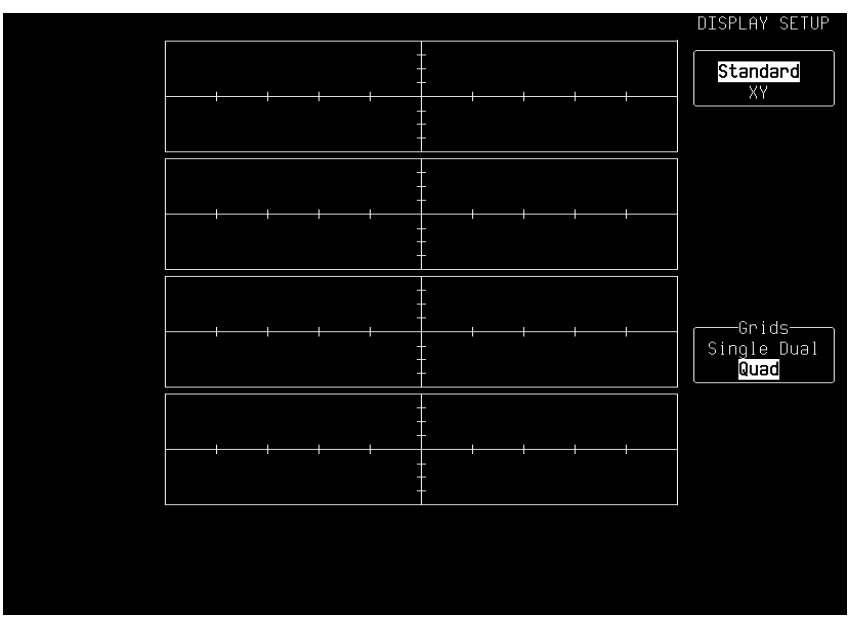

Dual	 <p>DISPLAY SETUP</p> <p>Standard XY</p> <p>Grids Single Dual Quad</p>
Quad	 <p>DISPLAY SETUP</p> <p>Standard XY</p> <p>Grids Single Dual Quad</p>

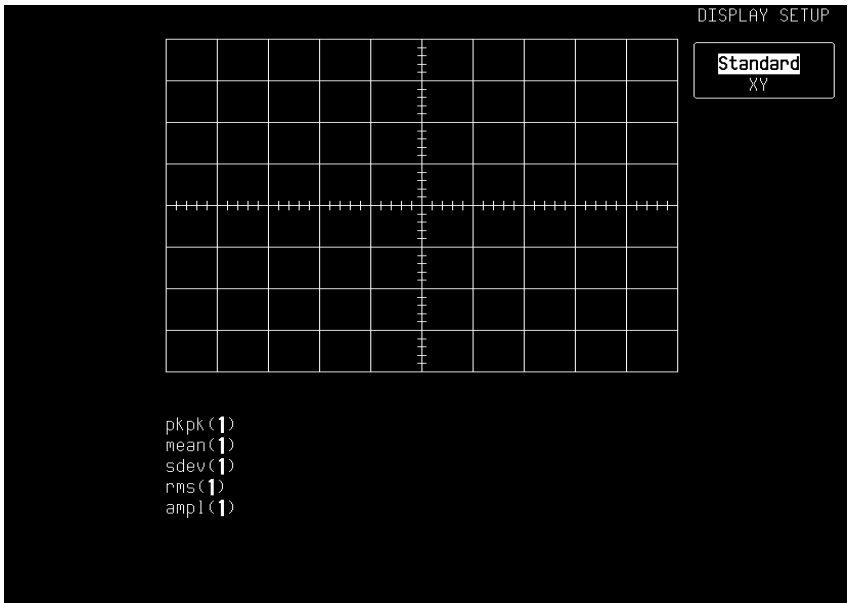
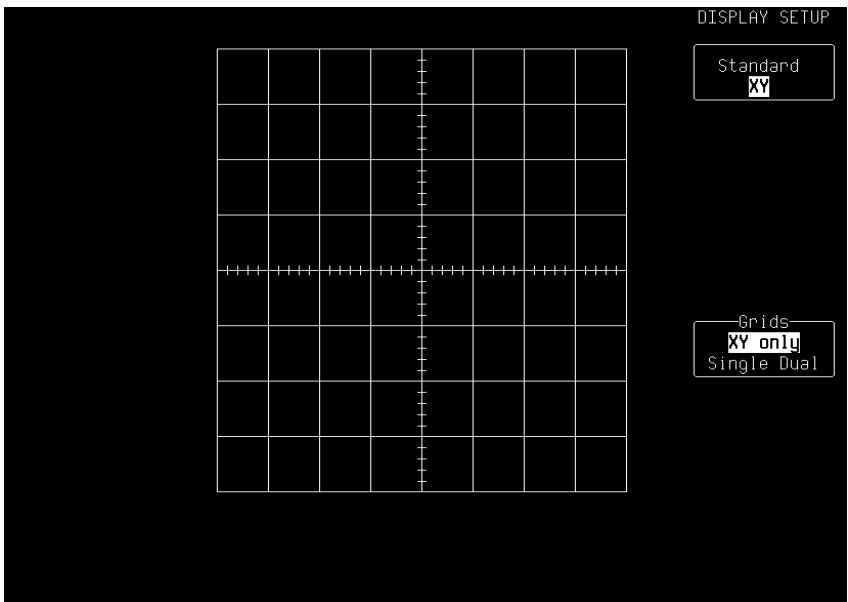

<p>Parameter</p> <p>S</p>	 <p>pkpk(1) mean(1) sdev(1) rms(1) ampl(1)</p> <p>DISPLAY SETUP Standard XY</p>
<p>XY only</p>	 <p>DISPLAY SETUP Standard XY</p> <p>Grids XY only Single Dual</p>

<p>XY Single</p>	
<p>XY Dual</p>	

DISPLAY SETUP – Standard

DISPLAY SETUP

Standard
XY

Persistence
OFF On

Dot Join
OFF On

Grids
Single Dual
Quad

W'Form+Text
intensity
90 %

Grid
intensity
60 %

With “Standard” selected, these menus appear:

Persistence

For activating Persistence (*see next menu*).

Dot Join

To select Dot Join “ON” — connecting the sample points with a line segment — or “OFF”, when only the sample points are displayed.

Grids

For selecting the number of grids.

**W'form + Text
intensity**

Adjusts the screen intensity for the waveform and associated text, using the attributed menu knob.

Grid intensity

Adjusts the screen intensity of the grid, using the attributed menu knob.

Note: If “W'form + Text intensity” is turned down to 0 %, the waveform and text disappear! Press the DISPLAY button to return automatically to 90 % intensity.

DISPLAY SETUP – Standard – Persistence “On”

DISPLAY SETUP

Standard
XY

Persistence
OFF On
(InFinite)

Dot Join
OFF On

Persistence
Setup

Grids
Single Dual
Quad

W'form+Text
intensity
90 %

Grid
intensity
60 %

With both “**Standard**” and “Persistence” “**On**” selected, these menus appear:

Persistence

Activates Persistence. When “**On**”, this can be cleared and reset by pressing the CLEAR SWEEPS button or by changing any acquisition condition or waveform processing condition.

Dot Join

To select Dot Join “**ON**” — connecting the sample points with a line segment — or “**OFF**”, when only the sample points are displayed.

Persistence Setup

To access the “**PERSISTENCE**” Setup menus (*see next page*)

Grids

For selecting the number of grids.

W'form + Text intensity

Adjusts the screen intensity for the waveform and associated text, using the attributed menu knob.

Grid intensity

Adjusts the screen intensity of the grid, using the attributed menu knob.

Note: If “W'form + Text intensity” is turned down to 0 %, the waveform and text disappear! Press the DISPLAY button to return automatically to 90 % intensity.

PERSISTENCE

These menus appear when “Persistence Setup” is selected from “DISPLAY SETUP”.

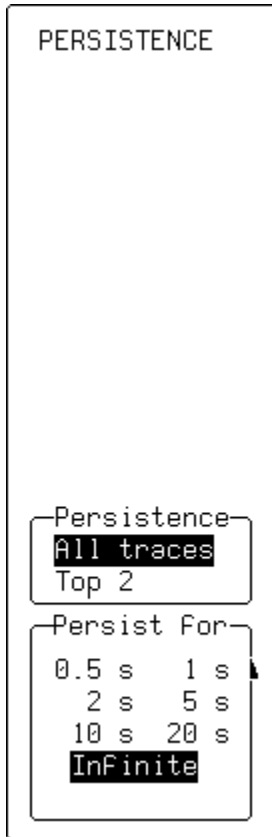

Persistence

To select whether persistence is applied to all or to the top two traces.

Persist for

For selecting the persistence duration, in seconds.

The number of sweeps accumulated — up to 1 million — is displayed below the grid.

DISPLAY SETUP – XY

When “XY” is selected from the first menu, these other menus appear.

The image shows a vertical menu titled "DISPLAY SETUP". It contains several sub-menus, each in a rectangular box. The first sub-menu is "Standard" with "XY" selected. The second is "Persistence" with "On" selected. The third is "Dot Join" with "On" selected. The fourth is "Grids" with "XY only" selected. The fifth is "W' Form + Text intensity" with "90 %" selected. The sixth is "Grid intensity" with "60 %" selected.

Persistence

Activates Persistence. When “On”, the other menus here do *not* change.

Dot Join

To select Dot Join “ON” — connecting the sample points with a line segment — or “OFF”, when only the sample points are displayed.

Grids

For selecting the grid style.

W'form + Text intensity

Adjusts the screen intensity for the waveform and associated text, using the attributed menu knob.

Grid intensity

Adjusts the screen intensity of the grid, using the attributed menu knob.

Printing, Storing, Using Special Modes

UTILITIES

Press  to access the primary menus for:

- **Hardcopy settings**
- **Time and date settings for the real-time clock**
- **GPIB and RS-232-C settings**
- **Mass storage utilities (including copy and format and delete files)**
- **Special modes of operation (including offset behavior, sequence time-out, cursor units, and auto-calibration)**
- **Signal function at the CAL BNC connector (magnitude, frequency, shape, trigger out, pass/fail use)**

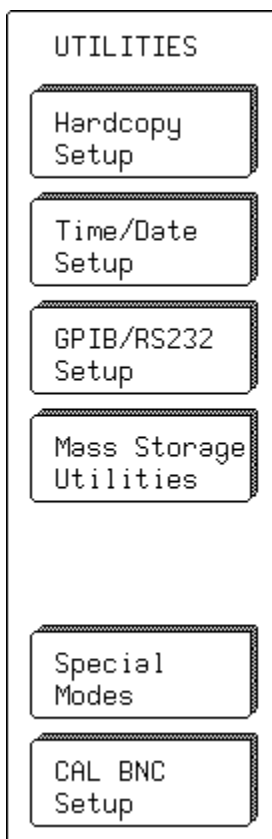

Hardcopy Setup (see page 12–2)

To access secondary menu for viewing, changing printer settings.

Time/Date Setup (page 12–4)

To access secondary menu for adjusting the real-time clock displayed in the upper left-hand corner of the screen.

GPIB/RS232 Setup (page 12–5)

To access secondary menu for viewing, changing interface settings.

Mass Storage Utilities (page 12–11)

For accessing the “Mass Storage UTILITIES” menus.

Special Modes (page 12–20)

For accessing the “Special Modes” menus.

CAL BNC Setup (page 12–23)

For accessing the “CAL BNC” menus.

Hardcopy Setup

HARDCOPY

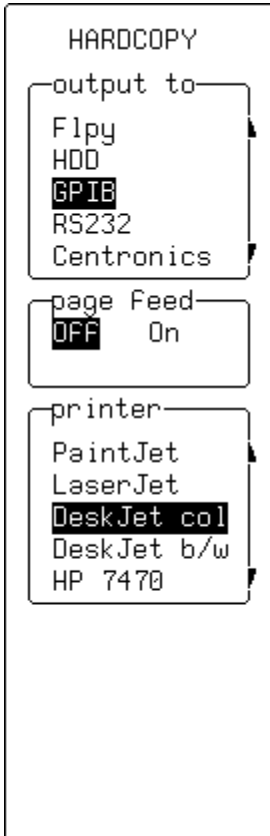

When “Hardcopy Setup” is selected from “UTILITIES” these menus appear:

output to

To select the device to which the instrument is to output. This menu shows the options installed in the instrument. The device can be either a port — GPIB, RS232 or Centronics — to which a printer is connected, a storage unit such as Floppy or portable hard disk (HDD), or the internal printer. If a port, the “GPIB & RS232” menu should be checked to ensure settings are correct. File names are assigned automatically when copying to storage units.

page feed

For starting (when “On” is selected) a new page each time SCREEN DUMP is pressed.

Press  to make a copy of the screen display.

printer

To select the type of printer, or graphics file format (“TIFF”, “BMP”) protocols, using the corresponding menu buttons or knob.

HARDCOPY – Internal Printer (*OPTION*)

```
HARDCOPY
output to
  Int. Printer
  Card
  Flpy
  HDD
  GPIB
auto print
  OFF On
cm/division
  1 2
  5 10
  20 50
  100 200
```

output to

To select the device to which the instrument is to output: in this case, the optional “**Int. Printer**”. This menu shows the options installed in the instrument. The device can be either a port — GPIB, RS232 or Centronics — to which a printer is connected, a storage unit such as Floppy or portable hard disk (HDD), or the internal printer. If a port, the “GPIB & RS232” menu should be checked to ensure settings are correct. File names are assigned automatically when copying to storage units.

auto print

For generating (“**On**”) a hard copy of the screen and send to the internal printer after every acquisition.

cm/division

For selecting the expansion factor.

Note: A “*persistence*” trace cannot be expanded, nor do cursors show on an expanded printout.



Time/Date Setup

TIME/DATE

TIME/DATE

SET CLOCK FORWARD ONE HOUR (SPRING)

SET CLOCK BACKWARD ONE HOUR (FALL)

LOAD CHANGES NOW

Hour Min Sec
10:14:33

Day Mnth Year
20 OCT 1997

When “Time Date Setup” is selected from “UTILITIES” these menus appear:

SET CLOCK FORWARD ONE HOUR

For changing to summer time.

SET CLOCK BACKWARD ONE HOUR

For changing back to standard time.

LOAD CHANGES NOW

To activate the changes made with the “Hour Min Sec” and “Day Mnth Year” buttons and knobs (*see below*).

Hour/Min/Sec

Using the corresponding menu button, for toggling between “**H**our”, “**M**in”utes, and “**S**ec”onds, and the associated menu knob to adjust the value.

Day/Mnth/Year

Using the corresponding menu button, for toggling between “**D**ay”, “**M**nth”, and “**Y**ear”, and the associated menu knob to adjust the corresponding value.

GPIB/RS232 Setup

When “GPIB/RS232 Setup” is selected from “UTILITIES” the RS-232-C port on the rear panel can be used for remote operation of the oscilloscope, and for direct interfacing to a hard-copy device for copying of displayed waveforms and other screen data. *See below and on next page for printer and computer cabling.*

A printer unit whose connected to the scope by RS-232-C port can be controlled from a host computer using the scope's GPIB port. The oscilloscope's built-in drivers also allow hard copies to be made without an external computer..

RS-232-C Connector Pin Assignments		
DB9 Pin No.	Line Name	Description
3	T × D	Transmitted Data (from the oscilloscope).
2	R × D	Received Data (to the oscilloscope).
7	RTS	Request To Send (from the oscilloscope). If the software Xon/Xoff handshake is selected, it is always TRUE. Otherwise (hardware handshake) it is TRUE when the oscilloscope is able to receive characters and FALSE when the oscilloscope is unable to receive characters.
8	CTS	Clear To Send (to the oscilloscope). When TRUE, the oscilloscope can transmit; when FALSE, transmission stops. It is used for the oscilloscope output hardware handshake.
4	DTR	Data Terminal Ready (from the oscilloscope). Always TRUE.
5	SIG GND	Signal Ground
Corresponds to a DTE (Data Terminal Equipment) Configuration		

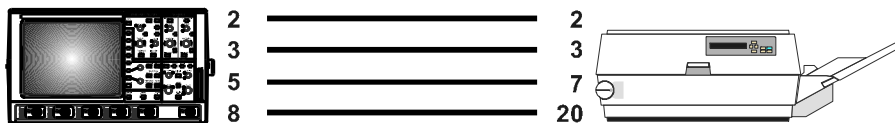

*RS-232 Cabling for Printers
(can be used in almost every case)*

GPIB & RS232

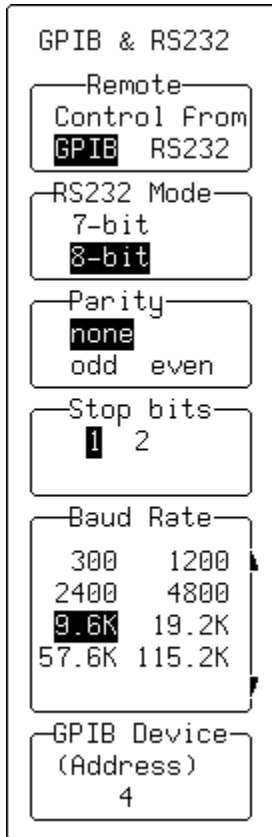

When “GPIB/RS232 Setup” is selected from “UTILITIES” these menus appear:

Remote Control from

For selecting the port for remote control.

RS232 Mode

To select “7-bit” or “8-bit” mode for RS-232 communication. When “RS-232” is selected, the GPIB interface is in “Talk Only” mode. Any change becomes effective immediately.

Parity

To select the “odd” or “even” parity, or “none”, for RS-232 communication.

Stop bits

For selecting the number of stop bits for RS-232 communication.

Baud Rate

To set the Baud Rate for RS-232 communication using the attributed menu knob.

GPIB Device (Address)

To choose the appropriate GPIB address.

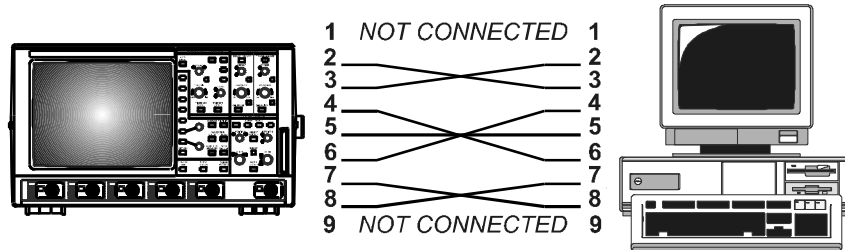

RS-232 nine-pin communication cabling for PC

Mass Storage Utilities

When “Mass Storage Utilities” is selected from “UTILITIES” the “MASS STORAGE” menu group appears (12–11) to give access to the mass-storage file system controls. The system supports storage and retrieval of data files to and from memory cards, floppy disks and removable hard disk (HDD) media.

Memory Card Format

The Memory Card structure, based on the PCMCIA II / JEIDA 4.0 standard, and as found in any DOS floppy or hard disk, consists of a DOS partition containing files. The oscilloscope formats the card in segmented contiguous sectors, each of 512 bytes. The scope does *not* support error-detection algorithms such as CRCs or checksum inserted between the sectors, and when this is done the instrument may only be able to read, but not write, the card.

Floppy Disk Format

The floppy supports DOS 1.44 MB and 720 kB formats.

Hard Disk (HDD) Format

The removable hard disk structure is based on the PCMCIA III / JEIDA 4.0 standard. The media is arranged as a DOS partition containing files as in any DOS floppy or hard disk.

The HDD format uses 512 bytes per sector and four sectors per cluster. One cluster is the minimum file size: any files smaller than 2048 bytes in size will still use one cluster’s allocation of 2048 bytes of disk space.

Subdirectories

All files are written to and read from the media from the current working directory. The default name of the working directory is LECROY_1.DIR. This directory is automatically created when the media is formatted. If the media is formatted elsewhere — for instance on a PC — the directory will be created the first time a file is stored to the memory card, floppy disk or removable hard disk.

The working directory can be changed to any valid DOS directory name, using the file-name preferences menu. All working directories are created as sub-directories from the root directory.

The maximum number of files allowed in any one directory is 2400.



File-naming Conventions As in MS-DOS, the file name can take up to eight characters followed by an extension of three characters.

A file is treated as:

- Panel setup if its extension is PNL
- Waveform if its extension is a three-digit number
- Waveform template if its extension is TPL
- Hardcopy if its extension is TIF, BMP, or PRT.

The instrument has a pre-defined naming convention for the eight-character file names and directory names, and these default names can be customized, as shown in this table.

If the new file being stored bears the same name as an existing file on the same storage medium, the old file will be deleted.

Type	Default Name	Customized Name	
Manually stored waveform files	Stt.nnn	xxxxxxxx.nnn	
Automatically stored waveform files	Att.nnn	xxxxxxxx.nnn	
Panel files	Pnnn.PNL	xxxxnnn.PNL	
Hard copy files	Dnnn.TIF Dnnn.BMP Dnnn.PRT	xxxxnnn.TIF xxxxnnn.BMP xxxxnnn.PRT	
Template files	LECROYw.TPL	Cannot be changed	
Directory name	LECROY_1.DIR	xxxxxxxx	
Spreadsheet	Sttnnn.TXT	xxxxnnn.TXT	
Matlab	Sttnnn.DAT	xxxxnnn.DAT	
Mathcad	Sttnnn.PRN	xxxxnnn.PRN	
KEY			
x	any legal DOS file-name character	w	the template version number: for example, for a version 2.2, the template is saved as LECROY22.TPL
tt	the trace name of C1, C2, C3, C4, TA, TB, TC, TD	TIF BMP	hardcopy graphics image files
nnn	a 3-digit decimal sequence number starting at 001 that is automatically assigned	PRT	hardcopy printer files.

Auto-Store Waveform File Naming

The default notation for waveform files is Stt.nnn for manually stored files and Att.nnn for automatically stored files, the characters S and A representing the two storage methods, respectively.

When automatically generating a file name, the system uses the assigned name plus a three-digit sequence number. If the assigned waveform name is already in the default 'Stt' form — such as SC1, STB — the name will be modified to the 'Att' form: AC1, ATB and so on. All other user-assigned names remain as entered.

More on Auto-Stored Files

If **"Fill"** is selected and default names are used, the first waveform stored will be Axx.001, the second Axx.002, and so on, continuing until the storage medium is filled, the file number reaches 999, or there are more than 2400 files in the current working directory.

If **"Wrap"** is selected, the oldest auto-stored waveform files will be deleted whenever the medium becomes full. And the remaining auto-stored waveform files will be renamed — the oldest group of files will be named "Axx.001", the second oldest "Axx.002" and so on.

The current sequence number is deduced from inspection of all file names in the working directory, regardless of file type — panel, hard copy or waveform. The highest occupied numeric file-name extension of the form 'nnn' is determined, and the next highest number is used as the current generation number for storage operations.

Deleting Files

When a file generation is deleted, all files designated with the three-digit sequence number of the file-name extension will be deleted, regardless of file type.

Media Size/Storage Availability

The mass-storage file system indicates media size and storage availability in kbytes where 1 kbyte = 1024 bytes. Many media manufacturers specify the available storage in Mbytes where 1 Mbyte = 1 million bytes. This results in an apparent mismatch in specified versus actual media storage availability, when in fact the availability in bytes is identical.

Write Protect Switch

If the write-protection switch of the card or floppy being used has been pushed to the active position, the message "Device is Write



UTILITIES

Protected” will be displayed on the upper part of the grid whenever the medium is accessed for writing.



SRAM Card Battery

The SRAM memory card contains a button-size battery for preserving data. When this needs replacing, the message “BAD BATTERY” appears. The battery can and should be changed while the memory card is still in the oscilloscope, in order to prevent loss of information. To access the battery, remove the panel on the bottom edge of the card by removing the small screw.

MASS STORAGE

— offers the primary menus for controlling mass storage. The range of “UTILITIES” available depends on the options installed — all shown here:

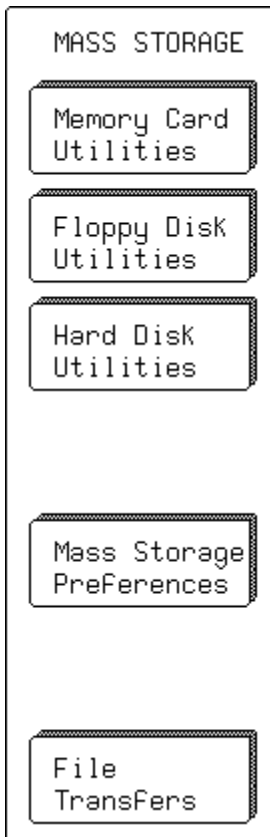

Memory Card Utilities (*OPTION*)

To delete files, format, or copy a machine template onto memory card. (The Utilities menus accessed by selection of this menu for the optional Memory Card are similar to those accessed for Floppy Disk *shown on the following pages.*)

Floppy Disk Utilities

To delete files, format, or copy a machine template onto floppy disk. *The examples on the following pages illustrate this selection.*

Hard Disk Utilities (*OPTION*)

To delete files, format, or copy a machine template onto hard disk. *See page 12–15*

Mass Storage Preferences

To set, add or delete it a working directory, or for customizing file names. *See page 12–16.*

File Transfers (*If more than one mass-storage device available*)

For copying files from one storage device to another. *See page 12–19.*

FLPY UTIL

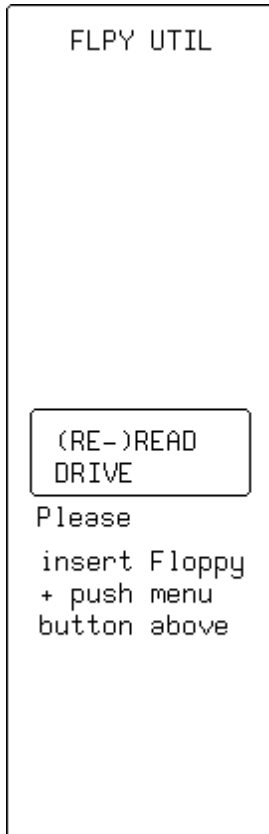

These menus appear when “Floppy Disk UTILITIES” is selected from “MASS STORAGE” and

- a floppy has been newly inserted, or
- there is no floppy in the drive.

(RE-)READ DRIVE

To read the floppy and display directory contents.

FLPY UTIL

```
FLPY UTIL
-----
TEMPLATE AND
FORMATTING
LECROY_1.DIR
12-Jun-96
  7 Files
Size 1440K
Free 1164K

DO DELETE
G703ONE.004

File
G703ONE 004
G703ZERO 004
ONE      PNL
ZERO     PNL
SC2      007

10-Oct-96
09:52:02
Size 409
```

Once the floppy has been read, these menus appear, displaying information on the installed storage media:

- Last “format” date and time
- Media size and available free space
- Date, time and size information of the selected file on the media.

TEMPLATE AND FORMATTING

To access a secondary menu for formatting storage media or copying to it the machine template. The template is an ASCII text-file containing all information required for decoding the descriptor part of a binary waveform.

DO DELETE

To delete the file selected in the “File” menu (*below*).

File

For selecting the file to be deleted with the attributed menu knob or buttons.

FORMAT FLPY

```

FORMAT FLPY
!FORMATTING
ERASES ALL
INFO ON FLPY

PERFORM
FLPY FORMAT

Density
1.44 MB (HD)
720 KB (DD)

COPY TEMPLATE
TO FLPY

```

These menus appear when “TEMPLATE AND FORMATTING” is selected from “FLOPPY UTIL”.

PERFORM FLPY FORMAT

To format the floppy, in DOS format with an interleave factor of two, which optimizes throughput to and from the scope.

Density

This menu appears only in “FORMAT FLOPPY”. For selecting density — “1.44 MB (HD)” or “720 kB (DD)”.

COPY TEMPLATE TO

For copying the machine template — an ASCII text-file containing all the information required to decode the descriptor part of a binary waveform — to the medium.

FORMAT HDD

These menus appear when “MASS STORAGE” “Hard Disk UTILITIES” “TEMPLATE AND FORMATTING” is selected.

```
FORMAT HDD
!FORMATTING
ERASES ALL
INFO ON HDD

QUICK FORMAT
(~15 sec)

FULL FORMAT
(~10 min)

COPY TEMPLATE
TO HDD
```

QUICK FORMAT

To quickly (15 seconds) clear the portable hard disk drive.

FULL FORMAT

For a complete formatting of the HDD — recommended if the disk is non-readable.

COPY TEMPLATE TO

For copying the machine template — an ASCII text-file containing all the information required to decode the descriptor part of a binary waveform — to the medium.

PREFERENCES



These menus appear when "MASS STORAGE" "Mass Storage Preferences" is selected and are for:

- Selecting the working directory
- Deleting a directory
- Accessing the "File Name Preferences" menu
- Accessing the "Add New Directory" menu.

on drive

For selecting the medium.

File Name Preferences

To access the secondary menu for defining custom names for waveform, setup, or hardcopy files (*see next page*).

DELETE THIS DIRECTORY

To delete the directory selected in "**work with**" menu (*see below*).

work with

For selecting the directory to be used for file storage and retrieval.

Add new Directory

To access secondary menu for adding a new directory.

FILENAME PREF

FILENAME PREF
SC1.xxx
to be set to:
TEA.xxx

RESTORE
DEFAULT NAME

ENTER NEW
FILE NAME

BACKSPACE

INSERT

character

56789-ABCDEFGHI

File Type

Channel 1
Channel 2

This menu group appears when “File Name Preferences” is selected from the preceding menu — for defining custom names for waveform, setup, or hardcopy files.

to be set to:

To select the character for modification.

RESTORE DEFAULT NAME

For restoring the file type selected in the “File Type” menu (see *below*) to its default name.

ENTER NEW FILE NAME

To validate the newly defined name.

BACKSPACE

For moving back one space and erasing the previous character.

INSERT

To move forward to create a space for insertion of a character.

character

For selecting a character using the menu knob.

File Type

To select the file type for customizing.



NEW DIRECTORY

— used to define a new directory with a custom name.

NEW DIRECTORY
 New Directory
 on Card:
 DAC

MAKE THIS
 DIRECTORY

BACKSPACE

INSERT

character

789-AB CDEFGHI

New Directory on Card:

For selecting the character to be modified.

MAKE THIS DIRECTORY

For validating the new directory.

BACKSPACE

To move back one space and erase the previous character.

INSERT

For moving forward to create a space for the insertion of a character.

character

For selecting a character using the menu knob.



COPY FILES

```
COPY FILES
Direction
Card -> Flpy
Flpy -> Card
Card -> HDD
HDD -> Card
Flpy -> HDD
Which Files
Panels
Prints
WaveForms
All Files
DO COPY
!OVERWRITES
FILES WITH
SAME NAME
```

These menus appear when "MASS STORAGE" "File Transfers" is selected, and copies files from one medium to another.

Direction (*DEPENDING ON OPTIONS INSTALLED*)

To select source (copy from) and destination (copy to).

Which files

For selecting the type of file for copying.

DO COPY

To execute the copying.

Special Modes

SPECIAL MODES

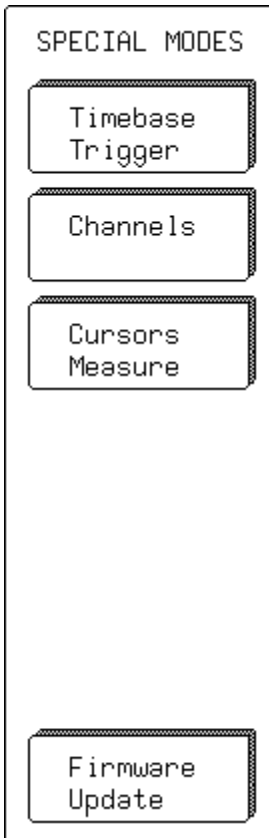

When “Special Modes” is selected from “UTILITIES”, the primary and secondary menus described here become available.

Timebase Trigger

Accesses the secondary menu:

- **AUTO sequence**
For specifying the time-out in Sequence mode using the associated menu knob to change the value.

Channels

Accesses the secondary menus:

On GAIN Changes, all OFFSETS fixed

- **In**
For specifying the offset behavior of a gain (VOLTS/DIV) change. The offset can be fixed either in “Volts” or vertical “Divisions”.
- **Automatic Recalibration**
For turning the automatic recalibration “ON” or “OFF”. Default is ON. Turning this off may speed up the acquisition, but during that time calibration is not guaranteed.

Cursors Measure

Accesses the secondary menu:

- **Read time cursor amplitudes**
For selecting from “In” the time cursor amplitude units in “Volts” or “dBm”.

Firmware Update

Accesses the secondary menu:



➤ **FLASH UPDATE**

Offering the “Update from” and “Update Program” menus
(*illustrated next page*).



The full screen warning message shown when “FLASH UPDATE” has been selected.

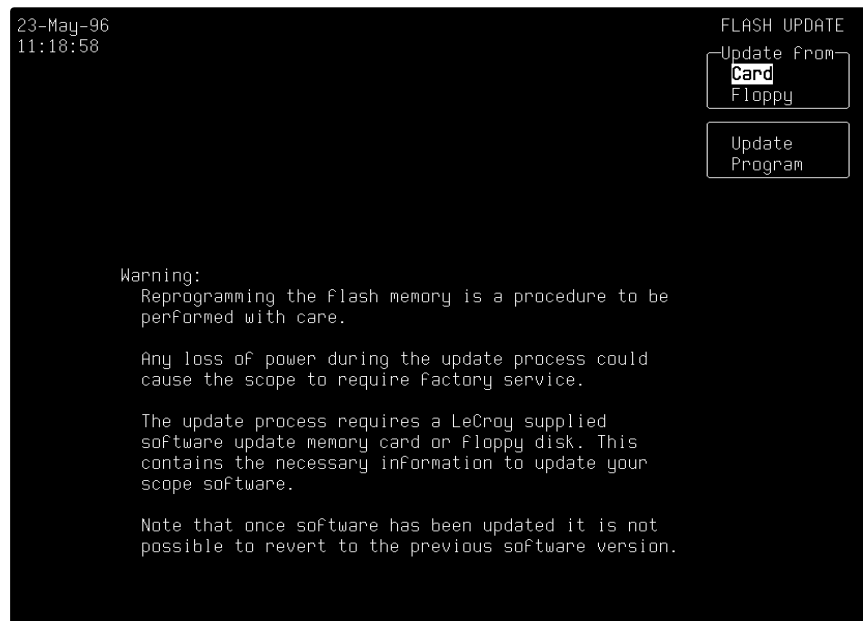

CAL BNC Setup

CAL BNC OUT

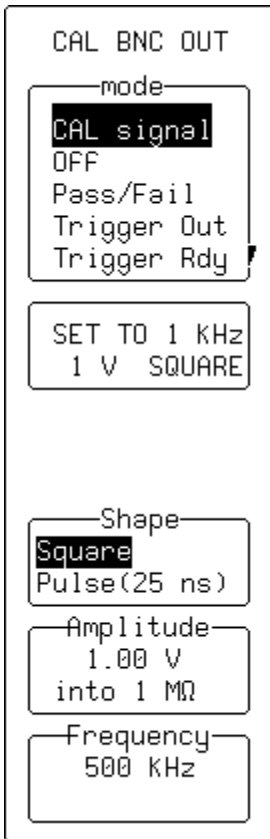

When “CAL BNC Setup” is selected from “UTILITIES”, selection can be made of the type of signal put out at the CAL BNC connector. The frequency, amplitude and pulse shape of the calibration signal can also be chosen.

In addition, the CAL BNC connector can be used to provide a pulse:

- as an action for PASS/FAIL testing
- at the occurrence of each accepted trigger event (Trigger Out)
- when the scope is ready to accept a trigger event (Trigger Rdy).

When the instrument is switched on, the calibration signal is automatically set to its default state, 1 kHz 1 V square wave.

mode

To change the kind of signal.

SET TO

To quickly reset the CAL BNC output to its default state.

Shape

To change the form of the calibration signal.

Amplitude

Using the associated knob, for setting the desired high level for all CAL BNC applications. If the BNC output is connected to an input channel with 50 Ω, the amplitude will be halved.

Frequency

Using the associated knob, for setting the desired frequency of a CAL signal in the range 500 Hz–2 MHz.

Waveform Store

STORE W'FORMS

```

STORE W'FORMS
Data Format
Binary ASCII

Auto-Store
OFF
Wrap Fill

DO STORE
(1->Card)

store
1 2
3 4
A B
C D
All displayed

to
M1 M2 M3 M4
Card Flpy HDD
  
```

Press WAVEFORM  to store waveforms to internal memory (M1, M2, M3, or M4) in LeCroy's binary format. And to store waveforms in either binary or ASCII format to floppy disk, or memory card or removable hard disk (HDD) with those options installed.

When "Binary" and either "Flpy" or one of the optional media is selected, the menus shown on this page will appear. But when an internal memory (M1–M4) is selected, neither the "Data Format", nor "Auto-Store" menus shown here will appear. And when the "DO STORE" menu button is pressed, the waveform will be stored automatically to the selected memory in binary format.

When "ASCII" is selected, *as shown on the next page*, the scope will store the waveform in an ASCII format. But this will create an output file requiring 10–20 times the disk space of the original LeCroy binary file. A one-megabyte record will typically take up 13–15 MB stored in ASCII. Furthermore, waveforms stored in ASCII cannot then be recalled back into the scope.

Note:

- *The capacity of the Reference and "Zoom & Math" memories each match those of the acquisition memories. For every unit of record length per channel, a point can be stored in any one of the four M reference memories, and the same number of points for each "Zoom & Math" trace.*
- *When more acquisition memory is acquired by combining channels, a single long trace can consume all the instrument's Reference memory or "Zoom & Math" trace capacity. If this happens, a warning message will show on-screen to prevent the accidental storage of a new trace to a reference memory already in use.*



WAVEFORM STORE & RECALL





Data Format

For choosing the data format, *as described on the previous page*. When "**ASCII**" has been selected, the primary "Setup ASCII Format" menu will appear immediately beneath this menu, giving access to the secondary "ASCII SETUP" menu (*see next page*). When "Binary"

Setup ASCII Format

Appears only when "**ASCII**" is highlighted in "Data Format", as shown here. For accessing the secondary "ASCII SETUP" menu (*see next page*).

Auto Store

For automatically storing waveforms after each acquisition. "**Fill**" stores until the medium is filled, while "**Wrap**" stores continuously, discarding — first-in—first-out — the oldest files.

DO STORE

To store in accordance with specifications made in the "store" and "to" menus (*see below*).

store

For selecting the waveform. "**All displayed**" can only be selected when storing to optional storage media .

to

To select the internal memories "**M1**", "**M2**", "**M3**", or "**M4**", when "Binary" is selected in the "Data Format" menu, *as shown on the previous page*., Or the optional "**Card**", "**Flpy**" or "**HDD**", when "**ASCII**" is selected from the "Data Format" menu, *as shown here*.

ASCII SETUP

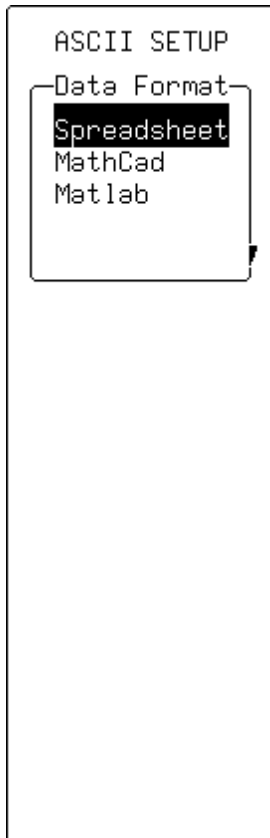

Data Format

This secondary menu, accessed through "SETUP ASCII FORMAT" offers a choice of ASCII formats. (*For details on each format, see Appendix E.*)

Waveform Recall

RECALL W'FORM

Press WAVEFORM  to recall a waveform from internal memory, floppy, or the optional memory card or removable hard disk (HDD).

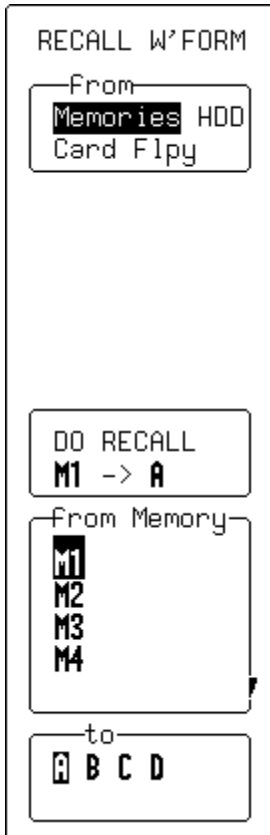

RECALL W'FORM

From

Memories HDD
Card Flpy

DO RECALL
M1 -> A

From Memory

M1
M2
M3
M4

to

A B C D

from

To select the storage medium from which to recall — in this case, internal “Memories”.

DO RECALL

To execute recall based on the selections made in the “from Memory” and “to” menus (see *below*). At the same time resets the horizontal and vertical positions as well as the zooms, showing the full contents of the memory at its original magnification.

from Memory

For selecting the source memory.

to

To select the destination trace.

Note: Performing a recall operation from an internal memory to Trace A–D overrides any previous definition of the destination trace.



WAVEFORM STORE & RECALL

RECALL W'FORM

(FLOPPY DISK OR OPTIONAL STORAGE DEVICE)

```
RECALL W'FORM
From
Memories HDD
Card Flpy
Directory:
LECROY-1.DIR

10-Oct-96
09:52:02
Size 409

DO RECALL
G703ONE.004

File
G703ONE 004
G703ZERO 004
SC2 007
SC3 007
SC4 007

to
M1 M2 M3 M4
A11 M
```

from

Select the device or medium on which the file is stored — “HDD”, “Card”, or “Flpy”.

DO RECALL

To execute recall based on the selections made in the “File” and “to” menus (see below).

File

To select the file on which the waveform is stored, using the attributed menu knob.

Note: The files listed will be those in the current working directory.

to

For selecting the destination memory. If the “All M” is selected, up to four files with the same three-digit numeric extension as the current “File” selection will be recalled into memories M1–4.

Cursors: Tools for Measuring Signal Values

Cursors are basic, important tools for measuring signal values.



In Standard Display Mode, **Amplitude**, or **Voltage**, cursors — broken lines or bars running across the screen — are moved up and down the grid *pixel by pixel*.

Time cursors — arrows or cross-hair markers that move along the waveform (see *symbols*) — can be placed at a desired time to read the amplitude of a signal at that time, and moved to *every single point acquired*.

When a Time cursor is placed on a data point, a cross-bar appears at the tail of the arrow, and at top and bottom of the cross-hair marker.

In **Absolute** Mode a single cursor is controlled. Readings for amplitude (using Amplitude cursors) or time and amplitude (using Time cursors) can be displayed at the cursor location. Measured amplitudes are relative to ground; measured times to the trigger point.

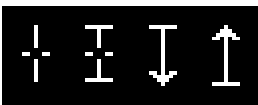

In **Relative** Mode, a pair of Amplitude or Time cursors is controlled, providing readings on the difference between the two in amplitude, or time and amplitude, respectively.

Amplitudes are shown in the Trace Label for each trace. When Time cursors are used, the time is shown below the grid. And in Relative Mode the frequency corresponding to the time interval between the cursors is also displayed there.

When there are few data points displayed, Time-cursor positions are linearly interpolated between the data points. Time cursors move up and down along these straight-line segments.

Cursors and Persistence When using Persistence, Amplitude cursors are the same as in Standard Display (see *above*). Time cursors are vertical bars running down the screen and moving across it.



CURSORS/MEASURE & Parameters

Cursors in XY Display

In XY Display, Absolute-Amplitude cursors are horizontal and vertical bars that can be moved both up and down and from side-to-side across the screen. Relative-Amplitude cursors are pairs of bars that move in the same way. Absolute- and Relative-Time cursors behave as they do in Standard Display.

Combinations of the amplitude values are shown on the left-hand side of the grid in the following top-to-bottom order:

1. "ΔY value / ΔX value"Ratio
2. "20 * log 10 (ratio)"Ratio in dB units
3. "ΔY value * ΔX value"Product
4. "f = arc tan (ΔY / ΔX)
range [-180° to +180°]"Angle (polar)
5. "r = sqrt (ΔX * ΔX + ΔY * ΔY)" ...Radius (distance to origin).

The definition of ΔX and ΔY depends on the cursor used. The table below shows how ΔX and ΔY are defined for each type of measurement.

Cursors					
	A _{Abs}	A _{Rel}	T _{Abs}		T _{Rel}
			Org = (0,0)	Org = V _{XOffset} V _{YOffset}	
DX	V _{XRef} - 0	V _{XDif} - V _{XRef}	V _{XRef} - 0	V _{XRef} - V _{XOffset}	V _{XDif} - V _{XRef}
DY	V _{YRef} - 0	V _{YDif} - V _{YRef}	V _{YRef} - 0	V _{YRef} - V _{YOffset}	V _{YDif} - V _{YRef}
<i>WHERE:</i>					
A _{Abs}	Absolute Amplitude cursors		V _{XRef}	Voltage of Reference cursor on X trace	
A _{Rel}	Relative Amplitude cursors		V _{YRef}	Voltage of Reference cursor on Y trace	
T _{Abs}	Absolute Time cursors		V _{XDif}	Voltage of Difference cursor on X trace	
T _{Rel}	Relative Time cursors		V _{YDif}	Voltage of Difference cursor on Y trace	
Org	Origin				

CURSORS/
MEASURE

MEASURE – Cursors

Press  — to access the “MEASURE” Setup menus.

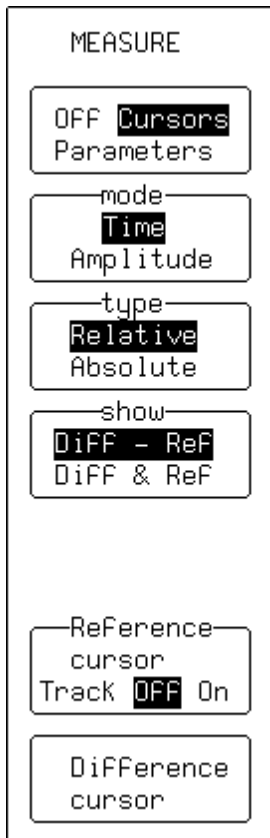

Off/Cursors/Parameters

To select “**Cursors**”.

mode

For selecting “**Time**” (time or frequency cursors) or “**Amplitude**” (voltage or amplitude cursors).

type

To toggle between “**Relative**” and “**Absolute**”. The first displays two cursors, Reference and Difference, and indicates either the voltage or time and voltage between the two. The second shows a single cursor that indicates either voltage compared to ground level, or this *and* time compared to the trigger point.

show

To select: “**Diff – Ref**”, which shows the subtraction between difference- and reference-cursor amplitudes; or “**Diff & Ref**”, which displays the amplitude values for each cursor. *Not available in persistence mode.*

Reference cursor

To control the Reference cursor available with Relative cursors, using the associated menu knob. With “Track” “**ON**”, both Reference and Difference cursors are controlled by this knob and move together, a constant time or voltage interval maintained between them. This tracking interval is represented by a bar — horizontal for time; vertical for voltage — appearing, respectively, at the top and left-hand edge of the grid.

Difference cursor

For controlling the Difference cursor, available when “**Relative**” is selected from “type” (*see above*), using the associated menu knob.

Cursor position (*not shown*)

For controlling the Absolute cursor, available when “**Absolute**” is selected from “type” (*see above*), using the associated menu knob.

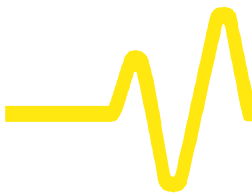

Parameters: Automatic Measurements

The instrument can determine certain signal properties automatically, using signal parameters. *The scope's standard parameters are listed and described in Appendix D of this manual.**

For common measurements on a lone signal, parameters can be measured in either of two standard classes or modes: in the amplitude or time domain.

On different signals, they can be customized and used to determine up to five of the quantities on the parameter list. Customized parameter measurements can also be used for Pass/Fail testing against chosen limits (*see page 14–13*).









Statistics on the parameter values are accumulated and can be displayed for all modes.

In addition to the overall number of sweeps used, each parameter has its average, lowest and highest value. The standard deviation of the parameter is also calculated.

Parameter Symbols

The algorithms that determine pulse waveform parameters are able to detect those situations where the mathematical formulas may be applied. However, the results obtained should be interpreted with caution. In such cases, the scope displays the name of the parameter and its value are separated on the screen by a graphic symbol, which acts either as information on the parameter or as a warning. The following table explains these symbols.

* A wide range of additional parameters are available in the specialized software packages, such as WP03, described in those packages' operator's manuals

Information	
	The parameter has been determined for several periods (up to 100), and the average of those values has been taken.
	The parameter has been determined over an integral number of periods.
	The parameter has been calculated on a histogram.
	Insufficient data to determine the parameter.
Warnings	
	Amplitude histogram is flat within statistical fluctuations; minimum and maximum are used to assign top and base.
	Only an upper limit could be estimated (the actual value of the parameter may be smaller than the displayed value).
	The signal is partially in overflow.
	The signal is partially in underflow.
	The signal is partially in overflow and in underflow.



CURSORS/MEASURE & Parameters

MEASURE – Parameters – Standard Voltage

```
MEASURE
OFF Cursors
Parameters
mode
Std Voltage
Std Time
Custom
List by nT
Pass
statistics
OFF On
on trace
1 2
from
0.00 div
Track OFF On
to
10.00 div
10000 pts
```

This mode measures, for a single trace:

- Peak-to-Peak (amplitude between maximum and minimum sample values)
- Mean of all sample values (corrected for periodic signals)
- Standard Deviation
- Root Mean Square of all sample values (corrected for periodic signals)
- Amplitude of the signal.

Off/Cursors/Parameters

To select “Parameters”.

mode

To select “Standard Voltage” parameters.

statistics

For turning “On” display of the parameter’s average, lowest, highest, and standard deviation, as well as the number of sweeps included in the statistics — cleared each time the acquisition conditions change or when the CLEAR SWEEPS button is pressed. As long as “Parameters” is highlighted in the top menu, the accumulation of statistics continues, even if the statistics are not shown.

on trace

To select the trace for which the voltage parameters are measured. The choices available in this menu will depend on the traces displayed (a maximum of four traces can be displayed). Here, Traces 1 and 2 are displayed and “2” selected.

from

To determine the starting point, in screen divisions, for parameter measurements, using the associated menu knob. “Track” “On”, links control of both the starting and end points of the parameter measurement so that they can be moved together using the associated menu knob.

to

To determine the end point in screen divisions. Also indicates the total number of data points used for the measurements.

MEASURE – Parameters – Standard Time

This mode measures for a single trace:

- Period
- Width (at 50% amplitude)
- Rise time (10–90% of amplitude)
- Fall time (90–10% of amplitude)
- Delay (from trigger to first 50% amplitude point).

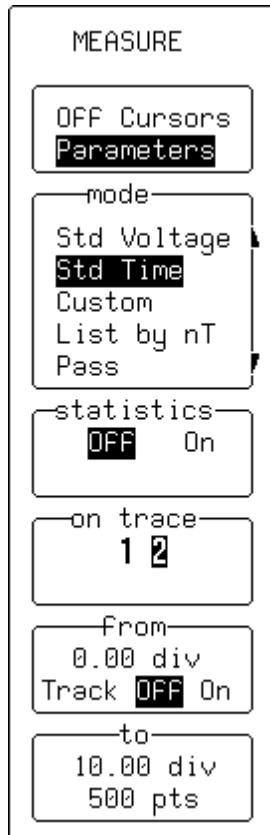

Off/Cursors/Parameters

To select "**Parameters**".

mode

For selecting "**Standard Time**" parameters.

statistics

For turning "**On**" display of the parameter's average, lowest, highest, and standard deviation, as well as the number of sweeps included in the statistics — cleared each time the acquisition conditions change or when the CLEAR SWEEPS button is pressed.

As long as "**Parameters**" is highlighted in the top menu, the accumulation of statistics continues, even if the statistics are not shown.

on trace

For selecting the trace for which the time parameters are to be measured. The choices available in this menu will depend on the traces displayed (a maximum of four traces can be displayed). Here, Traces 1 and 2 are displayed and "**2**" selected.

from

To determine the starting point, in screen divisions, for parameter measurements. "Track" "**On**", links control of both the starting and end points of the parameter measurement so that they can be moved together using the associated menu knob.

to

To determine the end point in screen divisions. Also indicates the total number of data points used for the measurements.

MEASURE – Parameters – Custom

In this mode, up to five parameters can be displayed for various traces.

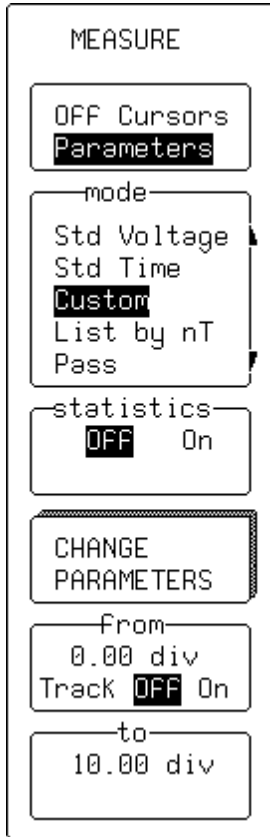

Off/Cursors/Parameters

For selecting “Parameters”.

mode

To select “Custom” parameters.

statistics

For turning “On” display of the parameter’s average, lowest, highest, and standard deviation, as well as the number of sweeps included in the statistics — cleared each time the acquisition conditions change or when the CLEAR SWEEPS button is pressed.

As long as “Parameters” is highlighted in the top menu, the accumulation of statistics continues, even if the statistics are not shown.

CHANGE PARAMETERS

For accessing the secondary “CHANGE PARAM” menu (see following pages).

from

To determine the starting point, in screen divisions, for parameter measurements. “Track” “On”, links control of both the starting and end points of the parameter measurement so that they can be moved together using the associated menu knob.

to

To determine the end point in screen divisions.

CHANGE PARAM

— for modifying parameters.

```
CHANGE PARAM
-----
On line
 1 2 3 4 5
-----
Category
All
DISK-Std
DISK-Local
DISK-PRML
OPTICAL-Data
-----
DELETE ALL
PARAMETERS
-----
measure
--
acsn
ampl
area
avg
-----
of
 1 2 3 4
  A B C D
-----
```

On line

To select for modification up to five different parameters, “1”, “2”, “3”, “4”, or “5”.

Category

To specify the category of parameter. When “All” is selected, the “measure” menu (see below) will feature all parameters. However, when a particular category is selected, only those parameters in the category are shown.

DELETE ALL PARAMETERS

For deleting all parameters previously selected.

measure

To choose the new parameter to be measured on this line. When “--” is selected the line is not used.

of

For selecting the channel or trace on which the parameter will be measured (*four-channel menu shown*).



CURSORS/MEASURE & Parameters

CHANGE PARAM

Parameters can be customized to meet specific needs:

```

CHANGE PARAM
  On line
  1 2 3 4 5
  Category
  All
  DISK-Std
  DISK-Local
  DISK-PRML
  OPTICAL-Data
  MORE Δt@lv
  SETUP
  measure
  Δp2c
  Δp2cs
  Δt@lv
  dur
  duty
  source
  From 1
  to 2

```

On line

To select for modification up to five different parameters, "1", "2", "3", "4", or "5".

Category

To specify the category or type of parameter.

MORE Dt@lv SETUP

Calls up the "Dt@lv" customization menu (*next page*).

measure

Set at Dt@lv.

source

Using the menu button, selects the channel — "1", "2" ("3" or "4") — or memory ("A", "B", "C", or "D"). While the knob selects "from" which and "to" which channel the measurement is to be made.

SETUP

“Dt@lv” — for customizing the $\Delta t@lv$ parameter.

```
SETUP Δt@lv

levels are
absolute
percent

hysteresis
0.5 1 2 5
divisions

from
-1.6mV
Pos Neg First

to
2.3mV
Pos Neg First
```

levels are

For selecting whether the levels should be set in absolute or percentage of the peak-to-peak signal value.

hysteresis

To set the hysteresis division. Hysteresis essentially enables the user to set a voltage band, which a waveform peak-trough pair must exceed in order not be considered either noise or a “bump”. This threshold crossing is recognized when an acquisition point in the waveform passes through the threshold level by 1/2 the hysteresis-division setting.

from

For selecting the voltage setting: the level on the trace at which the timing should start. And to select *where* the timing should start: “Pos” for rising edge, “Neg” for falling edge, “First” for either positive or negative edges.

to

For selecting the voltage setting: the level on the trace at which the timing should finish. And to select *where* the timing should finish: “Pos” for rising edge, “Neg” for falling edge, “First” for either positive or negative edges.



CURSORS/MEASURE & Parameters

SETUP

“Dc2d+” — for customizing the $\Delta c2d+$ parameter.

SETUP $\Delta c2d+$

hysteresis
0.5 **1** 2 5
divisions

clock edge
1.6mV
Pos Neg All

data edge
6.2mV
Pos Neg First

hysteresis

To set the hysteresis division. Hysteresis essentially enables the user to set a voltage band, which a waveform peak–trough pair must exceed in order not be considered either noise or a “bump”. This threshold crossing is recognized when an acquisition point in the waveform passes through the threshold level by 1/2 the hysteresis-division setting.

clock edge

To select the clock edge or edges used for this parameter measurement.

data edge

For selecting the data edge or edges used for the measurement.

Pass/Fail Testing

Parameters can also be used in carrying out Pass/Fail tests. These tests require a combination of measurements within chosen limits, using an action provoked when the test either passes or fails, depending on which has been specified. Signals can also be Pass/Fail tested against a tolerance mask.

Up to five parameters can be tested against limits at the same time. And, in tolerance mask testing, a trace can be compared to a tolerance mask.

Whether the tests pass or fail, any or all of the following actions can be provoked:

- Stop capturing further signals
- Dump the screen image to a hardcopy unit
- Store selected traces to internal memory, to a memory card (*optional*), or to a floppy
- Sound the buzzer
- Emit a pulse on the CAL BNC.

The Pass/Fail display will show:

- Results on the current waveforms
- Number of events passing
- Total number of sweeps treated
- Actions to be taken.

MEASURE – Parameters – Pass/Fail

```

MEASURE
OFF Cursors
Parameters
mode
Std Time
Custom
List by nT
Pass
Fail
testing
OFF On
CHANGE TEST
CONDITIONS
From
0.00 div
Track OFF On
to
10.00 div
    
```

Off/Cursors/Parameters

To select "Parameters".

mode

To select "Pass" or "Fail".

testing

For turning testing "Off" or "On". Testing is turned off in order to observe only the parameter variations.

CHANGE TEST CONDITIONS

To access the secondary "CHANGE TEST" menu (*see next page*)

from

To determine the starting point, in screen divisions, for parameter measurements.

to

To determine the end point in screen divisions.

CHANGE TEST

CHANGE TEST

On line
1 2 3 4 5
Action

Test on
Param Mask
---(No Test)

choose
Param Limit

DELETE ALL TESTS

measure
--
acsn
ampl
area
avg

of
1 2 3 4
A B C D

On line

To select for modification up to five different parameters, "1, 2, 3, 4 or 5"

Test on

To select "Param" or, if no test is required, "--- (No Test)".

choose

To select "Param".

DELETE ALL TESTS

For deleting all tests previously selected.

measure

For selecting the new parameter to be measured on this line. When "--" is selected the line is not used.

of

For selecting the channel or trace on which the parameter will be measured (*four-channel menu shown*).



CURSORS/MEASURE & Parameters

CHANGE TEST – Param (Changing Limits for Pass/Fail Tests on Parameters)

CHANGE TEST
On line 1 2 3 4 5 Action
Test on Param Mask ---(No Test)
choose Param Limit
DELETE ALL TESTS
True if < >
limit +0.00 E+00 3 digits
SET TO LATEST VALUE

On line

To select for modification up to five different parameters, “1, 2, 3, 4 or 5”.

Test on

To Select “Param” or “--- (No Test)” if no test required on the selected line (“Mask” selection, page 14–17).

choose

For setting to “Limit” (“Param” 14–15).

DELETE ALL TESTS

For deleting all tests previously selected.

True if

For selecting the adequate relation — smaller than “<”, or greater than “>”.

limit

To make the choice of one of three modifications of a limit: its mantissa, exponent, and the number of digits for the representation of its mantissa. The corresponding menu button is used to select, and the associated knob to modify the number in that field.

SET TO LATEST VALUE

To set the limit to the latest measured value — a starting value for the final adjustment.

CHANGE TEST – Mask (Changing Pass/Fail Test on a Mask)

CHANGE TEST

On line
1 2 3 4 5
Action

Test on
Param Mask
---(No Test)

MODIFY MASK

True if
all points
some points

of
1 2 3 4
A B C D

are
inside
outside

mask
A B C D

On line

To select for modification up to five different parameters, “1, 2, 3, 4 or 5” (“Action” selection, page 14–20).

Test on

For setting to “Mask” or “--- (No Test)” if no test required on the selected line (“Param” 14–15).

MODIFY MASK

To access the secondary menu for modifying mask settings.

True if

For choosing this mask-test condition.

of

To select channel or trace for testing (*four-channel menu shown*).

are

For choosing this mask-test condition.

mask

To select mask trace “A”, “B”, “C” or “D”.

Note: Pass/Fail testing against a mask is affected by horizontal and vertical zooming of the mask trace. The test will be made inside the area bordered by the parameter cursors. Timebases of the mask and the trace under test should be identical. For visual mask testing, a single-grid display should be used when performing a single-trace mask test, while a dual-grid display should be used for a dual-trace test.

MODIFY MASK – W'form (Generating a Mask from a Waveform)

MODIFY MASK

From

W' Form	HDD
Card	Flpy

into

D=M4
M1 M2 M3 M4

INVERT MASK

D=M4

Use W' Form

1	2	3	4	A	B	C
D	M1	M2	M3	M4		

MAKE MASK

D=M4

delta V

0.50 div

delta T

0.20 div

from

To select "W'form".

into

For selecting "D=M4" if the mask is to be automatically displayed on the screen. Otherwise select "M1", "M2", "M3", or "M4".

Using "RECALL W'FORM" (see *previous chapter*) memories M1–M4 can be recalled to traces A to D for display.

INVERT MASK

To generate an inverted mask.

Use W'form

For selecting the waveform to be used as reference. The mask will be generated around this waveform (*four-channel menu shown*).

MAKE MASK

To generate the mask.

delta V

For selecting tolerance in amplitude, using the attributed knob.

delta T

For selecting tolerance in time, using the attributed menu knob.

MODIFY MASK

(FLOPPY DISK OR OPTIONAL STORAGE DEVICE)

```
MODIFY MASK
  From
  W'Form HDD
  Card Flpy
  into
  D=M4
  M1 M2 M3 M4
  INVERT MASK
  D=M4
  DO RECALL
  G703ONE.004
  File
  G703ONE 004
  G703ZERO 004
  SC2 007
  SC3 007
  SC4 007
  10-Oct-96
  09:52:02
  Size 409
```

from

To select the device.

into

For selecting "D=M4" to automatically display the mask on- screen, or "M1", "M2", "M3" or "M4".

INVERT MASK

For generating an inverted mask.

DO RECALL

To recall the mask.

File

To select the appropriate mask, using the associated menu knob.



CURSORS/MEASURE & Parameters

CHANGE TEST – Action (Setting PASS/FAIL Actions)

Depending on the test result certain actions can be taken.

CHANGE TEST	
On line	
1	2 3 4 5
Action	
DELETE ALL ACTIONS	
IF	
Pass	Fail
Then:	
Stop	No
Store	No
Dump	Yes
Beep	No
Pulse	No
Dump	
No	Yes

On line

For selecting "Action".

DELETE ALL ACTIONS

To delete all previously selected actions.

If

To determine if the action will be taken on "PASS" or "FAIL".

Then

For selecting the action ("Dump" in this example). The selected action will then be activated in the menu below.

Dump

To perform ("Yes") or disable ("No") the action chosen in the "Then" menu (see above). The choice will then be indicated alongside the already selected action in "Then".

Saving and Recalling Panel Setups

PANEL SETUPS

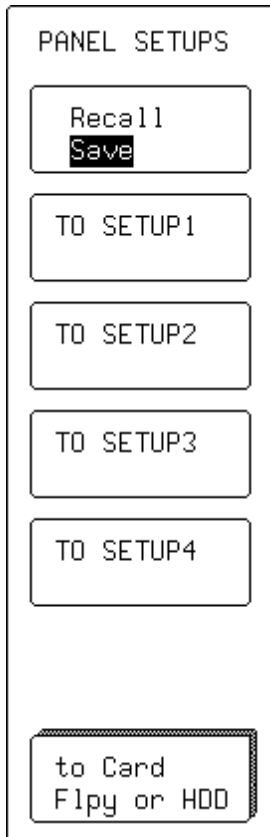

PANEL
SETUPS

Press  to access the menus used for saving or recalling configurations — panel setups — to non-volatile memory or floppy disk, or to memory card or portable hard disk (HDD) depending on options installed.

Recall Save

To choose to save a panel setup or recall one already saved. When “**Save**” is selected, as *shown here*, the “TO SETUP” menus appear. While when “**Recall**” is chosen, the “FROM SETUP” menus, *shown overleaf*, appear

TO SETUP 1 ...2 ...3 or ...4

For saving any of four possible setups.

to Card, Flpy or HDD

For saving a setup to floppy, memory card, or hard disk, depending on options.

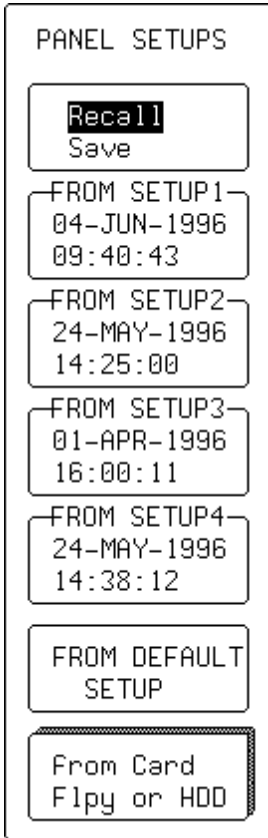

Recall or Save

To select for saving or recalling a panel setup. When **“Save”** is selected, as shown on the previous page, the **“TO SETUP”** menus appear. While when **“Recall”** is chosen, as shown here, the **“FROM SETUP”** menus appear.

FROM SETUP 1 ...2 ...3 or ...4

For recalling any of four possible saved setups. In the example shown here, all four possible setups have been stored. When no setup has been stored, that menu will indicate **“Empty”**.

FROM DEFAULT SETUP

To choose a default setup, already stored in the scope.

from Card, Flpy or HDD

For accessing the secondary **“RECALL SETUPS”** menu to recall a setup stored on floppy, card or portable hard disk, depending on the options installed.

RECALL SETUPS

```
RECALL SETUPS
  From
  Card Flpy
  HDD
  Directory:
  LECROY-1.DIR
  10-OCT-96
  09:52:12
  Size 3403
  DO RECALL
  ONE.PNL
  File
  ONE PNL
  ZERO PNL
```

from

For selecting to recall a setup from floppy, or card or portable hard disk, depending on the options installed and the medium on which the desired setup is stored.

DO RECALL

To perform the recall of the setup selected in the "File" menu (*see below*).

File

For selecting the stored setup, using the attributed menu knob.

The Complete Picture, Summarized

SHOW
STATUS

Press  to summon the “STATUS” menu and access full-screen summaries of the oscilloscope’s system and other functional status.

Acquisition Status

Vertical sensitivity, probe attenuation, offset and coupling for each channel, as well as timebase and trigger status summaries.

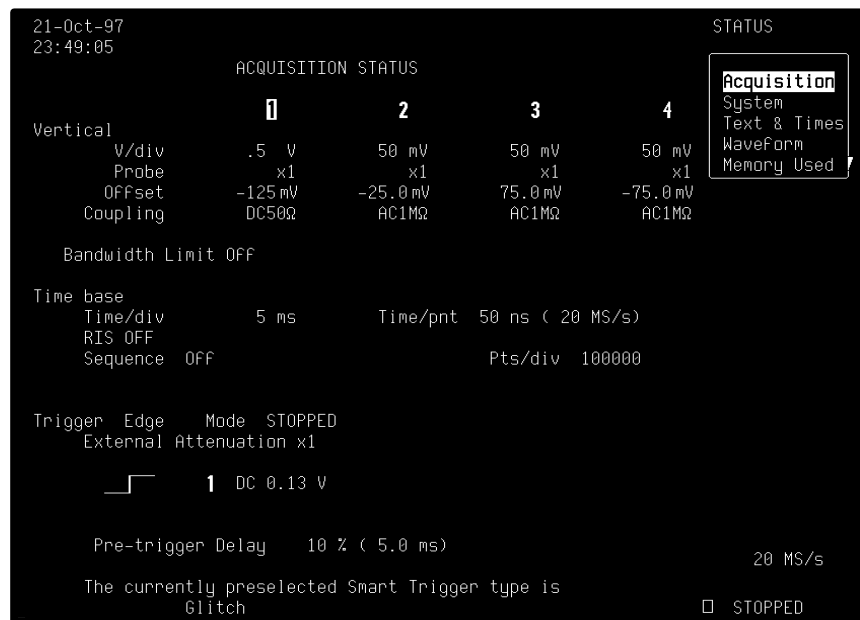

System

Scope serial number, firmware version, and software and hardware options installed. The “MORE VERSION INFORMATION” menu is used to perform a cyclic redundancy check (CRC) of the internal firmware and will generate a checksum that can be used to ensure the firmware is uncorrupted.

```
21-Oct-97                               STATUS
23:49:14

Serial Number 935401930
Soft Version 9354CL 07.5.1
Thursday, September 04, 1997 11:07 AM
(build 5)

Soft Options
WP01  WP02  WP03  DDM  CKIO  PRML  ORM  DDFA
MATE  MC01  S011  S012

Hard Options
GPIB  R232  CLBZ  FD01  GP01  CENT  HD01  CPU3
I2C

Main Processor RAM size: 16M bytes
Acquisition Memory size: 2M data points per channel

20 MS/s

□ STOPPED
```

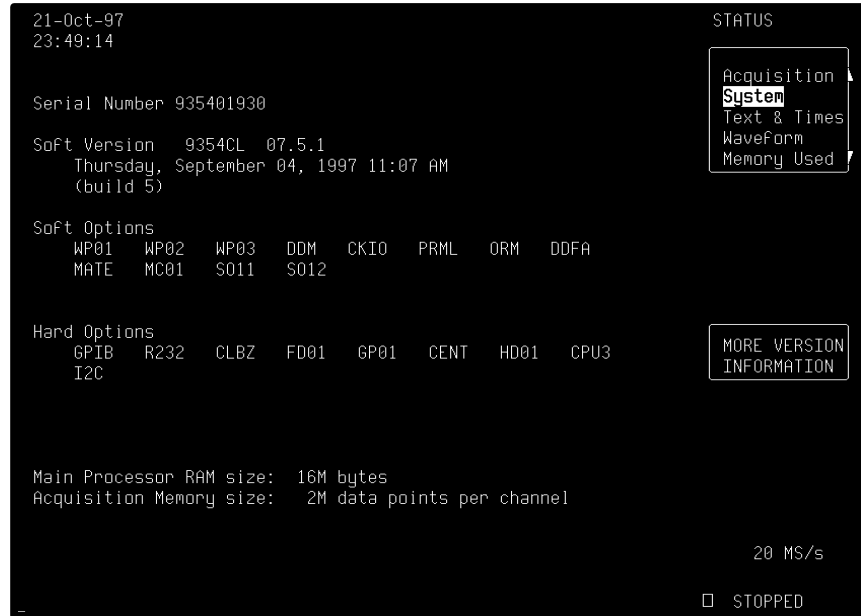

Text & Times

User text in the waveform descriptor* and trigger timing information (four-channel menu shown in this example). And when “Text & Times” is selected the “for” and “Select” menus shown here also appear, allowing a trace or memory to be selected and a segment range to be specified for information.

The screenshot shows a terminal window with the following content:

```
21-Oct-97
23:51:14

For
waveform
1

Segment      Time              since Segment 1  between Segments

1) 21-Oct-1997 23:50:54
2) 21-Oct-1997 23:50:54      5.999984 ms
3) 21-Oct-1997 23:50:54     11.999968 ms    5.999984 ms
4) 21-Oct-1997 23:50:54     17.999952 ms    5.999984 ms
5) 21-Oct-1997 23:50:54     23.999936 ms    5.999984 ms
6) 21-Oct-1997 23:50:54     29.999919 ms    5.999984 ms
7) 21-Oct-1997 23:50:54     35.999903 ms    5.999984 ms
8) 21-Oct-1997 23:50:54     41.999887 ms    5.999984 ms
9) 21-Oct-1997 23:50:54     47.999871 ms    5.999984 ms
10) 21-Oct-1997 23:50:54    53.999855 ms    5.999984 ms
11) 21-Oct-1997 23:50:54    59.999838 ms    5.999984 ms
12) 21-Oct-1997 23:50:54    65.999822 ms    5.999984 ms
13) 21-Oct-1997 23:50:54    71.999806 ms    5.999984 ms
14) 21-Oct-1997 23:50:54    77.999789 ms    5.999984 ms
15) 21-Oct-1997 23:50:54    83.999773 ms    5.999984 ms
16) 21-Oct-1997 23:50:54    89.999757 ms    5.999984 ms
17) 21-Oct-1997 23:50:54    95.999740 ms    5.999984 ms
18) 21-Oct-1997 23:50:54   101.999724 ms    5.999984 ms
19) 21-Oct-1997 23:50:54   107.999708 ms    5.999983 ms
20) 21-Oct-1997 23:50:54   113.999691 ms    5.999984 ms STOPPED
```

STATUS

- Acquisition System
- Text & Times**
- Waveform
- Memory Used

For

1	2	3	4
A	B	C	D
M1	M2	M3	M4

Select segment (1 - 50)

5 MS/s
50 x

* Refer to the *Remote Control Manual*.

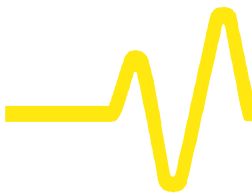

SHOW STATUS

Waveform

Detailed status information on channels, memories, zoom and math or displayed traces, specified using the bottom menu, which appears when “Waveform” is selected from the top.

21-Oct-97 23:52:19 WAVEFORM					STATUS
	1	2	3	4	
Trigger date	21-Oct-1997	21-Oct-1997	21-Oct-1997	21-Oct-1997	Acquisition System Text & Times Waveform Memory Used
time	23:50:54	23:50:54	23:50:54	23:50:54	
for	0.29 s	0.29 s	0.29 s	0.29 s	
Vertical					
Scale/div	100 mV	0.50 V	50 mV	50 mV	Channels Zoom+Math Memories Displayed
Offset	-256 mV	-0.25 V	75 mV	-75 mV	
Coupling	DC50Ω	AC1MΩ	AC1MΩ	AC1MΩ	
BW-Limit	Off	Off	Off	Off	
Horizontal					
Scale/div	0.50 ms	0.50 ms	0.50 ms	0.50 ms	
Offset	10.0 % Pre	10.0 % Pre	10.0 % Pre	10.0 % Pre	
Scale/pnt	0.20 μs	0.20 μs	0.20 μs	0.20 μs	
Pnts/div	2500	2500	2500	2500	
Record Type	SINGLE	SINGLE	SINGLE	SINGLE	
Segments	50	50	50	50	
Sweeps					
					5 MS/s 50 x
					□ STOPPED

Memory Used

Shows how much memory is being used and how much remains free. Memory allocation: memories M1–4 can be selected and then cleared using the “CLEAR INACTIVE” menu. The dedicated persistence data maps for each channel are dynamically created, resized and deleted as necessary. The allocation of memory to each of these data maps will appear in this menu. Persistence data maps are cleared using the CLEAR SWEEPS button.

```
21-Oct-97
23:53:31

Memory used for storage of records

name          bytes
A             568 inactive
B             50 048 inactive
M1           2 500 892
M4             50 108
Free          9 920 824
Total        12 522 440
```

To Free some memory, you can

- . clear Memory waveforms
- . reduce the number of points used for Math (MATH SETUP)
- . reduce the number of samples in the Record (TIMEBASE SETUP)
- . turn off traces or parameters

STATUS

Acquisition System
Text & Times
Waveform
Memory Used

CLEAR M1

M2 empty

M3 empty

CLEAR M4

CLEAR INACTIVE

5 MS/s

STOPPED

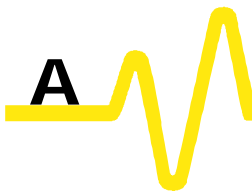

➤ **9304C Series, 9310C Series, 9314C Series**

Signal Capture



Acquisition System

Bandwidth (- 3 dB):

- **9304C Series**
 - @ 50 Ω: DC to 200 MHz
 - @ 1 MΩ: DC to 160 MHz typical at probe tip
- **9310C/9314C Series):**
 - @ 50 Ω: DC to 400 MHz
 - @ 1 MΩ: DC to 230 MHz typical at probe tip

Number of Channels:

- **9304C/9314C Series:** four
- **9310C Series:** two

Number of Digitizers:

- **9304C/9314C Series:** four
- **9310C Series:** two

Max. Sample Rate: 100 MS/s simultaneously on each channel

Sensitivity: 2 mV/div to 5 V/div, fully variable

Scale Factors: Wide range of probe attenuation factors

Offset Range:

- 2.00–9.9 mV/div: ±120 mV
- 10.0–199 mV/div: ±1.2 V
- 0.2–5.0 V/div: ±24 V

DC Accuracy: ±2 % full scale (eight divisions) at 0 V offset

Vertical Resolution: 8 bits

Bandwidth Limiter: 30 MHz

Note: Where a particular model or a series is NOT mentioned, the specification concerned applies to all related models.

Model	9304C	9304CM	9310C	9310CM	9310CL	9314C	9314CM	9314CL
Number of Channels	Four		Two			Four		
Acquisition Memory per Channel	50 k	200 k	50 k	200 k	1 M	50 k	200 k	1 M

Input Coupling: AC, DC, GND



Input Impedance: 1 M Ω //15 pF (system capacitance using PP002) or 50 Ω \pm 1 %

Max. Input:

- 50 Ω : \pm 5 V DC (500 mW) or 5 V rms
- 1 M Ω : 250 V max (DC + peak AC \leq 10 kHz)

Acquisition Modes

Random Interleaved Sampling (RIS): For repetitive signals from 1 ns/div to 10 μ s/div

Single shot: For transient and repetitive signals from 50 ns/div

Sequence: Stores multiple events in segmented acquisition memories

Deadtime Between Segments: \approx 80 μ s

Number of Segments Available:

Model			Segments
9304C	9310C	9314C	2–200
9304CM	9310CM	9314CM	2–500
9310CL	9314CL		2–2000

Timebase System

Timebases: Main and up to four Zoom Traces

Time/Div Range: 1 ns/div to 1000 s/div

Clock Accuracy: \approx \pm 0.002%

Interpolator resolution: 10 ps

Roll Mode: Ranges 500 ms–1000 s/div

For > 50 000 points: 10–1000 s/div

External Clock: \approx 100 MHz on EXT input with ECL, TTL or zero crossing levels

Triggering System

Modes: Normal, Auto, Single, and Stop

Sources: CH1, CH2 (plus CH3 and CH4 on four-channel models), Line, Ext, Ext/10; Slope, Level and Coupling able to be set independently

Slope: Positive, Negative, Window (Bislope)

Coupling: AC, DC, HF (up to 500 MHz), LFREJ, HFREJ

Pre-trigger Recording: 0–100 % of full scale adjustable in 1 % increments



Post-trigger Delay: 0–10 000 divisions adjustable in 0.1 div increments

Holdoff by Time: 10 ns–20 s

Holdoff by Events: 0–99 999 999 events

Internal Trigger Range: ± 5 div

EXT Trigger Max Input:

➤ 50 Ω ± 1 %: ± 5 V DC (500 mW) or 5 V rms

➤ 1 M Ω /15 pF: 250 V max. (DC + peak AC ≤ 10 kHz)

EXT Trigger Range: ± 0.5 V (± 5 V with Ext/10)

Trigger Timing: Trigger Date and Time listed in “Memory Status” menu

SMART Trigger Types

Signal Width: Triggers on width between two limits of between 2.5 ns and 20 s

Signal Interval: Triggers on interval between two limits of between 10 ns and 20 s

Dropout: Triggers if the input signal drops out for a time-out longer than 25 ns–20 s

State/Edge Qualified: Triggers on any source only if a given state or transition — number of events, time interval — on another source

TV: Selection of both line (up to 1500) and field number (up to 8) for PAL, SECAM, NTSC or nonstandard video

Exclusion Trigger: Triggers only on shorter-than-normal (defined) aberrations

Autosetup

AUTOSETUP button: Sets timebase, trigger and sensitivity to display wide range of repetitive signals — amplitude 2 mV to 40 V; frequency above 50 Hz; Duty cycle greater than 0.1%

Autosetup Time: Around two seconds

Vertical Find: Automatically sets sensitivity and offset



Probes

Probe Model: One PP002 probe supplied per channel; FET probes, purchased separately, fully compatible with entire scope series

Probe calibration: Max 1 V into 1 M Ω , 500 mV into 50 Ω , frequency and amplitude programmable, pulse or square wave able to be selected, rise and fall time 1 ns typical (calibrator also offers trigger or Pass/Fail output)



Signal Viewing

Display

CRT: 12.5 x 17.5 cm (9" diagonal)
 raster
Resolution: 810 x 696 points
Grids: 1, 2, or 4 grids.
Formats: YT, XY and both together
Graticules: Internally generated; separate intensity control for grids and waveforms
Waveform Style: Vectors, which can be switched on and off, connect individual sample points highlighted as dots
Modes: Normal, XY, Variable or Infinite Persistence
Real-time Clock: Date, hours, minutes, seconds
Vertical Zoom: Up to 5x Vertical Expansion (50x with averaging, up to 40 μ V sensitivity)
Horizontal Zoom:

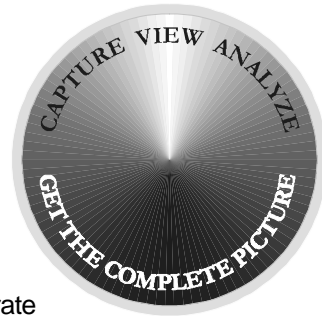

Model			Zoom Factor
9304C	9310C	9314C	1000x
9304CM	9310CM	9314CM	5000x
9310CL		9314CL	20 000x

Signal Analysis

Waveform Processing

Processing Functions: Add, Subtract, Multiply, Divide, Negate, Identity and Summation Averaging; four functions performable at one time
Average: Summed averaging of up to 1000 waveforms in the basic instrument; up to 10^6 averages possible with optional WP01 Advanced Waveform Math Package

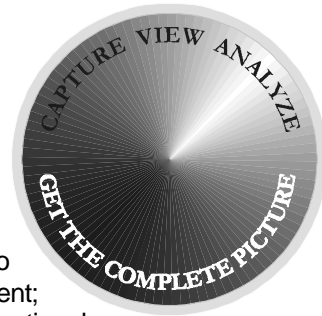

9304C Series, 9310C Series, 9314C Series

Extrema: Roof, Floor or Envelope values of from 1 to 10^6 waveforms with optional WP01 Advanced Waveform Math Package



ERES: Low-Pass digital filter provides up to 11 bits vertical resolution; sampled data always available, even when trace turned off; any of above modes usable without destroying data — with WP01 Option

FFT: Spectral Analysis with five windowing functions and FFT averaging, with optional WP02 Spectrum Analysis Package

Histogramming and Trending: With optional WP03 Parameter Analysis Package, in-depth diagnostics on waveform parameters

Internal Memory

Waveform Memory: Up to four 16-bit Memories (M1, M2, M3, M4)

Processing Memory: Up to four 16-bit Waveform Processing Memories (A, B, C, D)

Setup Memory: Four non-volatile memories; optional cards for high-capacity waveform and setup storage

Cursor Measurements

Relative Time: Arrow cursors measure time and voltage differences relative to each other

Relative Voltage: Horizontal bars measure voltage differences up to $\pm 0.2\%$ full-scale in single-grid mode

Absolute Time: Cross-hair marker measures time relative to trigger and voltage with respect to ground

Absolute Voltage: Reference bar measures voltage with respect to ground

Interfacing

Remote Control: By GPIB and RS-232-C for all front-panel controls, internal functions

RS-232-C Port: Asynchronous up to 115.2 Kb/s for computer or terminal control, or printer or plotter connection

GPIB Port: (IEEE-488.1) Configurable as talker/listener for computer control and fast data transfer; command language compliant with IEEE-488.2

Centronics Port: Hardcopy interface

PC Card (PCMCIA II/III Ports): Optional for memory cards, flash cards and removable hard disks

Floppy Disk: High density 3.5-inch floppy disk drive (DOS format)

Hardcopy: TIFF and BMP formats available for import to Desktop Publishing programs; printers and plotters — HP DeskJet, HP ThinkJet,

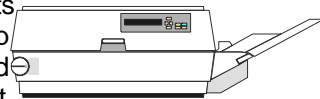
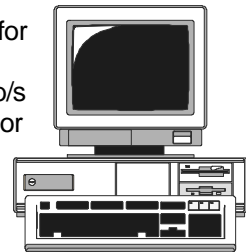

9304C Series, 9310C Series, 9314C Series

QuietJet, LaserJet, PaintJet, and EPSON printers; HP 7400 and 7500 series, or HPGL compatible plotters

➤ Optional internal, high-resolution graphics printer

Output Formats: Binary, or ASCII waveform output compatible with spreadsheets, MATLAB™, MathCad™

General

Auto-calibration: Ensures specified DC and timing accuracy

Temperature: 5 to 40 °C (41 to 104 °F) rated

Humidity: 80 % for temperatures up to 31 °C, decreasing linearly to 50 % relative humidity at 40 °C

Altitude: Up to 2000 m (6560 ft) operating, 40 °C max

Power: 90–250 V AC, 45–66 Hz, 150 W

Battery Backup: Front-panel settings maintained for two years

Dimensions: (HWD) 8.5 x 14.5 x 16.25 inches / 264 x 397 x 453 mm

Weight: 12.5 kg (27.5 lb.) net, 18 kg (40 lb.) shipping

Warranty: Three years

Conformity

EMC: EN 50082-1 conformity

Safety: Designed to comply with EN 61010-1; UL and cUL listed, File E 170588: Protection Category I, Installation (Over-Voltage) Category II, Pollution Degree 2

See Declaration of Conformity for further details.

➤ 9344C Series, 9350C Series, 9354C Series

Signal Capture

Acquisition System



Bandwidth (- 3 dB):

- **9344C Series**
 - @ 50 Ω: DC to 500 MHz
 - 100 mV/div: 400 MHz
 - 50 mV/div and below: 350 MHz
 - @ 1 MΩ: DC to 500 MHz typical at tip of optional FET probe AP020
- **9350C/9354C Series:**
 - @ 50 Ω: DC to 500 MHz
 - 100 mV/div: 400 MHz
 - 50 mV/div and below: 350 MHz
 - @ 1 MΩ: DC to 500 MHz typical at tip of optional FET probe AP020

Number of Channels:

- **9344C/9354C Series:** four
- **9350C Series:** two

Number of Digitizers:

- **9344C/9354C Series:** four
- 9350C Series:** two

9344C Series					
CHANNELS USED (PEAK DETECT ON/OFF)	MAX SAMPLE RATE	MEMORY PER CHANNEL (IN POINTS) PER MODEL			ACTIVE CHANNELS
		C	CM	CL	
All (Peak Detect Off)	250 MS/s	50k	250k	2M	All
All (Peak Detect ON)	100 MS/s data	25k data	100k data	1M data	All
	200 MS/s peak	25k peak	100k peak	1M peak	
Two Channels Paired (Peak Detect OFF)	500 MS/s	100k	500k	4M	CH 2 and CH 3
Four Channels Combined (Peak Detect OFF)	1000 MS/s	250k	500k	4M	CH 2



Specifications

9350C/9354C Series						
CHANNELS USED (PEAK DETECT ON/OFF)	MAX SAMPLE RATE	MEMORY PER CHANNEL (IN POINTS) PER MODEL			ACTIVE CHANNELS	
		C	CM	CL		
All (Peak Detect OFF)	500 MS/s	50k	250k	2M	All	
All (Peak Detect ON)	100 MS/s data	25k data	100k data	1M data	All	
	400 MS/s peak	25k peak	100k peak	1M peak	2.5 ns peak detect	
Two Channels Paired (Peak Detect OFF)	1 GS/s	100k	500k	4M	9350C/M/L	9354C/M/L
					CH 1	CH 2 + CH 3
FOUR-CHANNEL MODELS ONLY						
Four Channels Combined by PP092 Adapter (Peak Detect OFF)	2 GS/s	250k	1M	8M	CH 2 (PP092 input)	
9354CTM						
All (Peak Detect OFF)	500 MS/s	500 000			All	
Two Channels Paired (Peak Detect OFF)	1 GS/s	1M			CH 2 and CH 3	
All Peak Detect ON	100 MS/s data	250k data			All	
	400 MS/s peak	250k peak			2.5 ns peak detect	
Four Channels Combined by PP092 Adapter (Peak Detect OFF)	2 GS/s	2M			CH 2 (PP092 input)	

Sensitivity: 2 mV/div to 5 V/div, fully variable

Scale Factors: Wide range of probe attenuation factors

Offset Range:

- 2.00–9.9 mV/div: ±120 mV
- 10.0–199 mV/div: ±1.2 V
- 0.2–5.0 V/div: ±24 V

DC Accuracy: typically 1%

Vertical Resolution: 8 bits

Bandwidth Limiter: 30 MHz

Input Coupling: AC, DC, GND



Input Impedance: 50 Ω \pm 1 % or 1 M Ω //15 pF (system capacitance using PP002)

Max. Input:

- 50 Ω : \pm 5 V DC (500 mW) or 5 V rms
- 1 M Ω : 250 V max (DC + peak AC \leq 10 kHz)

Acquisition Modes

Random Interleaved Sampling (RIS): For repetitive signals from 1 ns/div to 2 μ s/div

- **9344C Series, 9350CM/CL, 9354CM/CL/CTM:** For repetitive signals from 1 ns/div to 5 μ s/div

Single shot:

- **9344C Series:** For transient and repetitive signals from 20 ns/div (all channels active)
- **9350C, 9354C Series:** For transient and repetitive signals from 10 ns/div (all channels active)

Peak Detect:

- **9344C Series:** Captures and displays 5 ns glitches and other high-speed events
- **9350C, 9354C Series:** Captures and displays 2.5 ns glitches and other high-speed events

Sequence: Stores multiple events in segmented acquisition memories

Deadtime Between Segments: \approx 80 μ s

Number of Segments Available:

Model				Segments
9344C	9350C	9354C		2–200
9344CM	9350CM	9354CM	9354CTM	2–500
9344CL	9350CL	9354CL		2–2000

Timebase System

Timebases: Main and up to four Zoom Traces

Time/Div Range: 1 ns/div to 1000 s/div

Clock Accuracy: \approx 10 ppm

Interpolator resolution: 10 ps

Roll Mode:

- **9344C:** Ranges 500 ms–1000 s/div
- **9350C, 9354C Series:** Ranges 500 ms–1000 s/div; >50 000 points: 10–1000 s/div

External Clock: \approx 100 MHz on EXT input with ECL, TTL or zero crossing levels

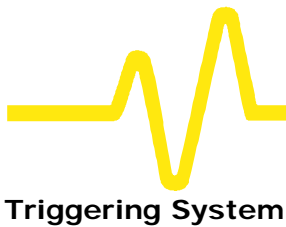

Triggering System

Modes: Normal, Auto, Single, and Stop
Sources: CH1, CH2 (plus CH3 and CH4 on four-channel models), Line, Ext, Ext/10; Slope, Level and Coupling able to be set independently
Slope: Positive, Negative
Coupling: AC, DC, HF (up to 500 MHz), LFREJ, HFREJ
Pre-trigger Recording: 0–100 % of full scale adjustable in 1 % increments
Post-trigger Delay: 0–10 000 divisions adjustable in 0.1 div increments
Holdoff by Time: 10 ns–20 s
Holdoff by Events: 0–99 999 999 events
Internal Trigger Range: ± 5 div
EXT Trigger Max Input:
 ➤ 50 Ω ± 1 %: ± 5 V DC (500 mW) or 5 V rms
 ➤ 1 M Ω /15 pF: 250 V max. (DC + peak AC ≤ 10 kHz)
EXT Trigger Range: ± 0.5 V (± 5 V with Ext/10)
Trigger Timing: Trigger Date and Time listed in “Memory Status” menu



SMART Trigger Types

Signal or Pattern Width: Triggers on width between two limits of between 2.5 ns and 20 s
Signal or Pattern Interval: Triggers on interval between two limits of between 10 ns and 20 s
Dropout: Triggers if the input signal drops out for a time-out longer than 25 ns–20 s
State/Edge Qualified: Triggers on any source only if a given state or transition — number of events, time interval — on another source
TV: Selection of both line (up to 1500) and field number (up to 8) for PAL, SECAM, NTSC or nonstandard video
Exclusion Trigger: Triggers only on shorter-than-normal (defined) aberrations
Pattern Trigger:
 ➤ **Two-channel models:** Triggers on the logic combination of the three inputs CH 1, CH 2 and EXT Trigger, where each source can be defined as High, Low or Don't Know and the trigger as the pattern's beginning or end
 ➤ **Four-channel models:** Triggers on the logic combination of the five inputs CH 1, CH 2, CH 3, CH 4 and EXT Trigger,

9344C Series, 9350C Series, 9354C Series

where each source can be defined as High, Low or Don't Know and the trigger as the pattern's beginning or end



Autosetup

AUTOSETUP button: Sets timebase, trigger and sensitivity to display wide range of repetitive signals — amplitude 2 mV to 40 V; frequency above 50 Hz; duty cycle greater than 0.1%

Autosetup Time: Around two seconds

Vertical Find: Automatically sets sensitivity and offset



Probes

Probe Model: One PP002 probe supplied per channel, DC to 250 MHz typical at probe tip, 600 V max.; FET probes, purchased separately, fully compatible with entire scope series

Probe calibration: Max 1 V into 1 MΩ, 500 mV into 50 Ω, frequency and amplitude programmable, pulse or square wave able to be selected, rise and fall time 1 ns typical (calibrator also offers trigger or Pass/Fail output)

Signal Viewing

Display

CRT: 12.5 x 17.5 cm (9" diagonal) raster

Resolution: 810 x 696 points

Grids: 1, 2, or 4 grids.

Formats: YT, XY and both together

Gaticules: Internally generated; separate intensity control for grids and waveforms

Waveform Style: Vectors, which can be switched on and off, connect individual sample points highlighted as dots

Modes: Normal, XY, Variable or Infinite Persistence

Real-time Clock: Date, hours, minutes, seconds

Vertical Zoom: Up to 5x Vertical Expansion (50x with averaging, up to 40 μV sensitivity, with optional WP01 Advanced Waveform Math Package)

Horizontal Zoom: Waveforms can be expanded to give 2–2.5 points/div



Model			Zoom Factor
9344C	9350C	9354C	2000x
9344CM	9350CM	9354CM	10 000x

9344C Series, 9350C Series, 9354C Series

9354CTM			50 000x
9344CL	9350CL	9354CL	100 000x



Signal Analysis

Waveform Processing

Processing functions: Add, Subtract, Multiply, Divide, Negate, Identity, Summation Averaging, and Sine x/x; four functions performable at one time **Average:** Summed averaging of up to 1000 waveforms in the basic instrument; up to 10^6 averages possible with optional WP01 Advanced Waveform Math Package

Extrema: Roof, Floor or Envelope values of from 1 to 10^6 waveforms with optional WP01 Advanced Waveform Math Package

ERES: Low-Pass digital filter provides up to 11 bits vertical resolution; sampled data always available, even when trace turned off; any of above modes usable without destroying data — with WP01 Option

FFT: Spectral Analysis with five windowing functions and FFT averaging, with optional WP02 Spectrum Analysis Package

Histogramming and Trending: With optional WP03 Parameter Analysis Package, in-depth diagnostics on waveform parameters



Internal Memory

Waveform Memory: Up to four 16-bit Memories (M1, M2, M3, M4)

Processing Memory: Up to four 16-bit Waveform Processing Memories (A, B, C, D)

Setup Memory: Four non-volatile memories; optional cards or disks for high-capacity waveform and setup storage

Cursor Measurements

Relative Time: Arrow cursors measure time and voltage differences relative to each other

Relative Voltage: Horizontal bars measure voltage differences up to $\pm 0.2\%$ full-scale in single-grid mode

Absolute Time: Cross-hair marker measures time relative to trigger and voltage with respect to ground

Absolute Voltage: Reference bar measures voltage with respect to ground

Interfacing



Remote Control: By GPIB and RS-232-C for all front-panel controls, internal functions

RS-232-C Port: Asynchronous up to 115.2 Kb/s for computer or terminal control, or printer or plotter connection

GPIB Port: (IEEE-488.1) Configurable as talker/listener for computer control and fast data transfer; command language compliant with IEEE-488.2

Centronics Port: Hardcopy interface

PC Card (PCMCIA II/III Ports): Optional for memory cards, flash cards and removable hard disks

Floppy Disk: High density 3.5-inch floppy disk drive (DOS format)

Hardcopy: TIFF and BMP formats, available for import to Desktop Publishing programs; printers and

plotters: HP DeskJet, HP ThinkJet, QuietJet, LaserJet, PaintJet, and EPSON printers;

HP 7400 and 7500 series, or HPGL compatible plotters

➤ Optional internal, high-resolution graphics printer

Output Formats: Binary, or ASCII waveform output compatible with spreadsheets, MATLAB, Mathcad

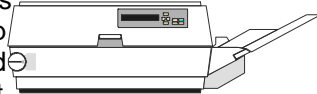
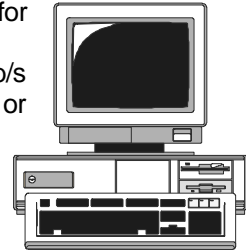

General

Auto-calibration: Ensures specified DC and timing accuracy

Temperature: 5 to 40 °C (41 to 104 °F) rated

Humidity: 80 % for temperatures up to 31 °C, decreasing linearly to 50 % relative humidity at 40 °C

Altitude: Up to 2000 m (6560 ft) operating, 40 °C max

Power: 90–250 V AC, 45–66 Hz, 230 W

Battery Backup: Front-panel settings maintained for two years

Dimensions: (HWD) 8.5 x 14.5 x 16.25 inches / 264 x 397 x 453 mm

Weight: 13 kg (28.6 lb.) net, 18.5 kg (40.7 lb.) shipping

Warranty: Three years

Conformity

EMC: EN 50082-1 conformity

Safety: Designed to comply with EN 61010-1; UL and cUL listed, File E 170588: Protection Category I, Installation (Over-Voltage) Category II, Pollution Degree 2

See Declaration of Conformity for further details.



➤ **9370C Series, 9374C Series**

Signal Capture



Acquisition System

Bandwidth (- 3 dB):

- @ 50 Ω: DC to 1 GHz
10 mV/div and above
- @ 1 MΩ: DC to 500 MHz typical
at PP005 probe tip
 - 1 GHz FET probe optional

Number of Channels, Digitizers:

- **9374C Series:** four
- **9370C Series:** two

Sensitivity:

- 50 Ω: 2 mV/div to 1 V/div, fully variable
- 1 MΩ: 2 mV/div to 10 V/div, fully variable

Scale Factors: Wide range of probe attenuation factors

9370C/9374C Series						
CHANNELS USED (PEAK DETECT ON/OFF)	MAX SAMPLE RATE	MEMORY PER CHANNEL (POINTS)				ACTIVE CHANNELS
		Model				
		C	CM	CTM	CL	
All (Peak Detect OFF)	500 MS/s	50k	250k	500k	2M	All
All (Peak Detect ON)	100 MS/s data	25k data	100k data	250k data	1M data	All
	400 MS/s peak	25k peak	100k peak	250k peak	1M peak	2.5 ns peak detect
Two Channels Paired (Peak Detect OFF)	1 GS/s	100k	500k	1M	4M	9370C/M/L
						CH 1
FOUR-CHANNEL MODELS ONLY						
Four Channels Combined by PP093 Adapter (Peak Detect OFF)	2 GS/s	250k	1M	2M	8M	One (PP093 input)



Acquisition Modes

Offset Range:

- 2.00–4.99 mV/div: ±400 mV
- 5–99 mV/div: ±1 V
- 0.1–1 V/div: ±10 V
- 1–10 V/div: ±100 V (1 MΩ Only)

DC Accuracy: typically 1%

Vertical Resolution: 8 bits

Bandwidth Limiter:

- 25 MHz
- 200 MHz

Input Coupling: AC, DC, GND

Input Impedance: 50 Ω ±1 %, or 1 MΩ//15 pF typical, system capacitance at tip of PP005 probe

Max. Input:

- 50 Ω: ±5 V DC (500 mW) or 5 V rms
- 1 MΩ: 400 V max (DC + peak AC ≤10 kHz)

Random Interleaved Sampling (RIS): For repetitive signals from 1 ns/div to 5 μs/div

Single shot: For transient and repetitive signals from 10 ns/div (all channels active)

Peak Detect: Captures and displays 2.5 ns glitches and other high-speed events

Sequence: Stores multiple events in segmented acquisition memories

Deadtime Between Segments: ≈80 μs

Number of Segments Available:

Model		Segments
9370C	9374C	2–200
9370CM	9374CM	2–500
9370CL	9374CL 9374CTM	2–2000

Timebase System

Timebases: Main and up to four Zoom Traces

Time/Div Range: 1 ns/div to 1000 s/div

Clock Accuracy: ≤10 ppm

Interpolator resolution: 10 ps



Triggering System



SMART Trigger Types

Roll Mode:

- Ranges 500 ms–1000 s/div
- For >50 000 points: 10–1000 s/div

External Clock:

- =100 MHz on EXT input with ECL, TTL or zero crossing levels
- Optional 50–500 MHz rear panel fixed frequency clock input

Modes: Normal, Auto, Single, and Stop

Sources: CH1, CH2 (plus CH3 and CH4 on four-channel models), Line, Ext, Ext/10; Slope, Level and Coupling able to be set independently

Slope: Positive, Negative

Coupling: AC, DC, HF, LFREJ, HFREJ

Pre-trigger Recording: 0–100 % of full scale adjustable in 1 % increments

Post-trigger Delay: 0–10 000 divisions adjustable in 0.1 div increments

Holdoff by Time: 10 ns–20 s

Holdoff by Events: 0–99 999 999 events

Internal Trigger Range: ±5 div

EXT Trigger Max Input:

- 50 Ω ±1 %: ±5 V DC (500 mW) or 5 V rms
- 1 MΩ/15 pF: 400 V max. (DC + peak AC ≤10 kHz)

EXT Trigger Range: ±0.5 V (±5 V with Ext/10)

Trigger Timing: Trigger Date and Time listed in “Memory Status” menu

Signal or Pattern Width: Triggers on width between two limits of between 2.5 ns and 20 s

Signal or Pattern Interval: Triggers on interval between two limits of between 10 ns and 20 s

Dropout: Triggers if the input signal drops out for a time-out longer than 25 ns–20 s

State/Edge Qualified: Triggers on any source only if a given state or transition — number of events, time interval — on another source

TV: Selection of both line (up to 1500) and field number (up to 8) for PAL, SECAM, NTSC or nonstandard video

Exclusion Trigger: Triggers only on shorter-than-normal (defined) aberrations

Pattern:

- **Two-channel models:** Triggers on the logic combination of the three inputs CH 1, CH 2 and EXT Trigger, where each source can be defined as High, Low or Don't Know and the trigger as the pattern's beginning or end
- **Four-channel models:** Triggers on the logic combination of the five inputs CH 1, CH 2, CH 3, CH 4 and EXT Trigger, where each source can be defined as High, Low or Don't Know and the trigger as the pattern's beginning or end

Autosetup



AUTOSETUP button: Sets timebase, trigger and sensitivity to display wide range of repetitive signals — amplitude 2 mV–40 V; frequency above 50 Hz; duty cycle greater than 0.1%

Autosetup Time: Around two seconds

Vertical Find: Automatically sets sensitivity and offset

Probe Model: One PP005 probe supplied per channel (10:1, 10 MΩ//11 pF, 500 V max input); FET probes, purchased separately, fully compatible with entire scope series

Probe calibration: Max 1 V into 1 MΩ, 500 mV into 50 Ω, frequency and amplitude programmable, pulse or square wave able to be selected, rise and fall time 1 ns typical (calibrator also offers trigger or Pass/Fail output)

Signal Viewing

Display

CRT: 12.5 x 17.5 cm (9" diagonal)
raster

Resolution: 810 x 696 points

Grids: 1, 2, or 4 grids.

Formats: YT, XY and both together

Graticules: Internally generated;
separate intensity control for grids and waveforms

Waveform Style: Vectors, which can be switched on and off, connect individual sample points highlighted as dots

Modes: Normal, XY, Variable or Infinite Persistence

Real-time Clock: Date, hours, minutes, seconds





Specifications

Vertical Zoom: Up to 5x Vertical Expansion (50x with averaging, up to 40 μ V sensitivity, with optional WP01 Advanced Waveform Math Package)

Horizontal Zoom: Waveforms can be expanded to give 2–2.5 points/div.

Model		Zoom Factor
9370C	9374C	2000x
9370CM	9374CM	10 000x
9374CTM		50 000x
9370CL	9374CL	100 000x

Signal Analysis

Waveform Processing

Processing functions: Add, Subtract, Multiply, Divide, Negate, Identity, Summation Averaging, and Sine x/x; four functions performable at one time

Average: Summed averaging of up to 1000 waveforms in the basic instrument; up to 10⁶ averages possible with optional WP01 Advanced Waveform Math Package

Extrema: Roof, Floor or Envelope values of from 1 to 10⁶ waveforms — with WP01 Option

ERES: Low-Pass digital filter provides up to 11 bits vertical resolution; sampled data always available, even when trace turned off; any of above modes usable without destroying data — with WP01 Option

FFT: Spectral Analysis with five windowing functions and FFT averaging, with optional WP02 Spectrum Analysis Package

Histogramming and Trending: With optional WP03 Parameter Analysis Package, in-depth diagnostics on waveform parameters

Waveform Memory: Up to four 16-bit Memories (M1, M2, M3, M4).

Processing Memory: Up to four 16-bit Waveform Processing Memories (A, B, C, D).

Setup Memory: Four non-volatile memories; optional cards or disks for high-capacity waveform and setup storage

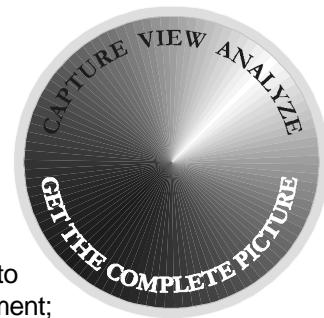

Internal Memory

Cursor Measurements

Relative Time: Arrow cursors measure time and voltage differences relative to each other

Relative Voltage: Horizontal bars measure voltage differences up to $\pm 0.2\%$ full-scale in single-grid mode

Absolute Time: Cross-hair marker measures time relative to trigger and voltage with respect to ground

Absolute Voltage: Reference bar measures voltage with respect to ground

Interfacing

Remote Control: By GPIB and RS-232-C for all front-panel controls, internal functions

RS-232-C Port: Asynchronous up to 115.2 Kb/s for computer or terminal control, or printer or plotter connection

GPIB Port: (IEEE-488.1) Configurable as talker/listener for computer control and fast data transfer; command language compliant with IEEE-488.2

Centronics Port: Hardcopy interface

PC Card (PCMCIA I/III Ports): Optional for memory cards, flash cards and removable hard disks

Floppy Disk: High density 3.5-inch floppy disk drive (DOS format)

Hardcopy: TIFF and BMP formats available for import to Desktop Publishing programs; printers and plotters: HP DeskJet, HP ThinkJet, QuietJet, LaserJet, PaintJet, and EPSON printers; HP 7400 and 7500 series, or HPGL compatible plotters

➤ Optional internal, high-resolution graphics printer

Output Formats: Binary, or ASCII waveform output compatible with spreadsheets, MATLAB, Mathcad

Auto-calibration: Ensures specified DC and timing accuracy

Temperature: 5 to 40 °C (41 to 104 °F) rated

Humidity: 80 % for temperatures up to 31 °C, decreasing linearly to 50 % relative humidity at 40 °C

Altitude: Up to 2000 m (6560 ft) operating, 40 °C max

Power: 90–250 V AC, 45–66 Hz, 230 W

Battery Backup: Front-panel settings maintained for two years

Dimensions: (HWD) 8.5 x 14.5 x 16.25 inches / 264 x 397 x 453 mm

Weight: 13 kg (28.6 lb.) net, 18.5 kg (40.7 lb.) shipping

Warranty: Three years

Conformity

EMC: EN 50082-1 conformity

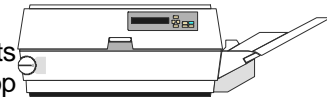
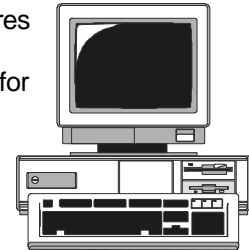



Specifications

Safety: Designed to comply with EN 61010-1; UL and cUL listed, File E 170588: Protection Category I, Installation (Over-Voltage) Category II, Pollution Degree 2
See Declaration of Conformity for further details.

➤ 9384C Series

Signal Capture

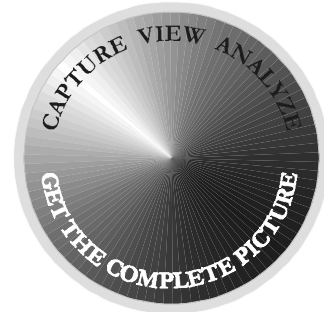

Acquisition System

Bandwidth (- 3 dB):

- @ 50 Ω: DC to 1 GHz
10 mV/div and above
- @ 1 MΩ: DC to 500 MHz typical
at PP005 probe tip
 - 1 GHz FET probe optional

Number of Channels: four

Number of Digitizers: four

Sensitivity:

- 50 Ω: 2 mV/div to 1 V/div, fully variable
- 1 MΩ: 2 mV/div to 10 V/div, fully variable

Scale Factors: Wide range of probe attenuation factors

Offset Range:

- 2.00–4.99 mV/div: ±400 mV
- 5–99 mV/div: ±1 V
- 0.1–1 V/div: ±10 V
- 1–10 V/div: ±100 V (1 MΩ Only)
- ±20 V over the full sensitivity range using AP 020 FET probe

9384C Series					
CHANNELS USED (PEAK DETECT ON/OFF)	MAX SAMPLE RATE	MEMORY PER CHANNEL (IN POINTS)			ACTIVE CHANNELS
		Model			
		C	CM/CTM	CL	
All (Peak Detect OFF)	1 GS/s	100k	500k	2M	All
All (Peak Detect ON)	100 MS/s data	50k data	250k data	1M data	All
	400 MS/s peak	50k peak	250k peak	1M peaks	2.5 ns peak detect
Two Channels Paired (Peak Detect OFF)	2 GS/s	200k	1M	2M	CH 2 + CH 3



Specifications

Four Channels Combined by PP094 Adapter (Peak Detect OFF)	4 GS/s	400k	2M	8M	One (PP094 input)
---	--------	------	----	----	----------------------



Acquisition Modes

DC Accuracy: typically 1% at 10 mV and above

Vertical Resolution: 8 bits

Bandwidth Limiter:

- 25 MHz
- 200 MHz

Input Coupling: AC, DC, GND

Input Impedance: 50 Ω ±1 %, or 1 MΩ//11 pF typical

Max. Input:

- 50 Ω: ±5 V DC
- 1 MΩ: 400 V max (DC + peak AC ≤10 kHz)

Random Interleaved Sampling (RIS): For repetitive signals from 1 ns/div to 2 μs/div

Single shot: For transient and repetitive signals from 1 ns/div (all channels active)

Peak Detect: Captures and displays 2.5 ns glitches and other high-speed events

Sequence: Stores multiple events, time-stamped, in segmented acquisition memories

Deadtime Between Segments: ≈80 μs

Number of Segments Available:

Model			Segments
9384C			2–500
9384CM	9384CTM	9384CL	2–2000

Timebase System

Timebases: Main and up to four Zoom Traces

Time/Div Range: 1 ns/div to 1000 s/div

Clock Accuracy: ≤10 ppm

Interpolator resolution: 10 ps

Roll Mode:

- Ranges 500 ms–1000 s/div
- For >50 000 points: 10–1000 s/div

Triggering System

Modes: Normal, Auto, Single, and Stop

Sources: CH1, CH2, CH3, CH4, Line, Ext, Ext/10; Slope, Level and Coupling able to be set independently

Slope: Positive, Negative

Coupling: AC, DC, HF, LFREJ, HFREJ

Pre-trigger Recording: 0–100 % of full scale adjustable in 1 % increments



SMART Trigger Types

Post-trigger Delay: 0–10 000 divisions adjustable in 0.1 div increments

Holdoff by Time: 10 ns–20 s

Holdoff by Events: 0–99 999 999 events

Internal Trigger Range: ± 5 div

EXT Trigger Max Input:

- 50 Ω ± 1 %: ± 5 V DC (500 mW) or 5 V rms
- 1 M Ω /15 pF: 400 V max. (DC + peak AC ≤ 10 kHz)

EXT Trigger Range: ± 0.5 V (± 5 V with Ext/10)

Trigger Timing: Trigger Date and Time listed in “Memory Status” menu

Signal or Pattern Width: Triggers on width between two limits of between <2.5 ns (1 ns typical) or pulse widths between <2.5 ns and 20 s exclusive

Signal or Pattern Interval: Triggers on interval between two limits of between 10 ns and 20 s

Dropout: Triggers if the input signal drops out for a time-out longer than 25 ns–20 s

State/Edge Qualified: Triggers on any source only if a given state or transition — number of events, time interval — on another source

TV: Selection of both line (up to 1500) and field number (up to 8) for PAL, SECAM, NTSC or nonstandard video

Exclusion Trigger: Triggers only on shorter-than-normal (defined) aberrations

Pattern: Triggers on the logic combination of the five inputs CH 1, CH 2, CH 3, CH 4 and EXT Trigger, where each source can be defined as High, Low or Don't Know and the trigger as the pattern's beginning or end

Autosetup

AUTOSETUP button: Sets timebase, trigger and sensitivity to display wide range of repetitive signals — amplitude 2 mV–40 V; frequency above 50 Hz; duty cycle greater than 0.1%

Autosetup Time: Around two seconds

Vertical Find: Automatically sets sensitivity and offset



Probes

Probe Model: One PP005 probe supplied per channel (10:1, 10 M Ω //11 pF, 500 V max input); FET probes, purchased separately, fully compatible with entire scope series

Probe calibration: Max 1 V into 1 M Ω , 500 mV into 50 Ω , frequency and amplitude programmable, pulse or square wave

able to be selected, rise and fall time 1 ns typical (calibrator also offers trigger or Pass/Fail output)

Signal Viewing

Display

CRT: 12.5 x 17.5 cm (9" diagonal) raster

Resolution: 810 x 696 points

Grids: 1, 2, or 4 grids.

Formats: YT, XY and both together

Graticules: Internally generated; separate intensity control for grids and waveforms

Waveform Style: Vectors, which can be switched on and off, connect individual sample points highlighted as dots

Modes: Normal, XY, Variable or Infinite Persistence

Real-time Clock: Date, hours, minutes, seconds

Vertical Zoom: Up to 5x Vertical Expansion (50x with averaging, up to 80 μ V sensitivity, with optional WP01 Advanced Waveform Math Package)

Horizontal Zoom: Waveforms can be expanded to give 2–2.5 points/div.

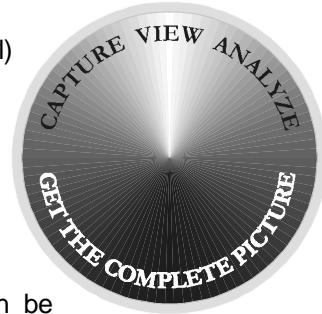

Model		Zoom Factor
9384C		2000x
9384CM	9384CTM	10 000x
9384CL		80 000x

Signal Analysis

Waveform Processing

Processing functions: Add, Subtract, Multiply, Divide, Negate, Identity, Summation Averaging, and Sine x/x; four functions performable at one time

Average: Summed averaging of up to 1000

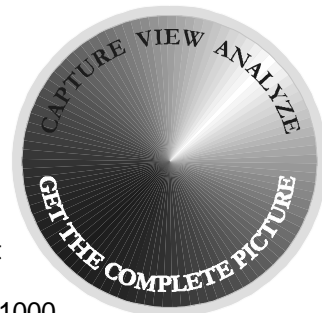



Specifications

waveforms in the basic instrument; up to 10^6 averages possible with optional WP01 Advanced Waveform Math Package



Extrema: Roof, Floor or Envelope values of from 1 to 10^6 waveforms — with WP01 Option

ERES: Low-Pass digital filter provides up to 11 bits vertical resolution; sampled data always available, even when trace turned off; any of above modes usable without destroying data — with WP01 Option

FFT: Spectral Analysis with five windowing functions and FFT averaging, with optional WP02 Spectrum Analysis Package

Histogramming and Trending: With optional WP03 Parameter Analysis Package, in-depth diagnostics on waveform parameters

Internal Memory

Waveform Memory: Up to four 16-bit Memories (M1, M2, M3, M4).

Processing Memory: Up to four 16-bit Waveform Processing Memories (A, B, C, D).

Setup Memory: Four non-volatile memories; optional cards or disks for high-capacity waveform and setup storage

Cursor Measurements

Relative Time: Arrow cursors measure time and voltage differences relative to each other

Relative Voltage: Horizontal bars measure voltage differences up to $\pm 0.2\%$ full-scale in single-grid mode

Absolute Time: Cross-hair marker measures time relative to trigger and voltage with respect to ground

Absolute Voltage: Reference bar measures voltage with respect to ground

Interfacing

Remote Control: By GPIB and RS-232-C for all front-panel controls, internal functions

RS-232-C Port: Asynchronous up to 115.2 Kb/s for computer or terminal control, or printer or plotter connection

GPIB Port: (IEEE-488.1) Configurable as talker/listener for computer control and fast data transfer; command language compliant with IEEE-488.2

Centronics Port: Hardcopy interface

PC Card (PCMCIA II/III Ports): Optional for memory cards, flash cards and removable hard disks

Floppy Disk: High density 3.5-inch floppy disk drive (DOS format)

Hardcopy: TIFF and BMP formats available for import to Desktop

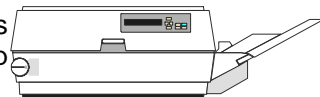
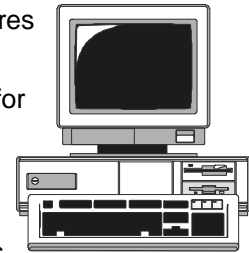
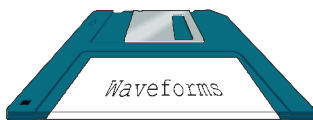

Publishing programs; printers and plotters: HP DeskJet, HP ThinkJet, QuietJet, LaserJet, PaintJet, and EPSON printers; HP 7400 and 7500 series, or HPGL compatible plotters

➤ Optional internal, high-resolution graphics printer

Output Formats: Binary, or ASCII waveform output compatible with spreadsheets, MATLAB, Mathcad

General

Auto-calibration: Ensures specified DC and timing accuracy

Temperature: 5 to 40 °C (41 to 104 °F) rated

Humidity: 80 % for temperatures up to 31 °C, decreasing linearly to 50 % relative humidity at 40 °C

Altitude: Up to 2000 m (6560 ft) operating, 40 °C max

Power: 90–250 V AC, 45–66 Hz, 350 W

Battery Backup: Front-panel settings maintained for two years

Dimensions: (HWD) 8.5 x 14.5 x 16.25 inches / 264 x 397 x 453 mm

Weight: 13 kg (28.6 lb.) net, 18.5 kg (40.7 lb.) shipping

Warranty: Three years

Conformity

EMC: EN 50082-1 conformity

Safety: Designed to comply with EN 61010-1; UL and cUL listed, File E 170588: Protection Category I, Installation (Over-Voltage) Category II, Pollution Degree 2

See Declaration of Conformity for further details.

Enhanced Resolution Filtering

The available sampling rate of LeCroy oscilloscopes is often higher than that required for the analyzed signal's bandwidth. Oversampling, particularly pronounced in the long-memory models, can be used to increase the displayed trace's effective resolution: the ability of the instrument to distinguish closely spaced voltage levels. This is done by filtering the digitized signal using Enhanced Resolution, available in the optional WP02 Advanced Math Package.

Although similar to signal smoothing using a simple moving-average filter, enhanced resolution filtering is more efficient both in terms of bandwidth and the superior passband characteristics that result. And on waveforms with single-shot characteristics, it can be used instead of successive trace averaging.

Advantages

Enhanced resolution filtering improves two important characteristics of the oscilloscope.

Resolution is improved by a fixed amount for each filter. This true increase in resolution occurs whether or not the signal is noisy, or whether a single-shot or repetitive signal.

Signal-to-noise ratio (SNR) is improved in such a way as to be dependent on the form of the noise in the original signal. This is because the enhanced resolution filtering decreases the bandwidth of the signal, therefore filtering out some of the noise.

Implementation

The oscilloscope's set of constant-phase, FIR (Finite Impulse-Response) filters provide fast computation, excellent step response in 0.5 bit steps, and minimum bandwidth reduction for resolution improvements of between 0.5 and 3 bits. Each step corresponds to a bandwidth reduction of a factor of two, allowing easy control of the bandwidth/resolution trade-off. The parameters of the six filters are given in the following table:

FIR Enhanced-Resolution-Filter Parameters		
Resolution Increase (Enhancement)	-3 dB Bandwidth (% Nyquist)	Filter Length (Samples)
0.5	0.5	2
1.0	0.241	5
1.5	0.121	10
2.0	0.058	24
2.5	0.029	51
3.0	0.016	117

With low-pass filters, the actual SNR increase obtained in any particular situation depends on the power spectral density of the noise on the signal. The improvement in SNR corresponds to the improvement in resolution if the noise in the signal is white — that is, if it is evenly distributed across the frequency spectrum. If the noise power is biased towards high frequencies, the SNR improvement will be better than the resolution improvement. Whereas the opposite may be true if the noise is mostly at lower frequencies.

SNR improvement due to the removal of coherent noise signals —feed-through of clock signals, for example — is decided by the fall of the dominant frequency components of the signal in the passband. This is easily ascertained using Spectral Analysis.

The filters have a precisely constant zero phase response. This has two desirable properties. First, the filters do not distort the relative position of different events in the waveform, even if the events' frequency content is different. And second, because the waveforms are stored, the delay normally associated with filtering (between the input and output waveforms) can be exactly compensated during the computation of the filtered waveform.

All the filters have been given exact unity gain at low frequency. Enhanced resolution should thus not cause overflow if the source data is not overflowed. If part of the source trace were to overflow, filtering would be allowed, but the results in the vicinity

of the overflowed data — the filter impulse response length — would be incorrect. This is because in some circumstances an overflow may be a spike of only one or two samples, and the energy in this spike may not be enough to significantly affect the results. It would then not be desirable to disallow the whole trace.

When to Use It?

In general, enhanced resolution is used to replace the averaging function in situations where the data record has a single-shot or slowly repetitive nature and averaging cannot be used.

There are two particular situations in which enhanced resolution is especially useful. One is when the signal is noticeably noisy and measurements of the noise are not required. The signal can be “cleaned up” by using the enhanced resolution function. The other is when — even if the signal is not particularly noisy — high-precision measurements of the waveform are required (when using Expand with high vertical gain, for example). Enhanced resolution will then increase the resolution of the measurements.

The examples on the following pages illustrate how enhanced resolution can be used.

Examples

Low-pass Filtering

This screen shows the spectrum of a square signal before (top grid) and after (bottom grid) enhanced resolution processing. The result clearly illustrates how the filter rejects high-frequency components from the signal. The higher the bit enhancement, the lower the resulting bandwidth.

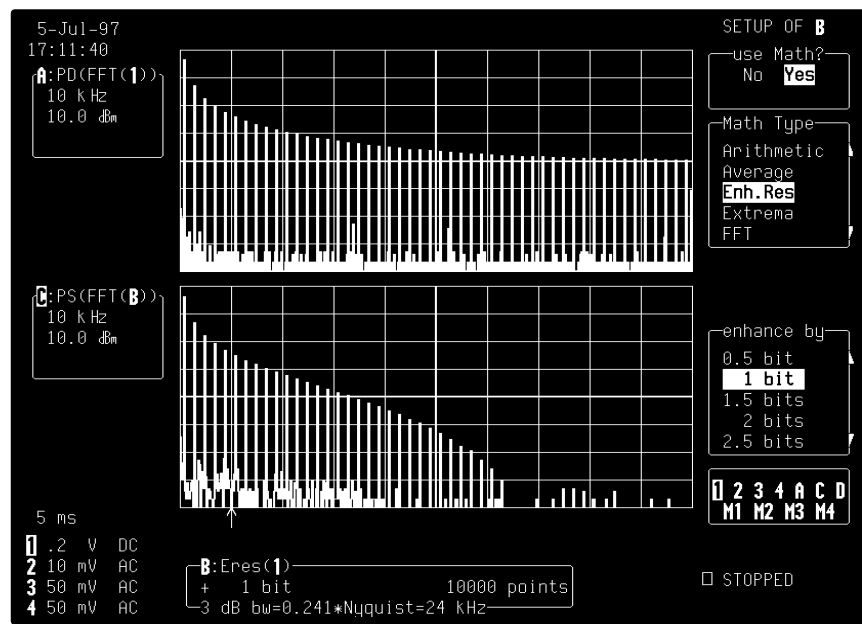

Enhanced Resolution

Increasing Vertical Resolution

In this example the bottom trace has been significantly enhanced by a three-bit enhanced resolution function.

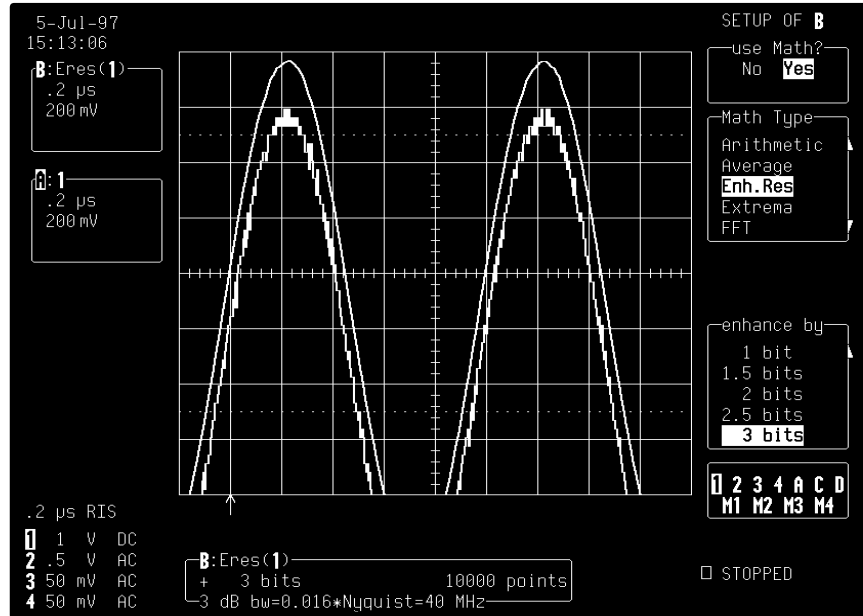

Note: The original signal being highly oversampled, the resulting bandwidth is still high enough for the signal not to be distorted.

Reducing Noise

The following illustration shows the effect of enhanced resolution on a noisy signal. The original trace (top grid) has been processed by a two-bit enhanced resolution filter. The result (bottom grid) shows a "smooth" trace, where most of the noise has been eliminated.

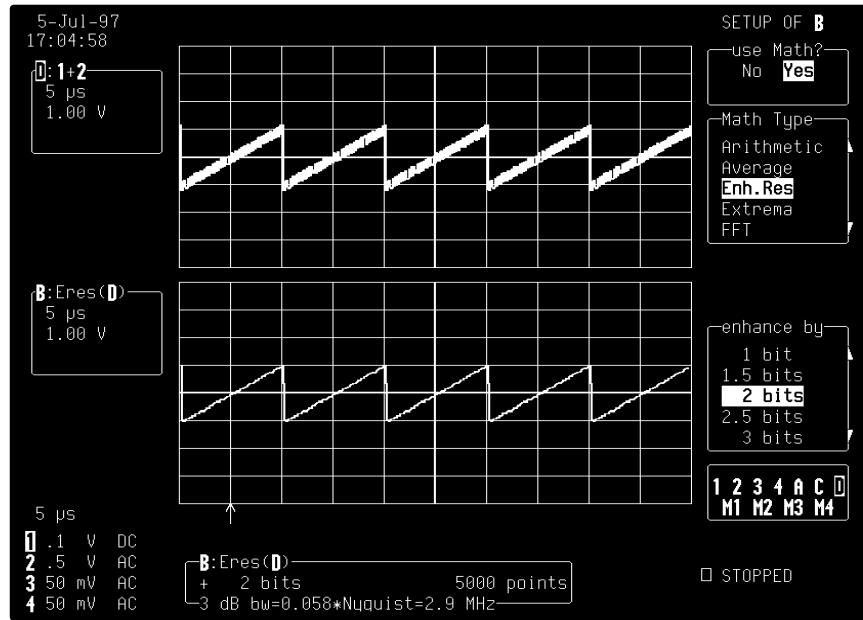

Cautionary Notes

- *The enhanced resolution function can only improve the resolution of a trace; it cannot improve the accuracy or linearity of the original quantization by the eight-bit ADC.*
- *The constraint of good temporal response excludes the use of maximally-flat filters. The pass-band will therefore cause signal attenuation for signals near the cut-off frequency. The highest frequencies passed may be slightly attenuated. The frequency response of a typical enhanced resolution filter (the 2-bit enhancement filter) is illustrated below, indicating the -3 dB cut-off frequency of 5.8% of the Nyquist frequency.*
- *The filtering must be performed on finite record lengths: data will be lost at the start and end of the waveform, so that the trace becomes slightly shorter after filtering.*
- *The number of samples lost is exactly equal to the length of the impulse response of the filter used, and thus varies between two and 117 samples. Owing to the oscilloscope's very long waveform memories, this loss — just 0.2% of a 50 000 point trace — is not normally noticed. However, it is possible to demand filtering on a record so short, there would be no data output, and in this case the scope will not allow filtering.*

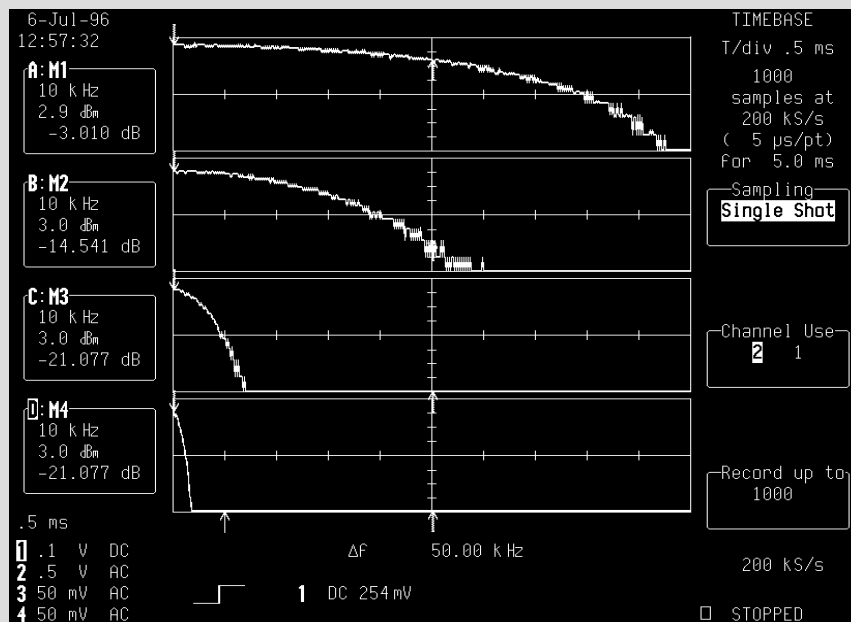

When and How to Use FFT

The WP02 Spectral Analysis package, with FFT (Fast Fourier Transform), reveals signal characteristics not visible in the time domain and adds the power of frequency domain analysis to your oscilloscope. FFT converts a time domain waveform into frequency domain spectra similar to those of a spectrum analyzer, but with important differences and added benefits.

Why Use FFT?

For a large class of signals, greater insight can be gained by looking at spectral representation rather than time description. Signals encountered in the frequency response of amplifiers, oscillator phase noise and those in mechanical vibration analysis — to mention just some applications — are easier to observe in the frequency domain.

If sampling is done at a rate fast enough to faithfully approximate the original waveform (usually five times the highest frequency component in the signal), the resulting discrete data series will uniquely describe the analog signal.

This is of particular value when dealing with transient signals because, unlike FFT, conventional swept spectrum analyzers cannot handle them.

Theory Behind FFT

Spectral analysis theory assumes that the signal for transformation be of infinite duration. Since no physical signal can meet this condition, a useful assumption for reconciling theory and practice is to view the signal as consisting of an infinite series of replica of itself. These replica are multiplied by a rectangular window (the display grid) that is zero outside of the observation grid.

- ***For an explanation of FFT terms: see the Glossary on page C-17***
- ***Using FFT Functions: see page C-9***
- ***FFT Algorithms: page C-14***



Figure C-1 shows spectra of a swept triangular wave. Discontinuities at the edges of the wave produce leakage, an effect clearly visible in Trace A, which was computed with a rectangular window, but less pronounced in the Von Hann window in Trace B (see below for leakage and window-type explanations). Histogramming in Trace C tracks the spread of the first harmonic.

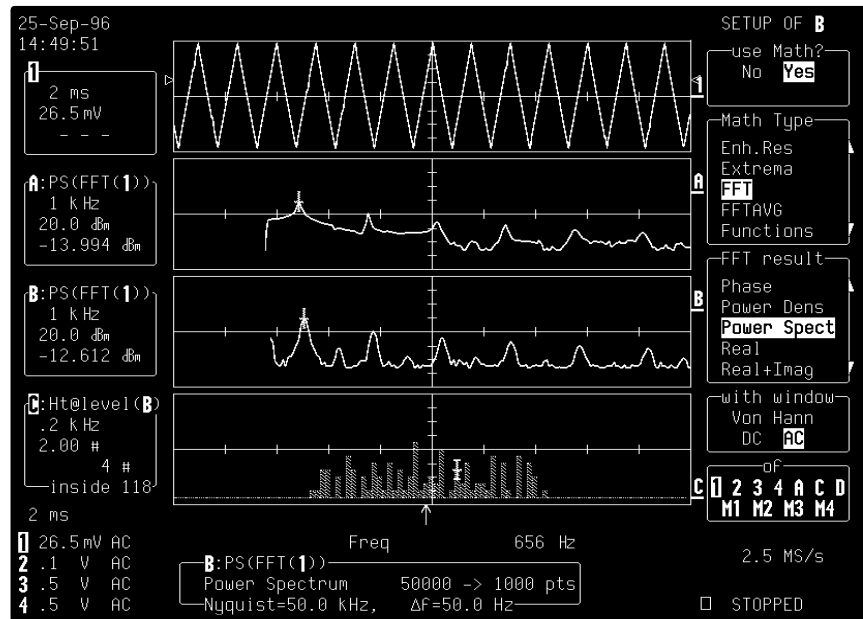

Figure C-1

Slicing the waveform in the fashion described above is tantamount to diluting the spectral energy in an infinite number of side lobes, which correspond to multiples of the frequency resolution Δf (Fig. C-2). The observation window or capture time T determines the frequency resolution of the FFT ($\Delta f=1/T$). Whereas the sampling period and the record length set the maximum frequency span that can be obtained ($f_{Nyq}=\Delta f*N/2$).

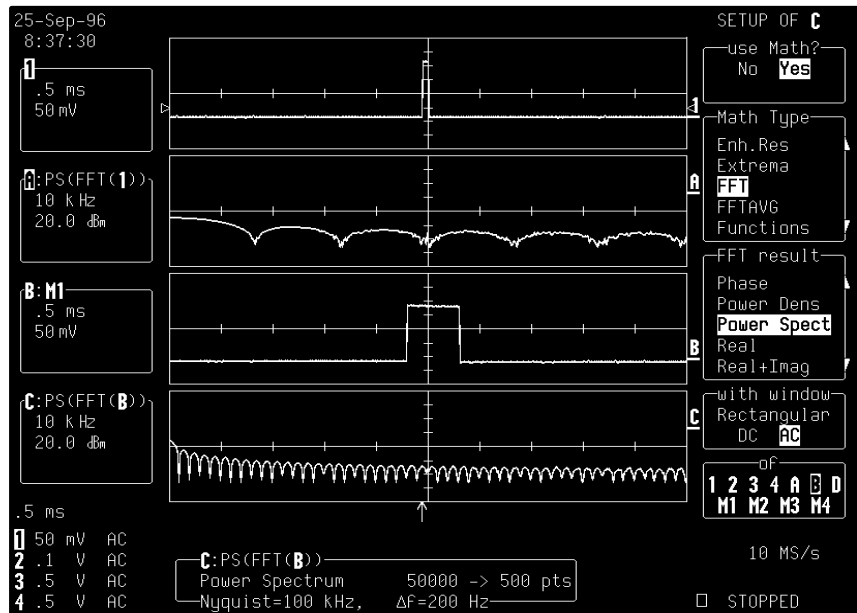

Figure C-2

An FFT operation on an N point time-domain signal may thus be compared to passing the signal through a comb filter consisting of a bank of N/2 filters. All the filters have the same shape and width and are centered at N/2 discrete frequencies. Each filter collects the signal energy that falls into the immediate neighborhood of its center frequency. Thus it can be said that there are N/2 frequency bins. The distance in Hz between the center frequencies of two neighboring bins is always the same: Δf .

Power (Density) Spectrum

Because of the linear scale used to show magnitudes, lower amplitude components are often hidden by larger components. In addition to the functions offering magnitude and phase representations, the FFT option offers power density and power spectrum density functions, selected from the "FFT result" menu shown in the figures. These latter functions are even better suited for characterizing spectra. The power spectrum (V^2) is the square of the magnitude spectrum (0 dB m corresponds to voltage equivalent to 1 mW into 50 Ω .) This is the



representation of choice for signals containing isolated peaks — periodic signals, for instance.

The power density spectrum (V^2/Hz) is the power spectrum divided by the equivalent noise bandwidth of the filter in Hz associated with the FFT calculation. This is best employed for characterizing broad-band signals such as noise.

Memory for FFT

The amount of acquisition memory available will determine the maximum range (Nyquist frequency) over which signal components can be observed. Consider the problem of determining the length of the observation window and the size of the acquisition buffer if a Nyquist rate of 500 MHz and a resolution of 10 kHz are required. To obtain a resolution of 10 kHz, the acquisition time must be at least:

$$T = 1/\Delta f = 1/10 \text{ kHz} = 100 \mu\text{s}.$$

For a digital oscilloscope with a memory of 100 k, the highest frequency that can be analyzed is:

$$\Delta f \times N/2 = 10 \text{ kHz} \times 100 \text{ k}/2 = 500 \text{ MHz}.$$

FFT Pitfalls to Avoid

Take care to ensure that signals are correctly acquired: improper waveform positioning within the observation window produces a distorted spectrum. The most common distortions can be traced to insufficient sampling, edge discontinuities, windowing or the “picket fence” effect.

Because the FFT acts like a bank of bandpass filters centered at multiples of the frequency resolution, components that are not exact multiples of that frequency will fall within two consecutive filters. This results in an attenuation of the true amplitude of these components.

Picket Fence and Scallop The highest point in the spectrum can be 3.92 dB lower when the source frequency is halfway between two discrete frequencies. This variation in spectrum magnitude is the picket fence effect. And the corresponding attenuation loss is referred to as scallop loss. LeCroy scopes automatically correct for the scallop effect, ensuring that the magnitude of the spectra lines correspond to their true values in the time domain.

If a signal contains a frequency component above Nyquist, the spectrum will be aliased, meaning that the frequencies will be folded back and spurious. Spotting aliased frequencies is often difficult, as the aliases may ride on top of real harmonics. A simple way of checking is to modify the sample rate and verify whether the frequency distribution changes.

Leakage

FFT assumes that the signal contained within the time grid is replicated endlessly outside the observation window. Therefore if the signal contains discontinuities at its edges, pseudo-frequencies will appear in the spectral domain, distorting the real spectrum. When the start and end phase of the signal differ, the signal frequency falls within two frequency cells broadening the spectrum.

This effect is illustrated in Figure C-1. Because the display does not contain an integral number of periods, the spectrum displayed in Trace B does not reveal sharp frequency components. Intermediate components exhibit a lower and broader peak. The broadening of the base, stretching out in many neighboring bins, is termed leakage. Cures for this are to ensure that an integral number of periods is contained within the display grid or that no discontinuities appear at the edges. Another is to use a window function to smooth the edges of the signal.

Choosing a Window

The choice of a spectral window is dictated by the signal's characteristics. Weighting functions control the filter response shape and affect noise bandwidth as well as side-lobe levels. Ideally, the main lobe should be as narrow and flat as possible to effectively discriminate all spectral components, while all side lobes should be infinitely attenuated.

Chosen from the "with window" menu, the window type defines the bandwidth and shape of the equivalent filter to be used in the FFT processing.

In the same way as one would choose a particular camera lens for taking a picture, some experimenting is generally necessary to determine which window is most suitable. However, the following general guidelines should help (see *page C-11 for window types*).



Rectangular windows provide the highest frequency resolution and are thus useful for estimating the type of harmonics present in the signal. Because the rectangular window decays as a sinc/x function in the spectral domain, slight attenuation will be induced. Alternative functions with less attenuation — Flat-top and Blackman-Harris — provide maximum amplitude at the expense of frequency resolution. Whereas, Hamming and von Hann are good for general purpose use with continuous waveforms.

Improving Dynamic Range Enhanced resolution (see *Appendix B*) uses a low pass filtering technique that can potentially provide for three additional bits (18 dBs) if the signal noise is uniformly distributed (white). Low pass filtering should be considered when high frequency components are irrelevant. A distinct advantage of this technique is that it works for both repetitive and transient signals. The SNR increase is conditioned by the cut-off frequency of the Eres low pass filter and the noise shape (frequency distribution).

LeCroy digital oscilloscopes employ FIR digital filters so that a constant phase shift is maintained. The phase information is therefore not distorted by the filtering action.

Spectral Power Averaging Even greater dynamic-range improvement is obtained on signals showing periodicity. Moreover, the range can be increased without sacrificing frequency response. The LeCroy oscilloscope being used is equipped with accumulation buffers 32 bits wide to prevent overflows.

Spectral power averaging is useful when the signal varies in time and the mean power of the signal needs to be estimated. Typical applications include noise and pseudo-random noise. Whereas time averaging ignores phase information, spectral averaging tracks magnitude as well as phase information. It is thus a superior estimator. And the improvement is typically proportional to the square root of the number of averages. For instance, averaging white noise at full scale over 10 sweeps yields a typical improvement of nearly 20 dBs.

Using FFT

Spectral power averaging is the technique of choice when determining the frequency response of passive networks such as filters. Figures 3 and 4 show the transfer functions of a low pass filter with a 3 dB cutoff of 11 MHz obtained by exciting the filter with a white noise source (Fig. C-3) and a sine swept generator (Fig. C-4). Both techniques give substantially the same results. The choice of method is governed by the availability of an adequate generating source.

The spectra of single time-domain waveforms can be computed and displayed to obtain power averages obtained over as many as 50 000 spectra.

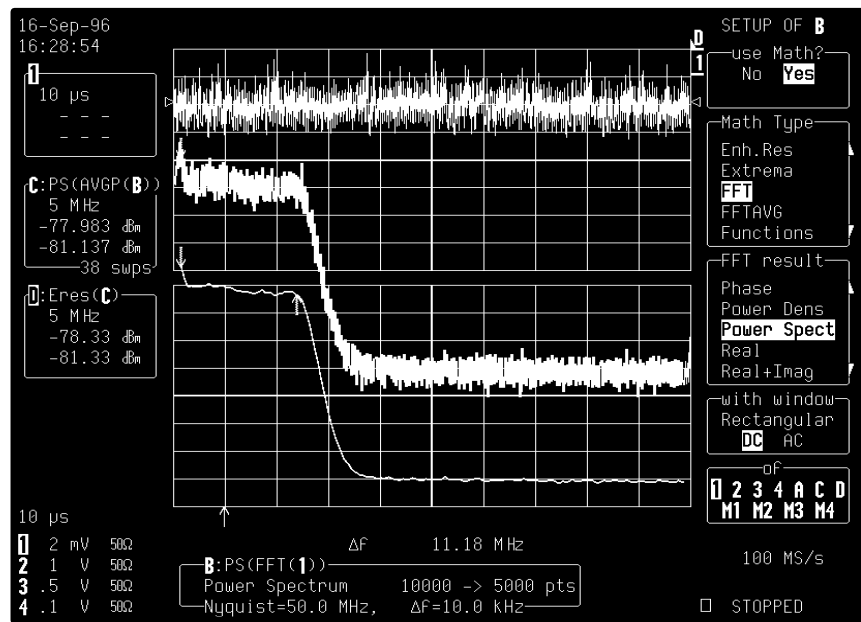

Figure C-3

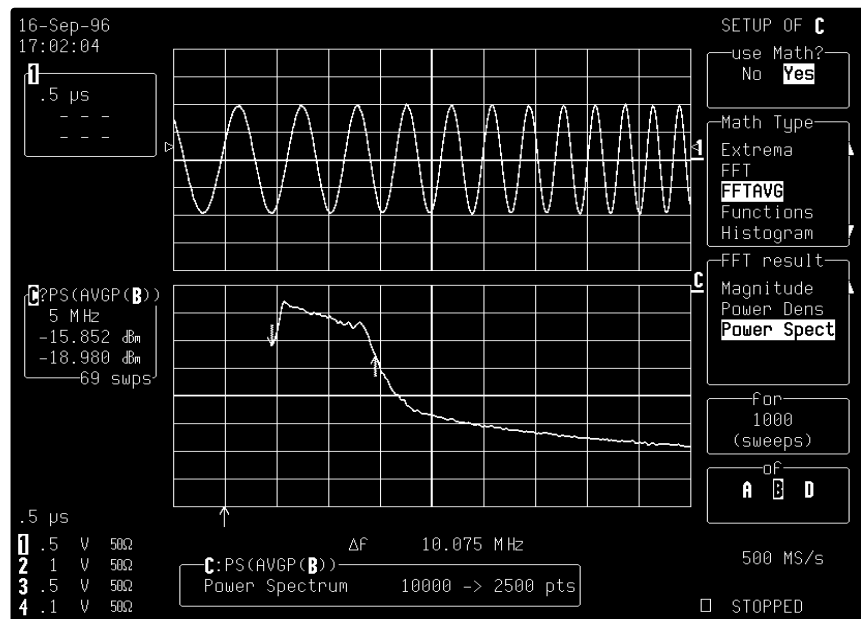

Figure C-4

Overall...

Because of its versatility, FFT analysis has become a popular analysis tool. However, some care must be taken with it. In most instances, incorrect positioning of the signal within the display grid will significantly alter the spectrum. Effects such as leakage and aliasing that distort the spectrum must be understood if meaningful conclusions are to be arrived at when using FFT.

An effective way to reduce these effects is to maximize the acquisition record length. Record length directly conditions the effective sampling rate of the scope and therefore determines the frequency resolution and span at which spectral analysis can be carried out.

Using FFT Functions

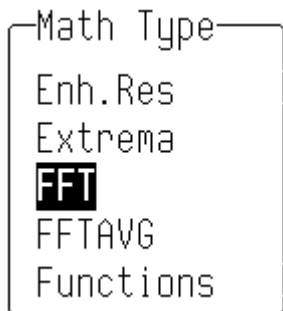

Select “FFT” from the “Math Type” menu (see *Chapter 10 for a full description of math and waveform processing menus*). Spectra displayed with a linear frequency axis running from zero to the Nyquist frequency are shown at the right-hand edge of the trace. The frequency scale factors (Hz/div) are in a 1–2–5 sequence.

The processing equation is displayed at the bottom of the screen, together with the three key parameters that characterize an FFT spectrum. These are:

1. Transform Size N (number of input points)
2. Nyquist frequency (= ½ sample rate), and
3. Frequency Increment, Δf , between two successive points of the spectrum.

These parameters are related as:

$$\text{Nyquist frequency} = \Delta f * N/2.$$

Where: $\Delta f = 1/T$, and where T is the duration of the input waveform record ($10 * \text{time/div}$). The number of output points is equal to $N/2$.

Note on Maximum Points: FFT spectra are computed over the entire source time-domain waveform. This limits the number of points used for FFT processing. If the input waveform contains more points than the selected maximum (in “for Math use max points”, they are decimated before FFT processing. But if it has fewer, all points are used.



The following selections can be made using the “FFT result” menu.

Phase

Measured with respect to a cosine whose maximum occurs at the left-hand edge of the screen, at which point it has 0°. Similarly, a positive-going sine starting at the left-hand edge of the screen has a -90° phase. (Displayed in degrees.)

Power Density

The signal power normalized to the bandwidth of the equivalent filter associated with the FFT calculation. The power density is suitable for characterizing broad-band noise. (It is displayed on a logarithmic vertical axis calibrated in dBm.)

Power Spectrum

The signal power (or magnitude) represented on a logarithmic vertical scale: 0 dBm corresponds to the voltage (0.316 V peak) which is equivalent to 1 mW into 50 Ω. The power spectrum is suitable for characterizing spectra which contain isolated peaks. (dBm.)

Magnitude

The peak signal amplitude represented on a linear scale. (Same units as input signal.)

Real, Real + Imaginary, Imaginary

These represent the complex result of the FFT processing. (Same units as input signal.)

Windows

Chosen using the “with window” menu, the window type defines the bandwidth and shape of the filter to be used in the FFT processing (see the table on page C–17 for these filters’ parameters). When “AC” is selected from the same menu, the DC component of the input signal is forced to zero prior to the FFT processing. This improves the amplitude resolution, especially when the input has a large DC component.

Window Type	Applications and Limitations
Rectangular	Normally used when the signal is transient — completely contained in the time-domain window — or known to have a fundamental frequency component that is an integer multiple of the fundamental frequency of the window. Signals other than these types will show varying amounts of spectral leakage and scallop loss, corrected by selecting another type of window.
Hanning (Von Hann)	Reduce leakage and improve amplitude accuracy. However, frequency resolution is also reduced.
Hamming	Reduce leakage and improve amplitude accuracy. However, frequency resolution is also reduced.
Flat Top	This window provides excellent amplitude accuracy with moderate reduction of leakage, but also at the loss of frequency resolution.
Blackman–Harris	It reduces the leakage to a minimum, but again along with reduced frequency resolution.

FFT Power Average

A function can be defined as the power average of FFT spectra computed by another function (see page C–6). Choose “FFTAVG” from the “Math Type” Menu, and “Power Spect” from “FFT Result”.

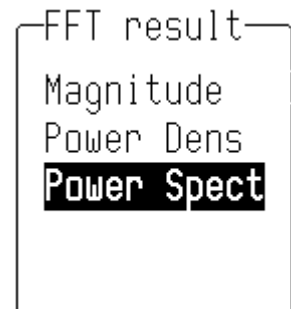
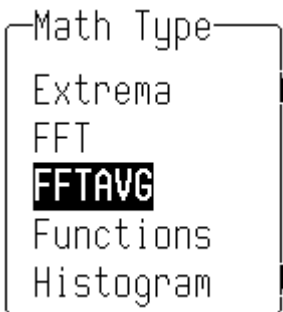

Additional Processing

Other waveform processing functions, such as Averaging and Arithmetic, can be applied to waveforms before FFT processing is performed. Time-domain averaging prior to FFT, for example, can be used if a stable trigger is available to reduce random noise in the signal.

Note:

- *To increase the FFT frequency range, the Nyquist frequency, raise the effective sampling frequency by increasing the maximum number of points or using a faster time base.*
- *To increase the FFT frequency resolution, increase the length of the time-domain waveform record by using a slower time base.*

Memory Status

When FFT is used, the field beneath the grid displays parameters of the waveform descriptor, including number of points, horizontal and vertical scale factors and units.

```
C:PS(AVGP(B))
Power Spectrum      10000 -> 2500 pts
```

Using Cursors with FFT

For reading the amplitude and frequency of a data point, the Absolute Time cursor can be moved into the frequency domain by going beyond the right-hand edge of a time-domain waveform.

The Relative Time cursors can be moved into the frequency domain to simultaneously indicate the frequency difference and the amplitude difference between two points on each frequency-domain trace.

The Absolute Voltage cursor reads the absolute value of a point in a spectrum in the appropriate units, and the *Relative Voltage* cursors indicate the difference between two levels on each trace

Error Messages

One of these FFT-related error messages may be displayed at the top of the screen.

Error Messages	
Message	Meaning
“Incompatible input record type”	FFT power average is defined only on a function defined as FFT.
“Horizontal units don't match”	FFT of a frequency-domain waveform is not available.
“FFT source data zero filled”	If there are invalid data points in the source waveform (at the beginning or at the end of the record), these are replaced by zeros before FFT processing.
“FFT source data over/underflow”	The source waveform data has been clipped in amplitude, either in the acquisition — gain too high or inappropriate offset — or in previous processing. The resulting FFT contains harmonic components which would not be present in the unclipped waveform. The settings defining the acquisition or processing should be changed to eliminate the over/underflow condition.
“Circular computation”	A function definition is circular (i.e. the function is its own source, indirectly via another function or expansion). One of the definitions should be changed.

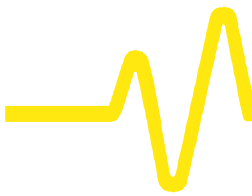

FFT Algorithms

A summary of the algorithms used in the oscilloscope's FFT computation is given here in the form of seven steps:

1. If the maximum number of points is smaller than the source number of points, the source waveform data are decimated prior to the FFT. These decimated data extend over the full length of the source waveform. The resulting sampling interval and the actual transform size selected provide the frequency scale factor in a 1–2–5 sequence.
2. The data are multiplied by the selected window function.
3. FFT is computed, using a fast implementation of the DFT (Discrete Fourier Transform):

$$X_n = \frac{1}{N} \sum_{k=0}^{k=N-1} x_k \times W^{nk},$$

where: x_k is a complex array whose real part is the modified source time domain waveform, and whose imaginary part is 0; X_n is the resulting complex frequency-domain waveform; $W = e^{-2\pi j/N}$; and N is the number of points in x_k and X_n .

The generalized FFT algorithm, as implemented here, works on N , which need *not* be a power of 2.

4. The resulting complex vector X_n is divided by the coherent gain of the window function, in order to compensate for the loss of the signal energy due to windowing. This compensation provides accurate amplitude values for isolated spectrum peaks.
5. The real part of X_n is symmetric around the Nyquist frequency, i.e.

$$R_n = R_{N-n},$$

while the imaginary part is asymmetric, i.e.

$$I_n = -I_{N-n}.$$

The energy of the signal at a frequency n is distributed equally between the first and the second halves of the spectrum; the energy at frequency 0 is completely contained in the 0 term.

The first half of the spectrum (Re, Im), from 0 to the Nyquist frequency is kept for further processing and doubled in amplitude:

$$R'_n = 2 \cdot R_n \quad 0 \leq n < N/2$$

$$I'_n = 2 \cdot I_n \quad 0 \leq n < N/2.$$

6. The resultant waveform is computed for the spectrum type selected.

If “Real”, “Imaginary”, or “Real + Imaginary” is selected, no further computation is needed. The appropriate part of the complex result is given as the result (R'_n or I'_n or $R'_n + jI'_n$, as defined above).

If “Magnitude” is selected, the magnitude of the complex vector is computed as:

$$M_n = \sqrt{R_n'^2 + I_n'^2}.$$

Steps 1–6 lead to the following result:

An AC sine wave of amplitude 1.0 V with an integral number of periods N_p in the time window, transformed with the rectangular window, results in a fundamental peak of 1.0 V magnitude in the spectrum at frequency $N_p \times \Delta f$. However, a DC component of 1.0 V, transformed with the rectangular window, results in a peak of 2.0 V magnitude at 0 Hz.

The waveforms for the other available spectrum types are computed as follows:

$$\text{Phase: angle} = \arctan (I_n/R_n) \quad M_n > M_{min}$$

$$\text{angle} = 0 \quad M_n \leq M_{min}.$$

Where M_{min} is the minimum magnitude, fixed at about 0.001 of the full scale at any gain setting, below which the angle is not well defined.

The dBm Power Spectrum:

$$dBm PS = 10 \times \log_{10} \left(\frac{M_n^2}{M_{ref}^2} \right) = 20 \times \log_{10} \left(\frac{M_n}{M_{ref}} \right)$$

where $M_{ref} = 0.316$ V (that is, 0 dBm is defined as a sine wave of 0.316 V peak or 0.224 V RMS, giving 1.0 mW into 50Ω).

The dBm Power Spectrum is the same as dBm Magnitude, as suggested in the above formula.

dBm Power Density:

$$dBm PD = dBm PS - 10 \times \log_{10} (ENBW \times \Delta f)$$

where $ENBW$ is the equivalent noise bandwidth of the filter corresponding to the selected window, and Δf is the current frequency resolution (bin width).

- The FFT Power Average takes the complex frequency-domain data R'_n and I'_n for each spectrum generated in Step 5, and computes the square of the magnitude:

$$M_n^2 = R_n'^2 + I_n'^2,$$

then sums M_n^2 and counts the accumulated spectra. The total is normalized by the number of spectra and converted to the selected result type using the same formulae as are used for the Fourier Transform.

Glossary

Defines the terms frequently used in FFT spectrum analysis and relates them to the oscilloscope.

Aliasing

If the input signal to a sampling acquisition system contains components whose frequency is greater than the Nyquist frequency (half the sampling frequency), there will be less than two samples per signal period. The result is that the contribution of these components to the sampled waveform is indistinguishable from that of components below the Nyquist frequency. This is **aliasing**.

The timebase and transform-size should be selected so that the resulting Nyquist frequency is higher than the highest significant component in the time-domain record.

Coherent Gain

The normalized coherent gain of a filter corresponding to each window function is 1.0 (0 dB) for a rectangular window and less than 1.0 for other windows. It defines the loss of signal energy due to the multiplication by the window function. This loss is compensated in the oscilloscope. This table lists the values for the implemented windows.

Window Frequency-Domain Parameters				
Window Type	Highest Side Lobe (dB)	Scallop Loss (dB)	ENBW (bins)	Coherent Gain (dB)
Rectangular	-13	3.92	1.0	0.0
von Hann	-32	1.42	1.5	-6.02
Hamming	-43	1.78	1.37	-5.35
Flat Top	-44	0.01	2.96	-11.05
Blackman-Harris	-67	1.13	1.71	-7.53

**ENBW**

Equivalent Noise BandWidth (ENBW) is the bandwidth of a rectangular filter (same gain at the center frequency), equivalent to a filter associated with each frequency bin, which would collect the same power from a white noise signal. In the table on the previous page, the ENBW is listed for each window function implemented and is given in bins.

Filters

Computing an N-point FFT is equivalent to passing the time-domain input signal through N/2 filters and plotting their outputs against the frequency. The spacing of filters is $\Delta f = 1/T$ while the bandwidth depends on the window function used (see Frequency bins).

Frequency bins

The FFT algorithm takes a discrete source waveform, defined over N points, and computes N complex Fourier coefficients, which are interpreted as harmonic components of the input signal.

For a real source waveform (imaginary part equals 0), there are only N/2 independent harmonic components.

An FFT corresponds to analyzing the input signal with a bank of N/2 filters, all having the same shape and width, and centered at N/2 discrete frequencies. Each filter collects the signal energy that falls into the immediate neighborhood of its center frequency, and thus it can be said that there are N/2 “frequency bins”.

The distance in hertz between the center frequencies of two neighboring bins is always:

$$\Delta f = 1/T,$$

where T is the duration of the time-domain record in seconds.

The width of the main lobe of the filter centered at each bin depends on the window function used. The rectangular window has a nominal width at 1.0 bin. Other windows have wider main lobes (see *table*).

Frequency Range

The range of frequencies computed and displayed is 0 Hz (displayed at the left-hand edge of the screen) to the Nyquist frequency (at the rightmost edge of the trace).

Frequency Resolution	<p>In a simple sense, the frequency resolution is equal to the bin width Δf. That is, if the input signal changes its frequency by Δf, the corresponding spectrum peak will be displaced by Δf. For smaller changes of frequency, only the shape of the peak will change.</p> <p>However, the effective frequency resolution (i.e. the ability to resolve two signals whose frequencies are almost the same) is further limited by the use of window functions. The ENBW value of all windows other than the rectangular is greater than Δf and the bin width. <i>The table on page C-17 lists the ENBW values for the implemented windows.</i></p>
Leakage	<p>In the power spectrum of a sine wave with an integral number of periods in the (rectangular) time window (i.e. the source frequency equals one of the bin frequencies), the spectrum contains a sharp component whose value accurately reflects the source waveform's amplitude. For intermediate input frequencies this spectral component has a lower and broader peak.</p> <p>The broadening of the base of the peak, stretching out into many neighboring bins is termed <i>leakage</i>. It is due to the relatively high side lobes of the filter associated with each frequency bin.</p> <p>The filter side lobes and the resulting leakage are reduced when one of the available window functions is applied. The best reduction is provided by the Blackman-Harris and Flat Top windows. However, this reduction is offset by a broadening of the main lobe of the filter.</p>
Number of Points	<p>FFT is computed over the number of points (Transform Size) whose upper bounds are the source number of points, and by the maximum number of points selected in the menu. FFT generates spectra of $N/2$ output points.</p>
Nyquist Frequency	<p>The Nyquist frequency is equal to one half of the effective sampling frequency (after the decimation): $\Delta f \times N/2$.</p>
Picket Fence Effect	<p>If a sine wave has a whole number of periods in the time domain record, the power spectrum obtained with a rectangular window will have a sharp peak, corresponding exactly to the frequency and amplitude of the sine wave. Otherwise the spectrum peak with a rectangular window will be lower and broader.</p>



The highest point in the power spectrum can be 3.92 dB lower (1.57 times) when the source frequency is halfway between two discrete bin frequencies. This variation of the spectrum magnitude is called the *picket fence effect* (the loss is called the scallop loss).

All window functions compensate this loss to some extent, but the best compensation is obtained with the Flat Top window.

Power Spectrum

The power spectrum (V^2) is the square of the magnitude spectrum.

The power spectrum is displayed on the dBm scale, with 0 dBm corresponding to:

$$V_{\text{ref}}^2 = (0.316 V_{\text{peak}})^2,$$

where V_{ref} is the peak value of the sinusoidal voltage, which is equivalent to 1 mW into 50 Ω .

Power Density Spectrum The power density spectrum (V^2/Hz) is the power spectrum divided by the equivalent noise bandwidth of the filter in hertz. The power density spectrum is displayed on the dBm scale, with 0 dBm corresponding to ($V_{\text{ref}}^2/\text{Hz}$).

Sampling Frequency

The time-domain records are acquired at sampling frequencies dependent on the selected time base. Before the FFT computation, the time-domain record may be decimated. If the selected maximum number of points is lower than the source number of points, the effective sampling frequency is reduced. The effective sampling frequency equals twice the Nyquist frequency.

Scallop Loss

Loss associated with the picket fence effect.

Window Functions

All available window functions belong to the sum of cosines family with one to three non-zero cosine terms:

$$W_k = \sum_{m=0}^{m=M-1} a_m \cos \left(\frac{2 p k}{N} m \right) \quad 0 \leq k < N,$$

where: $M = 3$ is the maximum number of terms, a_m are the coefficients of the terms, N is the number of points of the decimated source waveform, and k is the time index.

FFT Glossary

The following table lists the coefficients a_m . The window functions seen in the time domain are symmetric around the point $k = N/2$.

Coefficients Of Window Functions			
Window Type	a0	a1	a2
Rectangular	1.0	0.0	0.0
von Hann	0.5	-0.5	0.0
Hamming	0.54	-0.46	0.0
Flat-Top	0.281	-0.521	0.198
Blackman-Harris	0.423	-0.497	0.079

- Appendix C References**
- Bergland, G.D.**, *A Guided Tour of the Fast Fourier Transform*, IEEE Spectrum, July 1969, pp. 41–52.
A general introduction to FFT theory and applications.
- Brigham, E.O.**, *The Fast Fourier Transform*, Prentice Hall, Inc., Englewood Cliffs, N.J., 1974.
Theory, applications and implementation of FFT. Includes discussion of FFT algorithms for N not a power of 2.
- Harris, F.J.**, *On the Use of Windows for Harmonic Analysis with the Discrete Fourier Transform*, Proceedings of the IEEE, vol. 66, No. 1, January 1978, pp. 51–83.
Classic paper on window functions and their figures of merit, with many examples of windows.
- Ramirez, R.W.**, *The FFT Fundamentals and Concepts*, Prentice Hall, Inc., Englewood Cliffs, N.J., 1985.
Practice-oriented, many examples of applications.



Parameters and How They Work

In this Appendix, a general explanation of how the instrument's standard parameters are computed (see *below*) is followed by a table listing, defining and describing those parameters (page D-5).

Determining Top and Base Lines

Proper determination of the *top* and *base* reference lines is fundamental for ensuring correct parameter calculations. The analysis begins by computing a histogram of the waveform data over the time interval spanned by the left and right time cursors. For example, the histogram of a waveform transitioning in two states will contain two peaks (Fig. D-1). The analysis will attempt to identify the two clusters that contain the largest data density. Then the most probable state (centroids) associated with these two clusters will be computed to determine the *top* and *base* reference levels: the *top* line corresponds to the top and the *base* line to the bottom centroid.

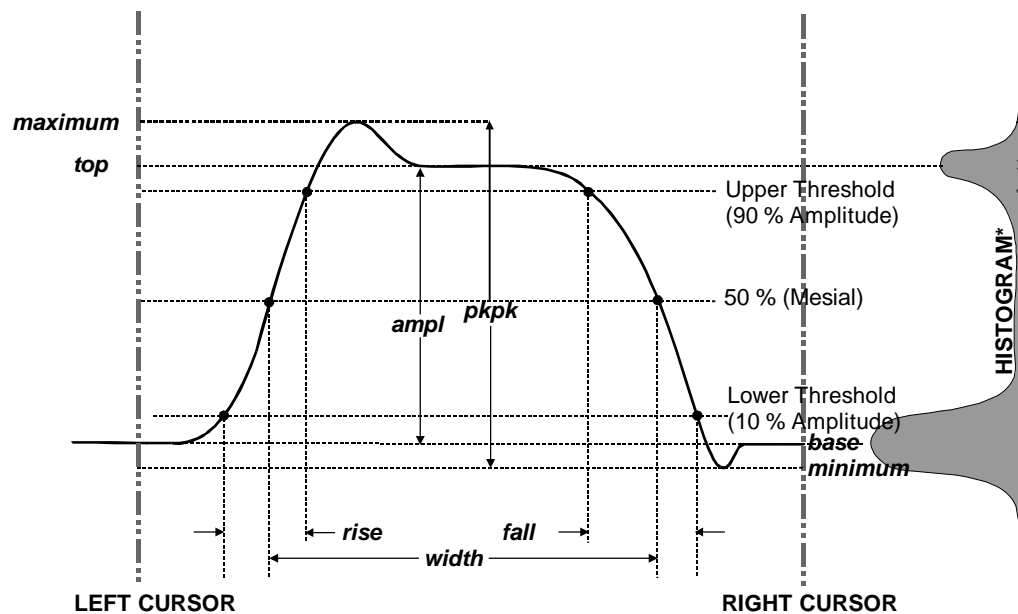
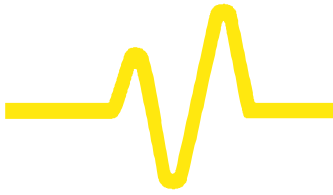

Figure D-1



Determining Rise and Fall Times

Once *top* and *base* are estimated, calculation of the *rise* and *fall* times is easily done (*Fig. 1*). The 90 % and 10 % threshold levels are automatically determined by the oscilloscope, using the amplitude (*amp*) parameter.

Threshold levels for *rise* or *fall* time can also be selected using absolute or relative settings (*r@level*, *f@level*). If absolute settings are chosen, the *rise* or *fall* time is measured as the time interval separating the two crossing points on a rising or falling edge. But when relative settings are chosen, the vertical interval spanned between the *base* and *top* lines is subdivided into a percentile scale (base = 0 %, top = 100 %) to determine the vertical position of the crossing points.

The time interval separating the points on the rising or falling edges is then estimated to yield the rise or fall time. These results are averaged over the number of transition edges that occur within the observation window.

Rising Edge Duration	$\frac{1}{Mr} \sum_{i=1}^{Mr} (Tr_i^{90} - Tr_i^{10})$
Falling Edge Duration	$\frac{1}{Mf} \sum_{i=1}^{Mf} (Tf_i^{10} - Tf_i^{90})$
Where <i>Mr</i> is the number of leading edges found, <i>Mf</i> the number of trailing edges found, Tr_i^x the time when rising edge <i>i</i> crosses the x % level, and Tf_i^x the time when falling edge <i>i</i> crosses the x % level.	

Determining Time Parameters

Time parameter measurements such as *width*, *period* and *delay* are carried out with respect to the mesial reference level (*Fig. D-2*), located halfway (50 %) between the top and base reference lines.

Time-parameter estimation depends on the number of cycles included within the observation window. If the number of cycles is not an integer, parameter measurements such as *rms* or *mean* will be biased.

Parameter Measurement

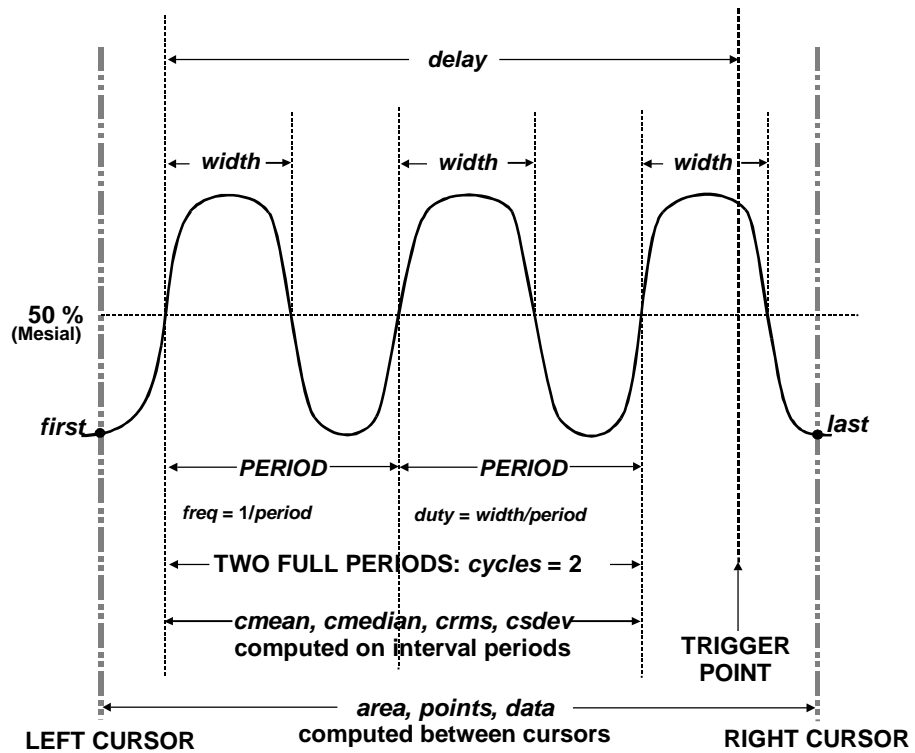

Figure D-2

To avoid these bias effects, the instrument uses cyclic parameters, including *crms* and *cmean*, that restrict the calculation to an integer number of cycles.

Determining Differential Time Measurements

The oscilloscope enables accurate differential time measurements between two traces — for example, propagation, setup and hold delays (Fig. D-3).

Parameters such as $Dc2d\pm$ require the transition polarity of the clock and data signals to be specified.

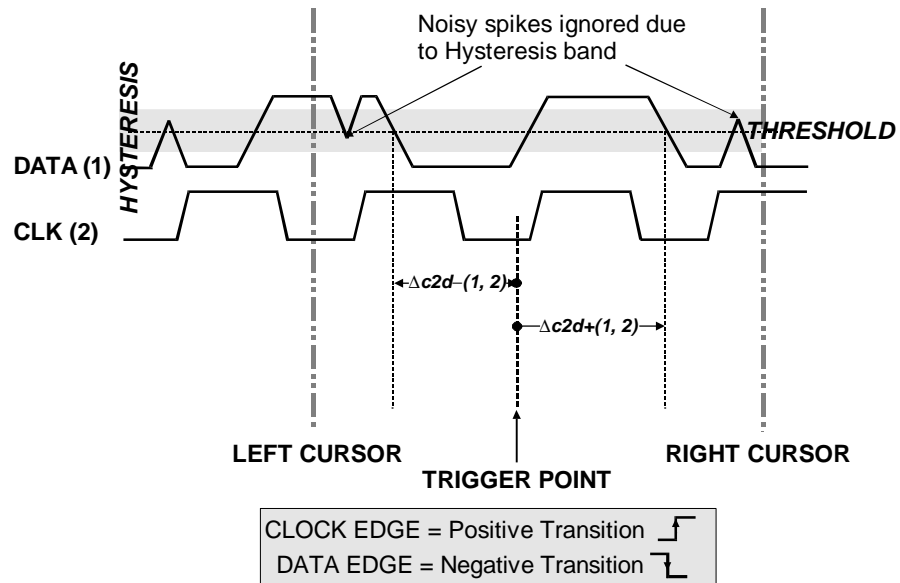

Figure D-3

Moreover, a hysteresis range may be specified to ignore any spurious transition that does not exceed the boundaries of the hysteresis interval. In Figure 3, $Dc2d-(1, 2)$ measures the time interval separating the rising edge of the clock (trigger) from the first negative transition of the data signal. Similarly, $Dc2d+(1, 2)$ measures the time interval between the trigger and the next transition of the data signal.

Parameter Measurement

Parameter and what it does		Definition	Notes
ampl	Amplitude: Measures difference between upper and lower levels in two-level signals. Differs from <i>pkpk</i> in that noise, overshoot, undershoot, and ringing do NOT affect measurement.	<i>top</i> - <i>base</i> (See Fig. D-1)	On signals NOT having two major levels (such as triangle or saw-tooth waves), returns same value as <i>pkpk</i> .
area	Integral of data: Computes area of waveform between cursors relative to zero level. Values greater than zero contribute positively to the area; values less than zero negatively.	Sum from <i>first</i> to <i>last</i> of data multiplied by horizontal time between points (See Fig. D-2)	
base	Lower of two most probable states (higher is <i>top</i>). Measures lower level in two-level signals. Differs from <i>min</i> in that noise, overshoot, undershoot, and ringing do NOT affect measurement.	Value of most probable lower state (See Fig. D-1)	On signals NOT having two major levels (triangle or saw-tooth waves, for example), returns same value as <i>min</i> .
cycles	Determines number of cycles of a periodic waveform lying between cursors. First cycle begins at first transition after the left cursor. Transition may be positive- or negative-going.	Number of cycles of periodic waveform (See Fig. D-2)	
cmean	Cyclic mean: Computes the average of waveform data. Contrary to <i>mean</i> , computes average over an integral number of cycles, eliminating bias caused by fractional intervals.	Average of data values of an integral number of periods	
cmedian	Cyclic median: Computes average of base and top values over an integral number of cycles, contrary to <i>median</i> , eliminating bias caused by fractional intervals.	Data value for which 50 % of values are above and 50 % below	
crms	Cyclic root mean square: Computes square root of sum of squares of data values divided by number of points. Contrary to <i>rms</i> , calculation performed over integral number of cycles, eliminating bias caused by fractional intervals.	$\sqrt{\frac{1}{N} \sum_{i=1}^N (v_i)^2}$	Where: v_i denotes measured sample values, and N = number of data points within the periods found up to maximum of 100 periods.

Parameter and what it does	Definition	Notes
csdev	Cyclic standard deviation: Standard deviation of data values from mean value over integral number of periods. Contrary to <i>sdev</i> , calculation performed over integral number of cycles, eliminating bias caused by fractional intervals.	$\sqrt{\frac{1}{N} \sum_{i=1}^N (v_i - \text{mean})^2}$ <i>Where: v_i denotes measured sample values, and N = number of data points within the periods found up to maximum of 100 periods.</i>
data	Returns average of all data points.	All data values in analyzed region (See Fig. D-2) <i>Multi-value parameter especially valuable for histograms and trends.</i>
delay	Time from trigger to transition: Measures time between trigger and first 50 % crossing after left cursor. Can measure propagation delay between two signals by triggering on one and determining delay of other.	Time between trigger and first 50 % crossing after left cursor (See Fig. D-2)
Ddly	Δ delay: Computes time between 50 % level of two sources.	Time between midpoint transition of two sources
Dt@lv	Δt at level: Computes transition between selected levels or sources.	Time between transition levels of two sources, or from trigger to transition level of a single source <i>Reference levels and edge-transition polarity can be selected. Hysteresis argument used to discriminate levels from noise in data.</i>
Dc2d±	Δ clock to data \pm : Computes difference in time from clock threshold crossing to either the next (<i>Dc2d+</i>) or previous (<i>Dc2d-</i>) data threshold crossing.	Time from clock threshold crossing to next or previous edge (See Fig. D-3) <i>Threshold levels of clock and data signals, and edge-transition polarity can be selected. Hysteresis argument used to differentiate peaks from noise in data, with good hysteresis value between half expected peak-to-peak value of signal and twice expected peak-to-peak value of noise.</i>

Parameter Measurement

Parameter and what it does		Definition	Notes				
dur	For single sweep waveforms, <i>dur</i> is 0; for sequence waveforms: time from first to last segment's trigger; for single segments of sequence waveforms: time from previous segment's to current segment's trigger; for waveforms produced by a history function: time from first to last accumulated waveform's trigger.	Time from first to last acquisition — for average, histogram or sequence waveforms					
duty	Duty cycle: Width as percentage of period.	$width/period$ (See Fig. D-2)					
f80-20%	Fall 80-20 %: Duration of pulse waveform's falling transition from 80% to 20%, averaged for all falling transitions between the cursors.	Average duration of falling 80-20 % transition	<i>On signals NOT having two major levels (triangle or saw-tooth waves, for example), top and base can default to maximum and minimum, giving, however, less predictable results.</i>				
f@level	Fall at level: Duration of pulse waveform's falling edges between transition levels.	Duration of falling edge between transition levels	<i>On signals NOT having two major levels (triangle or saw-tooth waves, for example), top and base can default to maximum and minimum, giving, however, less predictable results.</i>				
fall	Fall time: Measures time between two specified values on falling edges of a waveform. Fall times for each edge are averaged to produce final result.	Time at lower threshold - Time at upper threshold averaged over each falling edge (See Fig. D-1)	<i>On signals NOT having two major levels (triangle or saw-tooth waves, for example), top and base can default to maximum and minimum, giving, however, less predictable results.</i>				
	Arguments						
	Threshold			Remote	Lower Limit	Upper Limit	Default
	Lower			low	1 %	45 %	10 %
Upper	high	55 %	99 %	90 %			

Parameter and what it does	Definition	Notes
<p>Threshold arguments specify two vertical values on each edge used to compute fall time. Formulas for upper and lower values:</p> $\text{lower value} = \text{lower threshold} \times \frac{\text{amp}}{100} + \text{base}$ $\text{upper value} = \text{upper threshold} \times \frac{\text{amp}}{100} + \text{base}$		
first	<p>Indicates value of horizontal axis at left cursor.</p> <p>Horizontal axis value at left cursor (See Fig. D-2)</p>	<p><i>Indicates location of left cursor. Cursors are interchangeable: for example, the left cursor may be moved to the right of the right cursor and first will give the location of the cursor formerly on the right, now on left.</i></p>
freq	<p>Frequency: Period of cyclic signal measured as time between every other pair of 50 % crossings. Starting with first transition after left cursor, the period is measured for each transition pair. Values then averaged and reciprocal used to give frequency.</p> <p>1/period (See Fig. D-2)</p>	
last	<p>Time from trigger to last (rightmost) cursor.</p> <p>Time from trigger to last cursor (See Fig. D-2)</p>	<p><i>Indicates location of right cursor. Cursors are interchangeable: for example, the right cursor may be moved to the left of the left cursor and first will give the location of the cursor formerly on the left, now on right.</i></p>

Parameter Measurement

Parameter and what it does		Definition	Notes
maximum	Measures highest point in waveform. Unlike <i>top</i> , does NOT assume waveform has two levels.	Highest value in waveform between cursors (See Fig. D-1)	<i>Gives similar result when applied to time domain waveform or histogram of data of same waveform. But with histograms, result may include contributions from more than one acquisition. Computes horizontal axis location of rightmost non-zero bin of histogram — not to be confused with maxp.</i>
mean	Average of <i>data</i> for time domain waveform. Computed as centroid of distribution for a histogram. But when input is periodic time domain waveform, computed on an integral number of periods.	Average of <i>data</i> (See Fig. D-2)	<i>Gives similar result when applied to time domain waveform or histogram of data of same waveform. But with histograms, result may include contributions from more than one acquisition.</i>
median	The average of base and top values.	Average of <i>base</i> and <i>top</i> (See Fig. D-2)	
minimum	Measures the lowest point in a waveform. Unlike <i>base</i> , does NOT assume waveform has two levels.	Lowest value in waveform between cursors (See Fig. D-1)	<i>Gives similar result when applied to time domain waveform or histogram of data of same waveform. But with histograms, result may include contributions from more than one acquisition.</i>
over-	Overshoot negative: Amount of overshoot following a falling edge, as percentage of amplitude.	$\frac{ base - minimum }{ampl} \times 100$ (See Fig. D-2)	<i>Waveform must contain at least one falling edge. On signals NOT having two major levels (triangle or saw-tooth waves, for example), may NOT give predictable results.</i>
over+	Overshoot positive: Amount of overshoot following a rising edge specified as percentage of amplitude.	$\frac{ maximum - top }{ampl} \times 100$ (See Fig. D-1)	<i>Waveform must contain at least one rising edge. On signals NOT having two major levels (triangle or saw-tooth waves, for example), may NOT give predictable results.</i>



Parameter and what it does	Definition	Notes	
period	Period of a cyclic signal measured as time between every other pair of 50 % crossings. Starting with first transition after left cursor, period is measured for each transition pair, with values averaged to give final result.	$\frac{1}{Mr} \sum_{i=1}^{Mr} (Tr_i^{50} - Tr_i^{50})$ (See Fig. D-2)	Where: Mr is the number of leading edges found, Mf the number of trailing edges found, Tr_i^x the time when rising edge i crosses the x % level, and Tf_i^x the time when falling edge i crosses the x % level.
pkpk	Peak-to-peak: Difference between highest and lowest points in waveform. Unlike ampl, does not assume the waveform has two levels.	<i>maximum - minimum</i> (See Fig. D-1)	Gives a similar result when applied to time domain waveform or histogram of data of the same waveform. But with histograms, result may include contributions from more than one acquisition.
phase	Phase difference between signal analyzed and signal used as reference.	Phase difference between signal and reference	
points	Number of points in the waveform between the cursors.	Number of points between cursors (See Fig. D-2)	
r20-80%	Rise 20 % to 80 %: Duration of pulse waveform's rising transition from 20% to 80%, averaged for all rising transitions between the cursors.	Average duration of rising 20-80 % transition	On signals NOT having two major levels (triangle or sawtooth waves, for example), top and base can default to maximum and minimum, giving, however, less predictable results.
r@level	Rise at level: Duration of pulse waveform's rising edges between transition levels.	Duration of rising edges between transition levels	On signals NOT having two major levels (triangle or sawtooth waves, for example), top and base can default to maximum and minimum, giving, however, less predictable results.
rise	Rise time: Measures time between two specified values on waveform's rising edge (10-90 %). Rise times for each edge averaged to give final result.	Time at upper threshold - Time at lower threshold averaged over each rising edge	On signals NOT having two major levels (triangle or sawtooth waves, for example), top and base can default to maximum and minimum, giving, however, less predictable results.

Parameter Measurement

Parameter and what it does					Definition	Notes															
	<p style="text-align: center;">Arguments</p> <table border="1" style="width: 100%; border-collapse: collapse;"> <thead> <tr> <th>Threshold</th> <th>Remote</th> <th>Lower Limit</th> <th>Upper Limit</th> <th>Default</th> </tr> </thead> <tbody> <tr> <td>Lower</td> <td>low</td> <td>1 %</td> <td>45 %</td> <td>10 %</td> </tr> <tr> <td>Upper</td> <td>high</td> <td>55 %</td> <td>99 %</td> <td>90 %</td> </tr> </tbody> </table> <p>Threshold arguments specify two vertical values on each edge used to compute rise time.</p> <p>Formulas for upper and lower values:</p> <p style="margin-left: 20px;">lower value = lower threshold $\times \frac{amp}{100} + base$</p> <p style="margin-left: 20px;">upper value = upper threshold $\times \frac{amp}{100} + base$</p>				Threshold	Remote	Lower Limit	Upper Limit	Default	Lower	low	1 %	45 %	10 %	Upper	high	55 %	99 %	90 %		
Threshold	Remote	Lower Limit	Upper Limit	Default																	
Lower	low	1 %	45 %	10 %																	
Upper	high	55 %	99 %	90 %																	
rms	<p>Root Mean Square of data between the cursors — about same as <i>sdev</i> for a zero-mean waveform.</p>				$\sqrt{\frac{1}{N} \sum_{i=1}^N (v_i)^2}$ <p>(See Fig. D-2)</p>	<p><i>Gives similar result when applied to time domain waveform or histogram of data of same waveform. But with histograms, result may include contributions from more than one acquisition.</i></p> <p><i>Where: v_i denotes measured sample values, and N = number of data points within the periods found up to maximum of 100 periods.</i></p>															
sdev	<p>Standard deviation of the data between the cursors — about the same as <i>rms</i> for a zero-mean waveform.</p>				$\sqrt{\frac{1}{N} \sum_{i=1}^N (v_i - mean)^2}$ <p>(See Fig. D-2)</p>	<p><i>Gives similar result when applied to time domain waveform or histogram of data of same waveform. But with histograms, result may include contributions from more than one acquisition.</i></p> <p><i>Where: v_i denotes measured sample values, and N = number of data points within the periods found up to maximum of 100 periods.</i></p>															
t@level	<p>Time at level: Time from trigger (t=0) to crossing at a specified level.</p>				<p>Time from trigger to crossing level</p>																

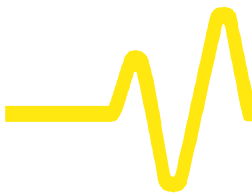

Parameter and what it does	Definition	Notes	
top	Higher of two most probable states, the lower being <i>base</i> . This is characteristic of rectangular waveforms and represents the higher most probable state determined from the statistical distribution of <i>datapoint</i> values in the waveform.	Value of most probable higher state <i>(See Fig. D-1)</i>	<i>Gives similar result when applied to time domain waveform or histogram of data of same waveform. But with histograms, result may include contributions from more than one acquisition.</i>
width	Width of cyclic signal determined by examining 50 % crossings in data input. If first transmission after left cursor is a rising edge, waveform is considered to consist of positive pulses and <i>width</i> the time between adjacent rising and falling edges. Conversely, if falling edge, pulses are considered negative and <i>width</i> the time between adjacent falling and rising edges. For both cases, widths of all waveform pulses averaged for final result.	Width of first positive or negative pulse averaged for all similar pulses <i>(See Figs. 1, 2)</i>	<i>Similar to fwhm, which, however, applies only to histograms.</i>

Using ASCII-Stored Files

The ASCII waveform storage feature allows waveforms to be stored to a mass-memory device in any of three ASCII formats: Spreadsheet, Mathcad and MATLAB. Each format is tailored for a commonly used analysis package. The user-interface changes supporting ASCII waveform storage are found in the STORE menu (see *Chapter 13*).

The table below summarizes the three formats' basic layout. Examples of the use of each format are given on the following pages.

Format	Header <i>Format includes some form of header before the data</i>	Time Values <i>Format stores time values with each amplitude value</i>	Amplitude Values <i>Format stores amplitude values</i>	Sequence Times <i>Header contains sequence time information for each sequence segment</i>	Multi-Segment <i>Format concatenates multiple segments of a sequence waveform</i>	Dual Array <i>Format allows dual-array data (i.e. Extrema, or complex FFT) to be stored</i>
Spreadsheet	Yes	Yes	Yes	Yes	Yes	Yes
Mathcad	Yes	Yes	Yes	Yes	Yes	Yes
MATLAB	No	No	Yes	No	Yes	No

Note: Once stored in ASCII, waveforms cannot be recalled into the DSO.

Using the Spreadsheet Format with Excel

This example was created using Microsoft Excel, Version 7.0 for Windows. A waveform stored in Spreadsheet format may be read into Microsoft Excel using the File -> Open dialog as follows:

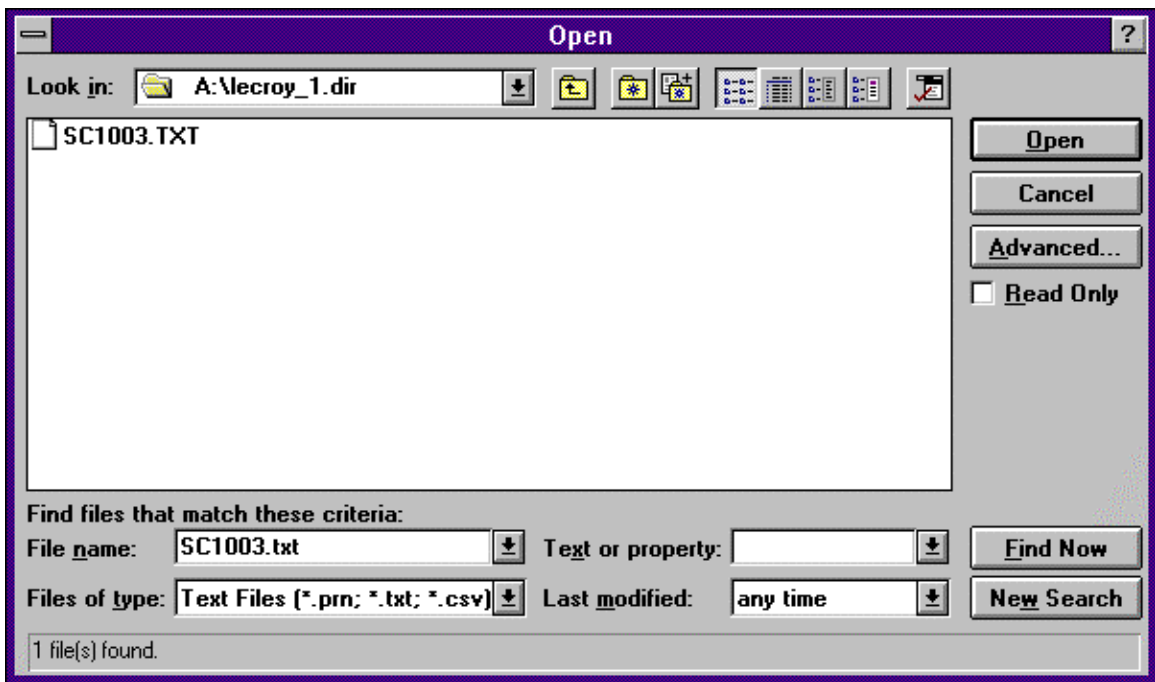

Excel will now ask for more information about the file type. Ensure that the 'Delimited' option is selected in the first step of the Wizard.

ASCII Waveform Export

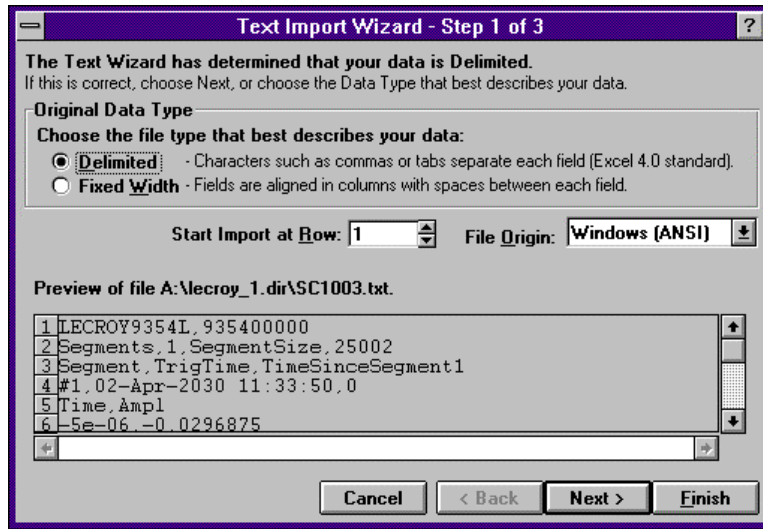

The next step allows the specific delimiter to be specified. The Spreadsheet format generated by the scope uses a comma (,) to delimit columns. Ensure that this is selected.

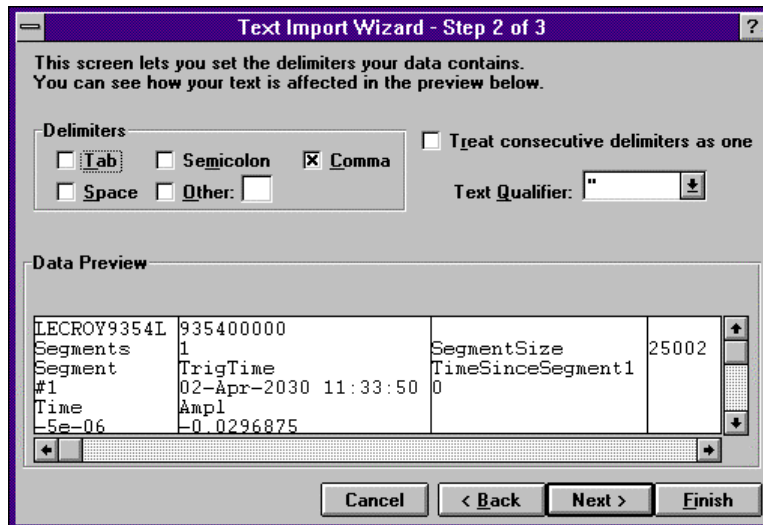

The third and final step allows the format of the columns to be specified. The 'general' format for each column should be used (this is the default).

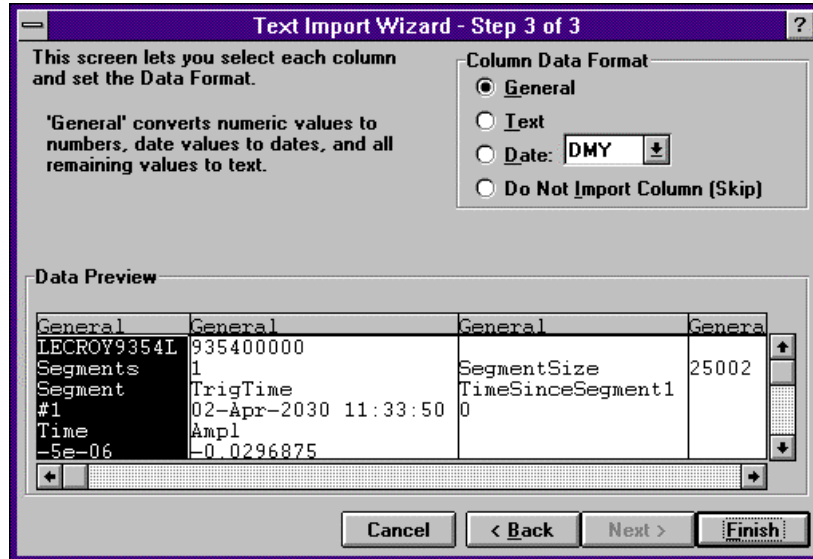

After clicking the Finish button, a display similar to that following should be displayed.

ASCII Waveform Export

Microsoft Excel - SC1001.TXT				
File Edit View Insert Format Tools Data				
	A	B	C	D
1	LECROY9354L	935400000		
2	Segments	1	SegmentSize	502
3	Segment	TrigTime	TimeSinceSegment1	
4	#1	22.03.30 20:22		0
5	Time	Ampl		
6	-5.01E-05	-0.00755		
7	-4.99E-05	-0.00755		
8	-4.97E-05	-0.00755		
9	-4.95E-05	-0.00755		
10	-4.93E-05	-0.00755		

Plotting a Single-Segment Waveform

Plotting the data from a single-segment waveform requires the use of a scatter plot based on the data in the first two columns with the first column used as the X values.

Extracting Segments from Sequence Waveforms

The header created for the Spreadsheet format contains all the information required to extract various elements of a sequence waveform. The following Formulae may be used to extract information such as the start and end row of the data for a given segment, or the trigger time of a given segment.

$$\text{SegmentStartRow} := (\text{DesiredSegment} * \text{D2}) + \text{B2} + 5$$

$$\text{SegmentEndRow} := \text{SegmentStartRow} + \text{D2} - 1$$

$$\text{TrigTime} = \text{INDIRECT}(\text{ADDRESS}(\text{DesiredSegment} + 3; 2; 4))$$

$$\text{TimeSinceFirstTrig} = \text{INDIRECT}(\text{ADDRESS}(\text{DesiredSegment} + 3; 3; 4))$$

Plotting the data from all segments using a scatter plot will result in all segments overlaid (similar to the scope's display of sequence traces in persistence mode).

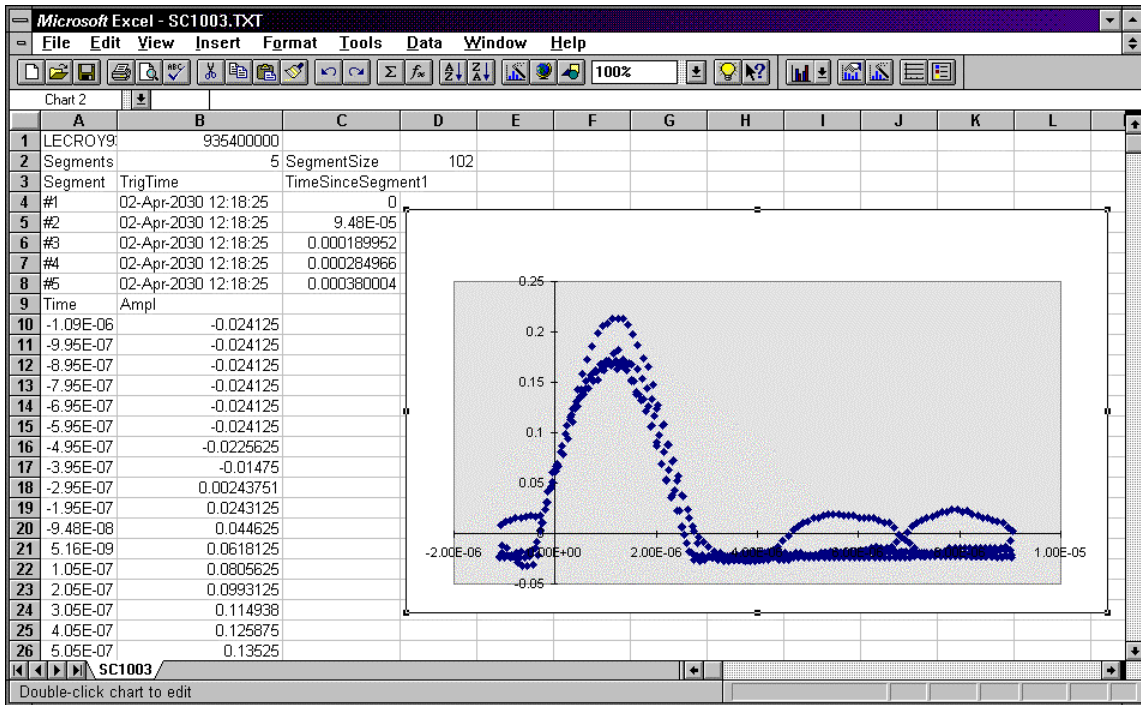

Using Mathcad

These examples were created using MathSoft's Mathcad for Windows. On this and the next page, the procedure for reading and graphing a file for a single segment is shown, using Mathcad Versions 3.1 and 7, respectively. The example on page E-9 is for multiple segments.

Single-Segment, Version 3.1 This single-segment example illustrates the use of Mathcad Version 3.1:

<code>a := READPRN(sc1004)</code>	Read data from file sc1004.prn into matrix 'a'
<code>n := 2..(1 + a_{0,1})</code>	Create ramp over all rows containing data
<code>time := a^{<0>}</code>	Extract time vector
<code>ampl := a^{<1>}</code>	Extract amplitude vector

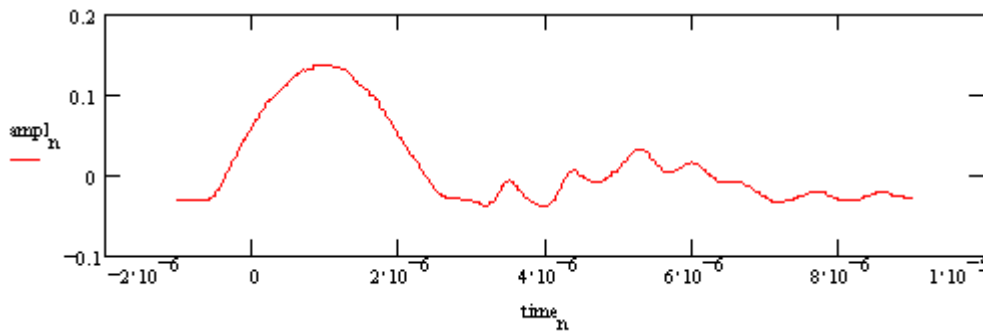

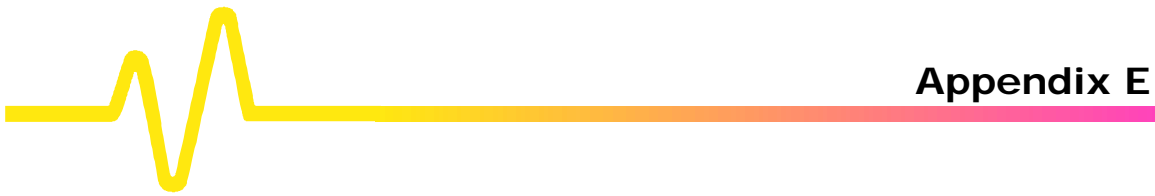

Single-Segment, Version 7 This single-segment example is valid for more recent versions of Mathcad:

$A := \text{READPRN}(\text{file})$

$K := \text{last}(A^{<0>})$

$A := \text{submatrix}(A, 2, K, 0, 1)$

$t := A^{<0>}$ $v := A^{<1>}$ $K := \text{last}(t)$ $k := 0..K - 1$

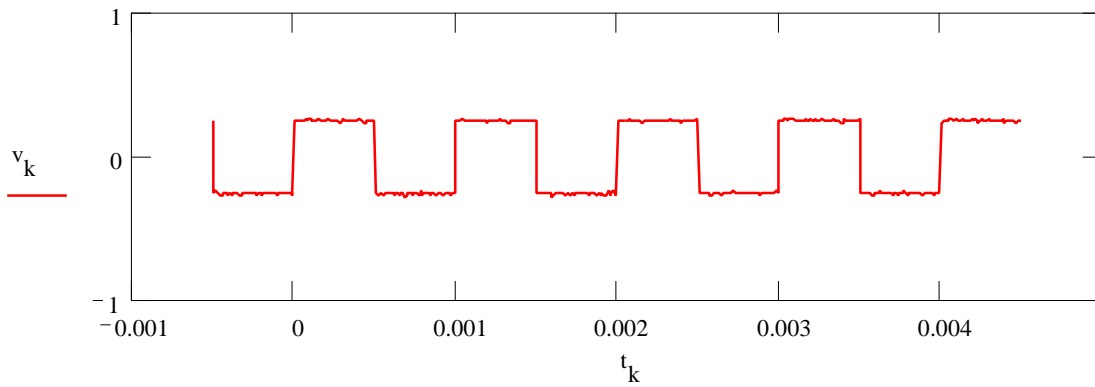

Multi-Segment Example The following Mathcad example demonstrates how to extract data from a given segment. The data used for this example consisted of two segments of three samples each, allowing the entire imported matrix to be shown.

Read data from file

$a := \text{READPRN}(sc1000)$

Extracting the first segment only (or only segment if not sequence trace)

$n := (1 + a_{0,0}) \cdot (a_{0,0} + a_{0,1})$

$m := 0..1$

$\text{firstseg}_{n-1-a_{0,0},m} := a_{n,m}$

$\text{firstseg} = \begin{pmatrix} 1 & 1 \\ 1.1 & 2 \\ 1.2 & 3 \end{pmatrix}$

n

3

4

5

$a = \begin{bmatrix} 2 & 3 \\ 1 & 0 \\ 2 & 999 \\ 1 & 1 \\ 1.1 & 2 \\ 1.2 & 3 \\ 1 & 1.1 \\ 1.1 & 2.1 \\ 1.2 & 3.1 \end{bmatrix}$

Extracting a given segment

$\text{numsegments} := a_{0,0}$

Total number of segments in trace

$\text{seglen} := a_{0,1}$

Number of samples in each segment

$\text{segment} := 0$

Desired segment number

$\text{segstart} := 1 + \text{numsegments} \cdot \text{segment}$

Index of first point in segment

$\text{segend} := \text{segstart} + \text{seglen} - 1$

Index of last point in segment

$\text{segtime} := a_{\text{segment}+1,1}$

Segment trigger time

$x := a^{<0>}$

$y := a^{<1>}$

$i := \text{segstart}.. \text{segend}$

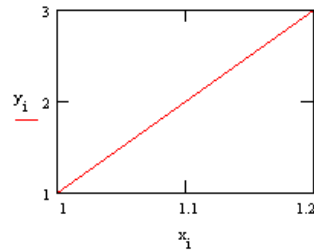

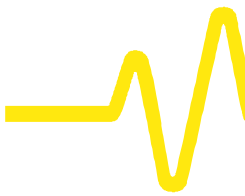

Using MATLAB

This example was created using MathWorks' MATLAB Version 4.2c.1 for Windows.

Reading and graphing a waveform in MATLAB may be achieved with two simple commands, as the following example shows. The first command loads the file into a matrix which is automatically named after the file. The second command plots this matrix.

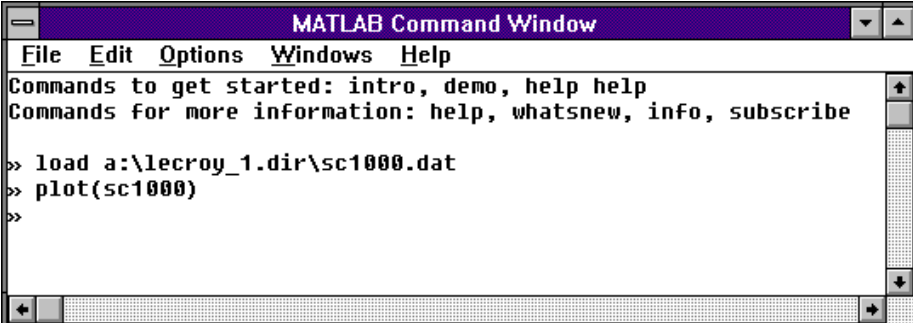
A screenshot of the MATLAB Command Window. The title bar reads "MATLAB Command Window". The menu bar includes "File", "Edit", "Options", "Windows", and "Help". The text area contains the following commands:

```
Commands to get started: intro, demo, help help
Commands for more information: help, whatsnew, info, subscribe

>> load a:\lecroy_1.dir\sc1000.dat
>> plot(sc1000)
>>
```

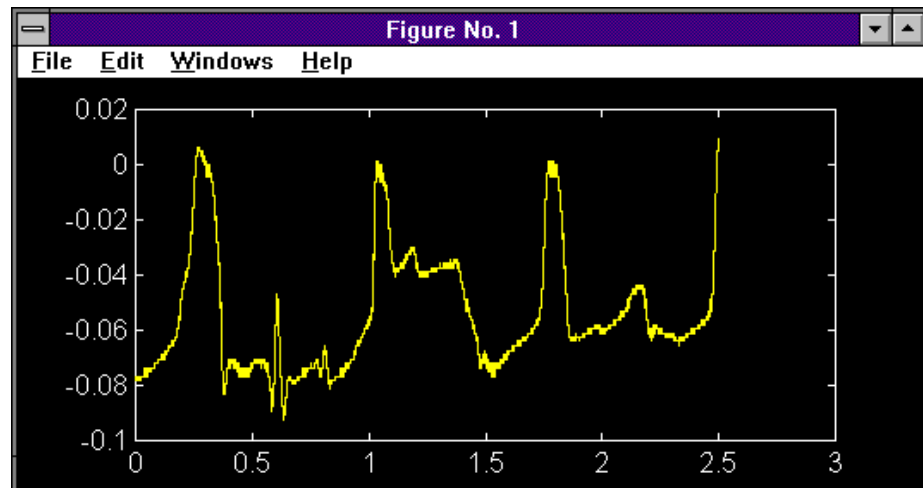

Detailed Description of the Formats

Spreadsheet

Format

Note: Fields in bold type are constants that are present in the output file as shown. Fields in italic are variables that are filled in when the file is written.

```

<scopeid>,          <scopeserial>
Segments,         <numseg>,          SegmentSize,
      <numpts>
Segment,         TrigTime,
      TimeSinceFirstSegment
#1,                 <trigtime(1)>,          0.0
...
#<numseg>,         <trigtime(numseg)>,
      <trigdelta(numseg)>
Time,            Ampl,          [Ampl1]
x(0),              y(0),            [y1(0)]
x(1),              y(1),            [y2(0)]
...
x(numgseg*numpts), y(numseg*numpts),
[y1(numseg*numpts)]
    
```

Single-Segment Example

```

LECROY9354,935412345
Segments,1,SegmentSize,502
Segment,Trig Time,TimeSinceFirstSegment
#1,21 Mar 1990 9:37:08,0.0
Time,Ampl
0.0,1
0.1,2
...
    
```



Multi-Segment Example

```
LECROY9354,935412345
Segments,3,SegmentSize,502
Segment,Trig Time,TimeSinceFirstSegment
#1,21 Mar 1990 9:37:08,0.0
#2,21 Mar 1990 9:37:13,5.0
#3,21 Mar 1990 9:37:15,7.0
Time,Ampl
0.0,1
0.1,2
...
0.0,1.1
0.0,2.1
...
0.0,1.05
0.0,2.05
```

Dual-Array Example

```
LECROY9354,935412345
Segments,1,SegmentSize,502
Segment,Trig Time,TimeSinceFirstSegment
#1,21 Mar 1990 9:37:08,0.0
Time,Ampl
0.0,1.1,1.1
0.1,2.1,2.1
...
```

Note:

- *The basic structure of the Spreadsheet format is a header containing scope identification information, followed by a block containing trigger times for multi-segment waveforms, followed by the data itself.*
- *This format is compatible with the ASCII import of the LeCroy LW4xx Arbitrary Function Generator.*

Mathcad

Format

```
<"scopeid">
<"TriggerTime">
<numseg>          <numpts>
Segment         TimeSinceFirstSegment
1                 0.0
...
<numseg>          <trigdelta(numseg)>
Time           Ampl           Ampl1
<x(0)>           <y(0)>           [<y1(0)>]
<x(1)>           <y(1)>           [<y1(1)>]
...
<x(numgseg*numpts)> <y(numseg*numpts)>
                    [<y1(numseg*numpts)>]
```

Single-Segment Example

```
"LECROY9354,935412345"
"23-March-90,12:44:23"
1                 502
Segment          TimeSinceFirstSegment
1                 0.0
Time            Ampl
0.0             1
0.1             2
.....
```



Multi-Segment Example

```
"LECROY9354,935412345"  
"23-March-90,12:44:23"  
3          502  
Segment    TimeSinceFirstSegment  
1          0.0  
2          5.0  
3          7.0  
Time       Ampl  
0.0       1  
0.1       2  
.....  
0.0       1.1  
0.1       2.1  
.....  
0.0       1.05  
0.1       2.05
```

Note:

- *The format created for MathCad is very similar to the Spreadsheet format, but with some differences due to the way MathCad interprets the header information.*
- *One of the most important of these is that the absolute trigger time is only given for the first segment, with relative times (in units of seconds) being included for each segment.*
- *Another difference is that the scope identification and trigger time are wrapped in quotes to ensure that MathCad does not attempt to import them.*

MATLAB Files

Format

```
y(0)  
y(1)  
...  
y(numseg*numpts)
```

Single Segment Example

```
1.0  
1.1  
1.2  
...  
4.5
```

Notes

- *The MATLAB format is simple, without header information and having amplitude values only.*
- *Multiple segments will be appended without a separator.*
- *Only one value from the pair of amplitude values present in a dual-array will be stored.*

A

AC, 8–5, C–15, 7–8
 Acquisition Memory, 7–1, C–4
 9304C/9310C/9314C Series,
 A–1
 9344C/9350C/9354C Series,
 A–7
 9370C/9374C Series, A–14
 9384C Series, A–21
 Acquisition Modes, 6–2, 7–5
 9304C/9310C/9314C Series,
 A–2
 9344C/9350C/9354C Series,
 A–9
 9370C/9374C Series, A–15
 9384C Series, A–22
 Acquisition Summary, 5–2, 5–4,
 6–3, 7–9, 16–1
 Acquisition Summary field, 4–9
 ADC (Analog-to-Digital
 Converter), 2–1, 7–1, 7–2, 7–8
 Aliasing, C–5, C–17
 Altitude, 3–1
 9304C/9310C/9314C Series,
 A–6
 9344C/9350C/9354C Series,
 A–13
 9370C/9374C Series, A–19
 9384C Series, A–26
 Amplitude, 12–21, 14–6, D–5
 in FFT, 10–18
 Area, D–5
 Arithmetic Setup, 10–8
 ASCII, 13–1, 13–2, 13–3, E–1
 ASCII Formats, A–6, A–13, A–19,
 A–26, E–1, E–2, E–3, E–4, E–
 5, E–9, E–10, E–11, E–12, E–
 13, E–14, E–15
 AUTO, 6–2, 7–9
 AUTO SETUP, 4–3, 6–1
 9304C/9310C/9314C Series,
 A–3

 9344C/9350C/9354C Series,
 A–11
 9370C/9374C Series, A–17
 9384C Series, A–23
 Auto-Calibration, 12–19
 9304C/9310C/9314C Series,
 A–6
 9344C/9350C/9354C Series,
 A–13
 9370C/9374C Series, A–19
 9384C Series, A–26
 Auto-Store, 12–9, 13–2
 Average Setup, 10–9
 Averaging, B–3

B

Bandwidth, 5–3, 5–5
 9304C/9310C/9314C Series,
 A–1
 9344C/9350C/9354C Series,
 A–7
 9370C/9374C Series, A–14
 9384C Series, A–21
 Bandwidth Limiter
 9344C/9350C/9354C Series,
 A–8
 9370C/9374C Series, A–15
 9384C Series, A–22
 Bandwidth Limiting (BWL), 5–3,
 5–5
 Base, D–1, D–2, D–5
 Battery, 12–10
 9304C/9310C/9314C Series,
 A–6
 9344C/9350C/9354C Series,
 A–13
 9370C/9374C Series, A–19
 9384C Series, A–26
 Baud Rate, 12–6
 Bi-level. See Window Pattern
 Trigger
 Binary, 13–1, 13–2
 Block Diagram, 2–5

BMP, 12–2, 12–8, A–5, A–13, A–19, A–26
 Boolean AND, 8–22

C

Cabling
 PC, 12–6
 Printer, 12–5
 CAL BNC Setup, 12–1, 12–21
 CAL/BNC, 14–13
 Calibration, 2–2, 5–4, 12–19, 12–21
 9304C/9310C/9314C Series, A–6
 9344C/9350C/9354C Series, A–13
 9370C/9374C Series, A–19
 9384C Series, A–26
 Capture information, 4–9
 Capture Time, 10–17
 Centroids, D–1
 Centronics, 12–2, 12–3
 CHANGE PARAM, 14–9, 14–10
 CHANGE PARAMETERS, 14–8
 Channel Pairing, 7–4, 7–5, 7–8
 Channel Use, 7–8
 Channels, 6–1
 9304C/9310C/9314C Series, A–1
 9344C/9350C/9354C Series, A–7
 9370C/9374C Series, A–14
 9384C Series, A–21
 CHANNELS, 4–3, 5–1
 Circuit Failures
 testing for using Exclusion Trigger, 8–12
 Cleaning and Maintenance, 3–3
 CLEAR INACTIVE menu, 16–5
 CLEAR SWEEPS, 4–7, 10–3, 10–4, 10–13, 11–7, 14–6, 14–7, 14–8
 Clock
 9304C/9310C/9314C Series, A–2
 9344C/9350C/9354C Series, A–9
 9370C/9374C Series, A–16
 9384C Series, A–22
 Clock Edge, 14–12, D–4
 Coherent Gain, C–17
 Combining Channels, 2–1, 7–4, 7–5, 7–8, 10–5
 Conformity, 3–1
 Continuous Averaging, 10–3, 10–9
 Controls
 Menu buttons and knobs, 4–3
 COPY FILES, 12–18
 Copying files between storage media, 12–10
 Coupling, 5–4, 8–4, 8–30, 8–33
 COUPLING, 5–2, 5–3
 Coupling Menus, 5–3
 Cursors
 9304C/9310C/9314C Series, A–5
 9344C/9350C/9354C Series, A–12
 9370C/9374C Series, A–19
 9384C Series, A–25
 Absolute, 14–1, 14–2, 14–3
 Amplitude, 14–1
 Difference, 14–3
 in FFT (Fast Fourier Transform), C–12
 Persistence, 14–1
 Reference, 14–3
 Relative, 14–1, 14–2, 14–3
 Time, 14–1
 CURSORS/MEASURE, 4–6, 14–3
 Custom Parameters, 14–4, 14–8, 14–9, 14–10, 14–11, 14–12
 Cycles, D–5
 in parameter measurements, D–2
 Cyclic Mean, D–5

Cyclic Median, D-5
Cyclic Parameters, D-3
Cyclic Root Mean Square, D-5
Cyclic Standard Deviation, D-6

D

Data, D-6
Data density, D-1
Data Edge, 14-12
Data Format, 13-3
Data Maps, 12-12
DC, 8-5, C-15
DC Accuracy
 9344C/9350C/9354C Series,
 A-8
 9370C/9374C Series, A-15
 9384C Series, A-22
DC Offset
 compensating for, 10-14
Deadtime
 9304C/9310C/9314C Series,
 A-2
 9344C/9350C/9354C Series,
 A-9
 9370C/9374C Series, A-15
 9384C Series, A-22
 reducing it using Sequence
 Mode, 7-4
Decimation
 in FFT, 10-19
Delay, D-6
DELAY, 6-3
Deleting Files, 12-9
Differential Time Measurements,
 D-3
Digital Filters, 10-10
Digitizers
 9304C/9310C/9314C Series,
 A-1
 9344C/9350C/9354C Series,
 A-7
 9384C Series, A-21
Directory, 12-7, 12-11, 12-15,
 12-16, 12-17

Disk Density, 12-13
Display, 2-2
 9304C/9310C/9314C Series,
 A-4
 9344C/9350C/9354C Series,
 A-11
 9370C/9374C Series, A-17
 9384C Series, A-24
 on-screen sections and
 fields, 4-9
 Standard Persistence, 11-7
DISPLAY, 4-6, 11-1, 11-6, 11-7
Display Scaling, 10-19
Display Setup, 11-1
 Persistence, 11-7
Displayed Trace Label, 4-9, 10-3,
 10-19, 11-1
Distortion
 FFT, C-4
DO RECALL, 13-4, 13-5, 14-19
DO STORE, 13-2
DOS. See UTILITIES:Mass
 Storage
Dot Join, 11-6, 11-7, 11-9
Dropout Trigger, 8-27, 8-37
 9304C/9310C/9314C Series,
 A-3
 9344C/9350C/9354C Series,
 A-10
 9370C/9374C Series, A-16
 9384C Series, A-23
Duration, D-7
Duty, D-7
Dynamic Range
 improving it, C-6

E

ECL/TTL gain, 5-3
Edge Trigger, 8-1, 8-2, 8-3, 8-4,
 8-5, 8-8, 8-9
Edge Trigger with Hold-off, 8-5
Edge Trigger with Hold-off by
 Events, 8-7



Edge Trigger with Hold-off by Time, 8–6
Edge-Qualified Trigger, 8–21, 8–25, 8–36
Edge-Qualified Trigger with Wait, 8–24
Electricity, 3–3
ENBW, C–17
Enhanced Resolution, 10–10
Enhanced Resolution Filtering, B–1, B–2, B–3, B–4, B–5, B–6, C–6
Enhanced Resolution Setup, 10–10
Envelope, 10–11
Events, 8–7, 8–9
 Trigger Hold-off by, 8–7
Excel, E–2
Exclusion Trigger, 8–10, 8–12, 8–13
 9304C/9310C/9314C Series, A–3
 9344C/9350C/9354C Series, A–10
 9370C/9374C Series, A–16
 9384C Series, A–23
Expansion Factor, 12–3
EXT, 8–4
External Clock, 7–5, 7–6
Extrema, 10–3, 10–11

F

Fall, D–2
Fall 80–20 %, D–7
Fall at Level, D–7
Fall time, 14–7, D–2, D–7
Falling edge, 14–11
FET Probes, 5–5
FFT (Fast Fourier Transform), 10–17, 10–18, 11–1, C–1, C–8, C–9, C–17
FFT (Fast Fourier Transform) menus, 10–12, 10–13

FFT Algorithms, C–14
FFT Average Setup, 10–13
FFT Error Messages, C–13
FFT Interruption, 10–12
FFT result menu, C–10, C–11
FFT Span, 10–17, 10–18, 10–19, 10–20, 10–21
FFT Windows, 10–12, C–5, C–6, C–11, C–17, C–19, C–20
Fields, 8–34
File, 13–5, 14–19
File Deleting, 12–9
File Naming, 12–8, 12–9, 12–15, 12–16
File Transfers, 12–10
Files, 12–7, 12–9, 12–10, 12–12, 12–14, 12–18, 15–3
Fill, 12–9
Filters, B–1, B–2, C–3, C–4, C–18
FIND, 5–1
FIR (Finite Impulse-Response) filter, B–1, B–2, C–6
Firmware, 12–19
First, D–8
FLASH UPDATE, 12–19
Floor, 10–11
 in extrema waveforms, 10–3
Floppy Disk, 12–7, 12–9, 12–10, 12–11, 12–12, 12–13, 12–15, 13–1, 13–2, 13–5, 14–19, 15–1, 15–2
 9304C/9310C/9314C Series, A–5
 9344C/9350C/9354C Series, A–13
 9370C/9374C Series, A–19
 9384C Series, A–25
for Math use max points menu, 10–18, C–9
FORMAT FLOPPY, 12–13
Format Hard Disk, 12–14
Frequency, 6–1, 12–1, 12–21, B–2, C–1, C–3, C–4, C–5, C–9, C–12, C–15, C–20, D–8. See

also Waveform Processing
(frequency)
Frequency bins, C-18
Frequency Range, C-18
9304C/9310C/9314C Series,
A-1
9344C/9350C/9354C Series,
A-7
9370C/9374C Series, A-14
9384C Series, A-21
Frequency Resolution, 10-17, C-
2, C-8, C-11, C-19
Frequency Span, 10-18, 10-19,
C-8
Front-panel Controls, 4-3
Fuses, 3-3

G

Glitch Trigger, 8-10, 8-11, 8-29,
8-30
Global BWL. See Bandwidth
Limiting. See Bandwidth
Limiting
GPIO, 2-3, 4-7
GPIO and RS232, 12-1, 12-2,
12-3
GPIO and RS-232-C
9304C/9310C/9314C Series,
A-5
9370C/9374C Series, A-19
9384C Series, A-25
GPIO Port, 12-5, A-5, A-19, A-25
GPIO/RS232 Setup, 12-1, 12-6
Graphics Files, 12-2
Grid intensity, 11-6, 11-7, 11-9
Grid selection, 11-2
Grids, 11-9
Dual, 11-3
Parameter Display, 11-4
Quad, 11-3
selecting, 11-6, 11-7
Single, 11-2
XY Dual, 11-5
XY only, 11-4

XY Single, 11-5
Ground and Trace Level markers,
4-9

H

Hard Disk, 12-7, 12-10, 12-14,
12-15, 13-1, 13-2, 13-5, 14-
19, 15-1, 15-2
Hardcopy, 2-2
9304C/9310C/9314C Series,
A-6
9344C/9350C/9354C Series,
A-13
9370C/9374C Series, A-19
9384C Series, A-26
Expansion factor, 12-3
Hardcopy Setup, 12-1, 12-2, 12-3
Harmonics, C-2, C-5
HDD (portable hard disk), 12-7,
12-14, 12-15, 13-2, 13-5, 14-
19, 15-1, 15-2
HF
in Triggering, 8-5
High-Frequency Triggering, 8-5
Histogram Setup, 10-15
Histograms, D-1
9304C/9310C/9314C Series,
A-5
9344C/9350C/9354C Series,
A-12
9370C/9374C Series, A-18
9384C Series, A-25
Holdoff, 8-33
Hold-off, 8-5, 8-9, 8-20
Hold-off by Time, 8-6
Humidity, 3-1
9304C/9310C/9314C Series,
A-6
9344C/9350C/9354C Series,
A-13
9370C/9374C Series, A-19
Hysteresis, 14-11, 14-12, D-4



I

Input Coupling
9304C/9310C/9314C Series,
A-2
9344C/9350C/9354C Series,
A-8
9370C/9374C Series, A-15
9384C Series, A-22
Input Impedance, 5-4
9304C/9310C/9314C Series,
A-2
9344C/9350C/9354C Series,
A-9
9370C/9374C Series, A-15
Interfacing
9304C/9310C/9314C Series,
A-5
9344C/9350C/9354C Series,
A-13
9370C/9374C Series, A-19
9384C Series, A-25
Interleaving, 7-2, 7-4, 7-8
Internal Memory, 13-1, 13-4, 13-
5, 15-1
9304C/9310C/9314C Series,
A-5
9344C/9350C/9354C Series,
A-12
9370C/9374C Series, A-18
9384C Series, A-25
Internal Printer Setup, 12-3
Interval Trigger, 8-13, 8-14, 8-15,
8-16, 8-17, 8-32

L

Last, D-8
Leading Edge, D-2
Leakage, C-5, C-11, C-19
LEVEL, 6-3, 8-1
LINE, 8-4
Lobes, C-2, C-5, C-17, C-19
Low-Frequency Triggering, 8-5

Low-pass Filtering, B-2, B-4, C-6

M

Magnitude, C-4, C-6, C-10, C-
15, C-16
Maintenance, 1-2
Mask Testing, 14-13, 14-17, 14-
18, 14-19
Mass Storage, 12-7, 12-15, 12-
16, 12-18
MASS STORAGE, 12-10, 12-12,
12-14
Math Functions, 9-1, 10-2, 10-6,
10-14, 10-17, 10-18, 10-19
Speeding them up, 10-5
MATH SETUP, 9-2
Math Type menu, C-11
Mathcad, E-1, E-9, E-13, E-14
MathCadä, 13-3
MATLAB, E-1, E-10, E-15
MATLAB™, 13-3
Maxima
in extrema waveforms, 10-3
Maximum, D-8
Maximum Input
9304C/9310C/9314C Series,
A-2
9344C/9350C/9354C Series,
A-9
9370C/9374C Series, A-14,
A-15
9384C Series, A-22
Maximum Sample Rate
9304C/9310C/9314C Series,
A-1
9370C/9374C Series, A-14
9384C Series, A-21
Maximum Sampling Rate, 7-2
Mean, D-8
MEASURE, 14-14
Median, D-9
Medium-to-High-Frequency
Triggering, 8-5

Memories, 2-1, 13-1, 13-4, 13-5,
15-1, 15-2
Memory, C-4, C-12
Memory Card, 12-7, 12-10, 12-
15, 13-1, 13-2, 13-5, 14-19,
15-1, 15-2
Memory Used/Available
Summary, 16-5
Menu buttons and knobs, 4-3
Menu Options, 4-5
Menu-Entry buttons, 4-4, 4-6, 4-
7, 9-2, 11-1, 12-1, 13-1, 13-4,
14-3
Menus
moving through them, 4-4,
4-6
Mesial, D-2
Message Field, 4-9
Minima
in extrema waveforms, 10-3
Minimum, D-9
MORE VERSION
INFORMATION, 16-2
Multi-Zoom, 10-6

N

NEW DIRECTORY, 12-17
Noise Reduction, 10-3, B-2, B-6
NORM, 6-2, 7-8, 10-3
Number of points, 7-5, C-14, C-
19
Nyquist Frequency, 10-18, 10-19,
B-2, C-4, C-5, C-9, C-12, C-
19

O

OFFSET, 5-1
Offset behavior, 7-9, 12-1, 12-19
Offset Range, A-8
9304C/9310C/9314C Series,
A-1
9344C/9350C/9354C Series,
A-8

9370C/9374C Series, A-15
9384C Series, A-21
Offset scaling, 6-1
Operand, 10-8
Operating Environment, 3-1, A-6,
A-13, A-19, A-26
Operator, 10-8
Options installed
information on, 16-2
OR interval, 8-32
Output Formats, A-6, A-13, A-19,
A-26
Over +, D-9
Over -, D-9
Overflow, B-3
Overload, 3-3, 5-3, 5-5
Oversampling, B-1
Overvoltage, 3-1

P

Packing and Shipment, 1-3
PANEL SETUPS, 4-7, 15-1, 15-
2, 15-3
Parameter Categories, 14-9, 14-
10
Parameter Display, 11-4
Parameter symbols, 14-4
Parameters, 10-3, 10-15, 14-4,
14-6, 14-7, 14-8, 14-9, 14-10,
14-11, 14-12, 14-13, 14-14,
14-15, 14-16, 14-17, 14-18,
14-20, D-1, D-5, D-6, D-7, D-
8, D-9, D-10, D-11
Parity, 12-6
Pass/Fail Testing, 12-21, 14-4,
14-13, 14-14, 14-15, 14-16,
14-17, 14-18, 14-20
Pattern Trigger, 8-18, 8-19, 8-20,
8-31, 8-33
9344C/9350C/9354C Series,
A-10
9370C/9374C Series, A-17
9384C Series, A-23
PC, 12-6, 12-7

- 9304C/9310C/9314C Series, A-5
 - 9344C/9350C/9354C Series, A-13
 - 9370C/9374C Series, A-19
 - 9384C Series, A-25
 - PCMCIA. See UTILITIES:Memory Card
 - Peak Detect, 7-2, 7-5
 - 9344C/9350C/9354C Series, A-9
 - 9370C/9374C Series, A-15
 - 9384C Series, A-22
 - Peak-to-Peak, 14-6, D-9
 - Period, D-9
 - Periodic Signals, C-6
 - Persist for
 - selecting persistence duration, 11-8
 - Persistence, 11-8, 11-9, 14-1
 - Persistence data maps
 - memory allocation, 16-5
 - Persistence Display, 11-1
 - Persistence duration, 11-8
 - Persistence Setup, 11-7, 11-8
 - Phase, C-10, D-9
 - Phase Response, B-2
 - Picket Fence Effect, C-4, C-20
 - Points, D-9
 - Pollution Degree, 3-1, A-6, A-13, A-20, A-26
 - POSITION, 9-2, 10-6
 - Post-Trigger, 6-3
 - Power, 3-3
 - 9304C/9310C/9314C Series, A-6
 - 9344C/9350C/9354C Series, A-13
 - 9370C/9374C Series, A-19
 - 9384C Series, A-26
 - Power Average, C-16
 - Power Averaging, 10-13
 - Power Density, 10-12, C-10, C-16
 - Power Density Spectrum, C-4, C-20
 - Power On
 - Self-Test, 3-3
 - Power Spectrum, 10-12, C-4, C-10, C-16, C-20
 - Precise Timing Measurements, 10-1
 - Pre-Trigger, 6-3
 - Printers, 12-2, 12-3, 12-5
 - 9304C/9310C/9314C Series, A-5
 - 9344C/9350C/9354C Series, A-13
 - 9370C/9374C Series, A-19
 - 9384C Series, A-26
 - Probe Attenuation, 5-3
 - Probe Calibration, 5-4
 - Probes, 5-4, 5-5
 - 9304C/9310C/9314C Series, A-3
 - 9344C/9350C/9354C Series, A-11
 - 9370C/9374C Series, A-17
 - 9384C Series, A-23
 - ProBus, 5-5
 - Processing Functions
 - 9370C/9374C Series, A-18
 - Processing Functions
 - 9304C/9310C/9314C Series, A-4
 - 9344C/9350C/9354C Series, A-12
 - 9384C Series, A-24
 - Processors, 2-1
 - Pulse Width, 8-14, 8-29, 8-30, 8-31
- Q**
- Qualifications
 - in Triggering, 8-2
 - Qualified Triggers, 8-21, 8-22, 8-35, 8-36

9304C/9310C/9314C Series,
A-3
9344C/9350C/9354C Series,
A-10
9370C/9374C Series, A-16
9384C Series, A-23
Qualifier. See Qualified Triggers

R

Real Time Clock field, 4-9
Real, Real + Imaginary, Imaginary
FFT, C-10
RECALL W'FORM, 13-4, 13-5
Recalling Setups, 15-2, 15-3
Record, 7-6
Record Length
maximising it, C-8
Record up to, 7-5, 7-6, 7-9
Reducing Noise, 10-3, B-2, B-6
Reference Memories, 10-5
Relative Mode. See
Cursors:Relative
Relative Time Cursors, 10-1
Remote Control, 2-3
Remote Enable, 4-5
Rescale Setup, 10-16
RESET, 9-2, 10-1
Reset (General Instrument), 4-10
Resolution, B-1, B-2, B-3
Resolution Bandwidth
in FFT, 10-17
Return, 1-3
RETURN, 4-4, 4-6
RIS (Random Interleaved
Sampling), 2-2, 7-1, 7-2, 7-5,
8-27
9304C/9310C/9314C Series,
A-2
9370C/9374C Series, A-15
9384C Series, A-22
AUTO, 6-2
SNGL, 6-3
STOP, 6-2
Rise, D-2

Rise 20-80%, D-10
Rise at Level, D-10
Rise time, 14-7, D-2, D-10
Rising edge, 14-11
Roll Mode, 7-1, 7-3
9304C/9310C/9314C Series,
A-2
9344C/9350C/9354C Series,
A-9
9370C/9374C Series, A-16
9384C Series, A-22
AUTO, 6-2
NORM, 6-2
SNGL, 6-3
STOP, 6-2
Roof, 10-11
in extrema waveforms, 10-3
Root Mean Square (rms), 14-6,
D-2, D-11
RS-232-C, 2-3, 4-7
RS-232-C Connector Pin
Assignments, 12-5
RS-232-C Port, 12-5, A-5, A-19,
A-25

S

Safety, 3-1, A-6, A-13, A-20, A-
26
Safety Symbols, 3-1
Sample Clock, 7-5, 7-6, 7-8
Sampling, 7-1, 7-6, 7-8
FFT, C-1
Sampling Modes, 7-1
Sampling Period
in FFT, 10-18
Sampling Rate, 7-3, 7-5, B-1
Sampling thresholds, 7-6
Saving Setups, 15-1
Scale Factors
9304C/9310C/9314C Series,
A-1
9344C/9350C/9354C Series,
A-8
9370C/9374C Series, A-14



- 9384C Series, A-21
- Scaling, 6-1
 - in FFT, 10-19
- Scallop Loss, C-4, C-17, C-20
- SCREEN DUMP, 4-7, 12-2
- Screen Intensity
 - Grid, 11-6, 11-7, 11-9
 - Waveform and Text, 11-6, 11-7, 11-9
- Segments, 6-2, 7-1, 7-3, 7-5, 7-6, 7-8, 10-3, 10-6
 - 9304C/9310C/9314C Series, A-2
- SELECT ABCD, 9-1
- SELECT CHANNEL, 5-1
- Self-Test, 3-3
- Sensitivity
 - 9304C/9310C/9314C Series, A-1
 - 9344C/9350C/9354C Series, A-8
 - 9370C/9374C Series, A-14
 - 9384C Series, A-21
- Sequence, 7-8
 - 9304C/9310C/9314C Series, A-2
 - 9344C/9350C/9354C Series, A-9
 - 9370C/9374C Series, A-15
 - 9384C Series, A-22
- Sequence Mode, 7-1, 7-3, 7-4, 7-5, 7-6, 7-8, 10-3, 10-6, 12-19
 - AUTO, 6-2
 - NORM, 6-2
 - STOP, 6-2
- Serial number, 16-2
- Service and Repair, 1-2
- Setup Recall, 2-3
- Setups, 2-3
- SHOW STATUS, 4-7, 16-1
- Signal-to-noise(SNR) ratio
 - improving it using Enhanced Resolution Filtering, B-1, B-2
- SINGLE, 7-8
- Single-Shot Acquisition, 10-3
- Single-Shot Acquisition, 7-1
- Single-Shot Mode, 6-3, 7-5
- Size
 - 9304C/9310C/9314C Series, A-6
 - 9344C/9350C/9354C Series, A-13
 - 9370C/9374C Series, A-19
 - 9384C Series, A-26
- SMART Trigger, 8-1, 8-2, 8-10, 8-11, 8-12, 8-13, 8-14, 8-15, 8-16, 8-17, 8-18, 8-19, 8-20, 8-21, 8-22, 8-24, 8-25, 8-27, 8-29, 8-30, 8-31, 8-32, 8-33, 8-34, 8-35, 8-36
- SMART Triggers
 - 9304C/9310C/9314C Series, A-3
 - 9344C/9350C/9354C Series, A-10
 - 9370C/9374C Series, A-16
 - 9384C Series, A-23
- SNGL, 6-3
- Software version information, 16-2
- Source Trace, 10-7
- Special Modes, 7-9, 12-1, 12-19
- Spectral Analysis, 10-17, B-2, C-1, C-2
- Spectral Power Averaging, C-6, C-7
- Spreadsheet, 13-3, E-1, E-2, E-3, E-4, E-5, E-11, E-12
- Standard Deviation, 14-6, D-11
- Standard Display, 11-1, 11-6
- Standard Parameters, D-1
- Standard Time Parameters, 14-7
- Standard Voltage Parameters, 14-6
- State-Qualified Trigger, 8-21, 8-35

State-Qualified Trigger with Wait, 8-22
Statistics, 14-4, 14-6, 14-7, 14-8
STOP, 6-1, 7-8, 10-3
Stop bits, 12-6
Storage
 Copy Files, 12-18
Storage Availability, 12-9
STORE W'FORMS, 13-1, 13-2
Summary, 16-1
Summed Averaging, 10-3, 10-9
System Setup, 4-6
System Summary, 16-2

T

Temperature, 3-1
 9304C/9310C/9314C Series, A-6
 9344C/9350C/9354C Series, A-13
 9370C/9374C Series, A-19
 9384C Series, A-26
 9384C Series, A-26
Template, 12-10, 12-13, 12-14
Text & Times Summary, 16-3
TIFF, 12-2, 12-8, A-5, A-13, A-19, A-26
Time
 Trigger Hold-off by, 8-6, 8-9
Time and Frequency field, 4-9
Time at Level, D-11
Time intervals, D-2
Time Parameter measurements, D-2
Time Resolution
 improving it with Zoom, 10-1
TIME/DATE, 12-4
Time/Date Setup, 12-1
TIME/DIV, 6-3
Timebase, 8-6, 14-17, 16-1
 9304C/9310C/9314C Series, A-2
 9344C/9350C/9354C Series, A-9
 9370C/9374C Series, A-15
 9384C Series, A-22
TIMEBASE, 6-1, 10-18, 10-20
TIMEBASE + TRIGGER, 4-3
Timebase Clock, 7-1
Timebase scaling, 6-1
TIMEBASE SETUP, 6-4, 7-5
Timebase Source, 6-1
Timebase summary, 16-1
Timeout, 8-6, 8-37
Time-outs, 8-27
tolerance, 14-18
Top, D-1, D-2, D-11
Trace and Ground Level markers, 4-9
TRACE ON/OFF, 5-1, 9-1
Traces
 selection of, 5-1
Tracking, 14-6, 14-7, 14-8
Trailing Edge, D-2
Transient signals, C-1, C-11
Trending
 9304C/9310C/9314C Series, A-5
 9344C/9350C/9354C Series, A-12
 9370C/9374C Series, A-18
 9384C Series, A-25
Trigger, 2-2, 8-1, 8-2, 8-9, 8-10
 AUTO, 8-1
 NORM, 8-1
 Slope, 8-8
 STOP, 8-1
TRIGGER, 6-1
Trigger Amplitude, 8-4
Trigger Configuration field, 4-9
Trigger Controls, 8-1
Trigger Coupling, 8-4, 8-9, 8-30, 8-32
 9304C/9310C/9314C Series, A-2
 9344C/9350C/9354C Series, A-10



- 9370C/9374C Series, A-16
- 9384C Series, A-22
- Trigger Delay, 4-9, 6-3, 7-1, 8-6, 8-27, 8-36, 14-7
- 9304C/9310C/9314C Series, A-3
- 9344C/9350C/9354C Series, A-10
- 9370C/9374C Series, A-16
- 9384C Series, A-23
- Trigger Events, 8-9, 8-35
- Trigger Holdoff, 8-33
- 9344C/9350C/9354C Series, A-10
- 9370C/9374C Series, A-16
- 9384C Series, A-23
- Trigger Hold-off, 8-5, 8-9
- Trigger Level, 6-3, 8-1, 8-4, 8-18, 8-33, 14-11
- Trigger Level arrows, 4-9
- Trigger Level scaling, 6-1
- Trigger Maximum Input
- 9304C/9310C/9314C Series, A-3
- 9344C/9350C/9354C Series, A-10
- 9370C/9374C Series, A-16
- 9384C Series, A-23
- Trigger Modes, 6-1
- Trigger Out, 12-21
- Trigger Range, 8-4
- 9304C/9310C/9314C Series, A-3
- 9344C/9350C/9354C Series, A-10
- 9370C/9374C Series, A-16
- 9384C Series, A-23
- Trigger Ready, 12-21
- TRIGGER SETUP, 6-4, 8-29
- TRIGGER SETUP, 8-1
- TRIGGER SETUP menus, 8-1
- Trigger Signal Interval
- 9304C/9310C/9314C Series, A-3
- Trigger Signal or Pattern Interval
- 9344C/9350C/9354C Series, A-10
- 9370C/9374C Series, A-16
- 9384C Series, A-23
- Trigger Signal or Pattern Width
- 9304C/9310C/9314C Series, A-3
- 9344C/9350C/9354C Series, A-10
- 9370C/9374C Series, A-16
- 9384C Series, A-23
- Trigger Slope, 8-5, 8-9, 8-37
- 9304C/9310C/9314C Series, A-2
- 9344C/9350C/9354C Series, A-10
- 9370C/9374C Series, A-16
- 9384C Series, A-22
- Trigger Source, 6-1, 6-3, 8-3, 8-4, 8-9, 8-32, 8-35, 8-36, 8-37
- 9304C/9310C/9314C Series, A-2
- 9344C/9350C/9354C Series, A-10
- 9370C/9374C Series, A-16
- 9384C Series, A-22
- Trigger Status field, 4-9
- Trigger summary, 16-1
- Trigger Threshold, 8-18, 8-19, 8-20, 8-36
- Trigger Timing
- 9304C/9310C/9314C Series, A-3
- 9344C/9350C/9354C Series, A-10
- 9370C/9374C Series, A-16
- 9384C Series, A-23
- Trigger window, 8-14, 8-32
- Triggering, 10-3
- 9304C/9310C/9314C Series, A-2
- 9344C/9350C/9354C Series, A-10

9370C/9374C Series, A-16
9384C Series, A-22
TV Trigger, 8-25, 8-34
9304C/9310C/9314C Series,
A-3
9344C/9350C/9354C Series,
A-10
9370C/9374C Series, A-16
9384C Series, A-23
TV Type, 8-34

U

UTILITIES, 4-6, 7-9, 12-1
File Transfers, 12-10
Floppy Disk, 12-7, 12-12,
12-13
GPIB port, 12-5
Hard Disk, 12-7, 12-14
Hardcopy Setup, 12-2, 12-3
Mass Storage, 12-1, 12-7,
12-10
Memory Card, 12-7
Printers, 12-2, 12-3
RS-232-C port, 12-5
Special Modes, 12-1, 12-19

V

V/div Offset, 5-3, 5-5
Validation
in triggering, 8-21
VAR, 5-2
Vertical Offset, 5-1
Vertical Resolution
9304C/9310C/9314C Series,
A-1
9344C/9350C/9354C Series,
A-8
9370C/9374C Series, A-15
9384C Series, A-22
increasing it, B-5
Vertical Sensitivity, 5-1
VOLTS/DIV, 5-1, 5-2
Volts/div scaling, 6-1

W

Warnings, 3-2
Warranty, 1-1, A-6, A-13, A-19,
A-26
Waveform and Text intensity, 11-
6, 11-7, 11-9
Waveform Mathematics, 10-2,
10-5, 10-6
Waveform Processing, 10-5, C-1,
C-7, C-11, C-12, C-14, C-17,
C-18
Waveform Recall, 13-4, 13-5
WAVEFORM RECALL, 4-6
Waveform Status, 16-4
Waveform Store, 13-1, 13-3
WAVEFORM STORE, 4-6
Weight
9304C/9310C/9314C Series,
A-6
9344C/9350C/9354C Series,
A-13
9370C/9374C Series, A-19
9384C Series, A-26
Width, 8-30, 8-31, D-11
Window Pattern Trigger, 8-20
Window Trigger, 8-8
with window menu, C-5
Wrap, 7-5, 7-8, 7-9, 12-9

X

XY Display, 11-1, 11-9

Z

ZERO, 6-3
Zoom, 9-1, 9-2, 10-1
ZOOM, 9-2, 10-6
ZOOM + MATH, 4-3
Zoom Factors
9304C/9310C/9314C Series,
A-4
9344C/9350C/9354C Series,
A-11



Index

9370C/9374C Series, A-18
9384C Series, A-24

Zoom menu, 10-7
Zoom of Math Functions, 10-1

