

LeCroy

# OSCILLOSCOPES, PROTOCOL ANALYZERS, AND SERIAL DATA TEST SOLUTIONS

2007-2008 CATALOG

FOR DESIGN  
VALIDATION  
AND DEBUG...  
IT'S ALL ABOUT  
THE TOOLS



Time	Packet #	Status
00.000 001 916		
00.000 001 920	21 (Downstream)	
00.000 001 924		
00.000 001 928		
00.000 001 932		
00.000 001 936		
00.000 001 940		
00.000 000 136	idle time	
00.000 002 080	22 (Upstream)	
00.000 000 076	idle time	
00.000 002 160		
00.000 002 164		
00.000 002 168		
00.000 000 120	idle time	

Hex	ASCII
5C 00 00 05 9F 87 76 FD	
FB 05 E5 00 10 10 10 01 00 00	
9A E9 99 FD FB 05 E6 00 10	
43 C2 40 1F 64 A3 99 FD	

## OVERVIEW

What We Do	3
Our Customers	4
Our Technology	5
SDA 18000/SDA 11000/SDA 9000	6-7
WaveExpert®	8-9
Serial Data Analyzers/Disk Drive Analyzers	10
WaveMaster®/WavePro®	11
WaveJet®	12
WaveSurfer®	13
WaveRunner®	14
Probes	15
QualiPHY™	16
WaveScan™	17
Protocol Solutions	18-19
Software	20
Customer Sales and Service	21
Digital Oscilloscope and Protocol Solutions Selection Guide	22-24

## TABLE OF CONTENTS

Serial Data Analyzers	25-67
WaveExpert	68-74
Protocol Solutions	75-99
Software	101-151
Disk Drive Analyzers	153-161
Oscilloscopes	163-222
Embedded Controller Test Solutions	223-225
Mixed Signal Testing	227-231
Oscilloscope Accessories	233-236
Probes and Probe Accessories	237-273
Differential Amplifiers and Accessories	275-279
Automotive and Vehicle Solutions	281-287



## INNOVATIVE TEST SOLUTIONS FOR ELECTRONIC DESIGN ENGINEERS

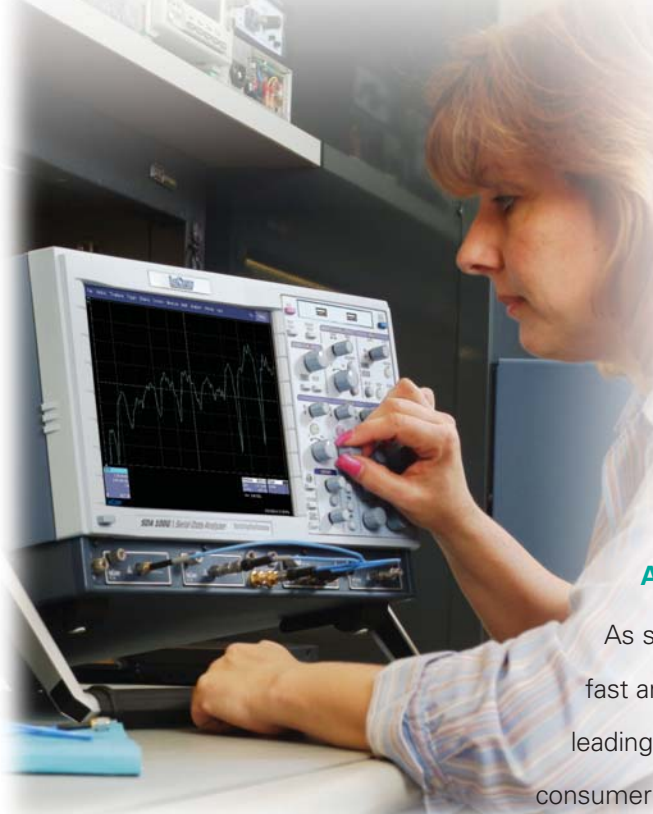

Since the company's founding in 1964, LeCroy has focused on being a leading innovator of test solutions for electronic design engineers. These solutions enable engineers to be more productive by resolving design issues faster and more effectively, thereby shortening product time to market. By developing industry-leading test systems in serial data analysis, protocol analysis, and analog and digital signal measurement, the company has played a major part in advancing the technological revolution.

### A Complete Toolbox for Serial Data Analysis

As serial data becomes the dominant standard for data transmission, fast and accurate signal analysis is critical. LeCroy Corporation's industry-leading expertise in serial data analysis has proven itself in the computer, consumer electronics, and semi-conductor markets, particularly in serial data bus development. In addition, by offering the best tools for physical layer testing, along with protocol testing systems for the message layer, LeCroy provides the ultimate toolset for the design cycle. Other key standards are equally well served by industry-preferred test devices for PCI Express,<sup>®</sup> SAS, SATA, and Ultraband-Wideband.

### Expanding Our Lead in Communications Standards

The rapid introduction of new consumer devices and capabilities is placing a high priority on interoperability and the flawless implementation of digital communications standards like PCI Express, SAS, SATA, and Wireless USB. With its broad range of protocol analyzers, LeCroy now offers the leading test solutions for computer I/O, storage, and networking protocols.

### Superior Analog and Digital Signal Analyzers

LeCroy analyzers offer the industry's best toolset for WaveShape analysis—the capturing, viewing, and analyzing of highly complex electronic signals. Based on unique hardware and software architecture, these powerful tools enable engineers to analyze signal performance in minute detail. This revolutionary technology is available in the Wave family of oscilloscopes—from innovative new bench scopes to the faster sampling rate, longer memory, and superior processing power of our high-end scopes. This technology also underpins the company's dominant systems in power analysis and automotive bus testing.



## SOLUTIONS SPANNING DIVERSE INDUSTRIES AND APPLICATIONS

LeCroy high-performance oscilloscopes and analyzers are used across a diverse range of industries. Our close relationships with leading companies in sectors such as computers, semiconductors, consumer electronics, data storage, and automotive electronics, help us to continuously refine our products to better address the requirements of the latest technologies. It is the main reason why engineers and research professionals worldwide rely on our systems for their most demanding test and measurement applications.

### Computer and Semiconductor Design

The transition to the digital technology world has required a new generation of test and measurement instruments. In the computer and semiconductor industry, LeCroy is firmly established as a leader in the market for PCI Express compliance and debug tools like PCI *Tracer/Trainer*. Our SDA-PCIE-G2 tool dramatically simplifies the new measurements necessary to qualify the PCI Express interface and, thus, fully evaluate the integrity of new serial data product designs. Our SDA-SATA software package is the only commercially available test suite that meets the specification requirements for both Gen1 and Gen2, as well as Serial ATA transmitter compliance testing.

### Consumer Electronics

In the consumer marketplace where electronic products tend to be thinner, lighter, faster, and more highly connected, interoperability is the key to success. A myriad of new devices is required to share data and seamlessly communicate with each other quickly and accurately. LeCroy expert systems provide advanced protocol analysis, precisely monitoring communications traffic and diagnosing operational problems to ensure compliance with interoperability standards such as PCI Express, SAS, SATA, USB, Wireless USB, Bluetooth®, Fibre Channel, and more.

### Automotive and Industrial Electronics

Automotive electronics is an area where exciting new digital innovations are coming to market. LeCroy oscilloscopes are helping automotive manufacturers design and test enhancements such as the latest in-dash screens, global positioning systems (GPS), lighting, and collision prevention systems. In this sector, our CANbus TDM/TD test system has established itself as the premier serial data solution. It is the first system that moves up the protocol stack from the physical layer to data-level measurements.

### Power Measurement

As manufacturers (especially those in the semiconductor, computer, and medical industries) bring more sophisticated products to market, there is a corresponding demand for more flexible and powerful instrumentation to test and measure the advanced power supplies their products incorporate. LeCroy's PowerMeasure Systems provide an exceptional ability to measure and analyze the operating characteristics of power conversion devices and circuits. Providing unmatched performance with a complete set of measurement tools, each system includes an easy-to-use yet high-performance digital storage oscilloscope, high-performance current probe and differential voltage amplifier, and PMA2 PowerMeasure Analysis software.



### Telecommunications

From wireless devices to broadband networks and fiber-optic transmission lines, signal complexity and transmission rates are increasing. Engineers working on next generation Telco systems must ensure that network products can accurately send and receive complex data streams. LeCroy breakthroughs in serial data analysis are enabling them to keep pace by using instruments designed to validate product performance and reliability.

### Military and Aerospace Electronics

The growing connectivity and sophistication of digital control systems is fueling productivity advances in industry and government. These systems are driven by massive amounts of serial data requiring tremendous bandwidths. LeCroy's proprietary X-Stream technology, a revolutionary method of data transfer and processing, enables our family of oscilloscopes and analyzers to perform 10–100x faster analysis of complex signals—the fastest in the industry.





## A 40-YEAR TRACK RECORD OF TECHNOLOGY INNOVATION

LeCroy is a global technology innovator with a 40-year successful track record of providing high-performance systems that are faster, more accurate, and more affordable. Our reputation for bringing cutting-edge systems to market is founded on our core competency in signal acquisition and analysis, and our ability to develop and leverage innovative technologies and capabilities.

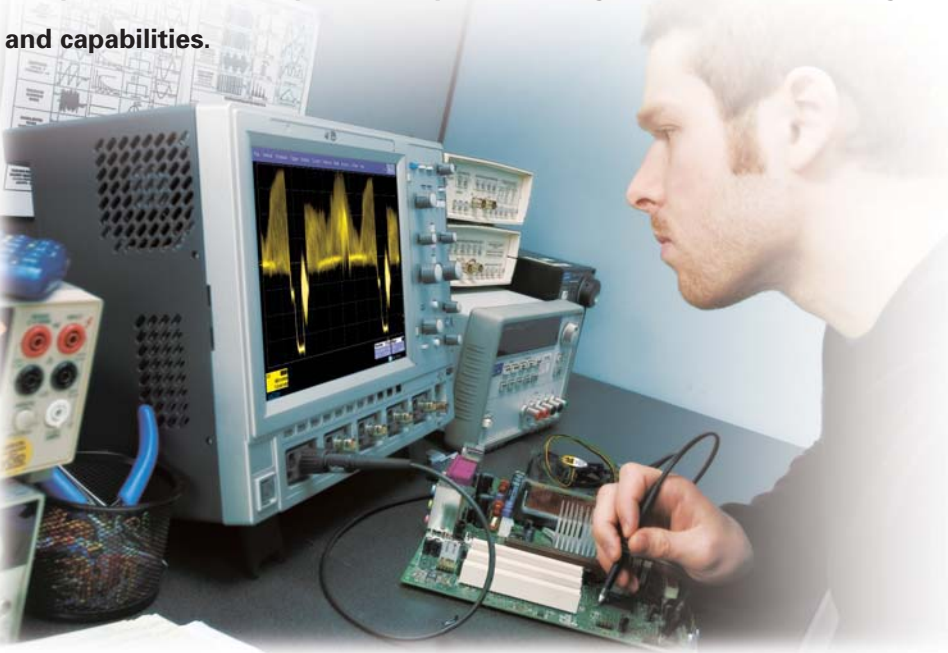

### MAUI Scope Operating System

LeCroy's proprietary MAUI software gives users high-speed throughput and customizable analysis never before seen in an oscilloscope. Based on Microsoft® COM technology, its architecture allows users to easily create their own instrument by choosing the necessary components from LeCroy's vast selection of capabilities, or adding their own custom ones. MAUI works in tandem with LeCroy's X-Stream hardware architecture to provide unparalleled performance.

### SiGe Technology

One of the most significant accomplishments in the design of LeCroy's line of digital oscilloscopes is the use of Silicon Germanium (SiGe) technology, which allows amplifiers and other devices to operate with a combination of high-speed, low-noise, high-gain, and excellent linearity capabilities. This unique pairing enables our oscilloscopes to achieve levels of performance not previously possible.

### Jumping the Power Curve

Pushing the limits of silicon-based processing, the exclusive LeCroy Digital Bandwidth Interleaving (DBI) technology is a breakthrough invention (patent pending) that extends the bandwidth of any silicon platform by up to four times. Sampling scopes have been reinvented with the availability of the new Near Real Time Oscilloscope (NRO) WaveExpert. Enabled by Accelerated Throughput Architecture (ATA – patent pending), WaveExpert offers 100 GHz bandwidth and signal acquisition speeds 100 times faster than conventional sampling scopes.

### WaveScan™ Advanced Search

Available on most LeCroy oscilloscopes, the new WaveScan enables you to search for and find unusual events during a single acquisition or scan for these events from many acquisitions over a long period of time. Just select from more than 20 parameter measurements, apply a search condition, and begin scanning. It's that simple. It means quicker understanding and faster debugging.

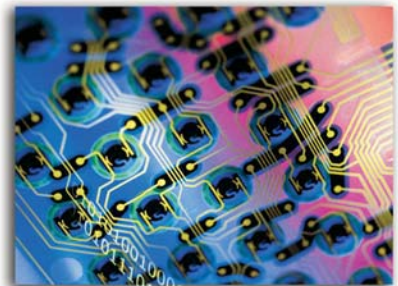

## SDA 18000, SDA 11000 & SDA 9000

### RAISING THE BAR FOR SERIAL DATA ANALYSIS

**T**he SDA 18000 serial data analyzer is a true breakthrough in signal analysis. It delivers the industry's highest bandwidth—18 GHz—as well as a combined highest sampling rate of 60 GS/s and longest memory of up to 150 million points available in a real-time test instrument.

Based on the industry's most advanced digital oscilloscope platform, the SDA 18000 is a 4-channel real-time serial data analyzer that offers outstanding analysis capabilities that normally would require two or three different analyzers.

Put these benefits to work for you:

- Pristine signal integrity measurements
- Precise jitter analysis
- Powerful advanced waveform analysis
- Stable, repeatable results

#### Sampling Speed with Real Time Capabilities

The SDA 18000 has sufficient bandwidth to allow real time measurements of the fastest serial data standards entering active development today, including 10 Gb/s Ethernet, and Fibre Channel 8.5. Capturing the data stream in real time with multiple points per transition edge with digitizing resolution as low as 16 ps per point allows the SDA 18000 to recover the embedded clock and phase lock to it, for precise jitter measurements. Now a complete breakdown of jitter composition is possible, even

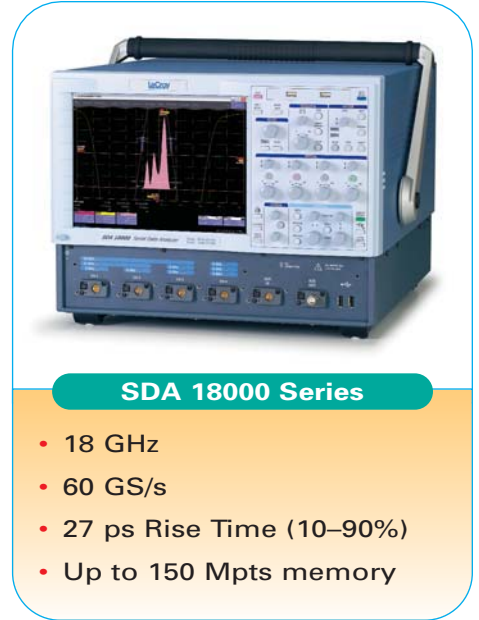

**SDA 18000 Series**

- 18 GHz
- 60 GS/s
- 27 ps Rise Time (10–90%)
- Up to 150 Mpts memory

#### With WaveScan Advanced Search

*Find problems that triggers won't find.  
Analyze faster, understand results quicker.*

#### Data Rate Configuration Chart

Standard	Data Rate/ Symbol Rate	Rise Time, ps min. (10%–90%)	Minimum Bandwidth
PCI Express® Gen2	5 Gb/s	30 ps	> 10 GHz (PCI Express Compliance Testing)
SATA II/III	Gen2 3 Gb/s Gen3 6 Gb/s	100 ps (Gen1) 67 ps (Gen2)	> 10 GHz (SATA II/III)
XAUI X2	6.25 Gb/s	30 ps	SDA 11000/D11000PS
Fibre Channel 8.5	8.5 Gb/s	30 ps	18 GHz (Fibre Channel)
SAS II/SAS 6G	SAS II 3 Gb/s SAS 6G 6 Gb/s	67 ps (Gen1) 33 ps (Gen2)	> 10 GHz (SAS II/SAS 6G)
FB-DIMM	FBD1 4.8 Gb/s FBD2 9.6 Gb/s	30 ps	> 10 GHz (FB-DIMM)
10 Gb Ethernet			18 GHz (10 Gb Ethernet)

with non-repeating patterns or “live” data. Sampling at 60 GS/s assures excellent waveform capture fidelity; and the 150 million points memory depth allows the capture of long serial data patterns. This is most helpful in locating the sources of low frequency jitter modulation or tracking spread spectrum clocked (SSC) data.

#### SDA 11000 and SDA 9000 – For Mid-speed Serial Data

The 11 GHz SDA 11000 is ideal for analysis in systems with serial data rates up to 6 Gb/s, while the 9 GHz SDA 9000 supports rates up to 5 Gb/s. Both feature an architecture that supports a choice of 2 active channels at full bandwidth, 1 high bandwidth channel with (2) 6 GHz channels, or (4) 6 GHz channels. Both instruments share the same advanced serial data and jitter analysis capabilities of the SDA 18000, including Q-Scale analysis.



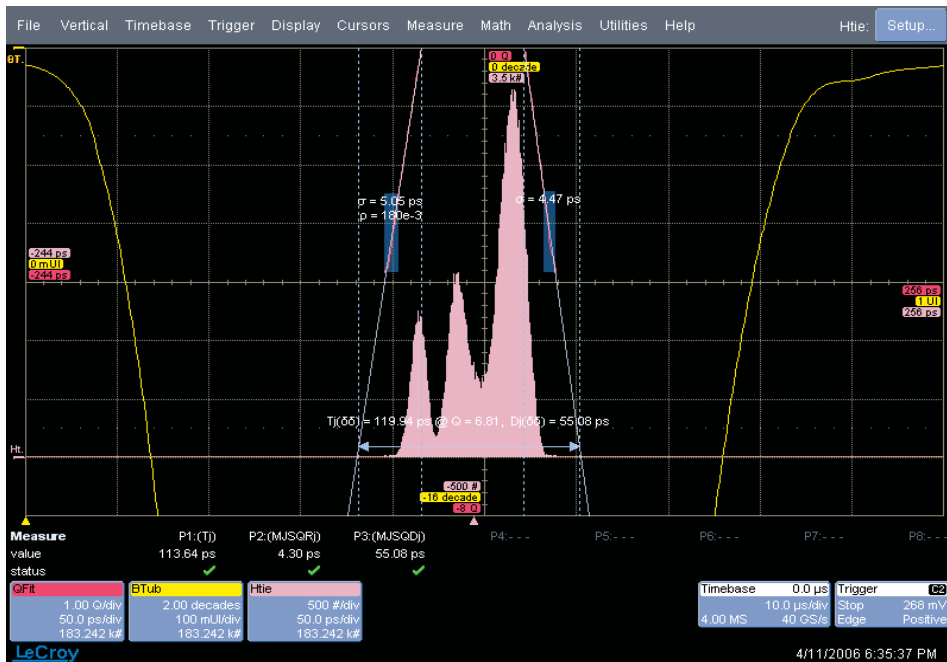

## New Q-Scale Analysis for Unique Insight

A remarkable innovation included with the SDA Series is the Q-Scale analysis and plot view, a dramatic improvement that provides much more insight into jitter than any other method.

Q-Scale analysis uses an alternative method of breaking down jitter components. It identifies components more accurately than the conventional method of just showing random jitter. It also incorporates improvements in extrapolating the jitter histogram tails, thereby improving the accuracy, stability, and convergence time.

The Q-Scale plot provides a visual representation of jitter breakdown, which is much more intuitive than a traditional bathtub curve. Q-Scale also allows engineers to locate the source of jitter in their circuit faster than with the tools used in the past.

## X-Stream Architecture

An innovative and highly efficient software architecture optimized for complex processing of large waveforms, X-Stream

offers the fastest processing speed in the industry. It pipelines data at 10 Gb/s into acquisition memory. It is then packetized into segments small enough to allow the remaining processing to take place in the processor cache memory—eliminating the need for constant external memory “fetches.” This dramatically speeds up complex waveform processing.

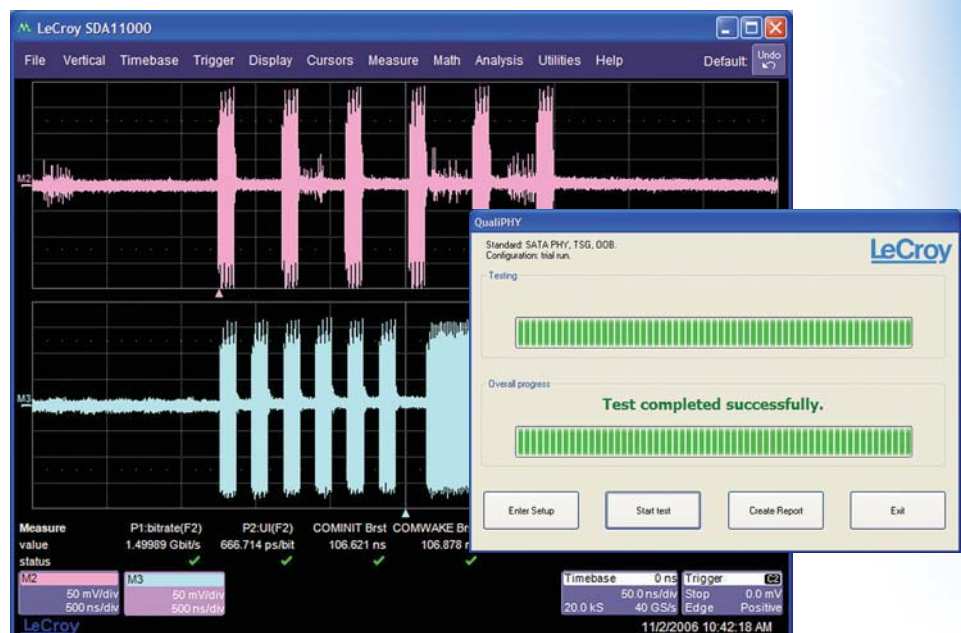

## QualiPHY™ Compliance Software

This new software provides a compliance framework for testing high-speed serial data applications including SATA, FB-DIMM, UWB, ENET, USB, PCI Express, SAS and HDMI. It features superior measurement accuracy, exceptional ease of use, and retrievable reports that can be output in multiple formats.

Designed to offer a common, intuitive user interface across the industry's most popular serial data standards, QualiPHY is an MS Windows-based application configured with one or more serial data compliance modules. This cost-effective modular architecture is an ideal test solution for a host of industry segments such as computers and computer equipment, wireless and mobile multi-service (voice/data) products and systems, cable and IPTV set-top boxes, and vending and gaming machines. Supporting LeCroy's complete compliance test solution packages, QualiPHY can be added to any of LeCroy's real-time or sampling scopes and can be used with LeCroy protocol analyzers, test fixtures and probes for specific standard configurations

# WAVEEXPERT® SERIES

## UNPARALLELED ACCURACY, THROUGHPUT, AND ANALYSIS

In recent years, the development of equivalent-time scopes has enabled measurements of high-speed serial and optical components and sub-systems by providing plug-in sampling modules that cover wide bandwidths, albeit at the expense of acquisition speeds.

The WaveExpert Series is LeCroy's newest line of equivalent-time sampling scopes designed to provide a superior Serial Data Analysis (SDA) tool for the growing high-speed digital and optical data markets.

### Exceptional Capabilities for Serial Data Testing

- 10 MS/s acquisition rate
- 512 Mpts waveform memory
- < 250 fs rms (typical) timebase jitter
- Built-in pattern lock
- Jitter and S-parameter measurement packages
- Plug-in modules with up to 100 GHz bandwidth
- MATLAB® Connectivity
- Open Windows® XP Pro OS

This new series is composed of flexible, modular oscilloscopes equipped with four sampling channels that can accommodate any combination of electrical, optical, clock recovery, or PRBS pattern generator modules available with the instruments.

The WaveExpert Series combines fast acquisition speed and deep memory with powerful data analysis packages for jitter and TDR thus serving as the single most effective tool available today for testing high-speed serial data. The throughput capabilities are powered by a patented timebase, Coherent Interleaved Sampling (CIS). It is also available with a High Stability Option that reduces trigger jitter further down to 250 fs rms. That, coupled with the only 100 GHz electrical sampling module currently available, they form an essential pair for high data rate optical testing at 40 Gb/s and beyond.



### WaveExpert SDA100G

- 20 GHz–100 GHz
- 10 MS/s Acquisition
- 128 MS/Ch Memory
- Jitter Analysis Package
- 10.4" SVGA TFT

### WaveExpert NRO 9000

### WaveExpert WE 9000

### With WaveScan Advanced Search

*Find problems that triggers won't find. Analyze faster, understand results quicker.*

### Jitter Analysis Using Q-Scale

The innovative Q-Scale jitter analysis software used in WaveExpert oscilloscopes provides the most accurate jitter measurements regardless of the jitter scenario. The Q-Scale method uses the measured jitter distribution to determine the random and bounded jitter components. When a repeating data pattern is used, the Data Dependent Jitter (DDJ) can be removed from the jitter measurement, resulting in the first instrument that can measure Bounded Uncorrelated Jitter (BUJ).

The benefit of Q-Scale is that it accurately measures the random and bounded uncorrelated jitter components even under conditions where crosstalk, power supply noise, and other pseudorandom sources are present.

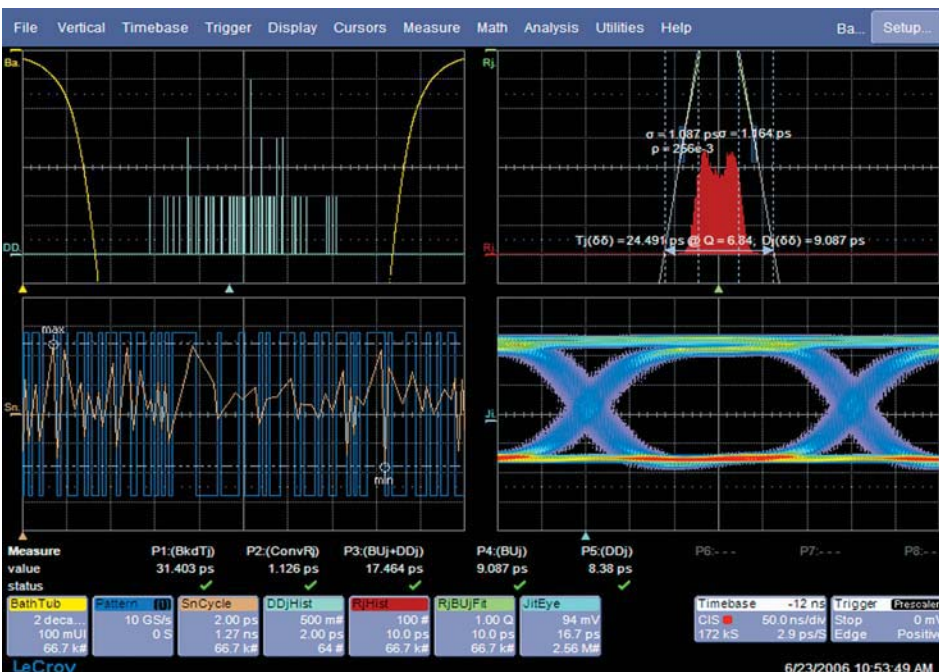



### TDR/S-Parameter Measurements

The WaveExpert Series sampling oscilloscopes include a TDR package for signal integrity measurements for both Single-ended and Differential devices. A 20 GHz TDR module (ST-20) is available, which can be accommodated in any of the four available channels on the WaveExpert oscilloscope, to make Single-ended or Differential TDR/TDT measurements.

The ST-20 (20 GHz module) generates a fast step with a rise time of 20 ps, which can help quantify closely spaced discontinuities in backplanes, PC boards, etc.

The WaveExpert Series oscilloscopes are capable of acquiring up to 100,000 points in TDR mode. This enables testing of backplanes etc., which usually require a large time acquisition window, with high resolution in the time domain.

Reference plane Calibration techniques such as SHORT-LOAD (SL) are available to correct for the measurement setup, including cables, adapters, test fixtures, etc., thus improving the accuracy of TDR and resulting S-parameter measurements.

### Optical NRZ and RZ Measurements

The WaveExpert oscilloscope with its fast coherent timebase provides a level of throughput rivaled only by bit error rate test systems. Eye patterns consisting of millions of samples can be measured in seconds, thus providing the highest level of accuracy and repeatability for a complete range of eye-based measurements such as extinction ratio, modulation amplitude, eye height, and eye width. With its fast acquisition, the WaveExpert oscilloscope performs the most accurate eye jitter measurements, without the timebase drift problems present in standard equivalent-time scopes.

The WaveExpert oscilloscope comes standard with a complete set of optical and electrical compliance masks. In addition to those supplied with the instru-

ment, custom masks can easily be added to the instrument via an easy-to-use mask data base editor.

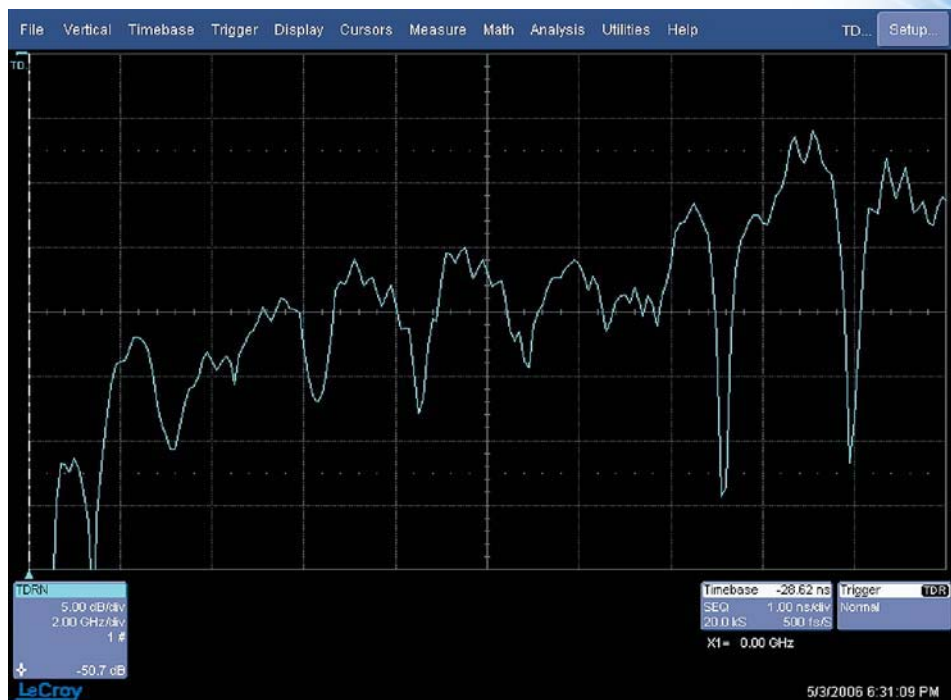
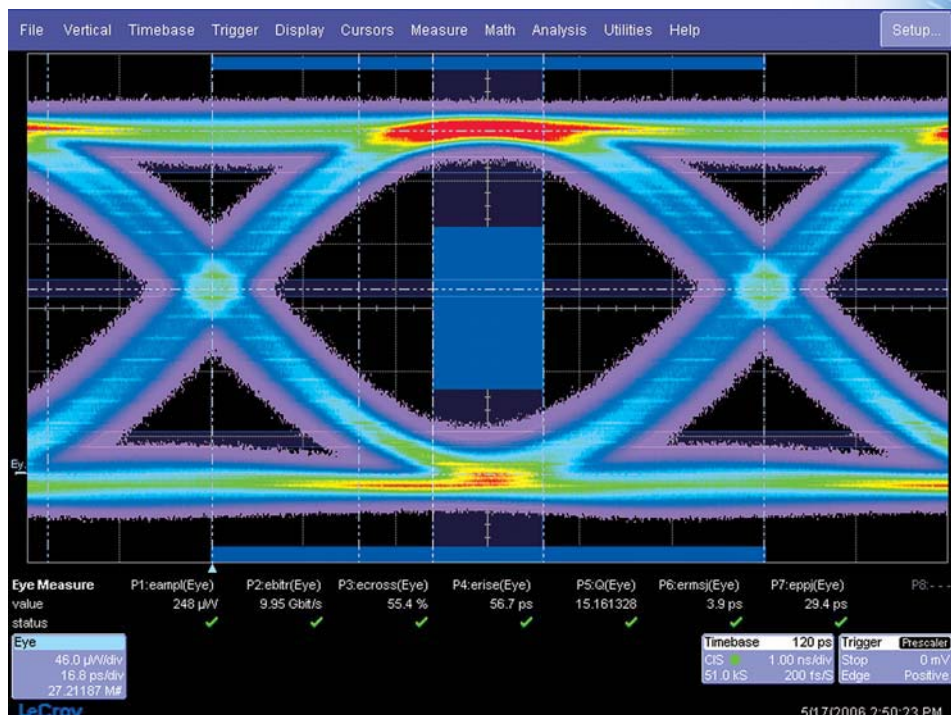

## SDA SERIES & DDA SERIES

### A TOTAL SOLUTION FOR SERIAL DATA ANALYSIS

Optical and electrical serial data has become a dominant form of data transmission. The LeCroy Serial Data Analyzer (SDA) Series, which features the ASDA-J software, is the first family of devices to combine sampling oscilloscopes, timing interval analyzers (TIAs), and bit error rate test sets in a single jitter engine. With these powerful capabilities in one instrument, engineers can easily view and understand the differences between these standard methods.

#### Thorough Jitter Analysis

Jitter is the most critical measurement in physical layer serial data analysis. LeCroy SDAs can measure a full set of clock and data jitter parameters as well as Time Interval Error (TIE) measurements for data signals. With the fully featured ASDA-J package, engineers can take advantage of the most effective jitter analysis tool available today, with support for the following advanced capabilities:

- **Jitter Wizard**

This function guides the user through the instrument setup and automatically detects the sampling rate, bit rate, and pattern length of the signal to achieve the highest accuracy.

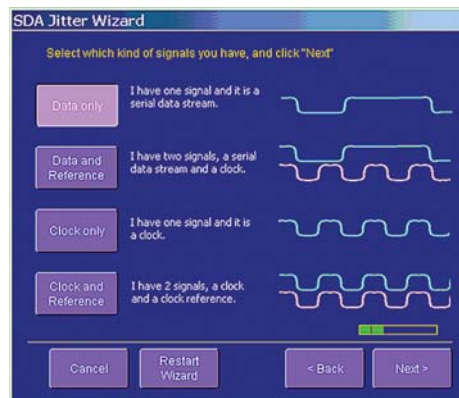

- **Edge-to-edge Jitter**

This function enables the SDA to correlate its jitter measurements with both sampling oscilloscopes and TIA-based instruments.

#### With WaveScan Advanced Search

*Find problems that triggers won't find.  
Analyze faster, understand results quicker.*



#### SDA Series

- 4 GHz and 6 GHz
- 2.7 Gb/s serial pattern trigger
- Up to 20 GS/s per channel
- 75 ps rise time
- 10.4" SVGA TFT

#### Key Measurements

Several different views are available to display processed data, including a bathtub curve, histograms, time trends, and data dependent jitter. TIE measurements are performed using precise software clock recovery. Other measurements include total, random, and deterministic jitter derived from a histogram.



#### DDA Series

- 3 GHz and 5 GHz
- 10 GS/s per channel
- 20 GS/s dual channel
- 5 GHz trigger
- 10.4" SVGA TFT

#### DDA Series

A unique combination of sophisticated measurement capability and an intuitive user interface makes the DDA 5005A the solution for disk drive analysis. Its X-Stream architecture integrates the SiGe "digitizer-on-a-chip" technology, and a high-speed streaming bus design enables the transfer of data from the ADC to a proprietary acquisition memory.

#### Signal Integrity is Assured

The DDA 5005A analyzer hardware includes a high-quality front end amplifier for low noise and a precise timebase for timing accuracy.

High quality clock sources with jitter  $\leq 1$  ps over a 1 ms period and low trigger jitter (2 ps max.) ensure that the sample points are precisely captured.



## WAVEMASTER® SERIES

### IT'S ALL ABOUT PERFORMANCE

**T**he LeCroy WaveMaster oscilloscope offers a unique combination of high bandwidth, fast sampling speeds, and long memory capture, ideal for digital and communications systems. Equipped with our patented X-Stream technology, its fast data transfer and processing system delivers unprecedented measurement capabilities, at speeds 10–100x faster than those of conventional oscilloscopes.

#### Industrial Strength Capabilities

WaveMaster can sample up to 20 GS/s on 4 channels (with up to 6 GHz bandwidth) into 48 Mpts of memory. Full sample rate is available at any memory length and without compromising speed. Superior timebase performance and very low jitter noise floor make it a truly remarkable instrument. Delivering extremely stable and precise measurements, its high level of accuracy includes:

- 1 ps rms jitter noise floor
- Clock accuracy of  $\pm 1$  ppm

#### With WaveScan Advanced Search

*Find problems that triggers won't find.  
Analyze faster, understand results quicker.*

#### Customization Capabilities

WaveMaster can be fine-tuned to meet specific needs. Custom functions can be created with current third-party analysis packages and inserted directly into the WaveShape Analysis engine, allowing the user to view results directly. A custom user interface can also be developed. These features enable users to complete their measurement and analysis more efficiently.



#### WaveMaster "A" Series

- 4 GHz and 6 GHz
- Up to 20 GS/s per channel
- Up to 100 Mpts memory
- 10.4" SVGA TFT

## WAVEPRO® SERIES

### A POWERFUL SCOPE OFFERING OUTSTANDING VALUE

**W**ith the WavePro 7000A Series, LeCroy put the premium into the performance, not the price. We have made our groundbreaking X-Stream architecture available in the very affordable WavePro range, enabling the oscilloscopes to perform WaveShape Analysis 10–100x faster than any other oscilloscope in the 1 GHz–3 GHz bandwidth class.

#### Intuitive Operation

WavePro eliminates the trade-offs between long memory lengths and fast processing. Familiar controls like timebase, voltage, and cursors can be operated from the front panel or through the touch screen graphical user interface. Users can easily view signals in time, frequency, or statistical domains.

#### With WaveScan Advanced Search

*Find problems that triggers won't find.  
Analyze faster, understand results quicker.*

Visual indications of parameter distributions are also shown as small histogram views called Histicons.



#### WavePro "A" Series

- 1–3 GHz
- 10 GS/s per channel
- 50  $\Omega$  and 1 M $\Omega$  input
- 10.4" SVGA TFT

## WAVEJET® SERIES

### OUTPERFORMS ITS CLASS

The WaveJet 300 Series offers a set of features and capabilities not typically found in a portable oscilloscope. Its small form factor boasts the biggest, brightest, highest resolution display in this class. It also provides connectivity through USB, GPIB, and Ethernet. With a display update rate of up to 3600 wfms/s and the unique Replay mode, the WaveJet can not only show you glitches and rare events but can also go back in time and let you take a closer look, providing valuable information that a fast display alone cannot provide. These features, plus the longest memory length available in a small portable oscilloscope, make the WaveJet truly unique in the 100 MHz to 500 MHz bandwidth range.

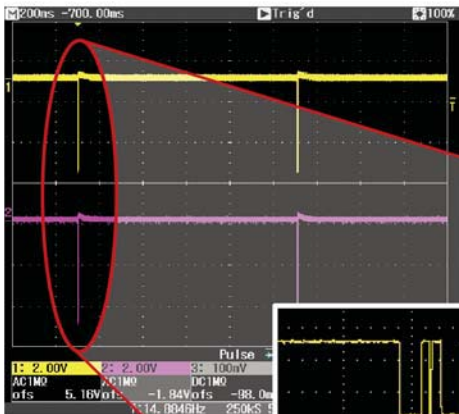

#### Long Capture

Low bandwidth portable oscilloscopes often suffer from very short memory lengths that prevent you from using the oscilloscope to its full potential. The

WaveJet eliminates the tradeoff between high sample rate and long capture time by providing up to 200x the capture time at 2 GS/s compared to other oscilloscopes in its class. The long memory makes WaveJet the ideal oscilloscope for viewing a mix of low-frequency and high-frequency signals, or low-speed signals with fast edges.

#### Connectivity

Documenting your work is easy using the front mounted USB port on the WaveJet. Simply press the Print button on the front panel to quickly save screen images to your USB memory device.

#### Replay

It is important to have a fast oscilloscope display for viewing rare events. However, most oscilloscopes show those rare events briefly and then disappear. The WaveJet offers a fast update of up to 3600 wfms/s, and Replay a new capability for looking at signal history. It enables the review of individual acquisitions and the use of cursors or parameters to measure them to better understand anomalies in the signal. Replay provides the ability to recall at up to 1024 events.

Zoom in on long captures to view detail; high sample rate is maintained.

#### WaveJet 300

<b>Bandwidth</b>	100 MHz–500 MHz
<b>SR – Per Ch</b>	1 GS/s
<b>SR – Interleaved</b>	2 GS/s
<b>Std. Memory – Per Ch</b>	500 kpts
<b>Max. Memory</b>	500 kpts
<b>Display</b>	7.5" VGA
<b>Footprint-Depth/Weight</b>	4"/7 lbs.



# WAVESURFER® SERIES

## ESSENTIAL TOOLS FOR EFFICIENT VALIDATION AND DEBUG

Anyone can appreciate a well designed product with all the right performance, features, and design elements. The WaveSurfer Xs oscilloscope is just such a product. Validation and debug is fast and simple. The big display (but small footprint), simplified front panel, and graphical touch screen user interface will allow you to be efficient in a matter of minutes. And you'll love how it fits your budget.

### Great Tools You've Always Wanted

How about a fast viewing analog display mode (WaveStream™) that can be toggled ON or OFF? How about a capture and search tool (WaveScan™) that lets you search for events you can't trigger on? How about an I<sup>2</sup>C serial trigger that lets you trigger conditionally on data values, or serial decoders (SPI or I<sup>2</sup>C) that are intuitively overlaid on the waveform and make understanding serial data easy? How about fast, responsive long memory that works quickly with measurements, math, and decodes? Or a mixed signal option? WaveSurfer provides all this and more.

### Perfectly Balanced

The WaveSurfer Xs oscilloscope is designed for fast and efficient validation and debug. Its simple, uncluttered, touch screen interface has what you need, where you need it. It will quickly earn a permanent place on your bench.

### A Great Combination

You'll be hard pressed to find a scope in its class that offers a better combination of performance, features, and value. With 2-channel and 4-channel configurations and bandwidths from 200 MHz to 1 GHz, it's tough to beat the value of a WaveSurfer Xs.

### WaveStream™ Fast Viewing Mode

WaveStream provides a vibrant, intensity graded (256 levels) display with a fast update to closely simulate the look and feel of an analog oscilloscope. Turn WaveStream ON or OFF, and adjust intensity, using the front panel knob. Use it only when you want to.

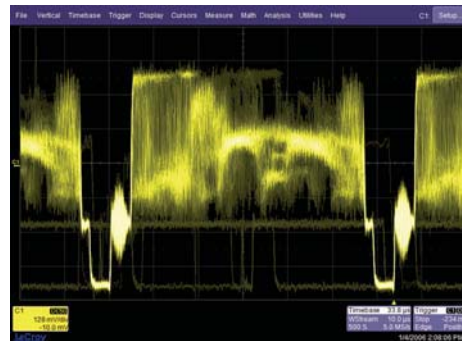

### WaveScan Advanced Search

**Locate Problems Triggers Won't Find**  
WaveScan is a powerful tool that provides the ability to locate unusual events in a single capture, or scan for an event in many acquisitions over a long period of time using more than 20 different search/scan modes. WaveScan uses measurement-based scanning modes, like frequency, to show statistical distribution of events. It overlays events for a quick and simple visual comparison.

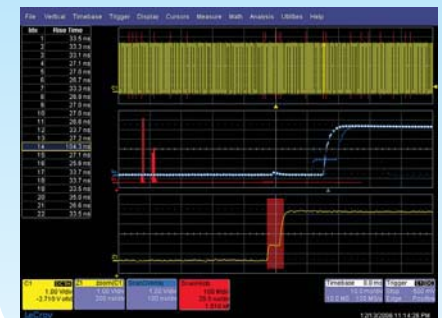

### WaveSurfer 400

### WaveSurfer Xs

<b>Bandwidth</b>	200 MHz–500 MHz	200 MHz–1 GHz
<b>SR – Per Ch</b>	1 GS/S	2.5 GS/s
<b>SR – Interleaved</b>	2 GS/S	2.5 GS/s (5 GS/s on WS 104Xs)
<b>Std. Memory – Per Ch</b>	1 Mpts	2.5 Mpts
<b>Std. Memory – Interleaved</b>	2 Mpts	2.5 Mpts
<b>Max. Memory</b>	2 Mpts	10 Mpts
<b>Display</b>	10.4" SVGA touch screen	10.4" SVGA touch screen
<b>Footprint-Depth/Weight</b>	6"/15 lbs.	6"/15.5 lbs.
<b>Application Packages/Analysis</b>	Elec. Telecom Mask Test, Mixed Signal	Elec. Telecom Mask Test, Mixed Signal I <sup>2</sup> C SPI Trigger & Decode

## WAVERUNNER® SERIES

### OUTSTANDING CAPABILITIES FOR EVERYDAY TESTING

**W**aveRunner Xi Series gives you everything with no compromises — great performance, big display, and small footprint along with WaveStream fast viewing mode, enhanced standard trigger capability, and much more. WaveRunner Xi is the perfect solution whether your signals are fast or slow. No matter what your need, you can put the precision, performance, and capability of WaveRunner Xi to work for you.

#### Complete Capability— 100% Test Coverage

WaveRunner Xi is the most complete “problem solving” oscilloscope from 400 MHz to 2 GHz with great performance, an unbelievable big display/small footprint form factor, and a multitude of fast viewing, SMART/serial data triggering, scanning, and WaveShape Analysis capabilities for fast or slow signals. No matter what your need, you can put the precision, performance, and capability of WaveRunner Xi to work for you.

#### Great Performance

With 5 GS/s and 10 Mpts standard on every channel (up to 10 GS/s interleaved with 62Xi, 64Xi, 104Xi, and 204Xi), you can be assured of precise measurements of fast signals, and long captures of slow-speed events.

#### Powerful WaveShape Analysis

The LeCroy WaveRunner Xi is the most powerful and capable scope available in

its class. Basic system validation using advanced triggers, fast viewing modes, measurement parameters, or serial decodes is simple and easy. Advanced debug, multi-domain analysis, and WaveShape analysis are possible with tools unique to WaveRunner Xi. Optional application packages help you make sense of well defined problems.

#### Advanced Features

WaveRunner Xi also contains many debugging and analysis features not available in other oscilloscopes in this class. Some examples are:

- Sequence Acquisition Mode to optimize capture, viewing, and understanding of events that are spaced far apart in time
- Extensive pass/fail capability with multiple conditions and limits, and flexibility to choose the action that is enabled when the conditions are satisfied

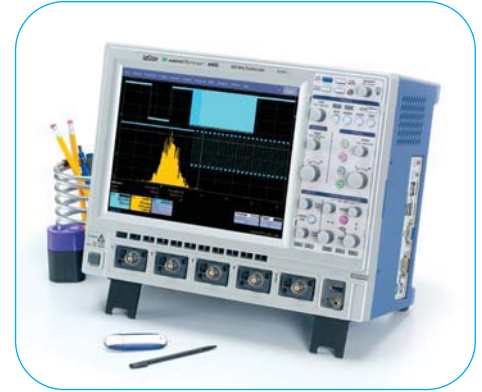

#### WaveScan Advanced Search

**Locate Problems Triggers Won't Find**  
*WaveScan is a powerful tool that provides the ability to locate unusual events in a single capture, or scan for an event in many acquisitions over a long period of time using more than 20 different search/scan modes. WaveScan uses measurement-based scanning modes, like frequency, to show statistical distribution of events. It overlays events for a quick and simple visual comparison.*

- Creation of user-customized measurement parameters or math functions using Excel, MATLAB®, Mathcad®, or VBScripts (some optional)
- Characterization of PWM signals and other data in a graphical mode (Track) to enable fast understanding of signal modulation or behavior (optional)

#### WaveRunner Xi

#### WaveRunner 6000A

<b>Bandwidth</b>	400 MHz–2 GHz	350 MHz–2 GHz
<b>SR – Per Ch</b>	5 GS/S	5 GS/s
<b>SR – Interleaved</b>	10 GS/s*	10 GS/s
<b>Std. Memory – Per Ch</b>	5 Mpts	4 Mpts
<b>Std. Memory – Interleaved</b>	10 Mpts	8 Mpts
<b>Max. Memory</b>	25 Mpts†	24 Mpts†
<b>Display</b>	10.4" SVGA touch screen	8.4" SVGA touch screen
<b>Footprint-Depth/Weight</b>	6"/15.5 lbs.	14.3"/22 lbs.
<b>Application Packages/Analysis</b>	Mixed Signal, CANbus, I <sup>2</sup> C SPI, Power, EMC, Jitter/Timing, Digital Filter, Serial Data Mask, Disk Drive Measurement	Mixed Signal, CANbus, Power, EMC, Jitter/Timing, Digital Filter, Serial Data Mask, Disk Drive Measurement, ENET, USB 2.0

\*600 MHz only †Interleaved



## PROBES

### OPTIMUM CONNECTION AND SIGNAL CAPTURE

**H**igh-performance probes are an essential tool for accurate signal capture. Consequently, LeCroy offers an extensive range of probes to meet virtually every application need. The probes are optimized for use with LeCroy oscilloscopes, and perform to the same high standards as all LeCroy products. The most recent LeCroy probe system sets new standards for wideband signal connection to test instruments.

#### HFP Series – Active Voltage Probes

This series of probes has a versatile, small, and lightweight design with high bandwidth from 1 GHz to 2.5 GHz. The HFP Series includes five interchangeable styles of tips to make probing easy. In addition to a traditional straight probe tip, a sharp tip allows easier access to tightly-packed test points and circuit vias.

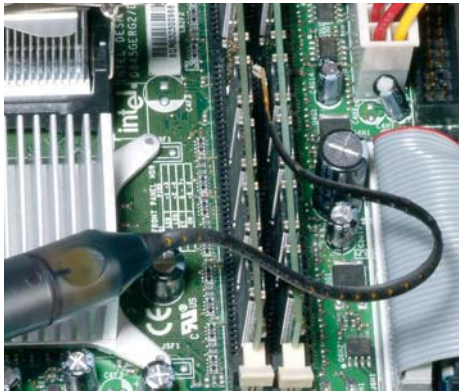

#### High Bandwidth Differential Probes

The wideband WaveLink® probe system offers unprecedented flexibility for probe interconnection. Its unique adjustable tips are ideal for restricted spaces. They are the first differential probes to employ SiGe technology, enabling extremely accurate signal measurement.



#### Differential Amplifiers and Probes

The DA18000 Differential Amplifier is a very high bandwidth DC coupled differential amplifier with a true 100  $\Omega$  balanced input. It features high common mode rejection, low noise, and is designed to be used exclusively with the SDA 18000 Serial Data Analyzer. The amplifier has unity gain, to maximize the signal to noise performance when used with the lower amplitude signal voltages common in higher data rate systems.

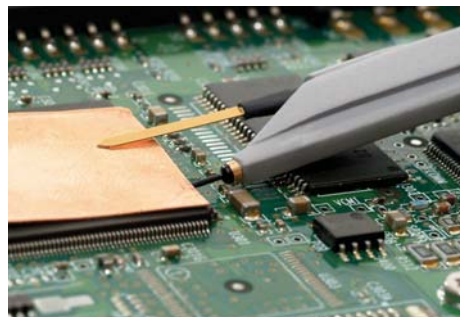

#### ZS Series High Impedance Active Probes

The ZS Series probes provide high impedance and an extensive set of probe tips and ground accessories to handle a wide range of probing scenarios. The high 1 M $\Omega$  input resistance and low 0.9 pF input capacitance mean this probe is ideal for all frequencies. The ZS Series probes provide full system bandwidth for all LeCroy oscilloscopes having bandwidths of 1 GHz and lower.

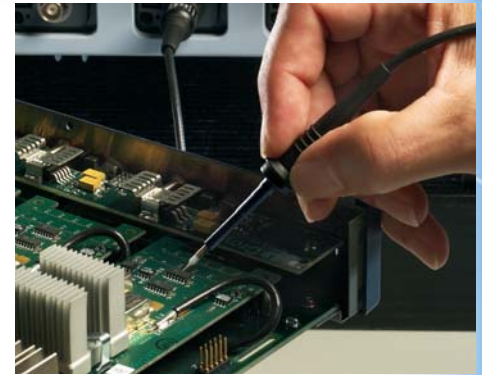

#### Passive Probes

The LeCroy Series of high impedance probes is available in 350 MHz and 500 MHz bandwidths. They include a probe-sense ring for automatic scale factor readout on LeCroy oscilloscopes. These passive probes offer an economical solution for low/medium frequency applications.

#### Additional Probe Options

The LeCroy probe range also includes alternative solutions to provide maximum flexibility for busy engineering departments. These additional options include:

- High frequency, ultra low capacitance probes
- High voltage passive probes
- Current probes

Visit [www.lecroy.com](http://www.lecroy.com) for details

#### O to E Converters

LeCroy offers several wideband multimode optical-to-electrical converters designed for measuring high-speed optical communication signals. Up to 5 GHz frequency range makes these converters ideal for Gigabit Ethernet, Fibre Channel, and SONET/SDA signal measurements. A universal calibrated reference receiver feature is available for most X-Stream model oscilloscopes.

#### Accessories

LeCroy offers a variety of oscilloscope carrying cases, rack mounts, and carts.

COMPLIANCE SOFTWARE

**W**hile multiple serial data standards converge in today's computer motherboards and multimedia equipment, device designers and their team members must rely on high-performance test equipment tools. With the introduction of QualiPHY, LeCroy demonstrates a continuing commitment to deliver unsurpassed value, measurement accuracy, and test flexibility for emerging and legacy standards.

**Automated Compliance Testing**

QualiPHY provides a compliance framework for testing high-speed serial data applications including SATA, FB-DIMM, UWB, ENET, USB, PCI Express, SAS and HDMI. It features superior measurement accuracy, exceptional ease of use, and retrievable reports that can be output in multiple formats.

Designed from the ground up to offer a common, intuitive user interface across the industry's most popular serial data standards, QualiPHY is an MS Windows-based application configured with one or more serial data compliance modules. It offers complete automation for system level preproduction tests; reporting in multiple formats for engineers conducting statistical analysis; access to live signals from scopes in remote locations; and demonstrations of device performance for chip vendors and their customers.

- Friendly graphical user interface
- Professional report of all results including margin analysis
- User-adjustable compliance limits
- Complete set of compliance fixtures
- Consistent, repeatable results
- Confirmed accurate by industry standards
- Results database enables quick access to and analysis of historical data
- Suitable for use in production test (Command line/batch mode operation).

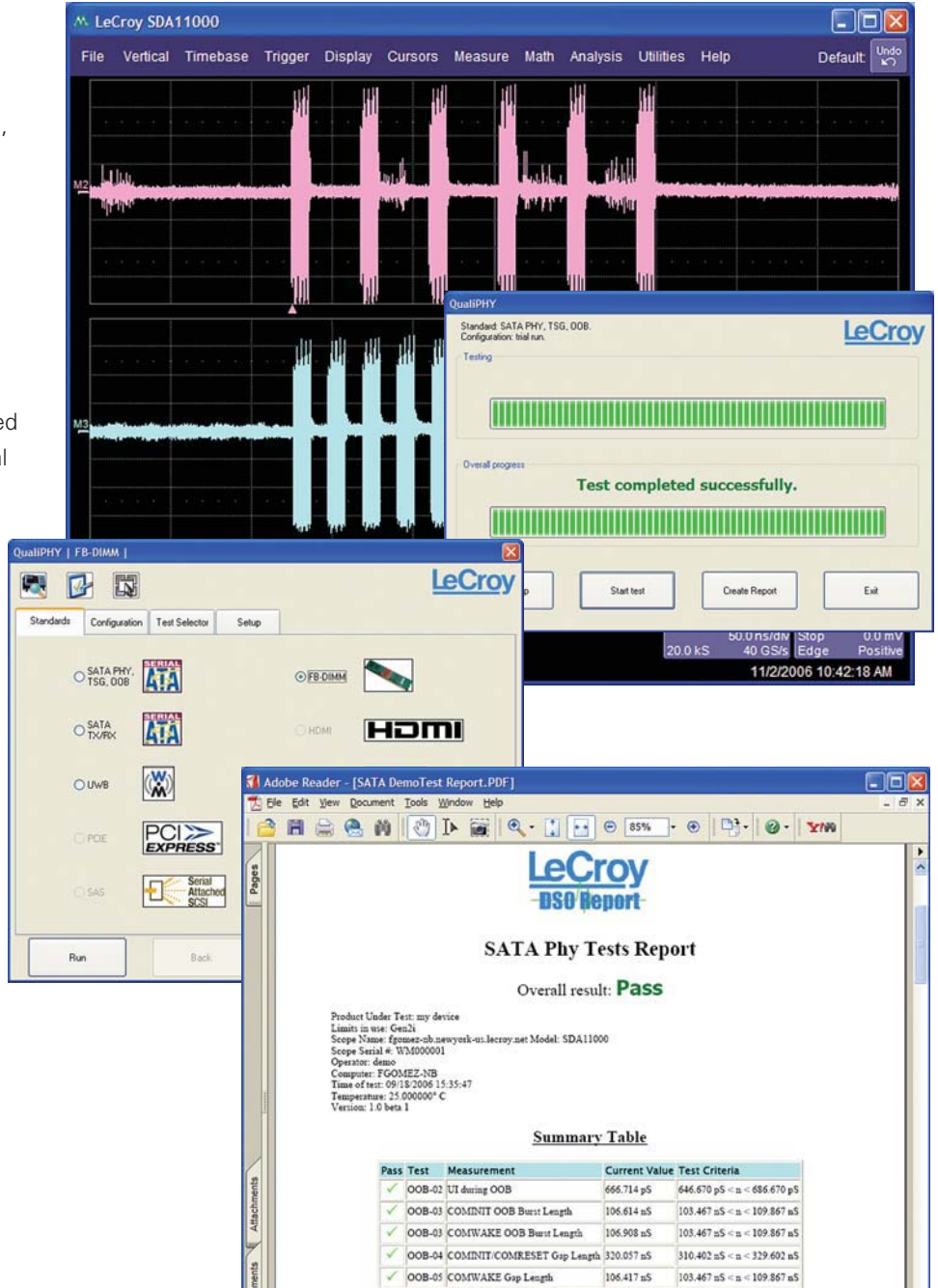

Supporting LeCroy's complete compliance test solution packages, QualiPHY can be added to any of LeCroy's real-time or sampling scopes and can be used with LeCroy protocol analyzers, test fixtures and probes for specific standard configurations.



## ADVANCED SEARCH AND ANALYSIS

**A** new capability available on most LeCroy oscilloscopes, WaveScan provides the ability to locate unusual events in a single capture (i.e., capture and search). It also “scans” for an event in many acquisitions over a long period of time. Select from more than 20 search modes (frequency, rise time, runt, duty cycle, etc.), apply a search condition and begin scanning. It’s that simple.

### Finds Problems That Triggers Won’t Find

The best trigger won’t find all unusual events—a more powerful capability is sometimes needed. Since the scanning “modes” are not simply copies of the hardware triggers, the utility and capability is much higher. For instance, there is no “frequency” trigger in any oscilloscope, however, WaveScan allows for “frequency” to be quickly “searched or scanned.” This allows the user to accumulate a data set

of unusual events that are separated by hours or days, enabling faster debugging.

### Fast Processing Aids Analysis

When used in multiple acquisitions, WaveScan builds on the traditional LeCroy strength of fast processing of data. A LeCroy X-Stream scope will quickly scan millions of events, looking for unusual occurrences, and do it much faster and more efficiently than other oscilloscope can.



### Advanced Analysis Adds to Understanding

The ScanHisto and ScanOverlay capabilities are available on most LeCroy scopes. Found events can be overlaid in a ScanOverlay view to provide a quick and simple comparison of events. In addition, measurement-based scanning modes (like the frequency example given above) permit ScanHistograms to show the statistical distribution of the found events. These analysis tools simplify understanding and enable faster debug.

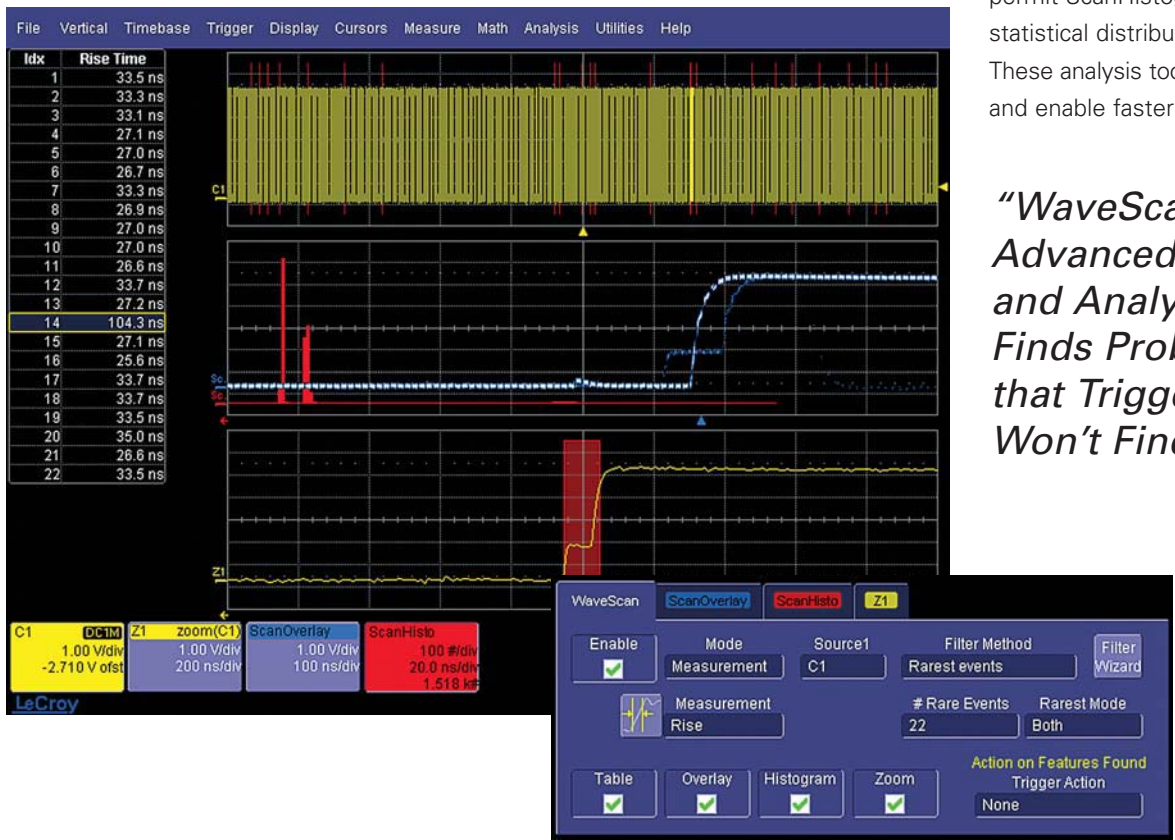

*“WaveScan Advanced Search and Analysis Finds Problems that Triggers Won’t Find”*

# PROTOCOL SOLUTIONS

## THE STANDARD FOR PROTOCOL ANALYSIS

A wide range of protocol analysis and verification test products for advanced high-speed communications are available from LeCroy. These market leading instruments are characterized by easy-to-use and intuitive user interfaces for rapid identification of issues; extensive data summaries, metrics and reports that aid understanding of data traffic; and flexible and extensible platforms for easy upgrades, reconfiguration for new specifications, and investment protection.

### Market Leadership

These products are the first to provide key support for many new and evolving communication specifications. They are the standard for many industry segments, providing a common test platform across the industry. They offer the most comprehensive data presentation and analysis available.

### Viewing Leads to Understanding

The patented CATC Trace display and data report system helps engineers quickly understand and isolate critical issues. Data isn't just displayed, it's organized and identified with information critical to understanding. Integration of trace summaries,

error identification, graphical reports, and test results provide an effective and efficient navigation system.

### Rapid Identification of Issues and Errors

Accurate data capture, automated compliance testing, performance metrics and features such as the unique ZeroTime™ search enable users to rapidly identify problems. Advanced triggering and data filtering allow the user to quickly isolate and focus on the key issues. Built-in data analysis and the ability to export data to other systems allow for more sophisticated analysis and identification of complex issues.



### PCI Express Protocol Analyzer and Exerciser

- For PCI Express IP Cores, semiconductors, add-in-boards, systems, and more
- PE Tracer™ ML system up to x8 lane widths
- PE Tracer™ EML and Summit Gen2, up to 16 lanes
- PE Tracer™ Summit Gen2 supports PCI Express Spec 2.0 (Gen2) traffic at 5 Gb/s per lane.

### Wide Range of Products

Multiple products and configurations are offered within each market segment, allowing users to match their requirements and budget with the test capabilities they need. From simple and inexpensive GO/NO GO manufacturing testers to the industry's most advanced integrated protocol analysis, traffic generation, and command analysis tools, LeCroy analyzers cover a wide range of customer needs and applications.

### Investment Protection

Modular product design, combined with reprogrammable BusEngine™ technology, result in a highly flexible and adaptive platform. Start with the basic product and add new capabilities or higher speeds as needs change. Upgrade your instrument by swapping modules when new specifications are issued. By providing cost-effective upgrade paths and integrated test equipment designs, LeCroy supports and protects your investment.

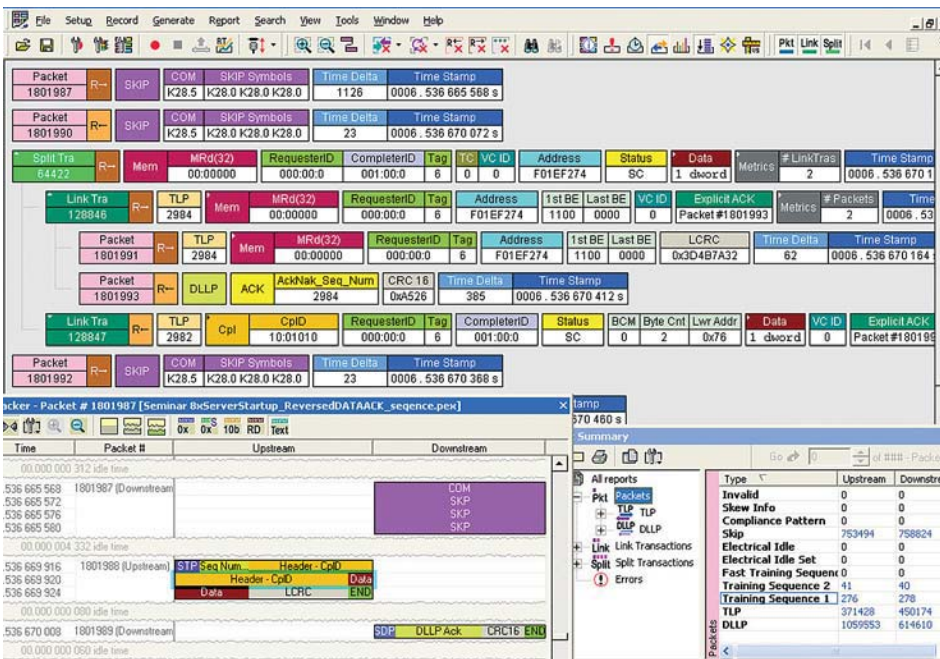



### USB Tracer/Trainer™ Protocol Analyzer and Exerciser



The USB *Tracer/Trainer* system is LeCroy's total solution for cutting edge USB 2.0 and On-the-Go (OTG) development and analysis. Based upon our CATC 2500H, you have the option of choosing either the

USB *Tracer/Trainer* system or the USB *Tracer* module only. Both modules are fully supported by our industry leading CATC Trace™ software, which enhances your ability to develop and debug USB

### SAS InFusion™ and SATA InFusion™



The SAS *InFusion* and SATA *InFusion* error injector and traffic modifier systems are the first of their kind. They enable the injection of errors and modification of traffic in order to verify real-world fault handling. The InFusion system supports a single 3.0G or 1.5G SAS or SATA link and monitors traffic from both directions.

The InFusion traffic modifier is designed to verify recovery characteristics within a

sub-system. In just minutes, an easy-to-use wizard-based interface allows you to create test scenarios. You can change any field, within any frame, as the data moves across the bus. Any primitive or data pattern can be intercepted and changed to a different pattern you specify. This allows for corner case and protocol level error injection for SAS and SATA traffic.

### UWB Tracer™ Protocol Analyzer



Designed to verify functionality and interoperability between WiMedia devices, LeCroy's UWB *Tracer* provides both wireless radio and MAC-PHY interface (MPI) capture of Wireless USB and WiNET protocol traffic. Small and portable, this flexible platform offers pluggable modules

that allow users to upgrade the system in the field. The ability to purchase additional radio modules gives users the peace of mind that LeCroy's Wireless USB analyzer can be enhanced to support future changes in the UWB PHY specifications.

### Bluetooth® Protocol Analyzer and Exerciser



All LeCroy Bluetooth analyzers capture traffic non-intrusively. These devices use hardware triggering to capture real-time events, and filtering to preserve memory, as well as assist in pinpointing data of interest.

Recorder data is displayed using the CATC Trace display. This software graphically

displays all piconet traffic as color-coded packets and offers users advanced functionality for filtering and sorting Bluetooth data, and searching for specific packet types and/or errors.

### SAS Tracer/Trainer™

Quickly and easily transmit valid and invalid 1.5 or 3 Gb/s SAS or SATA traffic, selectively record the exchange and display the results.

### IB Tracer™ 4X Protocol Analyzer

The IB *Tracer* provides advanced triggering, filtering, searching, and reporting for quick analysis of InfiniBand traffic. It supports the IB 1.1 specification and lane reversal of 4X InfiniBand links.

### FC Tracer™ Protocol Analyzer

This analyzer provides accurate, reliable, and complete decodes of FC-2 and FC-4 levels. The display shows captured traffic at the Frame, Sequence, and Exchange levels for chronological and logical viewing of the traffic.

ADD-ON CAPABILITIES TO MEET SPECIFIC NEEDS

**M**uch of the added value of a digital scope is in its ability to provide application specific solutions. LeCroy has worked very closely with users in a variety of industries to create software packages that offer best-in-class performance for specific applications. From Ethernet to Ultra Wireless Broadband applications, LeCroy's software applications span the entire spectrum of serial data signaling standards.

No matter what your needs, LeCroy software packages efficiently extend the scope's capabilities into your specific applications. Each package supplies measurements that use the whole oscilloscope memory. The result is better time accuracy at long time settings, better resolution in the frequency domain, and more measurements extracted from the waveform in the statistical domain.

LeCroy's architecture seamlessly adds the package's capabilities directly into the scope's simple graphic user interface. Measurements are explained on the screen or in the scope's help system so signal calculations are always clear and understandable. Even tracking the trend of a measurement over time is simple. Using these functions, troubleshooting gets easier as the signal make-up becomes clearer.

There is an expandable package for virtually every application. Need more capability? The LeCroy XDEV package enables the creation of custom oscilloscope measurements that run in your scope. No other oscilloscope company provides this type of customized measurement at such an integrated level.

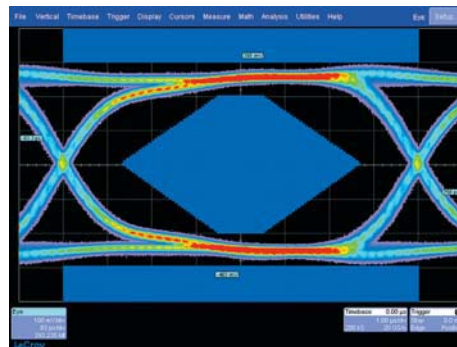

*SDA eye patterns are measured on a continuous record of up to 8M consecutive UI, giving low jitter, high update rates, and the ability to capture single-bit anomalies.*

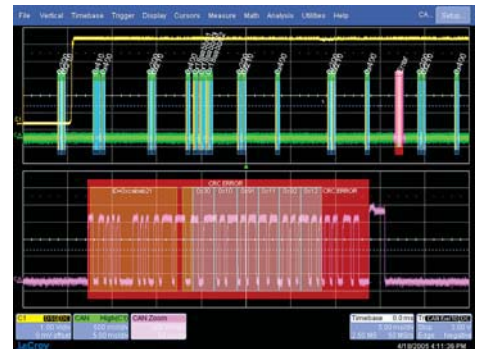

*With CANbus TDM/TD, the robust toolset makes all the difference in understanding CAN system performance.*



*MS-32 extends the range of WaveSurfer and WaveRunner by enabling 4 analog channel and 32 digital channel (4+32) measurement capability.*

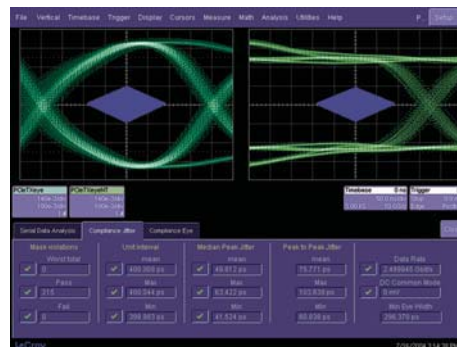

*The SDA-PCIE-G2 software option for the SDA implements PCI-SIG compliant eye pattern and jitter measurements.*



*PMA2 PowerMeasure Analysis software can be used with most LeCroy X-Stream oscilloscopes. Combine PMA2 with other accessories for a complete PowerMeasure System.*



## CUSTOMER SALES AND SERVICE

### EXTENDING THE VALUE OF LECROY PRODUCTS

**B**uilding long-term relationships with our customers is a deeply-held commitment at LeCroy. This commitment applies to our product development, manufacturing, sales, and support processes. It is reflected in the unprecedented level of customization that we build into our products, enabling the companies who use our equipment to easily tailor solutions for their specific applications.

At LeCroy, we believe an important way that we can provide significant added value for our customers is by extending the usable life of their LeCroy equipment. We believe our service practices are the best in the industry:

- Service Centers located around the world to speed repair and calibration of all LeCroy products
- 3 year warranties on Windows-based real-time oscilloscopes
- 3 year warranties on protocol analyzers
- 1 year warranties on sampling oscilloscopes and associated plug-in modules
- 7 year long term product repair support after a product has been discontinued
- Product calibration support guaranteed for 7 years after the product is discontinued, and best efforts after 7 years
- Goal of less than five days turnaround time in our Service Centers on most repairs

#### *Obsolescence Protection*

We believe we are unique in the T&M industry in offering a variety of plans to enable our customers to not only get the best equipment for the job at hand, but to finance it in a way that best matches their requirements. We call this program "Open Access," and it contains a family of plans to choose from. The plans are designed to ensure that engineers have the best instrumentation without expensive capital equipment purchases each and every time. They include a rental plan, a lease plan, and a subscription service. Contact LeCroy Customer Support for details.

#### *After-sale Option Add-ons and Upgrades*

LeCroy has made it a standard policy that customers may add after-sale options at any time without stiff pricing penalties. This practice has enabled our customers to grow their instrument capabilities as required.

#### *Software Updates*

LeCroy customers may upgrade to the latest software revisions without charge. Downloads of the latest instrument software can be found at our Web site under the "Service and Support" menu, Software Download menu selection.



#### *Retrofit of New Features*







When technically feasible, we make product extensions and new features available for existing equipment. These may include capabilities associated with an "A" version of a product as well as features enabled by software/firmware upgrades.

#### *Sales and Technical Support*







Our highly trained and knowledgeable sales and technical professionals are always available to help LeCroy customers solve their test and measurement challenges. Their application, product, and technology understanding is second-to-none. Sales and service staff work hand-in-hand to ensure that LeCroy customers get the maximum value from their equipment investment.

**LeCroy is committed to setting the standard for expert test and measurement solutions backed by dedicated customer service for the life of your product.**

# DIGITAL OSCILLOSCOPE SELECTION GUIDE

Product	Bandwidth	Maximum Sampling Rate (4 Channels)	Maximum Sampling Rate (Interleaved)	Standard Memory	Maximum Memory
<b>SDA Series</b> <b>Serial Data Analyzers</b> 	4 GHz–18 GHz	20 GS/s	60 GS/s	24 Mpts/Ch	150 Mpts/Ch
<p>The SDA Family series offers accurate and repeatable jitter analysis, precise eye patterns with violation locator, precision numerical clock recovery and support for next generation standards PCI-E 2, FC 8.5, FB-DIMM. The SDA 18000 is the fastest 4-channel real-time serial data analyzer with the highest bandwidth—18 GHz—and combines the highest sampling rate of 60 GS/s with the longest memory of up to 150 million points; all available in a real-time test instrument.</p>					
<b>WaveExpert Mainframe</b> <b>Sampling Oscilloscopes</b> 	20 GHz–100 GHz	10 MS/s	N/A	10 Mpts/Ch	510 Mpts/Ch
<p>The WaveExpert Series combines fast acquisition speed and deep memory with powerful data analysis packages for jitter, eye, and S-parameter measurements, making it the single most effective tool available today for testing high-speed serial data. WaveExpert has up to 100 GHz bandwidth, signal acquisition speeds 100x faster, and memory depths 125,000x deeper than conventional sampling oscillo-</p>					
<b>WaveExpert Modules</b> 	<p>This product range offers 5 electrical sampling modules from 20 GHz/TDR to 100 GHz, and 3 optical sampling modules from 10 GHz/Plug-in Reference Receiver to 50 GHz.</p>				
<b>WaveMaster® 8000A Series</b> 	4 GHz, 6 GHz	20 GS/s	20 GS/s	10 Mpts/Ch	100 Mpts/Ch
<p>These oscilloscopes are the first full-performance oscilloscopes providing high bandwidth, fast sampling speeds, and long memory capture.</p>					
<b>DDA Series</b> <b>Disk Drive Analyzers</b> 	3 GHz, 5 GHz	10 GS/s	20 GS/s	24 Mpts/Ch	100 Mpts/Ch
<p>Whether you are capturing, viewing, or analyzing disk drive signals, this series offers a robust toolset of drive-specific capabilities for fast solutions.</p>					
<b>WavePro® 7000A Series</b> 	1 GHz–3 GHz	10 GS/s	20 GS/s	10 Mpts/Ch	100 Mpts/Ch
<p>With its combination of innovative X-Stream Technology, unique customization strengths, and WaveShape Analysis capabilities, WavePro offers excellent performance at an appealing price.</p>					



Product		Bandwidth	Maximum Sampling Rate (4 Channels)	Maximum Sampling Rate (Interleaved)	Standard Memory	Maximum Memory
<b>VBA Series Vehicle Bus Analyzers</b>		400 MHz–2 GHz	5 GS/s	10 GS/s	10 Mpts/Ch, 20 Mpts	12.5 Mpts/Ch, 25 Mpts
<i>This analyzer is the first conventional oscilloscope that decodes CAN serial data into Symbolic (application layer) text. In addition, up to four different CAN buses can be decoded at one time.</i>						
<b>WaveRunner 6000A Series</b>		350 MHz–2 GHz	5 GS/s	10 GS/s	4 Mpts/Ch, 8 Mpts	12 Mpts/Ch, 24 Mpts
<i>Deeper memory, more math functions, faster sampling rates, and attractive pricing compared to other equivalent bandwidth oscilloscopes make the WaveRunner 6000A an appealing instrument for the busy engineering department.</i>						
<b>WaveRunner® Xi Series</b>		400 MHz–2 GHz	5 GS/s	10 GS/s	10 Mpts/Ch, 20 Mpts	12.5 Mpts/Ch, 25 Mpts
<i>All the performance you need with no compromises—big display, small footprint, plus WaveStream™ fast viewing mode, enhanced standard trigger capability and more.</i>						
<b>WaveSurfer® Xs Series</b>		200 MHz–1 GHz	2.5 GS/s	5 GS/s (only 104Xi)	2.5 Mpts/Ch	10 Mpts/Ch
<i>With an easy-to-learn and use interface, this oscilloscope offers a big 10.4" screen with a small 6" deep footprint. Fast viewing mode closely simulates the look and feel of an analog scope.</i>						
<b>WaveSurfer® 400 Series</b>		200 MHz–500 MHz	1 GS/s	2 GS/s	1 Mpts/Ch, 2 Mpts	1 Mpts/Ch, 2 Mpts
<i>Fits your working style as comfortably as it fits your bench, this oscilloscope offers a 10.4" LCD touch screen, 6" deep footprint and more than 100x the capture time compared to other instruments in its class.</i>						
<b>WaveJet® 300 Series</b>		100 MHz–500 MHz	1 GS/s	2 GS/s	500 kpts/Ch	500 kpts/Ch
<i>The WaveJet 300 Series raises the bar for performance in its class of oscilloscopes, offering exceptional value with 2 and 4 channel models from 100 MHz to 500 MHz. WaveJet eliminates the tradeoff between high sample rate and long capture time—providing 200x the capture time of any other product in its class, at 2 GS/s.</i>						

## PROTOCOL SOLUTIONS SELECTION GUIDE

### Product

### Description

#### PCI Express® Protocol Analyzers and Exercisers



The extensive PCI Express test equipment family from LeCroy includes expert analysis systems designed to meet your PCI Express needs. The PE *Tracer*™ ML system supports lane widths up to x8, while our most advanced systems, the PE *Tracer* EML and Summit Gen2, support up to 16 lanes with trace memory of 8 GB. The new PE *Tracer* Summit Gen2 is the first analyzer to support PCI Express Spec 2.0 (Gen2) traffic at 5 Gb/s per lane.

#### SAS/SATA Protocol Analyzers and Exercisers



Analyzers and exercisers from LeCroy for Serial Attached SCSI (SAS) and Serial ATA (SATA) deliver the power, flexibility, and features you need. The SAS *Tracer*™ Analyzer and SAS *Trainer*™ Exerciser support both SAS and SATA traffic at speeds up to 3 Gb/s, while the SA *Tracer*™ Analyzer and the SA *Trainer*™ Exerciser offer lower-cost solutions dedicated to SATA.

#### SAS InFusion™ / SATA InFusion™ Error Injector



The SAS *InFusion* and SATA *InFusion* error injector systems allow you to alter live traffic in order to verify real-world fault handling. In just minutes, an easy-to-use wizard-based interface allows you to create test scenarios. By introducing designed modifications into live traffic streams, engineers can easily verify error recognition and error recovery within SAS or SATA devices and systems.

#### USB Protocol Analyzers and Exercisers



LeCroy provides a comprehensive range of solutions for all USB data rates, including Hi-speed (480 Mb/s), Full-speed (12 Mb/s), and Low-speed (1.5 Mb/s). The development tools provide a variety of solutions from the high portability of the USB *Mobile*™ HS Analyzer to the powerful, flexible, and upgradable USB *Tracer/Trainer*™ Analyzer and Exerciser System.

#### UWB *Tracer*™ Protocol Analyzer System



Designed to verify functionality and interoperability between WiMedia devices, LeCroy's UWB *Tracer* provides both wireless radio and MAC-PHY interface (MPI) capture of Wireless USB protocol traffic. Small and portable, this flexible platform offers pluggable modules that allow users to interchange the radio component on the analyzer to support future changes in the UWB PHY specifications.

#### Bluetooth® Protocol Analyzers and Exercisers



LeCroy offers a wide range of Bluetooth test equipment, from the low-cost Merlin™ II Analyzer to the comprehensive BT *Tracer/Trainer*™ System, which supports both protocol analysis and exerciser (traffic generation) functions. When used in combination, the BT *Tracer*™ Analyzer can capture traffic that can then be used on the BT *Trainer*™ Exerciser as the basis for verification test scripts with user-defined error conditions.

#### Fibre Channel Protocol Analyzer System



The LeCroy FC *Tracer*™ 4G Analyzer supports all Fibre Channel data rates up to 4 Gb/s. The FC *Tracer* supports up to four channels (two full-duplex links), and allows cascading of multiple analyzers to provide a synchronized display of up to 16 links for testing of switches and similar multi-port devices. Interchangeable plug-in modules support easy expansion and upgrading of the system.



## EXTENDING YOUR REACH IN SERIAL DATA TESTING

When it comes to serial data testing, LeCroy oscilloscopes and analyzers lead the way in providing optimum solutions for high-speed signal and data analysis. In offering a complete toolbox for the busy test and measurement engineer, LeCroy devices provide the ultimate end-to-end solution for the design cycle. From physical layer measurement to expert protocol testing for the message layer, LeCroy's unique hardware and software architecture ensure superior performance, excellent value, and the fastest time-to-market.

### WaveExpert® Series Sampling Oscilloscopes

This series offers the first instruments that combine the high bandwidth and accuracy of a sampling oscilloscope with the speed and flexibility of a real-time instrument. This series of Near Real Time Oscilloscopes (NRO), eliminates most of the constraints of traditional sampling oscilloscopes. Enabled by a new LeCroy technology—Advanced Throughput Architecture (ATA)—they offer up to 100 GHz bandwidth, signal acquisition speeds 100 times faster, and memory depths 125,000 times deeper than conventional sampling scopes.



### SDA Series Real Time Oscilloscopes

Offering bandwidths from 18 GHz to 4 GHz, the SDA Series of oscilloscopes enables superior eye diagram fidelity for data rates up to 10 Gb/s.

These SDA instruments offer accurate and repeatable jitter analysis, precise eye patterns with violation locator, precision numerical clock recovery, and support for next generation standards PCI-E 2, FC 8.5, and FB-DIMM.



### Protocol Analyzers and Exercisers

Used by semiconductor, device, system, and software developers, LeCroy protocol analysis solutions feature impressive capabilities including:

- Monitoring bus activity, diagnosing operational and design problems, and confirming interoperability
- Variety of configurations for a large range of applications
- Functionality to assist design and test engineers and technicians through each phase of their products' life-cycle
- Powerful software that may be used directly with the equipment, or independently as a viewer and analysis tool
- Flexible platforms that offer future functionality via field upgrades



### WaveScan™ Advanced Search

**Locate Problems Triggers Won't Find.** WaveScan is a powerful tool that provides the ability to locate unusual events in a single capture, or scan for an event in many acquisitions over a long period of time using more than 20 different search/scan modes. WaveScan uses measurement-based scanning modes, like frequency, to show statistical distribution of events. It overlays events for a quick and simple visual comparison.



**RAISING THE BAR FOR SERIAL DATA ANALYSIS**

The LeCroy family of serial data analyzers provides bandwidth coverage second to none. For engineers working with the fastest data rates, the **SDA 18000** is the fastest 4-channel real-time serial data analyzer. It is a true breakthrough in signal analysis. The SDA 18000 delivers the highest bandwidth—18 GHz—as well as a combined highest sampling rate of 60 GS/s and longest memory of up to 150 million points available in a real-time test instrument. The SDA 18000 has sufficient bandwidth to allow real-time measurements of the fastest serial data standards entering active development today, including 10 Gb/s Ethernet, and Fibre Channel 8.5. Previously, serial data measurements and jitter analysis of these signals could only be made with a sampling oscilloscope, a technique confined to monitoring well behaved signals or small sequences of a repetitive bit pattern.

Capturing the data stream in real time with multiple points per transition edge, and with digitizing resolution as low as 16 ps per point, allows the SDA 18000 to recover the embedded clock and phase lock to it for precise jitter measurements. Now a complete breakdown of jitter composition is possible, even with non-repeating patterns or “live” data. You can instantly switch back to the individual bit pattern or the specific location where the mask violation has occurred. Sampling at 60 GS/s assures excellent waveform capture fidelity; and the 150 million points memory depth allows the capture of long serial data patterns. This is most helpful in locating the sources

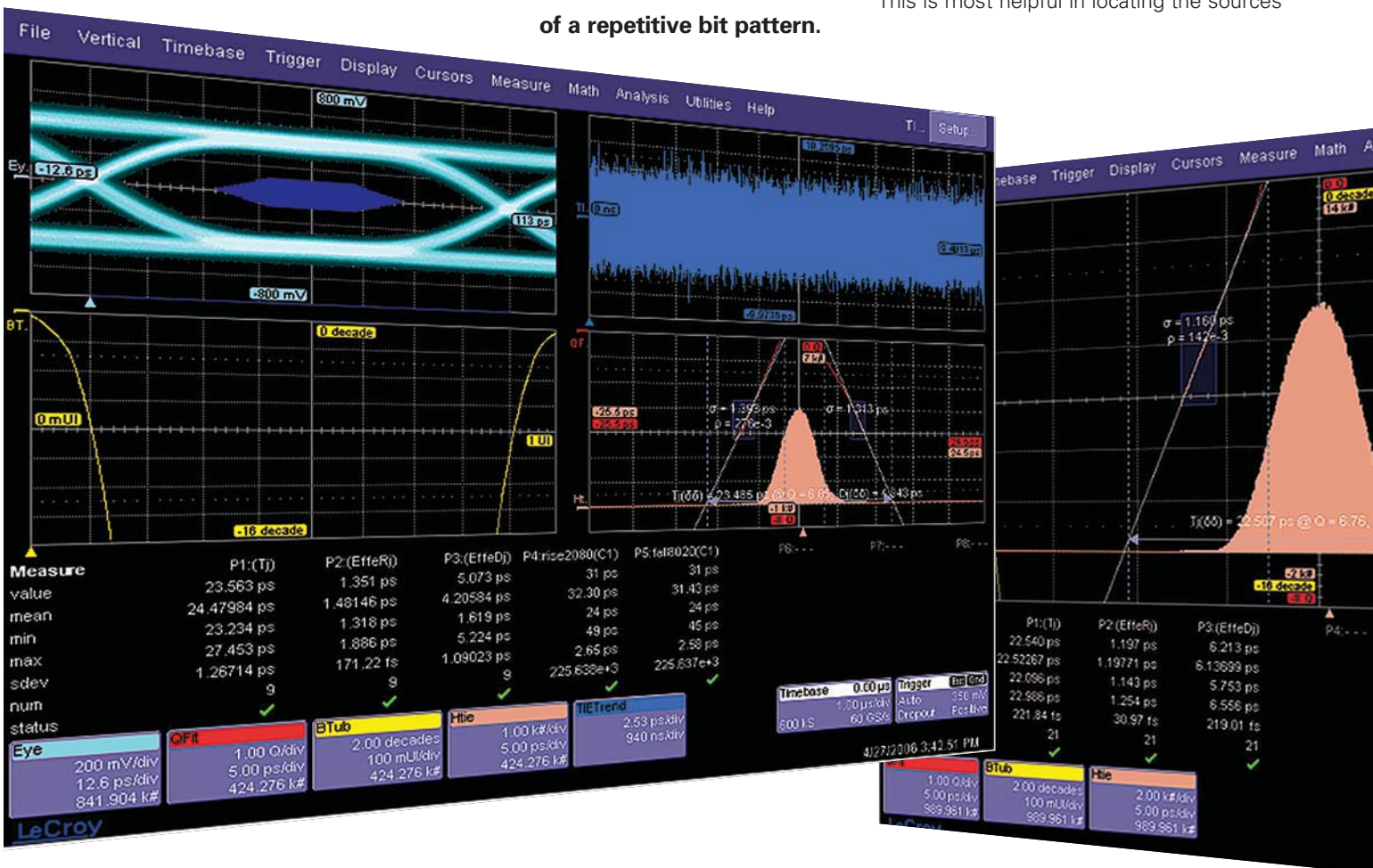



of low frequency jitter modulation or for tracking spread spectrum clocked (SSC) data.

### Mid-speed Serial Data is also Covered

The 11 GHz SDA 11000 is ideal for analysis in systems with serial data rates up to 6 Gb/s, while the 9 GHz SDA 9000 supports rates up to 5 Gb/s. The two instruments feature an architecture supporting 2 channels at full bandwidth. Both instruments share the same advanced serial data and jitter analysis capabilities of the SDA 18000, including Q-Scale analysis. Lower bandwidth applications from 6 GHz to 4 GHz are also well served by a number of models in each bandwidth.

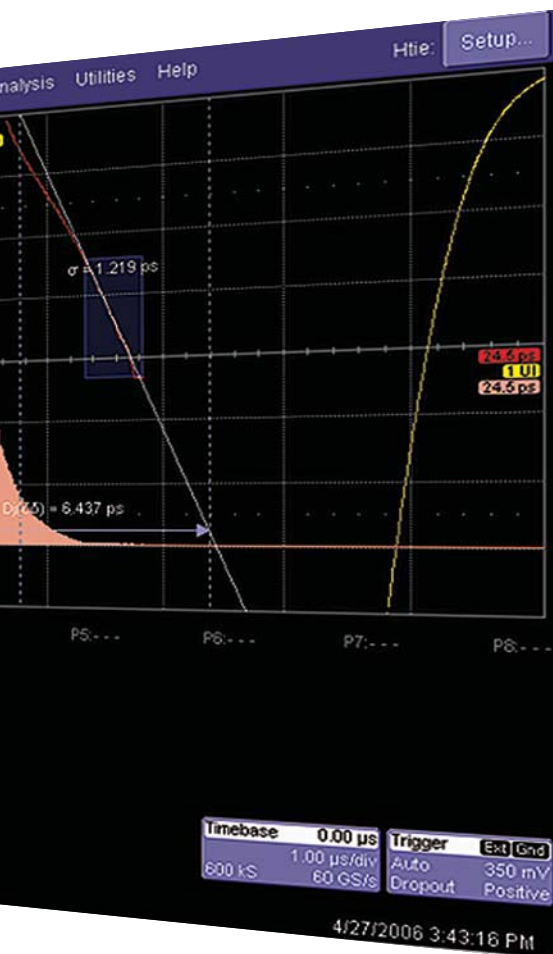

### Data Rate Configuration Chart

Standard	Data Rate/ Symbol Rate	Rise Time, ps min. (10%–90%)	Minimum Bandwidth
PCI Express® Gen2	5 Gb/s	30 ps	> 10 GHz (PCI Express Compliance Testing)
SATA II/III	Gen2 3 Gb/s Gen3 6 Gb/s	100 ps (Gen1) 67 ps (Gen2)	> 10 GHz (SATA II/III)
XAUI X2	6.25 Gb/s	30 ps	SDA 11000/D11000PS
Fibre Channel 8.5	8.5 Gb/s	30 ps	18 GHz (Fibre Channel)
SAS II/SAS 6G	SAS II 3 Gb/s SAS 6G 6 Gb/s	67 ps (Gen1) 33 ps (Gen2)	> 10 GHz (SAS II/SAS 6G)
FB-DIMM	FBD1 4.8 Gb/s FBD2 9.6 Gb/s	30 ps	> 10 GHz (FB-DIMM)
10 Gb Ethernet			18 GHz (10 Gb Ethernet)

### Advanced Capabilities at Your Fingertips

Every LeCroy serial data analyzer provides optimum test results for maximum understanding of circuit performance. Here are just a few of the benefits you will enjoy when using a LeCroy serial data analyzer.

- Pristine signal integrity measurements
- Accurate jitter analysis
- Powerful advanced waveform analysis
- Stable, repeatable results

### New Q-Scale Analysis for Unique Insight

A remarkable innovation included with the SDA Series is the Q-Scale analysis and plot view, a dramatic improvement that

provides much more insight into jitter than any other method. Q-Scale analysis uses an alternative method of breaking down jitter components. It also incorporates enhancements in extrapolating the jitter histogram tails, improving accuracy, stability, and measurement convergence time.

The Q-Scale plot provides a visual representation of jitter breakdown, which is much more intuitive than a traditional bathtub curve. Q-Scale allows engineers to locate the source of jitter in their circuit faster than was possible with tools used in the past.

## A COMPLETE SOLUTION

**Jitter is the most critical measurement in physical layer serial data analysis. LeCroy SDAs can measure a full set of clock and data jitter parameters as well as Time Interval Error (TIE) measurements for data signals. With the fully featured ASDA-J software, engineers will have the most effective jitter analysis tool available in the marketplace.**

**ISI Plot**

The ISI plot displays data dependent jitter contributions to the eye pattern for the second-to-last bit of a bit length, set from 3–10. This plot measures data dependent jitter without the need for a repeating bit pattern.

**Jitter Wizard**

This feature automatically selects all of the critical instrument settings, ensuring the highest accuracy and repeatability.

- Sampling rate, level, bit rate, and pattern length are automatically detected.

**Q-Scale**

First introduced in real-time serial data analyzers by LeCroy, the new Q-Scale view shows a graphical representation of key jitter components. It is a powerful tool for the engineer troubleshooting the source of jitter in circuits.

In brief, Q-Scale analysis depicts a Gaussian distribution as a straight line.

There are two fundamental benefits of using Q-Scale:

1. When placed on top of the reference line, you can instantly judge how Gaussian the distribution is. This is much easier than trying to look at the sides of a bathtub curve.
2. Greatly improved stability of the Random Jitter (Rj) component. Because the Rj component is heavily weighted to form the Tj, the Total Jitter number is also much more repeatable.

**Edge-to-Edge Jitter**

In this mode, timing is measured on data transitions relative to one another in the same way as a TIA.

- Measurements can be displayed directly or compensated to correlate with phase jitter measurements.
- Tj, Rj, and Dj measurements can be made at specific UI spacings, or for all spacings in the data stream.

**Filtered Jitter**

The SDA 11000 offers a filtered jitter mode to support ITU-T and SONET measurements.

- Band-pass filter with selectable upper and lower cutoff frequencies supplied.

**Interpreting the Q-Scale**

As with any jitter histogram, the width indicates the amount of jitter. The slope of the grey lines decreases with increasing random jitter.

The alignment of the red lines with the grey reference lines indicates how close to pure Gaussian the distribution on the corresponding face is. Note that it is possible and common for the two faces of the histogram to be nonsymmetrical, and even represent different amounts of jitter relative to the ideal edge placement.

The bottom tails of the red lines curve inward toward the center when there is a bounded component present. Likely sources of this jitter would be cross talk and power supply noise.



The distance between the dotted lines in the center is the deterministic (effective Dj) component, in the correct time scale.

There is no separation in these lines when the Dj is zero, indicating pure random jitter.

Three parameters are used to fit the tail of the histogram—Sigma, Mean, and Population. The Rho factor indicates the closeness of the data fit to the extrapolated model necessary to extend the histogram to the selected BER. A value of 1.0 would indicate a perfect fit to a single Gaussian distribution. Rho is the amount of the distribution of the histogram fit into the extrapolated tail. Essentially, this number represents a figure of merit for the measurement quality.





ADVANCED ANALYSIS TOOLS

Although serial data compliance testing is widely available, analyzers that easily discover the reason for failing a compliance test are not. Only LeCroy SDA Series offers the class-leading serial data and jitter analysis toolset to help understand the causes behind the failure. With them, you can quickly identify the nature of the jitter and isolate the source of the problem.

Spread Spectrum Clock

LeCroy's unique long acquisition memory and fast sample rate are ideal for seeing fine details in data transmitted with Spread Spectrum Clocks (SSC). It is becoming popular due to its lower noise contribution. The modulation frequency used is low, typically 33 kHz. With 150 Mpts of waveform memory, the SDA 18000 can capture over 72 entire cycles of SSC while sampling at its maximum rate of 60 GS/s.

Mask Violation Locator and Multi-Eye

Mask failures are identified by contrasting color spots on the eye pattern that appear anywhere the data intersects the mask template. Using the Mask Violation Locator tool, users can call up the actual stored bit stream waveform at the point in time of the initial failure. The actual bit sequence is also identified, pointing out any ISI problems. Cursor controls allow you to instantly jump to the next violation, or any other that occurred in the stored pattern.

The mask violation locator works effectively on single and multiple eye masks. Multi-Eye can be used whenever two valid eye patterns occur in the same data channel, such a

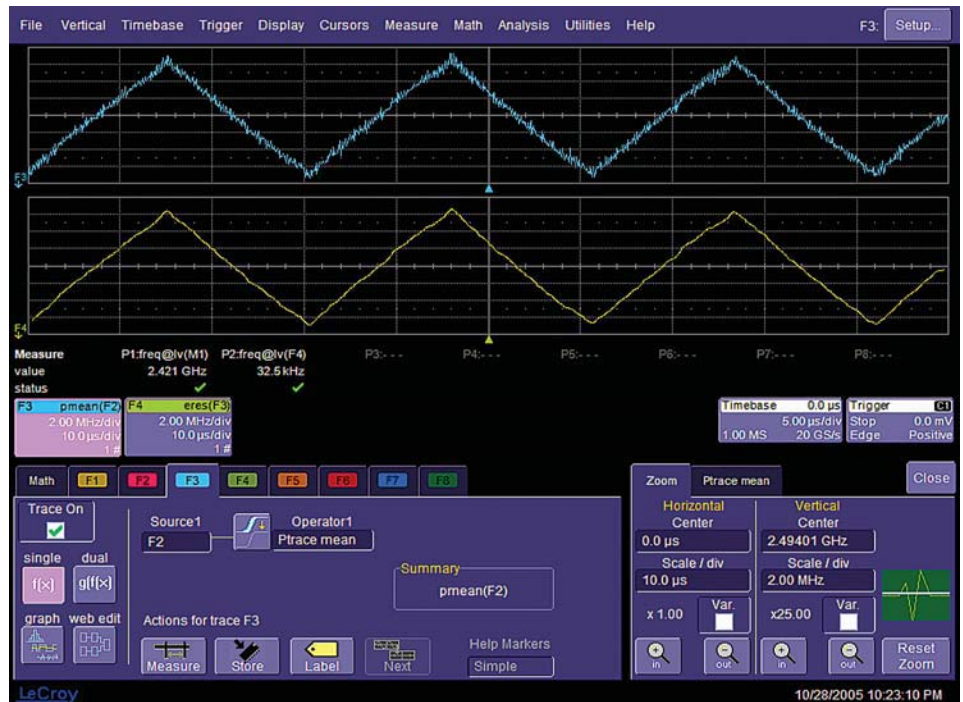

See multiple cycles of spread spectrum clocking.

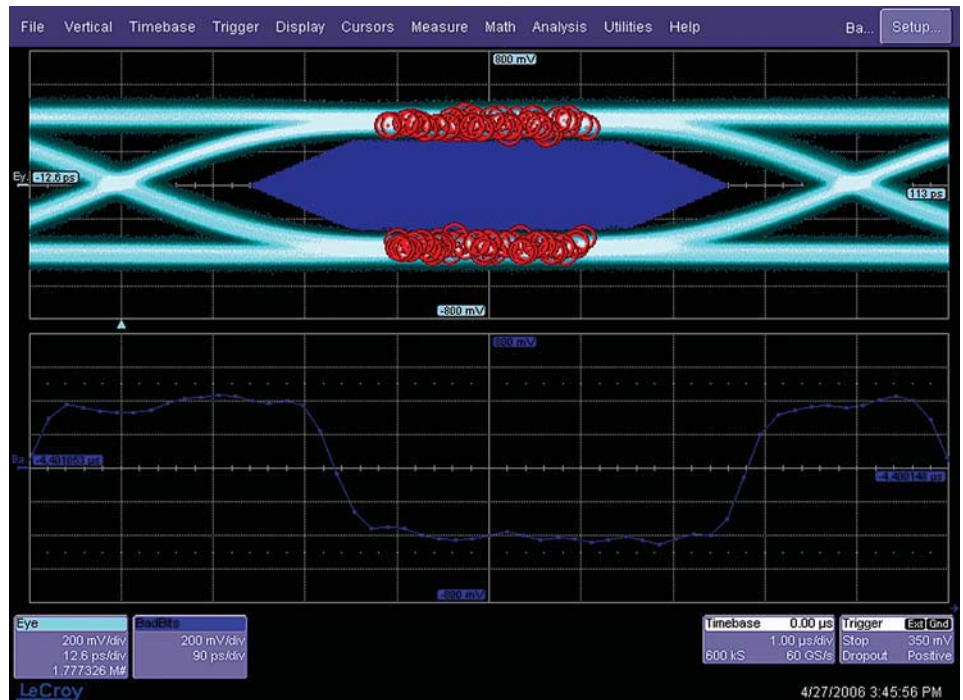

Observe bit sequences that cause mask violations.

different transmit and receive waveforms in bi-directional channels (FSB) and transition/non-transition bit applications, as found in

PCI Express. Independent measurements such as rise and fall time, eye amplitude, etc., can be made in each eye.



## QUALIPHY™ COMPLIANCE SOFTWARE

**W**hile multiple serial data standards converge in today's computer motherboards and multimedia equipment, device designers and their team members must rely on high-performance test equipment tools. With the introduction of QualiPHY, LeCroy demonstrates a continuing commitment to deliver unsurpassed value, measurement accuracy, and test flexibility for emerging and legacy standards.

### Automated Compliance Testing

QualiPHY provides a compliance framework for testing high-speed serial data applications including SATA, FB-DIMM, UWB, ENET, USB, PCI Express, SAS and HDMI. It features superior measurement accuracy, exceptional ease of use, and retrievable reports that can be output in multiple formats.

Designed from the ground up to offer a common, intuitive user interface across the industry's most popular serial data standards, QualiPHY is an MS Windows-based application configured with one or more serial data compliance modules. It offers complete automation for system level preproduction tests; reporting in multiple formats for engineers conducting statistical analysis; access to live signals from scopes in remote locations; and demonstrations of device performance for chip vendors and their customers.

- Friendly graphical user interface
- Professional report of all results including margin analysis
- User-adjustable compliance limits
- Complete set of compliance fixtures
- Consistent, repeatable results
- Confirmed accurate by industry standards
- Results database enables quick access to and analysis of historical data
- Suitable for use in production test (Command line/batch mode operation).

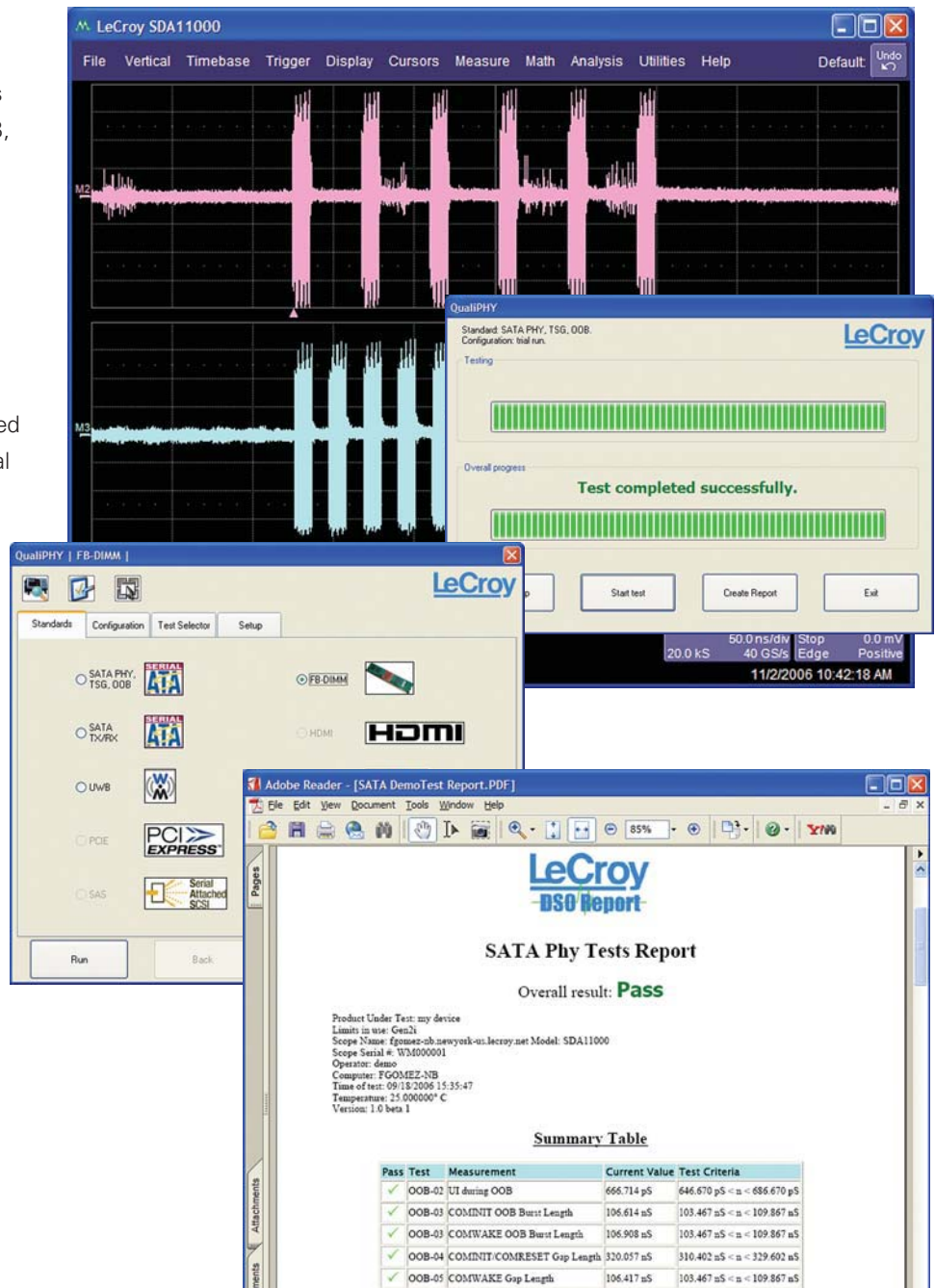

Supporting LeCroy's complete compliance test solution packages, QualiPHY can be added to any of LeCroy's real-time or sampling scopes and can be used with LeCroy protocol analyzers, test fixtures and probes for specific standard configurations.

**SERIAL DATA ANALYZER MODEL OVERVIEW**

**SDA 18000**



Analog Bandwidth	<b>18 GHz</b>
Rise Time (20–80% Typical)	<b>19 ps</b>
Input Channels	<b>4</b>
Max. Sample Rate	<b>60 GS/s</b>
Channels @ Max. SR	<b>1</b>
Standard Memory/Ch	<b>20 Mpts (60 Mpts @ Max. SR)</b>

**Memory Options**

150M/18 GHz  
100M/11 GHz  
50M/4 Ch

**SDA 11000**



Analog Bandwidth	<b>11 GHz</b>
Rise Time (20–80% Typical)	<b>28 ps</b>
Input Channels	<b>4</b>
Max. Sample Rate	<b>40 GS/s</b>
Channels @ Max. SR	<b>2</b>
Standard Memory/Ch	<b>20 Mpts (40 Mpts @ Max. SR)</b>

**Memory Options**

100M/11 GHz  
50M/4 Ch

**SDA 9000**



Analog Bandwidth	<b>9 GHz</b>
Rise Time (10–90% Typical)	<b>49 ps</b>
Input Channels	<b>4</b>
Max. Sample Rate	<b>40 GS/s</b>
Channels @ Max. SR	<b>2</b>
Standard Memory/Ch	<b>20 Mpts (40 Mpts @ Max. SR)</b>

**Memory Options**

100M/9 GHz  
50M/4 Ch

**SDA 6020**



Analog Bandwidth	<b>6 GHz</b>
Rise Time (10–90% Typical)	<b>75 ps</b>
Input Channels	<b>4</b>
Max. Sample Rate	<b>20 GS/s</b>
Channels @ Max. SR	<b>4</b>
Standard Memory/Ch	<b>20 Mpts @ Max. SR</b>

**Memory Option**

50M/4 Ch



## SERIAL DATA ANALYZER MODEL OVERVIEW

## SDA 6000A XXL



Analog Bandwidth	<b>6 GHz</b>
Rise Time (10–90% Typical)	<b>75 ps</b>
Input Channels	<b>4</b>
Max. Sample Rate	<b>20 GS/s</b>
Channels @ Max. SR	<b>2</b>
Standard Memory/Ch	<b>50 Mpts (100 @ Max. SR)</b>

**Memory Options**  
N/A

## SDA 4020



Analog Bandwidth	<b>4 GHz</b>
Rise Time (10–90% Typical)	<b>105 ps</b>
Input Channels	<b>4</b>
Max. Sample Rate	<b>20 GS/s</b>
Channels @ Max. SR	<b>4</b>
Standard Memory/Ch	<b>8 Mpts @ Max. SR</b>

**Memory Option**  
50M/4 Ch

## SDA 4000A XXL



Analog Bandwidth	<b>4 GHz</b>
Rise Time (10–90% Typical)	<b>105 ps</b>
Input Channels	<b>4</b>
Max. Sample Rate	<b>20 GS/s</b>
Channels @ Max. SR	<b>2</b>
Standard Memory/Ch	<b>50 Mpts (100 @ Max. SR)</b>

**Memory Options**  
N/A

## SDA 100G



Analog Bandwidth	<b>Up to 100 GHz</b>
Rise Time (10–90% Typical)	<b>4 ps</b>
Input Channels	<b>4</b>
Max. Sample Rate	<b>10 MS/s</b>
Channels @ Max. SR	<b>4</b>
Standard Memory/Ch	<b>4 Mpts</b>

**Memory Options**  
510M/255M/  
128M/64M

## PROBES AND AN AMPLIFIER

LeCroy offers an extensive range of probes to meet virtually all your needs. They are an essential tool for accurate signal capture, and perform to the same high standards as all LeCroy products.

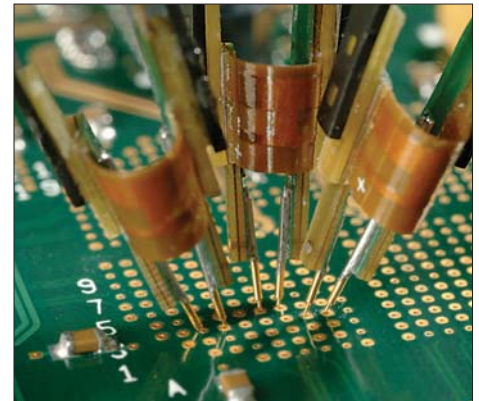
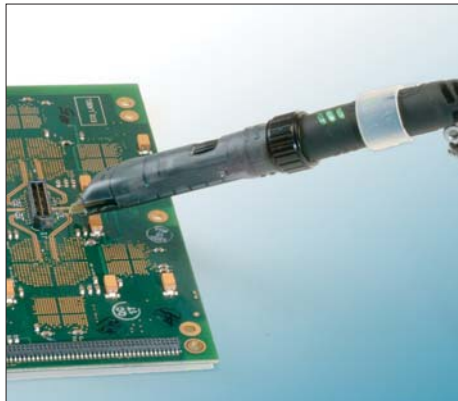

### The WaveLink® Series of Probes

#### Unprecedented Flexibility for Probe Interconnection

WaveLink probes provide industry leading technology for wideband signal connection to test instruments. The first differential probes to employ SiGe technology, they deliver full system bandwidth when used with LeCroy 3 GHz, 5 GHz, 6 GHz or greater oscilloscopes.

While other probes have higher DC resistance, their loading impedance quickly drops to very low values at relatively low frequencies. For any given tip style, WaveLink probes offer the lowest loading over frequency of any similar probe available.

### HFP2500 Active Probe

Since different situations call for probing at different points, the HFP Series of Active Probes includes 5 different types of probe tips. The Straight Tip is ideal for general purpose browsing, and the Sharp Tip or Bent Sharp Tip can be used for easy access to tightly spaced test points or circuit vias. Use the Discrete SMD Tip for probing on surface mount capacitors, resistors, or other components. The IC Lead enables probing on small geometry IC legs and is insulated to prevent any shorting between the test points. In addition to these unique probe tips, traditional IC clips and flexible wire leads are also included.

### Very Accurate Eye Pattern Measurements

WaveLink probes virtually eliminate distortion when measuring signals. This benefit is particularly useful in eye pattern measurements, now routine for systems using fast serial parallel data bus architecture.

All WaveLink probes offer:

- Superior loading characteristics
- Precise frequency response with outstanding fidelity for high-speed signals

Both low loading and frequency response flatness are needed to ensure the signal fidelity required to measure performance accurately.

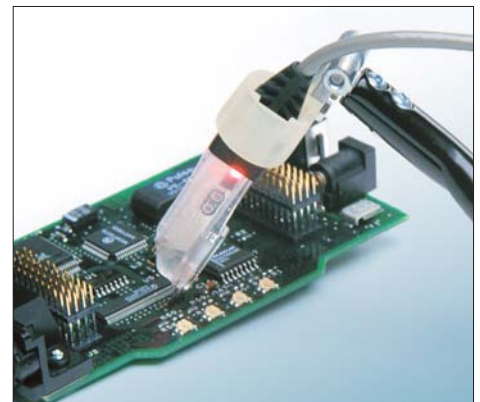





### DA18000 Differential Amplifier

The DA18000 Differential Amplifier is a very high bandwidth DC coupled differential amplifier with a true 100  $\Omega$  balanced input. It features high common mode rejection, low noise, and is designed to be used exclusively with the SDA 18000 Serial Data Analyzer. The amplifier has unity gain to maximize the signal to noise performance when used with the lower amplitude signal voltages common in higher data rate systems.

The DA18000 is supplied with a short pair of input cables which are matched to an electrical propagation length of 2.5 ps. Use



of the DA18000 with these cables eliminates the need to deskew and calibrate input channels for differential match, a problem encountered when acquiring differential signals with two oscilloscope channels connected with long cables.

The DA18000 differential amplifier utilizes third generation digital response equalization, the same calibration method used in LeCroy's award winning high bandwidth probes. This provides the most accurate magnitude and phase response, assuring the high fidelity eye pattern measurements.

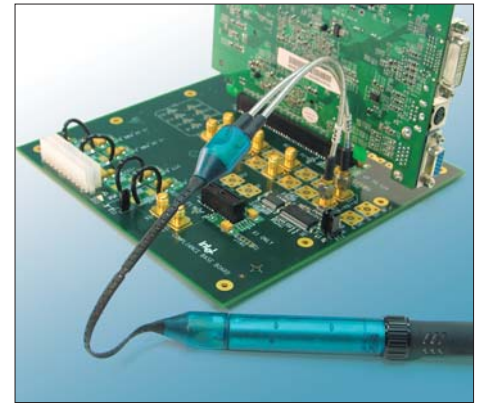

### D11000PS Differential Probe System

The D11000PS extends the full signal acquisition performance of the SDA 11000 and SDA 9000 to the probe tips. With 11 GHz system bandwidth, the probe enables direct measurement of high-speed serial data streams up to 6.25 Gb/s. The D11000PS also provides 11 GHz system bandwidth when used with the SDA 18000.

When used to acquire input signals for the SDA 11000, SDA 9000, or SDA 18000, the D11000PS provides unprecedented waveform fidelity, even with signals at higher serial data rates. The D11000PS utilizes third generation response compensation calibration, the most advanced in use today, to provide optimal system response.

The D11000PS provides both direct Solder-In and cabled SMA-connector interconnect lead assemblies. Each interconnect lead comes with a dedicated probe amplifier module that has calibration data optimized for the respective lead. This eliminates the performance compromise of using a single calibration for multiple lead types.

Specification	Value
Input Configuration	True Differential, 100 $\Omega$ Balanced
Input Connector	2.92 mm
Frequency Response, System	DC–18 GHz, Typical
Rise time, 20%–80%, System	< 24 ps, Typical
Rise time, 20%–80%, Probe Only	< 19 ps
Voltage Gain	X 1
Voltage Gain Accuracy	2%, (20–30 $^{\circ}$ C)
Max. Offset Voltage, RTI	< 5 mV
Noise, System	1 mV <sub>rms</sub> , Typical
Maximum Input – Differential with $\div 2$ Attenuators	$\pm 400$ mV (800 mV <sub>p-p</sub> ) $\pm 800$ mV (1.6 V <sub>p-p</sub> )
Maximum Input – Common Mode with $\div 2$ Attenuators	$\pm 10$ V 7 V <sub>rms</sub>
Common Mode Resistance, DC	25 k $\Omega$

#### Included with the DA18000:

Electrically matched input cables (2),  $\div 2$  precision attenuators (2), ESD dissipating wrist strap, Instruction Manual, certificate of traceable calibration, soft accessory case.

INTRODUCTION TO SERIAL DATA STANDARDS

This LeCroy Serial Data Configuration Guide describes the standards-based electronic bus and interfaces covered by LeCroy Serial Data Application Solutions. It relates technological requirements to specifications of important standard bus and interface architectures. The Guide addresses desktop applications (USB and PCI Express®) and system-level, storage oriented interfaces such as Serial ATA, and data communication standards such as Ethernet and SONET/SDH.

	Memory		Recommended	Software Package	Protocol Tools
	BEST	STD	Probe		
<b>USB</b>					
WP7300A	4M	4M	D300A-AT D350ST	USB	USB Mobile
<b>HDMI</b>					
SDA 4000A XXL	12M	8M	D350ST	SDA-HDMI	N/A
<b>SATA I (1.5 Gb/s)</b>					
SDA 6020	12M	8M	D600A-AT	SDA-SATA	SA Tracer/Trainer
<b>SATA II (3 Gb/s)</b>					
SDA 11000	24M	16M	D11000PS	SDA-SATA	SA Tracer/Trainer
<b>PCIe Gen1</b>					
SDA 6000A XXL	12M	8M	D600A-AT	SDA-PCIe-G2	PE Tracer/Trainer ML
<b>PCIe Gen2</b>					
SDA 11000	24M	16M	D11000PS	SDA-PCIe-G2	PE Tracer Summit
<b>SAS 1.5G</b>					
SDA 6020	12M	8M	D600A-AT	SDA-SAS	SA Tracer/Trainer
<b>SAS 3G</b>					
SDA 11000	24M	16M	D11000PS	SDA-SAS	SA Tracer/Trainer
<b>FB-DIMM</b>					
SDA 11000	24M	16M	N/A	SDA-FBDIMM	N/A
<b>UWB</b>					
SDA 11000	24M	16M	N/A	SDA-UWB	UWB Tracer

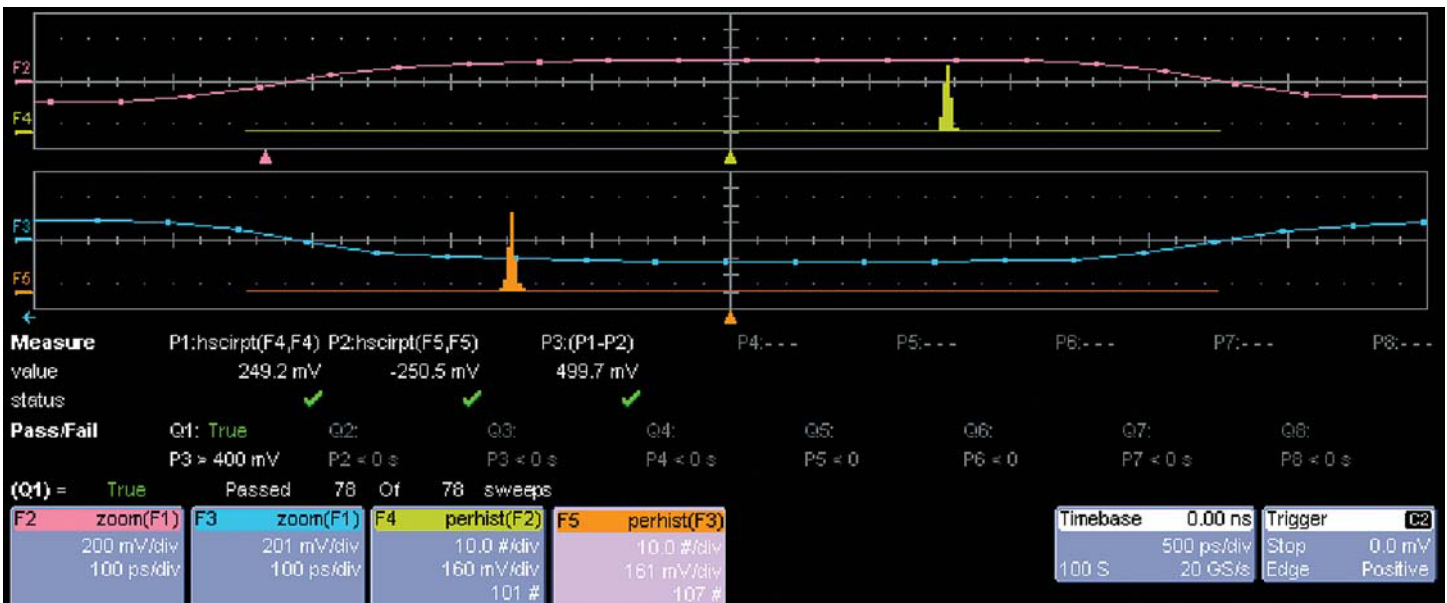



INTRODUCTION TO SERIAL DATA STANDARDS

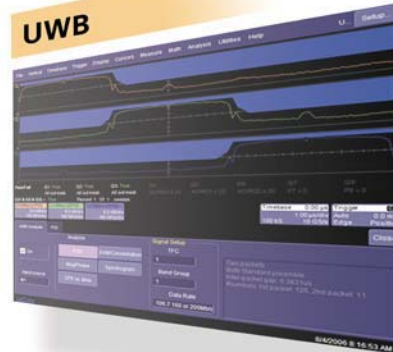
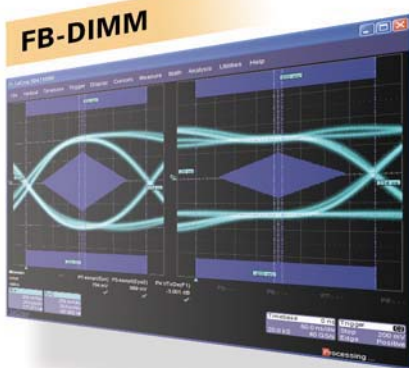
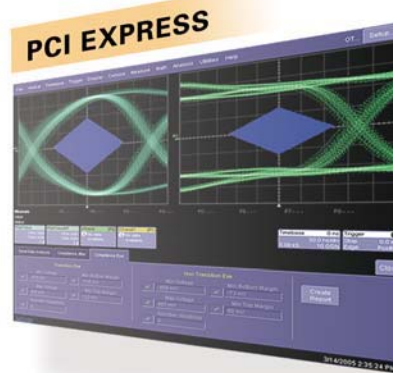
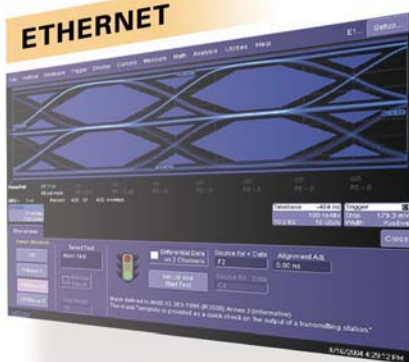
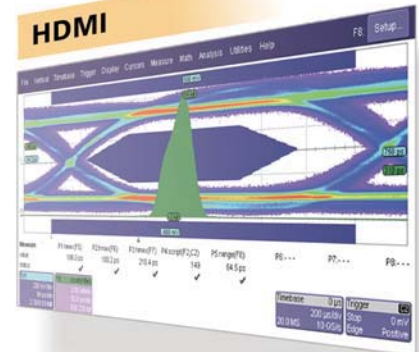
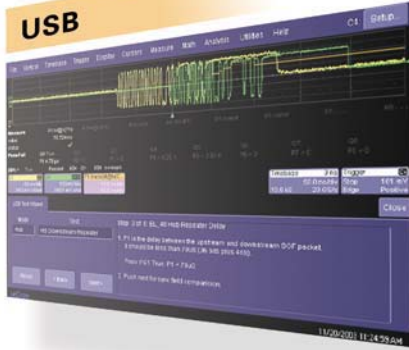

## PCI EXPRESS

The fundamental PCI Express link consists of two low-voltage, differentially driven pairs of signals: a transmit pair and a receive pair. A data clock is embedded using the 8B/10B encoding scheme to achieve very high data rates.

The initial frequency is 2.5 Gb/s in each direction, and this is expected to increase with silicon technology advances to 5 Gb/s (PCIe Gen2) in each direction.

The physical layer transports packets between the link layers of two PCI Express agents. The bandwidth of a PCI Express link may be linearly scaled by adding signal pairs to form multiple lanes. The physical layer supports x1, x2, x4, x8, x12, x16, and x32 lane widths and splits the byte data.

Each byte is transmitted, with 8B/10B encoding, across the lane(s).

**SSC Memory Requirements:** Whenever Spread Spectrum Clocking is used, it changes the nominal clock frequency at a rate between 30 and 33 kHz.

In order to capture and characterize/track SSC modulation, each modulation cycle must acquire 1.2 Mpts of data. A minimum of 4 cycles is required to obtain an accurate measurement.

## PCIe Gen1/Gen2

Bus Clock Signal: 1/2 Bit period

Theoretical Max. Transfer Rate: 2.5 Gb/s (Gen 1)  
5.0 Gb/s (Gen 2)

**Advantages:** Supports multiple market segments and emerging applications; unifying standard for desktop, mobile and enterprise platforms; supports existing PCI software

**Disadvantages:** Not an interconnect scheme for processors or memory; supports switch architecture but not cluster configurations

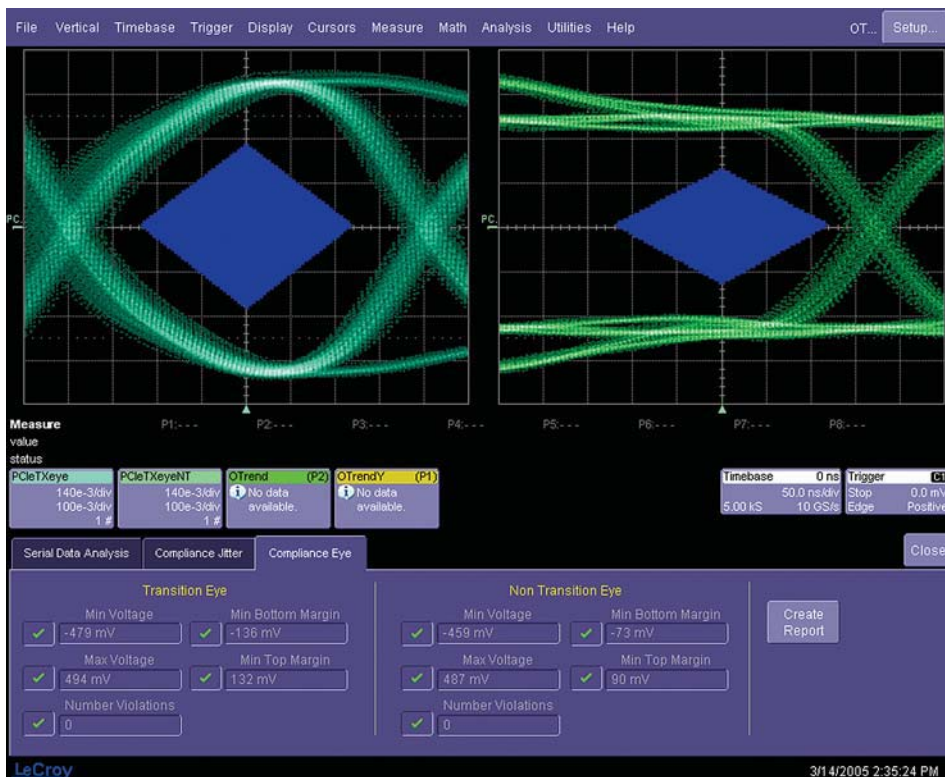

	Oscilloscope	Software	Fixture(s)	Active Diff. Probe
<b>Recommended</b>	SDA 11000	SDA-PCIE-G2	CBB+CLB	D11000PS
<b>Minimum</b>	WM8620	Sigtest	CBB+CLB	D600A-AT (2) + WL600 (2)

**Extra Accessories**

Item	Qty
SMA-M/SMA-M Cable, 18 in.	2
Terminator, SMA, 50 Ω	2
PC Power Supply	1

CBB = Compliance Base Board  
 CLB = Compliance Load Board

**Recommended Configuration for PCI Express Testing (2.5 Gb/s) or 5.0 Gb/s**

**11 GHz, 40 GS/s Oscilloscope**



**PCI Express Compliance Test Software Package**



**(OPTIONAL) 11 GHz Differential Probe**



**CBB and CLB Fixtures\***

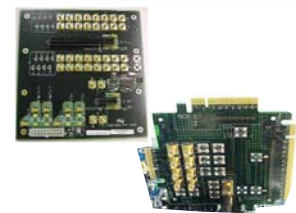

**Minimum Configuration for PCI Express Testing (2.5 Gb/s)**

**6 GHz, 20 GS/s Oscilloscope**



**PCI Sigtest**



**(OPTIONAL) 7.5 GHz Differential Probe**



**CBB and CLB Fixtures\***



\*For PCI Express Gen1 Tests Only.



## SATA

**T**he Serial ATA (SATA) bus is the serial version of the IDE (PATA) spec. SATA uses a 4 conductor cable with two differential pairs (Tx/Rx), plus an additional three ground pins and a separate power pin. Data runs at 150 MB/s (1.5 Gb/s) using 8B/10B encoding and 400 mV signal swings, with a maximum bus length of 1 meter. Later enhancements move the data transfer speed to 300 MB/s [Gen2].

Serial ATA uses LVDS with voltages of 400 mV; while parallel ATA is based on TTL signaling levels and rates. Serial ATA is a point-to-point interface where each device is directly connected to the host via a dedicated link. Non-Return to Zero (NRZ) encoding is used for data communication on a differential two wire bus. The bit decoding used is 8B/10B encoding which ensures compact messages. The transmit pair differential impedance is 100 ohms ( $\pm 15$  ohms). The use of NRZ encoding ensures compact messages with a minimum number of transitions and high

resilience to external disturbance. The termination resistor is 100 ohms ( $\pm 5$  ohms) differential.

**SSC Memory Requirements:** Whenever Spread Spectrum Clocking is used, it changes the nominal clock frequency at a rate between 30 and 33 KHz.

In order to capture and characterize/track SSC modulation, each modulation cycle must acquire about 1.3 Mpts of data (at 40 Gb/s) A minimum of 4 cycles is required to obtain an accurate measurement.

## SATA Gen1/Gen2

Theoretical Max. Transfer Rate: 300 MB/s (3000 Mb/s)

**Advantages:** Low pin count; low implementation cost; similar to Parallel ATA (PATA); compatible with IDE disk drive software

**Disadvantages:** Point-to-Point protocol; only one lane



	Oscilloscope	Software	Fixture(s)	Active Diff. Probe
<b>Recommended</b>	SDA 11000	SDA-SATA*	TF-SATA	D600A-AT (2) + WL600 (2)
<b>Minimum</b>	SDA 6000A XXL	SDA-SATA*	TF-SATA	D600A-AT (2) + WL600 (2)

\*ASDA-J is included in the SDA-SATA.  
For bundle pricing, please call 1-800-5-LeCroy for details.

**Recommended Configuration for Serial ATA Testing (30 Gb/s)**

11 GHz, 40 GS/s  
Oscilloscope

SDA/SATA

Serial ATA Test Fixture

(OPTIONAL)  
7.5 GHz Differential Probe (2)

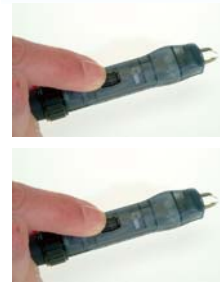
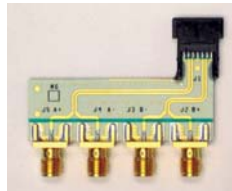

**Minimum Configuration for Serial ATA Testing (30 Gb/s)**

6 GHz, 20 GS/s  
Oscilloscope

SDA/SATA

Serial ATA Test Fixture

(OPTIONAL)  
7.5 GHz Differential Probe (2)

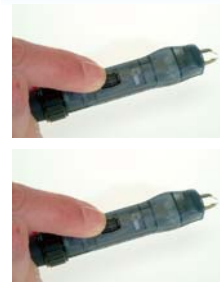
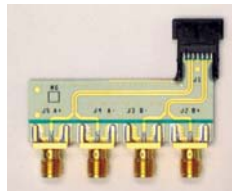

## USB 2.0

The USB bus is a differential, bi-directional serial interface cable bus. Differential NRZI data is transmitted between devices (NRZI produces a change in the signal indicating a logic zero; no change indicates a logic one). Data is transferred at three different rates over a maximum cable length of 5 meters ( $\pm$ ) over 4 wires, 2 of which carry data on a balanced twisted pair.

A low-speed mode of 1.5 Mb/s is used for devices such as mice. Full-speed mode is used by most devices and allows a transfer rate of 12 Mb/s. High-speed mode (defined by USB 2.0) allows rates of 480 Mb/s. Transmission at the high-speed mode requires the addition of 45 ohm termination resistors between each data line and ground.

- Operation in full-speed mode is 2.8 volts (High) to 0.3 volts (Low).

- Operation in high-speed mode is at 400 mV  $\pm$ 10% [High] to 0 V  $\pm$ 10 mV [Low].
- Cable impedance for both modes is 90 ohms  $\pm$ 15% (differential).

Four different (packet) protocols are used: Control, Interrupt, Isochronous, and Bulk. Each exchange contains 3 packets: a token packet that holds the address, a data packet that holds the data, and a handshake packet that terminates the exchange.

## USB 2.0

Bus Clock Signal: n/a

Theoretical Max. Transfer Rate: 60 MB/s (480 Mb/s) USB 2.0

Advantages: All the advantages of USB, along with significantly higher speeds, make it compatible with high-speed peripherals such as data drives and video cameras.

Disadvantages: Not compatible with older peripherals; still slower than PCI

USB Specification 1.1 was designed for low- to medium-speed applications running at less than 12 Mb/s. It is not suited for high-end data transfer such as high-speed back-ups to hard disks or CDs, high resolution color printing, and interactive gaming. The recently released USB Specification 2.0 intends to upgrade the bus for high performance applications. The main difference between Specification 1.1 and 2.0 is that the latter provides for data transfer rates up to 480 Mb/s.





	Oscilloscope	Software	Fixture(s)	Active Diff. Probe	Active Probe	Current Probe	Passive Probe
<b>Recommended</b>	WP7300A	USB2	TF-USB	D350ST (2)	HFP2500 (2)	CP030	PP005A
<b>Minimum</b>	WP7200A	USB2	TF-USB	D350ST (2)	HFP2500 (2)	CP030	PP005A



**Extra Accessories**

Item	Qty	Item	Qty
HS Self-powered Hub	5	USB Cable, 5 m	6
FS Device (e.g. Webcam)	1	FS Self-powered Hub	1
USB Mouse (LS)	1		

For bundle pricing, please call 1-800-5-LeCroy for details.

HS = High-speed  
 FS = Full-speed  
 LS = Low-speed

**Recommended Configuration for USB 2.0 High-speed (HS) Testing (480 Mb/s)**

2 GHz Oscilloscope	USB 2.0 Test Package + MATLAB	USB Test Fixture	3 GHz Differential Probe (2) D350ST	2.5 GHz Active Probe (2)	Current Probe Note: AP-1M needed if using WM or SDA	Passive Probe
						

**Minimum Configuration for USB 2.0 High-speed (HS) Testing (480 Mb/s)**

2 GHz Oscilloscope	USB 2.0 Test Package + MATLAB Runtime Module	USB Test Fixture	3 GHz Differential Probe (2) D350ST	2.5 GHz Active Probe (2)	Current Probe Note: AP-1M needed if using WM or SDA	Passive Probe
						

Note: Return Loss Measurements require a Function Generator; see USB 2.0 Manual for details.

**ETHERNET**

**E**NET is a software option package that performs complete electrical testing for 1000Base-T and 100Base-TX Ethernet standards. Jitter and pulse mask tests are performed with automatic waveform alignment, and all test results feature pass/fail indicators corresponding to the standard being tested. 10Base-T pulse mask testing is also supported, using the supplied compliance mask.

10Base-T/100Base-T has the capability to run at 10 Mb/s and 100 Mb/s, respectively. Transmission takes place over Shielded

Twisted Pair (STP) cables or Unshielded Twisted Pair (UTP, 100 ohm) cable, which forms the Ethernet architecture. The



**Ethernet (ENET)**

**Bus Clock Signal:** 125 MHz

---

**Theoretical Max. Transfer Rate:** 125 MB/s (1000 Mb/s)

---

**Advantages:** Most popular networking standard, with high-speed capability and widespread support.

---

**Disadvantages:** Slower than PCI





devices are interconnected via RJ45-type connectors and twisted-pair cables, and must conform to IEEE802 specification. This interconnect is point-to-point, commonly in a star topology. Normally this runs out to 100 meters. 10Base-T at a minimum uses "Category 3." 100Base-TX at a minimum uses "Category 5." The (nominally) 100 ohms cable impedance should be between 85 and 115 ohms and have at least two twists per foot. The total number of devices on a single chain is two. 1000Base-T (Gigabit Ethernet) operates up to 100 meters on EIA568, 4-pair (CAT-5) copper wiring. This is backwards compatible with 100Base-T. 1000Base-T also uses Fibre Channel as the physical layer, and runs at 1000 Mb/s

10Base-T	Oscilloscope	Software	Fixture(s)	Active Diff. Probe	Active Probe	Current Probe	Passive Probe
<b>Recommended</b>	WP7200A	ENET	TF-10BT, TF-ENET	D350ST	HFP2500 (2)	N/A	PP005A (2)
<b>Minimum</b>	WR6200A	ENET	TF-10BT	D350ST	HFP1500 (2)	N/A	PP006A



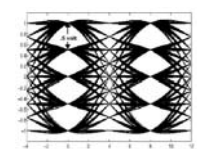

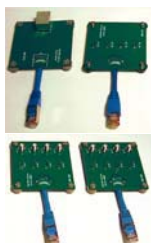
Extra Accessories	Item	Qty	Notes
	BNC-M/SMA-F Adapter	2	For WavePro Configuration
	SMA-M/SMA-M Cable, 18 in.	2	For WavePro Configuration
	RJ45 Cable, 1 in.	1	

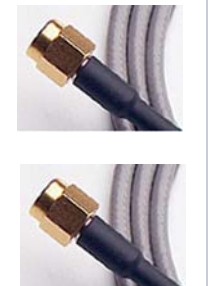
For bundle pricing, please call 1-800-5-LeCroy for details.

**Minimum Configuration for Ethernet Testing (10Base-T)**

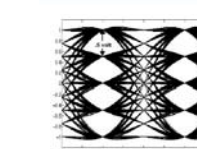
<b>2 GHz Oscilloscope</b>	<b>ENET Test Package</b>	<b>1 in. Ethernet Cable</b>	<b>Ethernet Twisted Pair Fixture</b>	<b>(1) Differential Probe with 5 V Range, OR (2) Passive Probes</b>	<b>(2) SMA-BNC Adapters (for WavePro)</b>	<b>(2) High Quality SMA Cables</b>
						

**Minimum Configuration for Ethernet Testing (100Base-T and 1000Base-T)**

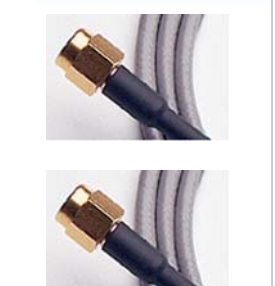
<b>2 GHz Oscilloscope</b>	<b>ENET Test Software</b>	<b>Ethernet Test Fixture</b>	<b>(2) SMA Power Splitters (1000Base-T only)</b>	<b>(2) SMA-BNC Adapters (for WavePro)</b>	<b>(2) High Quality SMA Cables</b>
					

100Base-T 1000Base-T	Oscilloscope	Software	Fixture(s)	Active Diff. Probe	Active Probe	Current Probe	Passive Probe
<b>Recommended</b>	WP7200A	ENET	TF-ENET, TF-10BT	D350ST	HFP2500 (2)	N/A	N/A
<b>Minimum</b>	WR6200A	ENET	TF-ENET	D350ST	HFP1500 (2)	N/A	N/A

Extra Accessories	Item	Qty	Notes
	BNC-M/SMA-F Adapter	2	For WavePro® Configuration
	Terminator, SMA, 50 Ω	2	For 1000Base-T Modes 1 and 4
	Directional Couplers	2	For 1000Base-T Modes 1 and 4
	SMA-M/SMA-M Cable, 18 in.	4	For 1000Base-T Modes 1 and 4

For bundle pricing, please call 1-800-5-LeCroy for details.



## SAS

## AN EXTENSIVE DESIGN AND VALIDATION TOOL

**T**he SDA-SAS software package for LeCroy Serial Data Analyzers provides an extensive set of validation, verification, and debug tools written in accordance with SAS I (1.5 Gb/s) and SAS II (3 Gb/s) electrical specifications. Covered SAS test modes include Internal, Short Backplane, and External Desktop Applications, and Extended, System-to-System Applications.

In addition to standard eye pattern and jitter tests, the SDA-SAS solution provides a complete set of amplitude and jitter measurements, as defined in the Serial Attached SCSI II specification. This combination of measurements makes SDA-SAS the only commercially available automated test suite that meets the requirements for multiple data transfer rates.

In addition, SDA-SAS software benefits from all the user-acclaimed test and measurement tools available in LeCroy's instruments:

- **Jitter Wizard Tool** – Standard in the SDA 11000, it ensures proper jitter measurement setup, allowing for correlation with other test instruments such as Bit Error Rate Test (BERT), sampling oscilloscopes, or Time Interval Analyzers.

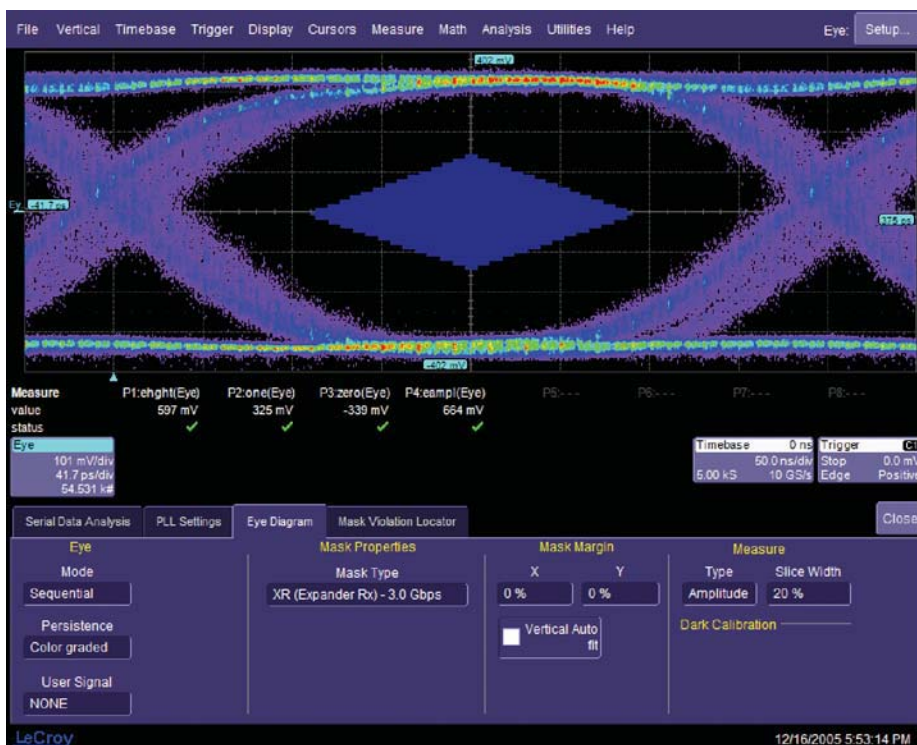

## Leading Features

- Test and Validation for SAS configurations from 1.5 Gb/s up to 6 Gb/s
- Built for QualiPHY Automated Software, compatible with all LeCroy high-performance real-time and sampling oscilloscopes.
- Test Suite conforms to UNH-IOL Methods of Implementation (MOI)
- Built-in support for upcoming Serial Attached SCSI (SAS) Expander technology running at 6 Gb/s
- Flexible, powerful suite of test tools for Physical Layer Device (PHY) layer
- Amplitude, Timing, and Jitter Measurements
- Integrated support for LeCroy SAS *Tracer/Trainer*™ Protocol Analysis Tools
- Custom Clock recovery supports Filtered Jitter measurements.
- Supports a variety of cable configurations and test fixture scenarios.
- **SAS Protocol Solutions by LeCroy** – The LeCroy SAS *Tracer/Trainer* system, with both host emulation and traffic generation capabilities, is supported by the new LeCroy SDA-SAS development environment, and is used in Compliance Jitter Tolerance Pattern (CJTPAT) for signal integrity measurements.
- **D11000PS High Bandwidth Probing System** – Available in dual-SMA input or Solder-In configurations, for a choice between versatility and the highest signal integrity with the lowest probe loading across the entire bandwidth range.

## Powerful Debugging Tools that will Ensure Future SAS 6G Connectivity

In order to validate existing cable technology to support transmission of high-speed differential signals, selective pre-emphasis/de-emphasis may have to be implemented in the electrical signal to ensure error-free transmission.

SDA-SAS will evolve as these requirements are defined to meet these needs.

Similarly, ensuring backward compatibility with legacy SAS infrastructure such as external SAS cables requires the use of advanced characterization tools.

The use of SDA-SAS, in conjunction with the deep memory and powerful analysis library of the SDA instrument family, greatly simplifies the verification process.

Clock recovery circuitry and clock extraction by Phase-Locked Loops (PLLs) is another significant design consideration.

The flexible clock recovery options in the SDA allow for the simulation of virtually any real receiver PLL configuration, thus allowing the simulation of “what if” scenarios. Jitter results can be measured exactly as the receiver would see them.

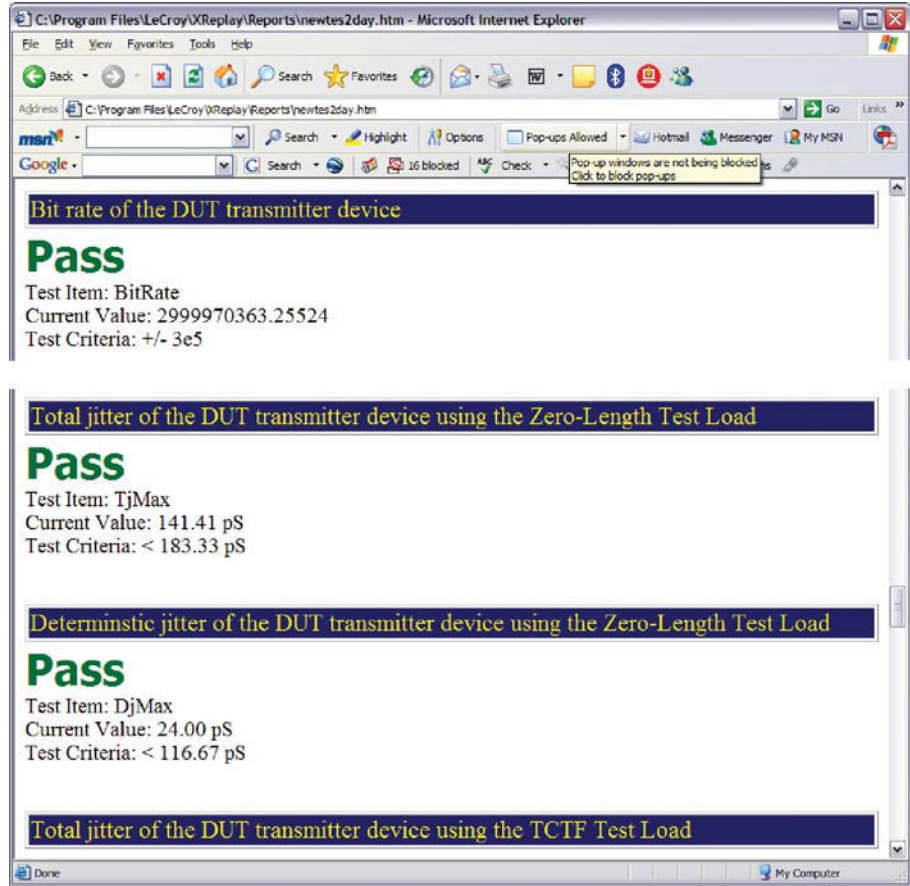

### Fixtures Used:

- Transmitter Transient Test Circuit
- Receiver Transient Test Circuit
- Zero-length Test Fixture
- TCTF Test Load

## SPECIFICATIONS

### OOB Signaling Tests

Test Number	Description
Test 5.1.1	TX Maximum Transients
Test 5.1.2	RX Maximum Transients
Test 5.1.3	TX Device Off Voltage
Test 5.1.4	TX OOB Offset Delta
Test 5.1.5	TX OOB Common Mode Delta
Test 5.1.6	TX Minimum OOB Align Burst Amplitude
Test 5.1.7	TX Maximum Noise During OOB Idle

### SAS Signaling Tests

Test Number	Description
Test 5.2.1	TX Bit Rate
Test 5.2.2	TX Jitter
Test 5.2.3	TX Output Imbalance
Test 5.2.4	TX Rise and Fall Times
Test 5.2.5	TX Skew

SDA-PCIE-G2

PCI EXPRESS COMPLIANCE/DEVELOPMENT SOFTWARE

This package is the ultimate development system for designers working with PCI Express. Spanning the complete device development cycle, design-engineers can focus on systematic, step-by-step functional device development tasks by selecting tests from the Electrical Design Considerations Checklist. Compliance Tests can be run with the integrated Intel-certified Sigtest to ensure success at PCIE Workshops for inclusion in the PCI Express Integrators List.

The Solution for PCI Express Gen2 Testing and Development

The LeCroy PCI Express Compliance and Development software helps you achieve faster time to market and meet the high demands of PCI Express Gen2. With high transfer speeds and timebase accuracy for jitter measurements scheduled to increase with Gen2, the SDA 11000 and SDA 18000

Serial Data Analyzers and PCI Express Compliance and Development software is the ideal solution to meet your needs. This powerful solution, which will be upgraded as the specification evolves, features the ability to:

- Measure up to 18 GHz bandwidth.
- Sample 60 GS/s and up to 150 million acquisition points.

- Capture up to 12.5 million unit intervals (UI) in a single acquisition, allowing measurements on low frequency effects.
- Achieve uncompromised uniformity in frequency and phase response, resulting in dependable eye patterns.
- Works in conjunction with the DA18000 and D11000PS probing system to attain 11 GHz bandwidth overall, with the highest signal integrity and lowest probe loading.

The Solution for PCI Express Gen1

LeCroy offers a complete solution to meet the demands of Gen1 with the SDA 6020 analyzer and PCI Express Compliance and Development software.

The SDA 6020 analyzer provides the needed bandwidth to ensure highly accurate measurements of Gen1 devices, and includes features such as:

- 6 GHz bandwidth measurements, with a sample rate of 20 GS/s
- Accurate and repeatable jitter and bit error analysis
- Low jitter noise floor, less than 1 ps
- Works with the WaveLink Series of differential probes to provide full system bandwidth when used with the SDA 6020.

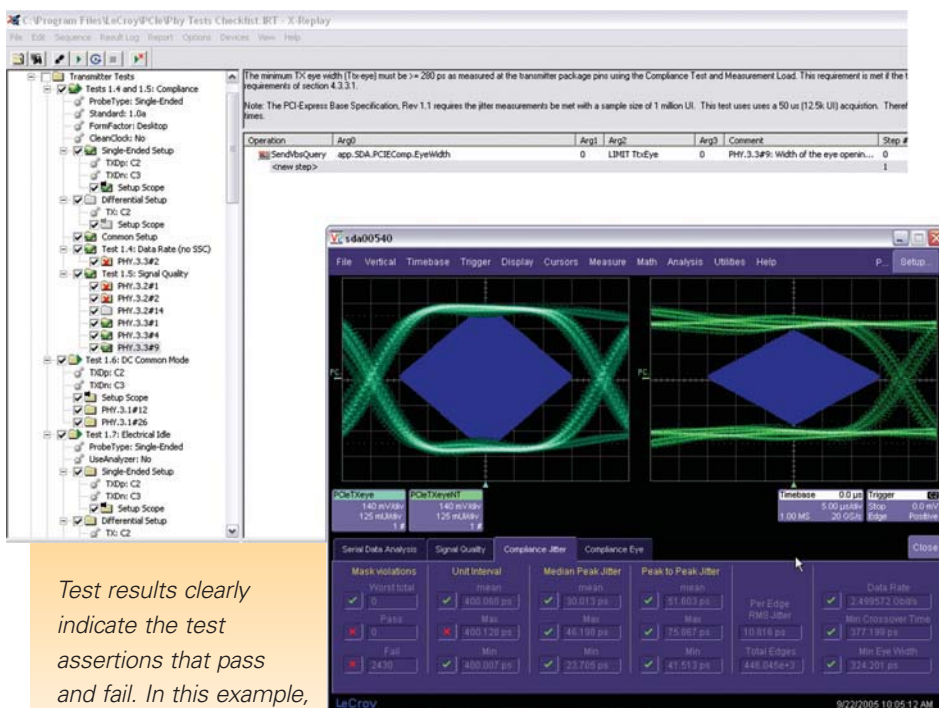

Test results clearly indicate the test assertions that pass and fail. In this example, the transition eye amplitude is not enough at the transmitter pins.

Complete Checklist for Ultimate Design Verification

Complete device development support is available with the LeCroy PCI Express software. Within the software, you have a complete checklist that leads you step-by-step through functional development tasks, and allows you to run compliance tests, including:

- General measurements including bit rate, and spread spectrum clocking (SSC) modulation index
- System tests, including system card eye parameters, receiver detection, and electrical idle transition



- Receiver tests, like Rx AC Voltage, Eye and Jitter, and electrical idle detection
- Add-in card tests, such as transmitted eye, and power consumption limits
- Transmitter tests, including unit interval and transmitted eye parameters

### Integrated System for Electrical Design Testing

By being the first provider to incorporate its PCI Express protocol analyzers and traffic generation tools (gained through its acquisition of Computer Access Technology [CATC]), with this software package, LeCroy offers exclusive coverage of test assertions in accordance with the PCIe Electrical Design Consideration requirements for Gen1.

The LeCroy PE*Tracer* protocol analyzer and PE*Trainer* traffic generator work together to capture, display, generate, and respond to all types of PCI Express Gen1 transactions. The host emulation platform provides you with an easy means to control the device under test (DUT).

### PLL Design Under Your Control

As a PCI Express designer, you need to give much consideration to clock recovery circuitry and clock extraction via Phase-Locked Loops (PLLs). LeCroy PCI Express software includes flexible clock recovery options, which allows for simulation of virtually any real receiver PLL configuration. This provides you with the ability to simulate “what if” scenarios. Additionally, Reference Clock and Transmitter Jitter can be measured.

## SPECIFICATIONS

### General Measurements

Test Number	Description
Test 1.1 – Bit Rate	PHY.3.1#1
Test 1.2 – SSC Modulation Index	PHY.3.1#2
	PHY.3.1#3
Test 1.3 – SSC Tracking	PHY.3.1#4

### Transmitter Tests

Test Number	Description
Test 1.4 – Non-SSC Transmitter Data Rate	PHY.3.3#2
Test 1.5 – Signal Quality	PHY.3.2#1
	PHY.3.2#2
	PHY.3.2#14
	PHY.3.3#1
	PHY.3.3#4
	PHY.3.3#9
Test 1.6 – DC CM Voltage	PHY.3.1#12
	PHY.3.1#26
Test 1.7 – Electrical Idle	PHY.3.1#23
	PHY.3.1#24
	PHY.3.1#27
Test 1.8 – RX Detect Voltage	PHY.3.1#14
Test 1.9 – RX Detect Hi-Z	PHY.3.1#17
Text 1.10 – RX Detect Low-Z	PHY.3.1#18
Test 1.11 – Lane Skew	PHY.3.3#8
Test 1.12 – Rise/Fall	PHY.3.3#3
Test 1.15 – Idle Voltage	PHY.3.3#6
Test 1.16 – Idle Transition	PHY.3.1#19
Test 1.17 – Vdd stability	PHY.3.1#30
	PHY.3.1#31
	PHY.3.1#32
	PHY.3.1#33
Test 1.19 – Electrical Idle Exit Detection	PHY.3.3#7

### Receiver Tests

Test Number	Description
Test 1.21 – Rx AC Voltage, Eye and Jitter	PHY.3.4#1
	PHY.3.4#2
	PHY.3.4#6
	EM.4#22
Test 1.22 – Electrical Idle Detection	PHY.3.4#3
Test 1.23 – Rx data within inter lane skew	PHY.3.4#9

### Add-in Cards

Test Number	Description
Test 1.5 – Add In Card Transmitted Eye	EM.4#19
Test 1.27 – Entering Link Training State	EM.2#27
Test 1.28 – x8 Card Operation in x4 Card	EM.6#4
Test 1.31 – Power Consumption Limits	EM.4#23

## FB-DIMM

### SERIAL DATA COMPLIANCE AND ANALYSIS SOFTWARE

The SDA-FBDIMM compliance and analysis software solution for the SDA 11000 high-performance Serial Data Analyzer provides an extensive set of validation/verification and debug tools written in accordance with the Joint Electron Device Engineering Council (JEDEC) AMB point-to-point electrical specification. Covered test functions include Transmitter, Receiver, and Reference Clock (REFCLK) Tests.

In addition to standard eye pattern and jitter tests, the SDA-FBDIMM solution provides a complete set of amplitude and timing measurements, as defined in the JEDEC specification. This combination of measurements available in SDA-FBDIMM constitutes a truly automated test suite that meets the Fully Buffered DIMM (FB-DIMM) requirements for point-to-point serial data links.

The SDA-FBDIMM software takes advantage of all the advanced test and measurement tools available in LeCroy's instruments:

- **D11000PS High Bandwidth Probing System** – Available in dual-SMA input or Solder-In configurations give you a choice between versatility and the highest signal integrity with the lowest probe loading across the entire bandwidth range.

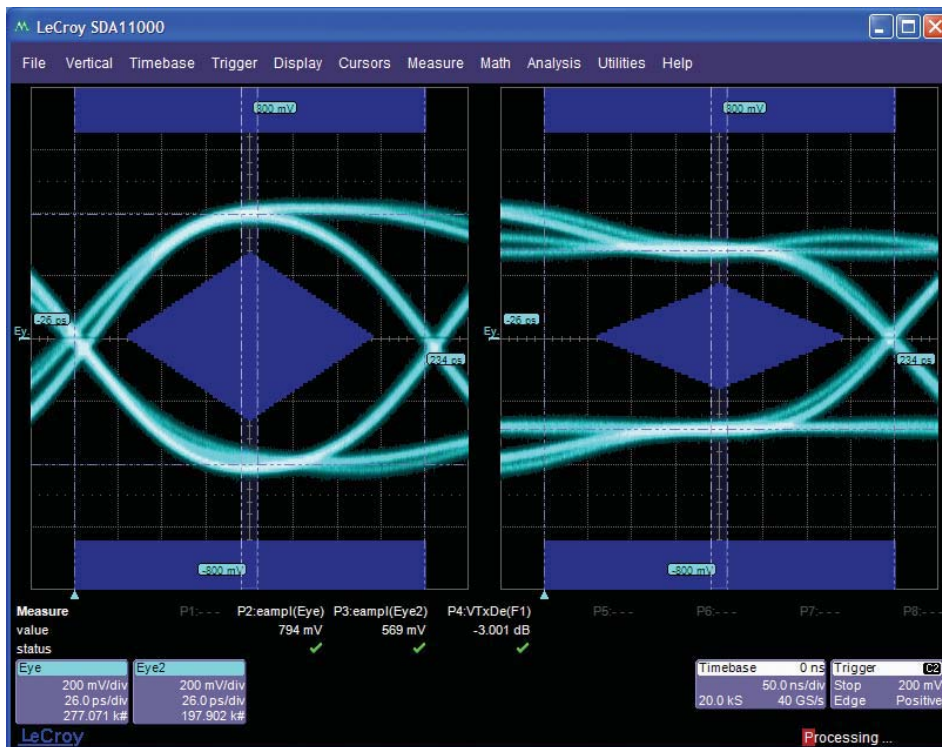

Eye diagram of FB-DIMM.

### Leading Features

- Built for QualiPHY Automated Software, compatible with all LeCroy High-performance Real-time oscilloscopes
- Test and Validation for FB-DIMM configurations from 3.2 Gb/s to 4.8 Gb/s
- Test Suite conforms with JC-45 Validation and Verification Task Group specification—updated to Revision 0.85.
- Built-in support for upcoming 4.8 Gb/s data rates and beyond
- Amplitude, Timing, Jitter, and Eye Measurements
- Custom Clock recovery supports Filtered Jitter measurements.
- Supports all industry standard test fixtures.
- **Jitter Wizard Tool** – Standard in the SDA 11000, it ensures correct jitter measurement setup, with data, clock, or a combination of data and clock signal inputs.
- **Filtered Jitter measurements and Custom PLL configurations** – Allow users to understand the behavior of circuits by selectively applying custom PLL bandwidth and cutoff frequencies.
- **Industry-leading, deep acquisition memory** – (Available up to 100 Mpts/Ch in 2 channel mode) enables true characterization of Spread Spectrum Clock (SSC) measurements required by FB-DIMM specification.

### Powerful Debugging Tools

Ensuring backward-compatibility with legacy Double Data Rate (DDR) designs such as DDR-2 or DDR-3 requires the use of advanced probing tools. LeCroy provides connectivity to DDR test scenarios through LeCroy's family of WaveLink active differential probes, all compatible with SDA 11000.

Similarly, the use of SDA-FBDIMM in conjunction with the deep memory and powerful analysis library of the SDA instrument family greatly simplifies the verification process.

Clock recovery circuitry and clock extraction via Phase-Locked Loops (PLLs) are another significant design considerations. The flexible numerical clock recovery options in the SDA allow for the simulation of virtually any real receiver PLL configuration thus allowing the simulation of “what if” scenarios. Jitter results can be measured exactly as the receiver would see them.

### Comprehensive and Easy to Read Test Reports

As hardware designers are quick to recognize, measurement results often need to be summarized and tabulated for quick specification verification. These test results, together with instrument and signal acquisition/test condition setups, create a fully documented record. SDA-FBDIMM incorporates a choice of automatic HTML, PDF, or RTF report generation formats. The test reports contain tabulated numerical values for each individual test result including PASS/FAIL and specification limit columns.

### Fixtures Supported:

- FB-DIMM Parametric test fixture (Agilent N4236A or equivalent) for Transmitter tests
- FB-DIMM Slot test fixture (Agilent N4238A or equivalent) for Receiver tests
- Channel Test Card (CTC) fixture or Certified Motherboard for Reference Clock tests
- AMB Parametric Test Fixture (Ball Grid Array) Agilent N4235A or equivalent

## SPECIFICATIONS

### Reference Clock Tests

Test Number	Description
Test 1.1	Reference Clock Frequency
Tests 1.2, 1.3	Single-ended Maximum and Minimum Clock Voltages
Test 1.4	Absolute Crossing Point
Test 1.5	Voltage Crossing Variation
Tests 1.6, 1.7, 1.8	Rising and Falling Edge Rate Variation and Mismatch
Test 1.9	Duty Cycle of Reference Clock
Test 1.10	Deterministic Jitter of Reference Clock

### Transmitter Tests

Test Number	Description
Tests 2.1, 2.2, 2.3	Differential Peak-to-Peak Output Voltage for Small Regular and Large Voltage Swing
Tests 2.4, 2.5	DC Common Mode Output Voltage for Small and Large Voltage Swing
Test 2.6	De-emphasized Differential Output Voltage Ratio for -3.5 and -6 dB
Tests 2.7, 2.8, 2.9	AC Peak-to-Peak Common Mode Output Voltage Ratio for Small, Regular and Large Voltage Swings
Test 2.10	Maximum Single-ended Voltage in EI (Electrical Idle) Condition, DC+AC
Test 2.11	Maximum Single-ended voltage in EI (Electrical Idle) Condition, DC Only
Test 2.12	Maximum Peak-to-Peak Differential Voltage in EI Condition
Test 2.13	Single-ended Voltage in D+/D-
Test 2.14	Minimum Tx Eye Width
Test 2.15	Maximum Tx Deterministic Jitter (2.15)
Test 2.16	Instantaneous Pulse Width
Tests 2.17, 2.18	Differential Tx Output Rise/Fall Time
Test 2.19	Mismatch between Rise/Fall Times

### Receiver Tests

Test Number	Description
Test 3.1	Differential Peak-to-Peak Input Voltage
Test 3.2	Maximum Single-ended Voltage for EI Condition, DC+AC
Test 3.3	Maximum Peak-to-Peak Differential Voltage for EI Condition
Test 3.4	Single-ended Voltage on D+/D-
Test 3.5	Maximum Rx Inherent Deterministic Timing Error
Test 3.6	DC Common Mode of the Input Voltage
Test 3.7	AC Peak-to-Peak Common Mode of the Input Voltage
Test 3.8	Ratio of VRX-CM-ACp-p to Minimum VRX-DIFFp-p (3.8)



## 8B/10B

### TRANSLATE SERIAL DATA WAVEFORMS INTO SYMBOL VIEWS

The SDA-8B10B Protocol Decoding software package provides the ability to analyze an encoded data stream and view the physical layer signaling associated with those data streams. Users can simultaneously view the physical layer waveform and the symbolic content of that waveform on one convenient display.

A powerful search feature allows captured waveforms to be searched for user-defined sequences of symbols.

When the sequence of symbols is identified, waveforms are automatically zoomed to highlight the detected sequence.

### Multichannel Operation – View up to Four Lanes Simultaneously

Certain serial data standards (for example PCI Express®) transmit and receive data in multiple lanes. The ability to apply decoding to up to four simultaneously

### Leading Features

- Translates 8B/10B encoded Serial Data Waveforms into symbol views for effective troubleshooting.
- Correlates Protocol Events to Physical Waveforms for greater insight.
- Saves Data to Disk for further analysis.
- Supports multichannel operation to view up to four lanes simultaneously.
- Protocol decoding capability up to 6.25 Gb/s
- Real-time Triggering for data rates up to 2.7 Gb/s\*

\* SDA 6000A XXL models only

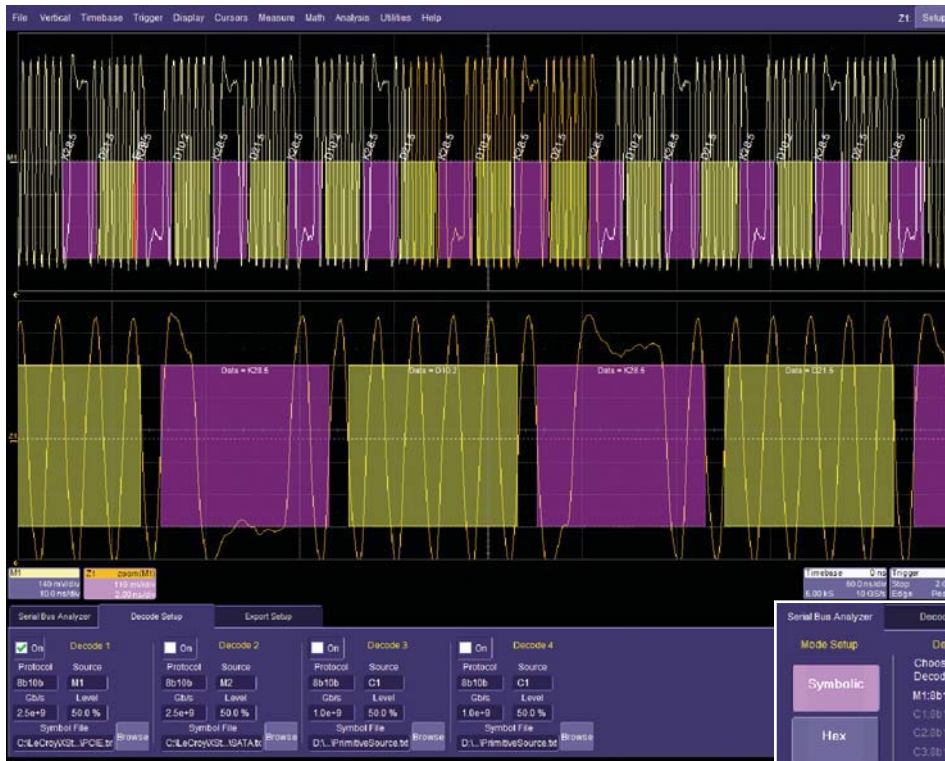

captured channels allows for multi-lane analysis that is not possible with single-channel solutions.

When combined with the high bandwidth abilities of the SDA 11000 oscilloscope, this software option permits symbolic decoding of high-speed serial data applications such as SATA Gen2 (3 Gb/s), PCI Express Gen2 (5 Gb/s) and SAS 6 Gb/s.

Configure and decode up to 4 channels.



## Correlate Protocol Events to Physical Waveforms for Greater Insight

LeCroy's unique combination of advanced protocol analysis and decoding tools allows for ultimate correlation of protocol messages to waveform events.

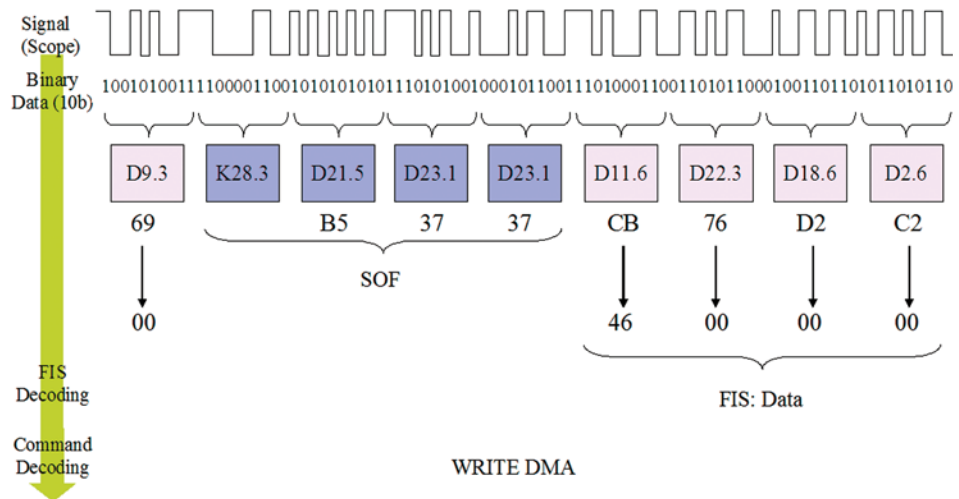
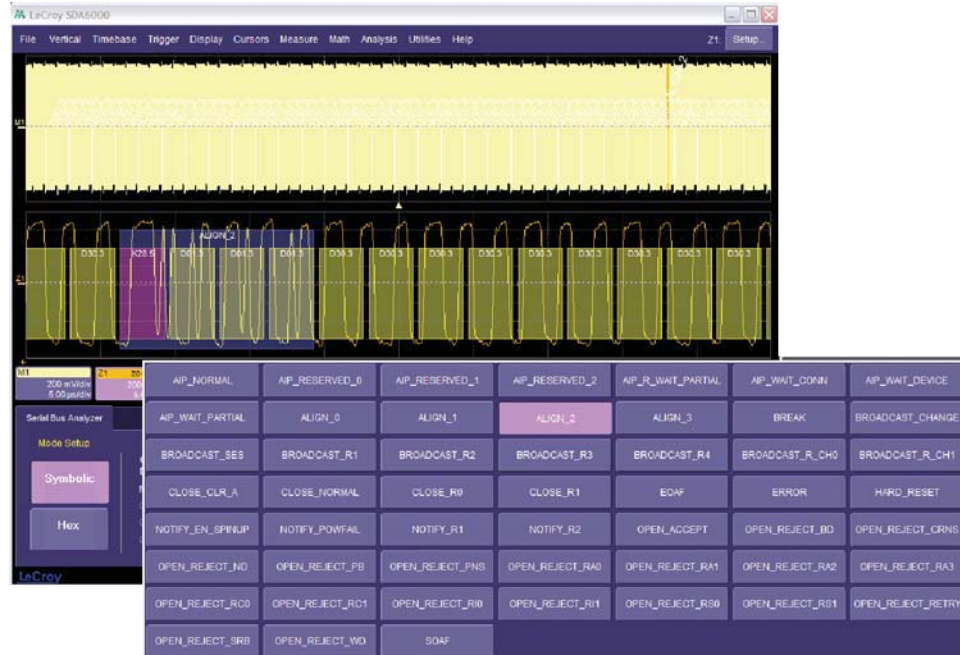

## SPECIFICATIONS

Decoding Level	8B/10B to Symbolic Primitives up to 4 simultaneous channels
ASCII Display	Yes
File Output	Yes
Memory Length	50 Mpts per channel
Hardware Trigger	Yes (SDA 6000A XXL Serial Trigger)
Trigger	32 bits (in SDA 6000A XXL), Advanced Pattern Length Triggering Options when used with Protocol Analyzer Trigger Function
Interaction with Oscilloscope Functions	Yes – All measurement and analysis tools

## HDMI

### FAST, ACCURATE HDMI COMPLIANCE TEST SOLUTION

The SDA-HDMI software package for the SDA family of Serial Data Analyzers provides a concise set of validation/verification and debug tools written in accordance with High Definition Multimedia Interface (HDMI) electrical test specifications. Covered HDMI test modes include Source and Cable Tests covering amplitude-timing, and jitter parameters as well as cable impedance tests.

In addition to standard eye pattern and jitter tests for HDMI, the SDA real-time test equipment platform provides a complete set of amplitude and jitter measurements, as defined in the HDMI specification. This combination of measurements makes SDA-HDMI a cost-effective, compelling HDMI solution.

Additionally, the SDA-HDMI software package takes advantage of all the user-acclaimed test and measurement tools available in LeCroy's instruments:

- *D350ST-SP, WaveLink 4 GHz Bandwidth Probing System* – available in SP (square pins) input or Solder-In (SI) configurations, for a choice between versatility and the highest signal integrity with the lowest probe loading across the entire bandwidth range.
- *Jitter Wizard Tool* – part of the ASDA-J Advanced Serial Data Analysis package ensures proper jitter measurement setup, allowing for correlation with other test instruments such as BERT, sampling scopes, or time interval analyzers (TIAs).

### Leading Features

- Built for QualiPHY Automated Software, compatible with all LeCroy high-performance real-time and sampling oscilloscopes.
- Backward compatible with Digital Video Interactive (DVI).
- Based on same TDMS Serial Data Link developed by Silicon Image.
- HDMI supports standard, enhanced, or high-definition video, plus multi-channel digital audio on a single cable.
- HDMI was designed specifically for consumer electronics applications; it offers an array of additional consumer enhancements.
- Amplitude, Timing, Jitter, and Cable Measurements
- Custom Clock recovery supports Filtered Jitter measurements.
- Supports a variety of cable configurations and test fixture scenarios.

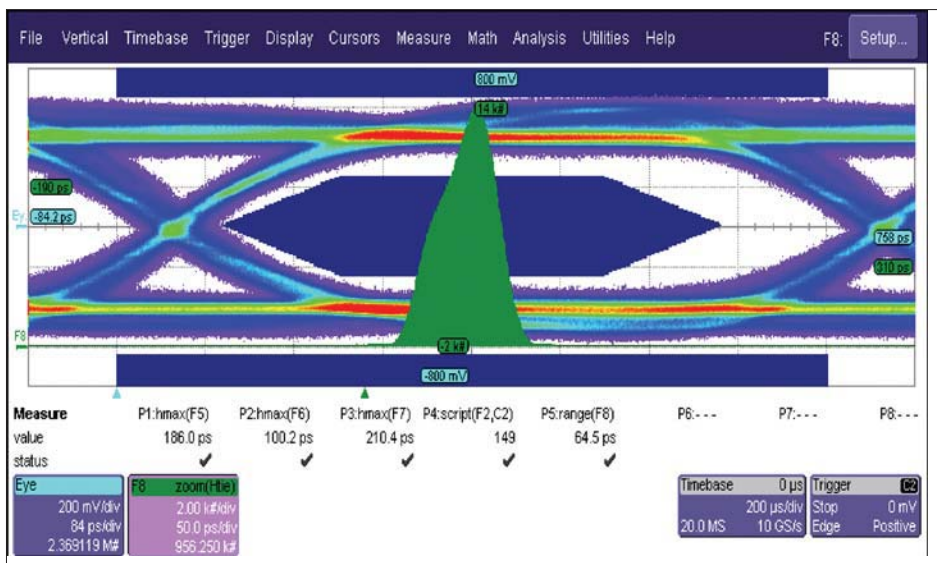

An Innovative Compliance Test Tool.



### Powerful Debugging Tools Ensure HDMI Connectivity

Clock recovery circuitry and clock extraction via Phase-Locked Loops (PLLs) are other significant design considerations. The flexible clock recovery options in the SDA allow for the simulation of virtually any real receiver PLL configuration, thus allowing the simulation of “what if” scenarios. Jitter results can be measured exactly as the receiver would see them.

### Advanced Real-time Jitter and Eye Pattern Analysis

While the SDA instrument family includes the ability to measure jitter and eye patterns in real time, the SDA-HDMI package leverages the Advanced Serial Data Analysis Library (ASDA-J), which provides ultimate control of PLL design, jitter measurement conditions that include detailed Data Dependent Jitter (DDj) breakdown, and bit error rate (BER) analysis. The SDA provides pinpoint accuracy for eye mask violations locator, even in the presence of Spread Spectrum Clocking.

#### Fixtures Used:

- TPA-P-D – Differential Test Fixture
- TPA-P-SE – Single Ended Test Fixture

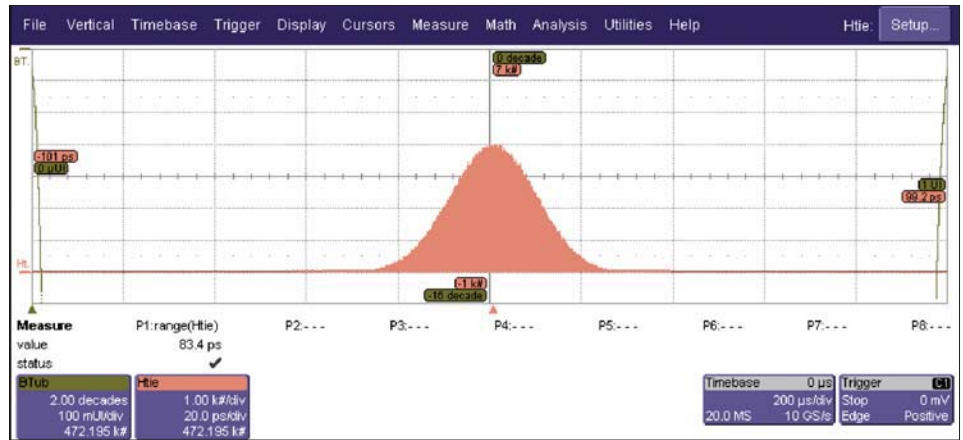

ASDA-J Jitter Analysis.

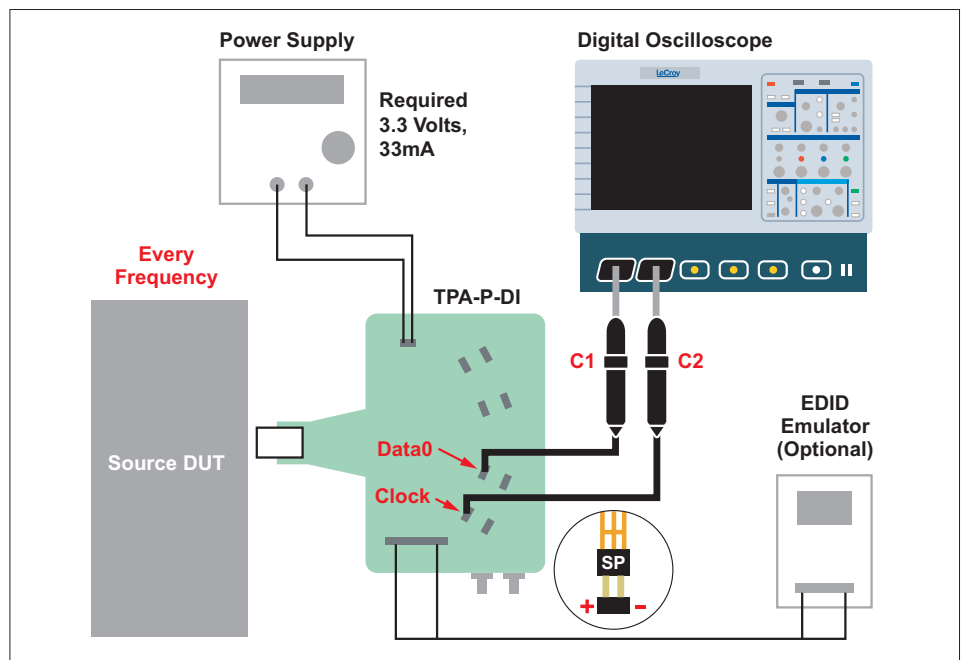

Typical HDMI Test Configuration.

## SPECIFICATIONS

### Source Device (SDA Series)

Test Number	Description
Test 7-2	TMDS-VL
Test 7-4	TDMS-TRISE, TFALL
Test 7-5	TMDS-Over/Undershoot
Test 7-6	TMDS-Inter-Pair Skew
Test 7-7	TDMS-Intra-Pair Skew
Test 7-8	TMDS-Clock Duty Cycle
Test 7-9	TMDS-Clock Jitter
Test 7-10	TMDS-Data Eye Diagram

### Cable Test (SDA Series)

Test Number	Description
Test 5-3	TMDS-Data Eye Diagram

## UWB

### WiMedia UWB COMPLIANCE TEST SOLUTION

**T**he SDA-UWB enables transmitter measurements on direct RF signal output and is the only commercially available software package that combines EVM Measurement, PSD, and Constellation Diagrams in a single application which is totally integrated into the oscilloscope. Other UWB analysis packages run as applications in external math processing software, requiring slow data transfers from the oscilloscope.

The SDA-UWB software package for the Serial Data Analyzer and WaveMaster Families provides a concise set of validation/verification and debug tools written in accordance with WiMedia PHY Compliance and Interoperability Test Specification version 1.0.

The LeCroy SDA 11000 Serial Data Analyzer provides the ideal combination

of high bandwidth, high sample rate, and deep capture memory to enable the user to capture the entire UWB spectrum. Covered transmission test features include software down-conversion, Power Spectral Density (PSD) mask testing of the 3 frequency sub-bands, constellation display, and Error Vector Magnitude (EVM) measurement of UWB radio signals.

### Leading Features

- Spectral analysis and software down-conversion on live UWB WiMedia RF signals
- Mask testing of Power Spectral Density (PSD) in Time-Frequency interleaved (TFI) modes
- Constellation display of baseband signals, Quadrature Phase Shift Keying (QPSK), and Dual Carrier Modulation (DCM)
- Error Vector Magnitude (EVM) parameter measurement
- Symbol by symbol constellation analysis
- Adjacent Channel Power Ratio (ACPR) measurements
- Frequency Error Measurement (FEM)
- Common Phase Error (CPE) vs. Time Plots



Power Spectral Density (PSD) mask testing performed simultaneously in TFI mode.

LeCroy's SDA-UWB package includes capabilities beyond the requirements of the WiMedia PHY Compliance and Interoperability Test Specification version 1.0, which are useful for finding problems in MB-OFDM UWB signals. The magnitude and phase display of the spectrum of a user specified symbol allows checking for variations of phase or magnitude of any tone from symbol to symbol. In this display the CE symbols are not equalized, providing a view of what the signal really looks like before equalization. Header and PSDU symbols are normalized. For QPSK modulation all the tones should have magnitude 1.00 and there are only four possible phases. For DCM modulation there are three

possible amplitudes and 12 possible phases; for this case we provide the ability to view only pilot tones on the magnitude and phase display—pilot tones are always at magnitude 1.00 and one of four possible phases.

LeCroy's EVM computation and constellation display can be over all data and pilot tones (the C&I test specification requirement), or only data tones, only pilot tones, or only a user specified tone; in addition it can be over all symbols in all packets or only for one user specified symbol. The ability to display the constellation and an EVM number for one tone makes it easy to check tones 1 and -1, and tones 56 and -56; in fact when you specify the tone we allow you to specify -61 to +61, so you can check the guard tones. Guard tones are not included in EVM computation or in the constellation for data, pilots, or data and pilots. The ability to check EVM for a specified symbol allows you to dial through the symbols and see if there is a time related disturbance. A time related disturbance will also show up in our Real and Imaginary traces that we display to the left of the constellation; these contain all the points that form the constellation. It is even possible to select both a specific tone and a specific symbol, in which case the constellation has one dot.

The usual "time related disturbance" of EVM is due to phase noise on the carrier. Phase noise causes a varying Common Phase Error (CPE). The WiMedia PHY Compliance and Interoperability Test Specification version 1.0 requires the EVM computation to measure and low pass filter CPE, and to only correct for the output of the low pass filter. The intent is that fast variation in CPE will degrade EVM. The SDA-UWB software allows you to choose whether to apply this filter or not. When the filter is not applied, CPE is completely corrected for on a symbol by symbol basis, improving EVM. This indicates how much EVM would improve if phase noise was reduced.

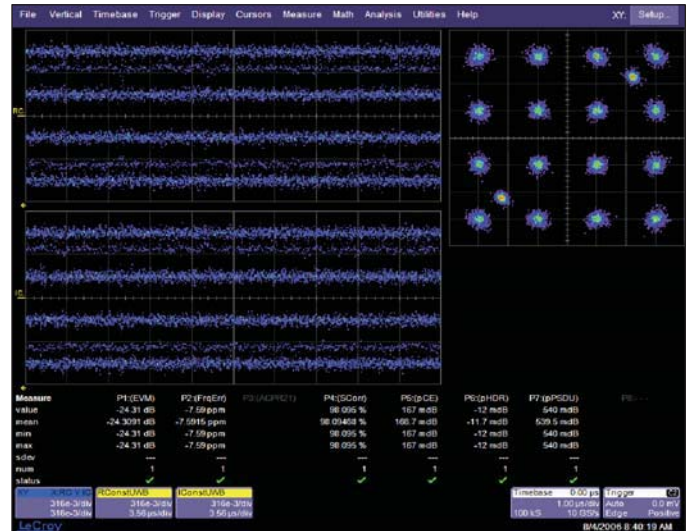

Constellation display of DCM signal and EVM and other required measurements



Spectrogram of a UWB signal hopping over three frequency bands of a band group

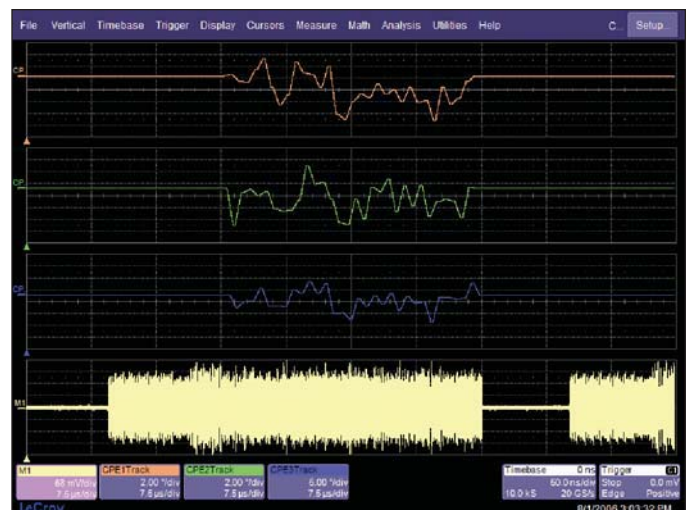

Common Phase Error (CPE) of the carrier frequency of each band vs. time



**SDA 18000, SDA 11000, SDA 9000 SPECIFICATIONS**

Vertical System	SDA 18000			SDA 11000		SDA 9000	
	18 GHz/Ch Mode	11 GHz/Ch Mode	6 GHz/Ch Mode	11 GHz/Ch Mode	6 GHz/Ch Mode	9 GHz/Ch Mode	6 GHz/Ch Mode
Analog Bandwidth @ 50 Ω (-3 dB)	18 GHz	11 GHz	6 GHz	11 GHz	6 GHz	9 GHz	6 GHz
Rise Time (Typical, 10–90%)	27 ps	40 ps	75 ps	40 ps	75 ps	49 ps	75 ps
Rise Time (Typical, 20–80%)	19 ps	28 ps		28 ps			
Input Channels	1	1	4, 2, or 1	2 or 1	4 or 2	2 or 1	4 or 2
Bandwidth Limiters	Full BW only		20 MHz, 200 MHz, 1 GHz, 3 GHz, 4 GHz	Full BW only	20 MHz, 200 MHz, 1 GHz, 3 GHz, 4 GHz	Full BW only	20 MHz, 200 MHz, 1 GHz, 3 GHz, 4 GHz
Input Impedance	50 Ω ±2.0%						
Input Coupling	DC, GND						
Maximum Input Voltage	±4 V <sub>peak</sub>						
Vertical Resolution	8 bits; up to 11 bits with enhanced resolution (ERES)						
Sensitivity	2 mV–1 V/div ( < 10 mV/div through zoom)		2 mV–1 V/div (fully variable, < 10 mV/div through zoom)	2 mV–1 V/div ( < 10 mV/div through zoom)	2 mV–1 V/div (fully variable, < 10 mV/div through zoom)	2 mV–1 V/div ( < 10 mV/div through zoom)	2 mV–1 V/div (fully variable, < 10 mV/div through zoom)
DC Gain Accuracy	±1.5% of full scale						
Offset Range	±750 mV @ 2 mV–194 mV/div ±4 V @ 196 mV–1 V/div						
Offset Accuracy	±(1.5% of full scale +1.5% of offset value +2 mV)						

**Horizontal System**

Timebases	Internal timebase common to 4 input channels; an external 100 MHz reference may be applied on the rear panel			Internal timebase common to 4 input channels; clock out available for reference (option SDA-REFCLK)			
Time/Division Range, Real Time	10 ps/div–100 μs/div (Std. memory) 10 ps/div–500 μs/div (-XL memory)	20 ps/div– 10 s/div	10 ps/div– 100 μs/div (Std. memory) 10 ps/div– 500 μs/div (-XL memory)	20 ps/div– 10 s/div	10 ps/div– 100 μs/div (Std. memory) 10 ps/div– 500 μs/div (-XL memory)	20 ps/div– 10 s/div	
Time/Division Range, Random Interleaved Sampling (RIS)	N/A	to 20 ps/div (upper time / div limit function of sample rate and memory length settings)	N/A	to 20 ps/div (upper time / div limit function of sample rate and memory length settings)	N/A	to 20 ps/div (upper time / div limit function of sample rate and memory length settings)	
Math and Zoom Traces	8 independent zoom and 8 math or zoom traces						
Sample Rate and Delay	±1 ppm @ 25 °C						
Time Accuracy							
Time Interval Accuracy	≤ 0.06 / SR + (1 ppm * Reading) (rms)						
Jitter Noise Floor	< 350 fs rms measured with 35 ps rise time (typical)	1 ps rms (typical)	< 350 fs rms measured with 35 ps rise time (typical)	1 ps rms (typical)	< 350 fs rms measured with 35 ps rise time (typical)	1 ps rms (typical)	
Trigger and Interpolator Jitter	≤ 2.5 ps rms (typical)						
Channel-Channel Deskew Range	±9 x time/div. setting, or 25 ns, whichever is larger						
External Timebase Reference In	100 MHz; 50 Ω impedance, applied at the rear input			N/A		N/A	
External Clock	N/A			N/A		N/A	
Clock Reference Out (SDA-REFCLK option)	N/A			100 MHz, sinusoid, 0 dBm (636 mVp-p)		100 MHz, sinusoid, 0 dBm (636 mVp-p)	

## SDA 18000, SDA 11000, SDA 9000 SPECIFICATIONS

Acquisition System	SDA 18000			SDA 11000		SDA 9000	
	18 GHz/Ch Mode	11 GHz/Ch Mode	6 GHz/Ch Mode	11 GHz/Ch Mode	6 GHz/Ch Mode	9 GHz/Ch Mode	6 GHz/Ch Mode
Single-Shot Sample Rate/Ch	60 GS/s on 1 Ch	40 GS/s on 1 Ch	20 GS/s on 4, 2 or 1 Ch	40 GS/s on 2 or 1 Ch	20 GS/s on 4 or 2 Ch	40 GS/s on 2 or 1 Ch	20 GS/s on 4 or 2 Ch
Random Interleaved Sampling (RIS)	N/A		200 GS/s for repetitive signals, to 20 ps /div.	N/A	200 GS/s for repetitive signals, to 20 ps /div.	N/A	200 GS/s for repetitive signals, to 20 ps /div.
Maximum Trigger Rate	150,000 waveforms / second						
Intersegment Time	6 $\mu$ s						
Maximum Acquisition Memory Points/Ch	1 Ch	1 Ch	4 Ch	2 Ch	4 Ch	2 Ch	4 Ch
Standard Memory	60M	40M	20M	40M	20M	40M	20M

## Acquisition Processing

Averaging	Summed averaging to 1 million sweeps; continuous averaging to 1 million sweeps
Enhanced Resolution (ERES)	From 8.5 to 11 bits vertical resolution
Envelope (Extrema)	Envelope, floor, or roof for up to 1 million sweeps

## Triggering System

Modes	Normal, Auto, Single, and Stop
Sources*	Any input channel, External, Ext X 10, Ext $\pm$ 10, or line; slope and level unique to each source (except line trigger)
Coupling Mode	DC
Pre-trigger Delay	0–100% of memory size (adjustable in 1% increments)
Post-trigger Delay	the smaller of 0–10,000 divisions or 86400 seconds
Hold-off by Time or Events	From 2 ns up to 20 s or from 1 to 99,999,999 events
Internal Trigger Range	$\pm$ 5 div from center
Trigger Sensitivity with Edge Trigger (Ch 1–4)	3 div @ $\leq$ 5 GHz 2 div @ $<$ 4 GHz 1.2 div @ $<$ 3 GHz (typical)
External Trigger Sensitivity, (Edge Trigger)	1.2 V @ $\leq$ 5 GHz, 800 mV @ $<$ 4 GHz, 480 mV @ $<$ 3 GHz (typical)
Max. Trigger Frequency, SMART Trigger	750 MHz @ $\leq$ 10 mV
External Trigger Input Range	Aux ( $\pm$ 0.4 V); Aux X10 ( $\pm$ 0.04 V); Aux/10 ( $\pm$ 4 V)

## Basic Triggers

Edge/Slope/Line	Triggers when signal meets slope and level condition.
-----------------	---

## SMART Triggers

State or Edge Qualified	Triggers on any input source only if a defined state or edge occurred on another input source. Delay between sources is selectable by time or events.
Dropout	Triggers if signal drops out for longer than selected time between 2 ns and 20 s.
Pattern	Logic combination (AND, NAND, OR, NOR) of 5 inputs* – 4 channels and external trigger input. Each source can be high, low, or don't care. The High and Low level can be selected independently. Triggers at start or end of the pattern.

\*Non-active channels are not available as trigger sources when operating in high bandwidth modes (9 GHz, 11 GHz, or 18 GHz)

# SERIAL DATA ANALYZERS

## SDA 6020, SDA 6000A XXL, SDA 4020, SDA 4000A XXL SPECIFICATIONS

Vertical System	SDA 6020	SDA 6000 XL	SDA 4020	SDA 4000A XXL
Analog Bandwidth @ 50 Ω (-3 dB)	6 GHz	6 GHz	4 GHz	4 GHz
Rise Time (Typical)	75 ps	75 ps	105 ps	105 ps
Input Channels	4			
Bandwidth Limiters	20 MHz, 200 MHz, 1 GHz, 3 GHz, 4 GHz		20 MHz, 200 MHz, 1 GHz, 3 GHz	
Input Impedance	50 Ω ±2.0%			
Input Coupling	DC, GND			
Maximum Input Voltage	±4 V <sub>peak</sub>			
Channel-Channel Isolation	≥ 100:1 at 2 GHz; ≥ 40:1 at 3 GHz; ≥ 20:1 at 4 GHz			
Vertical Resolution	8 bits; up to 11 bits with enhanced resolution (ERES)			
Sensitivity	2 mV-1 V/div (fully variable, < 10 mV/div through zoom)			
DC Gain Accuracy	±1.5% of full scale			
Offset Range	±750 mV @ 2 mV-194 mV/div ±4 V @ 195 mV-1 V/div			
Offset Accuracy	±(1.5% of full scale +1.5% of offset value +2 mV)			

### Horizontal System

Timebases	Internal timebase common to 4 input channels; an external clock may be applied at the auxiliary input			
Time/Division Range	Real Time: 20 ps/div-10 s/div Random Interleave Sampling: to 20 ps/div, Upper time/div limit function of sample rate and memory length settings			
Math and Zoom Traces	8 independent zoom and 8 math or zoom traces			
Sample Rate and Delay Time Accuracy	±1 ppm ≤ 10 s interval			
Time Interval Accuracy	≤ 0.06 / SR + (1 ppm * Reading) (rms)			
Jitter Noise Floor	1 ps rms (typical)			
Trigger and Interpolator Jitter	≤ 2 ps rms (typical)			
Channel-Channel Deskew Range	±9 x time/div. setting, or 25 ns, whichever is larger			
External Timebase Reference	100 MHz; 50 Ω impedance, applied at the rear input			
External Clock	30 MHz – 2 GHz 50 Ω impedance applied at the auxiliary input	N/A	30 MHz – 2 GHz 50 Ω impedance applied at the auxiliary input	N/A

### Acquisition System

Single-Shot Sample Rate/Ch	20 GS/s of 4 Ch	20 GS/s on 2 Ch; 10 GS/s on 4 Ch	20 GS/s of 4 Ch	20 GS/s on 2 Ch; 10 GS/s on 4 Ch
Random Interleaved Sampling (RIS)	200 GS/s for repetitive signals, to 20 ps /div. Upper time/div limit function of sample rate and memory length settings			
Maximum Trigger Rate	150,000 waveforms/second			
Intersegment Time	6 μs			
Maximum Acquisition Memory Points/Ch	4 Ch	(2 Ch) / (4 Ch)	4 Ch	(2 Ch) / (4 Ch)
Standard Memory	20M	100M / 50M	20M	100M / 50M
VL – Memory Option	32M	N/A	32M	N/A
XL – Memory Option	50M	N/A	50M	N/A

### Acquisition Processing

Averaging	Summed averaging to 1 million sweeps; continuous averaging to 1 million sweeps
Enhanced Resolution (ERES)	From 8.5 to 11 bits vertical resolution
Envelope (Extrema)	Envelope, floor, or roof for up to 1 million sweeps

### Triggering System

Modes	Normal, Auto, Single, and Stop
Sources*	Any input channel, External, Ext X 10, Ext ±10, or line; slope and level unique to each source (except line trigger)
Coupling Mode	DC
Pre-trigger Delay	0-100% of memory size (adjustable in 1% increments)
Post-trigger Delay	The smaller of 0-10,000 divisions or 86,400 seconds
Hold-off by Time or Events	From 2 ns up to 20 s or from 1 to 99,999,999 events

\*External trigger not available on the SDA 6000A XXL or SDA 4000A XXL.



## SDA 6020, SDA 6000A XXL, SDA 4020, SDA 4000A XXL SPECIFICATIONS

Triggering System (continued)	SDA 6020	SDA 6000A XXL	SDA 4020	SDA 4000A XXL
Internal Trigger Range	±5 div from center			
Trigger Sensitivity with Edge Trigger (Ch 1-4)	3 div @ ≤ 5 GHz 2 div @ < 4 GHz 1.2 div @ < 3 GHz (typical)		2 div @ ≤ 4 GHz 1.2 div @ < 3 GHz (typical)	
External Trigger Sensitivity, (Edge Trigger)	1.2 V @ ≤ 5 GHz 800 mV @ < 4 GHz 480 mV < 3 GHz (typical)		800 mV @ ≤ 4 GHz, 480 mV < 3 GHz (typical)	
Max. Trigger Frequency, SMART Trigger	750 MHz @ ≤ 10 mV			
External Trigger Input Range	Aux (±0.4 V); Aux X10 (±0.04 V); Aux/10 (±4 V)	N/A	Aux (±0.4 V); Aux X10 (±0.04 V); Aux/10 (±4 V)	N/A

### Basic Triggers

Edge/Slope/Line Triggers when signal meets slope and level condition.

### SMART Triggers

State or Edge Qualified Triggers on any input source only if a defined state or edge occurred on another input source. Delay between sources is selectable by time or events.

Dropout Triggers if signal drops out for longer than selected time between 2 ns and 20 s.

Pattern\* Logic combination (AND, NAND, OR, NOR) of 5 inputs – 4 channels and external trigger input. Each source can be high, low, or don't care. The High and Low level can be selected independently. Triggers at start or end of the pattern.

### Serial Trigger†

Data Rates	N/A	50 Mb/s to 2.7 Gb/s	N/A	50 Mb/s to 2.7 Gb/s
Pattern Length	N/A	Up to 32 bits	N/A	Up to 32 bits
Clock and Data Outputs	N/A	1/2 amplitude AC coupled LVPCCL 400 mV <sub>pp</sub> into 50 Ω	N/A	1/2 amplitude AC coupled LVPCCL 400 mV <sub>pp</sub> into 50 Ω

### SMART Triggers with Exclusion Technology

Glitch Triggers on positive or negative glitches with widths selectable from 600 ps to 20 s, or on intermittent faults

Signal or Pattern Width Triggers on positive or negative pulse widths selectable from 600 ps to 20 s, or on intermittent faults

Signal or Pattern Interval Triggers on intervals selectable between 2 ns and 20 s.

### Setup Storage

Front Panel and Instrument Status Store to the internal hard drive or to a USB-connected peripheral device.

### Power Requirements

Voltage	100–240 VAC ±10% at 50/60/400 Hz; 200–240 VAC ±10% at 50/60 Hz; Automatic AC Voltage Selection			
Max. Power Consumption	800 VA (800 W)	650 W/650 VA	800 VA (800 W)	650 W/650 VA

### Environmental

Temperature (Operating) +5 °C to +40 °C including CD-ROM drives

Temperature (Non-Operating) –20 °C to +60 °C

Humidity (Operating) 5% to 80% relative humidity (non-condensing) up to +30 °C. Upper limit derates to 25% relative humidity (non-condensing) at +40 °C.

Humidity (Non-Operating) 5% to 95% relative humidity (non-condensing) as tested per MIL-PRF-28800F

Altitude (Operating) Up to 10,000 ft. (3048 m) at or below +25 °C

Altitude (Non-Operating) Up to 40,000 ft. (12,192 m)

### Physical Dimensions

Dimensions (HWD)	264 mm x 397 mm x 491 mm; 10.4" x 15.6" x 19.3" (height excludes feet)			
Weight	23 kg; 50 lbs.	18 kg; 39 lbs.	23 kg; 50 lbs.	18 kg; 39 lbs.
Shipping Weight	29 kg; 63 lbs.	24 kg; 53 lbs.	29 kg; 63 lbs.	24 kg; 53 lbs.

### Certifications

CE Compliant; UL and cUL listed; Conforms to EN 61326 (for EMC); EN 61010, UL 61010B-1 and CSA C22.2 No. 1010.1 (for safety)

### Warranty and Service

3-year warranty; calibration recommended annually.

Optional service programs include extended warranty, upgrades, and calibration services. \*Maximum of 4-channels on the

\*Maximum of 4 channels (no External) on the SDA 6000A XXL and SDA 4000A XXL.

†Serial Trigger is available in SDA 6000A XXL and SDA 4000A XXL.

**SDA 18000, SDA 11000, SDA 9000 ORDERING INFORMATION**

**Description Product Code**

**SDA Serial Data Analyzers**

4 Ch; 18 GHz Serial Data Analyzer; 18 GHz, 60 GS/s 60 Mpts on 1 Ch, 6 GHz, 20 GS/s 20 Mpts/Ch on 4 Ch	SDA 18000
4 Ch; 11/6 GHz Serial Data Analyzer; 11 GHz, 40 GS/s 40 Mpts on 2 Ch; 6 GHz, 20 GS/s 20 Mpts on 4 Ch	SDA 11000
4 Ch; 9 GHz Serial Data Analyzer; 9 GHz 40 GS/s 40 Mpts/Ch on 2 Ch; 6 GHz, 20 GS/s 20 Mpts/Ch on 4 Ch	SDA 9000

**Included with Standard Configuration**

ProLink Adapter, Type K; 1 each (SDA 18000 only)	LPA-K
ProLink Adapter, SMA; 4 each (3 each with SDA 18000)	LPA-SMA
ProLink Adapter BNC; 2 each	LPA-BNC
Printed Getting Started Manual, Operator's Manual	
CD-ROMs containing Operator's Manual, Remote Control Manual, Automation Manual, and Software Options Manual	
CD-ROMs containing Utility Software and Norton Antivirus Software (1 year subscription)	
CD-ROM Drive	
Optical 3-button Wheel Mouse-USB	
Standard Ports; 10/100Base-T Ethernet, Parallel, SVGA Video Output, PowerMac G4/QS USB 2.0	
Power Cable (for the country ordered from)	
Protective Front Cover	
Standard Commercial Calibration and Performance Certificate	
3-Year Warranty	

**Memory Options**

<b>For SDA 18000:</b>	
150 Mpts/18 GHz, 100 Mpts/11 GHz, 50 Mpts/4 Ch	SDA18-XL
<b>For SDA 11000:</b>	
100 Mpts/11 GHz, 50 Mpts/4 Ch	SDA11-XL
<b>For SDA 9000:</b>	
100 Mpts/9 GHz, 50 Mpts/4 Ch	SDA9-XL

**Software Options**

**Standards Compliance Software Options**

Ethernet Test Software Package	ENET
FB-DIMM Solution Analysis Compliance Software Package (SDA 11000/SDA 9000 only)	SDA-FBDIMM
HDMI Compliance Test Software Package	SDA-HDMI
PCI Express Development and Compliance Software for Gen1 and Gen2	SDA-PCIE-G2
SAS Compliance Software Package	SDA-SAS
SATA Gen1/Gen2 Solution Analysis Software Package	SDA-SATA
UWB Test Solution Software Package	SDA-UWB
USB 2.0 Compliance Test Software Package	USB2

**Application Specific Test and Analysis Software Options**

Advanced Optical Recording Measurement Software Package	AORM
Disk Drive Measurements Software Package	DDM2

**Advanced Math and WaveShape Analysis Software Options**

Digital Filter Software Package	DFF2
Advanced Customization Software Package	XDEV
Processing Web Editor Software Package for Functions and Parameters	XWEB

**Description Product Code**

**Hardware and Software Option**

32 Digital Channel Oscilloscope Mixed Signal Option	MS-32-DSA
---	-----------

**Hardware Options and Accessories**

100 MHz Reference Clock Output (SDA 11000/SDA 9000 only)	SDA-REFCLK
38 GHz Trigger Prescaler	SDA-TPS
1 MΩ Adapter includes PP005A Passive Probe	AP-1M
IEEE-488 GPIB Control Interface	GPIB-1
Dual Monitor Display	DMD-1
Keyboard, USB	KYBD-1
ProLink-to-BNC Adapter; 1 each	LPA-BNC
Kit of 4 ProLink BNC Adapters with Case	LPA-BNC-KIT
ProLink-to-SMA Adapter	LPA-SMA
Kit of 4 SMA ProLink Adapters with Case	LPA-SMA-KIT
ProLink-to-Type 'K' adapter; 1 each	LPA-K
Oscilloscope Cart with Additional Shelf and Drawer	OC1024
Oscilloscope Cart	OC1021
Removable Hard Drive Package	WM-RHD
Additional Removable Hard Drive (includes USB, CD-ROM, and spare hard drive)	WM-RHD-02
Hard Shell Transit Case	SDA11-TC1

**Compliance Test Fixtures**

HDMI Test Fixture Set (TPA-P-SE, TPA-P-DI)	TF-HDMI
Ethernet Compliance Test Fixture for 10Base-T	TF-10BT
Telecom Adapter Kit 100 Ω Bal., 120 Ω Bal., 75 Ω Unbal.	TF-ET
Ethernet Compliance Test Fixture for 100Base-T/1000Base-T [Includes a Set of 2 Test Fixtures Signals on Twisted Pair Cables (UTP)]	TF-ENET
Serial ATA Test Fixture (Includes Pair of SMA Cables)	TF-SATA
USB 2.0 Testing Compliance Test Fixture	TF-USB

**Probe Options and Probe Accessories**

18 GHz Differential Amplifier (SDA 18000 only)	DA18000
Differential Probe System	D11000PS
WaveLink 7.5 GHz, Differential Probe Adjustable Tip Module	D600A-AT*
WaveLink 7 GHz, Differential Probe Small Tip Module	D600ST*
WaveLink 4 GHz, 5 V Differential Probe Small Tip Module	D350ST*
WaveLink 6 GHz, Differential Positioner Mounted Tip Probe Module	D500PT*
WaveLink ProLink Probe Body	WL600
1 GHz Active Differential Probe (±1, ±10, ±20)	AP034
7.5 GHz Low Capacitance Passive Probe 500/1000 Ω	PP066
2.5 GHz, 0.7 pF Active Probe (±10), Small Form Factor	HFP2500
Probe Deskew and Calibration Test Fixture	TF-DSQ
Cascade Microtech EZ-Probe Positioner	EZ PROBE

\*For a complete probe, order a WL600 Probe Body with the Probe Tip Module.

**Customer Service**

LeCroy oscilloscopes are designed, built, and tested to ensure high reliability. In the unlikely event you experience difficulties, our digital oscilloscopes are fully warranted for three years, and LeCroy probes are warranted for one year.

This warranty includes:

- No charge for return shipping
- Long-term 7-year support
- Upgrade to latest software at no charge

## SDA SERIES ORDERING INFORMATION

Description	Product Code
4 Ch; 6 GHz Serial Data Analyzer; 20 GS/s; 20 Mpts/Ch	SDA 6020
4 Ch; 6 GHz Serial Data Analyzer; 10 GS/s; 50 Mpts/Ch; 20 GS/s, 100 Mpts in 2 or 1 Ch	SDA 6000A XXL
4 Ch; 4 GHz Serial Data Analyzer; 20 GS/s; 20 Mpts/Ch	SDA 4020
4 Ch; 4 GHz Serial Data Analyzer; 10 GS/s; 50 Mpts/Ch; 20 GS/s, 100 Mpts in 2 or 1 Ch	SDA 4000A XXL

**Memory Options SDA 6020 / SDA 4020**

32M/Ch	SDA-VL
50M/Ch	SDA-XL

**Included with Standard Configurations**

ProLink Adapter SMA; 4 each	LPA-SMA
ProLink Adapter BNC; 2 each	LPA-BNC
Printed Getting Started Manual, Operator's Manual	
CD-ROM containing Operator's Manual, Remote Control Manual, and Automation Manual	
CD-ROMs containing Utility Software, and Norton Antivirus Software (1 year subscription)	
CD-ROM Drive	
Optical 3-button Wheel Mouse-USB	
Standard Ports; 10/100Base-T Ethernet, Parallel, SVGA Video Output, USB 2.0	
Protective Front Cover	
Standard Commercial Calibration and Performance Certificate	
3-Year Warranty	

**Software Options****Application Specific Test and Analysis Software Options**

Advanced Optical Recording Measurement	AORM
Disk Drive Measurement Software Package	DDM2

**Advanced Math and WaveShape Analysis Software Options**

Digital Filter Software Package	DFP2
Advanced M1 Software Package for Jitter and Timing Measurements (4 seats)	LECROYM1/ADV-4
Basic M1 Software Package for Jitter and Timing Measurements	LECROYM1/BASIC
Advanced Customization Software Package	XDEV
Processing Web Editor Software Package for Functions and Parameters	XWEB

**Standards Compliance Software Options**

Ethernet Test Software Package	ENET
HDMI Compliance Test Software Package	SDA-HDMI
PCI Express Development and Compliance Software for Gen1 and Gen2	SDA-PCIE-G2
SAS I/II Solution Analysis Compliance Software Package	SDA-SAS
SATA Gen1/Gen2 Solution Analysis Software Package	SDA-SATA
UWB Test Solution Software Package	SDA-UWB*
USB 2.0 Compliance Test Software Package	USB2

\*Compatible with SDA 6000A XXL and SDA 6020 only.

**Hardware and Software Option**

32 Digital Oscilloscope Mixed Signal Option	MS-32-DSA
---	-----------

Description	Product Code
-------------	--------------

**Hardware Options and Accessories**

1 M $\Omega$ Adapter includes PP005A Passive Probe	AP-1M
Dual Monitor Display	DMD-1
IEEE-488 GPIB Control Interface	GPIB-1
Keyboard, USB	KYBD-1
ProLink-to-BNC Adapter; 1 each	LPA-BNC
Kit of 4 ProLink BNC Adapters with Case	LPA-BNC-KIT
ProLink-to-SMA Adapter	LPA-SMA
Kit of 4 SMA ProLink Adapters with Case	LPA-SMA-KIT
Oscilloscope Cart with Additional Shelf and Drawer	OC1024
Oscilloscope Cart	OC1021
Rackmount Adapter with 25" (64 cm) Slides	RMA-25
Rackmount Adapter with 30" (76 cm) Slides	RMA-30
Internal Graphics Printer	WM-GP02
Removable Hard Drive Package (includes USB, CD-ROM, removable hard drive, and spare hard drive)	WM-RHD
Additional Removable Hard Drive	WM-RHD-02
Soft Carrying Case	WM-SCC
Hard Transit Case	WM-TC1

**Compliance Test Fixtures**

Ethernet Compliance Test Fixture for 10Base-T	TF-10BT
Ethernet Compliance Test Fixture for 100Base-T/1000Base-T [Includes a Set of 2 Test Fixtures Signals on Twisted Pair Cables (UTP)]	TF-ENET
Telecom Adapter Kit 100 $\Omega$ Bal., 120 $\Omega$ Bal., 75 $\Omega$ Unbal.	TF-ET
HDMI Test Fixture Set (TPA-P-SE, TPA-P-DI)	TF-HDMI
Serial ATA Test Fixture (includes pair of SMA cables)	TF-SATA
USB 2.0 Testing Compliance Test Fixture	TF-USB

**Probes Options and Probe Accessories**

1 GHz, Active Differential Probe ( $\pm 1$ , $\pm 10$ , $\pm 20$ )	AP034
WaveLink 7.5 GHz, Differential Probe Adjustable Tip Module	D600A-AT*
WaveLink 7 GHz, Differential Probe Small Tip Module	D600ST*
WaveLink 4 GHz, 5 V Differential Probe Small Tip Module	D350ST*
WaveLink 6 GHz, Differential Positioner Mounted Tip Probe Module	D500PT*
WaveLink ProLink Probe Body	WL600
2.5 GHz, 0.7 pF Active Probe ( $\pm 10$ ), Small Form Factor	HFP2500
Optical-to-Electrical Converter, 500–870 nm	OE525
ProLink BMA Connector	
Optical-to-Electrical Converter, 950–1630 nm	OE555
ProLink BMA Connector	
7.5 GHz, Low Capacitance Passive Probe ( $\pm 10$ , 1 k $\Omega$ ; $\pm 20$ , 500 $\Omega$ )	PP066
Probe Deskew and Calibration Test Fixture	TF-DSQ
Cascade Microtech EZ-Probe Positioner	EZ PROBE

\*For a complete probe, order a WL600 Probe Body with the Probe Tip Module.

**Customer Service**

LeCroy oscilloscopes and probes are designed, built, and tested to ensure high reliability. In the unlikely event you experience difficulties, our digital oscilloscopes are fully warranted for three years and our probes are warranted for one year.

This warranty includes:

- No charge for return shipping
- Long-term 7-year support
- Upgrade to latest software at no charge



## COMPLIANCE & CONFIGURATION ORDERING INFORMATION

### SATA Gen1/Gen2 Solution Analysis Package

Description	Product Code
SATA Gen1/Gen2 Solution Analysis Package (includes ASDA-J and TF-SATA)	SDA-SATA

#### Recommended System Configuration

SATA Solution System SDA6000A XXL, SDA 9000, or SDA 11000	
4 Ch; 6 GHz Serial Data Analyzer; 10 GS/s; 50 Mpts/Ch; 20 GS/s, 100 Mpts/Ch for 2 or 1 Ch	SDA 6000A XXL
4 Ch; 6 GHz Serial Data Analyzer; 20 GS/s; 20 Mpts/Ch	SDA 6020
4 Ch; 9 GHz Serial Data Analyzer; 9 GHz 40 GS/s 40 Mpts/Ch on 2 Ch; 6 GHz, 20 GS/s 20 Mpts/Ch on 4 Ch (Gen 1 Only)	SDA 9000
4 Ch; 11/6 GHz Serial Data Analyzer; 11 GHz, 40 GS/s 40 Mpts on 2 Ch; 6 GHz, 20 GS/s 20 Mpts on 4 Ch (Gen1 or Gen2)	SDA 11000
SATA Gen1/Gen2 Solution Analysis Software Package	SDA-SATA
SATA SA <i>Tracer/Trainer</i> 3G 1 Port Analyzer/Exerciser System (includes UPAS10K, SA <i>Tracer</i> 3G 1 Port Module, SA <i>Trainer</i> 3G Traffic Generator Module)	SA005APA-X

### USB 2.0 Compliance Test Software Package

Description	Product Code
USB 2.0 Compliance Test Software Package	USB2

#### Recommended Accessories

2.5 GHz, 0.7 pF Active Probe ( $\pm 10$ ), Small Form Factor	HFP2500
WaveLink 4 GHz, 5 V Differential Probe Small Tip Module	D350ST*
WaveLink ProBus Probe Body	WL300
30 A; 50 MHz Current Probe – AC/DC; 30 A <sub>rms</sub> ; 50 A <sub>Peak</sub> Pulse	CP030
1 M $\Omega$ Adapter includes PP005A Passive Probe	AP-1M
USB 2.0 Testing Compliance Test Fixture	TF-USB

\*For a complete probe, order a WL300 Probe Body with the Probe Tip Module.

### Ethernet Test Software Package

Description	Product Code
Ethernet Test Software Package	ENET

#### Recommended Accessories

WaveLink 4 GHz, 5 V Differential Probe Small Tip Module	D350ST*
Extra Square Pin Lead for the D350ST	D350ST-SP
2.5 GHz, 0.7 pF Active Probe ( $\pm 10$ ), Small Form Factor	HFP2500
Ethernet Compliance Test Fixture for 10Base-T	TF-10BT
Ethernet Fixture for 100Base-T/1000Base-T (Includes a Set of 2 Test Fixtures Signals on Twisted Pair Cables (UTP))	TF-ENET

\*For a complete probe, order a WL300 Probe Body with the Probe Tip Module.

### SAS Compliance Test

The SDA-SAS configurations include all software required to run the SAS software on the SDA Series. For customers who own an SDA 6000A XXL/6020A, SDA-SAS is compatible up to 3 Gb/s. For SAS 6G applications, the SDA 11000 or higher bandwidth real-time oscilloscope is required.

Description	Product Code
SAS I/II Solution Analysis Software Package for SDA Family of Serial Data Analyzers	SDA-SAS

#### Recommended Solution for SAS 3G/6G

SAS Solution System Configuration	
4 Ch, 11/6 GHz Serial Data Analyzer; 11 GHz, 40 GS/s 16 Mpts in 2 Ch mode; 6 GHz, 20 GS/s 8 Mpts in 4 Ch mode	SDA 11000
Differential Probe System (for SDA 18000, SDA 11000, SDA 9000 only)	D11000PS
SAS I/II Solution Analysis Software Package for SDA Family of Serial Data Analyzers	SDA-SAS
SAS SA <i>Tracer/Trainer</i> 3G 1 Port Analyzer/Exerciser System (Includes CATC platform, SA <i>Tracer</i> 3G 1 Port Module, SA <i>Trainer</i> 3G Traffic Generator Module)	SS001APA-X

### SDA-PCIE-G2 Compliance Test

Description	Product Code
PCI Express Development and Compliance Software for Gen1 and Gen2	SDA-PCIE-G2

#### PCI Express Gen2 Design Solution

4 Ch; 11/6 GHz Serial Data Analyzer; 11 GHz, 40 GS/s 40 Mpts on 2 Ch; 6 GHz, 20 GS/s 20 Mpts on 4 Ch	SDA 11000
PCI Express Development and Compliance Software for Gen1 and Gen2	SDA-PCIE-G2
Differential Probe System (for SDA 18000, SDA 11000, SDA 9000 only)	D11000PS

#### PCI Express Gen1 Design Solution

6 GHz, 20 GS/s 20 Mpts, 4 Ch Serial Data Analyzer	SDA 6020
PCI Express Development and Compliance Software for Gen1 and Gen2	SDA-PCIE-G2
WaveLink 7 GHz, Differential Probe Small Tip Module	D600ST*
PE <i>Tracer</i> Gen2 Summit x8 Protocol Analyzer	PE002AAA-X
PCI Express PE <i>Trainer</i> ML Host Emulation Platform	800-0082-00

\*For a complete probe, order a WL600 Probe Body with the Probe Tip Module.

For more options on protocol analyzers and exercisers, please see the products from LeCroy's Protocol Solutions Group on pages 75-99.

## COMPLIANCE & CONFIGURATION ORDERING INFORMATION

### FB-DIMM Compliance Test

SDA-FBDIMM Package Configurations include all the software, required to run AMB point-to-point on the SDA 9000\* and higher bandwidth real-time oscilloscopes.

Description	Product Code
FB-DIMM Solution Analysis Software Package	SDA-FBDIMM
<b>System Configuration for FB-DIMM 3.2-4.8 Gb/s</b>	
4 Ch; 11/6 GHz Serial Data Analyzer; 11 GHz, 40 GS/s 40 Mpts on 2 Ch; 6 GHz, 20 GS/s 20 Mpts on 4 Ch	SDA 11000
Differential Probe System	D11000PS
FB-DIMM Solution Analysis Software Package	SDA-FBDIMM

\*SDA 9000 for FB-DIMM data rates up to 4.0 Gb/s, SDA 11000 for data rates up to 4.8 Gb/s.

### 8B/10B Decoding Software

Simultaneously translates up to 4 lanes of 8B/10B encoded Serial Data waveforms into symbol views to allow easier troubleshooting. This allows the user to quickly correlate protocol events with the physical serial data waveform. The decoder operates with 8B/10B encoded data at rates up to 6.25 Gb/s.

Description	Product Code
8B/10B Decoding and Analysis Software	SDA-8B10B*

\*SDA-8B10B is standard with LeCroy Serial Data Analyzers, and optional with the Disk Drive Analyzers, WavePro and WaveMaster oscilloscope series.

### HDMI Compliance Test

SDA-HDMI software package includes all the software required to run HDMI compliance tests on the SDA/ WaveMaster 4 GHz and higher bandwidth real-time oscilloscope family.

Description	Product Code
HDMI Compliance Test Software Package	SDA-HDMI
<b>Recommended System Configuration for HDMI Compliance Tests</b>	
<b>HDMI Solution System Configuration</b>	
4 Ch; 4 GHz Serial Data Analyzer; 10 GS/s; 20 Mpts/Ch; 20 GS/s, 100 Mpts/Ch for 2 or 1 Ch	SDA 4000A XXL
WaveLink 4 GHz, 5 V Differential Probe Small Tip Module	D350ST*
Extra Square Pin Lead for the D350ST	D350ST-SP
HDMI Compliance Test Software Package	SDA-HDMI
HDMI Test Fixture Kit contains TPA-P-DI Differential Test Fixture and TPA-P-SE Single Ended Test Fixture	TF-HDMI

\*For a complete probe, order a WL300 Probe Body with the Probe Tip Module.

### SDA-UWB

The SDA-UWB software package for the Serial Data Analyzer and WaveMaster Families provides a concise set of validation/verification and debug tools written in accordance with WiMedia PHY Compliance and Interoperability Test Specification version 1.0.

Description	Product Code
UWB Test Solution Software Package	SDA-UWB

#### Serial Data Analyzer Recommended System Configuration for UWB WiMedia Physical Layer Tests

UWB Solution System Configuration	
4 Ch 11/6 GHz Serial Data Analyzer; 11 GHz, 40 GS/s 16 Mpts in 2 Ch mode; 6 GHz 20 GS/s 8 Mpts in 4 Ch mode	SDA 11000
UWB Test Solution Software Package	SDA-UWB
Bandgroup #1	SDA 6000A XXL/SDA 6020
Bandgroup #1, #2 and #3	SDA 9000
Bandgroup #1 thru #5	SDA 11000 (or SDA 18000)
Wi-Media MB OFDM-UWB Measurement Solution	SDA-UWB

PROTOCOL SOLUTIONS

THE STANDARD FOR PROTOCOL ANALYSIS

A wide range of protocol analysis and verification test products for advanced high-speed communications are available from LeCroy. These market leading instruments are characterized by easy-to-use and intuitive user interfaces for rapid identification of issues; extensive data summaries, metrics, and reports that aid understanding of data traffic; and flexible and extensible platforms for easy upgrades, reconfiguration for new specifications, and investment protection.

Market Leadership

These products are the first to provide key support for many new and evolving communication specifications. They are the standard for many industry segments, providing a common test platform across the industry. They offer the most comprehensive data presentation and analysis available.

Viewing Leads to Understanding

The patented CATC Trace™ display and data report system helps engineers quickly understand and isolate critical issues. Data isn't just displayed, it's organized and identified with information critical to understanding. Integration of trace

summaries, error identification, graphical reports, and test results provide an effective and efficient navigation system.

Rapid Identification of Issues and Errors

Accurate data capture, automated compliance testing, performance metrics and features such as the unique ZeroTime™ search enable users to rapidly identify problems. Advanced triggering and data filtering allow you to quickly isolate and focus on the key issues. Built-in data analysis and the ability to export data to other systems allow for more sophisticated analysis and identification of complex issues.



PCI Express Protocol Analyzer and Exerciser

- For PCI Express IP Cores, semiconductors, add-in-boards, systems, and more
- PE Tracer ML system up to x8 lane widths
- PE Tracer EML and Summit Gen2, up to 16 lanes
- PE Tracer Summit Gen2 supports PCI Express Spec 2.0 (Gen2) traffic at 5 Gb/s per lane.

Wide Range of Products

Multiple products and configurations are offered within each market segment, allowing users to match their requirements and budget with the test capabilities they need. From simple and inexpensive GO/NO GO manufacturing testers to the industry's most advanced integrated protocol analysis, traffic generation, and command analysis tools, LeCroy analyzers cover a wide range of customer needs and applications.

Investment Protection

Modular product design, combined with reprogrammable BusEngine™ technology, result in a highly flexible and adaptive platform. Start with the basic product and add new capabilities or higher speeds as needs change. Upgrade your instrument by swapping modules when new specifications are issued. By providing cost-effective upgrade paths and integrated test equipment designs, LeCroy supports and protects your investment.

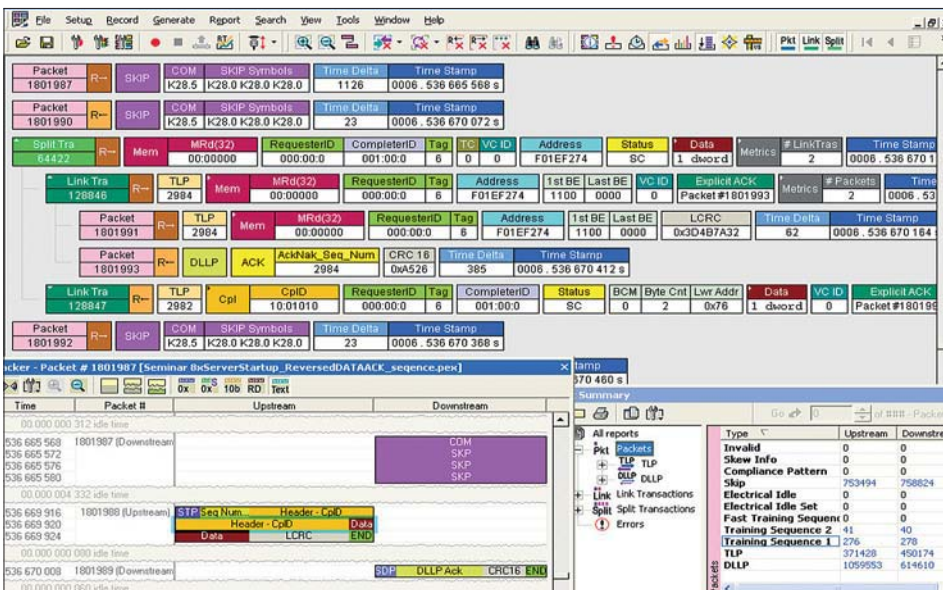



**USB Tracer/Trainer™ Protocol Analyzer and Exerciser**



The USB *Tracer/Trainer* system is LeCroy's total solution for cutting edge USB 2.0 and On-the-Go (OTG) development and analysis. Based upon our CATC 2500H, you have the option of choosing either the

USB *Tracer/Trainer* system or the USB *Tracer* module only. Both modules are fully supported by our industry leading CATC Trace software, which enhances your ability to develop and debug USB devices.

**SAS InFusion™ and SATA InFusion™**



The SAS *InFusion* and SATA *InFusion* error injector and traffic modifier systems are the first of their kind. They enable the injection of errors and modification of traffic in order to verify real-world fault handling. The InFusion system supports a single 3.0G or 1.5G SAS or SATA link and monitors traffic from both directions.

sub-system. In just minutes, an easy-to-use wizard-based interface allows you to create test scenarios. You can change any field, within any frame, as the data moves across the bus. Any primitive or data pattern can be intercepted and changed to a different pattern you specify. This allows for corner case and protocol level error injection for SAS and SATA traffic.

The InFusion traffic modifier is designed to verify recovery characteristics within a

**UWB Tracer™ Protocol Analyzer**



Designed to verify functionality and interoperability between WiMedia devices, LeCroy's UWB *Tracer* provides both wireless radio and MAC-PHY interface (MPI) capture of Wireless USB and WiNET protocol traffic. Small and portable, this flexible platform offers pluggable modules

that allow users to upgrade the system in the field. The ability to purchase additional radio modules gives users the peace of mind that LeCroy's Wireless USB analyzer can be enhanced to support future changes in the UWB PHY specifications.

**Bluetooth® Protocol Analyzer and Exerciser**



All LeCroy Bluetooth analyzers capture traffic non-intrusively. These devices use hardware triggering to capture real-time events, and filtering to preserve memory as well as assist in pinpointing data of interest.

displays all pconet traffic as color-coded packets and offers users advanced functionality for filtering and sorting Bluetooth data, and searching for specific packet types and/or errors.

Recorder data is displayed, using the CATC Trace display. This software graphically

**SAS Tracer/Trainer™**

Quickly and easily transmit valid and invalid 1.5 or 3 Gb/s SAS or SATA traffic, selectively record the exchange and display the results.

**IB Tracer™ 4X Protocol Analyzer**

The IB *Tracer* provides advanced triggering, filtering, searching, and reporting for quick analysis of InfiniBand traffic. It supports the IB 1.1 specification and lane reversal of 4X InfiniBand links.

**FC Tracer™ Protocol Analyzer**

This analyzer provides accurate, reliable, and complete decodes of FC-2 and FC-4 levels. The display shows captured traffic at the Frame, Sequence, and Exchange levels for chronological and logical viewing of the traffic.

## WAVEEXPERT® SERIES

### UNPARALLELED ACCURACY, THROUGHPUT, AND ANALYSIS

In recent years, the development of equivalent-time scopes has enabled measurements of high-speed serial and optical components and subsystems by providing plug-in sampling modules that cover wide bandwidths, albeit at the expense of acquisition speeds.

The WaveExpert Series is LeCroy's newest line of equivalent-time sampling scopes designed to provide a superior Serial Data Analysis (SDA) tool for the growing high-speed digital and optical data markets. This new series is composed of flexible, modular oscilloscopes equipped with four sampling channels that can accommodate any combination of electrical, optical, clock recovery, or PRBS pulse pattern generator modules with the instruments.

The WaveExpert Series combines fast acquisition speed and deep memory with

powerful data analysis packages for jitter, eye, and S-parameter measurements, thus serving as the single most effective tool available today for testing high-speed serial data. The throughput capabilities are powered by a patented timebase, Coherent Interleaved Sampling (CIS), also available with a High Stability Option that reduces trigger jitter further down to 250 ps rms. That, coupled with the only 100 GHz electrical sampling module currently available, form an essential pair for high data rate optical testing at 40 Gb/s and beyond.



### Exceptional Capabilities for Serial Data Testing

- 10 MS/s acquisition rate
- 512 Mpts waveform memory
- < 250 fs rms (typical) timebase jitter
- Built-in pattern lock
- Jitter and S-parameter measurement packages
- Plug-in modules with up to 100 GHz bandwidth
- MATLAB® Connectivity
- Open Windows® XP Pro OS

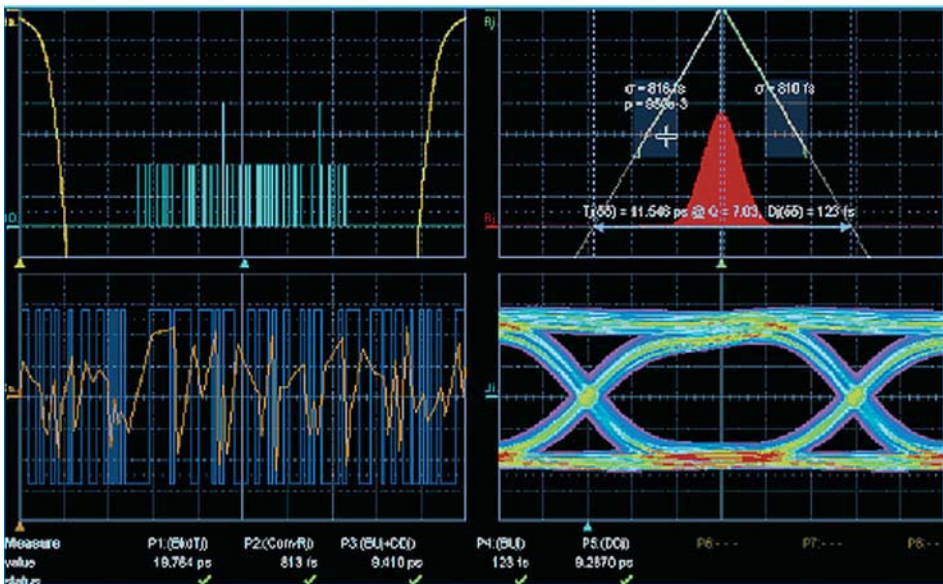

Complete jitter measurements utilize the Coherent Interleaved Sampling timebase. Analysis includes total jitter along with random, deterministic, bounded, and data dependent parts.

### Jitter Analysis

As the speeds of serial data signals move past 10 Gb/s, accurate jitter measurements have become more important than ever before. The innovative Q-Scale jitter analysis software used in WaveExpert oscilloscopes provides the most accurate jitter measurements, regardless of the jitter scenario.

### WaveScan Advanced Search

#### Locate Problems Triggers Won't Find

WaveScan is a powerful tool that provides the ability to locate unusual events in a single capture, or scan for an event in many acquisitions over a long period of time using more than 20 different search/scan modes. WaveScan uses measurement-based scanning modes, like frequency, to show statistical distribution of events. It overlays events for a quick and simple visual comparison.

### Comprehensive Jitter Analysis

- One-button Jitter Measurements
- Accurate Total Jitter analysis at any data rate
- Jitter breakdown into Random and Bounded components, including Data Dependent Jitter (DDJ) and Bounded Uncorrelated Jitter (BUJ) components using Q-scale analysis
- Fast acquisition rate permits analysis of ALL edges in a waveform.
- < 250 fs rms intrinsic timebase jitter

Conventional oscilloscope-based jitter methods rely on the accurate measurement of the jitter spectrum to determine the random and deterministic jitter breakdown. This method can become inaccurate, and overestimate jitter in cases where there is crosstalk or power supply noise.

The Q-Scale method does not rely on the jitter spectrum but, instead, uses the

measured jitter distribution to determine the random and bounded jitter components. When a repeating data pattern is used, the data dependent jitter can be removed from the jitter measurement, resulting in the first instrument that can measure Bounded, Uncorrelated Jitter (BUJ). BUJ is a critical component of jitter in real systems that include crosstalk and other non-periodic but bounded jitter sources.

### Coherent Interleaved Sampling—a breakthrough in acquisition technology

Conventional sampling oscilloscopes acquire measurements by sampling the voltage of a signal, using a synchronous clock supplied by the system under test or through a clock recovery circuit. This method of sampling results in slow sampling rates in the range of 50 to 100 kHz typically. LeCroy's patented Coherent Interleaved Sampling (CIS) timebase enhances performance by increasing the sampling speed by up to 100 times over conventional sampling oscilloscopes.

The technology behind CIS is a timebase that employs a phase-locked loop (PLL) to recover a sampling clock from the supplied or recovered bit clock. The internal sampling clock is set so that its sampling rate is lower than the fundamental period of the signal under test by a precise amount. By setting the period equal to the number of bits in a repeating bit sequence, for example PRBS15 or CJTPAT, a pattern-locked

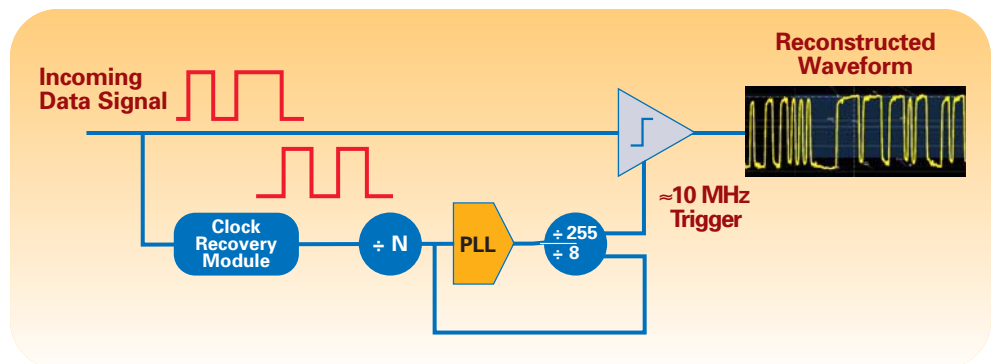

amplitude-vs.-time display is generated with an exact number of samples in each symbol. The CIS timebase has a nominal sampling rate of 10 MS/s, so it is possible for the first time in an equivalent-time sampling scope to capture millions of samples of waveform data—up to 510 million samples.

The unprecedented acquisition capabilities of the CIS timebase enable the capture of millions of waveform samples with ultra-low jitter and high time resolution. Measurements such as jitter, optical signal

measurements, frequency response, and dispersion are all possible using the built-in math and analysis functions. The pattern-lock capabilities of CIS, along with fast acquisition and waveform memory of 510 Million samples, facilitates viewing of up to  $2^{23}$  PRBS patterns to analyze individual bits and consequently apply post processing to the waveform, such as Filtering, Equalization, etc.



## WAVEEXPERT SERIES (CONTINUED)

### Impedance Characterization

Time Domain Reflectometry (TDR) is an essential tool for signal integrity measurements of today's high-speed designs. Impedance discontinuities in PCB connectors, etc., can reduce the bandwidth supported by the channel. These critical measurements can be easily made, either as voltage reflections or as impedance measurements, using the TDR feature on the WaveExpert Series. The available TDR module (ST-20) includes a step generator that produces a fast step (typical rise time of 20 ps) to quantify sub-millimeter discontinuities in PCBs, backplanes, interconnects, etc.

### True Differential Measurements

True differential TDR measurements can be made with equal ease using two ST-20 modules to produce a differential to the Device Under Test (DUT). The WaveExpert Series makes true differential measurements by turning the differential channels ON simultaneously, one generating a positive step pulse and the other generating a negative step pulse of equal amplitude.

### Outstanding TDR/TDT Capabilities

- Single-ended and Differential measurements
- Fast Step (20 ps Rise Time)
- True Impedance profiling
- Sub-millimeter measurement resolution
- Advanced TDR calibrations such as OSL (Open Short Load) to remove effects of cables, fixtures, etc.
- True differential drive to DUT
- Automated Step and Sampler Deskew
- Accurate S-parameter measurements to 20 GHz
- Data Output in Voltage, Impedance, or S-parameter (SnP) format

An automated procedure guides you through the deskew process between the channels. This adjusts both the sampling skew between the modules and the step skew between the generated pulses, for enhanced measurement accuracy.

### 40 Gb/s and Beyond

Telecom and datacom technologies are at 40 Gb/s in deployed systems, and 80 Gb/s and beyond in the lab. Measuring signals at these rates is pushing the limits of test equipment technology. The WaveExpert oscilloscope with its industry-leading 100 GHz bandwidth is up to the challenge. The fast acquisition, deep memory, and ultra-low jitter of the CIS timebase provide an unprecedented level of waveform analysis. Complex measurements such as dispersion penalty, and processing functions such as equalization, are possible for the first time on pattern lengths as long as PRBS23. A complete set of optical and electrical plug-in modules provides coverage of all current and emerging standards.

### Fast Eye Measurements

Eye patterns remain one of the most important measures of signal quality in optical systems. In the past, designers were forced to use small statistical samples for this measurement, but the WaveExpert oscilloscope's fast coherent timebase provides a level of throughput rivaled only by bit error rate test systems. Eye patterns consisting of millions of

### Accurate Signal Integrity Measurements

- 40 Gb/s and higher data rate testing with available 100 GHz sampling module
- Pattern locking feature of CIS enables viewing of PRBS23 waveforms.
- Fast Eye measurements with mask testing for common telecom standards
- Channel Equalization using the available filtering functions
- Built-in Optical measurements such as Extinction Ratio, OMA, etc.

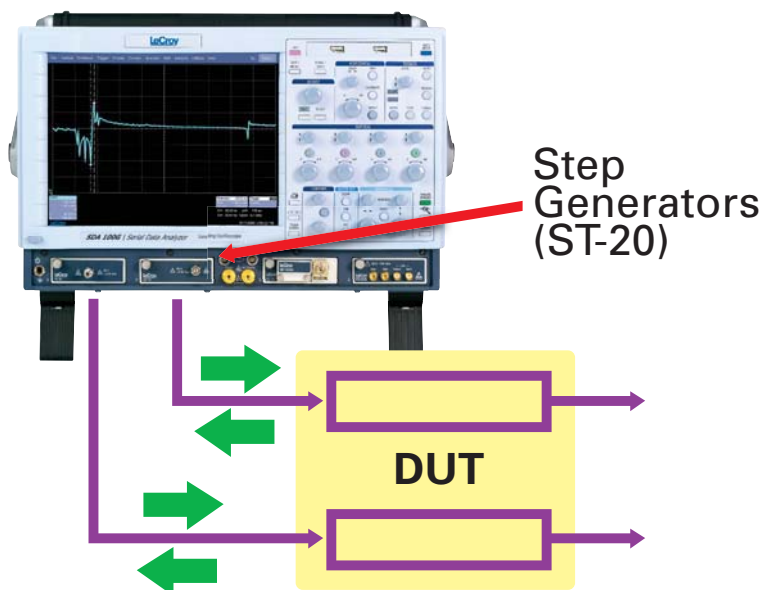

Differential TDR measure setup.

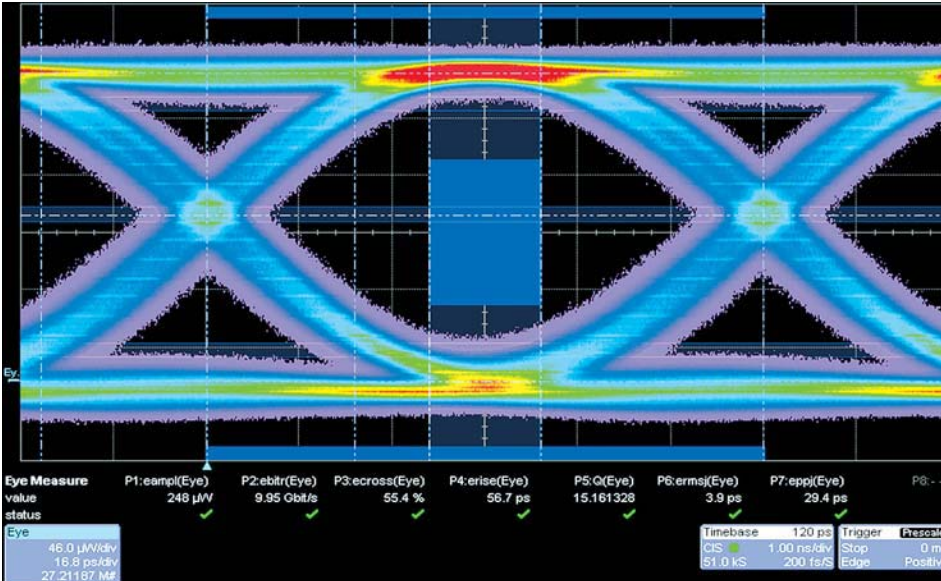

samples can be measured in seconds, thus providing the highest level of accuracy and repeatability for a complete range of eye-based measurements such as extinction ratio, modulation amplitude, eye height, and eye width. With its fast acquisition, the WaveExpert oscilloscope performs the most accurate eye jitter measurements, without the timebase drift problems present in standard equivalent-time scopes.

Fast eye pattern measurements acquire millions of samples in seconds compared to minutes or hours on standard sampling scopes. WaveExpert comes standard with a complete set of compliance masks and measurements.



## SDA 100G

### Standard Features

- 10 MS/s Acquisition Rate
- Deep Memory (4 MS/Ch)
- Pattern Locking at any Data Rate, Powered by CIS Architecture
- Jitter Analysis Software Package
- Eye Diagram Measurements w/Mask testing
- All features of NRO 9000 and WE 9000
- Single-ended and Differential TDR

### SDA 100G Optional Features

- S-parameter measurements
- High Stability Timebase (< 280 fs rms jitter)
- Up to 510 MS Memory



## NRO 9000

### Standard Features

- 10 MS/s Acquisition Rate
- Deep Memory (4 MS/Ch)
- Low Jitter (600 fs rms)
- Pattern Locking at any Data Rate, Powered by CIS architecture
- Single-ended and Differential TDR
- Basic Eye Measurements
- All features of WE 9000

### NRO 9000 Optional Features

- S-parameter measurements
- Jitter Analysis Software Package
- Eye Diagram Measurements w/ Mask Testing
- Up to 510 MS Memory



## WE 9000

### Standard Features

- 1 MS/s Acquisition Rate
- 16 kS/Ch Memory
- Single-ended and Differential TDR
- Basic Eye Measurements

### WE 9000 Optional Features

- S-parameter measurements
- 100 kS/Ch Memory
- Gated Trigger

WAVEEXPERT SPECIFICATIONS

Timebase

Parameter	Sequential	CIS	High Stability w/ CIS
Supporting Models	WE 9000	NRO 9000, SDA 100G	Option NRO 9000, SDA 100G
Sample Rate	1 MS/s	10 MS/s	10 MS/s
Frequency Range	DC to 5 GHz, using Trigger input 5 to 14 GHz, using Clk/Prescale input up to 38 GHz, using SDA-TPS accessory		62.5 to 125 MHz, using Trigger input 125 MHz to 14 GHz, using Clk/Prescale input up to 38 GHz, using SDA-TPS accessory
Pattern Lock	N/A		YES, up to PRBS 23
Minimum Time Per Division	1 ps	1 ps	1 ps
Time Resolution	100 fs	100 fs	100 fs
Timebase Range	1 ps/div to 1 ms/div		1 ps/div to 500 ns/div (4M memory)
Timebase Delay Time Range	25 ns–10 ms		±1 pattern
Time Interval Accuracy	±1 ps ±0.1% of reading		Determined by trigger signal
Long Term Stability	±1 ppm	±1 ppm	±1 ppm
Maximum Record Length	16k samples 100k		4M samples 64M, 128M 255M, 510M
Jitter	< 1.8 ps	600 fs rms (typical)	< 250 fs rms (typical)

Trigger Input

Connector Type	2.92 mm
Impedance	50 Ω nominal
Input Amplitude	±1 V
Max. Input Voltage	±2.5 V
Coupling	DC only
Trigger Sensitivity	-10 dBm at 100 MHz, -5 dBm at 5 GHz
Trigger Gating	Disable: 2.0–3.5 V Enable: 0–0.8 V
Trigger Gating Delay	Disable: 24 ns+ trigger period + time window setting Enable: 32 ns

Clk/Prescale Input

Connector Type	2.92 mm
Impedance	50 Ω nominal
Input Amplitude	0.0 dBm ±6 dBm
Max. Input Voltage	±2.5 V
Coupling	AC coupled
Trigger Sensitivity	-5 dBm to 14 GHz

Electrical Sampling Modules

Parameter	ST-20 (20 GHz)
Connector Type	2.92 mm
Rise Time	18 ps
Bandwidth	20 GHz
Input Voltage Range	2 V <sub>p-p</sub>
DC Vertical Voltage Accuracy	<1% (800 mV <sub>p-p</sub> signal)
Aberrations	First 40 ps: ±10%, 40 ps–200 ps: ±5%, 200 ps–10 ns ±2%
RMS Noise	700 μV max. (500 μV typical)
Offset Range	±1 V

Parameter	SE-30 (30 GHz)
Connector Type	2.92 mm
Rise Time	12 ps
Bandwidth	30 GHz
Input Voltage Range	2 V <sub>p-p</sub>
DC Vertical Voltage Accuracy	< 1% (800 mV <sub>p-p</sub> signal)
Aberrations	First 40 ps: ±10%, 40 ps–200 ps: ±5%, 200 ps–10 ns ±2%
RMS Noise	1 mV (max.)
Offset Range	±1 V

Parameter	SE-50 (50 GHz)
Connector Type	2.4 mm
Rise Time	8 ps
Bandwidth	50 GHz
Input Voltage Range	2 V <sub>p-p</sub>
DC Vertical Voltage Accuracy	< 1% (800 mV <sub>p-p</sub> signal)
Aberrations	First 40 ps: ±10%, 40 ps–200 ps: ±5%, 200 ps–10 ns ±2%
RMS Noise	2 mV (max.), 1 mV (typical)
Offset Range	±1 V

Parameter	SE-70 (70 GHz)
Connector Type	1.85 mm
Rise Time	5 ps
Bandwidth	70 GHz
Input Voltage Range	2 V <sub>p-p</sub>
DC Vertical Voltage Accuracy	< 1% (800 mV <sub>p-p</sub> signal)
Aberrations	First 40 ps: ±10%, 40 ps–200 ps: ±5%, 200 ps–10 ns ±2%
RMS Noise	3 mV (max.)
Offset Range	±1 V

Parameter	SE-100 (100 GHz)
Connector Type	1 mm
Rise Time	4 ps
Bandwidth	100 GHz
Input Voltage Range	2 V <sub>p-p</sub>
DC Vertical Voltage Accuracy	< 1% (800 mV <sub>p-p</sub> signal)
Aberrations	First 40 ps: ±10%, 40 ps–200 ps: ±5%, 200 ps–10 ns ±2%
RMS Noise	3 mV (max.)
Offset Range	±1 V

TDR Step Generator (ST-20)

Parameter	Nominal
Step Rise Time	20 ps
TDR Step Voltage	250 mV
Resistance	50 Ω
TDR Pulse Rate	1 MHz
Offset Range	±1 V
Step Flatness	First 40 ps: ±10%, 40 ps–200 ps: ±5%, 200 ps–10 ns ±2%
Pulse Width	300 ns ±15 ns



## WAVEEXPERT SPECIFICATIONS

### Optical Sampling Modules

Parameter	SO-10 (10 GHz)
Optical Bandwidth	10 GHz
Connector Diameter	62.5 $\mu$ m/50 FC
FWHM (50%)	40 ps (max.) 35 ps (typical)
Wavelength Range	750 to 1650 nm
Responsivity	450 V/W (typical) 425 V/W (min.) @ 1310 nm, 425 V/W (typical) 400 V/W (min.) @ 1565 nm, 225 V/W (typical) 200 V/W (min.) @ 850 nm
Maximum Peak Optical Input	5 mW
Maximum Average Optical Input	
Noise Equivalent Power (Unfiltered)	3 $\mu$ W (max.) 2 $\mu$ W (typical) @ 10 GHz optical bandwidth into 150 MHz IF bandwidth
Optical Power Monitor	-30 dBm to 10 dBm, $\pm$ 5%
Optical Return Loss	-22 dB (SM), -14 dB (MM)
Sensitivity (Unfiltered)	-15 dBm 10.7 Gb/s 1550 SM, -14 dBm 12.5 Gb/s 1550 SM

Parameter	SO-25 (28 GHz)
Optical Bandwidth	28 GHz
Connector diameter	9 $\mu$ m
FWHM (50%)	15 ps
Wavelength Range	1280 to 1620 nm
Responsivity	17 V/W (typical) 15 V/W (min.) @ 1564 nm, 11 V/W (typical) 9 V/W (min.) @ 1310 nm
Maximum Peak Optical Input	50 mW (+17 dBm)
Maximum Average Optical Input	20 mW (+13 dBm)
Noise Equivalent Power (Unfiltered)	47 $\mu$ W (-13.2 dBm) @ 28 GHz bandwidth with 150 MHz IF bandwidth
Optical Power Monitor	-30 dBm to +10 dBm $\pm$ 5%
Optical Return Loss	> 25 dB @ 1550 nm
Sensitivity (Unfiltered)	-2.5 dBm

Parameter	SO-50 (50 GHz)
Optical Bandwidth	50 GHz
Connector diameter	9 $\mu$ m
FWHM (50%)	8.5 ps (typical), 8.8 ps (max.)
Wavelength Range	1280 to 1620 nm
Responsivity	17 V/W (typical) 15 V/W (min.) @ 1564 nm, 11 V/W (typical) 9 V/W (min.) @ 1310 nm
Maximum Peak Optical Input	50 mW (+17 dBm)
Maximum Average Optical Input	20 mW (+13 dBm)
Noise Equivalent Power (Unfiltered)	83 $\mu$ W (-11 dBm) @ 50 GHz bandwidth with 150 MHz IF bandwidth
Optical Power Monitor	-30 dBm to +10 dBm $\pm$ 5%
Optical Return Loss	> 25 dB @ 1550 nm
Sensitivity (Unfiltered)	-0 dBm

### Clock Recovery Modules

#### Electrical Clock Recovery (CDR-E135)

Parameter	Nominal
Frequency Range	All standard data rates from 622 Mb/s–8 Gb/s, up to 13.5 Gb/s with option 001
Sensitivity (peak to peak voltage)	100 mV up to 7 Gb/s, 200 mV from 7 Gb/s–13.5 Gb/s
Maximum Input Voltage	2 V <sub>p-p</sub>
Clock Output Voltage	500 mV <sub>p-p</sub> minimum
Data Output Jitter	.005 UI rms @ 10 Gb/s (500 fs rms typical)
Input Return Loss	15 dB from 622 MHz –10 GHz, 10 dB from 10 GHz–25 GHz
Output Clock Rise/Fall Time	30 ps (20%–80%)
PLL Loop Bandwidth	6 MHz

#### Optical Clock Recovery Module (CDR-O125)

(includes one Multi-mode splitter and one Single-mode splitter for both serial data and optical applications)

Parameter	Nominal
Frequency Range	12.5 MHz–2.7 GHz, 9.9 GHz–12.5 GHz
Wavelength Range	750 nm–1650 nm
Clock and Clock/8 Output Voltage	300 mV <sub>p-p</sub> (typical)
Data Output Jitter	.01 UI rms (12.5 MHz–12.5 GHz)
Optical Sensitivity for Clock Recovery (Not including loss from external optical splitter)	-19 dBm, typical @ 1564 nm -17 dBm, minimum @ 1564 nm -19 dBm, typical @ 1310 nm -17 dBm, minimum @ 1310 nm -17 dBm, typical @ 850 nm -14 dBm, minimum @ 850 nm

### Pulse Generator Module

#### PRBS Pulse Pattern Generator (PPG-E135)

Parameter	Nominal
Frequency Range	2.45 GHz–2.875 GHz 4.9 GHz–5.75 GHz 9.8 GHz–11.5 GHz
Data Patterns	2N-1, N=7, 10, 15, 23, 31
Mark Space Density	0.5, 0.250, 0.125 0.875 or 0.750 possible with Data Invert
Data Output Voltage	500 mV <sub>p-p</sub> , 1000 mV differential
Data Output Jitter	< 1 ps rms
Data Output Rise/Fall Time	30 ps (20–80%)
Clock Output Power	0 dBm $\pm$ 3 dBm
External Clock Input Frequency	50 MHz–12.5 GHz
External Clock Input Power	> 0 dBm
Frequency Accuracy	$\pm$ 3 ppm
Front Panel Connectors	Data+, Data- CLK Input, CLK Output
	2.92 mm (3.5 mm compatible) SMA

### Power Requirement

100-200 Vrms ( $\pm$ 10%) at 50/60 Hz; 115 Vrms ( $\pm$ 10%) at 400 Hz, Automatic AC Voltage Selection Installation Category: 300V CAT II; Max Power Consumption: 400 VA (400 W)

### Environmental

Temperature (Operating)	+5 $^{\circ}$ C to +40 $^{\circ}$ C including CD-ROM drive
Temperature (Non-Operating)	-20 $^{\circ}$ C to +60 $^{\circ}$ C
Humidity (Operating)	5% to 80% relative humidity (non-condensing) up to +30 $^{\circ}$ C. Upper limit derates to 25% relative humidity (non-condensing) at +40 $^{\circ}$ C
Altitude (Operating)	Up to 10,000 ft. (3048 m) at or below +25 $^{\circ}$ C
Altitude (Non-Operating)	Up to 40,000 ft. (12,192 m)
Random Vibration (Operating)	0.31 grms 5 Hz to 500 Hz, 15 minutes in each of three orthogonal axes
Random Vibration (Non-Operating)	2.4 grms 5 Hz to 500 Hz, 15 minutes in each of three orthogonal axes
Functional Shock	20 g <sub>peak</sub> , half sine, 11 ms pulse, 3 shocks (positive and negative) in each of three orthogonal axes, 18 shocks total

### Physical Dimensions

Dimensions (HWD) (height excludes feet)	264 mm x 397 mm x 491 mm; 10.4" x 15.6" x 19.3"
Weight	40 lbs; 18 kg
Shipping Weight	48 lbs; 24 kg

### Certifications

CE Compliant, UL and cUL listed; Conforms to EN 61326; EN 61010-1; UL 61010-1; and CSA C22.2 No. 61010-1

WAVEEXPERT ORDERING INFORMATION

**Product Description**

**Product Code**

**WaveExpert WE 9000**

Standard 4-slot Mainframe	WE 9000
100k/Channel Memory	WE9K-L
Gated Trigger	WE9K-GT

**WaveExpert NRO 9000**

NRO 4-slot Mainframe (includes CIS timebase)	NRO 9000
Serial Data Package (Jitter and Hi-Throughput Eye-Pattern Analysis)	NRO-SDA
64M (1 Ch), 32M (2 Ch), 16M (4 Ch) Waveform Memory	NRO-L
128M (1 Ch), 64M (2 Ch), 32M (4 Ch) Waveform Memory	NRO-VL
255M (1 Ch), 128M (2 Ch), 64M (4 Ch) Waveform Memory	NRO-XL
510M (1 Ch), 255M (2 Ch), 128M (4 Ch) Waveform Memory	NRO-XXL
Gated Trigger	NRO-GT

**WaveExpert SDA 100G**

SDA 4-slot Mainframe (includes CIS timebase, Serial Data Analysis Package)	SDA 100G
High Stability CIS Timebase < 250 fs Jitter	SDA100G-HCIS
64M (1 Ch), 32M (2 Ch), 16 M (4 Ch) Waveform Memory	SDA100G-L
128M (1 Ch), 64M (2 Ch), 32M (4 Ch) Waveform Memory	SDA100G-VL
255 M (1 Ch), 128M (2 Ch), 64M (4 Ch) Waveform Memory	SDA100G-XL
510M (1 Ch), 255M (2 Ch), 128M (4 Ch) Waveform Memory	SDA100G-XXL
Gated Trigger	SDA100G-GT

**Software Options**

Digital Filter Software Package	WE9K-DFP2
Advanced Customization Software Package	WE9K-XDEV
Advanced Math Software Package	Included in standard configuration
Processing Web Editor Software Package for Functions and Parameters	WE9K-XWEB
S-parameter Software includes S11, S22, S12, S21 and OSLT Calibration	WE-SPAR

**Electrical Sampling Modules**

100 GHz Electrical Sampling Module	SE-100
70 GHz Electrical Sampling Module	SE-70
50 GHz Electrical Sampling Module	SE-50
30 GHz Electrical Sampling Module	SE-30
20 GHz Electrical Sampling Module with TDR	ST-20

**Optical Sampling Modules**

50 GHz Optical Sampling Module	SO-50
28 GHz Optical Sampling Module	SO-25
High Sensitivity 10 GHz Optical Sampling Module with Plug-in Reference Receivers	SO-10

**Optical Reference Receiver Kit**

Optical Reference Receiver Kit–Serial Bus	REFKIT-SBUS
Kit includes:	
1.063 Gb/s Reference Receiver Filter for SO-10	REF-01063
1.250 Gb/s Reference Receiver Filter for SO-10	REF-01250
2.125 Gb/s Reference Receiver Filter for SO-10	REF-02125
2.5 Gb/s Reference Receiver Filter for SO-10	REF-02500
3.125 Gb/s Reference Receiver Filter for SO-10	REF-03125
3.32 Gb/s Reference Receiver Filter for SO-10	REF-03320
4.25 Gb/s Reference Receiver Filter for SO-10	REF-04250

**Product Description**

**Product Code**

**Optical Reference Receiver Kit (cont.)**

Optical Reference Receiver Kit–Serial Bus	REFKIT-SBUS
Kit includes:*	
9.950 Gb/s Reference Receiver Filter for SO-10	REF-09950
10.31 Gb/s Reference Receiver Filter for SO-10	REF-10310
10.52 Gb/s Reference Receiver Filter for SO-10	REF-10520

**Optical Reference Receiver Kit–SONET/SDH** REFKIT-TELCO  
Kit includes:\*

155 Mb/s Reference Receiver Filter for SO-10	REF-00155
622 Mb/s Reference Receiver Filter for SO-10	REF-00622
2.488 Gb/s Reference Receiver Filter for SO-10	REF-02488
3.188 Gb/s Reference Receiver Filter for SO-10	REF-03188
9.950 Gb/s Reference Receiver Filter for SO-10	REF-09950
10.66 Gb/s Reference Receiver Filter for SO-10	REF-10660
10.71 Gb/s Reference Receiver Filter for SO-10	REF-10710
11.1 Gb/s Reference Receiver Filter for SO-10	REF-11100

\*Also available separately.

**Clock Recovery Modules**

Optical Clock Recovery Module (12.5 MHz to 2.7 GHz, 9.95 GHz to 12.5 GHz)	CDR-O125
Electrical Clock Recovery Module (622 MHz to 8 GHz)	CDR-E135
Extend Frequency Range of CDR-E135 to 13.5 Gb/s	CDR-E135-001*

\*Part must be ordered with the CDR-E135.

**Pulse Pattern Generator**

12.5 Gb/s Pulse Pattern Generator with Clock Output	PPG-E135
---	----------

**Coaxial Adapters**

2.92 mm F-F Adapter	ADAPT-292
2.92 mm – SMA F-F Adapter	ADAPT-292-SMA
1.85 mm F-F Adapter	ADAPT-185
1 mm F-F Adapter	ADAPT-100
1 mm – 1.85 mm F-F Adapter	ADAPT-100-185

**Hardware Options and Accessories**

38 GHz Trigger Prescaler (for clock frequencies to 38 GHz)	SDA-TPS
1.5 Meter Module Extender Cable	ME-15
Blank Cover Module	WE-CM
IEEE-488 GPIB Remote Control Interface	GPIB-1
Dual Monitor Display	DMD-1
Keyboard, USB	KYBD-1
Oscilloscope Cart with Extra Shelf and Drawer	OC1024
Oscilloscope Cart	OC1021
Rackmount Adapter with 25" (64 cm) Slides	RMA-25
Rackmount Adapter with 30" (76 cm) Slides	RMA-30
Removable Hard Drive Package	WE9K-RHD
Additional Removable Hard Drive (includes USB, CD-ROM and Spare Hard Drive)	WE9K-RHD-02
4 in.-lb. Torque Wrench	TW-4
8 in.-lb. Torque Wrench	TW-8

**Customer Service**

LeCroy oscilloscopes are designed, built, and tested to ensure high reliability. In the unlikely event you experience difficulties, the WaveExpert Series oscilloscopes and modules are warranted for a period of one year, and our probes are warranted for one year.

This warranty includes:

- No charge for return shipping
- Long-term 7-year support
- Upgrade to latest software at no charge

## CATC™ PROTOCOL ANALYZER SYSTEM

The CATC Protocol Analyzer System, also known as the CATC Platform, is the foundation upon which LeCroy's test and verification tools are built. The CATC platform not only supports today's communication protocols but also technologies of the future. With interchangeable plug-ins, field upgradeable firmware, and the ability to link multiple analyzers together for higher bandwidth applications, the CATC platform can evolve, as your protocol analysis needs change.

The CATC platform, with a protocol analyzer and/or exerciser module, is a complete solution for testing and verifying serial-based communications. It offers modularity with interchangeable plug-ins for different protocols, and a real-time recording engine for capturing the traffic that interests you most. It's tightly coupled with the CATC Trace™ software that interprets and explains protocol behavior.

LeCroy offers four versions of the CATC platform—the CATC 2500H chassis for lower speed communications protocols, the CATC 10K chassis for high-speed communication links, the advanced CATC 100K chassis for even higher performance, and the new CATC Summit for the ultimate performance in today's analyzer tools. The CATC Summit platform is currently offered only in configurations supporting PCI Express® and not as a separate product.

### SPECIFICATIONS: CATC 100K PLATFORM

Recording Memory Size	4 GB for trace capture, timing, and control information
Host Requirements	Windows 2000, or greater; Intel Pentium II processor or greater; USB port
Power Requirements	90–254 VAC, 47–63 Hz (universal input), 200 W maximum
Connectors	AC power connection, External trigger connection (TRIG IN/OUT, BNC) USB type "B" host computer connection, Breakout Board Data Output Connection (RS232)

### INDICATORS

PWR	Lights when power is on
STATUS	Lights during power up of platform; Blinks if self-test fails
Triggered	Lights when triggering an event
Slot 1 Status	Lights when analyzer in slot 1 is recording
Slot 2 Status	Lights when analyzer in slot 2 is recording

### SWITCHES

Power	On/Off
Manual Trigger	Forces a trigger event when pressed

### PHYSICAL DIMENSIONS

Dimensions	11.5" x 5.75" x 16.25" (29.2 x 14.6 x 41.3 cm)
Net Weight	9.5 lbs (4.3 kg.)

### ENVIRONMENTAL

Temperature: Operating	0 °C to 55 °C (32 °F to 131 °F)
Temperature: Non-Operating	-20 °C to 80 °C (-4 °F to 176 °F)
Humidity: Operating	10% to 90% RH (non-condensing)



CATC 100K

The CATC 100K platform chassis is shown here in the *PETrainer* EML version for PCI Express applications.



## CATC™ PROTOCOL ANALYZER SYSTEM

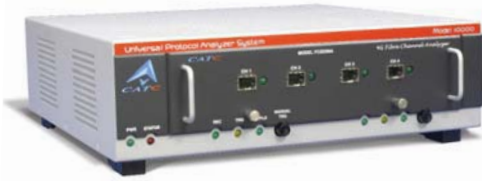

### CATC 10K

The CATC 10K platform chassis is shown here in the *SAS Tracer* version for Serial-Attached SCSI applications.

#### SPECIFICATIONS: CATC 10K PLATFORM

Recording Memory Size	2 GB for trace capture, timing, and control information
Host Requirements	Windows 2000, or greater; Intel Pentium II processor or greater; USB port
Power Requirements	90–254 VAC, 47–63 Hz (universal input) 150 W maximum
Connectors	AC power connection, External trigger connection (TRIG IN/OUT, BNC) USB type “B” host computer connection, Breakout Board Data Output Connection (RS232)

#### INDICATORS

PWR	Lights when power is on
STATUS	Lights during power up of platform; Blinks if self-test fails

#### SWITCHES

Power	On/Off
Manual Trigger	Forces a trigger event when pressed

#### PHYSICAL DIMENSIONS

Dimensions	12.2" x 12.2" x 3.5" (311 mm x 311 mm x 89 mm)
Net Weight	3.4 kg (7.5 lbs.)

#### ENVIRONMENTAL

Temperature: Operating	0 °C to 55 °C (32 °F to 131 °F)
Temperature: Non-Operating	-20 °C to 80 °C (-4 °F to 176 °F)
Humidity: Operating	10% to 90% RH (non-condensing)

#### SPECIFICATIONS: CATC 2500H PLATFORM

Recording Memory Size	512 MB for trace capture, timing, and control information
Host Requirements	Windows 2000, or greater; Intel Pentium II processor or greater; USB port
Power Requirements	90–254 VAC, 47–63 Hz (universal input) 125 W maximum
Connectors	AC power connection, External trigger connection (TRIG IN/OUT, BNC) USB type “B” host computer connection, Breakout Board Data Output Connection (RS232)

#### INDICATORS

PWR	Lights when power is on
STATUS	Lights during initialization; Blinks if self-test fails

#### SWITCHES

Power	On/Off
Manual Trigger	Forces a trigger event when pressed

#### PHYSICAL DIMENSIONS

Dimensions	12.2" x 12.2" x 3.5" (311 mm x 311 mm x 89 mm)
Net Weight	3.4 kg (7.5 lbs.)



### CATC 2500H

The CATC 2500H platform chassis is shown here in the *USB Tracer/Trainer* version for Universal Serial Bus applications.

## CATC™ PROTOCOL ANALYZER SYSTEM

### SPECIFICATIONS: CATC 2500H PLATFORM (CONTINUED)

#### ENVIRONMENTAL

Temperature: Operating	0 °C to 55 °C (32 °F to 131 °F)
Temperature: Non-Operating	-20 °C to 80 °C (-4 °F to 176 °F)
Humidity: Operating	10% to 90% RH (non-condensing)

#### ALL PLATFORMS WARRANTY AND SERVICE

3-year warranty. Optional service programs include extended warranty, maintenance, upgrades, trade-ins, and rental services.

#### ORDERING INFORMATION

#### PRODUCT CODE

CATC 100K Platform	PT003UXA-X
CATC 10K Platform	PT002UXA-X
CATC 2500H Platform	PT001UXB-X
CATC Platform Breakout Board	800-0031-00
Small Carrying Case (For use with CATC 2500H and 10K Platforms)	AC001XXA-X
Large Carrying Case (For use with CATC 100K Platform)	AC002XXA-X
Cable USB2 Std A Rcpt-Mini A Plug 10	180-0027-00
Cable USB2 Mini A Rcp-Std A Plug	180-0028-00

## PCI EXPRESS® PROTOCOL SOLUTIONS

The **PCI Express protocol analyzers and exercisers** offer you the advanced analysis tools necessary to speed the development and testing of PCI Express IP cores, semiconductors, bridges, switches, boards, and systems.

The LeCroy PCI Express Product Line is built around a choice of three different systems: the **PETracer™ Summit Gen2** platform; the **CATC 100K** platform (EML systems); and the **CATC 10K** platform (ML systems). The ML systems support x1, x2, x4, and x8; and the higher-performance EML and Summit systems support x1, x2, x4, x8, and x16. Summit systems support Gen2 PCI Express at data rates up to 5 Gb/s.

The Summit systems support protocol analysis only. The ML and EML platforms offer the choice of a protocol analyzer or an exerciser (traffic generator). For a customer requiring both functions, ML and EML systems are offered as analyzer/exerciser bundles (in two separate chassis).

In addition to the analyzer or exerciser system, customers will need the appropriate cable assembly, adapter, and/or interposer—all of which may be included in the system part number. **PETrainer™** ML/EML exerciser systems also include either a host emulation card or a device emulation card (depending on whether the customer wants to emulate a PCI host or PCI device). A customer who wants both host and device emulation can purchase the second capability as an option.

The PCI Express Protocol Analyzers and Exercisers offer you the advanced analysis tools necessary to speed the development and testing of PCI Express IP cores, semiconductors, bridges, switches, boards, and systems.

The CATC Trace software offers you many features to ease time to market for PCI Express Solutions:

- The system provides accurate, reliable, and complete decodes of Transaction Layer Packets (TLPs), Data Link Layer Packets (DLLPs), and all PCI Express ordered sets.
- The CATC Trace display shows captured traffic at the packet, link transaction and split transaction levels for chronological and logical viewing of the trace.
- Link Tracker displays all DWORDS on all channels synchronized to a common clock.
- Powerful triggering conditions allow for you to trigger on Error, Link, TLP, DLLP, or any user-defined data pattern or multiple events in the traffic.
- Full-featured filtering capabilities isolate areas of interest, and filters out unwanted traffic in order to maximize memory buffer utilization.
- Performance metrics facilitate calculation and display of timing, bus utilization, and data throughput.
- Intelligent traffic reports and summaries illustrate the occurrence of errors, TLP, DLLP, and link conditions. Any of the traffic report data selected for detailed study can be hyperlinked back into the CATC Trace software.

When used with a LeCroy protocol exerciser, the software assists you with analyzing and exercising PCI Express components:

- Script level traffic generation provides programmability to test PCI Express components with precision and control.
- Trace files convert into generation scripts to recreate failure scenarios by replaying recorded traffic.
- Programmable transaction layer defines arbitrary sequence of transactions, payload generation, and conditional repeat of transactions.
- Programmable data link layer gives you the ability to modify flow control, ACK/NAK, and retry behaviors.

### PETracer™ Gen2 Summit Protocol Analyzer

The **PETracer Gen2 Summit Protocol Analyzer** is the first analyzer to support PCI Express Spec 2.0 ("Gen2"), with data rates up to 5 Gb/s on each lane. The **PETracer** Summit supports lane widths of x1, x2, x4, x8, and x16; provides a full 8 GB of trace memory; supports a Mid-Bus probe interface to directly tap into an embedded PCI Express bus; and introduces novel features such as lane swizzling to provide flexibility in PCB design, bifurcated lane support to recombine lanes of a single bus that have been split over multiple connectors, auto link sensing, and raw mode recording.



PETRACER SUMMIT



PETRAINER EML



PETRACER ML



## PCI EXPRESS® PROTOCOL SOLUTIONS

### PETracer™ EML Protocol Analyzer

The **PETracer EML Analyzer** allows for full bi-directional support of x16, x8, x4, x2, and x1 PCI Express links and employs a high-impedance, non-intrusive probing technology allowing fully unaltered data pass-through. The **PETracer EML Analyzer** is built upon the CATC 100K Platform, which supports PCI Express Gen1 at the full speed of 2.5 GHz per lane. Two probe options are available for advanced analysis: the x16 Slot Interposer Probe for capturing signals between a motherboard and an add-in card, and the Mid-Bus Probe for capturing inter-chip signaling on a PCI Express Board.

### PETrainer™ EML Exerciser

The **PETrainer EML Exerciser** is a PCI Express system that is capable of generating and responding to all types of PCI Express transactions. Built on the CATC 100K platform, the exerciser is available in either x16 or x8 configurations, though you may configure each to a narrower lane width as desired. Two probe options are available for testing both the host and the device sides of a PCI Express link: the x16 Device Emulation Interposer for connecting to a PCI Express motherboard and the Host Emulation platform for testing PCI Express add-on cards.

### PETracer™ ML Protocol Analyzer

With the CATC 10K Platform as its chassis, a single **PETracer ML Analyzer** supports bi-directional x4, x2, and x1 links, as well as unidirectional x8 PCI Express link data capture and analysis. You can have full bi-directional decode and capture of a x8 link by combining two analyzer systems. Two probe options are available for advanced analysis: the Slot Interposer Probe (available in x8, x4, or x1) for capturing signals between a motherboard and an add-in card, and the Mid-Bus Probe for capturing inter-chip signaling on a PCI Express Board.

### PETrainer™ ML Exerciser

The **PETrainer ML Exerciser**, using the CATC 10K platform, is a multi-lane PCI Express system that supports both x4 and x1 links. It will assist you with early validation of designs along with error injection and stress testing in preparation for compliance testing. Two probe options are available for testing both the host and the device sides of a PCI Express link: the Device Emulation interposer (available in both x4 and x1) for connecting to a PCI Express motherboard and the Host Emulation platform for testing PCI Express add-on cards.

#### SPECIFICATIONS: PETRACER/TRAINER EML PLUG IN MODULE

##### PHYSICAL DIMENSIONS

Dimensions (each)	9.16" x 6" x 1.25" (233 mm x 152 mm x 32 mm)
Net Weight (each)	1.58 kg (3.5 lbs.)

#### SPECIFICATIONS: PETRACER ML PLUG IN MODULE

##### PHYSICAL DIMENSIONS

Dimensions (each)	9.3" x 6.7" x 1.3" (236 mm x 170 mm x 32 mm)
Net Weight (each)	0.77 kg (1.7 lbs.)

CATC PLATFORM SPECIFICATIONS (SEE PAGES 75-77)

# PCI EXPRESS PROTOCOL SOLUTIONS

## PE Tracer™ Protocol Analyzer Systems Interconnect Diagram

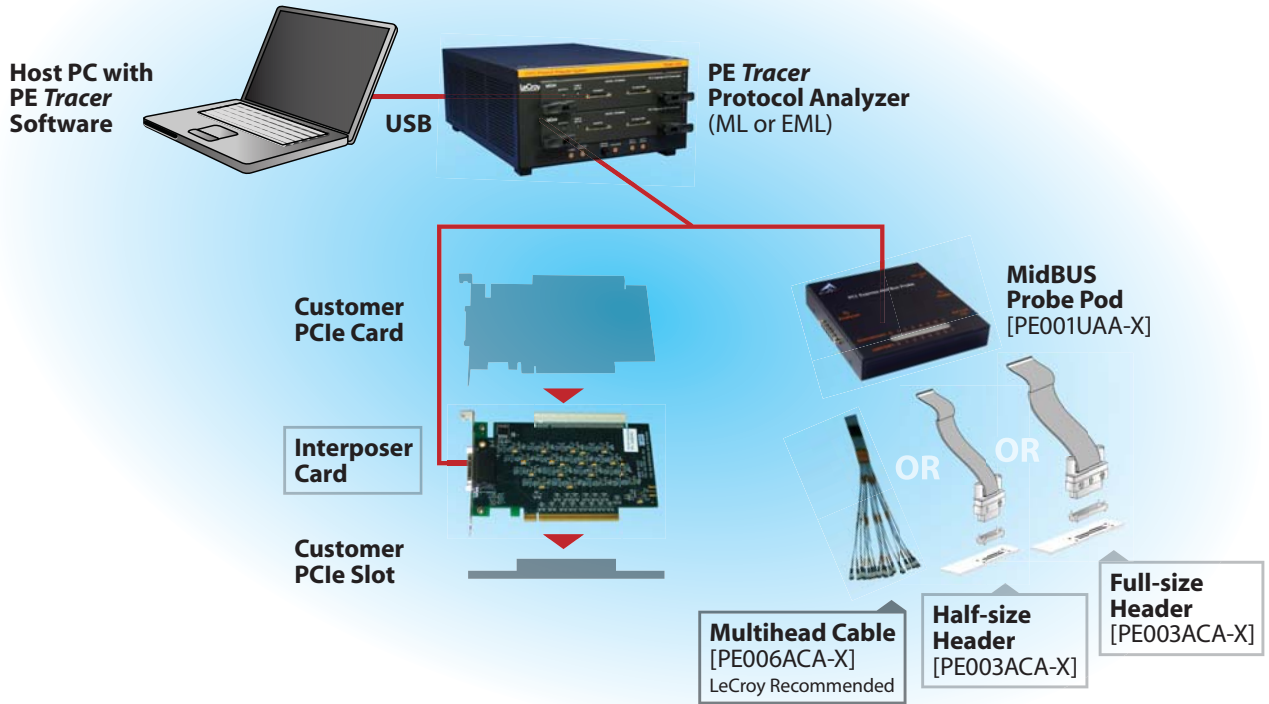

## PE Trainer™ Exerciser Systems Interconnect Diagram

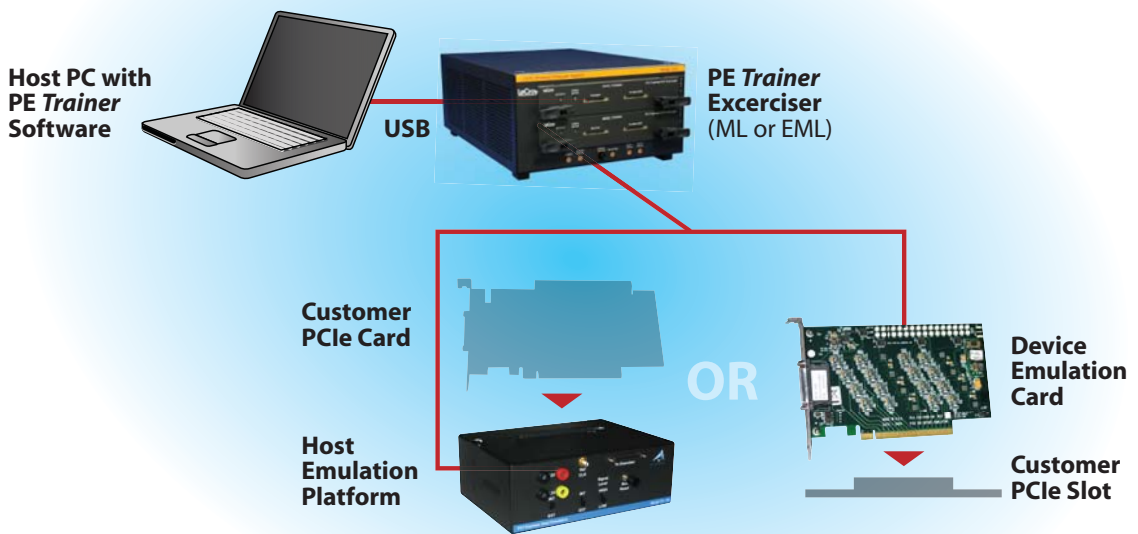

**PCI EXPRESS PROTOCOL SOLUTIONS**

**ORDERING INFORMATION: PETRACER/TRAINER EML**

**PRODUCT CODE**

**PCI EXPRESS ANALYZERS**

PCI Express PETracer ML x1 Analyzer System/Pro Software Package	PE001AAF-X
PCI Express PETracer ML x1 Analyzer System/Expert Software Package	PE001AAE-X
PCI Express PETracer ML x4 Analyzer System/Pro Software Package	PE002AAD-X
PCI Express PETracer ML x4 Analyzer System/Expert Software Package	PE002AAC-X
PCI Express PETracer ML x8 Analyzer System	PE003AAC-X
PCI Express PETracer EML x8 Analyzer System	PE009AAB-X
PCI Express PETracer EML x16 Analyzer System	PE008AAB-X
PCI Express PETracer Gen2 Summit x16 Analyzer System	PE015AAA-X
PCI Express PETracer Gen2 Summit x8 Analyzer System	PE022AAA-X
PCI Express PETracer Gen1 Summit x16 Analyzer System	PE024AAA-X
PCI Express PETracer Gen1 Summit x8 Analyzer System	PE025AAA-X

**PCI EXPRESS EXERCISERS**

PCI Express PETrainer ML x1 Exerciser System	PE001AGA-X
PCI Express PETrainer ML x1 Exerciser System	PE001AGB-X
PCI Express PETrainer ML x4 Exerciser System	PE002AGB-X
PCI Express PETrainer ML x4 Exerciser System	PE002AGC-X
PCI Express PETrainer EML x8 Exerciser System	PE009AGB-X
PCI Express PETrainer EML x8 Exerciser System	PE009AGC-X
PCI Express PETrainer EML x16 Exerciser System	PE008AGB-X
PCI Express PETrainer EML x16 Exerciser System	PE008AGC-X
PCI Express LinkUp™ LTSSM Trainer	PE024AGA-X

**PCI EXPRESS BUNDLES OF ANALYZERS AND EXERCISERS**

PCI Express PETracer/Trainer ML x1 Expert Analyzer/Exerciser Bundle	PE001APA-X
PCI Express PETracer/Trainer ML x1 Expert Analyzer/Exerciser Bundle	PE001APB-X
PCI Express PETracer/Trainer ML x4 Expert Analyzer/Exerciser Bundle	PE002APB-X
PCI Express PETracer/Trainer ML x4 Expert Analyzer/Exerciser Bundle	PE002APC-X
PCI Express PETracer/Trainer EML x8 Analyzer/Exerciser Bundle	PE009APB-X
PCI Express PETracer/Trainer EML x8 Analyzer/Exerciser Bundle	PE009APC-X
PCI Express PETracer/Trainer EML x16 Exerciser/Analyzer Module Bundle	PE008APB-X
PCI Express PETracer/Trainer EML x16 Exerciser/Analyzer Module Bundle	PE008APC-X

**PCI EXPRESS MODULES FOR ANALYZERS AND EXERCISERS**

PCI Express PETracer ML x1 Analyzer Module Kit	PE001MAC-X
PCI Express PETracer ML x4 Analyzer Module Kit	PE002MAB-X
PCI Express PETrainer ML x4 Exerciser Module Kit	PE002MGA-X
PCI Express PETracer EML x8 Analyzer Module Kit	PE009MAA-X
PCI Express PETrainer EML x8 Exerciser Module Kit	PE009MGA-X
PCI Express PETracer EML x16 Analyzer Module Kit	PE008MAA-X
PCI Express PETrainer EML x16 Exerciser Module Kit	PE008MGA-X



PCI EXPRESS PROTOCOL SOLUTIONS

ORDERING INFORMATION: PETRACER/TRAINER EML	PRODUCT CODE
<b>PCI EXPRESS OPTIONS</b>	
Expert Analysis Option	PE014SUA-X
PCI Express PETracer ML Analyzer x1 to x4 Option	PE010SUA-X
PCI Express PETrainer ML Exerciser x1 to x4 Option	PE011SUA-X
PCI Express PETracer ML Analyzer x4 Upgrade to x8	PE007AAB-X
PCI Express PETracer EML x8 to EML x16	PE008SUA-X
PCI Express PETrainer EML x8 to EML x16	PE012SUA-X
PCI Express PETracer/PETrainer EML x8 Exerciser/Analyzer Module Bundle to	PE013SUA-X
PCI Express PETracer/PETrainer EML x16 Analyzer/Exerciser Bundle	
PCI Express PETracer Gen1 Summit x16 Analyzer System to Gen2 Summit x16 Analyzer System	PE025SUA-X
PCI Express PETracer Gen1 Summit x8 Analyzer System to Gen2 Summit x8 Analyzer System	PE026SUA-X
<b>PETRACER ACCESSORIES</b>	
PCI Express PETracer ML x8 Slot Interposer	800-0110-00
PCI Express PETracer EML x16 Slot Interposer	PE001UIA-X
PCI Express ExpressCard Interposer	PE006UIA-X
<b>PETRAINER ACCESSORIES</b>	
PCI Express PETrainer ML x1 Device Emulation Card	800-0084-00
PCI Express PETrainer ML x4 Device Emulation Card	800-0083-00
PCI Express PETrainer ML Host Emulation Platform	800-0082-00
PCI Express PETrainer EML x16 Device Emulation Card	PE001UEA-X
PCI Express PETrainer EML Host Emulation Platform	PE002UEA-X
<b>MID-BUS PROBE AND ACCESSORIES</b>	
PCI Express PETracer Mid-Bus Probe	PE001ACA-X
PCI Express PETracer Mid-Bus Probe	PE004ACA-X
PCI Express PETracer Mid-Bus Probe	PE005ACA-X
Multi-Lead Mid-Bus Cable	PE006ACA-X
PCI Express Mid-Bus Probe Test Interposer	PE005UIA-X
Dual Gen2 Mid-Bus Interposer for Gen2	PE027UIA-X
PCI Express PETracer Gen2 Summit x16 Slot Interposer	PE028UIA-X
PETracer Mid-Bus Probe Pod	PE001UAA-X
PETracer x8 Gen2 Mid-Bus Probe Pod (Pod, Cables, and Probe Cable)	PE015ACA-X
PETracer Mid-Bus Probe Header Cable (Full Size)	PE002ACA-X
PETracer Mid-Bus Probe Header Cable (Half Size)	PE003ACA-X
PETracer EML x1-x8 Mid-Bus Probe Cable	PE003ADA-X
Retention Module Half Size	232-0004-00
Retention Module Full Size	232-0003-00
<b>CABLE ASSEMBLIES AND ADAPTERS</b>	
PCI Express PETracer ML x4 Cable Assembly	180-0068-00
PCI Express PETracer ML x8 Cable Assembly	180-0066-00
PCI Express PETracer/PETrainer EML Cable Assembly	PE003UCA-X
PCI Express x16 to x8 Card Edge Adapter	PE002UIA-X
PCI Express x16 to x4 Card Edge Adapter	PE003UIA-X
PCI Express x16 to x1 Card Edge Adapter	PE004UIA-X
Extended EML Cables	180-0094-00

**PCI EXPRESS PROTOCOL SOLUTIONS**

**ORDERING INFORMATION: PETRACER/TRAINER EML**

**PRODUCT CODE**

**PCI EXPRESS PRODUCTS MAINTENANCE**

PCI Express PETracer ML x1/x4 EXP Analyzer	PE002AAD-M
PCI Express PETracer ML x1 Analyzer System Maintenance	PE001AAE-M
PCI Express PETracer ML x1/x4 Pro Analyzer	PE001AAF-M
PCI Express PETracer ML x1 Analyzer Module Maintenance	PE001MAD-M
PCI Express PETrainer ML x1 Exerciser System (Host) Maintenance	PE001AGA-M
PCI Express PETrainer ML x1 Exerciser System (Device) Maintenance	PE001AGB-M
PCI Express PETracer/Trainer ML x1 Analyzer/Exerciser Bundle (Host) Maintenance	PE001APA-M
PCI Express PETracer/Trainer ML x1 Analyzer/Exerciser Bundle (Device) Maintenance	PE001APB-M
PCI Express PETracer ML Analyzer x1 to x4 Option Maintenance	PE002SAA-M
PCI Express PETrainer ML Exerciser x1 to x4 Option Maintenance	PE002SGA-M
PCI Express PETrainer ML x4 Exerciser System (Host) Maintenance	PE002AGB-M
PCI Express PETrainer ML x4 Exerciser System (Device) Maintenance	PE002AGC-M
PCI Express PETracer/Trainer ML x4 System (Host) Maintenance	PE002APB-M
PCI Express PETracer/Trainer ML x4 System (Device) Maintenance	PE002APC-M
PCI Express PETracer ML x4 Analyzer Module Maintenance	PE002MAB-M
PCI Express PETrainer ML x4 Exerciser System Maintenance	PE002AGA-M
PCI Express PETrainer ML x4 Exerciser Module Maintenance	PE002MGA-M
PCI Express PETracer ML Analyzer x4 to x8 Option Maintenance	PE007AAB-M
PCI Express PETracer ML x8 Analyzer System Maintenance	PE003AAC-M
PCI Express PETracer EML x8 Analyzer System Maintenance	PE009AAB-M
PCI Express PETracer EML x8 Analyzer Module Maintenance	PE009MAA-M
PCI Express PETrainer EML x8 Exerciser System (Host) Maintenance	PE009AGB-M
PCI Express PETrainer EML x8 Exerciser System (Device) Maintenance	PE009AGC-M
PCI Express PETracer EML x8 Exerciser Module Maintenance	PE009MGA-M
PCI Express PETracer/Trainer EML x8 System (Host) Maintenance	PE009APB-M
PCI Express PETracer/Trainer EML x8 System (Device) Maintenance	PE009APC-M
PCI Express PETracer EML x16 Analyzer System Maintenance	PE008AAB-M
PCI Express PETracer EML x16 Analyzer Module Maintenance	PE008MAA-M
PCI Express PETrainer EML x16 Exerciser System (Host) Maintenance	PE008AGB-M
PCI Express PETrainer EML x16 Exerciser System (Device) Maintenance	PE008AGC-M
PCI Express PETracer EML x16 Exerciser Module Kit	PE008MGA-M
PCI Express PETracer EML Analyzer x8 to x16 Option Maintenance	PE008SUA-M
PCI Express PETrainer EML Exerciser x8 to x16 Option Maintenance	PE008SGA-M
PCI Express PETracer/Trainer EML x16 System (Host) Maintenance	PE008APB-M
PCI Express PETracer/Trainer EML x16 System (Device) Maintenance	PE008APC-M
PCI Express PETracer/Trainer EML Bundle x8 to x16 Maintenance	PE008SPA-M
PCI Express PETracer Gen2 Summit x16 Analyzer Maintenance	PE015AAA-M
PCI Express PETracer Gen2 Summit x8 Analyzer Maintenance	PE022AAA-M
PCI Express PETracer Gen1 Summit x16 Analyzer Maintenance	PE024AAA-M
PCI Express PETracer Gen1 Summit x8 Analyzer Maintenance	PE025AAA-M

## SAS/SATA PROTOCOL SOLUTIONS



SASTRACER

LeCroy's *SAS Tracer/Trainer™* is an integrated protocol analyzer and exerciser platform that provides fast, efficient and accurate debug, test and verification of Serial-Attached SCSI semiconductors, devices, and systems. It allows designers and validation engineers to quickly and easily transmit valid and invalid 1.5 or 3 Gbps SAS or SATA traffic, selectively record the exchange and display the results using the acclaimed CATC Trace display.

Three key products offered for Serial Attached SCSI (SAS) applications are the *SAS Tracer™* Protocol Analyzer, the *SAS Trainer™* Analyzer Exerciser (or Traffic Generator), and the *SAS Tracker™* Command Analyzer. All three products are based on the same chassis (the CATC 10K platform), all support SAS speeds up to 3 Gbps, and all support SATA in addition to SAS. The common hardware design allows the user to obtain very economical product bundles when multiple instruments are needed.

### SERIAL ATTACHED SCSI

#### *SAS Tracer™* Protocol Analyzer

Utilizing the CATC 10K platform, the *SAS Tracer* Analyzer combines non-intrusive, multi-port recording with an intuitive display of bus traffic. Multiple *SAS Tracer* systems can be cascaded together to provide a time-synchronized display of traffic across 8 or 16 links. The *SAS Tracer* is available with single lane "SATA" style connectors or four lane InfiniBand style external connector. The *SAS Tracer* can also be used for SATA protocol analysis.

- Advanced software provides accurate, reliable, and complete decodes of transport layer, STP, SATA, and SMP transactions.
- The CATC Trace display shows captured traffic at the Command and FIS levels for chronological and logical viewing of the trace.
- Link Tracker displays all DWORDS on all channels synchronized to a common clock.
- FrameTracker™ shows a summary view of transport level events in a time-synchronized table format.
- Powerful triggering conditions allow for you to trigger on out of band signals, commands, primitives, errors, or FISs from specific ports. It can monitor up to 256 levels of condition trigger logic with up to three events per level.
- Full-featured filtering capabilities isolate areas of interest, and filters out unwanted traffic in order to maximize memory buffer utilization.
- Performance metrics automatically calculate and display average throughput, latency, and response time for a specific portion of the traffic.
- Intelligent traffic reports and summaries provide high-level abstraction of events, operations, and errors for each link under analysis. The traffic summary statistics are hyperlinked back into the detailed Trace display to provide superior drill down.

#### *SAS Tracer/Trainer™* Protocol Analyzer and Exerciser

When configured with the *SAS Trainer™* exerciser option, the system can transmit a single link of 3 or 1.5 Gbps traffic while providing 1 or 2 recording channels. LeCroy's Compliance Test Suite for SAS accompanies the *SAS Trainer™* and provides a substantial test suite for validating Link & Transport layer compliance for initiators, targets and expander devices. The *SAS Tracer/Trainer* system also supports SATA protocol analysis and traffic generation system as well.

- When used with a LeCroy protocol exerciser, the software assists you with analyzing and exercising SAS/SATA components:
- Script level traffic generation provides programmability to test SAS and SATA systems with precision and control.
- Trace files convert into generation scripts to recreate failure scenarios by replaying recorded traffic.
- Advanced handshaking allows for the system to automatically reply to out of band and speed negotiation signals; it can open connections, acknowledge frames, and react to any inbound SAS or SATA frame or pattern.



## SAS/SATA PROTOCOL SOLUTIONS

### SASTracker™ Command Analyzer Option

The SASTracker Command Analyzer is an important option for the SASTracer Protocol Analyzer, specifically designed to debug command timeout problems. The SASTracker System is available in a single link configuration for SAS developers involved in debugging command timeout issues for Serial-Attached SCSI systems using native command queuing (NCQ). The SASTracker tracks and times every command issued, and triggers if any command remains pending for more than the user-defined timeout. A large recording memory provides a chronological log file of all transactions. The SASTracker capability can also be added to an existing SASTracer Protocol Analyzer to enable a flexible, multipurpose test capability. Users can easily switch between the SASTracker Command Analyzer and the SASTracer Protocol Analyzer to enable a flexible multi-purpose test platform.



SAS TRACER/TRAINER

### SERIAL ATA

#### SATracer™ 3G Protocol Analyzer

The SATracer 3G Analyzer, installed in the CATC 10K platform, utilizes production level transceiver silicon designed to be fully compatible with SATA II specification. It triggers and records the critical out-of-band signaling, supports spread spectrum clocked signals, and automatically negotiates 1.5 or 3G link rates. Available with 1, 2, or 4 recording channels, the SATracer 3G Analyzer can also be cascaded to provide a synchronized display of SATA traffic across 8 or 16 links.

#### SATracer™/Trainer™ 3G Protocol Analyzer and Exerciser

LeCroy also offers an exerciser plug in module called the SATrainer which makes this all in one test tool for SATA traffic analysis and generation. Built on the CATC 10K platform, the SATrainer module transmits traffic to emulate host or device side SATA communications.

#### SATA Tracker™ Command Analyzer Option

The SATA Tracker Command Analyzer is an important option for the SATracer Protocol Analyzer, specifically designed to debug command timeout problems. The SATA Tracker System is available in a single link configuration for SATA developers involved in debugging command timeout issues for Serial ATA systems using native command queuing (NCQ). The SATA Tracker tracks and times every command issued, and triggers if any command remains pending for more than the user-defined timeout. A large recording memory provides a chronological log file of all ATA transactions. The SATA Tracker capability can also be added to an existing SATracer Protocol Analyzer to enable a flexible, multipurpose test capability. Users can easily switch between the SATA Tracker Command Analyzer and the SATracer Protocol Analyzer to enable a flexible multi-purpose test platform.

CATC PLATFORM SPECIFICATIONS (SEE PAGES 75-77)

#### SPECIFICATIONS: SAS TRACER/SAS TRACER PLUG IN MODULE

Dimensions	4.5" x 6.7" x 1.3" (113 mm x 170 mm x 33 mm)
Net Weight	.77 kg (1.9 lbs.)

#### SPECIFICATIONS: SAS TRACER/SAS TRACKER/SAS TRACER 3G/SAS TRACKER 3G EXTERNAL CONNECTOR PLUG IN MODULE

Dimensions (each)	9.3" x 6.7" x 1.3" (236 mm x 170 mm x 33 mm)
Net Weight (each)	01.22 kg (2.1 lbs.)

#### SPECIFICATIONS: SAS TRAINER/SAS TRAINER PLUG IN MODULE

Dimensions	4.5" x 6.7" x 1.3" (113 mm x 170 mm x 33 mm)
Net Weight	.77 kg (1.9 lbs.)

SAS/SATA PROTOCOL SOLUTIONS

ORDERING INFORMATION	PRODUCT CODE
<b>SERIAL-ATTACHED SCSI (SAS) PRODUCTS</b>	
SAS <i>Tracer</i> 3G 1 Port Analyzer System	SS001AAA-X
SAS <i>Tracer</i> 3G 1 Port Analyzer Module	SS001MAA-X
SAS <i>Tracer</i> 3G 2 Port Analyzer Option Key	SS001SUA-X
SAS <i>Tracer</i> 1 Port External Connector Analyzer System	SS004AAA-X
SAS <i>Tracer</i> 1 Port External Connector Analyzer Module	SS004MAA-X
SAS <i>Tracer</i> 3G 4 Port External Connector Analyzer Option Key	SS004SUA-X
SAS <i>Tracer</i> 3G 4 Port External Connector Analyzer System	SS006AAA-X
SAS <i>Tracer</i> 3G 4 Port External Connector Analyzer Module	SS006MAA-X
SAS <i>Tracer</i> 3G 2 Port Analyzer System	SS002AAA-X
SAS <i>Tracer</i> 3G 2 Port Analyzer Module	SS002MAA-X
SAS <i>Tracer</i> 3G 2 Port External Connector Analyzer System	SS005AAA-X
SAS <i>Tracer</i> 3G 2 Port External Connector Analyzer Module	SS005MAA-X
SAS <i>Tracer</i> 3G 4 Port Analyzer System	SS003AAA-X
SAS <i>Tracer</i> 3G 4 Port Analyzer Module	SS003MAA-X
SAS <i>Tracer/Trainer</i> 3G 1 Port Analyzer and Exerciser System	SS001APA-X
SAS <i>Tracer/Trainer</i> 3G 2 Port Analyzer and Exerciser System	SS002APA-X
SAS <i>Trainer</i> 3G Exerciser Module	SS001MGA-X
<b>SAS Tracker</b>	
SAS <i>Tracker</i> 3G Command Analyzer Option	SS005SUA-X
SAS Protocol Analyzer and SAS <i>Tracker</i> Option Bundle	SS008AAA-X
<b>Serial Attached SCSI (SAS) Accessories</b>	
SAS 4 Wide External Octopus Cable – 1 m	SS004UCA-X
SAS/SATA Probe Adapter	SS001UCA-X
SAS 4 Wide Internal Octopus Cable – 2 m	SS002UCA-X
SAS 4 Wide Internal Octopus Cable – 1 m	SS003UCA-X
SAS 1M HDD Cable	SS005UCA-X
SAS 1M Backplane (A to B) Cable	SS006UCA-X
SAS IPASS to SATA internal Octopus cables	SS009UCA-X
SAS IPASS to IB EXT Cable – 1 m	SS008UCA-X
SAS/SATA Junction Board Int/Int	210-0126-00
SAS 4X External "IB" cable 1 m	SS007UCA-X
<b>SAS 3G Products Maintenance</b>	
SAS <i>Tracer</i> 3G 1 Port Analyzer System Maintenance	SS001AAA-M
SAS <i>Tracer</i> 3G 2 Port Analyzer System Maintenance	SS002AAA-M
SAS <i>Tracer</i> 3G 1 Port Analyzer Module Maintenance	SS001MAA-M
SAS <i>Tracer</i> 3G 2 Port Analyzer Module Maintenance	SS002MAA-M
SAS <i>Tracer</i> 3G 4 Port Analyzer Module Maintenance	SS003MAA-M
SAS <i>Tracer</i> 3G 4 Port Analyzer System Maintenance	SS003AAA-M
SAS <i>Tracer/Trainer</i> 1 Port Analyzer and Generator System Maintenance	SS001APA-M
SAS <i>Tracer/Trainer</i> 2 Port Analyzer and Generator System Maintenance	SS002APA-M
SAS <i>Tracer</i> 3G 1 Port External Connector Analyzer System Maintenance	SS004AAA-M
SAS <i>Tracer</i> 3G 1 Port External Connector Analyzer Module Maintenance	SS004MAA-M

**SAS/SATA PROTOCOL SOLUTIONS**

**ORDERING INFORMATION**

**PRODUCT CODE**

**SERIAL-ATTACHED SCSI (SAS) PRODUCTS (CONTINUED)**

**SAS 3G Products Maintenance**

SAS <i>Tracer</i> 3G 2 Port External Connector Analyzer System Maintenance	SS005AAA-M
SAS <i>Tracer</i> 3G 2 Port External Connector Analyzer Module Maintenance	SS005MAA-M
SAS <i>Tracer</i> 3G 4 Port External Connector Analyzer System Maintenance	SS006AAA-M
SAS <i>Tracer</i> 3G 4 Port External Connector Analyzer Module Maintenance	SS006MAA-M
SAS <i>Tracer</i> 3G 2 Port Analyzer Key Maintenance	SS001SUA-M
SAS <i>Tracer</i> 3G 4 Port External Connector Analyzer System and SAS <i>Tracker</i> Option Bundle Maintenance	SS008AAA-M

**Expert Analytical Systems™ SAS-Auditor Software**

Auditor Install Kit	FC001STA-X
SAS Auditor Base 2 Port Software Key	SS002STA-X
SAS Auditor Base 4 Port Software Key	SS003STA-X
SAS Auditor STP Module Software Key	SS004STA-X
SAS Auditor SMP and Expander Module Software Key	SS005STA-X
SAS Auditor STP, SMP and Expander Suite Software Key	SS006STA-X
TRIAL SAS Auditor Base, STP, SMP, and Expander Suite Software Key	SS007STA-X

**Expert Analytical Systems SAS-Auditor Software Maintenance**

Maintenance SAS Auditor Base Software 2 Port	SS002STA-M
Maintenance SAS Auditor Base Software > 2 Port	SS003STA-M
Maintenance SAS Auditor STP Add-on Module	SS004STA-M
Maintenance SAS Auditor SMP and Expander Add-on Module	SS005STA-M
Maintenance SAS Auditor STP, SMP, and Expander Suite	SS006STA-M

**SERIAL ATA (SATA) PRODUCTS**

SATA SA <i>Tracer</i> 3G 1 Port Analyzer System	SA005AAA-X
SATA SA <i>Tracer</i> 3G 1 Port Analyzer Module	SA005MAA-X
SATA SA <i>Tracer</i> 3G 4 Port External Connector Analyzer System	SA010AAA-X
SATA SA <i>Tracer</i> 3G 4 Port External Connector Analyzer Module	SA010MAA-X
SATA SA <i>Tracer</i> 3G 2 Port Analyzer System	SA006AAA-X
SATA SA <i>Tracer</i> 3G 2 Port Analyzer Module	SA006MAA-X
SATA SA <i>Tracer</i> 3G 2 Port External Connector Analyzer System	SA009AAA-X
SATA SA <i>Tracer</i> 3G 2 Port External Connector Analyzer Module	SA009MAA-X
SATA SA <i>Tracer</i> 3G 4 Port Analyzer System	SA007AAA-X
SATA SA <i>Tracer</i> 3G 4 Port Analyzer Module	SA007MAA-X
SATA SA <i>Tracer</i> 3G 1 Port External Connector Analyzer System	SA008AAA-X
SATA SA <i>Tracer</i> 3G 1 Port External Connector Analyzer Module	SA008MAA-X
SATA SA <i>Tracer/Trainer</i> 3G 1 Port Analyzer/Exerciser System	SA005APA-X
SATA SA <i>Tracer/Trainer</i> 3G 2 Port Analyzer/Exerciser System	SA006APA-X
SATA SA <i>Trainer</i> 3G 1 Port Exerciser Module	SA005MGA-X
SATA SA <i>Tracer</i> 3G SAS Software Option	SA001SUA-X
SATA SA <i>Tracer</i> 3G 4 Port External Connector Analyzer Option Key	SA003SUA-X



**SAS/SATA PROTOCOL SOLUTIONS**

**ORDERING INFORMATION**

**PRODUCT CODE**

**SERIAL ATA (SATA) PRODUCTS (CONTINUED)**

**SATA Tracker™**

Serial ATA SATA Tracker 3G Command Analyzer Option	SA004SUA-X
Serial ATA SATA Protocol Analyzer and SATA Tracker Option Bundle	SA012AAA-X

**Serial ATA Accessory**

SAS/SATA Probe Adapter	SS001UCA-X
SATA 1M Backplane (A to B) Cable	SA001UCA-X

**Serial ATA 3G Products Maintenance**

SATracer 3G 1 Port Analyzer System Maintenance	SA005AAA-M
SATracer 3G 2 Port Analyzer System Maintenance	SA006AAA-M
SATracer 3G 4 Port Analyzer System Maintenance	SA007AAA-M
SATracer 3G SAS Software License Maintenance	SA001SUA-M
SATracer 3G 1 Port Analyzer Module Maintenance	SA005MAA-M
SATracer 3G 2 Port Analyzer Module Maintenance	SA006MAA-M
SATracer 3G 4 Port Analyzer Module Maintenance	SA007MAA-M
SATracer/Trainer 3G 1 Port Analyzer/Exerciser System Maintenance	SA005APA-M
SATracer/Trainer 3G 2 Port Analyzer/Exerciser System Maintenance	SA006APA-M
SATracer 3G 1 Port External Connector Analyzer System Maintenance	SA008AAA-M
SATracer 3G 1 Port External Connector Analyzer Module Maintenance	SA008MAA-M
SATracer 3G 2 Port External Connector Analyzer System Maintenance	SA009AAA-M
SATracer 3G 2 Port External Connector Analyzer Module Maintenance	SA009MAA-M
SATracer 3G 4 Port External Connector Analyzer System Maintenance	SA010AAA-M
SATracer 3G 4 Port External Connector Analyzer Module Maintenance	SA010MAA-M
SATracer 3G 1 Port Analyzer System and SATA Tracker Option Bundle Maintenance	SA012AAA-M

## SAS/SATA PROTOCOL SOLUTIONS

### SAS InFusion™ and SATA InFusion™

The SAS InFusion and SATA InFusion error injector and traffic modifier systems are the first of their kind. InFusion Systems allow you to inject errors and modify traffic in order to verify real world fault handling.

The InFusion traffic modifier is designed to verify recovery characteristics within a sub-system. In just minutes, an easy-to-use wizard-based interface allows you to create test scenarios. You can change any field, within any frame, as the data moves across the bus. Any primitive or data pattern can be intercepted and changed to a different pattern you specify. This allows for corner case and protocol level error injection for SAS and SATA traffic.

The InFusion system supports a single 3.0G or 1.5G SAS or SATA link and monitors traffic from both directions. Once an InFusion session starts, the system automatically passes the boot up sequence and preserves protocol handshaking between devices. It silently monitors the line while retransmitting a faithful copy of the original data stream. The system will wait for a specific time interval or count a particular event that you designate before it begins modifying frames or injecting errors. It can send either a single error or inject multiple errors.

When modifying the contents of a frame, the InFusion traffic modifier will preserve the outbound frame structure, including recalculating the CRC if needed. The response transmitted from the test will pass through the InFusion system, without modification. This allows true end-to-end system testing. The InFusion System will maintain a log that contains a summary of the exchange.



SAS/SATA INFUSION

### SPECIFICATIONS: SAS INFUSION/SATA INFUSION

Power	100–200 volts. Internal power supply with detachable cord.
Connectors	Two external SATA connectors with external to internal conversion cables
LCD	LCD control panel allows instrument to operate as standalone device
Memory	32 MB internal flash for storage of up to 10 preconfigured test scenarios
Firmware	Field Upgradeable Firmware
Interface to Host	RJ45 10/100 Ethernet connector for communication to host
Supported Configuration	Operate in any topology with any upper level SATA or SAS protocol including SSP, SMP, STP, or native SATA

### PHYSICAL DIMENSIONS

Dimensions	2.25" x 6" x 8" (57.2 mm x 152.4 mm x 203 mm)
Net Weight	1.42 kg (3.2 lbs.)

### WARRANTY AND SERVICE

3-year warranty. Optional service programs include extended warranty, maintenance, upgrades, trade-ins, and rental services.

### ORDERING INFORMATION

	PRODUCT CODE
SAS InFusion 1 Port System	IF001UTA-X
SATA InFusion 1 Port System	IF002UTA-X
SAS InFusion 4 System Bundle	IF003UTA-X
SAS InFusion 1 Port Software Maintenance	IF001UTA-M
SATA InFusion 1 Port Software Maintenance	IF002UTA-M
SAS InFusion 4 Port Software Maintenance	IF003UTA-M

## USB PROTOCOL SOLUTIONS



USB TRACER/TRAINER

### USB Tracer/Trainer™ Protocol Analyzer and Exerciser

The **USB Tracer/Trainer system** is LeCroy's total solution for cutting edge USB 2.0 and On-the-Go (OTG) development and analysis. Based upon our CATC 2500H, you have the option of choosing either the *Tracer/Trainer* system or the *Tracer* module only. Both modules are fully supported by our industry leading CATC Trace software, which will enhance your ability to develop and debug USB devices.

- The system provides accurate, reliable, and complete decodes of bus packets, transactions, split transactions, and transfers.
- Powerful triggering conditions allow for you to trigger on high-speed PIDs and split transaction special tokens, such as ERR, SPLIT, PINK, MYET, DATA1, AND MDATA.
- Full-featured filtering capabilities isolate areas of interest, and filters out unwanted-traffic in order to maximize memory-recording capacity.
- Intelligent traffic reports and summaries give you a quick review of error rates, abnormal bus or timing conditions. Any of the traffic report data selected for detailed study can be hyperlinked back into the CATC Trace.
- Traffic generation providing host and device emulation capabilities.
- Script level traffic generation provides programmability to test USB devices with precision and control.
- Trace files convert into generation scripts to recreate failure scenarios by replaying recorded traffic.
- Intelliframe mode actively searches for a response from the device under test and issues the next appropriate packet.

CATC PLATFORM SPECIFICATIONS (SEE PAGES 75-77)

### SPECIFICATIONS: USB TRACER/TRAINER PLUG IN MODULE

#### PHYSICAL DIMENSIONS

Dimensions	4.5" x 6.7" x 1.3" (113 mm x 170 mm x 32 mm)
Net Weight	0.5 kg (1.0 lb.)



USB MOBILE HS

### USB Mobile™ HS Portable Analyzer

The **USB Mobile HS module** is a highly portable bus and protocol analyzer that connects through your computer's PCMCIA port. This PC card size analyzer offers advanced triggering, multi-level sequencing, sophisticated viewing, and intelligent searching to accurately and efficiently debug, test, and verify USB devices. The *USB Mobile HS* analyzer supports the USB 2.0 and OTG standards, and is fully compatible with the CATC Trace software.



USB ADVISOR

### USB Advisor™ Protocol Analyzer

The **Advisor protocol analyzer** is a cost effective solution for those developing USB 2.0 devices. Like our other analyzers it captures, displays, and analyzes bus traffic. This stand-alone unit works in conjunction with the CATC Trace software to provide a full range of capture and analysis tools. The graphical display software shows bus packets, transactions, split transaction, and transfers. The *USB Advisor* will detect and alert you to potential bus errors and protocol violations. The *Advisor* analyzer supports the USB 2.0 standard.



## USB PROTOCOL SOLUTIONS

### SPECIFICATIONS: USB MOBILE HS

Host Requirements	Windows 2000, Windows XP or greater; Intel Pentium II processor or greater; with a PCMCIA port
Basic Trigger Events	Packet Identifiers, Token Patterns, Frame Patterns, Device Request, Data Pattern, Bus Conditions, Errors, Transactions, Data Length, Splits
Reporting and Statistics	Packet Level, Transaction Level, Transfer Level, Error Reports
Generating Memory Size	64 MB
Power Consumption	Idle: 500 mA (typical), Active: 560 mA (typical)
Connectors	16-bit Type II PC card, 2 Mini-AB USB receptacles

### ENVIRONMENTAL

Temperature: Operating	0 °C to 55 °C (32 °F to 131 °F)
Temperature: Non-Operating	-20 °C to 80 °C (-4 °F to 176 °F)
Humidity: Operating	10% to 90% RH (non-condensing)

### PHYSICAL DIMENSIONS

Dimensions	5.3" x 2.1" x 0.4" (135 mm x 54 mm x 10.5 mm)
Net Weight	51 g (1.8 oz.)

### WARRANTY AND SERVICE

3-year warranty. Optional service programs include extended warranty, upgrades, trade-ins, and rental services.

### SPECIFICATIONS: USB ADVISOR

Host Requirements	Windows 2000, Windows XP or greater; Intel Pentium II processor or greater; with a USB port
Generating Memory Size	128 M DRAM for traffic capture, timing, and other data
Power Consumption	90–254 VAC, 47–63 Hz (universal input), 165 W
Connectors	AC Power Connection, External Clock Input (EXT CLK, BNC), Host Connection (USB, type "B"), Data Connection (Data In/Out, 9-pin DB)

### SWITCHES

Power	On/Off
Manual Trigger	Forces a trigger event
Detach Device	Detaches the device from the host

### INDICATORS (LEDS)

PWR	Lights when analyzer is powered on
REC	Lights when analyzer is actively recording data
TRG	Lights when triggering an event or during power-on testing
UPLD	Lights when uploading data to host

### ENVIRONMENTAL

Temperature: Operating	0 °C to 55 °C (32 °F to 131 °F)
Temperature: Non-Operating	-20 °C to 80 °C (-4 °F to 176 °F)
Humidity: Operating	10% to 90% RH (non-condensing)

### PHYSICAL DIMENSIONS

Dimensions	9.2" x 8.4" x 2.5" (234 mm x 213 mm x 64 mm)
Net Weight	1.3 kg (2.8 lbs.)

### WARRANTY AND SERVICE

3-year warranty. Optional service programs include extended warranty, upgrades, trade-ins, and rental services.

**USB PROTOCOL SOLUTIONS**

**ORDERING INFORMATION**

**PRODUCT CODE**

**USB PRODUCTS**

USB <i>Tracer/Trainer</i> All Speed Analyzer/Generator System	US005APB-X
USB Device Emulation Software Option	US002SUA-X
USB <i>Tracer</i> All Speed Analyzer System	US005AAB-X
USB <i>Tracer</i> All Speed Analyzer CATC Platform Module with OTG	US006MAA-X
USB <i>Trainer</i> Generator CATC Platform Module with Device Emulation	US006MGA-X
USB High-Speed Slow Clock Option	US005SNA-X
USB Advisor All Speed Analyzer	US004UAA-X
USB <i>Mobile</i> HS USB 2.0 All Speed Protocol Analyzer	US008UAA-X
USB Parametric Probe	US006UTA-X

**CATC USB PLATFORM CLASSIC OPTIONS**

USB <i>Tracer/Trainer</i> Classic to All Speed <i>Tracer/Trainer</i> System Option	US500SUA-X
USB <i>Tracer</i> Classic to All Speed <i>Tracer</i> System Option	US501SUA-X

## ULTRA WIDEBAND PROTOCOL SOLUTIONS

### UWB Tracer™ MPI Protocol Analyzer

Designed to verify functionality and interoperability between WiMedia devices, LeCroy's *UWB Tracer* provides both wireless radio and MAC-PHY interface (MPI) capture of Wireless USB protocol traffic. Small and portable, this flexible platform offers pluggable modules that allow users to upgrade the system in the field. The ability to purchase additional radio modules gives users the peace of mind that LeCroy's Wireless USB analyzer can be enhanced to support future changes in the UWB PHY specifications.

The *UWB Tracer* helps ensure interoperability between wireless USB devices with precise capture of all MMC timing elements. LeCroy's leadership in designing innovative and reliable debug tools for the USB and Bluetooth markets make the *UWB Tracer* the ideal choice testing next generation wireless USB devices.

The *UWB Tracer* Analyzer:

- Verifies interoperability between Wireless USB devices
- Supports the latest WiMedia and Certified Wireless USB Specifications
- Captures traffic between multiple Wireless USB endpoints within a WiMedia cluster
- Completely non-intrusive recording within the wireless USB network
- Displays hierarchical views of WiMedia and the USB IF's Certified Wireless USB protocol using the CATC Trace display
- Interchangeable RF modules allow swapping radio front-ends to add support for future changes in the RF specifications
- Isolates specific areas of interest with real time triggering
- Optional wireless USB Security module automatically decodes encrypted payloads
- Excludes non-essential and redundant packets from the trace with pre-capture filtering
- Provides quick glance bus activity using a real time statistics display
- Traffic Summaries automatically report error rates and protocol level metrics which are linked to trace level detail
- Full support for Certified Wireless USB Security including 4-way encryption handshake and USB cable association option.



UWB TRACER

### SPECIFICATIONS

#### PHYSICAL DIMENSIONS

Dimensions	311 mm x 311 mm x 89 mm (9.8" x 6.9" x 2")
Net Weight (each)	2.0 kg (4.4 lbs.)

#### ORDERING INFORMATION

#### PRODUCT CODE

UWB Tracer Standard Analyzer System	UW002AAA-X
UWB Tracer Advanced Analyzer System	UW003AAA-X
UWB Tracer Pro Analyzer System	UW004AAA-X
UWB Tracer Analyzer Module #1	UW002MAA-X
UWB Tracer Analyzer Module #2	UW003MAA-X
USB Association Option	US007MAA-X
UWB Tracer MPI KIT	UW001UAA-X
2GB Memory Option for 5K	UW001SUA-X
Advanced Triggering Option for 5K	UW002SUA-X
WiNET Option	UW003SUA-X
Carrying Case for 5K	AC003XXA-X
UWB Tracer Standard Analyzer System Maintenance	UW002AAA-M
UWB Tracer Advanced Analyzer System Maintenance	UW003AAA-M
UWB Tracer Pro Analyzer System Maintenance	UW004AAA-M



## BLUETOOTH® PROTOCOL SOLUTIONS



**BT TRACER/TRAINER**

### BT Tracer/ Trainer™ Protocol Analyzer and Exerciser

The *BT Tracer/Trainer* system offers you the analysis tools necessary for Bluetooth design and verification. It provides a robust, flexible, and efficient integrated environment for both Bluetooth v1.2 analysis and v1.1 traffic generation. Built on the CATC 2500H platform, the *BT Tracer*™ analyzer can automatically synchronize with the *BT Trainer*™ exerciser to easily capture the results of tests. The *BT Tracer* is also available as an individual module.

The *BT Tracer/Trainer* and the CATC Trace software system offers you features to ease development and testing of Bluetooth:

- Advanced software provides accurate, reliable, and complete decodes of protocols and profiles, such as Baseband, HCI, LMP, SDP, and PPP.
- The CATC Trace display presents a transaction level view of piconet traffic with accurate time stamps and frequency hop information.
- Powerful triggering capabilities allow you to trigger on various conditions, including protocol packet errors, transaction errors, packet type, destination device, and data patterns.
- Full-featured filtering capabilities isolate areas of interest, and filters out unwanted traffic in order to maximize memory buffer utilization.
- Intelligent traffic reports and summaries track error rates, abnormalities, or timing conditions.
- Script level traffic generation provides programmability to test Bluetooth devices with precision and control.
- Trace files convert into generation scripts to recreate failure scenarios by replaying recorded traffic.
- Sophisticated traffic generation can establish or participate in a piconet, and send or receive data within the piconet.

### CATC PLATFORM SPECIFICATIONS (SEE PAGES 75-77)

#### SPECIFICATIONS: BT TRACER/TRAINER PLUG IN MODULES

##### PHYSICAL DIMENSIONS

Dimensions (each)	4.5" x 6.7" x 1.3" (113 mm x 170 mm x 32 mm)
Net Weight (each)	0.5 kg (1.0 lb.)

##### ORDERING INFORMATION

##### PRODUCT CODE

Bluetooth v 1.2 <i>BT Tracer/Trainer</i> Analyzer/Generator System	BT004APA-X
Bluetooth v1.2 <i>BT Tracer</i> Analyzer System	BT004AAA-X
Bluetooth v1.2 <i>BT Tracer/Trainer</i> Analyzer/Generator	BT004MPA-X
CATC Platform Module	
Bluetooth v1.2 <i>BT Tracer</i> Analyzer CATC Platform Module	BT004MAA-X
Bluetooth v1.2 <i>BT Tracer</i> Auxiliary CATC Platform Module	BT005MAA-X
Bluetooth HCI <i>Tracer</i> System	BT002ACA-X
Bluetooth HCI Probe	BT001ACA-X

## BLUETOOTH® PROTOCOL SOLUTIONS

### Merlin™ II Protocol Analyzer

Compatible with Bluetooth v1.2 and EDR-ready, the **Merlin II protocol analyzer** is a small form factor stand-alone unit with a radio interface that allows you to probe and analyze transactions at the lowest level within the Bluetooth architecture. By creating this probing point within the radio level packet view, you can analyze all levels of the protocol stack. Merlin II works with the CATC Trace software interface for detailed capture and analysis of Bluetooth protocol. For very long recording sessions, the analyzer can spool data to an external disk drive extending the memory capacity.



MERLIN II

### SPECIFICATIONS: MERLIN II

Host Requirements	Windows 2000, Windows XP or greater; Intel Pentium II Processor or greater; USB port
Recording Memory Size	Internal 32 MB, disk spooling capabilities
Power Requirements	100 V–240 VAC, 50–60 Hz, PS/2 Power Cable: 5 V, 800 mA DC
Connectors	DC Power, Mini DIN, Host Connection (USB Type “B”), Antenna (Reverse Polarity SMA)
Radio	Bluetooth v1.1 qualified, Class 2, FCC, and CE Compliant

### INDICATORS (LEDS)

STATUS (blue)	Lights when analyzer is on
SYNC (yellow)	Lights when tracking active piconets
REC (green)	Lights when actively recording

### ENVIRONMENTAL

Temperature: Operating	0 °C to 55 °C (32 °F to 131 °F)
Temperature: Non-Operating	-20 °C to 80 °C (-4 °F to 176 °F)
Humidity: Operating	10% to 90% RH (non-condensing)

### PHYSICAL DIMENSIONS

Dimensions	6.1" x 3.0" x 1.1" (155 mm x 76 mm x 27 mm)
Net Weight	246 g (8.8 oz.)

### WARRANTY AND SERVICE

3-year warranty. Other service programs include upgrades, trade-ins, and rental services.

### ORDERING INFORMATION

### PRODUCT CODE

Bluetooth v1.2 BT Merlin II Analyzer	BT006UAA-X
Bluetooth v1.1 BT Merlin Mobile Analyzer	BT005UAA-X



FCTRACER 4G

## FIBRE CHANNEL PROTOCOL SOLUTIONS

### FCTRACER™ PROTOCOL ANALYZER

The Fibre Channel Protocol Analyzers offer you the advanced analysis tools necessary to speed the testing and deployment of Fibre Channel platforms. The *FCTracer Analyzer* uses the CATC Trace software, which has features to ease time for test and debugging of the Fibre Channel devices and systems:

- Advanced software provides you with accurate, reliable, and complete decodes of FC-2 and FC-4 levels.
- The CATC Trace display shows captured traffic at the Frame, Sequence, and Exchange levels for chronological and logical viewing of the traffic.
- Link Tracker displays all DWORDS on all channels synchronized to a common clock.
- FrameTracker shows a summary of all frames in a time-synchronized table.
- Powerful triggering uses two independent sequencers that can track two unrelated series of events in parallel. Each sequencer can separately monitor up to 256 levels of trigger logic with up to six events per level.
- Full-featured filtering capabilities isolate areas of interest and filters out unwanted traffic in order to maximize memory buffer utilization.
- “Cascade” up to four *FCTracer* systems together to capture traffic (from up to 16 links) synchronized to a single clock reference.
- Full-featured filtering capabilities isolate areas of interest and filters out unwanted traffic in order to maximize memory buffer utilization.
- Performance metrics facilitate calculation and display of average throughput, latency, and response time for any portion of the trace.
- Intelligent traffic reports present summaries on error rates, abnormal bus, or timing conditions. Any of the traffic report data selected for detailed study can be hyper-linked back into the Tracer software.
- Verification Script Engine API that allows users to automate analysis tasks by creating scripts that open trace files and extract information from a recording.
- *FCTracer* Analyzers can automatically detect and record 4, 2, and 1 Gb/s data transfer rates.

CATC PLATFORM SPECIFICATIONS (SEE PAGES 75-77)

### SPECIFICATIONS

#### PHYSICAL DIMENSIONS

Dimensions	9.3" x 6.7" x 1.3" (236 mm x 170 mm x 32 mm)
------------	---

Net Weight	.82 kg (1.8 lbs.)
------------	-------------------

Four Fibre Channel small form-factor pluggable (SFP) module connectors

#### ORDERING INFORMATION

#### PRODUCT CODE

#### FCTRACER 4G FIBRE CHANNEL ANALYZER SYSTEMS

Fibre Channel <i>FCTracer</i> 4G 2 Ch Analyzer System	FC006AAA-X
Fibre Channel <i>FCTracer</i> 4G 4 Ch Analyzer System	FC007AAA-X
Fibre Channel <i>FCTracer</i> 4G 2 Ch Analyzer Module	FC003MAA-X
Fibre Channel <i>FCTracer</i> 4G 4 Ch Analyzer Module	FC004MAA-X

#### FIBRE CHANNEL ANALYZER ACCESSORIES

Multimode Fibre 4 Gbps SFP Connector Kit	FC005ACA-X
Copper 1-2 Gbps SFP Connector Kit	FC001ACA-X
Multimode Fibre 2 Gbps (LC) Transceiver Connector Kit	FC002ACA-X
Multimode Fibre 2 Gbps (SC) Transceiver Connector Kit	FC004ACA-X
Singlemode Optical 1-2 Gbps SFP Connector Kit	FC003ACA-X



## 1394 PROTOCOL SOLUTIONS

### FireInspector™ Analyzer

The LeCroy FireInspector IEEE 1394 Protocol Analyzer offers powerful functionality, flexibility, and user-friendliness for the IEEE 1394-based (FireWire and i.Link) product development and test communities. FireInspector Plus™ includes traffic generation capabilities.

#### SPECIFICATIONS

Basic Events Detected	Bus Conditions, PHY packets, acknowledge packets, transaction codes, data patterns, hardware- detected errors, external signals
Generating Memory Size	64M x 8-bit DRAM
Host Requirements	Windows 2000, Windows XP, or greater; Intel Pentium II processor or greater; USB port
Power Requirements	90–264 VAC, 47–63 Hz (universal input), 125 W maximum
Connectors	USB Connection, 1394 Connection (6-pin) (3)

#### INDICATORS (LEDS)

PWR	Lights when powered on
TRG	Lights when triggering an event or power-on testing
REC	Lights when actively recording

#### ENVIRONMENTAL

Temperature: Operating	0 °C to 55 °C (32 °F to 131 °F)
Temperature: Non-Operating	-20 °C to 80 °C (-4 °F to 176 °F)
Humidity: Operating	10% to 90% RH (non-condensing)

#### PHYSICAL DIMENSIONS

Dimensions	10.5" x 10.4" x 2.4" (267 mm x 265 mm x 60 mm)
Net Weight	1.6 kg (3.5 lbs.)

#### WARRANTY AND SERVICE

3-year warranty. Other service programs include extended warranty, upgrades, trade-ins and rental services.



FIREINSPECTOR

#### ORDERING INFORMATION

#### PRODUCT CODE

1394 FireInspector Plus Analyzer/Generator	FW001UPA-X
1394 FireInspector Analyzer	FW001UAA-X
1394 FireInspector to FireInspector Plus Option	FW00SUA-X
1394 FireInspector Reduced Speed Option	FW501SUA-X

## INFINIBAND® PROTOCOL SOLUTIONS



**IBTRACER 4X**

### IB Tracer™ 4X Protocol Analyzer

IB Tracer 4X protocol analyzer advances validation and compliance testing for next generation InfiniBand silicon, switches, and software. Supporting 4X 2.5 Gb/s dual simplex connections, the IB Tracer 4X captures and displays traffic using the CATC Trace display.

The IB Tracer gives you full access to advanced triggering, filtering, searching and reporting for quick analysis of your InfiniBand traffic. IB Tracer supports the IB 1.1 specification and lane reversal of 4X InfiniBand links. The analyzer is built on the CATC 10K platform, and can also support capture of 1X InfiniBand links.

CATC PLATFORM SPECIFICATIONS (SEE PAGES 75-77)

### SPECIFICATIONS

#### PHYSICAL DIMENSIONS

Dimensions	9.3" x 6.7" x 1.3" (236 mm x 170 mm x 32 mm)
Net Weight	.82 kg (1.8 lbs.)

#### ORDERING INFORMATION

#### PRODUCT CODE

InfiniBand IB Tracer 4X Analyzer System	IB002AAA-X
InfiniBand IB Tracer 4X Analyzer Module	IB002MAA-X

## EXPERT ANALYTICAL SYSTEMS

The Auditor software application is a post processing analysis tool developed by **Expert Analytical Systems™** in cooperation with LeCroy. Designed to work with *SAS Tracer* and *FC Tracer* analyzers, the Auditor software can be configured to automatically perform architectural compliance assessment on the contents of a trace file captured by our analyzers. This automated tool significantly accelerates engineering qualification as well as regression testing of SAS and Fibre Channel silicon, firmware, software, and subsystems.

The Auditor software uses a 'rules' based verification engine developed using the architectural documents within the standard to provide a clear Pass/Fail analysis for numerous aspects of operational behavior and compliance at the logical level. It generates a series of reports that evaluate and highlight possible issues at the PHY, Link, Transport, and application layers.

The Auditor software can be opened from within the *SAS Tracer* and *FC Tracer* software environments with a few keystrokes. It can selectively verify traffic between up to 4 source or destination addresses and provides a systematic and repeatable assessment of compliance that significantly reduces the amount of detailed architectural knowledge required by test engineers.

The Auditor test suite can be customized to verify user specified subsets of rules. Individual rule-sets can be hidden from the reports to narrow the scope of the analysis. In addition to architectural compliance, the Auditor software provides a number of protocol specific thresholds that can be manually set by the user including command completion times and link layer timeouts values.

### ORDERING INFORMATION

### PRODUCT CODE

#### EXPERT ANALYTICAL SYSTEMS FC-AUDITOR SOFTWARE

Auditor Install Kit	FC001STA-X
FC Auditor Base 2-4 Software Key	FC002STA-X
FC Auditor Base 8 Software Key	FC003STA-X
FC Auditor FC-AL-2 Module Software Key	FC004STA-X
FC Auditor FCP Module Software Key	FC005STA-X
FC Auditor FC-AL-2 and FCP Suite Software Key	FC006STA-X
TRIAL FC Auditor Base, FC-AL-2 and FCP Suite Software Key	FC007STA-X
Maintenance FC Auditor Base Software 4	FC002STA-M
Maintenance FC Auditor Base Software 8	FC003STA-M
Maintenance FC Auditor FC-AL-2 Add-on Module	FC004STA-M
Maintenance FC Auditor FCP Add-on Module	FC005STA-M
Maintenance FC Auditor FC-AL-2 and FCP Suite	FC006STA-M

#### EXPERT ANALYTICAL SYSTEMS SAS-AUDITOR SOFTWARE

Auditor Install Kit	FC001STA-X
SAS Auditor Base 2 Port Software Key	SS002STA-X
SAS Auditor Base 4 Port Software Key	SS003STA-X
SAS Auditor STP Module Software Key	SS004STA-X
SAS Auditor SMP and Expander Module Software Key	SS005STA-X
SAS Auditor STP, SMP and Expander Suite Software Key	SS006STA-X
TRIAL SAS Auditor Base, STP, SMP, and Expander Suite Software Key	SS007STA-X
Maintenance SAS Auditor Base Software 2 Port	SS002STA-M
Maintenance SAS Auditor Base Software > 2 Port	SS003STA-M
Maintenance SAS Auditor STP Add-on Module	SS004STA-M
Maintenance SAS Auditor SMP and Expander Add-on Module	SS005STA-M
Maintenance SAS Auditor STP, SMP, and Expander Suite	SS006STA-M





## SOFTWARE OPTIONS

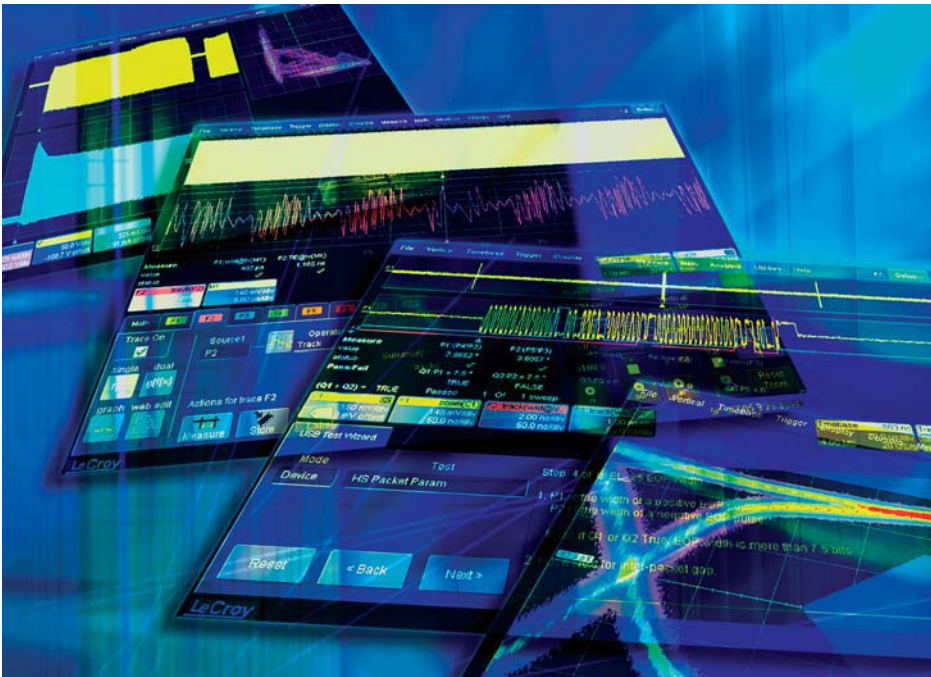

LeCroy oscilloscopes provide the best methods for probing, viewing, and manipulating electrical signals. Built in and customizable measurements let users perform calculations simply and quickly. Signal shape and variation can be analyzed through parameter measurements, histograms or frequency analysis.

In addition to a wide array of standard measurements, any LeCroy oscilloscope can be upgraded with an application package, adding sequencing of measurements that transform the oscilloscope into an even more powerful analyzer.

Each application package provides measurements that take advantage of the long channel memory for better time accuracy at long time per division settings, enhanced resolution in the frequency domain, and better statistics.

LeCroy's advanced architecture allows added application packages to be seamlessly incorporated directly into the simple graphic user interface. The new measurements are explained on the screen or in the scope's help system, so users will always understand the calculations on a signal. Users can even track the trend of a measurement over time. These additional tools facilitate troubleshooting, as they allow a greater understanding of the signal makeup.

There is an expandable package for virtually every application. For even more capability, our XDEV package lets users create their own oscilloscope measurements and run them within the scope. No other company in the industry offers measurement customization at such an integrated level.

WaveScan™ is a powerful search and analysis tool that provides the ability to locate unusual events in a single capture, or scan for an event in many acquisitions over a long period of time using more than 20 different search/scan modes. WaveScan uses measurement-based scanning modes, like frequency, to show statistical distribution of events, and can overlay events for a quick and simple visual comparison.

Users can efficiently create complete and detailed waveform reports directly in the oscilloscope with LeCroy's LabNotebook™. An all-in-one solution for annotating and sharing information, LabNotebook simplifies results recording and report generation by eliminating the multi-step processes that often involve several pieces of equipment.

**Analysis for the future** – LeCroy's architecture allows fast development of new measurements—combining probe, scope setup, reporting, documentation all in one oscilloscope package. LeCroy—from your circuit to your manager's desk.

## SOFTWARE OPTIONS

APPLICATION	WaveSurfer 200 MHz –1 GHz	WaveRunner 350 MHz–2 GHz	WavePro 1 GHz–3 GHz	WaveMaster 4 GHz, 6 GHz	WaveExpert 20 GHz–100 GHz	Serial Data Analyzer 4 GHz–18 GHz	Disk Drive Analyzer 3 GHz, 5 GHz
CAN Bus Trigger, DeCode, and Measure		CANbus TDM, CANbus TD	CANbus TDM, CANbus TD	CANbus TDM, CANbus TD		CANbus TDM, CANbus TD	CANbus TDM, CANbus TD
Communication Mask Test	ET-PMT	SDM, ET-PMT	SDM, ET-PMT	SDM, ET-PMT	*	ET-PMT	SDM, ET-PMT
Disk Drive Head, Channel and Failure Analysis		DDM2	DDM2	DDM2		DDM2	●
Fibre Channel					●	●	
InfinitiBand					●	●	
Mixed Signal Measurements	MS-32	MS-32	MS-32 DSA	MS-32 DSA		MS-32 DSA	MS-32 DSA
PCI Express						SDA-PCIE-G2	
PLL Analysis, Clock, & Timing		JTA2	JTA2	JTA2		ASDA-J	JTA2
Power Conversion Devices and Power Supply Measurement		PMA2	PMA2	PMA2		PMA2	
Rapid I/O					●	●	
Serial ATA						SDA-SATA	SDA-SATA
USB2		USB2	USB2	USB2		USB2	USB2
Ethernet		ENET†	ENET†	ENET		ENET	ENET
Advanced Optical Recording Measurement			AORM	AORM		AORM	AORM
Serial-Attached SCSI				SDA-SAS		SDA-SAS	SDA-SAS
Fully Buffered DIMM						SDA-FBDIMM	
High Definition Media Interface				SDA-HDMI**		SDA-HDMI**	SDA-HDMI**
Encode/Decode Utility			SDA-8B10B	SDA-8B10B		●	SDA-8B10B
EMC Pulse Parameter		WR6-EMC, WRXi-EMC††	WP7-EMC	WM-EMC			
WiMedia Ultra-Wideband				SDA-UWB		SDA-UWB	

● Standard

\* Compliance mask included

† WR6200A only

‡ WP7000A and higher bandwidths

\*\*\* Applicable only on 4 GHz or higher oscilloscopes

†† Applicable on all WR6000A and WRXi scopes with 500 MHz bandwidth or greater



## SOFTWARE OPTIONS

APPLICATION	WaveSurfer 200 MHz – 1 GHz	WaveRunner 350 MHz–2 GHz	WavePro 1 GHz–3 GHz	WaveMaster 4 GHz, 6 GHz	WaveExpert 20 GHz–100 GHz	Serial Data Analyzer 4 GHz–18 GHz	Disk Drive Analyzer 3 GHz, 5 GHz
<b>XMATH</b> Advanced Math Software Package		■	■	■	■	●	●
<b>XDEV</b> Advanced Customization Software Package		■	■	■	■	■	●
<b>XMAP</b> Master Analysis Software Package (Includes JTA2, XMATH and XDEV)		■	■	■		■	■
<b>JTA2</b> Jitter and Timing Analysis Software Package		■	■	■		●	■
<b>XWEB</b> Processing Web Editor Software Package for Functions and Parameters		■	■	■	■	■	■
<b>DDM2</b> Disk Drive Measurement Software Package		■	■	■		■	
<b>DFP2</b> Digital Filter Software Package		■	■	■	■	■	■
<b>ET-PMT</b> Electrical Telecom Test Software Package	■	■	■	■		●	■
<b>PMA2</b> Power Measure and Analysis Software Package		■	■	■		■	■
<b>SDM</b> Serial Data Mask Software Package		■	■	■		●	■
<b>MATHSURF</b>	■						

● Standard  
■ Optional

## WAVESCAN

*“WaveScan  
Advanced Search  
and Analysis  
Finds Problems  
that Triggers  
Won’t Find”*

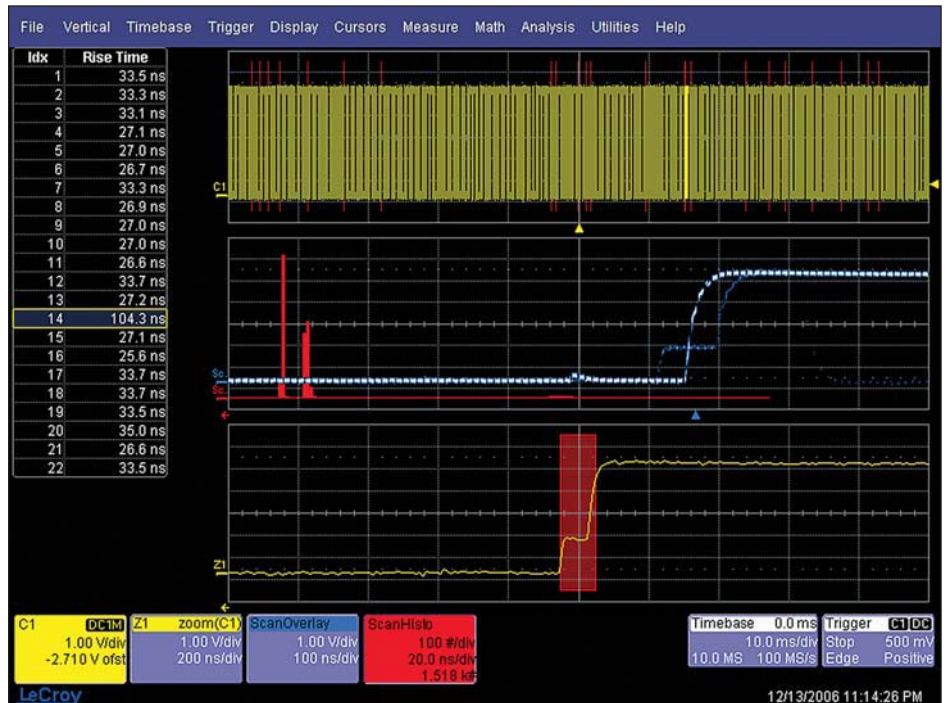

*WaveScan Advanced Search and Analysis finds problems that triggers won't find.*

### Both Searches and “Scans”

WaveScan provides the ability to locate unusual events in a single capture (i.e., capture and search), or “scan” for an event in many acquisitions over a long period of time. Select from more than 20 search modes (frequency, rise time, runt, duty cycle, etc.), apply a search condition and begin scanning.

### Finds Problems That Triggers Won't Find

The best trigger won't find all unusual events—a more powerful capability is sometimes needed. Since the scanning “modes” are not simply copies of the hardware triggers, the utility and capability is much higher. For instance, there is no “frequency” trigger in any oscilloscope, however, WaveScan allows for “frequency” to be quickly “searched or scanned.” This allows the user to accumulate a data set of unusual events that are separated by hours or days, enabling faster debugging.

### Fast Processing Aids Analysis

When used in multiple acquisitions, WaveScan builds on the traditional LeCroy strength of fast processing of data. A LeCroy X-Stream scope will quickly scan millions of events, looking for unusual occurrences, and do it much faster and more efficiently than other oscilloscope can.

### Advanced Analysis Adds to Understanding

The ScanHisto and ScanOverlay capabilities are available on most LeCroy scopes. Found events can be overlaid in a ScanOverlay view to provide a quick and simple comparison of events. In addition, measurement-based scanning modes (like the frequency example given above) permit ScanHistograms to show the statistical distribution of the found events. These analysis tools simplify understanding and enable faster debug.

WAVESCAN

SPECIFICATIONS

<b>General</b>	<b>Available on most LeCroy oscilloscopes</b>
Modes	Edge, Non-Monotonic, Runt, Measurement (15 available)
Measurement Modes	DTime@Level (time between 2 edges), Duty Cycle, Fall Time (90–10%), Fall Time (80–20%), Fall Time (User Select), Frequency, Period, Rise Time (10–90%), Rise Time (20–80%), Rise Time (User Select), Time@Level (time from Trigger to Edge), Width Positive, Width Negative, X@max, X@min. (WaveExpert also includes TimeIntervalError@Level) Additional parameters may be available if other software options are purchased for the oscilloscope.
Source	Any channel, math, or memory trace
Filter Method	None Greater Than Less Than Within Limit $\pm\Delta$ (value or %) Outside Limit $\pm\Delta$ (value or %) Definable # of Rare Events.
Filter Setup	Setup directly, Set Value $\pm n\sigma$ , or select ScanHisto bin to define filter.
Event “Found” Marker	Red box around the event area
Trigger Actions on Feature “Found”	None Audible Beep Stop Acquisition Save Waveform(s) Pulse AUX Output Print (Save) Screen Image Save to LabNotebook
<b>Searching</b>	For a single acquisition (STOP trigger), pick a Mode, Source, and Filter. WaveScan searches through a single acquisition, identifies events found with a red box, and creates a user-scalable zoom trace to look at event(s) in more detail.
<b>Scanning</b>	Create a hardware trigger condition, then pick a Mode, Source, and Filter. WaveScan scans through each acquisition, identifies events found with a red box, and creates a user-scalable zoom trace to look at event(s) in more detail. User can set WaveScan to perform an action when an event is found, such as STOP the trigger, or save the results. Thus, a software “scan” can be used to qualify a hardware trigger event.
<b>Table</b>	Optionally displayed (user-selectable). Displays a list of all found events that meet the setup condition. Touch a listed event and automatically center the zoom on that event.
<b>Analysis</b> ScanHisto(gram)	Optionally displayed (user-selectable). Displays an accumulative histogram (1000 events standard, up to 2 billion with other, optional packages) showing distribution of all found events.
ScanOverlay	Optionally displayed (user-selectable). Displays an accumulative overlay with adjustable persistence of all events found in the most recent acquisition. Overlay may be zoomed and positioned, as desired.



LABNOTEBOOK

This software works with

- WaveExpert
- WaveMaster
- WaveRunner
- WavePro
- SDA
- DDA

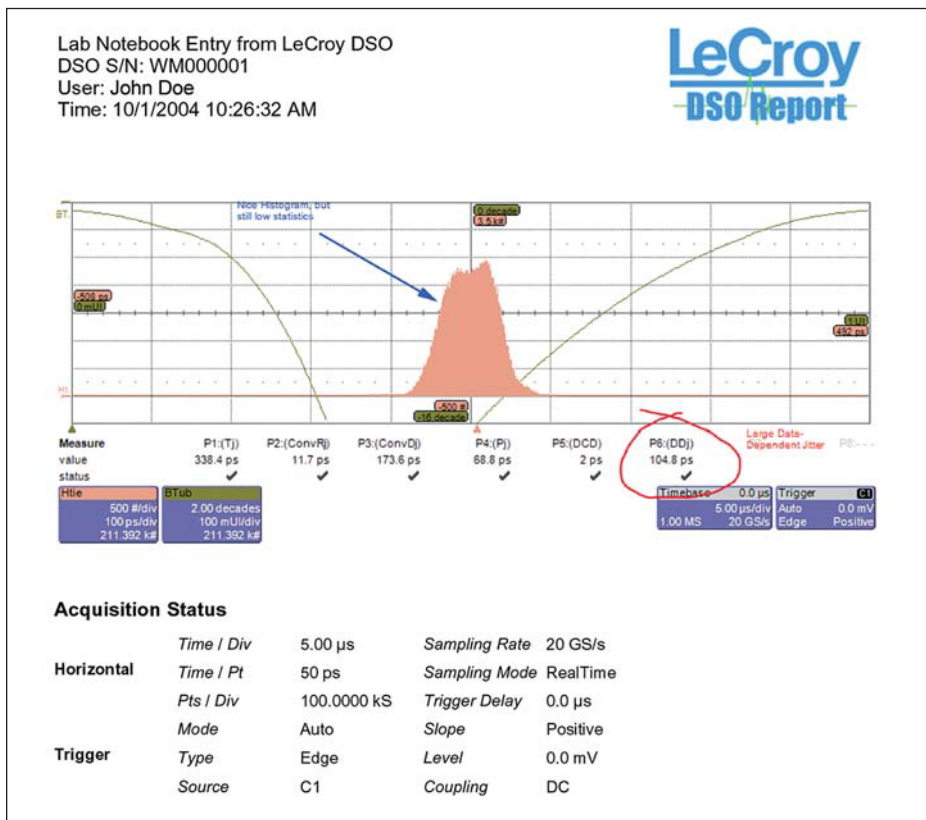

Freehand notes can be written on the screen with a stylus right on the waveform and then saved in the report file. Simple and very efficient.

LabNotebook enables users to efficiently create complete and detailed waveform reports in a LeCroy oscilloscope.

An all-in-one solution for annotating and sharing information, LabNotebook eliminates the multi-step processes that often involve several pieces of equipment, allowing users to stay focused on the content, not the process.

**Features:**

- Save all displayed waveforms
- Save the relevant oscilloscope setups with the saved waveform
- Add freehand notes with a stylus or as text
- Convert the complete report to pdf, rtf, or html
- Print or email reports

**Additional Features:**

- A default report layout
- Configuration of a customized report layout
- The ability to place a company logo or department name in the report
- Storing notebook entries for recall at any time
- Storing panel setups and parameter measurements
- Database backup to external media
- Storing reports and data separately for shared oscilloscopes

## LABNOTEBOOK

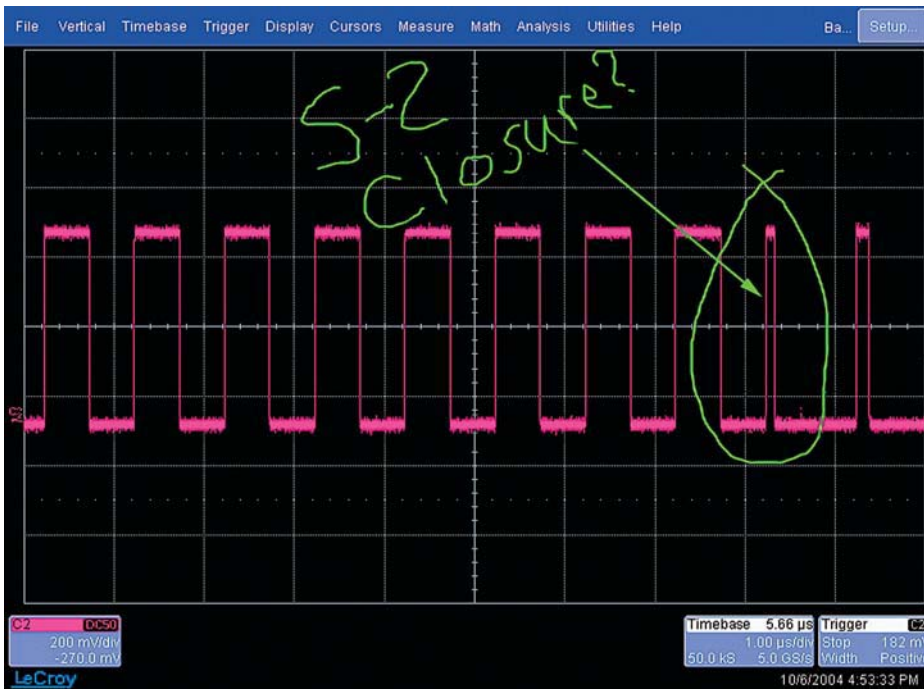

### Create Notes with the Screen Capture

By pressing Hard Copy, users can annotate waveforms as they capture them. Once the notes are finished, they can be readily saved as a report and e-mailed directly from the oscilloscope.

### Flashback Function

Users can employ the Flashback Function to recall the state of the oscilloscope, including saved waveforms and setup. Additional measurements are easily made using the keyword filter to find the correct notebook entry for recall.

## AORM - ADVANCED OPTICAL RECORDING

### This software works with

- WaveMaster
- WavePro
- SDA
- DDA

### A Precise, Accurate Characterization Tool Kit

The AORM software package is now available in the new generation (WaveMaster and WavePro 7200A or better) high-performance oscilloscopes. In addition to all the ORM/AORM features supplied in legacy oscilloscopes for over ten years, the AORM option in new generation/X-Stream oscilloscope environment provides a completely updated user interface and improved debug tools written to support ever-increasing read/write data rates and larger media capacity required for the latest CD and DVD implementations. Typical applications include game machine technology and high capacity DVD Read/Write.

The unique combination of deep acquisition memory available in LeCroy oscilloscopes plus the flexibility of AORM in adapting to Optical Recording standards provides the user with ultimate measurement accuracy and 2-dimensional correlation of recording parameters.

### Features:

- Real Time Emulation of CD and DVD Channel Signal Processing
- Histogram, Trend and XY Parametric Views
- Flexible, Powerful suite includes ORM Measurements Package
- Equalizer, Slicer and Clock Extraction functionality

### CD and DVD Channel Emulation

In AORM, Channel emulation enables real time signal processing in software. Responding to innovations in Optical Disk Drive technology, LeCroy is pleased to introduce a software package designed to interface with existing CLV (Constant linear Velocity) type systems as well as new CAV (Constant Angular Velocity) type systems used for Hard Disk Drive and High-speed CD-ROM applications. AORM is also compatible with ZCLV (Zoned Constant Linear Velocity) systems used in DVD Drive.

AORM allows the user to simulate several aspects of RF signals, including:

- Equalization with Low Pass Filtering and Signal Boost/pre-emphasis control
- Slicing, which sharpens signal edges and filters out low frequency content
- Software clock recovery with user configurable PLL
- Slicer Threshold, which verifies PLL stability

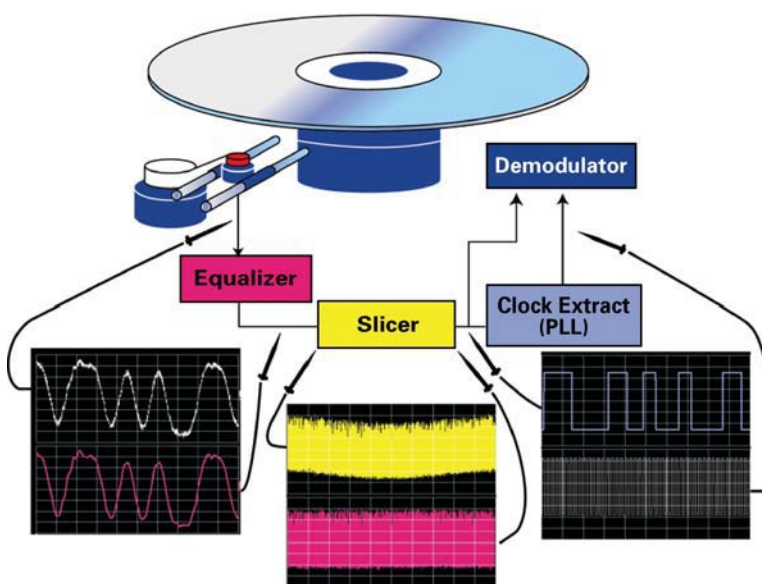
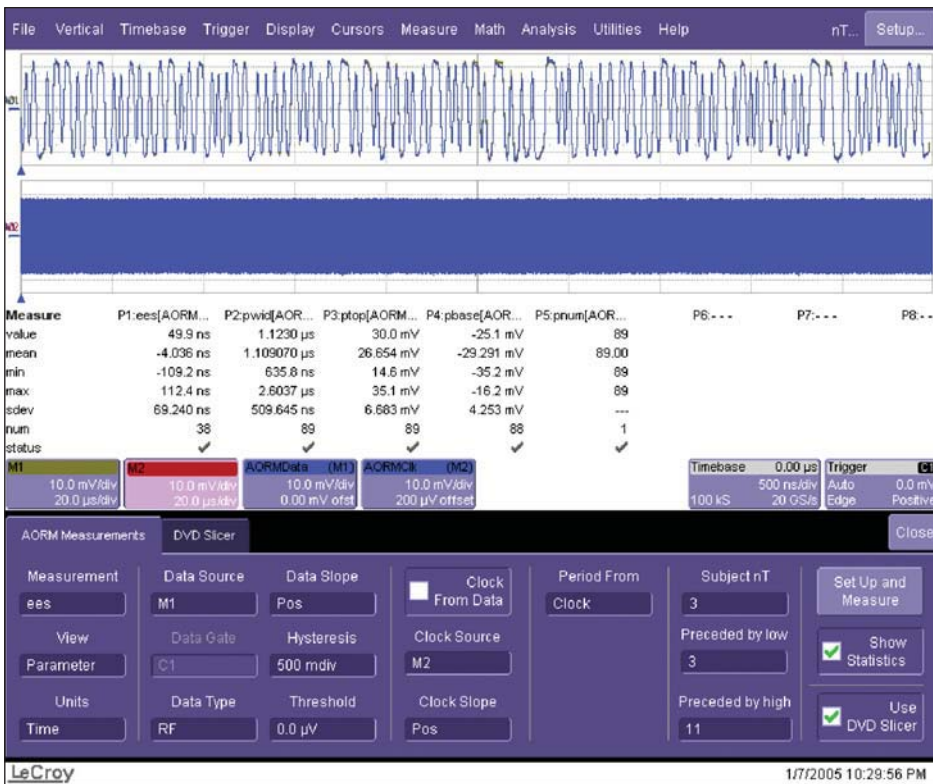

Figure 1 depicts a block diagram of signal processing in Optical Disk Drive. AORM software extracts baseline fluctuation and slices the RF signal to generate a binary signal. Then the software PLL extracts clock content from the incoming binary signal, and decoder decode from binary signal timing refer to the clock. Accordingly a timing of an edge of binary signal and clock has big meaning.



## AORM – ADVANCED OPTICAL RECORDING

**Histogram, Trend, and XY Parametric Views**

As hardware designers are quick to recognize, measurement results often need to be summarized and tabulated for quick interpretation. Oscilloscope technology further enhances AORM functionality:

- Long Memory Records
- Multi Zoom
- Smart Trigger (Interval and Width)
- Statistics of Parameter
- Signal processing views (Histogram/Trend/XY Trend)

**Characterization of ISI**

Since its introduction over a decade ago, ORM has been viewed as the optical disk recording measurement standard. However, characterization of ISI using edge shift parametric measurements versus pit-space pair was a tedious, time-consuming process. AORM software adds five parameters that greatly simplify characterization of ISI: **BES, BESS, EES, EESS, BEES**.

**Bes** Pulse width between beginning specified edge shift of specific pit-space pair and next positive clock edge

**bess** Standard deviation of bes

**ees** Pulse width between trailing edge shift of specific pit/space pair and nearest specified clock edge

**eess** Standard deviation of ees

**bees** Beginning and ending edge shift for a specific pit (space) preceded and followed by a specific space (pit)

**AORM - ADVANCED OPTICAL RECORDING**

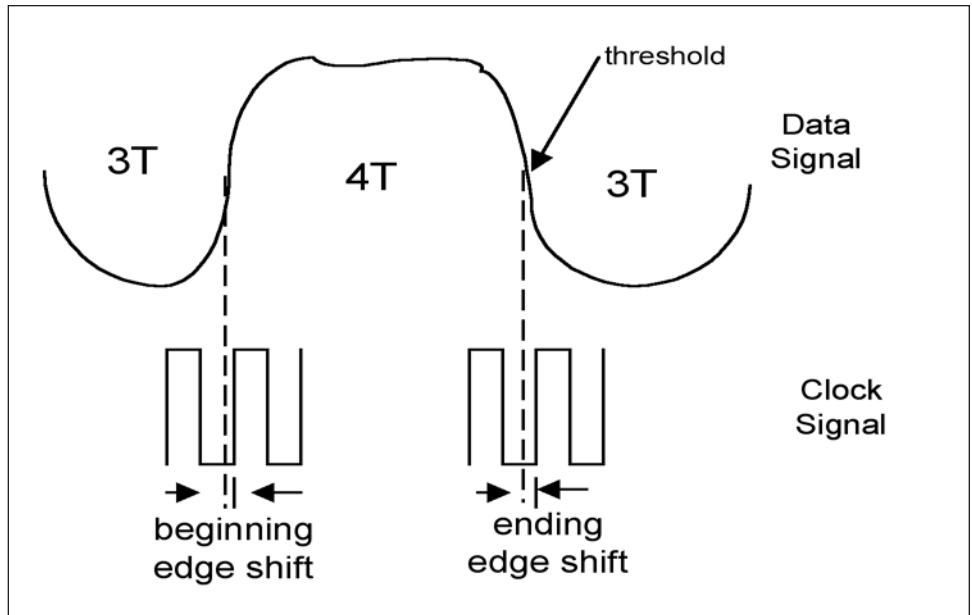

PARAMETER DEFINITION TABLE			
Timing Analysis Parameters		Amplitude Analysis Parameters	
<b>deltap2c</b>	Data edge shift referred to clock	<b>paa</b>	Average amplitude of RF signal
<b>deltap2cs</b>	Standard deviation of deltap2c	<b>pasym</b>	Asymmetry of RF signal
<b>edgsh</b>	Pit or space width difference from ideal value	<b>pbase</b>	Base of pit or space
<b>period</b>	Period of each cycle of clock	<b>pmax</b>	Maximum of pit or space
<b>pnum</b>	Number of pit or space pair	<b>pmidl</b>	Middle voltage of pit or space
<b>pwid</b>	Width of pit or space pairs	<b>pmin</b>	Minimum of pit or space
<b>t@pit</b>	Delay of pit or space from trigger	<b>pmoda</b>	Modulation of RF signal
<b>timj</b>	Standard deviation of edgsh	<b>pres</b>	Resolution of RF signal
		<b>ptop</b>	Top of pit or space

## AORM - ADVANCED OPTICAL RECORDING

### View Options:

- *Parameter* – the source trace(s) will be displayed along with the custom parameters.
- *List by nT* – the source trace(s) will be displayed along with the list by nT parameter display.
- *Histogram* – The histogram of the selected parameter is shown.
- *Trend* – The trend of the selected parameter is shown.
- *XY Plot* – Plots the trend of the selected measurement vs either the trend t@pit or pwid as appropriate



Histogram Function.

AORM Package Configuration includes all the software and oscilloscope accessories required to run the application on the WaveMaster or WavePro (7200A or better) family. A retrofit kit (RK-AORM) is available for existing ORM customers.

### ORDERING INFORMATION

Advanced Optical Recording Measurement Software Package

### PRODUCT CODE

AORM

### AORM Minimum Recommended System Package

WavePro 7200A with Memory Option-L

WavePro 7200A

AORM Advanced Optical Recording Measurement Software Package

AORM



DDM2 – DISK DRIVE MEASUREMENT

This software works with

- WaveMaster
- WaveRunner
- WavePro
- SDA



In this example, DDM2 allows the user to perform up to eight simultaneous parametric measurements of critical disk drive properties.

The perfect solution for failure analysis when testing disk drives, DDM2 software adds dozens of measurements to standard oscilloscopes capabilities. This package provides disk drive parameter measurements and related mathematical functions for performing disk drive analysis.

The Disk Drive Measurement and PRML Measurement packages utilize IDEMA® test methods and industry standard PRML measurements to extend the range of capabilities of the LeCroy WaveMaster, WaveRunner and WavePro oscilloscopes.

Features:

- Disk Drive Parameters
  - amplitude symmetry
  - auto correlation s/n
  - local base
  - local baseline separation
  - local maximum
  - local minimum
  - local number
  - local peak-peak
  - local time between events
  - local time between peaks
  - local time between troughs
  - local time at minimum
  - local time at maximum
  - local time peak-trough
  - local time over threshold
  - local time trough-peak
  - local time under threshold
  - narrow band phase
  - narrow band power
  - non-linear transition shift
  - overwrite
  - pulse width 50
  - pulse width 50-
  - pulse width 50+
  - resolution
  - track average amplitude
  - track average amplitude-
  - track average amplitude+
- Correlation function
- Trend (datalog) of up to one million events
- Histograms expanded with 19 histogram parameters and up to 2 billion events

## DDM2 – DISK DRIVE MEASUREMENT

TAA	Resolution	Inum	ltot	msnr
TAA+	Overwrite	lpp	ltpt	rsnr
TAA-	lbase	ltbe	lttp	m_to_r
PW50	lbsep	ltbp	ltut	nbph
PW50+	lmax	ltmn	NLTS	nbpw
PW50-	lmin	ltmx	ACSN	

### Frequency Domain Parameters Description

These parameters provide a rapid technique to extract the amplitude and phase of single frequencies from complex waveforms. These parameters are more efficient than using an FFT if the frequencies of interest are known.

### Histograms

Any waveform parameter may be histogrammed. The histogram function produces a waveform with the vertical axis in units of “Events” and the horizontal axis in parameter units (volts, nanoseconds, . . . etc.). The histogram shows the statistical variation of the selected parameter. Over thirteen different statistical measurements can be modified on the histogram.

### PRML Measurement Package

#### PRML Parameters

PRML (Partial Response Maximum Likelihood) recording channels provide higher area densities by allowing magnetic transitions to be written at closer spacing than peak detection channels. The following parameters provide a time domain technique to measure the time shift and S/N ratio created by this magnetic writing process.

The DDM2 package also includes the following functions:

- Non Linear Transition Shift
- Auto Correlated Signal to Noise
- Auto Correlation

### ORDERING INFORMATION

Disk Drive Measurement Software Package

### PRODUCT CODE

DDM2

## EMC PULSE PARAMETER

### This software works with

- WaveMaster
- WaveRunner
- WavePro

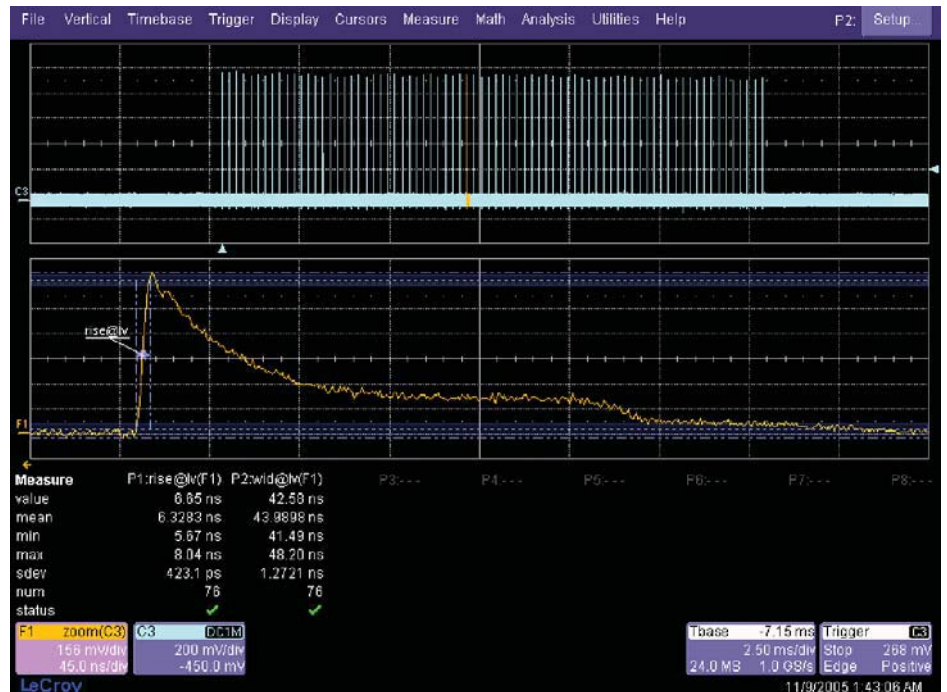

Long memory allows the capture of complete EFT bursts with high sample rate. EMC measurement parameters can measure the entire burst or be used with the zoom function to measure an individual pulse.

### Customizable Measurement Parameters for EMC Pulse Verification

#### Electrostatic Discharge (ESD)

High sample rate and bandwidth are important to accurately characterize pulse shapes created with an ESD generator. The software package offers specialized parameters with adjustable levels to customize the necessary rise time, fall time, and width measurements to ensure that the generator meets industry standards. View a large number of measurements at a single glance with built-in statistics and histograms.

#### Electrical Fast Transient (EFT)

The long memory available in X-Stream Digital Oscilloscopes, along with sequence acquisition mode, enable the capture of many EFT bursts in a short period of time. Specialized rise, fall, and width pulse parameters, added with the software package and combined with statistics and histograms, allow for fast pulse measurements over all bursts. Built-in oscilloscope zoom capabilities allow you to quickly locate and view any pulses that may fall out of spec.

#### Surge

Validate surge waveforms at the appropriate sampling rate with the built-in long memory of the X-Stream oscilloscopes. Parameters, statistics and histograms, quickly and easily characterize surge generator pulse shapes over many acquisitions.

#### Features:

- Fast and Accurate EMC pulse verification
- Customizable Rise, Fall, and Width parameters
- Histogram up to 2 billion events

## EMC PULSE PARAMETER

### Pulse Parameters

#### *Special Automatic Measurement Parameters*

The software package provides customizable parameters to measure rise time, fall time, or width characteristics according to specific EMC/ESD standards. Level selections can be made to ignore undershoot, overshoot, or tail perturbations, making it quick and easy to capture and verify repetitive pulse sequences without the need to manually use time-consuming cursors. Up to 8 parameters in WavePro or WaveMaster/SDA can be defined at one time.

#### *Measurement Filtering*

Measurement filtering allows users to measure only a certain number of pulses in an acquisition, or measure only the initial pulse rise excluding the effects of excessive tail perturbations.

### Transient

The long memory of X-Stream Digital Oscilloscopes ensures the sample rate and capture time needed to verify and view transient pulses spaced up to 10 seconds apart.

### Voltage Dips and Interrupts

Testing your device to meet the Voltage Dips and interrupts standard requires monitoring the device during a voltage dip. X-Stream Digital Oscilloscopes provide all necessary monitoring tools, and the ability to quickly store and annotate waveforms.

### ORDERING INFORMATION

### PRODUCT CODE

EMC Pulse Parameter Software Package for WaveRunner Xi Series	WRXi-EMC*
EMC Pulse Parameter Software Package for WaveRunner Series	WR6-EMC*
EMC Pulse Parameter Software Package for WavePro Series	WP7-EMC
EMC Pulse Parameter Software Package for WaveMaster/SDA Series	WM-EMC

\*WR6-EMC is compatible with all WR6000A and WRXi models with 500 MHz bandwidth or greater.



## ET-PMT – PULSE MASK TEST PACKAGE

### This software works with

- WaveMaster
- WaveRunner
- WavePro
- WaveSurfer
- SDA

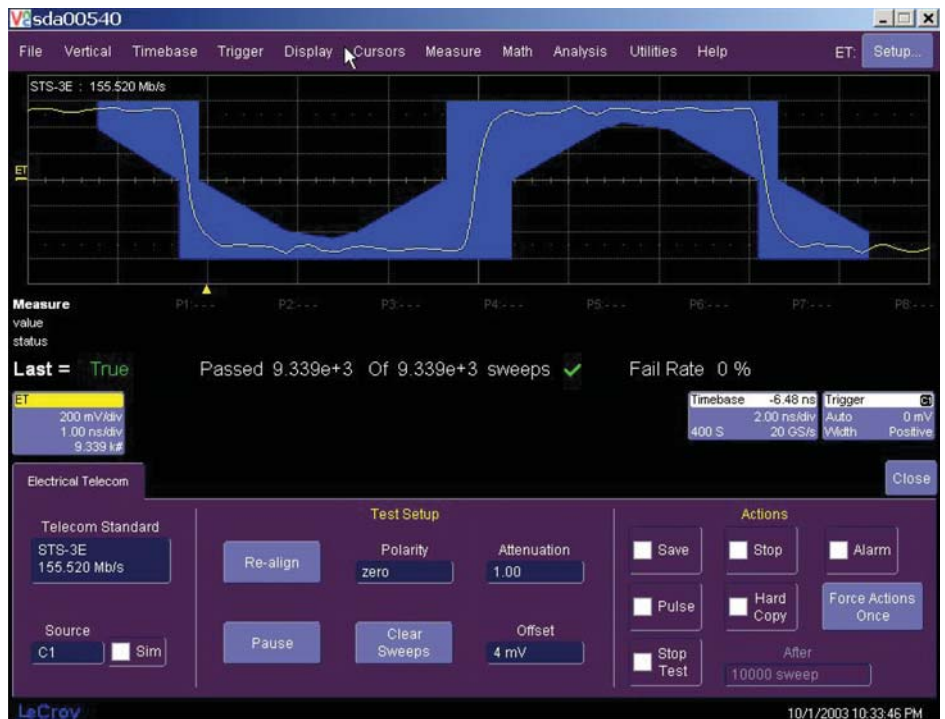

An ATM (155.2 Mb/s) pulse is measured using the STS-3E mask.

The ET-PMT electrical pulse mask testing software for LeCroy oscilloscope performs automated compliance mask tests on a wide range of electrical telecom standards.

### Features:

- Automatic PASS/FAIL testing
- Supports ANSI T1 and ITU standard pulse mask tests
- User-definable mask for custom signals
- Automatic mask alignment
- Multiple actions on failure

### Fast, Accurate Conformance Testing

Signals are tested against standard masks and the software keeps track of the number of failures (signal excursions outside the compliance mask) as well as the percentage of failures relative to the number of sweeps. Unattended or long-term testing is supported through the use of automated actions on failure. These include storage of the failed waveform, outputting a pulse, printing a screen image, stopping the test, or generating an audible alarm. Any combination of these actions can be set to occur on a failure. The test can be programmed to terminate after a defined number of sweeps or to run indefinitely.

### Future-proof Design

As telecom standards evolve, new pulse types and data rates are defined. In addition, many new applications for pulse mask tests are being developed for proprietary interfaces. The LeCroy ET-PMT software mask, alignment and pulse location functions are completely defined by a single Microsoft™ Access 2000™ data base. New mask test criteria can be added by simply editing this file to include the data rate, mask and any pulse finding criteria.

## ET-PMT – PULSE MASK TEST PACKAGE

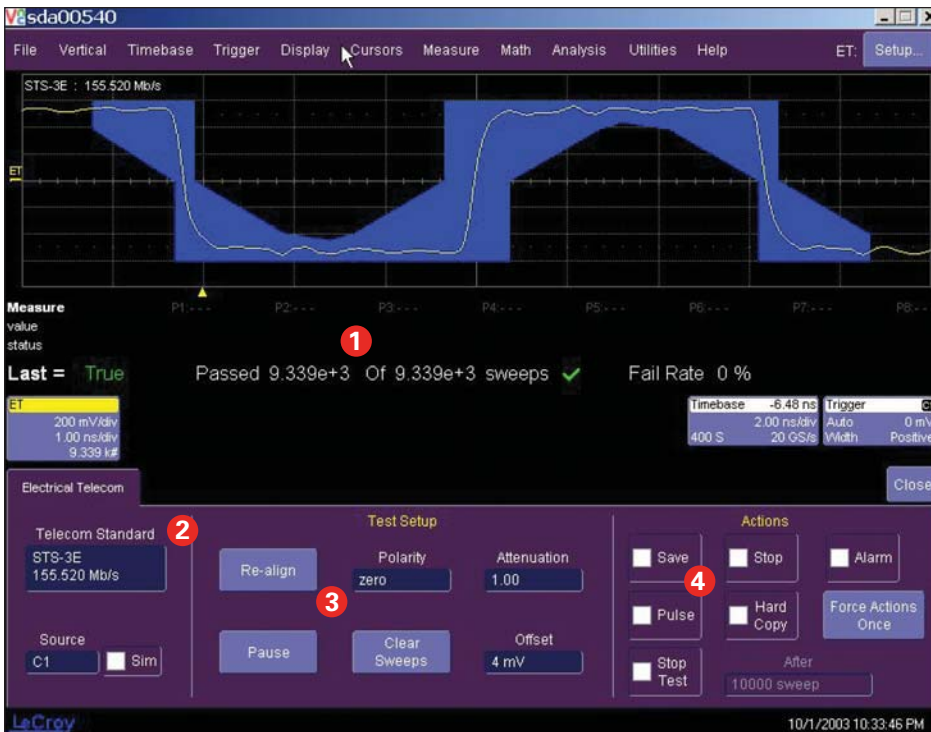

- 1 Failure rate and percentage
- 2 Support for ITU and ANSI telecom pulse masks
- 3 Automatic mask alignment, gain and offset
- 4 Multiple simultaneous failure actions

### SPECIFICATIONS

Telecom Standards	E1 TP, E1 Coax, E2,E3, E4, STM1-E,DS-1, DS-3, STS-1,STS-3E
Actions on Failure	Save, stop, print, alarm, output pulse
Sweep Count for Testing	1 to 10e9

### ORDERING INFORMATION

### PRODUCT CODE

Electrical Telecom Test Software Package	ET-PMT
Telecom Adapter Kit 100 Ω Bal., 120 Ω Bal., 75 Ω Unbal.	TF-ET

## PMA2 – POWERMEASURE PACKAGE

### This software works with

- WaveMaster
- WaveRunner
- WavePro
- SDA



LeCroy's PMA2 PowerMeasure Analysis software provides exceptional ability to measure and analyze the operating characteristics of power conversion devices and circuits.

### Features:

- Automatic setup and display of relevant waveforms and parameters
- Waveforms scaled and displayed in Volts, Amps, Watts, Ohms, etc.
- Power device performance analyzed in-circuit
- Measure and view the time domain response of the entire control loop
- Line harmonics testing to EN 61000-3-2
- Complete solutions available, including probes and differential amplifiers.
- Usable with a wide range of probes, amplifiers, shunts, and current shunt resistors.
- Gated measurement capability

PMA2 is used with LeCroy X-Stream oscilloscopes to make critical power switching device measurements, perform control loop modulation analysis, and measure line power harmonics. Specially designed LeCroy accessories, such as differential amplifiers, differential probes, current probes, and deskew fixtures, provide unparalleled measurement quality. PMA2 provides quick and easy setup of your voltage and current input. In many cases, no manual deskew is required, ensuring the highest accuracy of your measurements. Once set up, access to important analysis and measurements is only a button push away. All aspects of Device Analysis, such as various power losses, saturation voltage, high side gate drive, dynamic-on resistance, safe operating area, and others are easily performed. Modulation analysis allows you to intuitively understand control loop response, such as soft start performance or step response to line and load changes. Line Power Analysis allows simple and quick pre-compliance testing to EN 61000-3-2.

## PMA2 – POWERMEASURE PACKAGE

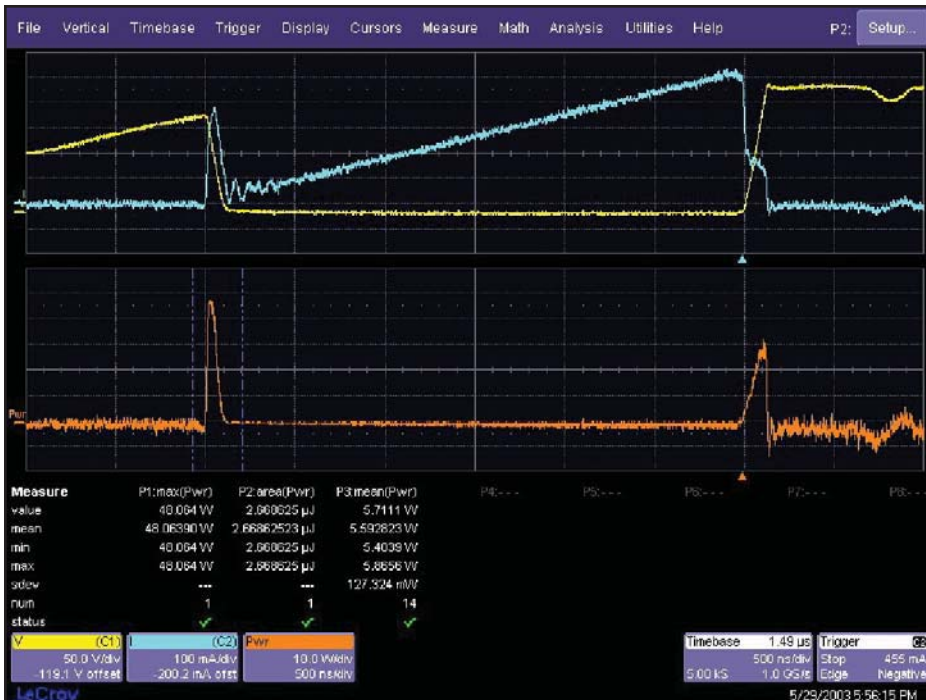

PMA2 provides the capability to apply a gate (window) for a particular parameter around a portion of the waveform.

### Power Device Analysis

Analyze power device performance while the device is operating in circuit, without requiring specially designed test fixtures or clipping circuits. Only LeCroy can provide the full range of measurement capability, including capture windows in the 100s of milliseconds at high sample rates for finding unusual violations during safe operating area measurements.

### Modulation Analysis

Modulation Analysis functions produce a time domain display, which represents the modulated parameter in a time-vs-parameter value graphical plot. They are convenient tools for intuitively viewing the time domain response of the entire control loop, including any time constants added by the pulse width modulator. Modulation Analysis can be performed for duty cycle, period, frequency, and pulse width.

### Line Harmonic Analysis

Line Power Analysis easily measures a power conversion device's incoming rms line voltage, rms current consumption (in watts and VA), Power Factor, Apparent Power, and Real Power. Line current harmonic measurements are made and compared to standard templates for EN 61000-3-2 Class A, B, C, or D equipment. Results can be displayed in either graphical frequency domain or tabular formats.



## PMA2 – POWERMEASURE PACKAGE

### ORDERING INFORMATION

PowerMeasure Analysis Software Package

### PRODUCT CODE

PMA2

### DIFFERENTIAL AMPLIFIERS AND ACCESSORIES

1 Ch, 100 MHz Differential Amplifier with Precision Voltage Source	DA1855A
2 Ch, 100 MHz Differential Amplifier with Precision Voltage Source	DA1855A-PR2
±100 or ±10 Selectable, 250 MHz Passive Differential Probe Pair	DXC100A*
±1, 50 MHz Passive Differential Probe Pair	DXC200*
±100, 250 MHz 2.5kv, High Voltage Probe Pair (requires DA101 for full performance)	DXC-5100*
±10, 1 MΩ External Passive Attenuator (recommended with DXC5100)	DA101*
DA1855A with Rackmount (must be ordered at time of purchase, no retrofit)	DA1855A-PR2-RM

\* Must be used with DA Series Differential Amplifiers.

### CURRENT PROBES

30 A; 100 MHz Current Probe – AC/DC; 30 A <sub>rms</sub> ; 50 A <sub>peak</sub> Pulse	CP031
30 A; 50 MHz Current Probe – AC/DC; 30 A <sub>rms</sub> ; 50 A <sub>peak</sub> Pulse	CP030
150 A; 10 MHz Current Probe – AC/DC; 150 A <sub>rms</sub> ; 500 A <sub>peak</sub> Pulse	CP150
500 A; 2 MHz Current Probe – AC/DC; 500 A <sub>rms</sub> ; 700 A <sub>peak</sub> Pulse	CP500
30 A; 50 MHz Current Probe – AC/DC; 30 A <sub>rms</sub> ; 50 A <sub>peak</sub> Pulse	AP015

### ACCESSORIES

Deskew Calibration Source	DCS015
---------------------------	--------

### OTHER POWER ACCESSORIES

#### HIGH-VOLTAGE DIFFERENTIAL PROBES

1,400 V, 100 MHz Differential Probe	ADP305
1,400 V, 20 MHz Differential Probe	ADP300
15 MHz Differential Probe (±10, ±100)	AP031

#### HIGH-VOLTAGE PASSIVE PROBES

±1000; 100 MHz; 50 MΩ High-Voltage Probe 20 kV (40 kV Peak) max. Voltage DC and Peak AC	PPE20KV
±100; 400 MHz; 50 MΩ High-Voltage Probe 2 kV max. Voltage DC and Peak AC	PPE2KV
±100; 400 MHz; 50 MΩ High-Voltage Probe 4 kV max. Voltage DC and Peak AC	PPE4KV
±100; 400 MHz; 50 MΩ High-Voltage Probe 5 kV max. Voltage DC and Peak AC	PPE5KV
±1000; 400 MHz; 50 MΩ High-Voltage Probe 6 kV max. Voltage DC and Peak AC	PPE6KV
±10/±100; 200/300 MHz; 5 MΩ/50 MΩ High-Voltage Probe 600 V/1.2 kV max. Voltage DC and Peak AC	PPE1.2KV

## SDA-8B10B - DECODE AND ANALYZE



This software works with

- SDA (Standard)
- DDA
- WavePro
- WaveMaster

Configure and decode up to 4 channels

### Translate Serial Data Waveforms into Symbol Views

The SDA-8B10B Protocol Decoding Software package provides the ability to analyze an encoded data stream and view the physical layer signaling associated with those data streams. Users can simultaneously view the physical layer waveform and the symbolic content of that waveform on one convenient display.

A powerful search feature allows captured waveforms to be searched for user-defined sequences of symbols.

When the sequence of symbols is identified, waveforms are automatically zoomed to highlight the detected sequence.

### Features and Benefits:

- Automatic setup and display of relevant waveforms and parameters
- Translates 8B/10B encoded Serial Data Waveforms into symbol views for effective troubleshooting
- Correlates Protocol Events to Physical Waveforms for greater insight
- Saves Data to Disk for further analysis
- Supports multichannel operation to view up to four lanes simultaneously
- Protocol decoding capability up to 6.25 Gb/s
- Real-time Triggering for data rates up to 2.7 Gb/s

## SDA-8B10B – DECODE AND ANALYZE

### Multichannel Operation – View up to Four Lanes Simultaneously

Certain serial data standards (for example PCI Express) transmit and receive data in multiple lanes. The ability to apply decoding to up to four simultaneously captured channels allows for multi-lane analysis that is not possible with single-channel solutions.

When combined with the high bandwidth abilities of the SDA 11000 oscilloscope, this software option permits symbolic decoding of high-speed serial data applications such as SATA Gen2 (3 Gb/s), PCI Express Gen2 (5 Gb/s) and SAS 6 Gb/s.

### Correlate Protocol Events to Physical Waveforms for Greater Insight

LeCroy's unique combination of advanced protocol analysis and decoding tools allows for ultimate correlation of protocol messages to waveform events. LeCroy's protocol analyzers can be programmed to issue a trigger signal on the occurrence of any protocol primitive or message.

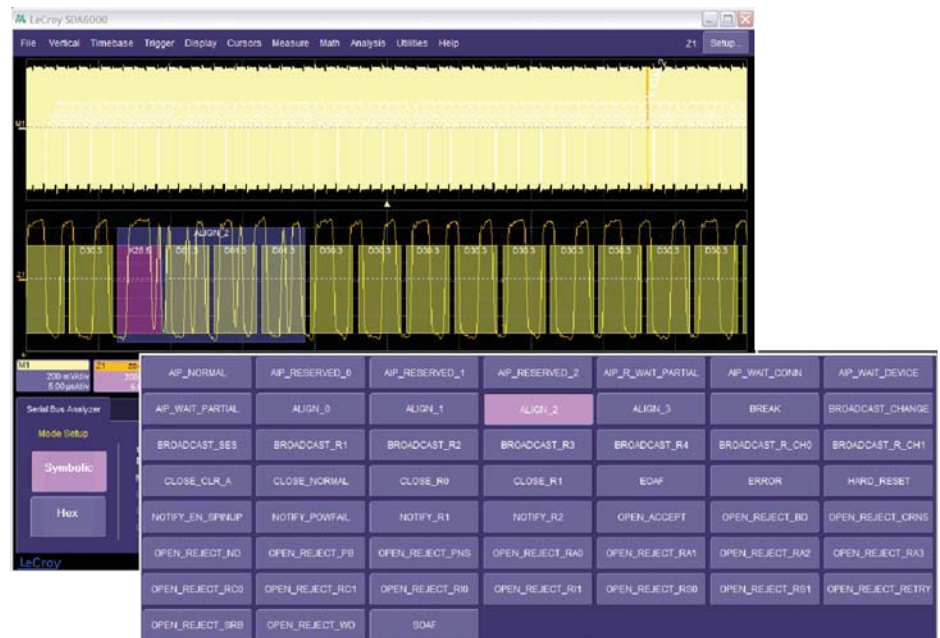

### SPECIFICATIONS

Decoding Level	8B/10B to Symbolic Primitives up to 4 simultaneous channels
ASCII Display	Yes
File Output	Yes
Memory Length	50 Mpts per channel
Hardware Trigger	Yes (SDA 6000A XXL Serial Trigger)
Trigger	32 bits (in SDA 6000A XXL), Advanced Triggering Options
Pattern Length	when used with Protocol Analyzer Trigger Function
Interaction with Oscilloscope Functions	Yes – All measurement and analysis tools

### ORDERING INFORMATION

8B/10B Decoding and Analysis Software Package

### PRODUCT CODE

SDA-8B10B\*

\* SDA-8B10B is standard with LeCroy Serial Data Analyzers and optional with the Disk Drive Analyzers, WavePro, and WaveMaster oscilloscope series.

## ACTIVEDSO

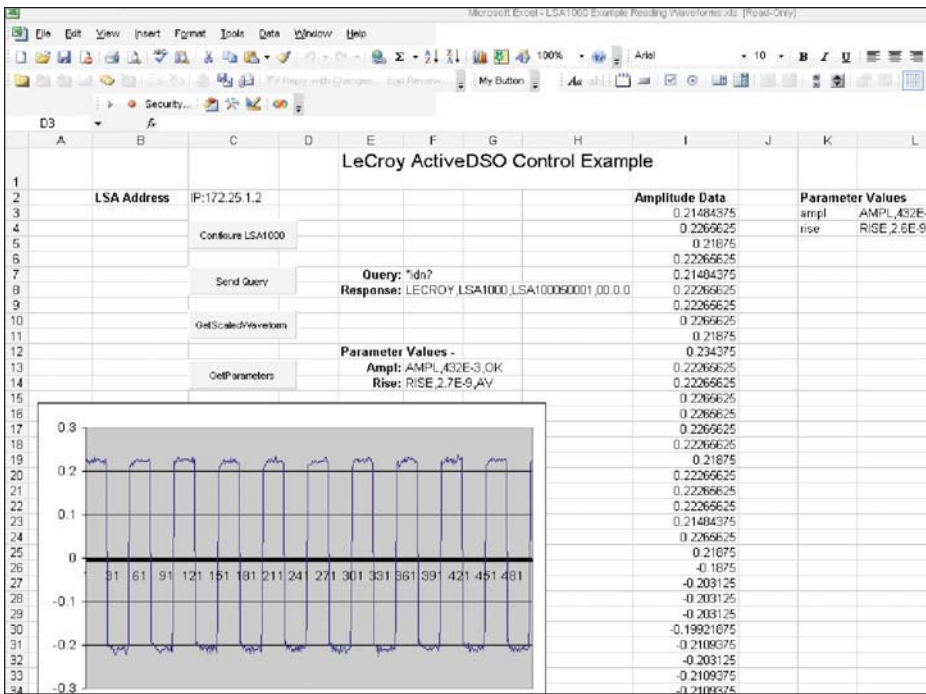

ActiveDSO may be used to read waveform data from the oscilloscope, and graph it directly within an Excel Spreadsheet.

ActiveDSO is a ActiveX™ control, available at no charge to LeCroy customers, that enables LeCroy oscilloscopes and LSA-1000 series embedded signal analyzers to be controlled by and exchange data with a variety of Windows applications that support the ActiveX standard. MS Office programs, Internet Explorer, Visual Basic, Visual C++, Visual Java, and MATLAB (v5.3) are a few of the many applications that support ActiveX controls.

### Features:

- Generate a report by importing oscilloscope data right into Excel or Word
- Analyze waveforms by bringing them directly into MathCad
- Archive measurement results on the fly in a Microsoft Access Database
- Automate tests using Visual Basic, Java, C++, Excel (VBA)

The ActiveDSO control can be used programmatically and as an embedded control. Software designers can create instances of the ActiveDSO control within their programs, and use the control's Methods and Properties for instrument communications, setup, and data transfer. With ActiveDSO, all details of the interface bus used to connect to the LeCroy instrument are encapsulated within the ActiveDSO control. The intricacies of programming for each of these interfaces is hidden from the user, allowing the software developer to focus on his or her application and to avoid the complexities of the lower-level interface calls.

The ActiveDSO control can also be embedded visually in any OLE automation compatible client. When included in a Microsoft Word document or PowerPoint presentation, it enables users to easily transfer the bitmap image of the instrument display into the document. Whether using the control programmatically or as an embedded object, ActiveDSO helps to integrate oscilloscope data into the application:

ActiveDSO can be easily downloaded from the LeCroy website at [www.lecroy.com/tm/library/software/ActiveDSO/](http://www.lecroy.com/tm/library/software/ActiveDSO/)



## DFP2 – DIGITAL FILTER PACKAGE

### This software works with

- WaveExpert
- WaveMaster
- WaveRunner
- WavePro
- SDA
- DDA



Example of a high-pass filter, used to block power supply hum (60 Hz frequency component) from a higher frequency signal. The cutoff frequency is set to 1 kHz with a narrow transition region of 1% (very steep). F1 displays the unfiltered signal, while F2 shows the filtered result. The FFT analysis of the signal before and after the filtration is displayed by traces F3 and F4. Notice the disappearance of the 60 Hz component which is indicated by the yellow circle.

With the Digital Filter Package 2 (DFP2), LeCroy provides a completely integrated, oscilloscope-based solution. The package includes a variety of finite impulse response (FIR) and infinite impulse response (IIR) filters, in addition to User-Defined (Configurable) filter designs. The user has complete control over all aspects of filter implementation.

#### Features:

- Wide variety of standard FIR and IIR filters
- Design your own custom filter
- Quickly emulate analog filters with an IIR digital filter
- Create multirate, multistage filters with narrow spectral constraints
- Reconstruct corrupted signals by applying matched (mirror) filters to compensate for known distortions
- Can be coupled with other LeCroy analysis packages for increased power and flexibility
- Eliminates need for off-line processing for digital filter implementation

Power is enhanced by using cascaded filters to produce the desired response characteristic. In addition, the custom design feature allows the user to design unique filters tailored to specific needs using common math packages such as MATLAB, Mathcad, and Excel. DFP2 can also be coupled with other LeCroy software products, such as XMAP, JTA2, or DDM2 to provide application specific solutions. For instance, a DFP2 band-pass filter can be coupled with the JTA2 package to measure jitter over a narrow frequency range.

## DFP2 – DIGITAL FILTER PACKAGE

### Applications

The DFP option has a broad range of applications:

#### System Identification

- Telephone channel identification
- Modem echo cancellation

#### Prediction

- CDMA interference
- Adaptive CDMA receiver
- Spectral whitening

#### Noise Cancellation

- ECG noise control
- Background noise

**Low-pass filters** eliminate the accumulated high-frequency noise and interference, canceling high-frequency background noise.

**Band-stop filters** eliminate a narrow band of frequencies.

**Band-pass filters** emphasize a selected frequency band.

**High-pass filters** are useful for eliminating DC and low-frequency components.

- Applications include disk drive and optical recording (emulation of the slicing function).

**Raised cosine, raised root cosine, and Gaussian filters** are low-pass filters with unique shapes.

- Raised cosine is one of a class of filters used to minimize intersymbol interference. The time domain impulse response crosses zero at all multiples greater than one over the bit period. Harmonics of the modulation frequencies are therefore canceled.
- Applying raised root cosine twice (or, for example, at the sending and receiving end of a signal) produces the same result as a raised cosine filter.

**Custom design filters** let the user design filter responses with virtually any desired characteristics. The required custom filter can be designed with a digital filter design or math package such as MATLAB or Mathcad. Filter coefficients can be downloaded into the oscilloscope with the DSOFiler utility. This utility can be downloaded from LeCroy's Web site at [www.lecroy.com](http://www.lecroy.com).

### Low Pass Filtering Example

If the acquired signal has a shaped baseline, as shown in Figure 1, it is possible to use a low-pass filter to separate the baseline and then subtract it from the acquired waveform. In this example a low-pass filter (Trace F1) is used to extract the baseline which is then subtracted from the acquired signal in trace F2.

### Improving Signal to Noise Ratio

The acquired waveform in Figure 2 (C2) is a 12.5 MHz damped sine badly contaminated with noise. The judicious use of band-pass filtering improves the signal-to-noise ratio significantly. Note that the fast Fourier transform (FFT) displays are used to assess the effects of the filtering operation. Trace F2 shows the spectrum of the acquired signal and trace F4 shows the spectrum of the filtered signal. The band-pass filter is used to reduce the acquired signal's bandwidth to 16 MHz, thereby eliminating large noise components outside the filter's pass band. The recovered signal is shown in trace F3. While averaging could produce even better results it would require multiple acquisitions which are not always available.

DFP2 – DIGITAL FILTER PACKAGE



Figure 1



Figure 2

## DFP2 – DIGITAL FILTER PACKAGE

### Hardware Filter Simulation

The final example, shown in Figure 3, is the evaluation of a band limiting filter for a digital communications signal. In this measurement the effects of filter selection for a North American Digital Cellular (NADC) waveform are evaluated. Comparing a normally filtered signal (raised root cosine) against an unfiltered waveform with DFP filtering shows a near exact match. The user can vary the type of filter or adjust parameters to see the effect of other types of filter configurations. Channel 2 contains the NADC signal without filtering. Channel 3 is the same signal with the normal raised root cosine filter. The DFP raised root cosine filter is applied using trace F2. The overlapped traces F3 and F4 are used to compare the two versions of the signal.

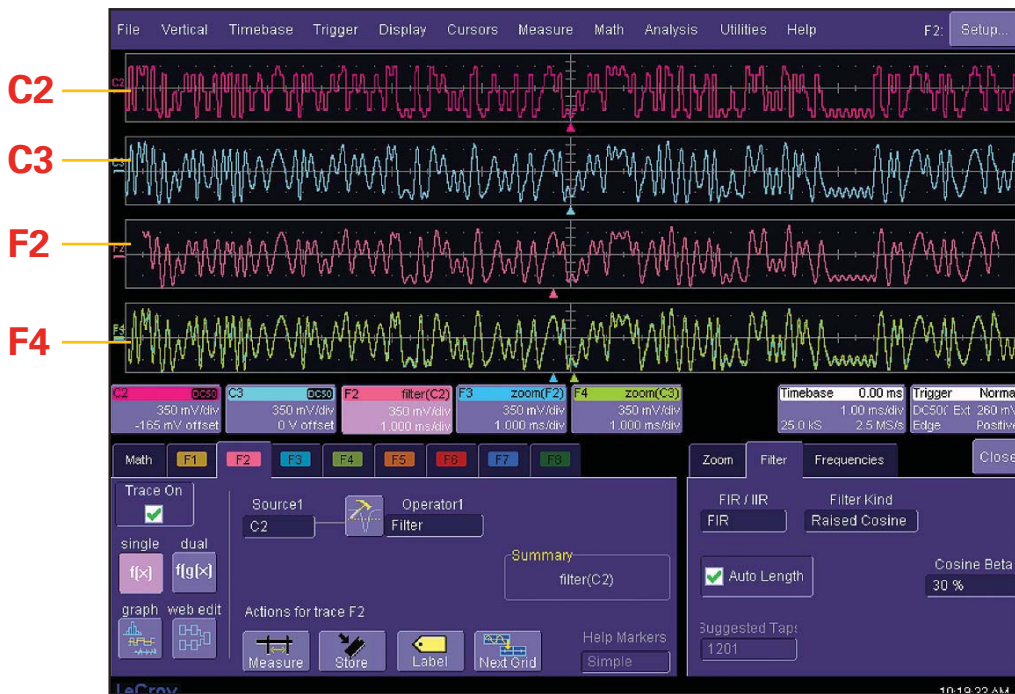

Figure 3

### SPECIFICATIONS

#### FIR

FIR Coefficients	2000 maximum
FIR Filter Types	High pass, low pass, band pass, band stop, raised cosine, raised-root cosine, Gaussian custom

#### IIR

IIR Filter Types	Low pass, band pass, high pass, band stop, custom
IIR Rolloff Selections	Butterworth, Chebyshev, Inverse Chebyshev, Bessel

### ORDERING INFORMATION

Digital Filter Software Package

### PRODUCT CODE

DFP2



## JTA2 – JITTER AND TIMING PACKAGE

### This software works with

- WaveMaster
- WaveRunner
- WavePro
- SDA
- DDA



Track of TIE@level is displayed in math function F2.

LeCroy digital storage oscilloscopes offer measurement and analysis capabilities designed to help resolve your complicated design problems.

The JTA2 software package for LeCroy oscilloscopes provides advanced jitter and timing analysis capabilities. It uses LeCroy's long memory and Zoom architecture to capture and precisely measure thousands of cycles of timing information and then present the results with three different views. View flexibility helps engineers seek out and identify the source of jitter in an electrical or electro-mechanical system.

### Features:

- A rich set of timing measurements for clock, clock-to-data, and data stream analysis
- Expanded parameters with three views of jitter, including JitterTrack™
- Persistence functions
- High-speed clock and data jitter analysis
- High-accuracy, peak-to-peak jitter measurements
- Spot modulation effects, frequency drift and other timing problems
- Flexibility of operation – to do exactly what you need

### Statistical View

LeCroy's statistical view of jitter gives insight by providing a view of the distribution of jitter. As with any noise-based phenomena, the peak-to-peak value grows as more values are measured. Therefore, anyone interested in determining worst-case timing and jitter values needs to consider the number of measurements taken in making this determination. More is better. With memory from 1M to 100 Mpts/Ch JTA2 provides the largest data population for statistical measurements.

### Spectral View

Because jitter may have various frequency components, it is important that a spectral view of jitter be available. This view often reveals critical insights into the sources of jitter. LeCroy provides a direct view of these frequency components as an FFT of jitter. Unlike FFT's of a clock signal, this provides a spectral view that is purely of the timing measurement variations.

## JTA2 – JITTER AND TIMING PACKAGE

### LeCroy JitterTrack

The key to understanding and debugging jitter is JitterTrack. Imagine that each clock period is represented by a horizontal arrow. Variations in time (of the period) are not clear at all. Now imagine that each of these arrows is flipped perpendicularly and placed time-synchronized to the individual periods they represent. The amplitude of each arrow represents the time duration of each period. By connecting the tops of those arrows, you now can see how a particular jitter measurement varies over time, perfectly synchronized to the signal being measured.

### Time Interval Error (TIE)

LeCroy oscilloscopes in conjunction with JTA2 Jitter and Timing Analysis Package can be used to test both optical and electrical communications signals. One type of analysis function which is common for both types of signals is Time Interval Error (TIE). TIE measures the position of each edge in a waveform and compares it to the position the edge would have if the waveform frequency was perfect. This analysis can reveal modulation effect, phase noise, and other sources of timing variations.

### Persistence Functions

JTA2 includes the ability to further process persistence waveform data. For example, by creating a new trace as the mean of a persistence waveform you are able to analyze the data using the parameters on the oscilloscope.

#### Parameters

period at level	TIE at level	setup
width at level	frequency at level	skew
edge at level	dv/dt	$\Delta$ period at level
duty at level	half period	$\Delta$ width at level

#### Math Processing

persistence histogram	persistence trace range
persistence trace mean	persistence trace sigma

#### Statistical and Graphical Analysis

track	histogram base	percentile
trend (20000)	high	peaks
histograms	histogram median	range
histogram parameters	histogram rms	sigma
average	low	total population
full width at half max bin	max population	x at peak
full width at x% max bin	mode	population at x
histogram amplitude		

### ORDERING INFORMATION

Jitter and Timing Analysis Software Package

### PRODUCT CODE

JTA2

XDEV – CUSTOMIZATION PACKAGE

This software works with

- WaveExpert
- WaveMaster
- WaveRunner
- WavePro
- SDA

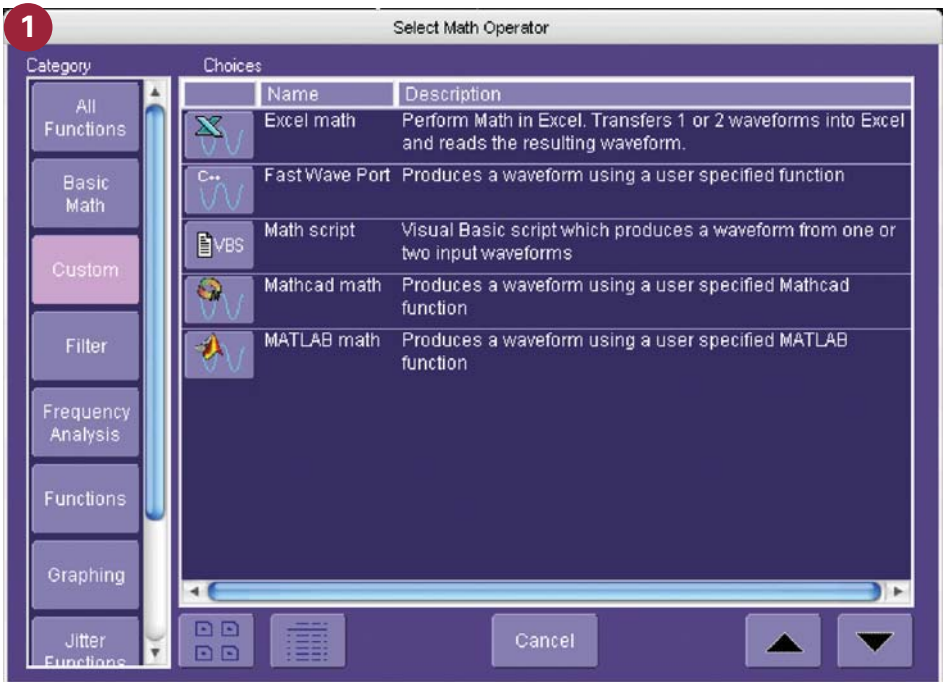

An example of XDEV Advanced Customization is shown below. 1) Select a customized algorithm. 2) Load your algorithm. 3) The calculated result is displayed on the WaveMaster oscilloscope.

XDEV Customization Package lets you modify, expand, and integrate your own measurements from within your LeCroy oscilloscope, making your design and debug time more efficient.

Only LeCroy completely integrates third party programs into the oscilloscope's processing stream by allowing you to create and deploy a new measurement or math algorithm directly into the WaveShape Analysis Engine and display the result on the oscilloscope in real-time. There is no need to run a separate program, or ever leave the oscilloscope window. XDEV Advanced Customization package enables you to extend your LeCroy X-Stream oscilloscope to include your most recent in house proprietary algorithms the same day they are created.

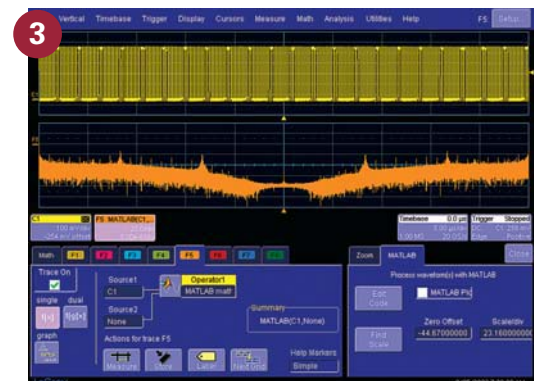
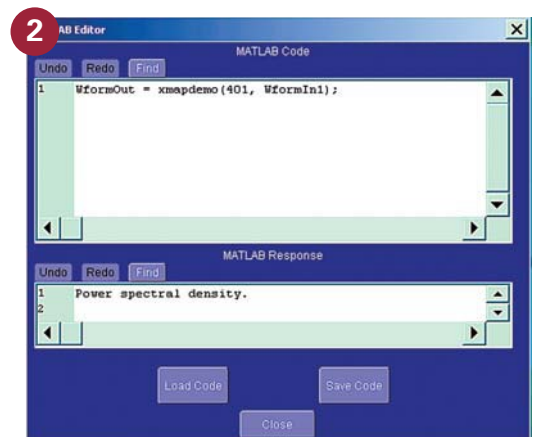

## XDEV – CUSTOMIZATION PACKAGE

### Features:

- Create and run your own measurement parameters and math functions using VBScript
- Use C/C++, and other programming languages to create your own custom algorithms
- Create your own user interface
- Support for third-party applications: Excel, MATLAB, Mathcad
- Add macro keys to run VBScript files
- Plug-in support

### Unsurpassed Customization Capability

The LeCroy X-Stream oscilloscope design incorporates a fast, robust COM-based architecture that provides a level of customization that simply cannot be approached by any other oscilloscope. It allows you to create your own script in your favorite programming language (Visual Basic, C, C++), which can then be integrated seamlessly into the WaveShape Analysis engine with the results shown on the oscilloscope display.

### Seamlessly Integrate Third-Party Applications

With the XDEV Advanced Customization package, third-party applications such as Excel, MATLAB, and Mathcad become part of your LeCroy X-Stream oscilloscope allowing you to fully integrate your measurements. Analyze your data in a third-party application installed on your oscilloscope and display the results in your LeCroy X-Stream oscilloscope.

### Create Custom Measurements and Math Functions

With XDEV you are able to create your own custom measurement parameters and math functions allowing for limitless analysis capability. Use your own proprietary measurements in the oscilloscope for faster results. Using XDEV's support for macro keys, you need only set up your measurement once and then the scope will repeat it for you, enabling you to easily run your custom VBScript files.

### Customizable User Interface

CustomDSO allows you to create setups that can be recalled by the touch of a single button. This process can be extended to include rings of three or more setups as well as trees of setups. CustomDSO also lets you add your own ActiveX™ controls to a setup, allowing you to create personalized user interfaces.

### FastWavePort

This unique processing function enables you to insert your own custom processing algorithm, written in the C/C++ language, into your oscilloscope's processing stream. FastWavePort maximizes data throughput from the acquisition system to your processing function.

### ORDERING INFORMATION

Advanced Customization Software Package

### PRODUCT CODE

XDEV



## XMAP – MASTER ANALYSIS PACKAGE

### This software works with

- WaveMaster
- WaveRunner
- WavePro
- SDA
- DDA



*XMAP combines timing analysis tools (JTA2) with complex math capability (XMATH) and advanced customization (XDEV).*

The LeCroy family of oscilloscopes take WaveShape Analysis to a whole new level by offering more measurement choices, more powerful ways to analyze the measurements and more viewing capabilities. The result is an oscilloscope that provides greater insight into signal wave shapes than has been previously available in any type of test instrument.

The highest level of WaveShape Analysis is available with the Master Analysis Package (XMAP). This option expands the basic FFT function to accommodate all acquired points, provides averaging in the frequency domain, and enables measurement of spectral power density, real and imaginary components, and frequency domain parameters. It also provides measurement of 12 additional timing parameters for jitter and timing analysis, plus time vs. time JitterTrack™ plots. Histogramming is provided for up to two billion events, and histogram measurements are enhanced through the availability of 18 parameters that statistically define the shape of the distribution. The auto-correlation function is also included.

In addition to the wider range of math functions and signal parameter measurements, XMAP also permits the user to create customized parameter measurements and custom math functions, perform parameter math (such as computing the ratio of peak power to average power or similar computations that involve addition, subtraction, multiplication or division of signal parameters), and doubles the number of math traces (from four to eight).

### Features:

- Comprehensive set of signal WaveShape Analysis tools (includes JTA2, XMATH, XDEV)
- Provides insight and speed of validation and debug process in a design
- Helps modify, expand, and integrate your own measurements from within your LeCroy oscilloscope

## XMATH - ADVANCED MATH PACKAGE

The XMATH Advanced Math Package for LeCroy X-Stream oscilloscopes provides a comprehensive set of signal WaveShape Analysis tools that offer insight into the shape of complex signals.

XMATH includes expanded histogram functions, Trend and Track, enhanced FFT capabilities, and Parameter math. XMATH lets you perform these operations over the whole signal, whether 250 points or 100 million waveform points.

### Features:

- Complete set of comprehensive signal analysis tools
- Expanded histogram functions
- Enhanced FFT capabilities
- Track graphs of any measurement parameter
- Trend up to 1 million events
- Persistence Functions
- Parameter math – add, subtract, multiply or divide two different parameters
- Auto-correlation function
- Cubic, Linear, and Sin x/x interpolation functions
- Narrow-band power measurements
- Sparse function
- Up to 8 different math functions

### Additional Features:

XMATH also gives you over 20 more parameters, including a Trend function to facilitate trending up to 1 million events, and an Auto-Correlation function which will help separate a periodic signal from noise.

### This software works with

- WaveExpert
- WaveMaster
- WaveRunner
- WavePro
- SDA
- DDA

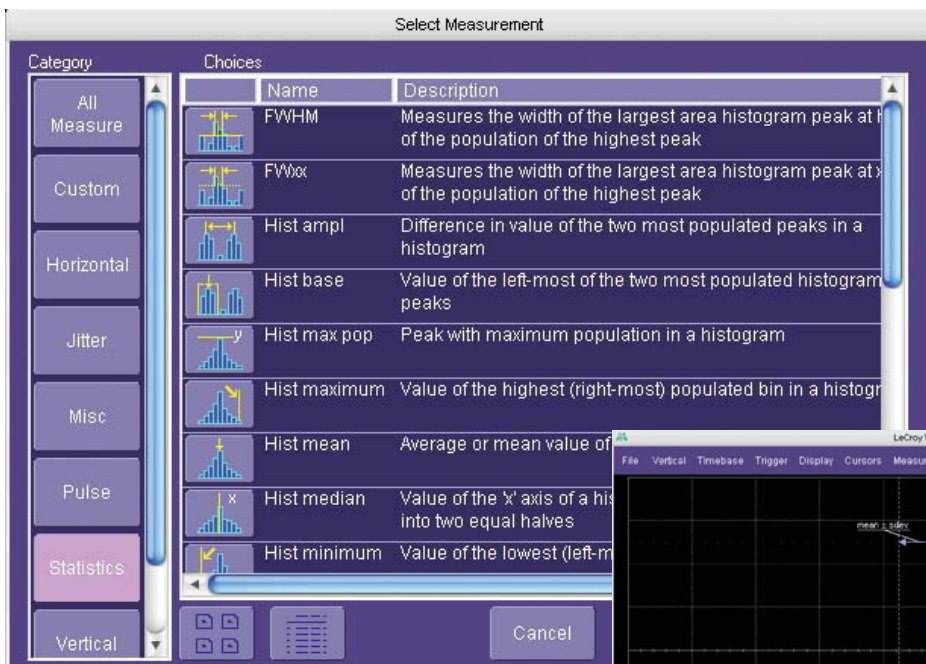

*This below histogram is showing expanded histogram measurements.*

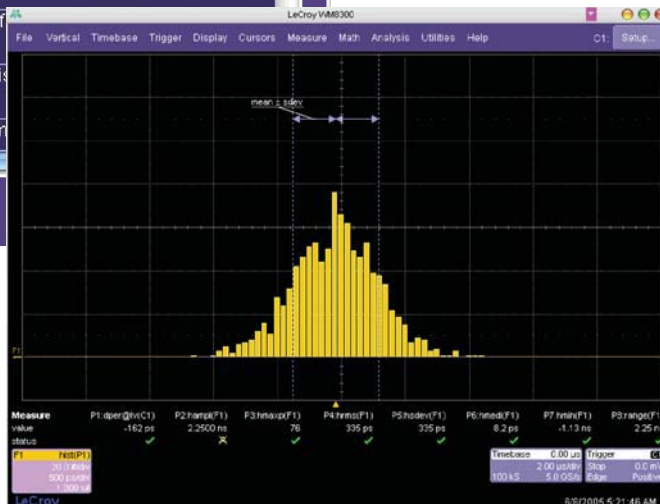

## XMATH – ADVANCED MATH PACKAGE

### Fast Fourier Transform (FFT)

When coupled with LeCroy's X-Stream architecture, XMATH's enhanced FFT capabilities allow you to do an FFT on up to 50M input points and with 5 different windows. For frequency power at a given point, XMATH provides narrow power measurements.

The FFT function's display of the frequency content of your signal will give you insight into potential problems within your circuit. LeCroy's Math on Zoom capability lets you single out problem areas of your signal and analyze the frequency content while seeing the live measure result updating on the screen.

### Histograms

An understanding of statistical variations in parameter values tells you about the range or variation of a measurement. A well-controlled design will have a narrow mean and distribution of measurements. Often, knowing the average, minimum, maximum, and standard deviation of the parameter may be enough, but a more detailed understanding of the distribution of a parameter's values can help an engineer locate anomalous behavior in a design.

### Parameter Math

XMATH allows you to do math on Parameters. Add, subtract, multiply, or divide two different parameters to extend the abilities of the oscilloscope. For example, you are able to take a measurement of the voltage of a signal and divide that by the current of the signal to find the resistance. With XMATH the result can be renamed and displayed live on the screen.

### Persistence Functions

XMATH includes the ability to further process persistence waveform data. For example, by creating a new trace as the mean of a persistence waveform you are able to analyze the data using the parameters on the oscilloscope.

### ORDERING INFORMATION

Advanced Math Software Package

### PRODUCT CODE

XMATH

## XWEB - WEB PROCESSING EDITOR

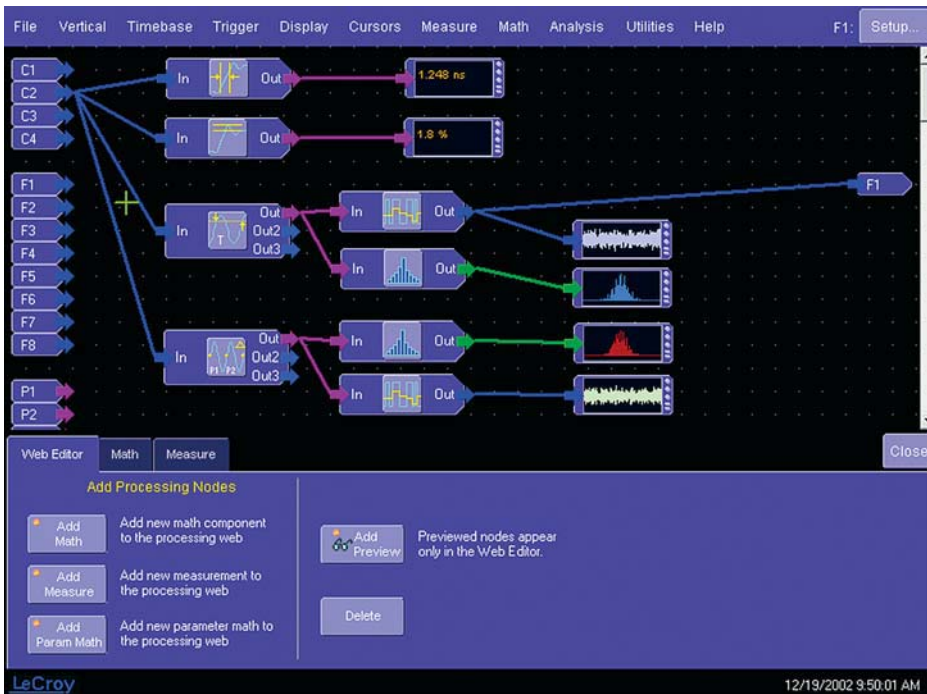

### This software works with

- WaveExpert
- WaveMaster
- WaveRunner
- WavePro
- SDA
- DDA

Drag and drop functions and measurements. Chain an unlimited number of functions together for maximum analysis power.

The processing web provides a graphical way to quickly and easily set up math functions and parameter measurements. Practically unlimited math-on-math functions can be chained together, and parameter measurements for any math output waveform anywhere on the web can be inserted.

### Features:

- Chain together any combination of Math and Measurements using a graphical editor
- Easily visualize the block diagram of custom processing configurations
- Color-coded interconnect 'wires' show data types (Waveforms, Parameters, Histograms, etc.)
- Add 'Preview Nodes' to the diagram, allowing the value/signal at intermediate nodes to be viewed.

### ORDERING INFORMATION

Processing Web Editor Software Package for Functions and Parameters

### PRODUCT CODE

XWEB



## ENET - ETHERNET TEST PACKAGE

## This software works with

- WaveMaster
- WaveRunner
- WavePro
- SDA
- DDA

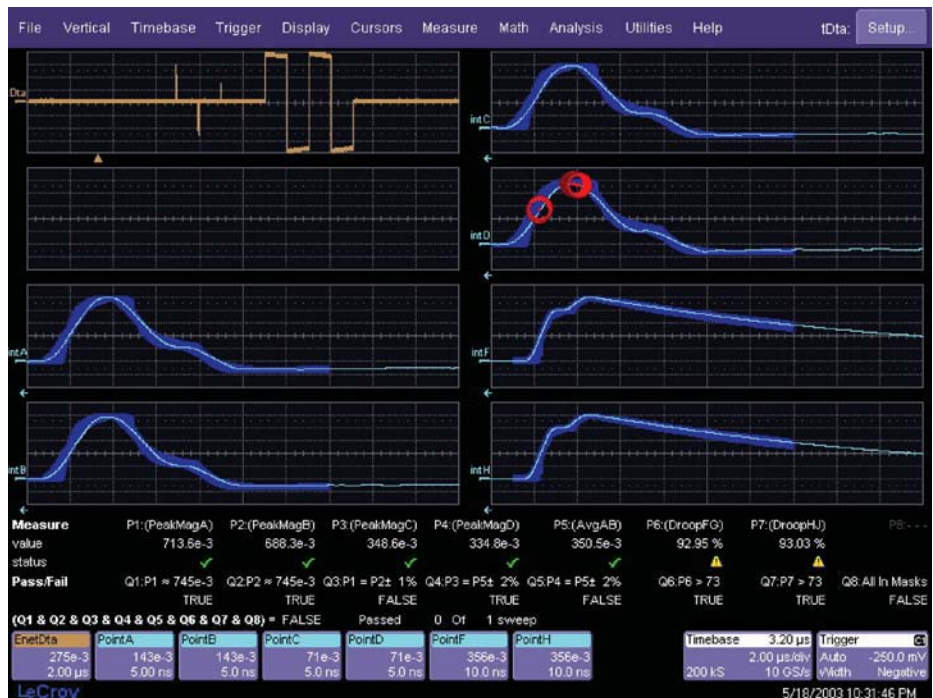

Example shows 100Base-T Mode 1 Mask Test.

ENET is a software option package that performs complete electrical testing for 1000Base-T and 100Base-TX Ethernet standards.

Jitter and pulse mask tests are performed with automatic waveform alignment, and all test results feature pass/fail indicators corresponding to the standard being tested. 10Base-T pulse mask testing is also supported, using the supplied compliance mask.

#### Features:

- Compliant with IEEE 802.3-2000 and ANSI X3.263 standards
- Eliminates the need for external math programs
- Speeds up testing by performing multiple tests on one acquisition
- Easy-to-use tests and calculations are performed inside the oscilloscope
- Complete tests for 1000Base-T and 100Base-TX, 10Base-T
- Mask testing

Document your test and compliance results with LeCroy's LabNotebook report generator.

Two test fixture kits provides for all the test loads and conditions as described in IEEE specification.

#### TF-10BT

The TF-10BT fixture set consists of four fixtures designed to support the test requirements for 10Base-T Ethernet. The fixture set includes a twisted pair model along with three test loads. The test loads include 2 reactive loads (designated load 1 and load 2 in the IEEE802.3 specification) and a 100 ohm resistive load. The loads provide connection pins for a differential probe and are compatible with WaveLink Active Differential Probes D350ST and D300A-AT from LeCroy.

ENET is supported by 2 GHz or higher bandwidth X-Stream oscilloscopes.

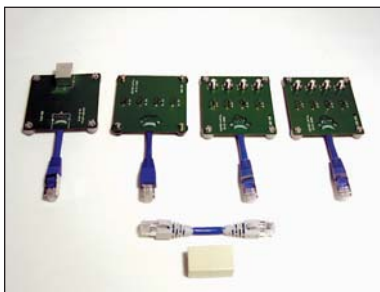

TF-10BT Fixture Set

## ENET – ETHERNET TEST PACKAGE

### TF-ENET

TF-ENET includes a set of 2 test fixtures for testing ethernet signals on twisted pair cables (UTP) for 100Base-T and 1000Base-T.

The set includes a feed-through adapter for measuring live traffic signals and a terminated fixture for off-line testing. The terminated fixture includes removable 50 ohm terminations to allow direct connection to an oscilloscope or the application of a disturbing signal. Both fixtures include pins on each wire pair for attaching a differential probe.

### SPECIFICATIONS

#### 1000BASE-T TESTS

Mode 1:	Pulse Masks, Droop
Mode 2:	Master Jitter
Mode 3:	Slave Jitter
Mode 4:	Distortion

#### 100BASE-T TESTS

Duty Cycle Distortion
Jitter
Differential Output Voltage
Rise and Fall Time

#### 10BASE-T TESTS

Mask Testing
--------------

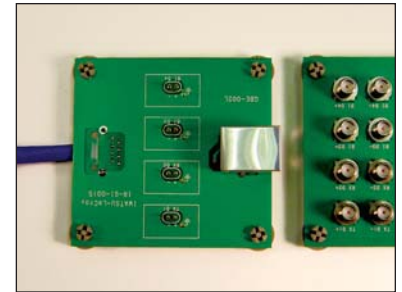

TF-ENET Fixture Set

### ORDERING INFORMATION

Ethernet Test Software Package

### PRODUCT CODE

ENET

### RECOMMENDED ACCESSORIES

WaveLink 4 GHz, Differential Probe Adjustable Tip Module	D300A-AT*
WaveLink 4 GHz, 5 V Differential Probe Small Tip Module	D350ST*
Extra Square Pin Lead for the D350ST	D350ST-SP
2.5 GHz, 0.7 pF Active Probe ( $\pm 10$ ), Small Form Factor	HFP2500
Ethernet Compliance Test Fixture for 10Base-T	TF-10BT
Ethernet Fixture for 100Base-T/1000Base-T	TF-ENET
[Includes a Set of 2 Test Fixtures Signals on Twisted Pair Cables (UTP)]	

\* For a complete probe, order a WL300 Probe Body with the Probe Tip Module.

## USB2 - COMPLIANCE TEST PACKAGE

### This software works with

- WaveMaster
- WaveRunner
- WavePro
- SDA
- DDA

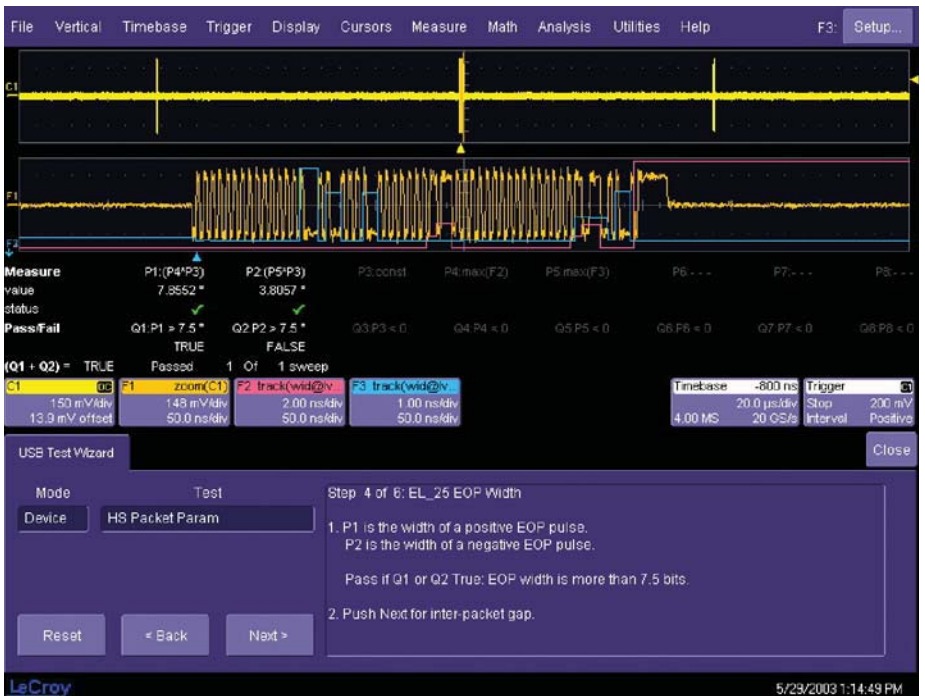

USB 2.0 Packet Parameters Test.

The USB package provides a complete acquisition and analysis system for USB 2.0 devices, hosts, and hubs, as specified in the USB-IF USB 2.0 Electrical Test Specification, version 1.0. The test software implements a full set of electrical tests for USB 2.0, including full- and low-speed tests. Ease of use is enhanced through step-by-step instructions embedded in the menu system of the application. The user is prompted when to change the test conditions and as how to interpret the test results. Each measurement is indicated by its designation within the specification, and the allowed values for each parameter are shown, as well as a pass/fail indication.

### Features:

- Complete implementation of USB-IF test procedures
- Support for host, device, and hub testing
- Easy to use step-by-step procedure embedded in user interface
- High-, Full-, and Low-speed testing included

Document your test and compliance results with LeCroy's LabNotebook report generator. LeCroy's TF-USB fixture kit provides sections for signal quality, inrush, droop, sensitivity, and disconnect. Supports full, low, and high-speed tests.

USB is supported by 3 GHz or higher bandwidth X-Stream oscilloscopes.

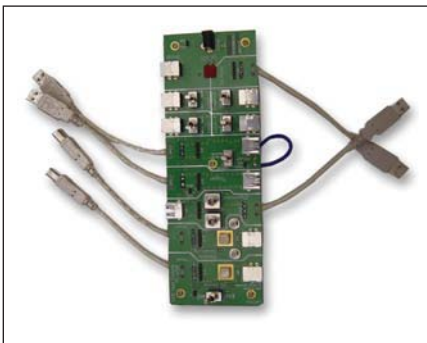

TF-USB Fixture Kit.

## USB2 – COMPLIANCE TEST PACKAGE

### SPECIFICATIONS

HS Signal Quality  
 HS Packet Parameters  
 HS J/K Chirp Timing  
 Suspend/Resume/Reset Timing  
 Inrush Current  
 Disconnect  
 Droop  
 LS and FS Signal Quality  
 Hub Repeater Tests

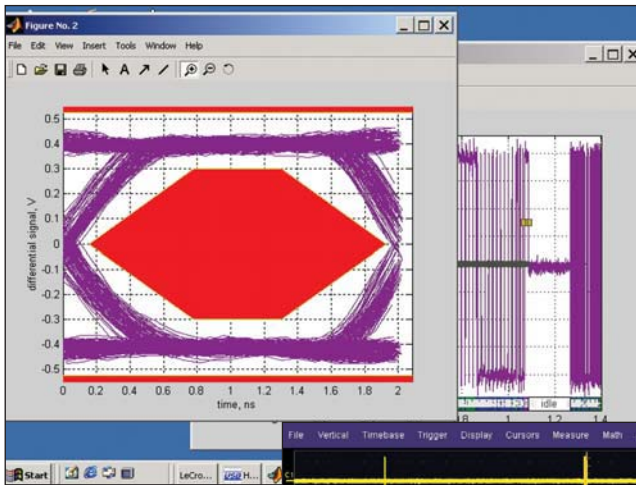

Signal quality tests are performed using the USB-IF MATLAB test scripts. Results are automatically stored in HTML format on the instrument.

The user interface features step-by-step instructions for all tests, along with pass/fail indications.

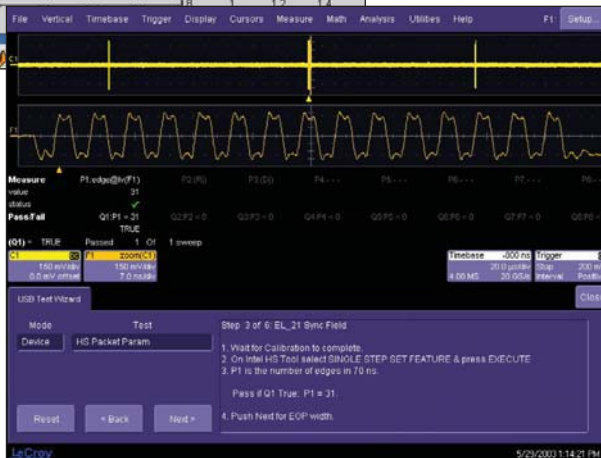

D350ST probe in TF-USB fixture.

### ORDERING INFORMATION

USB 2.0 Compliance Test Software Package

### PRODUCT CODE

USB2

### RECOMMENDED ACCESSORIES

2.5 GHz, 0.7 pF Active Probe ( $\pm 10$ ), Small Form Factor	HFP2500
Wavelink 4 GHz, Differential Probe Adjustable Tip Module	D300A-AT*
Wavelink 4 GHz, 5 V Differential Probe Small Tip Module	D350ST*
Wavelink ProBus Probe Body	WL300
1 M $\Omega$ Adapter includes PP005A Passive Probe	AP-1M
USB 2.0 Testing Compliance Test Fixture	TF-USB

\* For a complete probe, order a WL300 Probe Body with the Probe Tip Module.



## SDA-HDMI - COMPLIANCE TEST

## This software works with

- SDA
- WaveMaster

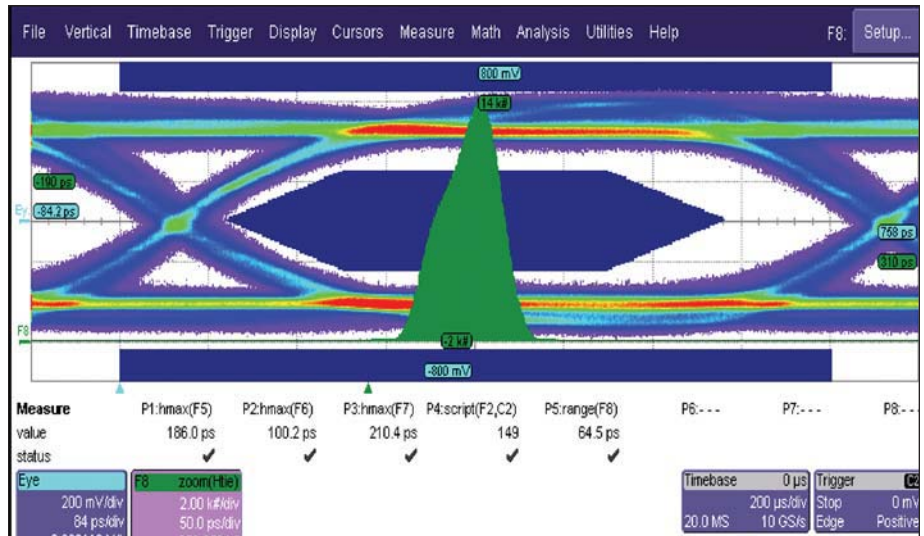

An Innovative Compliance Test Tool

The SDA-HDMI software package for the SDA family of Serial Data Analyzers provides a concise set of validation/verification and debug tools written in accordance with High Definition Multimedia Interface (HDMI) electrical test specifications. Covered HDMI test modes include Source and Cable Tests covering amplitude-timing, and jitter parameters as well as cable impedance tests.

In addition to standard eye pattern and jitter tests for HDMI, the SDA real-time test equipment platform provides a complete set of amplitude and jitter measurements, as defined in the HDMI specification. This combination of measurements makes SDA-HDMI a cost-effective, compelling HDMI solution.

Additionally, the SDA-HDMI software package takes advantage of all the user-acclaimed test and measurement tools available in LeCroy's instruments:

- **D350ST-SP, WaveLink 4 GHz Bandwidth Probing System** – available in SP (square pins) input or Solder-In (SI) configurations, for a choice between versatility and the highest signal integrity with the lowest probe loading across the entire bandwidth range.
- **Jitter Wizard Tool** – part of ASDA-J Advanced Serial Data Analysis package ensures proper jitter measurement setup, allowing for correlation with other test instruments such as BERT, Sampling oscilloscopes or time interval analyzers (TIAs).

**Features:**

- Backward compatible with Digital Video Interactive (DVI)
- Based on same TDMS Serial Data Link developed by Silicon Image
- HDMI supports standard, enhanced, or high-definition video, plus multi-channel digital audio on a single cable
- HDMI was designed specifically for consumer electronics applications, it offers an array of additional consumer enhancements
- Amplitude, Timing, Jitter and Cable Measurements
- Custom Clock recovery supports Filtered Jitter measurements
- Supports a variety of cable configurations and test fixture scenarios

## SDA-HDMI – COMPLIANCE TEST

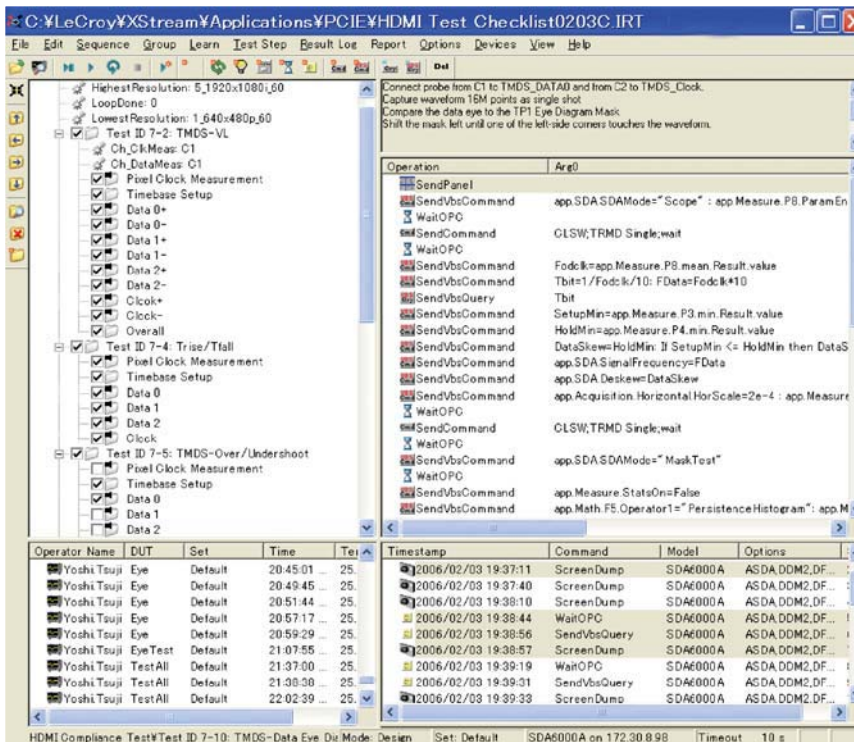

As hardware designers are quick to recognize, measurement results often need to be summarized and tabulated for quick specification verification. SDA-HDMI goes a leap beyond by incorporating a unique application framework, where every experimental result is saved in XML, format directly compatible with most popular database applications. A report generation engine interfaces with the underlying Microsoft® Access-compatible database to facilitate custom text and graphics based reports. Sample applications that stand to benefit the most from the new software framework include, but are not limited to:

- **Chipset developers** who require comprehensive silicon characterization to define parametric performance and establish device performance capability.
- **Device development teams** working in parallel development cycles who need to combine, study, and interpret performance data and correlate with prior design runs
- **Manufacturing/Production test environments** where key performance parameters are monitored using control charts or other in-process indicators of device performance

## SDA-HDMI - COMPLIANCE TEST

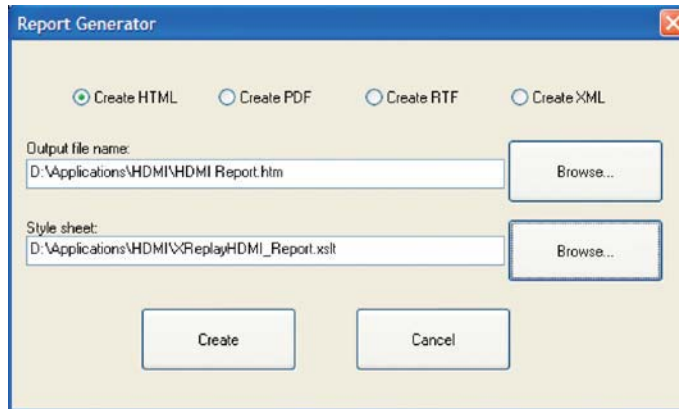

Test Report

### Powerful Debugging Tools Ensure HDMI Connectivity

Clock recovery circuitry and clock extraction via Phase-Locked Loops (PLLs) is another significant design consideration. The flexible clock recovery options in the SDA allow for the simulation of virtually any real receiver PLL configuration, thus allowing the simulation of “what if” scenarios. Jitter results can be measured exactly as the receiver would see them.

### Comprehensive and Easy- to-Read Test Reports

As hardware designers are quick to recognize, measurement results often need to be summarized and tabulated for quick specification verification. These test results, together with instrument and signal acquisition/test condition setups, create a fully documented record. SDA-HDMI incorporates a multiple-format report generation engine. This test report contains tabulated numerical values for each individual test result including PASS/FAIL and specification limit columns.

ID	Pass/Fail	Comment
7-2 TMDS-VL	Pass	VL_Max4 = 2.859V D0+ = 2.850V, D0- = 2.854V D1+ = 2.854V, D1- = 2.854V D2+ = 2.859V, D2- = 2.863V CK+ = 2.859V, CK- = 2.854V
7-4 TMDS-Trise, Tfall	Pass	Trise D0: 261.694psec ( 0.194Tbit ), 226.962psec ( 0.169Tbit ) D1: 261.718psec ( 0.194Tbit ), 228.964psec ( 0.170Tbit ) D2: 223.525psec ( 0.166Tbit ), 205.506psec ( 0.153Tbit ) CK: 256.343psec ( 0.190Tbit ), 258.444psec ( 0.192Tbit )
7-5 TMDS-Over/Undershoot	Pass	Overshoot = 9.901% Undershoot = 17.822%
7-6 TMDS-Inter_Pair Skew	Pass	TIPSKEW_MAX = 5.379E -02Tpixel D0-D1: 0.000Tpixel D1-D2: 4.306E -02Tpixel D0-D2: 5.379E -02Tpixel D1-CK: 4.158E -02Tpixel D0-CK: 4.306E -02Tpixel D2-CK: 4.306E -02Tpixel

HDMI Test Report (Partial)

## SDA-HDMI – COMPLIANCE TEST

### Advanced Real-time Jitter and Eye Pattern Analysis

While the SDA instrument family includes the ability to measure jitter and eye patterns in real time, the SDA-HDMI package leverages the Advanced Serial Data Analysis Library (ASDA-J), which provides ultimate control of PLL design, jitter measurement conditions that include detailed Data Dependent Jitter (DDj) breakdown and also bit error rate (BER) analysis. The SDA provides pinpoint accuracy for eye mask violations locator, even in the presence of SSC.

### SPECIFICATIONS

#### Fixtures Used:

- TPA-P-D – Differential Test Fixture
- TPA-P-SE – Single Ended Test Fixture

#### Source Device (SDA Series)

Test Number	Description
Test 7-2	TMDS-VL
Test 7-4	TMDS-TRISE, TFALL
Test 7-5	TMDS-Over/Undershoot
Test 7-6	TMDS-Inter-Pair Skew
Test 7-7	TMDS-Intra-Pair Skew
Test 7-8	TMDS-Clock Duty Cycle
Test 7-9	TMDS-Clock Jitter
Test 7-10	TMDS-Data Eye Diagram

#### Cable Test (SDA Series)

Test Number	Description
Test 5-3	TMDS-Data Eye Diagram

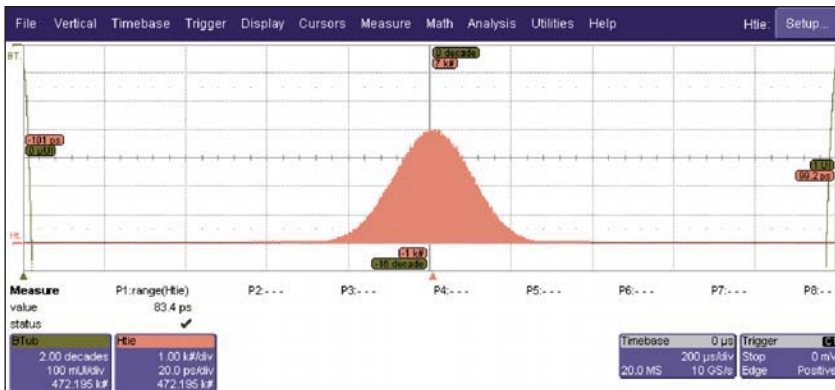

ASDA-J Jitter Analysis

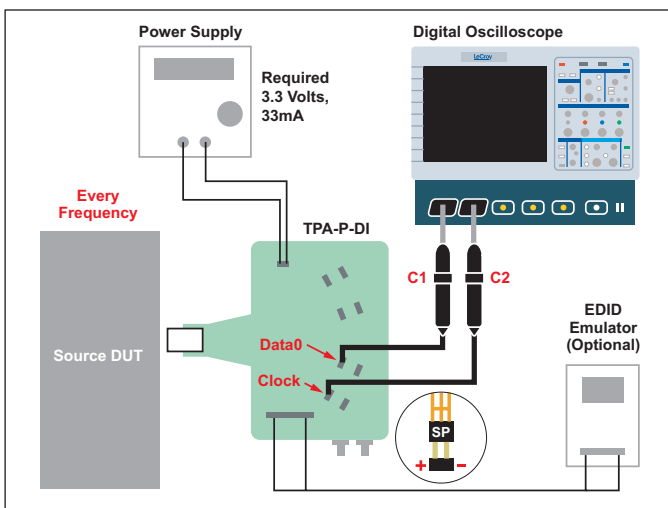

Typical HDMI Test Configuration



## SDA-HDMI - COMPLIANCE TEST

SDA-HDMI software package includes all the software required to run HDMI compliance tests on the SDA/WaveMaster 4 GHz and higher bandwidth real-time oscilloscope family.

### ORDERING INFORMATION

### PRODUCT CODE

#### Product Configuration

HDMI Compliance Test Software Package

SDA-HDMI

#### Recommended System Configuration for HDMI Compliance Tests

#### HDMI SOLUTION SYSTEM CONFIGURATION

4 Ch; 4 GHz Serial Data Analyzer; 10 GS/s; 20 Mpts/Ch; 20 GS/s, 100 Mpts/Ch for 2 or 1 Ch	SDA 4000A XXL
WaveLink 4 GHz, 5 V Differential Probe Small Tip Module	D350ST*
Extra Square Pin Lead for the D350ST	D350ST-SP
HDMI Compliance Test Software Package	SDA-HDMI
HDMI Test Fixture Kit contains TPA-P-DI Differential Test Fixture and TPA-P-SE Single Ended Test Fixture	TF-HDMI

\*For a complete probe, order a WL300 Probe Body with the Probe Tip Module.

## SDA-SAS COMPLIANCE TEST PACKAGE

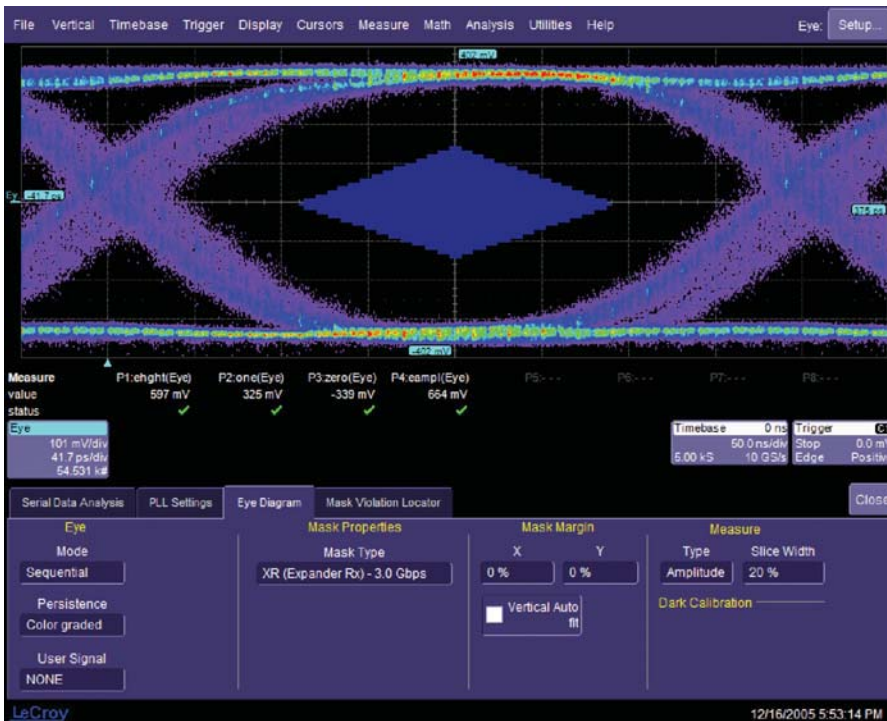

SAS Eye Diagram

This software works with

- WaveMaster
- SDA
- DDA

### An Extensive Design and Validation Tool

The SDA-SAS software package for the LeCroy Serial Data Analyzers provides an extensive set of validation, verification and debug tools written in accordance with SAS I (1.5 Gb/s) and SAS II (3 G/s electrical specifications). Covered SAS test modes include Internal, Short Backplane and External Desktop Applications, and Extended, System-to-System Applications.

In addition to standard eye pattern and jitter tests, the SDA-SAS solution provides a complete set of amplitude and jitter measurements, as defined in the Serial Attached SCSI II specification. **This combination of measurements makes SDA-SAS the only commercially available automated test suite that meets the requirements for multiple data transfer rates.**

In addition, SDA-SAS software benefits from all the user-acclaimed test and measurement tools available in LeCroy's instruments:

- **D11000PS High Bandwidth Probing System**

Available in dual-SMA input or Solder-In configurations, for a choice between versatility and the highest signal integrity with the lowest probe loading across the entire bandwidth range.

- **Jitter Wizard Tool**

Standard in the SDA 11000, ensures proper jitter measurement setup, allowing for correlation with other test instruments such as Bit Error Rate Test (BERT), Sampling oscilloscopes, or Time Interval Analyzers (TIAs).

- **SAS Protocol Solutions by LeCroy**

The LeCroy SAS *Tracer/Trainer* system, with both host emulation and traffic generation capabilities, is supported by the new LeCroy SDA-SAS development environment—and is used in Compliance Jitter Tolerance Pattern (CJTPAT) for signal integrity measurements.

## SDA-SAS COMPLIANCE TEST PACKAGE

### Features:

- Test and Validation for SAS configurations from 1.5 Gb/s up to 6 Gb/s
- Test Suite conforms to UNH-IOL Methods of Implementation (MOI)
- Built-in support for upcoming Serial Attached SCSI (SAS) Expander technology running at 6 Gb/s
- Flexible, powerful suite of test tools for Physical Layer Device (PHY) layer
- Amplitude, Timing, and Jitter Measurements
- Integrated support for LeCroy SAS *Tracer/Trainer*™ Protocol Analysis Tools
- Custom Clock recovery supports Filtered Jitter measurements
- Supports a variety of cable configurations and test fixture scenarios

As hardware designers are quick to recognize, measurement results often need to be summarized and tabulated for quick specification verification. SDA-SAS goes a step beyond by incorporating a unique application framework, where every experimental result is saved to a database and, using the Export to XML utility, can be made available in a universally compatible format. A report generation engine interfaces with the underlying database to facilitate custom text and applications that stand to benefit the most from the new software framework including, but are not limited to:

- Chipset developers who require comprehensive wafer/die characterization to define parametric performance and establish device performance capability
- Device development teams working in parallel development cycles who need to combine, study, and interpret performance data and correlate with prior design runs
- Manufacturing/Production test environments where key performance parameters are monitored using control charts or other in-process indicators of device performance

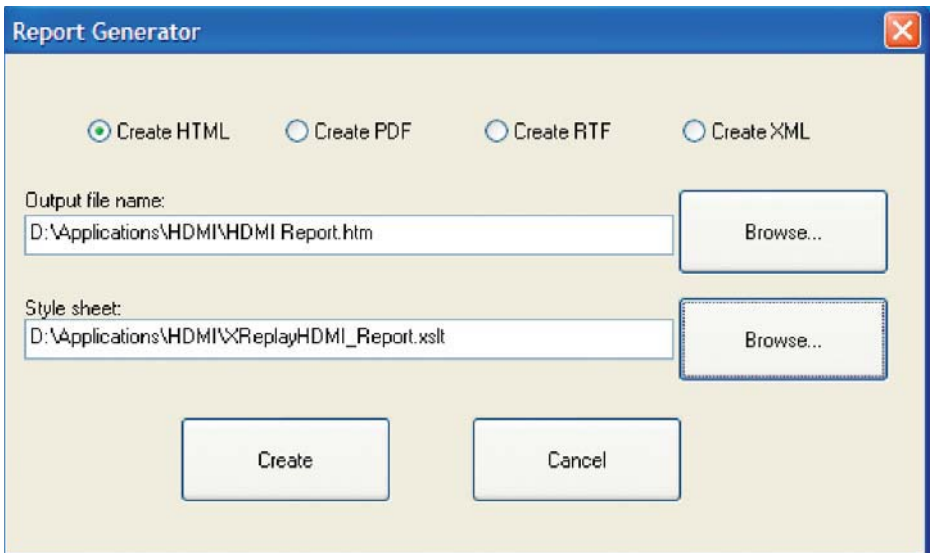

*Test Report*

## SDA-SAS COMPLIANCE TEST PACKAGE

### Powerful Debugging Tools that will Ensure Future SAS 6G Connectivity

In order to validate existing cable technology to support transmission of high-speed differential signals, selective pre-emphasis/de-emphasis may have to be implemented in the electrical signal to ensure error-free transmission.

SDA-SAS will evolve as these requirements are defined to meet these needs.

Similarly, ensuring backward compatibility with legacy SAS infrastructure such as external SAS cables requires the use of advanced characterization tools.

The use of SDA-SAS, in conjunction with the deep memory and powerful analysis library of the SDA instrument family, greatly simplifies the verification process.

Clock recovery circuitry and clock extraction by Phase-Locked Loops (PLLs) is another significant design consideration. The flexible clock recovery options in the SDA allow for the simulation of virtually any real receiver PLL configuration, thus allowing the simulation of "what if" scenarios. Jitter results can be measured exactly as the receiver would see them.

### Comprehensive and Easy to Read Test Reports

These test results, together with instrument and signal acquisition/test condition setups, create a fully documented record. SDA-SAS incorporates an automatic HTML report generation engine. This test report contains tabulated numerical values for each individual test result, including PASS/FAIL and specification limit columns.

Bit rate of the DUT transmitter device

**Pass**

Test Item: BitRate  
Current Value: 2999970363.25524  
Test Criteria: +/- 3e5

Total jitter of the DUT transmitter device using the Zero-Length Test Load

**Pass**

Test Item: TjMax  
Current Value: 141.41 pS  
Test Criteria: < 183.33 pS

Deterministic jitter of the DUT transmitter device using the Zero-Length Test Load

**Pass**

Test Item: DjMax  
Current Value: 24.00 pS  
Test Criteria: < 116.67 pS

Total jitter of the DUT transmitter device using the TCTF Test Load

SAS Test Report (Partial)



## SDA-SAS COMPLIANCE TEST PACKAGE

### Advanced Real-time Jitter and Eye Pattern Analysis

While the SDA instrument family adds the ability to measure jitter and eye patterns in real time, the SDA-SAS package leverages the Advanced Serial Data Analysis library (ASDA-J). Some of the advanced tools provided in ASDA-J include custom PLL filter design, jitter measurement methods and Bit Error Rate (BER) analysis. The SDA provides pinpoint accuracy for eye mask violation locator, even in the presence of Spread Spectrum Clocking (SSC).



### SPECIFICATIONS

#### OOB Signaling Tests

Test Number	Description
Test 5.1.1	TX Maximum Transients
Test 5.1.2	RX Maximum Transients
Test 5.1.3	TX Device Off Voltage
Test 5.1.4	TX OOB Offset Delta
Test 5.1.5	TX OOB Common Mode Delta
Test 5.1.6	TX Minimum OOB AlignBurst Amplitude
Test 5.1.7	TX Maximum Noise During OOB Idle

#### SAS Signaling Tests

Test Number	Description
Test 5.2.1	TX Bit Rate
Test 5.2.2	TX Jitter
Test 5.2.3	TX Output Imbalance
Test 5.2.4	TX Rise and Fall Times
Test 5.2.5	TX Skew

#### Fixtures Used:

- Transmitter Transient Test Circuit
- Receiver Transient Test Circuit
- Zero-length Test Fixture
- TCTF Test Load

## SDA-SAS COMPLIANCE TEST PACKAGE

The SDA-SAS configurations include all software required to run the SAS software on the SDA Series. For customers who own an SDA 6000A XXL/6020A, SDA-SAS is compatible up to 3 Gb/s. For SAS 6G applications, the SDA 11000 or higher bandwidth real-time oscilloscope is required.

### ORDERING INFORMATION

### PRODUCT CODE

SAS I/II Solution Analysis Software Package

SDA-SAS

### RECOMMENDED SOLUTION FOR SAS 3G/6G

#### SAS Solution System Configuration

4 Ch 11/6 GHz Serial Data Analyzer; 11 GHz, 40 GS/s 16 Mpts in 2 Ch mode; 6 GHz, 20 GS/s 8 Mpts in 4 Ch mode	SDA 11000
Differential Probe System (for SDA 18000, SDA 11000, SDA 9000 only)	D11000PS
SAS I/II Solution Analysis Software Package	SDA-SAS
SAS SA <i>Tracer/Trainer</i> 3G 1 Port Analyzer/Exerciser System (includes CATC 10K platform, SA <i>Tracer</i> 3G 1 Port Module, SA <i>Trainer</i> 3G Traffic Generator Module)	SA005APA-X

## SDM – SERIAL DATA MASK PACKAGE

## This software works with

- WaveMaster
- WaveRunner
- WavePro
- SDA (Standard)
- DDA

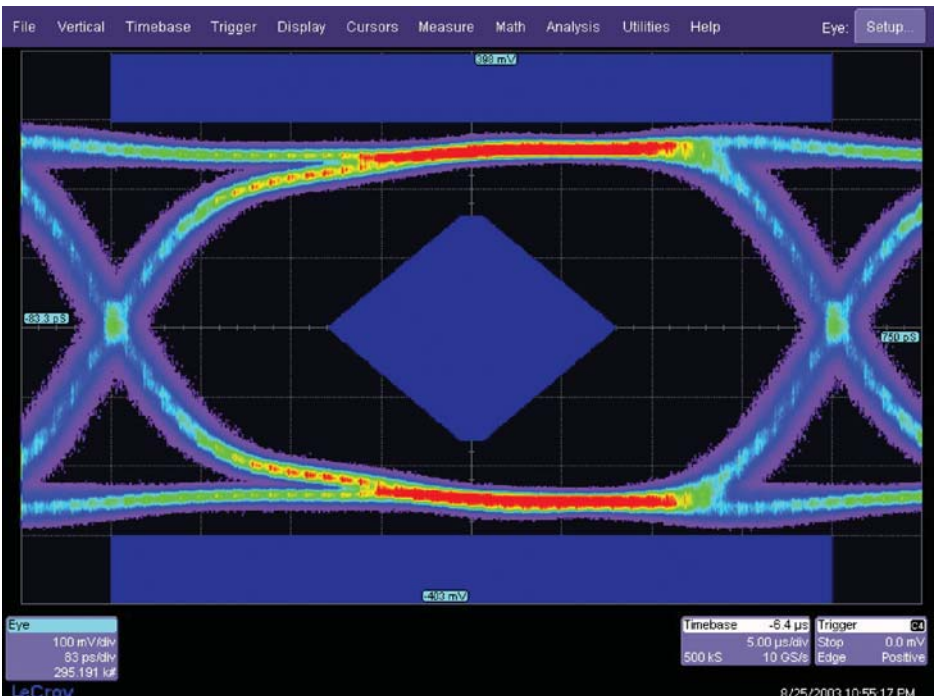

*Eye pattern of serial ATA signal.*

The SDM serial data mask package for LeCroy oscilloscopes adds eye pattern mask testing capability to oscilloscopes that are occasionally used to measure serial data streams.

The SDM package measures eye patterns by acquiring a long record of waveform data from the data stream under test. Once in the oscilloscope's memory, a software algorithm computes a reference clock from the signal data which tracks the long-term variations in the data rate in the same way as a "GOLDEN" PLL does in hardware. The loop bandwidth of this software golden PLL is adjustable as a ratio of the measured bit rate. This ratio is variable from 1/20 to 1/10,000. Mask violations are counted and indicated by red circles in the display. The mask margins are adjustable both vertically and horizontally.

The software capabilities included in the SDM package are standard features in LeCroy's SDA (Serial Data Analyzer) Series.

#### Features

- Software clock recovery eliminates trigger jitter
- Measure data rates up to 3.5 Gb/s
- Automatic mask alignment
- Adjustable mask margins
- Creation of user-defined masks

#### Support for Multiple Standards

The user selects compliance masks from a comprehensive list of standards and the eye pattern is tested against this mask. User-defined masks are also possible by simply editing the included data base file. The eye pattern is automatically aligned with the compliance mask.

All of the data for the eye pattern are collected in a single acquisition thus completely eliminating any trigger jitter from the measurement.

## SDM – SERIAL DATA MASK PACKAGE

### Pulse Mask Testing

Telecom signals such as DS1, DS3 and E1, require mask template testing for compliance. The SDA software package includes this type of testing as standard. Pulse masks are available for T1 and ITU communications signals up to 155 Mb/s. User defined masks are also possible by editing the mask data base file.

Pulse mask tests include automatic pass/fail detection and a readout of total failures as well as the ratio of failed sweeps. The sweep count is variable from 1 to 10e9. Multiple actions on failure are selectable including print, store, and trigger external equipment.

### SPECIFICATIONS

#### SOFTWARE CLOCK RECOVERY

**PLL bandwidth:** .05 to 10<sup>-5</sup> of the Data Rate

**Jitter:** 1ps rms typical (based on the WaveMaster sampling clock stability)

**Data rates:** Less than 3.5 Gb/s

#### STANDARD MASKS

##### SONET/SDH

OC1/STM0 • OC3/STM1 • OC12/STM4 • OC48/STM16

##### Ethernet IEEE Std. 802.3 and ANSI X3.263-1995

1000Base-SX Short Wave Optical

1000Base-LX Long Wave Optical

##### Fibre Channel Electrical

FC133E, FC266E, FC531E, FC1063E

Fibre Channel Optical

FC1063

##### IEEE 1394b (draft)

S400 Optical • S400b T1 • S400b T2 • S800 Optical • S800b T1 • S800b T2

S1600 Optical • S1600b T1

##### Serial ATA (draft)

G1, G1 Rx, G1 Tx

G2, G2 Rx, G2 Tx

DVI (rev. 1.0)

Transmit Normalized,

Receiver Low/High

##### InfiniBand (draft)

2.5 Gb/s Optical

2.5 Gb/s Electrical

#### PULSE MASKS

##### ANSI T1

DS-1, DS-3, STS-1, STS-3E

##### ITU-T

E1, E2, E3, E4, STM1-E

### ORDERING INFORMATION

Serial Data Mask Software Package

### PRODUCT CODE

SDM

### RECOMMENDED ACCESSORIES

Optical-to-Electrical Converter, 500–870 nm ProBus BNC Connector	OE425
Optical-to-Electrical Converter, 950–1630 nm ProBus BNC Connector	OE455
Optical-to-Electrical Converter, 500–870 nm ProLink BMA Connector	OE525
Optical-to-Electrical Converter, 950–1630 nm ProLink BMA Connector	OE555





## DDA 5005A/DDA 5005A XXL/DDA 3000

Since their inception, Disk Drive Analysis (DDA) Series oscilloscopes have helped data storage design engineers improve the time to market of new products and accelerated understanding and failure analysis on existing drives. LeCroy continues that tradition with its powerful Disk Drive Analysis toolset, enabling you to capture, view, and analyze the waveshape of high-speed, complex drive signals with speed and integrity. LeCroy's X-Stream architecture integrates SiGe "digitizer on a chip" technology and a specialized high-speed streaming bus design to transfer data from the ADC to a proprietary acquisition memory. The X-Stream architecture enables disk drive engineers to quickly, easily, and accurately measure and analyze disk drive signals.

The DDA 5005A is designed for signal fidelity, whole track acquisition and analysis for read channel, media noise analysis, and head parametrics with the longest acquisition memory standard. The DDA 3000 provides the same measurement capability at a lower bandwidth. This unique product has the convenience of selectable 50  $\Omega$  or 1 M $\Omega$  inputs.

### Features:

- 3 or 5 GHz bandwidth
- 10 GS/s sample rate/channel
- 20 GS/s dual-channel mode
- Up to 100 Mpts in dual-channel mode
- 3 or 5 GHz trigger bandwidth
- Intuitive front panel and touch screen interface
- Zoom and Multi-Zoom on disk sectors
- One-button access to Read Channel Emulation, Servo Analysis, and Disk Triggers
- Head Equalization, Channel Emulation, and SAM Histograms
- Segmented Memory for sector-by-sector parametric analysis
- Built-in PWxx, amplitude, pulse shape, and ACSN parametric measurements
- Customizable with MATLAB, Mathcad, Visual Basic, or Excel scripts
- Flexible connectivity to networks, peripherals with 100Base-T Ethernet, and USB

### Excellence in Head, Disk, Track, and Noise Analysis

The DDA Series analyzers incorporate the tools to make you the most efficient. The standard 100 Mpts of capture memory in the DDA 3000 (2 channel mode) and DDA 5005A XXL provides 5 milliseconds of single-shot 20 GS/s capture on two channels, allowing multiple drive sectors to be acquired at once.

### Long Memory and Flexibility in Finding Problems

Acquire a head signal up to 5 GHz, and then QuickZoom it from the front panel. The DDA copies and expands the drive signal automatically. Simply scroll horizontally and vertically to examine any sector. Multiple zooms let you view up to eight separate areas of the head signal; each zoom comes in a distinct color. You can measure the time between two events accurately with horizontal and vertical cursors. Disk drive parameters let you characterize the pulse width variation or signal-to-noise ratio across a selectable region. Failure Analysis engineers can store and recall golden waveforms and panel setups to compare problem drives with the known good drives. Analog-to-digital converters running at speeds up to 20 GS/s ensure the right sensitivity to measure today's high-speed read channels. In every DDA, you can run your customer-developed scripts to view the captured signal with the filters matched to your channel and media. Custom user scripts can be created in MATLAB, Mathcad, Visual Basic, or even Excel.



DDA 5005A



DDA 3000

### WaveScan Advanced Search

#### Locate Problems Triggers Won't Find

*WaveScan is a powerful tool that provides the ability to locate unusual events in a single capture, or scan for an event in many acquisitions over a long period of time using more than 20 different search/scan modes. WaveScan uses measurement-based scanning modes, like frequency, to show statistical distribution of events. It overlays events for a quick and simple visual comparison.*

## DDA 5005A/DDA 5005A XXL/DDA 3000

### Exceptional Trigger Performance

Disk Triggers allow you to set up a series of events in the signal that then cause a trigger. For example, qualify the signal on the index signal and then capture all the sectors of information on the track. As memory is increased in the DDA, more sectors can be captured, with up to 50 picosecond/sample time resolution. Up to 25,000 sectors of data can be gathered with the DDA 3000 or DDA 5005A XXL.

### Natural Graphical Interface

One press of the DDA button takes you directly to the Disk Drive Analyzer features. The familiar controls on the front panel, coupled with a natural, context-sensitive graphical user-interface, react quickly to your commands. Functionality is exactly where you expect it to be. If you have questions, context-sensitive on-line help gives immediate assistance.

### Cursors

Cursors let you measure time and amplitude points on the disk waveforms. You can measure the time between gate and signal across two different channels. Different cursor modes are easily recalled and set. They are easily accessed from the front panel or the graphical user interface. Set up basic time or amplitude cursors on a single waveform, or choose to use independent cursors on different waveforms.

### ProLink Signal Inputs (DDA 5005A Analyzer)

ProLink inputs provide a high integrity, high bandwidth interchangeable interface to SMA or BNC cables, probes, and accessories. ProLink supports ProBus for direct, automatic control of LeCroy probes and accessories. The optional AP-1M adapter provides Hi-Z input.

### Flexible Connectivity

The DDA Series comes complete with a 100Base-T/10Base-T Ethernet connection and a built-in hard drive for waveform storage. At the press of a button, you can even e-mail the measurement result and waveform display to other engineers or to your notebook. Attach any USB device for extended connectivity for network printing, or for attaching additional storage or pointing devices.

### Math Tools

Displays up to eight math function traces (F1-F8); The easy to use graphical interface simplifies setup of up to two operations on each function trace. Function traces can be chained together to perform math-on-math. Capabilities include:

absolute value	FFT	resample (deskew)
average (summed)	floor	rescale (with units)
average (continuous)	identity	roof
difference (-)	integrate	Sin x/x, square
differentiate	log (base e)	square root
enhanced resolution (to 11 bits vertical)	log (base 10)	sum (+)
envelope	negate,	histogram
exp (base e)	product (x)	trend (datalog)
exp (base 10)	ratio (/)	Auto-correlation
	reciprocal (invert)	

FFT includes: power averaging, power density, real and imaginary components, and frequency domain parameters.

## DDA 5005A/DDA 5005A XXL/DDA 3000

### Pass/Fail

Test waveforms by comparing their shape to test templates, and simultaneously check multiple parameters versus selectable parameter or mask limits. Pass or fail conditions can initiate actions including document to local or networked files, or e-mail the image of the failure, save waveforms, or send a GPIB SRQ, or pulse to trigger another device.

### Automated Disk Drive Measurements

TAA	lmax	lttp
TAA+	lmin	ltut
TAA-	lnum	NLTS
PW50	lpp	ACSN
PW50+	ltbe	msnr
PW50-	ltbp	rsnr
Resolution	ltmn	m_to_r
Overwrite	ltmx	nbph
lbase	ltot	nbpw
lbsep	ltpt	

### Standard Automated Measurements

amplitude	maximum	phase
area	mean	time @ minimum (min.)
base	minimum,	time @ maximum (max.)
cycles	+ overshoot	$\Delta$ delay
cycle std. deviation	- overshoot	$\Delta$ time @ level
cycle mean	peak-to-peak	$\Delta$ time @ level from
cycle median	period	trigger
cycle rms	risetime	$\Delta$ time from clock to
data	rms	data + (setup time)
delay	std. deviation	$\Delta$ time from clock to
duty cycle	top	data - (hold time)
duration	width	18 Histogram
falltime	last	parameters
frequency	media	
first	number of points	

Jitter measurement for parameters including: period, cycle-cycle, frequency, and edge@lv, with JitterTrack of up to 200 edges.

### Advanced Drive Analysis

Capabilities include: Head Filter/ Equalizer Emulation, Channel Emulation, SAM Histograms, Plot of SAM Values, PES Runout Analysis, Analog Compare.

Additional waveshape analysis capabilities include: FFT capability with power averaging, power density, real and imaginary components, and frequency domain parameters, Parameter Math – add, subtract, multiply, or divide two different parameters, User-definable parameter measurements, User-definable math functions.



## DDA 5005A/DDA 5005A XXL/DDA 3000

SPECIFICATIONS	DDA 5005A AND DDA 5005A XXL	DDA 3000
<b>VERTICAL SYSTEM</b>		
Analog Bandwidth @ 50 $\Omega$ (-3 dB)	5 GHz	3 GHz
Input Channels	4	4
Bandwidth Limiter	20 MHz; 200 MHz; 1 GHz; 3 GHz; 4 GHz	25 MHz, 200 MHz, 1 GHz
Input Impedance	50 $\Omega$ $\pm$ 1.5%	50 $\Omega$ or 1 M $\Omega$    15 pF, 10 M $\Omega$    11 pF with PP005A probe
Input Coupling	DC, GND	1 M $\Omega$ : AC, DC, GND; 50 $\Omega$ : DC
Maximum Input Voltage	2.5 V <sub>rms</sub> ; $\pm$ 4 V <sub>peak</sub>	50 $\Omega$ : 5 V <sub>rms</sub> , 1 M $\Omega$ : 100 V max. (peak AC: $\leq$ 5 KHz + DC)
Vertical Resolution	8 bits; up to 11 bits with enhanced resolution (ERES)	
Sensitivity	2 mV–1 V/div fully variable	50 $\Omega$ : 2 mV–1 V/div fully variable; 1 M $\Omega$ : 2 mV–2 V/div fully variable
Offset Range	$\pm$ 750 mV @ 2 mV–194 mV/div $\pm$ 4 V @ 196 mV–1 V/div	50 $\Omega$ : $\pm$ 700 mV @ 2 mV–4.95 mV/div. $\pm$ 1.50 V @ 5 mV–100 mV/div. $\pm$ 10 V @ 102 mV–1 V/div. 1 M $\Omega$ : $\pm$ 700 mV @ 2 mV–4.95 mV/div. $\pm$ 1.50 V @ 5 mV–100 mV/div. $\pm$ 20 V @ 102 mV–2 V/div.
DC Gain Accuracy	$\pm$ 1.5% of full scale; $\pm$ 1% (typical)	
<b>HORIZONTAL SYSTEM</b>		
Timebases	Internal timebase common to 4 input channels; An external clock may be applied at the auxiliary input	
Clock Accuracy	$\leq$ 1 ppm	$\leq$ 5 ppm
Time Interval Accuracy	$\leq$ 0.06/SR + (1 ppm * Reading)	$\leq$ 0.06/SR + (5 ppm * Reading)
External Clock Frequency	30 MHz–2 GHz; 50 $\Omega$ impedance; applied at the auxiliary input	30 MHz–1 GHz; 50 $\Omega$ impedance; applied at the auxiliary input
Roll Mode – Operating Range	N/A	Up to 1000 s/div; lower limit determined by memory length and sample rate
<b>ACQUISITION SYSTEM</b>		
Single-Shot Sample Rate/Ch	10 GS/s	
2 Channel Max.	20 GS/s	
Maximum Trigger Rate	150,000 waveforms/second (in Sequence Mode – up to 4 channels)	
Acquisition Memory	Max. Length (Mpts) (2 Ch / 4 Ch)	Max. number of Segments; Sequence Mode
DDA 3000, DDA 5005A XXL	100M / 48M	25,000
DDA 5005A	48M / 24M	20,000
Random Interleaved Sampling (RIS)	200 GS/s for repetitive signals, to 20 ps/div. Upper limit determined by sample rate and memory length settings.	
Intersegment Time	6 $\mu$ s	
<b>ACQUISITION PROCESSING</b>		
Averaging	Summed or continuous averaging up to 1 million sweeps	
Enhanced Resolution (ERES)	From 8.5 to 11 bits vertical resolution	
Envelope (Extrema)	Envelope, linear, floor, or roof; for up to 1 million sweeps	
Interpolation	Linear or Sin x/x	

## DDA 5005A/DDA 5005A XXL/DDA 3000

### TRIGGERING SYSTEM

Modes	Normal, Auto, Single, and Stop
Sources	Any input channel, External, Ext x 10, Ext/10, or line; slope and level unique to each source (except line trigger)
Coupling	DC
Pre-trigger Delay	0–100% of horizontal time scale
Post-trigger Delay	0–10,000 divisions
Hold-off by Time or Events	Up to 20 s or from 1 to 99,999,999 events
Internal Trigger Range	±5 div from center

	DDA 5005A AND DDA 5005A XXL	DDA 3000
Trigger Sensitivity (edge, typical) (Ch 1-4 & External)	3 div < 5 GHz 2 div < 4 GHz 1.2 div < 3 GHz	2 div < 3 GHz 1 div < 2 GHz

Max. Trigger Frequency, SMART Trigger	750 MHz ≥ 10 mV
External Trigger Input Range	Ext ±0.4 V; Ext x 10 ±0.04 V; Ext/10 ±4 V

### BASIC TRIGGERS

Edge/Slope/Line	Triggers when signal meets slope and level condition
-----------------	--

### SMART TRIGGERS

State or Edge Qualified	Triggers on any input source only if a defined state or edge occurred on another input source. Delay between sources is selectable by time or events
Dropout	Triggers if signal drops out for longer than selected time between 2 ns and 20 s
Pattern	Logic combination (AND, NAND, OR, NOR) of 5 inputs (4 channels and external trigger input) Each source can be high, low, or don't care. Trigger at start or end of the pattern

### SMART TRIGGERS WITH EXCLUSION TECHNOLOGY

Glitch	Triggers on positive or negative glitches with widths selectable from 600 ps to 20 s or on intermittent faults
Signal or Pattern Width	Triggers on positive or negative pulse widths selectable from 600 ps to 20 s or on intermittent faults
Signal or Pattern Interval	Triggers on intervals selectable between 2 ns and 20 s

### DISK DRIVE TRIGGERS

Sector	Triggers on the n'th sector pulse after index. Index and sector pulse polarity and sector pulse number are selectable
Servo Gate	Triggers on the n'th servo gate after index and every m'th thereafter. Index and servo gate pulse polarity are selectable
PES Trigger	Triggers on Position Error Signal (PES) exceeding an adjustable voltage window. Servo gate can be selected as qualifier
Read Gate Trigger	Triggers on any read gate longer than an adjustable Sector ID filed length

### AUTOMATIC SETUP

Auto Setup	Automatically sets timebase, trigger, and sensitivity to display a wide range of repetitive signals
Vertical Find Scale	Automatically sets the vertical sensitivity and offset for the selected channels to display a waveform with maximum dynamic range

## DDA 5005A/DDA 5005A XXL/DDA 3000

**PROBES**

	<b>DDA 5005A AND DDA 5005A XXL</b>	<b>DDA 3000</b>
Probes	A variety of passive and active probes are optional	(2) PP005A passive probes are standard. A variety of other passive and active probes are available.
Probe System	ProLink: Automatically detects and supports a variety of compatible probes; Supports SMA or ProBus BNC with ProLink adapters (included)	ProBus: Automatically detects and supports a variety of compatible probes
Scale Factors	Automatically or manually selected depending on probe used	

**COLOR WAVEFORM DISPLAY**

Type	Color 10.4" flat-panel TFT-LCD with high resolution touch panel
Resolution	SVGA; 800 x 600 pixels
Real-time Clock	Dates, hours, minutes, seconds displayed with waveform
Number of Traces	Display a maximum of eight traces. Simultaneously display channel, zoom, memory, and math traces
Grid Styles	Single, Dual, Quad, Octal, XY, Single + XY, Dual + XY
Waveform Styles	Sample dots joined or dots only

**ANALOG PERSISTENCE DISPLAY**

Analog and Color-Graded Persistence	Variable saturation levels; stores each trace's persistence data in memory
Persistence Selections	Select Analog or color positive
Trace Selection	Activate Analog Persistence on all or any combination of traces
Persistence Aging Time	Select from 500 ms to infinity
Sweeps Displayed	All accumulated or all accumulated with last trace highlighted

**ZOOM EXPANSION TRACES**

Display up to 4 Zoom and 4 Math/Zoom traces; 8 Math/Zoom traces available with XMAP (Master Analysis software package)

**CPU**

Processor	Intel® Pentium® 4 @ 2.54 GHz (or better), with Microsoft Windows® XP Professional
Processing Memory	Up to 2 Gbytes

**INTERNAL WAVEFORM MEMORY**

M1, M2, M3, M4 Internal Waveform Memory (Store full-length waveforms with 16 bits/data point) or store to any number of files limited only by data storage media

**SETUP STORAGE**

Front Panel and Instrument Status	Store to the internal hard drive or to a USB connected peripheral device
-----------------------------------	--

**INTERFACE**

Remote Control	Full command set for all front panel controls and internal functions via GPIB or Ethernet using Windows Automation or LeCroy Remote Command Set
----------------	---

## DDA 5005A/DDA 5005A XXL/DDA 3000

## INTERFACE (CONTINUED)

	DDA 5005A AND DDA 5005A XXL	DDA 3000
GPIB Port (IEEE-488.2)	Optional	Standard
Ethernet Port	10/100Base-T Ethernet interface	
USB Ports	6 USB 2.0 ports (2 on front panel), support MS Windows® compatible devices	
External Monitor Port Standard (independent Dual Monitor support available as an option)	15-pin D-Type SVGA-compatible	
Parallel Port	1 standard	

## AUXILIARY OUTPUT

Signal Types	Select from calibrator or control signals output on front panel
Calibrator Signal	5 Hz–1 MHz square wave or DC level; 0–0.5 V into 50 $\Omega$ (0–1.0 V into 1 M $\Omega$ )
Control Signals	Trigger ready, trigger out, pass/fail status; TTL logic voltage

## AUXILIARY INPUT

Signal Types	Select from External Trigger or External Clock input on front panel
--------------	---

## GENERAL

Auto Calibration	Ensures specified DC and timing accuracy is maintained for 1 year minimum
------------------	---

## POWER REQUIREMENTS

Voltage	100–240 V <sub>rms</sub> ( $\pm 10\%$ ) at 50 or 60 Hz; 115 V <sub>rms</sub> ( $\pm 10\%$ ) at 400 Hz; Automatic AC Voltage selection
Max. Power Consumption	650 W/650 VA

## PHYSICAL DIMENSIONS

Dimensions (HWD)	264 mm x 397 mm x 491 mm; 10.4" x 15.65" x 19.25" (height excludes feet)
Weight	18 kg; 39.5 lbs.
Shipping Weight	24 kg; 53 lbs.

## ENVIRONMENTAL

Temperature (Operating)	+5 °C to +40 °C including CD-ROM drives
Temperature (Non-Operating)	-20 °C to +60 °C
Humidity (Operating)	5% to 80% relative humidity (non-condensing) up to +30 °C Upper limit derates to 25% relative humidity (non-condensing) at +40 °C
Humidity (Non-Operating)	5% to 95% relative humidity (non-condensing) as tested per MIL-PRF-28800F
Altitude (Operating)	Up to 10,000 ft. (3,048 m) at or below +25 °C
Altitude (Non-Operating)	Up to 40,000 ft. (12,192 m)
Random Vibration (Operating)	0.31 g <sub>rms</sub> 5 Hz to 500 Hz, 15 minutes in each of three orthogonal axes
Random Vibration (Non-Operating)	2.4 g <sub>rms</sub> 5 Hz to 500 Hz, 15 minutes in each of three orthogonal axes
Functional Shock	20 g <sub>peak</sub> , half sine, 11 ms pulse, 3 shocks (positive and negative) in each of three orthogonal axes, 18 shocks total

## CERTIFICATIONS

CE Compliant for Safety and EMC, UL, and cUL listed; conforms to EN 61326, EN 61010-1, UL 3111-1, and CSA C22.2 No. 1010.1

## WARRANTY AND SERVICE

3-year warranty; calibration recommended annually. Optional service programs include extended warranty, upgrades, and calibration services.



## DDA 5005A/DDA 5005A XXL/DDA 3000

## ORDERING INFORMATION

## PRODUCT CODE

4 Ch; 5 GHz; 10 GS/s; 20 GS/s max.; 100 Mpts Memory (using 1 or 2 Ch)	DDA 5005A XXL
4 Ch; 5 GHz; 10 GS/s; 20 GS/s max.; 48 Mpts Memory (using 1 or 2 Ch)	DDA 5005A
4 Ch; 3 GHz; 10 GS/s; 20 GS/s max.; 100 Mpts Memory (using 1 or 2 Ch 50 $\Omega$ and 1 M $\Omega$ Input)	DDA 3000

## INCLUDED WITH STANDARD CONFIGURATION

CD-ROM Drive	
$\div$ 10, 10 M $\Omega$ Passive Probe (Qty 2) (DDA 3000 only)	PP005A
ProLink Adapters (DDA 5005A and DDA 5005A XXL only): SMA (Qty 4); BNC (Qty 2)	
Optical 3-button Wheel Mouse-USB	
Getting Started Manual	
CD-ROM containing Operator's Manual, Remote Control Manual, and Automation Manual	
CD-ROMs containing Utility Software and Norton Antivirus Software (1 year subscription)	
Protective Front Cover	
Remote Control Manual	
Standard Commercial Calibration and Performance Certificate	
Standard Ports; 10/100Base-T Ethernet, Parallel, SVGA Video Output, USB	
3-Year Warranty	

## SOFTWARE OPTIONS

## Application Specific Test and Analysis Software Options

Advanced Optical Recording Measurement Software Package	AORM
8B/10B Decoding and Analysis Software Package	SDA-8B10B

## Advanced Math and WaveShape Analysis Software Options

Demodulation Software Package	DMOD
Processing Web Editor Software Package for Functions and Parameters	XWEB
Jitter and Timing Analysis Software Package	JTA2
Digital Filter Software Package	DFP2
Advanced M1 Software Package for Jitter and Timing Measurements (4 seats)	LECROYM1/ADV-4
Basic M1 Software Package for Jitter and Timing Measurements	LECROYM1/BASIC

## Standard Compliance Software Options

PCI Express Development and Compliance Software for Gen1 and Gen2	SDA-PCIE-G2
SATA Gen1/Gen2 Solution Analysis Software Package	SDA-SATA
SAS I/II Solution Analysis Software Package	SDA-SAS
HDMI Compliance Test Software Package	SDA-HDMI
Serial Data Mask Software Package	SDM
Ethernet Test Software Package	ENET
USB 2.0 Compliance Test Software Package	USB2

## HARDWARE AND SOFTWARE OPTION

32 Digital Oscilloscope Mixed Signal Option	MS-32-DSA
---	-----------

## DDA 5005A/DDA 5005A XXL/DDA 3000

## ORDERING INFORMATION

## PRODUCT CODE

## HARDWARE OPTIONS AND ACCESSORIES

Internal Graphics Printer	WM-GP02
IEEE-488 GPIB Interface (standard in DDA 3000)	GPIB-1
Dual Monitor Display	DMD-1
Keyboard, USB	KYBD-1
Rackmount Adapter with 25" (64 cm) Slides	RMA-25
Rackmount Adapter with 30" (76 cm) Slides	RMA-30
Removable Hard Drive Package (includes USB, CD-ROM, Removable Hard Drive, and Spare Hard Drive)	WM-RHD
Additional Removable Hard Drive	WM-RHD-02
Soft Carrying Case	WM-SCC
Hard Transit Case	WM-TC1
Oscilloscope Cart with Additional Shelf and Drawer	OC1024
Oscilloscope Cart	OC1021
USB 2.0 Testing Compliance Test Fixture	TF-USB

## PROBE AND PROBE ACCESSORIES

(Qty. 4) 1.5 GHz, 0.9 pF, 1 M $\Omega$ High Impedance Active Probe	ZS1500-QUADPAK
(Qty. 4) 1 GHz, 0.9 pF, 1 M $\Omega$ High Impedance Active Probe	ZS1000-QUADPAK
WaveLink 7.5 GHz, Differential Probe with Adjustable Tip Module (for DDA 5005A only)	D600A-AT*
WaveLink 4 GHz, Differential Probe with Adjustable Tip Module (for DDA 3000 only)	D300A-AT*
WaveLink 7 GHz, Differential Probe with Small Tip Module (for DDA 5005A only)	D600ST*
WaveLink 4 GHz, 5 V Differential Probe with Small Tip Module	D350ST*
WaveLink 6 GHz, Differential Positioner with Mounted Probe Tip Module	D500PT*
WaveLink ProLink Probe Body (for DDA 5005A only)	WL600
WaveLink ProBus Probe Body (for DDA 3000 only)	WL300
Optical-to-Electrical Converter, 500–870 nm ProLink BMA Connector	OE525
Optical-to-Electrical Converter, 950–1630 nm ProLink BMA Connector	OE555
1 GHz Active Differential Probe ( $\pm 1$ , $\pm 10$ , $\pm 20$ )	AP034
ProLink-to-SMA Adapter	LPA-SMA
ProLink-to-BNC Adapter; 1 each	LPA-BNC
Kit of 4 SMA ProLink Adapters with Case	LPA-SMA-KIT
Kit of 4 ProLink BNC Adapters with Case	LPA-BNC-KIT
1 M $\Omega$ Adapter includes PP005A Passive Probe (for DDA 5005A and DDA 5005A XXL only)	AP-1M

\*For a complete probe, order a WL300 or WL600 Probe Body with the Probe Tip Module.



## WAVEMASTER® 8000A SERIES

The LeCroy **WaveMaster 8000A Series** oscilloscope offers a unique combination of high bandwidth, fast sampling speeds, and long memory capture, ideal for digital and communications systems. Equipped with our patented X-Stream technology, its fast data transfer and processing system deliver unprecedented measurement capabilities, at speeds 10–100 times faster than conventional oscilloscopes. Providing true WaveShape Analysis, its high-performance capabilities are changing the way engineers think about design and testing.

### Features:

- High bandwidth from 4 GHz to 6 GHz
- Fast sampling speeds—to 20 GS/s on 4 channels
- Full sampling speed maintained over entire memory length
- Standard memory 10 Mpts/Ch
- High signal integrity with an SiGe amplifier, ADC, and trigger circuit
- Intuitive GUI for easier WaveShape Analysis
- 10–100 times faster processing speeds
- A wide array of standard math tools
- Optional math and measurement packages

### Measurement Accuracy

Superior timebase performance and very low jitter noise floor make WaveMaster a truly remarkable instrument. Delivering extremely stable and precise measurements, its high level of accuracy includes:

- 1 ps rms jitter noise floor
- Timebase stability of  $\pm 1$  ppm clock accuracy
- Low trigger jitter < 2.5 ps
- Rise time as fast as 75 ps captures fast signal edges

### Exceptional Trigger Performance

WaveMaster offers a comprehensive array of triggers for maximum performance. The SiGe trigger circuit offers a 5 GHz edge trigger bandwidth for capturing fast signals with superior sensitivity. The versatile SMART Trigger™ captures a variety of signals, including glitches and pulse widths down to 600 ps. The logic trigger makes it easy to capture a pattern of up to 5 inputs, or to qualify on 4 signal inputs and trigger on the 5th.

### Deep Memory Calculations with Unprecedented Speed

LeCroy's proprietary X-Stream technology offers users the ability to see deep memory calculations updated quickly on the screen. With waveform processing at speeds 10–100 times faster than conventional oscilloscope technology, users can now easily:

- Capture and analyze long records quickly
- Use advanced tools such as XMATH Advanced Math and XDEV Advanced Customization software packages with long records
- Display unique analysis views, such as 3-dimensional displays, and histicons



WAVEMASTER 8000A

### WaveScan Advanced Search

#### Locate Problems Triggers Won't Find

*WaveScan is a powerful tool that provides the ability to locate unusual events in a single capture, or scan for an event in many acquisitions over a long period of time using more than 20 different search/scan modes. WaveScan uses measurement-based scanning modes, like frequency, to show statistical distribution of events. It overlays events for a quick and simple visual comparison.*



## WAVEMASTER® 8000A SERIES

### True Customization

LeCroy offers the ability to modify parameter measurements or math functions in the oscilloscope's interface for true customization. Users simply add proprietary functionality like MATLAB, Mathcad, or Excel, just as in a LeCroy-installed function. The results are displayed on the screen. Since the resulting waveform is inserted back into the processing flow, the oscilloscope's cursors, measurements, and math can be performed on it. This feature adds a robust dimension to WaveMaster's capabilities, creating much more flexibility than a simple export of data to a third-party program.

### Familiar Controls for Ease of Use

The WaveMaster 8000A Series oscilloscope's user interface is designed to be familiar, intuitive, and efficient. The easily recognizable oscilloscope controls on the front panel combine with a natural, context-sensitive graphical user interface that react quickly to user commands. A flexible selection of cursors can be positioned by knobs dedicated to specific functions that can be accessed from the front panel or the touch screen.

### Standard Math Tools

Display up to four math function traces (F1–F4). The easy-to-use graphical interface simplifies setup of up to two operations on each function trace, and function traces can be chained together to perform math-on-math.

absolute value	fft (power spectrum, magnitude, phase, up to 25 Mpts)	ratio (/)
auto-correlation function	floor	reciprocal
average (summed)	histogram of 2 billion events	rescale (with units)
average (continuous)	integral	roof
cubic interpolation function	invert (negate)	(sinx)/x
derivative	log (base e)	sparse function
deskew (resample)	log (base 10)	square
difference (-)	parameter math (+, -, *, / of two different parameters)	square root
enhanced resolution (to 11 bits vertical)	product (x)	sum (+)
envelope		track graphs
exp (base e)		trend (datalog) of 1 million events
exp (base 10)		zoom (identity)

### Standard Measure Tools

Displays any 8 parameters together with statistics, including their average high, low, and standard deviations. Histicons provide a fast, dynamic view of parameters and waveshape characteristics.

amplitude	last	phase
area	level@x	risetime (10–90%, 20–80% @level)
base	maximum	rms
cycles	mean	std. deviation
delay	median	top
Δ delay	minimum	width
duty cycle	narrowband power measurements	time@minimum (min.)
duration	number of points	time@maximum (max.)
falltime (90–10%, 80–20% @level)	+overshoot	Δ time@level
frequency	-overshoot	Δ time@level from trigger
first	peak-to-peak	x@max.
histogram parameters	period	x@min.

## WAVEMASTER® 8000A SERIES

SPECIFICATIONS	WAVEMASTER 8620A	WAVEMASTER 8600A XXL	WAVEMASTER 8420A	WAVEMASTER 8400A XXL
<b>VERTICAL SYSTEM</b>				
Analog Bandwidth @ 50 Ω (-3 dB)	6 GHz	6 GHz	4 GHz	4 GHz
Rise Time (typical)	75 ps	75 ps	105 ps	105 ps
Input Channels	4			
Bandwidth Limiters	20 MHz, 200 MHz, 1 GHz, 3 GHz, 4 GHz		20 MHz, 200 MHz, 1 GHz, 3 GHz	
Input Impedance	50 Ω ±2.0%			
Input Coupling	DC, GND			
Maximum Input Voltage	±4 V <sub>peak</sub>			
Channel-Channel Isolation	≥ 100:1 at 2 GHz; ≥ 40:1 at 3 GHz; ≥ 20:1 at 4 GHz			
Vertical Resolution	8 bits; up to 11 bits with enhanced resolution (ERES)			
Sensitivity	2 mV–1 V/div (fully variable, < 10 mV/div through zoom)			
DC Gain Accuracy	±1.5% of full scale			
Offset Range	±750 mV @ 2 mV–194 mV/div ±4 V @ 196 mV–1 V/div			
Offset Accuracy	±(1.5% of full scale +1.5% of offset value +2 mV)			
<b>HORIZONTAL SYSTEM</b>				
Timebases	Internal timebase common to 4 input channels; an external clock may be applied at the auxiliary input			
Time/Division Range	Real Time: 20 ps/div–10 s/div Random Interleave Sampling: to 20 ps/div, Upper time / div limit function of sample rate and memory length settings			
Sample Rate and Delay Time Accuracy	±1 ppm ≤ 10 sec interval			
Time Interval Accuracy	≤ 0.06 / SR + (1 ppm * Reading) (rms)			
Jitter Noise Floor	1 ps rms (typical)			
Trigger and Interpolator Jitter	< 2 ps rms (typical)			
Channel-Channel Deskew Range	±9 x time/div. setting, or 25 ns, whichever is larger			
External Timebase Reference	100 MHz; 50 Ω impedance, applied at the rear input			
External Clock	30 MHz–2 GHz, 50 Ω impedance, applied at the auxiliary input			
<b>ACQUISITION SYSTEM</b>				
Single-Shot Sample Rate/Ch	20 GS/s of 4 Ch	20 GS/s on 2 Ch; 10 GS/s on 4 Ch	20 GS/s of 4 Ch	20 GS/s on 2 Ch; 10 GS/s on 4 Ch
Random Interleaved Sampling (RIS)	200 GS/s for repetitive signals, to 20 ps /div. Upper time/div limit function of sample rate and memory length settings			
Maximum Trigger Rate	150,000 waveforms/second			
Intersegment Time	6 μs			
Maximum Acquisition Memory Points/Ch	4 Ch	(2 Ch)/(4 Ch)	4 Ch	(2 Ch)/(4 Ch)
Standard Memory	10M	96M/48M	10M	96M/48M
VL – Memory Option	32M	N/A	32M	N/A
XL – Memory Option	48M	N/A	48M	N/A

**WAVEMASTER® 8000A SERIES**

**ACQUISITION PROCESSING**

Averaging	Summed averaging to 1 million sweeps; continuous averaging to 1 million sweeps
Enhanced Resolution (ERES)	From 8.5 to 11 bits vertical resolution
Envelope (Extrema)	Envelope, floor, or roof for up to 1 million sweeps

**TRIGGERING SYSTEM**

Modes	Normal, Auto, Single, and Stop
Sources	Any input channel, External, Ext X 10, Ext $\pm$ 10, or line; slope and level unique to each source (except line trigger)
Coupling Mode	DC
Pre-trigger Delay	0–100% of memory size (adjustable in 1% increments)
Post-trigger Delay	the smaller of 0–10,000 divisions or 86400 seconds
Hold-off by Time or Events	From 2 ns up to 20 s or from 1 to 99,999,999 events
Internal Trigger Range	$\pm$ 5 div from center

**WAVEMASTER 8620A  
WAVEMASTER 8600A XXL**

**WAVEMASTER 8420A  
WAVEMASTER 8400A XXL**

Trigger Sensitivity with Edge Trigger (Ch 1–4)	3 div @ $\leq$ 5 GHz 2 div @ $<$ 4 GHz 1.2 div @ $<$ 3 GHz (typical)	2 div @ $\leq$ 4 GHz 1.2 div @ $<$ 3 GHz (typical)
External Trigger Sensitivity (Edge Trigger)	1.2 V @ $\leq$ 5 GHz 800 mV $<$ 4 GHz 480 mV $<$ 3 GHz (typical)	800 mV @ $<$ 4 GHz 480 mV @ $<$ 3 GHz
Max. Trigger Frequency, SMART Trigger™	750 MHz @ $\geq$ 10 mV	
External Trigger Input Range	Aux ( $\pm$ 0.4 V); Aux X10 ( $\pm$ 0.04 V); Aux/10 ( $\pm$ 4 V)	

**BASIC TRIGGERS**

Edge	Triggers when signal meets slope and level condition.
------	---

**SMART TRIGGERS**

State or Edge Qualified	Triggers on any input source only if a defined state or edge occurred on another input source. Delay between sources is selectable by time or events.
Dropout	Triggers if signal drops out for longer than selected time between 2 ns and 20 s.
Pattern	Logic combination (AND, NAND, OR, NOR) of 5 inputs. Each source can be high, low, or don't care. The High and Low level can be selected independently. Triggers at start or end of the pattern.

**SMART TRIGGERS WITH EXCLUSION TECHNOLOGY**

Glitch	Triggers on positive or negative glitches with widths selectable from 600 ps to 20 s, or on intermittent faults.
Signal or Pattern Width	Triggers on positive or negative pulse widths selectable from 600 ps to 20 s, or on intermittent faults.
Signal or Pattern Interval	Triggers on intervals selectable between 2 ns and 20 s.

**COLOR WAVEFORM DISPLAY**

Type	Color 10.4" flat panel TFT-LCD with high resolution touch screen
Resolution	SVGA; 800 x 600 pixels
Number of traces	Display a maximum of 8 traces. Simultaneously display channel, zoom, memory, and math traces.
Grid Styles	Auto, Single, Dual, Quad, Octal, X-Y, Single+X-Y, Dual+X-Y
Waveform Representation	Sample dots joined, or sample dots only

## WAVEMASTER® 8000A SERIES

### ANALOG PERSISTENCE DISPLAY

Analog and Color-Graded Persistence	Variable saturation levels; stores each trace's persistence data in memory
Persistence Types	Select analog, color graded, or three-dimensional
Trace Selection	Select persistence on all or any combination of traces
Persistence Aging Timing	Select from 500 ms to infinity
Sweep Display Modes	All accumulated, or all accumulated with last trace highlighted.

### PROCESSOR

Type	Intel® Pentium® 4, 2.54 GHz or better
Processor Memory	Up to 2 Gbytes
Operating System	Microsoft Windows® XP Professional
Oscilloscope Operating Software (X-Stream)	Entire instrument including any installed optional applications packages operates within a single Windows application
Real Time Clock	Date and time displayed with waveform an in hardcopy files. SNTP support to synchronize to precision internal clocks.

### INTERNAL WAVEFORM MEMORY

4 active waveform memory traces (M1–M4) store 16 bit/point full length waveforms. Waveforms can be stored to any number of files limited only by the data storage media capacity.

### SETUP STORAGE

Front Panel and Instrument Status	Store to the internal hard drive or to a USB-connected peripheral device.
-----------------------------------	---

### INTERFACE

Remote Control	Via Windows Automation, or via LeCroy Remote Command Set
GPIB Port (optional)	Supports IEEE – 488.2
Ethernet Port	Supports 10/100BaseT Ethernet interface
USB Ports	USB 2.0 ports on front and rear panels support Windows® XP compatible devices
External Monitor Port	15 pin D-Type SVGA compatible, duplicates instrument display. Optional dual monitor support for split Windows® applications
Parallel Port	1 standard

### AUXILIARY INPUT

Signal Types	Select External Trigger or External Clock Input on the front panel
--------------	--

### AUXILIARY OUTPUT

Signal Types	Select Calibrator, Trigger Enabled, Trigger Out, Pass/Fail, or Off
Calibrator Signal	5 Hz–5 MHz square wave or DC Level, 0–500 mV into 50 Ω, 0–1.0 V into 1 MΩ, or TTL logic voltages

### GENERAL

Auto Setup	Automatically sets timebase, trigger, and sensitivity to display a wide range of repetitive signals.
Find Vertical Scale	Automatically sets the vertical sensitivity and offset for the selected channel to display a waveform with the maximum dynamic range
Auto Calibration	Ensures specified DC and timing accuracy is maintained for 1 year minimum.



## WAVEMASTER® 8000A SERIES

### POWER REQUIREMENTS

Voltage	100–240 VAC ±10% at 50/60/400 Hz; 200–240 VAC ±10% at 50/60 Hz; Automatic AC Voltage Selection			
	<b>WAVEMASTER 8620A</b>	<b>WAVEMASTER 8600A XXL</b>	<b>WAVEMASTER 8420A XXL</b>	<b>WAVEMASTER 8400A XXL</b>
Max. Power Consumption	800 VA (800 W)	650 W/650 VA	800 VA (800 W)	650 W/650 VA

### ENVIRONMENTAL

Temperature (Operating)	+5 °C to +40 °C including CD-ROM drives
Temperature (Non-Operating)	-20 °C to +60 °C
Humidity (Operating)	5% to 80% relative humidity (non-condensing) up to +30 °C. Upper limit derates to 25% relative humidity (non-condensing) at +40 °C.
Humidity (Non-Operating)	5% to 95% relative humidity (non-condensing) as tested per MIL-PRF-28800F
Altitude (Operating)	Up to 10,000 ft. (3048 m) at or below +25 °C
Altitude (Non-Operating)	Up to 40,000 ft. (12,192 m)

### PHYSICAL DIMENSIONS

Dimensions (HWD)	264 mm x 397 mm x 491 mm; 10.4" x 15.6" x 19.3" (height excludes feet)			
Weight	23 kg; 50 lbs.	18 kg; 39 lbs.	23 kg; 50 lbs.	18 kg; 39 lbs.
Shipping Weight	29 kg; 63 lbs.	24 kg; 53 lbs.	29 kg; 63 lbs.	24 kg; 53 lbs.

### CERTIFICATIONS

CE Compliant; UL and cUL listed; Conforms to EN 61326 (for EMC); EN 61010, UL 61010B-1, and CSA C22.2 No. 1010.1 (for safety)

### WARRANTY AND SERVICE

3-year warranty; calibration recommended annually.  
Optional service programs include extended warranty, upgrades, and calibration services.

**WAVEMASTER® 8000A SERIES**

**ORDERING INFORMATION**

**PRODUCT CODE**

**WAVEMASTER DIGITAL OSCILLOSCOPES**

4 Ch; 6 GHz; 20 GS/s; 10 Mpts/Ch	WaveMaster 8620A
4 Ch; 6 GHz; 10 GS/s; 50 Mpts/Ch; 20 GS/s and 100 Mpts/Ch max. using 2 or 1 Ch	WaveMaster 8600A XXL
4 Ch; 4 GHz; 20 GS/s; 10 Mpts/Ch	WaveMaster 8420A
4 Ch; 4 GHz; 10 GS/s; 50 Mpts/Ch; 20 GS/s and 100 Mpts/Ch max. using 2 or 1 Ch	WaveMaster 8400A XXL

**MEMORY OPTIONS**

**8620A/8420A**

32M (4 Ch)	WM-VL
48M (4 Ch)	WM-XL

**INCLUDED WITH STANDARD CONFIGURATIONS**

ProLink Adapter SMA; 4 each	LPA-SMA
ProLink Adapter BNC; 2 each	LPA-BNC
Optical 3-button Wheel Mouse – USB	
Protective Front Cover	
Printed Operator’s Manual	
Printed Getting Started Manual	
Printed Remote Control Manual	
Product Manual Set on CD-ROM	
Software Option Manual on CD-ROM	
Norton Antivirus Software (1 year subscription)	
Microsoft Windows License Agreement	
Standard Commercial Calibration with Performance Certificate	
Power cable for the destination country	
3-Year Warranty	

**SOFTWARE OPTIONS**

**Application Specific Test and Analysis Software Options**

Advanced Optical Recording Measurement Software Package	AORM
Disk Drive Measurement Software Package	DDM2
PowerMeasure Analysis Software Package	PMA2
8B/10B Decoding and Analysis Software Package	SDA-8B10B
EMC Pulse Parameter Software Package	WM-EMC

**Advanced Math and WaveShape Analysis Software Options**

Digital Filter Software Package	DFP2
Jitter and Timing Analysis Software Package	JTA2
Serial Data Mask Software Package	SDM
Advanced M1 Software Package for Jitter and Timing Measurements (4 seats)	LECROYM1/ADV-4
Basic M1 Software Package for Jitter and Timing Measurements (1 seat)	LECROYM1/BASIC
Advanced Customization Software Package	XDEV
Master Analysis Software Package (Includes JTA2, XMATH, XDEV)	XMAP
Advanced Math Software Package	XMATH
Processing Web Editor Software Package for Functions and Parameters	XWEB

**Standard Compliance Software Options**

HDMI Compliance Test Software Package	SDA-HDMI
SAS I/II Solution Analysis Software Package	SDA-SAS
UWB Test Solution Software Package	SDA-UWB
Ethernet Test Software Package	ENET
USB 2.0 Compliance Test Software Package	USB2

## WAVEMASTER® 8000A SERIES

## ORDERING INFORMATION

## PRODUCT CODE

## SERIAL DATA OPTIONS

I <sup>2</sup> C Decode only Option	WM-I2Cbus D
SPI Decode only Option	WM-SPIbus D

## HARDWARE AND SOFTWARE OPTION

32 Digital Channel Oscilloscope Mixed Signal Option	MS-32-DSA
---	-----------

## HARDWARE OPTIONS AND ACCESSORIES

IEEE-488 GPIB Control Interface	GPIB-1
Dual Monitor Display	DMD-1
Keyboard, USB	KYBD-1
ProLink-to-BNC Adapter; 1 each	LPA-BNC
Kit of 4 ProLink BNC Adapters with Case	LPA-BNC-KIT
ProLink-to-SMA Adapter	LPA-SMA
Kit of 4 SMA ProLink Adapters with Case	LPA-SMA-Kit
Oscilloscope Cart with Additional Shelf and Drawer	OC1024
Oscilloscope Cart	OC1021
Rackmount Adapter with 25" (64 cm) Slides	RMA-25
Rackmount Adapter with 30" (76 cm) Slides	RMA-30
Video Trigger Module	VT75
Internal Graphics Printer	WM-GP02
Removable Hard Drive Package (includes USB, CD-ROM, Removable Hard Drive, and Spare Hard Drive)	WM-RHD
Additional Removable Hard Drive	WM-RHD-02
CD-ROM Read/Write Upgrade	WM-CDRW
Soft Carrying Case	WM-SCC
Hard Transit Case	WM-TC1
1 M $\Omega$ Adapter includes PP005A Passive Probe	AP-1M

## COMPLIANCE TEST FIXTURES

HDMI Test Fixture Set (TPA-P-SE, TPA-P-DI)	TF-HDMI
Ethernet Compliance Test Fixture for 10Base-T	TF-10BT
Telecom Adapter Kit 100 $\Omega$ Bal., 120 $\Omega$ Bal., 75 $\Omega$ Unbal.	TF-ET
Ethernet Compliance Test Fixture for 100Base-T/1000Base-T [Includes a Set of 2 Test Fixtures Signals on Twisted Pair Cables (UTP)]	TF-ENET
USB 2.0 Testing Compliance Test Fixture	TF-USB

## PROBES AND PROBE ACCESSORIES

2.5 GHz, 0.7 pF Active Probe ( $\pm 10$ ), Small Form Factor	HFP2500
(Qty. 4) 1.5 GHz, 0.9 pF, 1 M $\Omega$ High Impedance Active Probe	ZS1500-QUADPAK
(Qty. 4) 1 GHz, 0.9 pF, 1 M $\Omega$ High Impedance Active Probe	ZS1000-QUADPAK
WaveLink 7.5 GHz, Differential Probe Adjustable Tip Module	D600A-AT*
WaveLink 7 GHz, Differential Probe Small Tip Module	D600ST*
WaveLink 4 GHz, 5 V Differential Probe Small Tip Module	D350ST*
WaveLink 6 GHz, Differential Positioner Mounted Tip Module	D500PT*
WaveLink ProLink Probe Body	WL600
7.5 GHz, Low Capacitance Passive Probe ( $\pm 10$ , 1 k $\Omega$ ; $\pm 20$ , 500 $\Omega$ )	PP066
1 GHz, Active Differential Probe ( $\pm 1$ , $\pm 10$ , $\pm 20$ )	AP034
Optical-to-Electrical Converter, 500–870 nm ProLink BMA Connector	OE525
Optical-to-Electrical Converter, 950–1630 nm ProLink BMA Connector	OE555
Probe Deskew and Calibration Test Fixture	TF-DSQ

\*For a complete probe, order a WL600 Probe Body with the Probe Tip Module.

## WAVEPRO® 7000A SERIES

The **WavePro 7000A Series** oscilloscope offers the sophisticated analysis capability of a top line oscilloscope with the all-round utility of a general purpose instrument. In 1 GHz to 3 GHz bandwidth applications, the WavePro delivers fast, accurate measurements associated more often with high-end lab oscilloscopes. Common Jitter and Timing measurements for clock and timing analysis enhance its capabilities. Wrap this performance in a very attractive price, and the LeCroy WavePro oscilloscope is the ideal solution for your test needs.

### Features:

- 10 GS/s single-shot sample rate on all channels (20 GS/s maximum) to capture signal details
- Up to 3 GHz with 50  $\Omega$  and 1 M $\Omega$  inputs
- Acquisition of up to 100 million data points to maintain high sampling rates and complex signals
- Over 80 jitter and timing measurements are standard
- 1 ps jitter noise floor
- Unique processing chain that enables the addition of customized measurements in the processing stream

### Additional Features:

- Deep Memory – Offers 10 Mpts per channel standard memory. Options extend all the way up to 100 Mpts.
- Display – Large 10.4" SVGA touch screen. View waveform details and measurement results without crowding.
- Accessories – Passive, active, differential, and current probes as well as O/E converters can be connected to a WavePro oscilloscope.
- High Impedance Input – All WavePro channels can be used at either 50  $\Omega$  or 1 M $\Omega$ , both selectable on the screen.
- X-Stream Technology – Proprietary technology that enables data processing that is 80–150 times faster than other oscilloscopes.
- Auto Setup – One button automatically calls up a signal on the display.
- Analog Persistence – Switches between analog view and digital view so you can fully explore the signal's modulation.
- QuickZoom – Automatically displays 10x magnified traces of all signals on multi-grids.
- Wavepilot – Controls give easy access to powerful signal analysis capabilities so you can gain insight and trace problems directly to their source.
- Dedicated Vertical Controls – Each channel has its own volts per division (V/div) and offset control knobs. You can control any channel by turning the knobs, eliminating the need to multiplex a single control across all four channels.
- Dedicated Cursor Controls – Allows instant adjustment—even after you leave the cursor setup menu.
- Touch Screen (standard) – Can be used with or without a mouse.
- Front Access USB 2.0 – Provides convenient access for transferring waveform or setup data to flash memory keys, without the need to reach behind the oscilloscope.

Proprietary X-Stream Technology enables the insertion of a user's custom analysis routines directly into the processing chain of the WavePro oscilloscope. Easily write a Visual Basic script, MATLAB, Mathcad, or Excel function and seamlessly integrate it into the oscilloscope's processing chain without running "off line," establish a remote communication between the oscilloscope and another program, create a new reference waveform, or transfer large data files between the oscilloscope and another program.

- Import tools such as filters from your simulation environment into the oscilloscope to compare simulated signals with actual circuit performance. Validate if circuit performance matches the model, and reduce characterization time.
- Build your own user interface. Add push buttons, frames, custom controls.



WAVEPRO 7000A

### WaveScan Advanced Search

#### **Locate Problems Triggers Won't Find**

*WaveScan is a powerful tool that provides the ability to locate unusual events in a single capture, or scan for an event in many acquisitions over a long period of time using more than 20 different search/scan modes. WaveScan uses measurement-based scanning modes, like frequency, to show statistical distribution of events. It overlays events for a quick and simple visual comparison.*



**WAVEPRO® 7000A SERIES**

**Standard Math Tools**

Display up to four math function traces (F1–F4). The easy-to-use graphical interface simplifies setup of up to two operations on each function trace, and function traces can be chained together to perform math-on-math.

absolute value	fft (power spectrum, magnitude, phase, up to 25 kpts)	ratio (/)
average (summed)		reciprocal
average (continuous)		rescale (with units)
derivative	floor	roof
deskew (resample)	histogram of 1000 events	(sinx)/x
difference (-)	integral	square
enhanced resolution (to 11 bits vertical)	invert (negate)	square root
envelope	log (base e)	sum (+)
exp (base e)	log (base 10)	trend (datalog) of 1000 events
exp (base 10)	product (x)	zoom (identity)

**Standard Measure Tools**

Display any 8 parameters together with statistics, including their average, high, low, and standard deviations. Histicons provide a fast, dynamic view of parameters and waveshape characteristics.

amplitude	last	rms
area	level@x	std. deviation
base	maximum	top
cycles	mean	width
data	median	median
delay	minimum	phase
Δ delay	number of points	time@minimum (min.)
duty cycle	+overshoot	time@maximum (max.)
duration	-overshoot	Δ time@level
falltime (90–10%, 80–20% @level)	peak-to-peak	Δ time@level from trigger
frequency	period	x@max.
first	risetime (10–90%, 20–80% @level)	x@min.

**Pass/Fail Testing**

Simultaneously test multiple parameters against selectable parameter limits or pre-defined masks. Pass or fail conditions can initiate actions including document to local or networked files, e-mail the image of the failure, save waveforms, send a pulse out at the front panel auxiliary BNC output, or (with the GPIB option) send a GPIB SRQ.

**Jitter and Timing**

*Parametric Measurements:*

- period@level
- width@level
- duty@level
- frequency@level
- TIE@level
- edge@level

*Statistical Analysis:*

- Jitter Track
- Jitter Trend (1000 pts)
- Histograms (1000 pts)

## WAVEPRO® 7000A SERIES

### WAVEPRO SOFTWARE OPTIONS

#### ADVANCED MATH AND WAVESHAPe ANALYSIS

##### Master Analysis Software Package (XMAP)

This package provides maximum capability and flexibility, and includes all the functionality present in XMATH, XDEV, and JTA2.

##### Advanced Math Software Package (XMATH)

This package provides a comprehensive set of signal WaveShape Analysis tools providing insight into the waveshape of complex signals. Additional capability provided by XMATH includes:

- 8 math traces total (4 additional)
- Parameter math – add, subtract, multiply, or divide two different parameters
- Histograms expanded with 19 histogram parameters and up to 2 billion events
- Trend (datalog) of up to 1 million events
- Track graphs of any measurement parameter
- FFT capability added to include: power averaging, power density, real and imaginary components, frequency domain parameters, and FFT on up to 25 Mpts.
- Narrow-band power measurements
- Auto-correlation function
- Sparse function
- Cubic and Quadratic Interpolation function

##### Advanced Customization Software Package (XDEV)

This package provides a set of tools to modify the oscilloscope and customize it to meet your unique needs. Additional capability provided by XDEV includes:

- Creation of your own measurement parameter or math function, using third-party software packages, and display the result in the oscilloscope. Supported third-party software packages include:
  - VBScript
  - MATLAB
  - Excel
  - Mathcad
- CustomDSO – create your own user interface in a oscilloscope dialog box.
- Addition of macro keys to run VBScript files
- Support for plug-ins

##### Jitter and Timing Analysis Software Package (JTA2)

This package provides jitter timing and analysis using time, frequency, and statistical views for common timing parameters, and also includes other useful tools. JTA2 includes:

- Jitter and timing parameters, with “Track” graphs of
 

– Cycle-Cycle Jitter	– Frequency	– Time Interval Error	– Duty Cycle
– N-Cycle	– Period	– Setup	– Duty Cycle Error
– N-Cycle with start selection	– Half Period	– Hold	
	– Width	– Skew	
- Edge@lv parameter (counts edges)
- Histograms expanded with 19 histogram parameters and up to 2 billion events
- Trend (datalog) of up to 1 million events
- Track graphs of all parameters
- Persistence histogram, persistence trace (mean, range, sigma)

## WAVEPRO® 7000A SERIES

### **ADVANCED MATH AND WAVESHAPE ANALYSIS (CONTINUED)**

#### **Digital Filter Software Package (DFP2)**

LeCroy's Digital Filter Package (DFP2) implements a set of linear-phase Finite Impulse Response (FIR) filters and IIR filters. It enhances the user's ability to examine important signal components by filtering out undesired spectral components such as noise. With the custom design feature, corrupted signals can be reconstructed by applying matched (mirror) filters to compensate for known distortions.

The DFP2 option has a broad range of applications:

- System Identification
- Prediction
- Noise Cancellation
- Low-pass Filters
- Band-stop Filters
- Band-pass Filters
- High-pass Filters
- Raised Cosine, Raised Root Cosine, and Gaussian Filters

### **APPLICATION SPECIFIC TEST AND ANALYSIS PACKAGES**

#### **Power Measure Analysis Package (PMA2)**

This package provides exceptional ability to measure and analyze the operating characteristics of power conversion devices and circuits.

- Automatic setup and display of relevant waveforms and parameters
- Waveforms scaled and displayed in volts, amps, watts, ohms, etc.
- Power device performance analyzed in-circuit
- Measure and view time domain response of the entire control loop
- Pre-compliance line harmonic testing to EN 61000-3-2
- Complete solutions available including probes and differential amplifiers

#### **Advanced Optical Recording Measurements (AORM)**

The AORM option in our new-generation X-Stream oscilloscope environment provides a completely updated user interface and improved debug tools written to support ever-increasing read/write data rates and larger media capacity required for the latest CD and DVD implementations. Typical applications include game box technology and high-capacity DVD Read/Write.

The unique combination of deep acquisition memory available in LeCroy oscilloscopes and the flexibility of AORM in adapting to optical recording standards provides the user with ultimate measurement accuracy and 2-dimensional correlation of recording parameters.

**Note:** AORM is supported in WavePro 7200A oscilloscopes and higher.

## WAVEPRO® 7000A SERIES

### APPLICATION SPECIFIC TEST AND ANALYSIS PACKAGES (CONTINUED)

#### PARAMETER DEFINITION TABLE

Timing Analysis Parameters		Amplitude Analysis Parameters	
deltap2c	Data edge shift referred to clock	paa	Average amplitude of RF signal
deltap2cs	Standard deviation of deltap2c	pasym	Asymmetry of RF signal
edgsh	Pit or space width difference from ideal value	pbase	Base of pit or space
period	Period of each cycle of clock	pmax	Maximum of pit or space
pnum	Number of pit or space pair	pmidl	Middle voltage of pit or space
pwid	Width of pit or space pairs	pmin	Minimum of pit or space
t@pit	Delay of pit or space from trigger	pmoda	Modulation of RF signal
timj	Standard deviation of edgsh	pres	Resolution of RF signal
		ptop	Top of pit or space

#### Disk Drive Measurements Package (DDM2)

This package provides disk drive parameter measurements and related mathematical functions for performing disk drive WaveShape Analysis.

- Disk Drive Parameters are as follows

amplitude asymmetry	local time at minimum	pulse width 50–
local base	local time at maximum	pulse width 50+
local baseline separation	local time peak-trough	resolution
local maximum	local time over threshold	track average amplitude
local minimum	local time trough-peak	track average amplitude–
local number	local time under threshold	track average amplitude+
local peak-peak	narrow band phase	auto-correlation s/n
local time between events	narrow band power	non-linear transition shift
local time between peaks	overwrite	
local time between troughs	pulse width 50	

- Correlation function
- Trend (datalog) of up to 1 million events
- Histograms expanded with 18 histogram parameters and up to 2 billion events



**WAVEPRO® 7000A SERIES**

<b>SPECIFICATIONS</b>	<b>WAVEPRO 7300A</b>	<b>WAVEPRO 7200A</b>	<b>WAVEPRO 7100A</b>	<b>WAVEPRO 7300A XXL</b>	<b>WAVEPRO 7200A XXL</b>	<b>WAVEPRO 7100A XXL</b>
<b>VERTICAL SYSTEM</b>						
Analog Bandwidth (-3 dB, 50 Ω ≥ 10 mV/div)	3 GHz	2 GHz	1 GHz	3 GHz	2 GHz	1 GHz
Rise Time (Typical)	150 ps	225 ps	400 ps	150 ps	225 ps	400 ps
Input Channels	4					
Bandwidth Limiters	25 MHz; 200 MHz					
Input Impedance	50 Ω or 1 MΩ    15 pF; 10 MΩ    11 pF with PP005A Probe					
Input Coupling	1 MΩ: AC, DC, GND; 50 Ω: DC					
Maximum Input Voltage	50 Ω: 5 V <sub>rms</sub> , 1 MΩ: 100 V max. (peak AC: ≤ 5 kHz + DC)					
Channel-Channel Isolation	250:1 at same V/div setting, 40:1 at 3 GHz					
Vertical Resolution	8 bits; up to 11 bits with enhanced resolution (ERES)					
Sensitivity	50 Ω: 2 mV–1 V/div, fully variable; 1 MΩ: 2 mV–2 V/div, fully variable					
DC Gain Accuracy	±1.5% of full scale; (±1% typical)					
Offset Range	50 Ω: ±700 mV @ 2–4.95 mV/div ±1.5 V @ 5–100 mV/div ±10 V @ 0.102–1 V/div 1 MΩ: ±700 mV @ 2–4.95 mV/div ±1.5 V @ 5–100 mV/div ±20 V @ 0.102–2 V/div					
Offset Accuracy	±(1.5% of full scale + 0.5% of offset value + 2 mV)					
<b>HORIZONTAL SYSTEM</b>						
Timebase	Internal timebase common to 4 input channels; an external clock may be applied at the auxiliary input					
Time/Division Range	200 ps/div–10 s/div; RIS mode: to 20 ps/div; Roll mode: up to 1000 s/div					
Clock Accuracy	≤ 10 ppm					
Time Interval Accuracy	≤ 0.06 / SR + (10 ppm * Reading) (rms)					
Sample Rate and Delay Time Accuracy	±5 ppm ≤ 10 s interval					
Jitter Noise Floor	1 ps rms @ 100 mV/div (typical)					
Trigger and Interpolator Jitter	2.5 ps rms (typical)					
Channel-Channel Deskew Range	±9 x time/div. setting, 100 ms max., each channel					
External Clock	30 MHz–1 GHz; 50 Ω impedance; applied at the auxiliary input					
<b>ACQUISITION SYSTEM</b>						
Single-Shot Sample Rate/Ch	10 GS/s					
2 Channel Max.	20 GS/s					
Random Interleaved Sampling (RIS)	200 GS/s for repetitive signals: to 20 ps/div, Upper time/div limit function of sample rate and memory length settings					
Maximum Trigger Rate	150,000 waveforms/second (in Sequence Mode, up to 4 channels)					
Intersegment Time	≤ 6 μs					
Maximum Acquisition Points/Ch	(4 Ch/2 Ch)		Max. Segments (Sequence Mode)			
Standard	10M/20M		5000			
VL – Memory Option	16M/32M		10,000			
XL – Memory Option	24M/48M		20,000			
XLL versions	50M/100M		25,000			

## WAVEPRO® 7000A SERIES

### ACQUISITION PROCESSING

Averaging	Summed or continuous averaging up to 1 million sweeps
Enhanced Resolution (ERES)	From 8.5 to 11 bits vertical resolution
Envelope (Extrema)	Envelope, floor, or roof for up to 1 million sweeps
Interpolation	Linear or Sin x/x

### TRIGGERING SYSTEM

Modes	Normal, Auto, Single, and Stop
Sources	Any input channel, External, Ext X10, Ext/10, or line; slope and level unique to each source (except line trigger)
Coupling	DC
Pre-trigger Delay	0–100% of memory size (adjustable in 1% increments of 100 ns)
Post-trigger Delay	0–10,000 divisions in real time mode, limited at slower time/div settings or in roll mode
Hold-off by Time or Events	2 ns to 20 s or from 1 to 99,999,999 events
Internal Trigger Range	±5 div from center

	WAVEPRO 7300A	WAVEPRO 7200A	WAVEPRO 7100A	WAVEPRO 7300A XXL	WAVEPRO 7200A XXL	WAVEPRO 7100A XXL
Trigger Sensitivity (edge) (Ch 1–4 and External)	2 div < 3 GHz 1 div < 2 GHz	2 div < 2 GHz 1 div < 1.8 GHz	2 div < 1 GHz 1 div < 750 MHz	2 div < 3 GHz 1 div < 2 GHz	2 div < 2 GHz 1 div < 1.8 GHz	2 div < 1 GHz 1 div < 750 MHz
Max. Trigger Frequency, SMART Trigger™	750 MHz					

### BASIC TRIGGERS

Edge	Triggers when signal meets slope (positive or negative) and level condition.
------	--

### SMART TRIGGERS

State or Edge Qualified	Triggers on any input source only if a defined state or edge occurred on another input source. Delay between sources is selectable by time or events.
Dropout	Triggers if signal drops out for longer than selected time between 2 ns and 20 s.
Pattern	Logic combination (AND, NAND, OR, NOR) of 5 inputs (4 channels and external trigger input.) Each source can be high, low, or don't care. The High and Low level can be selected independently. Triggers at start or end of the pattern.

### SMART TRIGGERS WITH EXCLUSION TECHNOLOGY

Glitch and Pulse Width	Triggers on positive or negative glitches with widths selectable from 600 ps to 20 s or on intermittent faults (subject to bandwidth limit of oscilloscope)
Signal or Pattern Interval	Triggers on intervals selectable between 2 ns and 20 s.
Timeout (State/Edge Qualified)	Triggers on any source if a given state (or transition edge) has occurred on another source. Delay between sources is 2 ns to 20 s, or 1 to 99,999,999 events.
Exclusion Triggering	Trigger on intermittent faults by specifying the normal width or period.

### AUTOMATIC SETUP

Auto Setup	Automatically sets timebase, trigger, and sensitivity to display a wide range of repetitive signals.
Vertical Find Scale	Automatically sets the vertical sensitivity and offset for the selected channels to display a waveform with maximum dynamic range.

### PROBES

Probes	(4) PP005A ÷10, 10 MΩ passive probes
Probe System: Probus	Automatically detects and supports a variety of compatible probes
Scale Factors	Automatically or manually selected depending on probe used

## WAVEPRO® 7000A SERIES

### COLOR WAVEFORM DISPLAY

Type	Color 10.4" flat-panel TFT-LCD with high resolution touch screen
Resolution	SVGA; 800 x 600 pixels
Number of Traces	Display a maximum of 8 traces. Simultaneously display channel, zoom, memory, and math traces
Grid Styles	Auto, Single, Dual, Quad, Octal, XY, Single + XY, Dual + XY
Waveform Styles	Sample dots joined or dots only

### ANALOG PERSISTENCE DISPLAY

Analog and Color-Graded Persistence	Variable saturation levels; stores each trace's persistence data in memory.
Persistence Selections	Select analog, color, or three-dimensional
Trace Selection	Activate persistence on all or any combination of traces
Persistence Aging Time	Select from 500 ms to infinity
Sweeps Displayed	All accumulated, or all accumulated with last trace highlighted

### ZOOM EXPANSION TRACES

Display up to 4 Zoom and 4 Math/Zoom traces; 8 Math/Zoom traces available with XMAP (Master Analysis software package) or XMATH (Advanced Math software package)

### CPU

Processor	Processor Intel® Pentium® 4 @ 2.54 GHz (or better) with Microsoft Windows® XP Professional
Processing Memory	Up to 2 Gbytes
Real Time Clock	Dates, hours, minutes, seconds displayed with waveform SNTP support to synchronize to precision internet clocks

### INTERNAL WAVEFORM MEMORY

M1, M2, M3, M4 Internal Waveform Memory (store full-length waveforms with 16 bits/data point) or store to any number of files limited only by data storage media

### SETUP STORAGE

Front Panel and Instrument Status	Store to the internal hard drive, over a network or to a USB-connected peripheral device
-----------------------------------	--

### INTERFACE

Remote Control	Via Windows Automation, or via LeCroy Remote Command Set
GPIB Port (Optional)	Supports IEEE – 488.2
Ethernet Port	10/100Base-T Ethernet interface
USB Ports	USB 2.0 ports support Windows compatible devices
External Monitor Port Standard	15-pin D-Type SVGA-compatible
Parallel Port	1 standard

### AUXILIARY INPUT

Signal Types	Selected from External Trigger or External Clock input on front panel
Coupling	50 Ω: DC; 1 MΩ: AC, DC, GND
Max. Input Voltage	50 Ω: 5 V <sub>rms</sub> ; 1 MΩ 250 V (Peak AC < 10 kHz + DC)

### AUXILIARY OUTPUT

Signal Types	Select from calibrator, control signals, or Off
Calibrator Signal	5 Hz–5 MHz square wave or DC level; 0.0 to 5.0 V into 50 Ω (0–1 V into 1 MΩ) or TTL volts (selectable)
Control Signals	Trigger enabled, trigger out, pass/fail status

## WAVEPRO® 7000A SERIES

### GENERAL

Auto Calibration	Ensures specified DC and timing accuracy is maintained for 1 year minimum
Power Requirements	100–120 VAC at 50/60/400 Hz; 200–240 VAC at 50/60 Hz; Automatic AC Voltage selection Max. power consumption: 650 W/650 VA

### ENVIRONMENTAL

Temperature (Operating)	+5 °C to +40 °C including CD-ROM drives
Temperature (Non-Operating)	-20 °C to +60 °C
Humidity (Operating)	5% to 80% relative humidity (non-condensing) up to +30 °C Upper limit derates to 25% relative humidity (non-condensing) at +40 °C
Humidity (Non-Operating)	5% to 95% relative humidity (non-condensing) as tested per MIL-PRF-28800F
Altitude (Operating)	up to 10,000 ft. (3048 m) at or below +25 °C
Altitude (Non-Operating)	up to 40,000 ft. (12,192 m)
Random Vibration (Operating)	0.31 g <sub>rms</sub> 5 Hz to 500 Hz, 15 minutes in each of three orthogonal axes
Random Vibration (Non-Operating)	2.4 g <sub>rms</sub> 5 Hz to 500 Hz, 15 minutes in each of three orthogonal axes
Functional Shock	20 g <sub>peak</sub> , half sine, 11 ms pulse, 3 shocks (positive and negative) in each of three orthogonal axes, 18 shocks total

### PHYSICAL DIMENSIONS

Dimensions (HWD)	264 mm x 397 mm x 491 mm; 10.4" x 15.6" x 19.3" (height excludes feet)
Weight	18 kg; 39 lbs.
Shipping Weight	24 kg; 53 lbs.

### CERTIFICATIONS

CE Compliant, UL and cUL listed; conforms to EN 61326-1, EN 61010-1, UL 3111-1, and CSA C22.2 No. 1010.1

### WARRANTY AND SERVICE

3-year warranty; calibration recommended annually  
Optional service programs include extended warranty, upgrades, and calibration services.



**WAVEPRO® 7000A SERIES**

**ORDERING INFORMATION**

**PRODUCT CODE**

**WAVEPRO 4-CHANNEL DIGITAL OSCILLOSCOPES**

4 Ch 3 GHz; 10 GS/s; 10 Mpts/Ch; 20 Mpts/Ch 20 GS/s using 2 or 1 Ch; 50 Ω and 1 MΩ Input	WavePro 7300A
4 Ch 2 GHz; 10 GS/s; 10 Mpts/Ch; 20 Mpts/Ch 20 GS/s using 2 or 1 Ch; 50 Ω and 1 MΩ Input	WavePro 7200A
4 Ch 1 GHz; 10 GS/s; 10 Mpts/Ch; 20 Mpts/Ch 20 GS/s using 2 or 1 Ch; 50 Ω and 1 MΩ Input	WavePro 7100A

**MEMORY OPTIONS**

32 Mpts/2 Ch, 16 Mpts/Ch	WP7-VL
48 Mpts/2 Ch, 24 Mpts/Ch	WP7-XL

**LONG MEMORY VERSIONS**

4 Ch 3 GHz; 10 GS/s; 50 Mpts/Ch; 100 Mpts/Ch 20 GS/s using 2 or 1 Ch; 50 Ω and 1 MΩ Input	WavePro 7300A XXL
4 Ch 2 GHz; 10 GS/s; 50 Mpts/Ch; 100 Mpts/Ch 20 GS/s using 2 or 1 Ch; 50 Ω and 1 MΩ Input	WavePro 7200A XXL
4 Ch 1 GHz; 10 GS/s; 50 Mpts/Ch; 100 Mpts/Ch 20 GS/s using 2 or 1 Ch; 50 Ω and 1 MΩ Input	WavePro 7100A XXL

**INCLUDED WITH STANDARD CONFIGURATION**

±10, 500 MHz 10 MΩ Passive Probe (Qty. 4)	PP005A
Optical 3-button Wheel Mouse – USB	
Protective Front Cover	
Printed Operator's Manual	
Printed Getting Started Guide	
Printed Remote Control Manual	
Product Manual Set on CD-ROM	
Software Option Manual CD-ROM	
Norton Antivirus Software (1 year subscription)	
Microsoft XP Pro License	
Commercial Calibration with Performance Certificate	
Power Cable for the Destination Country	
3-Year Warranty	

**SOFTWARE OPTIONS**

**Advanced Math and WaveShape Analysis Software Options**

Advanced Math Software Package	XMATH
Advanced Customization Software Package	XDEV
Processing Web Editor Software Package for Functions and Parameters	XWEB
Jitter and Timing Analysis Software Package	JTA2
Master Analysis Software Package (includes JTA2, XMATH, and XDEV)	XMAP
Digital Filter Software Package	DFF2

**Communications Testing Software Options**

Serial Data Mask Software Package	SDM
Ethernet Test Software Package	ENET
USB 2.0 Compliance Test Software Package	USB2

**Application Specific Test and Analysis Options**

Disk Drive Measurement Software Package	DDM2
Advanced Optical Recording Measurement Software Package (WP7200A and WP7300A only)	AORM
PowerMeasure Analysis Software Package	PMA2
EMC Pulse Parameter Software Package	WP7-EMC

**HARDWARE OPTIONS AND ACCESSORIES**

IEEE-488 GPIB Control Interface	GPIB-1
Internal Graphics Printer	WM-GP02
Removable Hard Drive Package (includes USB, CD-ROM, removable hard drive, and spare hard drive)	WM-RHD
Additional Removable Hard Drive	WM-RHD-02
CD-ROM Read/Write Upgrade	WM-CDRW
Dual Monitor Display	DMD-1

## WAVEPRO® 7000A SERIES

### ORDERING INFORMATION

### PRODUCT CODE

#### SERIAL DATA OPTIONS

I <sup>2</sup> C Decode only Option	WP7K-I2Cbus D
SPI Decode only Option	WP7K-SPIbus D
CANbus TD Trigger and Decode Option	CANbus TD
CANbus TDM Trigger, Decode, and Measure/Graph Option	CANbus TDM

#### HARDWARE AND SOFTWARE OPTIONS

32 Digital Channel Oscilloscope Mixed Signal Option	MS-32-DSA
CANbus TDM Trigger, Decode, and Measure/Graph Option	CANbus TDM
CANbus TD Trigger and Decode Option	CANbus TD

#### SELECTED PROBES AND SIGNAL CONDITIONERS SERIES

÷10, 500 MHz 10 MΩ Passive Probe (4 included)	PP005A
SMT Probing Accessories for PPE Series, PP005A, and PP065 Surface Mount Technology Products	PK106
2.5 GHz, 0.7 pF Active Probe (÷10), Small Form Factor	HFP2500
1.5 GHz, 0.7 pF Active Probe (÷10), Small Form Factor	HFP1500
(Qty. 4) 1.5 GHz, 0.9 pF, 1 MΩ High Impedance Active Probe	ZS1500-QUADPAK
(Qty. 4) 1 GHz, 0.9 pF, 1 MΩ High Impedance Active Probe	ZS1000-QUADPAK
WaveLink 4 GHz, Differential Probe Adjustable Tip Module	D300A-AT*
WaveLink 7 GHz, Differential Probe Small Tip Module	D600ST*
WaveLink 4 GHz, 5 V Differential Probe Small Tip Module	D350ST*
WaveLink 6 GHz, Differential Positioner Mounted Tip Probe Module	D500PT*
WaveLink ProBus Probe Body	WL300
1 GHz Active Differential Probe (÷1, ÷10, ÷20)	AP034
500 MHz Active Differential Probe (x10, ÷1, ÷10, ÷100)	AP033
Optical-to-Electrical Converter, 500–870 nm ProBus BNC Connector	OE425
Optical-to-Electrical Converter, 950–1630 nm ProBus BNC Connector	OE455
30 A; 100 MHz Current Probe – AC/DC; 30 A <sub>rms</sub> ; 50 A <sub>peak</sub> Pulse	CP031
30 A; 50 MHz Current Probe – AC/DC; 30 A <sub>rms</sub> ; 50 A <sub>peak</sub> Pulse	CP030
150 A; 10 MHz Current Probe – AC/DC; 150 A <sub>rms</sub> ; 500 A <sub>peak</sub> Pulse	CP150
500 A; 2 MHz Current Probe – AC/DC; 500 A <sub>rms</sub> ; 700 A <sub>peak</sub> Pulse	CP500
30 A; 50 MHz Current Probe – AC/DC; 30 A <sub>rms</sub> ; 50 A <sub>peak</sub> Pulse	AP015
1 Ch, 100 MHz Differential Amplifier with Precision Voltage Source	DA1855A
1,400 V, 100 MHz High-Voltage Differential Probe	ADP305
1,400 V, 20 MHz High-Voltage Differential Probe	ADP300

#### SELECTED ACCESSORIES

Keyboard, USB	KYBD-1
Rackmount Adapter with 25" (64 cm) Slides	RMA-25
Rackmount Adapter with 30" (76 cm) Slides	RMA-30
Hard Transit Case	WM-TC1
Oscilloscope Cart with Additional Shelf and Drawer	OC1024
Oscilloscope Cart	OC1021
Additional Graphic Printer Paper (10 Rolls Pkg.)	GPR10
Video Trigger Module	VT75
Telecom Adapter Kit for 100 Ω Bal., 120 Ω Bal., and 75 Ω Unbal.	TF-ET
Ethernet Compliance Test Fixture for 10Base-T	TF-10BT
Ethernet Compliance Test Fixture for 100Base-T/1000Base-T [includes a Set of 2 Test Fixtures Signals on Twisted Pair Cables (UTP)]	TF-ENET
USB 2.0 Testing Compliance Test Fixture	TF-USB

\*For a complete probe, order WL300 Probe Body with Probe Tip Module.

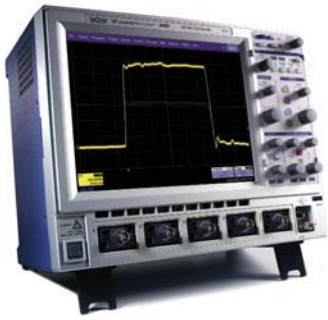

WAVERUNNER Xi

### WaveScan Advanced Search

#### Locate Problems Triggers Won't Find

*WaveScan is a powerful tool that provides the ability to locate unusual events in a single capture, or scan for an event in many acquisitions over a long period of time using more than 20 different search/scan modes. WaveScan uses measurement-based scanning modes, like frequency, to show statistical distribution of events. It overlays events for a quick and simple visual comparison.*

## WAVERUNNER Xi SERIES

**WaveRunner Xi** is the most complete “problem solving” oscilloscope from 200 MHz to 1 GHz with great performance, an unbelievable big display/small footprint form factor, and a multitude of fast viewing, SMART/serial data triggering, scanning, and WaveShape Analysis capabilities for fast or slow signals. No matter what your need, you can put the precision, performance, and capability of WaveRunner Xi to work for you.

#### Features:

- Bandwidths of 400 MHz, 600 MHz, 1 GHz, and 2 GHz
- 2 or 4 channel input
- Sample rates of 5 to 10 GS/s
- Standard memory of 10 (20 Mpts/Ch interleaved) up to 25 Mpts additional memory available when interleaved (VL memory option)
- WaveScan Advanced Search and Analysis
- SMART/serial data triggering

#### Powerful WaveShape Analysis Capability

WaveRunner Xi has the best problem solving capability, whether you are gathering statistical data on thousands or millions of events, converting signal information into a statistical, modulation, or frequency domain for better understanding, or using WaveScan™ to find anomalous events. In addition, WaveRunner Xi has numerous application packages to solve specific test and measurement challenges.

#### Additional Features:

- Bright, 10.4" Display, Only 15 cm (6") Deep – The most space-efficient oscilloscope for your bench from 400 MHz to 2 GHz.
- Dedicated Push, Zoom and Cursor Knobs – allow for faster readings and added functionality.
- Touch Screen with Built-in Stylus – The most time-efficient user interface is even easier to use with a built-in stylus.
- High Impedance Active Probes – ZS Series 1 and 1.5 GHz active probes with 0.9 pF, 1 M $\Omega$  input impedance and an extensive probe tip and ground accessory selection.
- Local Language User Interface – Select from 10 language preferences. Add a front panel overlay with your local language.

#### Excellence in Acquisition – WaveRunner Xi Fast Memory Architecture

LeCroy's proprietary method of data transfer and processing permits waveshapes to be captured and processed 10–100x faster than other oscilloscopes. The result is better capability to perform advanced WaveShape Analysis, and faster debug. With WaveRunner Xi, you'll see a difference when capturing long records and making measurements, calculating math or FFTs, or performing non-time domain analysis using statistically-based Histograms or parameter-based Tracks. For instance, in a long 10 Mpts capture where it's desired to measure the periodicity of a signal, WaveRunner Xi will quickly capture and display thousands of signal periods, measure each period, calculate statistics, and display a Histogram of the measurement values. Other oscilloscopes struggle to calculate a single period value (instead of thousands) and can't provide a Histogram view of the statistical data. Similar speed is achieved during simple operations, such as subtracting two channels (when a differential probe isn't available), or computing FFTs with high-frequency resolution (and, long memory).

## WAVERUNNER Xi SERIES

### SMART Triggers Isolate Events

The WaveRunner Xi oscilloscope provides a multitude of basic and advanced (SMART) triggers to meet any need. Advanced triggers isolate specific events of interest, and (when combined with long memory) provide a complete view of the signal activity around that event. WaveRunner Xi excels in this regard. Trigger on what you expect (widths, glitches, video, logic patterns, etc.) and also trigger on unusual signals (dropouts, intervals, runts, slew rates). LeCroy's exclusion triggering can exclude normal signals and capture only the abnormal ones, speeding the debug of circuits and systems. Trigger on signals down to 1 ns in width (500 ps for width and glitch trigger), or use an "A" condition to qualify a "B" trigger.

### Sequence Mode Extends Long Memory and SMART Triggering Capability

Use Sequence mode to store up to 10,000 triggered events as "segments" into oscilloscope memory. This can be ideal when capturing many fast pulses in quick succession (i.e., trigger re-arm time is most important) or when capturing few events separated by long time periods (i.e., longest capture time is most important). Sequence mode can acquire 4 channels simultaneously, provide timestamps for each acquisition (to 1 ns resolution), minimize capture dead-time (to  $\leq 800$  ns), and allow various ways to view and analyze the captured segmented data. Combine sequence mode with an advanced trigger to isolate a rare event, capture all instances over hours or days, and view and analyze each event afterwards.

### WaveScan™ Advanced Search and Analysis Finds Problems Triggers Won't Find

The best trigger won't find all unusual events—a more powerful capability is sometimes needed. WaveScan provides the ability to locate unusual events in a single capture (i.e., capture and search), or "scan" for an event in many acquisitions over a long period of time. Select from more than 20 search modes (frequency, rise time, runt, duty cycle, etc.), apply a search condition and begin scanning. Since the scanning "modes" are not simply copies of the hardware triggers, the utility and capability is much higher. For instance, there is no "frequency" trigger in any oscilloscope, yet WaveScan allows "frequency" to be quickly "scanned" for. This allows the user to accumulate a data set of unusual events that are separated by hours or days, enabling faster debugging.

When used in multiple acquisitions, WaveScan builds on the traditional LeCroy strength of fast processing of data. A LeCroy X-Stream oscilloscope will quickly scan millions of events, looking for unusual occurrences, and do it much faster and more efficiently than other oscilloscopes can. WaveScan in WaveRunner Xi also contains ScanHisto and ScanOverlay capability. Found events can be overlaid in a ScanOverlay view to provide a quick and simple comparison of events. In addition, measurement-based scanning modes (like the frequency example given above), permit ScanHistograms to show the statistical distribution of the found events. These analysis tools simplify understanding for faster debug.



## WAVERUNNER Xi SERIES

### **LeCroy WaveStream Fast Viewing Mode**

WaveStream provides a vibrant, intensity graded (256 levels) display with a fast update to closely simulate the look and feel of an analog oscilloscope. WaveStream is most helpful in viewing signals that have signal jitter or signal anomalies, or for applying a visual check before creating an advanced trigger or WaveScan setup to locate an unusual event. Since the sample rate in WaveStream mode can be as high as 10 GS/s (up to 5x that of other oscilloscopes), it is an excellent runt or glitch finder. Timing jitter is often visually assessed to understand approximate behavior. WaveStream makes it easy to understand jitter on edges or in eye diagrams. WaveStream also excels in allowing you to relate composite (WaveStream) to single-event (real-time sampled) behaviors. Just capture in WaveStream mode, toggle to view or zoom a single trace, then toggle back to WaveStream mode.

### **Unmatched Measurement and Validation Capability**

WaveRunner Xi provides the highest value for everyday characterization, validation, and debug, and the best capability for quickly debugging advanced problems. Whether you are debugging circuits with a mix of slow- and high speed signals, performing signal integrity checks on high speed clock and data signals, or doing advanced debugging of complex problems, WaveRunner Xi has the right toolset that is easily applied to the problem.

Oftentimes, only viewing signals does not provide the level of precision that is required for validating designs. At those times, the ability of WaveRunner Xi to quickly provide precise statistical data becomes vital. With WaveRunner Xi, you can quickly accumulate data on thousands of measurements in a single shot (WaveRunner Xi does not limit its measurements to a single value in an acquisition) or in multiple acquisitions. Touch a button, and display statistical information. Touch another button to display a Histogram graphical view of the measurement distribution. Expand this view into a larger histogram of measurement data. Accumulate up to 2 billion measurement events, or create measurable persistence traces of signals with the optional WRXi-STAT.

### **Advanced Math Characterization**

Most oscilloscopes contain only a few simple math functions to subtract waveforms or to perform coarse resolution FFTs on short record length acquisitions. Or, they provide long memory, but limited ability to process the memory and perform WaveShape Analysis that leads to detailed understanding and faster debug. WaveRunner Xi oscilloscopes contain dozens of standard math functions, and powerful capabilities, such as long memory FFTs, Trending, Tracking (optional), Sparsing, Interpolation selection, a variety of Persistence Views, user customized math and measurements (MATLAB, Mathcad, or Visual Basic formats), and numerous other specialized capabilities (optional Application Packages). The toolset is rich and deep, and sure to solve any complex problem.

### **LabNotebook™ – A Unique Tool for Documentation and Report Generation**

The LabNotebook feature of WaveRunner Xi provides a report generation tool to save and document all your work. Saving all displayed waveforms, relevant WaveRunner Xi settings, and screen images is all done through LabNotebook, eliminating the need to navigate multiple menus to save all these files independently. The screen images saved can be annotated with freehand notes using the stylus and touch screen, and then included in your report.

## WAVERUNNER Xi SERIES

### **Multidomain WaveShape Analysis Improves Understanding**

The most difficult electrical circuit problems are rarely obvious in the time domain. Long memory with zooming, searching, and scanning is an important part of the solution. However, serious design professionals understand the importance of converting time-domain information into statistical, parameter, or frequency domains so as to get to the root of the problem quicker. WaveRunner Xi provides you with the tools necessary to understand complex circuit problems and solve them faster.

### **Trend Views Turn Your Oscilloscope Into a Strip Chart Recorder**

Slowly sample at 1000 seconds/div to capture hours of slow speed signal data. Using Trend Views, plot measurement values of high-speed signals with slower speed signals, such as transducer or voltage values.

### **Track Views Provide Graphical Display of Parameter Values vs. Time**

Track in WaveRunner Xi (optional) uses every instance of a measurement in an acquisition to create a plot of measurement values on the Y-axis and time on the X-axis. The result is a graphical plot of a measurement change time correlated to the original channel acquisition—perfect for intuitive understanding.

Some examples include:

- Measuring a signal's Frequency over a 100 ms interval, and understanding whether the correct frequency shifts are present at the right times.
- Measuring a pulse width modulated (PWM) signal's Width over a 1 second interval, and determining if the modulation circuit is correctly reacting to system changes.
- Measuring the cycle-cycle jitter values in a micro processor and understanding how cycle-cycle jitter peaks correlate to spikes in power supply lines.

### **Histograms Graphically Present Statistical Data**

LeCroy oscilloscopes excel in capturing hundreds or thousands times more measurements per acquisition than other oscilloscopes do. With this much data, it is essential to provide more than just a list of mean, min, max, sdev, etc. Histograms provide an intuitive way to view the distribution of statistical data and gain real insight into underlying problems. For instance:

- Measure millions of jitter values in seconds, understand whether the measurement distribution is Gaussian or non-Gaussian, and correct timing problems to stay within a timing budget.
- Improve validation of timing budgets when measuring embedded controller response times. Measure hundreds of thousands of timing events instead of just hundreds, and easily view real-world worst case timing situations.

### **Fast Fourier Transforms (FFTs) Provide Spectral Views for Advanced Troubleshooting**

LeCroy's long memory (up to 25 Mpts) FFTs increase your ability to understand signal behaviors in the frequency domain. The long memory allows users to obtain 5–100x the frequency resolution possible with FFTs available in other oscilloscopes, which allows more precise troubleshooting. Built-in averaging of FFTs helps to eliminate random events from the calculations. In addition, LeCroy FFTs can be applied to any channel or math function, which greatly expands the ability to gather useful information.

## WAVERUNNER Xi SERIES

Some examples include:

- Capture power supply, clock, and data signals with 1 kHz frequency resolution. Correlate power supply noise to signal integrity.
- Apply an FFT to a Track of Cycle-Cycle Jitter and gain insight into the frequency components and root cause of the jitter.
- Quickly capture hundreds of acquisition and average the FFTs to increase frequency signal-noise ratio and to separate random from deterministic events.

### Specific Solutions for Tough Problems

In addition to the general purpose waveshape analysis tools that LeCroy offers with WaveRunner Xi, there are also specific tool sets that are packaged into a complete Application solution for Automotive, Embedded Design, or Switching Power Supply markets. These optional packages offer great value, and allow you to add to your oscilloscope over time as your needs change.

#### *Mixed Signal Testing Oscilloscope Option (MS-32)\**

Add 32 digital channels to a 4-channel WaveRunner Xi oscilloscope for 4 analog + 32 digital testing capability, with a simple oscilloscope setup and user interface. Each digital channel has 1 Mpts/Ch (32 Mpts total!) to capture all of your signal information for efficient debug and analysis. Thirty-two digital channels is ideal for the most efficient testing of 16-bit embedded controllers where all 16 ADDR and DATA lines can be viewed simultaneously.

\*MS-32 is compatible with WRXi 4-channel model oscilloscopes only.

#### *I2C, SPI, and CAN Serial Trigger and Decode (WRXi-I2Cbus TD, WRXi-SPIbus TD)*

- *Complete I2C, SPI, and CAN Serial Triggering*  
Quickly and easily isolate specific serial data events on your embedded controller for better understanding and faster debug. Set up trigger conditions in binary, hexadecimal (Symbolic for CAN) formats. Use the EXT input for the clock signal and keep an additional analog oscilloscope channel open for other uses. Trigger on DATA in specific locations of long I2C EEPROM reads. Get complete control of your debug process and finish faster.
- *Powerful Conditional I2C Data Triggering*  
Completely isolate specific SPI or I2C message events for better understanding and debug. Use a conditional I2C DATA trigger to select a range of DATA values to trigger on, not just a single DATA value. Oftentimes, I2C utilizes DATA bytes to specify sub-addresses for accessing memory locations in EEPROMs. Conditional DATA trigger allows triggering on a range of DATA bytes that correspond to reads or writes to specific sub-address memory blocks in the EEPROM. It can also aid in monitoring DATA outputs from I2C-based sensors, such as analog-to-digital converters, and triggering when DATA is outside a safe operating range. In both cases, verifying proper operation becomes a simple task.
- *Intuitive, Color-Coded Decode Overlay*  
Advanced software algorithms deconstruct the waveform into binary, hex, or ASCII protocol information, then overlay the decoded data on the waveform. Various sections of the protocol are color-coded to make it easy to understand. The decode operation is fast—even with long acquisitions.

## WAVERUNNER Xi SERIES

- **Table Summary and Search/Zoom**

Turn your oscilloscope into a protocol analyzer with the Table display of protocol information. Customize, or export Table data to an Excel file. Touch a message in the table and zoom for detail. Search for specific address or data values in the acquisition.

- **CANbus Trigger, Decode, and Measure/Graph Testing Options (CANbus TDM, CANbus TD, Vehicle Bus Analyzers)**

Flexibly trigger on CAN bus messages. Decode and display hexadecimal data values next to the CAN signal on the screen. Use CAN-specific parameters to automatically measure timing from sensor or actuator signals to specific CAN messages. Statistically analyze performance with histograms, and determine root cause of timing irregularities. Extract decimal data from a CAN message and graph it as if it were an analog signal. Easily correlate electrical problems to CAN bus messages or error frame data. In addition, Vehicle Bus Analyzers (VBAs) provide CAN symbolic level trigger and decode on up to four different CAN buses.

- **PowerMeasure Analysis Software Package (PMA2)**

The PMA2 software package enhances your ability to analyze power conversion devices and circuits. Measure switching and conduction losses with high accuracy. Capture power supply start-up events using long memory, view changes in the PWM signals using Track, and correlate PWM changes to other circuit signals. Measure power frequency harmonics and apparent/real power and power factor. Optional accessories, such as differential amplifiers, differential probes, current probes, and deskew fixtures complete the solution.

- **Electromagnetic Compatibility Software Package (EMC)**

The EMC software package adds flexibility to the rise time, fall time, and width parameters necessary to accurately measure ESD pulses, EFT bursts, surges, and transients common in EMC testing. In addition, the EMC package allows histogramming of up to 2 billion events, parameter math, and measurement filtering. Combine this with LeCroy's unbeatable standard statistics and measurement capability and you have a winning combination.

- **Jitter and Timing Analysis Software Package (JTA2)**

Use specialized timing parameters to measure period, cycle-cycle, half period, width, etc. jitter on a variety of signals. Use the three views of jitter (statistical, time, and frequency) to understand root cause and to debug problems. Histograms (statistical view) provide understanding of statistical distributions. Tracks (time view) provide a means to show time-correlated peaks or modulations of jitter, and to compare it to other signals. FFTs (frequency view) provide the ability to debug root causes of high in-circuit jitter.

- **Digital Filter Software Package (DFP2)**

DFP2 lets you implement Finite or Infinite Impulse Response filters to eliminate undesired spectral components, such as noise, and enhances your ability to examine important signal components. The DFP2 option allows you to choose from a standard set of FIR or IIR filters and also gives you the ability to design your own filters.



**WAVERUNNER Xi SERIES**

**Standard Math Tools**

Display up to four math function traces (F1–F4). The easy-to-use graphical interface simplifies setup of up to two operations on each function trace; and function traces can be chained together to perform math-on-math.

absolute value	fft (power spectrum, magnitude, phase, square root up to 50 kpts)	rescale (with units)
average (summed)	floor	roof
average (continuous)	histogram of 1000 events	segment
copy	integral	(sinx)/x
custom (MATLAB)	invert (negate)	square
derivative	log (base e)	square root
deskew (resample)	log (base 10)	sum (+)
difference (–)	product (x)	floor
enhanced resolution (to 11 bits vertical)	ratio (/)	trend (datalog) of 1000 events
envelope	reciprocal	zoom (identity)
exp (base e)		
exp (base 10)		

**Standard Measure Tools**

Display any 6 parameters together with statistics, including their average, high, low, and standard deviations. Histicons provide a fast, dynamic view of parameters, and waveshape characteristics.

amplitude	level@x	std. deviation
area	maximum	time@level
base	mean	top
cycles	median	Δ time@level
custom (MATLAB)	minimum	Δ time@level
delay	number of points	from trigger
Δ delay	+overshoot	width (positive + negative)
duration	–overshoot	
duty cycle	peak-to-peak	x@max.
falltime (90–10%, 80–20% @level)	period	x@min.
first	phase	
frequency	risetime (10–90%, 20–80% @level)	
last	rms	

**Software Options/Advanced Math and WaveShape Analysis:**

- Statistics Package (WRXi-STAT)
- Master Analysis Software Package (WRXi-XMAP)
- Advanced Math Software Package (WRXi-XMATH)
- Advanced Customization Software Package (WRXi-XDEV)
- Value Analysis Software Package (WRXi-XVAP)
- Intermediate Math Software Package (WRXi-XWAV)

## WAVERUNNER Xi SERIES

SPECIFICATIONS	WAVERUNNER 44Xi	WAVERUNNER 64Xi	WAVERUNNER 62Xi	WAVERUNNER 104Xi	WAVERUNNER 204Xi
<b>VERTICAL SYSTEM</b>					
Nominal Analog Bandwidth @ 50 Ω, 10 mV–1 V/div	400 MHz	600 MHz	600 MHz	1 GHz	2 GHz
Rise Time (Typical)	875 ps	625 ps	625 ps	400 ps	225 ps
Input Channels	4	4	2	4	4
Bandwidth Limiters	20 MHz; 200 MHz				
Input Impedance	1 MΩ    16 pF or 50 Ω			1 MΩ    20 pF or 50 Ω	
Input Coupling	50 Ω: DC, 1 MΩ: AC, DC, GND				
Maximum Input Voltage	50 Ω: 5 V <sub>rms</sub> , 1 MΩ: 400 V max. (DC + Peak AC ≤ 5 kHz)			50 Ω: 5 V <sub>rms</sub> , 1 MΩ: 250 V max. (DC + Peak AC ≤ 10 kHz)	
Vertical Resolution	8 bits; up to 11 with enhanced resolution (ERES)				
Sensitivity	50 Ω: 2 mV/div–1 V/div fully variable; 1 MΩ: 2 mV–10 V/div fully variable				
DC Accuracy	±1.0% of full scale (typical); ±1.5% of full scale, ≥ 10 mV/div (warranted)				
Offset Range	50 Ω: ±1 V @ 2–98 mV/div, ±10 V @ 100 mV/div–1 V/div; 1 MΩ: ±1 V @ 2–98 mV/div, ±10 V @ 100 mV/div–1 V/div, ±100 V @ 1.02 V/div–10 V/div			50 Ω: ±400 mv @ 2–4.95 mV/div, ±1 V @ 5–99 mv/div, ±10 V @ 100 mV– 1 V/div, ±100 V @ 1.02–10 V/div; 1 MΩ: ±400 mV @ 2–4.95 mV/div, ±1 V @ 5–99 mV/div, ±10 V @ 100 mV –1 V/div, ±100 V @ 1.02–10 V/div	
Input Connector	ProBus/BNC				
<b>TIMEBASE SYSTEM</b>					
Timebases	Internal timebase common to all input channels; an external clock may be applied at the auxiliary input				
Time/Division Range	Real time: 200 ps/div–10 s/div, RIS mode: 200 ps/div to 10 ns/div, Roll mode: up to 1,000 s/div				
Clock Accuracy	≤ 5 ppm @ 25 °C (typical) (≤ 10 ppm @ 5–40 °C)				
Sample Rate and Delay Time Accuracy	Equal to Clock Accuracy				
Channel to Channel Deskew Range	±9 x time/div setting, 100 ms max., each channel				
External Sample Clock	DC to 600 MHz; (DC to 1 GHz for 104Xi and 204Xi) 50 Ω, (limited BW in 1 MΩ), BNC input, limited to 2 Ch operation (1 Ch in 62Xi), (minimum rise time and amplitude requirements apply at low frequencies)				
Roll Mode	User selectable at ≥ 500 ms/div and ≤ 100 kS/s				
<b>ACQUISITION SYSTEM</b>					
Single-Shot Sample Rate/Ch	5 GS/s	5 GS/s	5 GS/s	5 GS/s	5 GS/s
Interleaved Sample Rate (2 Ch)	5 GS/s	10 GS/s	10 GS/s	10 GS/s	10 GS/s
Random Interleaved Sampling (RIS)	200 GS/s				
RIS Mode	User selectable from 200 ps/div to 10 ns/div			User selectable from 100 ps/div to 10 ns/div	
Trigger Rate (Maximum)	1,250,000 waveforms/second				
Sequence Time Stamp Resolution	1 ns				
Minimum Time Between	800 ns				
Sequential Segments					
Acquisition Memory Options	Max. Acquisition Points (4 Ch/2 Ch, 2 Ch/1 Ch in 62Xi)			Segments (Sequence Mode)	
Standard	10M/20M			5000	
Option VL	12.5M/25M			10,000	

## WAVERUNNER Xi SERIES

ACQUISITION PROCESSING	WAVERUNNER 44Xi	WAVERUNNER 64Xi	WAVERUNNER 62Xi	WAVERUNNER 104Xi	WAVERUNNER 204Xi
Time Resolution (min, Single-shot)	200 ps (5 GS/s)	100 ps (10 GS/s)	100 ps (10 GS/s)	100 ps (10 GS/s)	100 ps (10 GS/s)
Averaging	Summed and continuous averaging to 1 million sweeps				
ERES	From 8.5 to 11 bits vertical resolution				
Envelope (Extrema)	Envelope, floor, or roof for up to 1 million sweeps				
Interpolation	Linear or (Sinx)/x				
<b>TRIGGER SYSTEM</b>					
Trigger Modes	Normal, Auto, Single, Stop				
Sources	Any input channel, External, Ext/10, or Line; slope and level unique to each source, except Line				
Trigger Coupling	DC, AC (typically 7.5 Hz), HF Reject, LF Reject				
Pre-trigger Delay	0–100% of memory size (adjustable in 1% increments, or 100 ns)				
Post-trigger Delay	Up to 10,000 divisions in real time mode, limited at slower time/div settings in roll mode				
Hold-off	1 ns to 20 s or 1 to 1,000,000,000 events				
Internal Trigger Level Range	±4.1 div from center (typical)				
Trigger and Interpolator Jitter	≤ 3 ps rms (typical)				
Trigger Sensitivity with Edge Trigger (Ch 1–4 + external, DC, AC, and LFrej coupling)	2 div @ < 400 MHz 1 div @ < 200 MHz	2 div @ < 600 MHz 1 div @ < 200 MHz	2 div @ < 600 MHz 1 div @ < 200 MHz	2 div @ < 1 GHz 1 div @ < 200 MHz	2 div @ < 2 GHz 1 div @ < 200 MHz
Max. Trigger Frequency with SMART Trigger (Ch 1–4 + external)	400 MHz @ ≥ 10 mV	600 MHz @ ≥ 10 mV	600 MHz @ ≥ 10 mV	1 GHz @ ≥ 10 mV	2 GHz @ ≥ 10 mV
External Trigger Range	EXT/10 ±4 V; EXT ±400 mV				

### BASIC TRIGGERS

Edge Triggers when signal meets slope (positive, negative, or Window) and level condition.

### SMART TRIGGERS

State or Edge Qualified	Triggers on any input source only if a defined state or edge occurred on another input source. Delay between sources is selectable by time or events.
Dropout	Triggers if signal drops out for longer than selected time between 1 ns and 20 s.
Pattern	Logic combination (AND, NAND, OR, NOR) of 5 inputs (4 channels and external trigger input – 2 Ch+EXT on WaveRunner 62Xi). Each source can be high, low, or don't care. The High and Low level can be selected independently. Triggers at start or end of the pattern.
TV-Composite Video	Triggers selectable fields (1, 2, 4, or 8), Positive or Negative slope, or Line (up to 1500), for NTSC, PAL, SECAM, or non-standard video (up to 1500 lines).

### SMART TRIGGERS WITH EXCLUSION TECHNOLOGY

Glitch and Pulse Width	Triggers on positive or negative glitches with widths selectable from 500 ps to 20 s or on intermittent faults (subject to bandwidth limit of oscilloscope).
Signal or Pattern Interval	Triggers on intervals selectable between 1 ns and 20 s.
Timeout (State/Edge Qualified)	Triggers on any source if a given state (or transition edge) has occurred on another source. Delay between sources is 1 ns to 20 s, or 1 to 99,999,999 events.
Runt	Trigger on positive or negative runts defined by two voltage limits and two time limits. Select between 1 ns and 20 s.
Slew Rate	Trigger on edge rates. Select limits for dV, dt, and slope. Select edge limits between 1 ns and 20 s.
Exclusion Triggering	Trigger on intermittent faults by specifying the normal width or period.

## WAVERUNNER Xi SERIES

### LECROY WAVESTREAM FAST VIEWING MODE

Intensity	256 Intensity Levels, 1–100% adjustable via front panel control
Number of Channels	up to 4 simultaneously
Max Sampling Rate	5 GS/s (10 GS/s for WaveRunner 62Xi, 64Xi, 104Xi, 204Xi in interleaved mode)
Waveforms/second (continuous)	up to 8000 waveforms/second
Operation	Front panel toggle between normal real-time mode and LeCroy WaveStream Fast Viewing mode

### AUTOMATIC SETUP

Auto Setup	Automatically sets timebase, trigger, and sensitivity to display a wide range of repetitive signals.
Vertical Find Scale	Automatically sets the vertical sensitivity and offset for the selected channels to display a waveform with maximum dynamic range.

PROBES	WAVERUNNER 44Xi	WAVERUNNER 64Xi	WAVERUNNER 62Xi	WAVERUNNER 104Xi	WAVERUNNER 204Xi
Probes	One PP008 per channel standard; Optional passive and active probes available.			One PP007 per channel standard; Optional passive and active probes available.	
Probe System; ProBus	Automatically detects and supports a variety of compatible probes.				
Scale Factors	Automatically or manually selected, depending on probe used				

### COLOR WAVEFORM DISPLAY

Type	Color 10.4" flat-panel TFT-LCD with high resolution touch screen
Resolution	SVGA; 800 x 600 pixels; maximum external monitor output resolution of 2048 x 1536 pixels
Number of Traces	Display a maximum of 8 traces. Simultaneously display channel, zoom, memory, and math traces.
Grid Styles	Auto, Single, Dual, Quad, Octal, XY, Single + XY, Dual + XY
Waveform Styles	Sample dots joined or dots only in real-time mode

### ZOOM EXPANSION TRACES

Display up to 4 Zoom/Math traces with 16 bits/data point)

### INTERNAL WAVEFORM MEMORY

M1, M2, M3, M4 Internal Waveform Memory (store full-length waveform with 16 bits/data point) or store to any number of files limited only by data storage media.

### SETUP STORAGE

Front Panel and Instrument Status	Store to the internal hard drive, over the network, or to a USB-connected peripheral device.
-----------------------------------	--

### INTERFACE

Remote Control	Via Windows Automation, or via LeCroy Remote Command Set
GPIO Port (Accessory)	Supports IEEE – 488.2
Ethernet Port	10/100/1000Base-T Ethernet interface (RJ-45 connector)
USB Ports	5 USB 2.0 ports (one on front of instrument) supports Windows-compatible devices.
External Monitor Port	Standard 15-pin D-Type SVGA-compatible DB-15; connect a second monitor to use extended desktop display mode with XGA resolution.
Serial Port	DB-9 RS-232 port (not for remote oscilloscope control)



## WAVERUNNER Xi SERIES

AUXILIARY INPUT	WAVERUNNER 44Xi	WAVERUNNER 64Xi	WAVERUNNER 62Xi	WAVERUNNER 104Xi	WAVERUNNER 204Xi
Signal Types	Selected from External Trigger or External Clock input on front panel				
Coupling	50 Ω: DC, 1 MΩ: AC, DC, GND				
Maximum Input Voltage	50 Ω: 5 V <sub>rms</sub> , 1 MΩ: 400 V max. (DC + Peak AC ≤ 5 kHz)			50 Ω: 5 V <sub>rms</sub> , 1 MΩ: 250 V max. (DC + Peak AC ≤ 10 kHz)	

### AUXILIARY OUTPUT

Signal Type	Trigger Enabled, Trigger Output. Pass/Fail, or Off
Output Level	TTL, ≈3.3 V
Connector Type	BNC, located on rear panel

### GENERAL

Auto Calibration	Ensures specified DC and timing accuracy is maintained for 1 year minimum.
Calibrator	Output available on front panel connector provides a variety of signals for probe calibration and compensation.
Power Requirements	90–264 V <sub>rms</sub> at 50/60 Hz; 115 V <sub>rms</sub> (±10%) at 400 Hz, Automatic AC Voltage Selection Installation Category: 300V CAT II; Max. Power Consumption: 340 VA/340 W; 290 VA/290 W for WaveRunner 62Xi

### ENVIRONMENTAL

Temperature: Operating	+5 °C to +40 °C
Temperature: Non-Operating	-20 °C to +60 °C
Humidity: Operating	Maximum relative humidity 80% for temperatures up to 31 °C decreasing linearly to 50% relative humidity at 40 °C
Humidity: Non-Operating	5% to 95% RH (non-condensing) as tested per MIL-PRF-28800F
Altitude: Operating	Up to 2,000 m
Altitude: Non-Operating	12,190 m

### PHYSICAL

Dimensions (HWD)	260 mm x 340 mm x 152 mm Excluding accessories and projections (10.25" x 13.4" x 6")
Net Weight	6.95 kg. (15.5 lbs.)

### CERTIFICATIONS

CE Compliant, UL and cUL listed; Conforms to EN 61326, EN 61010-1, UL 61010-1 2nd Edition, and CSA C22.2 No. 61010-1-04.

### WARRANTY AND SERVICE

3-year warranty; calibration recommended annually. Optional service programs include extended warranty, upgrades, calibration, and customization services.

## WAVERUNNER Xi SERIES

### ORDERING INFORMATION

### PRODUCT CODE

#### WAVERUNNER Xi SERIES OSCILLOSCOPES

2 GHz, 4 Ch, 5 GS/s, 10 Mpts/Ch (10 GS/s, 20 Mpts/Ch in interleaved mode) with 10.4" Color Touch Screen Display	WaveRunner 204Xi
1 GHz, 4 Ch, 5 GS/s, 10 Mpts/Ch (10 GS/s, 20 Mpts/Ch in interleaved mode) with 10.4" Color Touch Screen Display	WaveRunner 104Xi
600 MHz, 4 Ch, 5 GS/s, 10 Mpts/Ch (10 GS/s, 20 Mpts/Ch in interleaved mode) with 10.4" Color Touch Screen Display	WaveRunner 64Xi
600 MHz, 2 Ch, 5 GS/s, 10 Mpts/Ch (10 GS/s, 20 Mpts/Ch in interleaved mode) with 10.4" Color Touch Screen Display	WaveRunner 62Xi
400 MHz, 4 Ch, 5 GS/s, 10 Mpts/Ch (20 Mpts/Ch in interleaved mode) with 10.4" Color Touch Screen Display	WaveRunner 44Xi

#### INCLUDED WITH STANDARD CONFIGURATION

÷10 HiZ 500 MHz Passive Probe (Total of 1 Per Channel)
Getting Started Manual and Quick Reference Guide
CD-ROMs containing Utility Software
Optical 3-button Wheel Mouse – USB
Standard Ports; 10/100Base-T Ethernet, USB 2.0 (5), SVGA Video out, Audio in/out, RS-232
Protective Front Cover
Accessory Pouch
Standard Commercial Calibration and Performance Certificate
3-Year Warranty

#### MEMORY OPTIONS

12.5 Mpts/Ch (25 Mpts/Ch Interleaved) (for use with 2 Ch WaveRunner Xi)	WRXi-VL2
12.5 Mpts/Ch (25 Mpts/Ch Interleaved) (for use with 4 Ch WaveRunner Xi)	WRXi-VL

#### SOFTWARE OPTIONS

##### General Purpose Software Options

Statistics Software Package	WRXi-STAT
Master Analysis Software Package	WRXi-XMAP
Advanced Math Software Package	WRXi-XMATH
Intermediate Math Software Package	WRXi-XWAV
Value Analysis Software Package (Includes XWAV and JTA2)	WRXi-XVAP
Advanced Customization Software Package	WRXi-XDEV
Processing Web Editor Software Package	WRXi-XWEB

##### Application Specific Test and Analysis Options

Jitter and Timing Analysis Software Package	WRXi-JTA2
Digital Filter Software Package	WRXi-DFP2
Disk Drive Measurement Software Package	WRXi-DDM2
PowerMeasure Analysis Software Package	WRXi-PMA2
Serial Data Mask Software Package	WRXi-SDM
EMC Pulse Parameter Software Package	WRXi-EMC
Electrical Telecom Mask Test Package	ET-PMT

## WAVERUNNER Xi SERIES

### ORDERING INFORMATION

### PRODUCT CODE

#### SERIAL DATA OPTIONS

I <sup>2</sup> C Trigger and Decode Option	WRXi-I2Cbus TD
SPI Trigger and Decode Option	WRXi-SPIbus TD
CANbus TD Trigger and Decode Option	CANbus TD
CANbus TDM Trigger, Decode, and Measure/Graph Option	CANbus TDM

A variety of Vehicle Bus Analyzers based on the WaveRunner Xi platform are available. These units are equipped with a Symbolic CAN trigger and decode.

#### MIXED SIGNAL OSCILLOSCOPE OPTION

32 Digital Channel Oscilloscope Mixed Signal Option (for use with 4 Ch WRXi only)	MS-32
--	-------

#### PROBES AND AMPLIFIERS\*

2.5 GHz, 0.7 pF Active Probe	HFP2500
(Qty. 4) 1.5 GHz, 0.9 pF, 1 M $\Omega$ High Impedance Active Probe	ZS1500-QUADPAK
(Qty. 4) 1 GHz, 0.9 pF, 1 M $\Omega$ High Impedance Active Probe	ZS1000-QUADPAK
1 GHz Active Differential Probe ( $\div 1$ , $\div 10$ , $\div 20$ )	AP034
500 MHz Active Differential Probe (x10, $\div 1$ , $\div 10$ , $\div 100$ )	AP033
30 A; 100 MHz Current Probe – AC/DC; 30 A <sub>rms</sub> ; 50 A <sub>peak</sub> Pulse	CP031
30 A; 50 MHz Current Probe – AC/DC; 30 A <sub>rms</sub> ; 50 A <sub>peak</sub> Pulse	CP030
30 A; 50 MHz Current Probe – AC/DC; 30 A <sub>rms</sub> ; 50 A <sub>peak</sub> Pulse	AP015
150 A; 10 MHz Current Probe – AC/DC; 150 A <sub>rms</sub> ; 500 A <sub>peak</sub> Pulse	CP150
500 A; 2 MHz Current Probe – AC/DC; 500 A <sub>rms</sub> ; 700 A <sub>peak</sub> Pulse	CP500
1,400 V, 100 MHz High-Voltage Differential Probe	ADP305
1,400 V, 20 MHz High-Voltage Differential Probe	ADP300
1 Ch, 100 MHz Differential Amplifier	DA1855A

A wide variety of other passive, active, and differential probes are also available. Consult LeCroy for more information.

#### HARDWARE ACCESSORIES

External GPIB Interface	WS-GPIB
Soft Carrying Case	WRXi-SOFTCASE
Hard Transit Case	WRXi-HARDCASE
Mounting Stand – Desktop Clamp Style	WRXi-MS-CLAMP
Rackmount Kit	WRXi-RACK
Mini Keyboard	WRXi-KYBD

A variety of local language front panel overlays are also available.

## WAVERUNNER® 6000A SERIES

The WaveRunner® 6000A Series is the best oscilloscope available for everyday signal testing. Advanced acquisition technology delivers exceptionally accurate measurements, while out-of-the-box capabilities and outstanding timing resolution rival that of oscilloscopes at twice the cost. The WaveRunner 6000A Series is powered by the same SiGe chipset used in LeCroy's higher bandwidth oscilloscopes.

### Features:

- Bandwidths from 350 MHz to 2 GHz
- Sample rates of 2.5 to 10 GS/s
- Standard memory of 4 Mpts/Ch
- All channels expandable to 12 Mpts
- Up to 24 Mpts when interleaved
- High sample rate to capture high frequency transients and sharp edges
- Very low residual jitter (2 ps typical)
- Ultra-stable clock ( $\pm 5$  ppm)

The WaveRunner 6000A SMART Trigger technology provides the flexibility to quickly trigger and locate the specific signal characteristic or pattern you want at the touch of a button.

### Capabilities:

- Exclusion/inclusion feature triggers on signals outside, or within, a specific range of pulse widths.
- Selecting multiple threshold levels and pulse widths quickly catches the waveform for viewing and measuring.
- Memory retains thousands of acquired events for viewing at your leisure.
- Replay signal history, scan, and search from sweep to sweep.

### An Outstanding Scope Experience

WaveRunner lets you focus on understanding your signal rather than setting up your scope. The WaveRunner 6000A's uniquely efficient interface is the result of input received from hundreds of scope users about features and functionality that would facilitate usage in the everyday workplace:

- **Bright Display** – All WaveRunner 6000A Series oscilloscopes include a crisp and bright SVGA screen with 800 x 600 pixels for superior resolution. It's the best resolution available for this class of scope.
- **One-touch Efficiency** – The descriptor labels show the oscilloscope settings and status. Touch the screen once to open a setup dialog and change settings. Quickly measure a signal's timing characteristics. Touch "Measure" and "Horizontal" to see multiple common timing parameters. Math, histograms, statistics, and other analysis tools are all within two touches.
- **Dedicated Vertical Controls** – Each channel has its own volts per division (V/div) control knob. You can control any channel by turning the knob—eliminating the need to multiplex a single V/div control across all four channels.
- **Intensity Modulated Display** – Display intensity can be adjusted from 0–100% to enable a better view of underlying glitches, runts, or signal modulation in long record captures. The perfect accompaniment to the WaveRunner 6000A oscilloscope's long memory.
- **Cursor Knobs** – Need a quick measurement? Just turn the cursor knob to bring up a pair of vertical cursors to measure timing relationships and quickly characterize the waveform.



WAVERUNNER 6000A

### WaveScan Advanced Search

#### Locate Problems Triggers Won't Find

*WaveScan is a powerful tool that provides the ability to locate unusual events in a single capture, or scan for an event in many acquisitions over a long period of time using more than 20 different search/scan modes. WaveScan uses measurement-based scanning modes, like frequency, to show statistical distribution of events. It overlays events for a quick and simple visual comparison.*



## WAVERUNNER® 6000A SERIES

- **Zoom Control Knobs** – Need a closer look at your signal? Push the QuickZoom button. Four dedicated knobs (zoom and offset in horizontal and vertical directions) make it easy to navigate any trace—from broad relationships to minute details.
- **“Push” Knobs** – WaveRunner rotating knobs control functions, but pushing them invokes further functionality. Push the trigger level; the scope selects the correct setting for a stable display. Push the offset button; your scope instantly zeroes the offset, restoring the waveform clearly in the middle of the screen. Another push restores the offset.
- **Handy, Front Accessible USB Port** – Use a memory stick to transfer your captured waveforms, or take your setup from scope to scope to automatically load your configuration. In addition, with one USB port on the front panel and four more on the back, you can connect a variety of plug-n-play peripheral and memory devices.

### Standard Math Tools

Display up to four math function traces (F1–F4). The easy-to-use graphical interface simplifies setup of up to two operations on each function trace, and function traces can be chained together to perform math-on-math.

absolute value	exp (base e)	ratio (/)
average (summed)	exp (base 10)	reciprocal
average (continuous)	fft (power spectrum, magnitude, phase, up to 50 kpts)	rescale (with units)
custom (MATLAB, Mathcad, VBScript) – limited points	floor	roof
derivative	histogram of 1000 events	(sinx)/x
des skew (resample)	integral	square
difference (–)	invert (negate)	square root
enhanced resolution (to 11 bits vertical)	log (base e)	sum (+)
envelope	log (base 10)	trend (datalog) of 1000 events
	product (x)	zoom (identity)

### Standard Measure Tools

Display any 6 parameters together with statistics, including their average, high, low, and standard deviations. Histicons provide a fast, dynamic view of parameters and waveshape characteristics.

amplitude	first	phase
area	frequency	risetime (10–90%, 20–80% @level)
base	last	rms
cycles	level@x	std. deviation
custom (MATLAB, Mathcad, VBScript) – limited points	maximum	time @level
delay	mean	top
Δ delay	median	Δ time@level
duration	minimum	Δ time@level from trigger
duty cycle	number of points	width (positive + negative)
falltime (90–10%, 80–20% @level)	+overshoot	x@max.
	–overshoot	x@min.
	peak-to-peak	
	period	

### Pass/Fail Testing

Simultaneously test multiple parameters against selectable parameter limits or pre-defined masks. Pass or fail conditions can initiate actions including document to local or networked files, e-mail the image of the failure, save waveforms, send a pulse out at the rear panel auxiliary BNC output, or (with the GPIB option) send a GPIB SRQ.

## WAVERUNNER® 6000A SERIES

### WAVERUNNER 6000A SOFTWARE OPTIONS

#### **ADVANCED MATH AND WAVESHAPE ANALYSIS**

##### **Master Analysis Software Package (XMAP)**

This package provides maximum capability and flexibility, and includes all the functionality present in XMATH, XDEV, and JTA2.

##### **Advanced Math Software Package (XMATH)**

This package provides a comprehensive set of WaveShape Analysis tools providing insight into the waveshape of complex signals. Additional capability provided by XMATH includes:

- Parameter math – add, subtract, multiply, or divide two different parameters.  
Invert a parameter and rescale parameter values.
- Histograms expanded with 19 histogram parameters and up to 2 billion events
- Trend (datalog) of up to 1 million events
- Track graphs of any measurement parameter
- FFT capability added to include: power averaging, power density, real and imaginary components, frequency domain parameters, and FFT on up to 24 Mpts.
- Persistence histogram
- Persistence trace (mean, sigma, range)
- Narrow-band power measurements
- Auto-correlation function
- Sparse function
- Cubic Interpolation function

##### **Advanced Customization Software Package (XDEV)**

This package provides a set of tools to modify the scope and customize it to meet your unique needs. Additional capability provided by XDEV includes:

- Creation of your own measurement parameter or math function, using third-party software packages, and display the result in the scope. Supported third-party software packages include:
  - VBScript
  - MATLAB
  - Excel
  - Mathcad
- CustomDSO – create your own user interface in a scope dialog box.
- Addition of macro keys to run VBScript files
- Support for plug-ins

## WAVERUNNER® 6000A SERIES

### ADVANCED MATH AND WAVESHAPE ANALYSIS (CONTINUED)

#### Value Analysis Software Package (XVAP)

XVAP adds the following capabilities:

##### Measurements:

- Jitter and Timing parameters (period@level, width@level, edge@level, duty@level, time interval error@level, frequency@level, half period, setup, skew,  $\Delta$  period@level,  $\Delta$  width@level).

##### Math:

- Persistence histogram
- Persistence trace (mean, sigma, range)
- 1 Mpts FFTs with power spectrum density, power averaging, real, imaginary, and real+imaginary settings

##### Statistical and Graphical Analysis:

- 1 Mpts Trends and Histograms
- 19 histogram parameters
- Track graphs of any measurement parameter

#### Intermediate Math Software Package (XWAV)

XWAV adds the following capabilities:

##### Math:

- 1 Mpts FFTs with power spectrum density, power averaging, real, and imaginary components

##### Statistical and Graphical Analysis:

- 1 Mpts Trends and Histograms
- 19 histogram parameters
- Track graphs of any measurement parameter

### APPLICATION SPECIFIC TEST AND ANALYSIS PACKAGES

#### Jitter and Timing Analysis Software Package (JTA2)

This package provides jitter timing and analysis using time, frequency, and statistical views for common timing parameters, and also includes other useful tools. JTA2 includes:

- Jitter and timing parameters, with "Track" graphs of
 

– Cycle-Cycle Jitter	– Period	– Hold
– N-Cycle	– Half Period	– Skew
– N-Cycle with start selection	– Width	– Duty Cycle
– Frequency	– Time Interval Error	– Duty Cycle Error
	– Setup	
- Edge@lv parameter (counts edges)
- Histograms expanded with 19 histogram parameters and up to 2 billion events
- Trend (datalog) of up to 1 million events
- Track graphs of all parameters
- Persistence histogram, persistence trace (mean, range, sigma)

## WAVERUNNER® 6000A SERIES

### APPLICATION SPECIFIC TEST AND ANALYSIS PACKAGES (CONTINUED)

#### Digital Filter Software Package (DFP2)

LeCroy's Digital Filter Package (DFP2) implements a set of linear-phase Finite Impulse Response (FIR) filters and IIR filters. It enhances your ability to examine important signal components by filtering out undesired spectral components such as noise. With the custom design feature, corrupted signals can be reconstructed by applying matched (mirror) filters to compensate for known distortions.

The DFP2 option has a broad range of applications:

- System Identification
- Prediction
- Noise Cancellation
- Low-pass Filters
- Band-stop Filters
- Band-pass Filters
- High-pass Filters
- Raised Cosine, Raised Root Cosine, and Gaussian Filters

#### PowerMeasure Analysis Package (PMA2)

This package provides exceptional ability to measure and analyze the operating characteristics of power conversion devices and circuits.

- Automatic setup and display of relevant waveforms and parameters
- Waveforms scaled and displayed in volts, amps, watts, ohms, etc.
- Power device performance analyzed in-circuit
- Measure and view time domain response of the entire control loop
- Pre-compliance line harmonic testing to EN 61000-3-2
- Complete solutions available including probes and differential amplifiers

#### EMC Pulse Parameter Software Package (WR6-EMC)\*

This package includes enhanced Rise@level, Fall@level, and Width@level parameters. The new functionality in the WR6-EMC software package includes user definable thresholds for accurate pulse measurements.

\*WR6-EMC is compatible with all WaveRunner 6000A oscilloscopes except the WR6030A.



## WAVERUNNER® 6000A SERIES

### APPLICATION SPECIFIC TEST AND ANALYSIS PACKAGES (CONTINUED)

#### Disk Drive Measurements Package (DDM2)

This package provides disk drive parameter measurements and related mathematical functions for performing disk drive WaveShape Analysis.

- Disk Drive Parameters are as follows

amplitude asymmetry	local time at minimum	pulse width 50–
local base	local time at maximum	pulse width 50+
local baseline separation	local time peak-trough	resolution
local maximum	local time over threshold	track average amplitude
local minimum	local time trough-peak	track average amplitude–
local number	local time under threshold	track average amplitude+
local peak-peak	narrow band phase	auto-correlation s/n
local time between events	narrow band power	non-linear transition shift
local time between peaks	overwrite	
local time between troughs	pulse width 50	

- Correlation function
- Trend (datalog) of up to 1 million events
- Histograms expanded with 18 histograms parameters and up to 2 billion events

#### CANbus TDM Trigger, Decode, and Measure/Graph Testing Option (CANbus TDM)

- Trigger Module with TC251-OPTO optically isolated Trigger Coupler installed (and room for one additional Trigger Coupler). Trigger Couplers are interchangeable.
- CANbus TD Series Oscilloscope Interface Module with 1.0 meter connection cable. Connects Trigger Module to LeCroy oscilloscope ProBus interface.
- Storage case with accessories (other accessories may be required)
- Software for
  - Trigger Setup
  - CAN Protocol Decode
  - CAN Measurement, (CAN-analog, CAN-CAN, and Time@CAN timing parameters, CAN bus load% and CAN-Value Data Extraction parameters)
  - Histogramming (up to 2 billion events)
  - Graphing (Track and Trend).

#### CANbus TD Trigger and Decode Testing Option (CANbus TD)

- Same hardware package as CANbus TDM
- Software for only
  - Trigger Setup
  - CAN Protocol Decode

#### Oscilloscope Mixed Signal Option (MS-32)\*

32 Digital Channel Oscilloscope Mixed Signal Option. Gripper probe accessories are recommended.

\*MS-32 is compatible only with WR6000A 4-channel oscilloscopes.

## WAVERUNNER® 6000A SERIES

SPECIFICATIONS	WAVERUNNER 6030A	WAVERUNNER 6050A	WAVERUNNER 6051A	WAVERUNNER 6100A	WAVERUNNER 6200A
<b>VERTICAL SYSTEM</b>					
Nominal Analog Bandwidth @ 50 Ω, 10 mV-1 V/div	350 MHz	500 MHz	500 MHz	1 GHz	2 GHz
Rise Time (Typical)	1 ns	750 ps	750 ps	300 ps	200 ps
Input Channels	4	4	2	4	4
Bandwidth Limiters	20 MHz; 200 MHz				
Input Impedance	1 MΩ    20 pF (10 MΩ    9.5 pF using PP007 probe)				
Input Coupling	50 Ω: DC, 1MΩ: AC, DC, GND				
Maximum Input Voltage	50 Ω: 5 V <sub>rms</sub> , 1 MΩ: 250 V max. (Peak AC: ≤ 10 kHz + DC)				
Channel to Channel Isolation	> 40 dB @ < 100 MHz (> 30 dB @ full bandwidth)				
Vertical Resolution	8 bits; up to 11 with enhanced resolution (ERES)				
Sensitivity	50 Ω: 2 mV/div–1 V/div fully variable; 1 MΩ: 2 mV–10 V/div fully variable				
DC Accuracy	±1.0% of full scale (typical); ±1.5% of full scale, ≥ 10 mV/div (warranted)				
Offset Range	50 Ω: ±400 mV @ 2–4.95 mV/div ±1 V @ 5–100 mV/div ±10 V @ 102 mV/div–1 V/div 1 MΩ: ±400 mV @ 2–4.95 mV/div ±1 V @ 5–100 mV/div ±10 V @ 102 mV/div–1 V/div ±100 V @ 1.02 V/div–10 V/div				
Offset Accuracy	±(1.5% of offset value + 0.5% of full scale + 1 mV) all fixed gain setting < 2 V/div ±(1.5% of offset value + 1.0% of full scale + 1 mV) for variable and V/div settings ≥ 2 V/div				
Input Connector	ProBus/BNC				
<b>TIMEBASE SYSTEM</b>					
Timebases	Internal timebase common to all input channels; an external clock may be applied at the auxiliary input				
Time/Division Range	Real time: 200 ps/div – 10 s/div, RIS mode: to 20 ps/div, Roll mode: up to 1,000 s/div				
Clock Accuracy	≤ 5 ppm @ 25 °C (≤ 10 ppm @ 5–40 °C)				
Sample Rate and Delay Time Accuracy	Equal to Clock Accuracy				
Trigger and Interpolator Jitter	≤ 3 ps rms (typical)				
Time Interval Accuracy	Clock Accuracy + Jitter				
Channel to Channel Deskew Range	±9 X time/div setting, 100 ms max., each channel				
External Sample Clock	DC to 1 GHz; 50 Ω, (limited BW in 1 MΩ), BNC input, limited to 2 Ch operation (1 Ch in WR6051A), (minimum rise time and amplitude requirements apply at low frequencies)				
Roll Mode	User selectable. Available at lower time/div settings.				
<b>ACQUISITION SYSTEM</b>					
Single-Shot Sample Rate/Ch	2.5 GS/s	5 GS/s	5 GS/s	5 GS/s	5 GS/s
Interleaved Sample Rate (2 Ch)	5 GS/s	N/A	N/A	10 GS/s	10 GS/s
Random Interleaved Sampling (RIS)	200 GS/s				
Trigger Rate	125,000 waveforms/second				
Sequence Time Stamp Resolution	1 ns				
Minimum Time Between Sequential Segments	8 μs				

**WAVERUNNER® 6000A SERIES**

<b>ACQUISITION SYSTEM (CONTINUED)</b>	<b>WAVERUNNER 6030A</b>	<b>WAVERUNNER 6050A</b>	<b>WAVERUNNER 6051A</b>	<b>WAVERUNNER 6100A</b>	<b>WAVERUNNER 6200A</b>
Acquisition Memory Options	Max. Acquisition Points (4 Ch/2 Ch, 2 Ch/1 Ch in WR6051A)			Segments (Sequence Mode)	
Standard	4M/8M			1000	
Option L	8M/16M			5000	
Option VL	12M/24M			10,000	

**ACQUISITION PROCESSING**

Time Resolution (min., Single-shot)	200 ps (5 GS/s)	100 ps (10 GS/s)
Averaging	Summed and continuous averaging to 1 million sweeps	
ERES	From 8.5 to 11 bits vertical resolution	
Envelope (Extrema)	Envelope, floor, or roof for up to 1 million sweeps	
Interpolation	Linear or Sin x/x	

**TRIGGER SYSTEM**

Trigger Modes	Normal, Auto, Single, Stop				
Sources	Any input channel, External, Ext/10, or Line; slope and level unique to each source, except Line.				
Trigger Coupling	DC				
Pre-trigger Delay	0–100% of memory size (adjustable in 1% increments, or 100 ns)				
Post-trigger Delay	Up to 10,000 divisions in real time mode, limited at slower time/div settings in roll mode				
Hold-off	2 ns to 20 s or 1 to 1,000,000,000 events				
Internal Trigger Level Range	±4.1 div from center (typical)				
Trigger Sensitivity with Edge Trigger (Ch 1–4 + external)	2 div @ < 350 MHz, 1 div @ < 250 MHz	2 div @ < 500 MHz, 1 div @ < 350 MHz	2 div @ < 500 MHz, 1 div @ < 350 MHz	2 div @ < 1 GHz, 1 div @ < 750 MHz	2 div @ < 2 GHz, 1 div @ < 1.8 GHz
Max. Trigger Frequency with SMART Trigger (Ch 1–4 + external)	350 MHz @ ≥ 10 mV	500 MHz @ ≥ 10 mV	500 MHz @ ≥ 10 mV	750 MHz @ ≥ 10 mV	750 MHz @ ≥ 10 mV
Trigger Level DC Accuracy	±4% full scale ±2 mV (typical)				
External Trigger Range	EXT/10 ±4 V; EXT ±400 mV				

**BASIC TRIGGERS**

Edge	Triggers when signal meets slope (positive or negative) and level condition.
------	--

**SMART TRIGGERS**

State or Edge Qualified	Triggers on any input source only if a defined state or edge occurred on another input source. Delay between sources is selectable by time or events.
Dropout	Triggers if signal drops out for longer than selected time between 2 ns and 20 s.
Pattern	Logic combination (AND, NAND, OR, NOR) of 5 inputs (4 channels and external trigger input – 2 Ch+EXT on WR6051A). Each source can be high, low, or don't care. The high and low level can be selected independently. Triggers at start or end of the pattern.

**SMART TRIGGERS WITH EXCLUSION TECHNOLOGY**

Glitch and Pulse Width	Triggers on positive or negative glitches with widths selectable from 600 ps to 20 s or on intermittent faults (subject to bandwidth limit of oscilloscope).
Signal or Pattern Interval	Triggers on intervals selectable between 2 ns and 20 s.
Timeout (State/Edge Qualified)	Triggers on any source if a given state (or transition edge) has occurred on another source. Delay between sources is 2 ns to 20 s, or 1 to 99,999,999 events.
Exclusion Triggering	Trigger on intermittent faults by specifying the normal width or period.

## WAVERUNNER® 6000A SERIES

### AUTOMATIC SETUP

Auto Setup	Automatically sets timebase, trigger, and sensitivity to display a wide range of repetitive signals.
Vertical Find Scale	Automatically sets the vertical sensitivity and offset for the selected channels to display a waveform with maximum dynamic range.

### PROBES

Probes	One PP007-WR-1 per channel standard; Optional passive and active probes available.
Probe System; ProBus	Automatically detects and supports a variety of compatible probes.
Scale Factors	Automatically or manually selected, depending on probe used

### COLOR WAVEFORM DISPLAY

Type	Color 8.4" flat-panel TFT-LCD with high resolution touch screen
Resolution	SVGA; 800 x 600 pixels
Number of Traces	Display a maximum of 8 traces. Simultaneously display channel, zoom, memory, and math traces.
Grid Styles	Auto, Single, Dual, Quad, Octal, XY, Single + XY, Dual + XY
Waveform Styles	Sample dots joined or dots only

### ANALOG PERSISTENCE DISPLAY

Analog and Color-Graded Persistence	Variable saturation levels; stores each trace's persistence data in memory.
Persistence Selections	Select analog, color, or three-dimensional.
Trace Selection	Activate persistence on all or any combination of traces.
Persistence	Aging time select from 500 ms to infinity.
Sweeps Displayed	All accumulated, or all accumulated with last trace highlighted.

### ZOOM EXPANSION TRACES

Display up to 4 Zoom/Math traces

### CPU

Processor	Intel® Celeron®, 2.0 GHz or better.
Processing Memory	256 MB on Std and M option; 512 MB with L and VL options
Operating System	Microsoft Windows® XP Professional

### INTERNAL WAVEFORM MEMORY

M1, M2, M3, M4 Internal Waveform Memory (store full-length waveform with 16 bits/data point) or store to any number of files limited only by data storage media.

### SETUP STORAGE

Front Panel and Instrument Status	Store to the internal hard drive, over the network, or to a USB-connected peripheral device.
-----------------------------------	--

### INTERFACE

Remote Control	Via Windows Automation, or via LeCroy Remote Command Set
GPIB Port (Optional)	Supports IEEE – 488.2
Ethernet Port	10/100Base-T Ethernet interface (RJ-45 connector)
USB Ports	5 USB 2.0 ports (one on front of instrument) supports Windows-compatible devices.
External Monitor Port	Standard 15-pin D-Type SVGA-compatible DB-15; connect a second monitor to use dual-monitor display mode.
Parallel Port	Standard DB-25
Serial Port	DB-9 RS-232 port (not for remote oscilloscope control)



## WAVERUNNER® 6000A SERIES

### AUXILIARY INPUT

Signal Types	Selected from External Trigger or External Clock input on front panel
Coupling	50 $\Omega$ : DC, 1 M $\Omega$ : AC, DC, GND
Maximum Input Voltage	50 $\Omega$ : 5 V <sub>rms</sub> , 1 M $\Omega$ : 250 V max. (Peak AC: $\leq$ 10 kHz + DC)

### AUXILIARY OUTPUT

Signal Type	Trigger Enabled, Trigger Output, Pass/Fail, or Off
Output Level	TTL, $\approx$ 3.3 V
Connector Type	BNC, located on rear panel

### GENERAL

Auto Calibration	Ensures specified DC and timing accuracy is maintained for 1 year minimum.
Calibrator	Output available on front panel connector provides a variety of signals for probe calibration and compensation.
Power Requirements	100–240 V <sub>rms</sub> at 50/60 Hz; 115 V <sub>rms</sub> ( $\pm$ 10%) at 400 Hz, Automatic AC Voltage Selection Installation Category: 300V CAT II; Max. Power Consumption: 400 VA/400 W; 350 VA/350 W for WaveRunner 6051A

### ENVIRONMENTAL

Temperature: Operating	+5 °C to 40 °C
Temperature: Non-Operating	-20 °C to +60 °C
Humidity: Operating	5% to 80% RH (non-condensing) up to 30 °C, Upper limit derates linearly to 45% RH (non-condensing) at 40 °C
Humidity: Non-Operating	5% to 95% RH (non-condensing) as tested per MIL-PRF-28800F
Altitude: Operating	3,048 m (10,000 ft.) max. at $\leq$ 25 °C
Altitude: Non-Operating	12,190 m (40,000 ft.)

### PHYSICAL DIMENSIONS

Dimensions (HWD)	211 mm x 355 mm x 363 mm (excluding feet) 8.3" x 13.8" x 14.3"
Net Weight	10 kg. (22 lbs.), excluding printer
Shipping Weight	less than 13.6 kg. (30 lbs.)

### CERTIFICATIONS

CE Compliant, UL and cUL listed; Conforms to EN 61326-1, EN 61010-1, UL 3111-1, and CSA C22.2 No. 1010.1.

### WARRANTY AND SERVICE

3-year warranty; calibration recommended annually.  
Optional service programs include extended warranty, upgrades, calibration, and customization services.

## WAVERUNNER® 6000A SERIES

### ORDERING INFORMATION

	PRODUCT CODE
2 GHz, 4 Ch, 5 GS/s, 4 Mpts/Ch; 10 GS/s, (8 Mpts using 2 or 1 Ch) Color with Windows XP Pro	WaveRunner 6200A
1 GHz, 4 Ch, 5 GS/s, 4 Mpts/Ch; 10 GS/s (8 Mpts using 2 or 1 Ch) Color with Windows XP Pro	WaveRunner 6100A
500 MHz, 4 Ch, 5 GS/s, 4 Mpts/Ch (8 Mpts/2 Ch) Color with Windows XP Pro	WaveRunner 6050A
350 MHz, 4 Ch, 2.5 GS/s, 4 Mpts/Ch (5 GS/s, 8 Mpts/2 Ch) Color with Windows XP Pro	WaveRunner 6030A
500 MHz, 2 Ch, 5 GS/s, 4 Mpts/Ch (8 Mpts/1 Ch) Color with Windows XP Pro	WaveRunner 6051A

### INCLUDED WITH STANDARD CONFIGURATION

±10 HiZ 500 MHz Passive Probe (Total of 1 Per Channel)	PP007-WR-1
Getting Started Manual	
CD-ROM containing Operator's Manual, Remote Control Manual, and Automation Manual	
CD-ROMs containing Utility Software	
Optical 3-button Wheel Mouse – USB	
Standard Ports; 10/100Base-T Ethernet, USB 2.0 (5), Parallel, RS-232, SVGA Video out, Audio in/out	
Protective Front Cover	
Standard Commercial Calibration and Performance Certificate	
3-Year Warranty	

### MEMORY OPTIONS

24 Mpts max. when interleaved, 12 Mpts/Ch (for use with 4 Ch WaveRunner 6000A)	WR6-VL
24 Mpts max., 2 Ch 12 Mpts/Ch Memory Option (WR6051A only)	WR6-VL2
16 Mpts max. when interleaved, 8 Mpts/Ch (for use with 4 Ch WaveRunner 6000A)	WR6-L
16 Mpts max., 2 Ch 8 Mpts/Ch Memory Option (WR6051A only)	WR6-L2

### SOFTWARE OPTIONS

Master Analysis Software Package (includes JTA2, XMATH, and XDEV)	WR6-XMAP
Advanced Math Software Package	WR6-XMATH
Advanced Customization Software Package	WR6-XDEV
Value Analysis Software Package (includes XWAV and JTA2)	WR6-XVAP
Intermediate Math Software Package	WR6-XWAV
Processing Web Editor Software Package for Functions and Parameters	WR6-XWEB
Jitter and Timing Analysis Software Package	WR6-JTA2
PowerMeasure Analysis Software Package	WR6-PMA2
EMC Pulse Parameter Software Package (not applicable on WR6030A)	WR6-EMC
Digital Filter Software Package	WR6-DFP2
Disk Drive Measurement Software Package	WR6-DDM2
Ethernet Test Software Package (WR6200A only)	WR6-ENET
USB 2.0 Compliance Test Software Package (WR6200A only)	WR6-USB2
Serial Data Mask Software Package	WR6-SDM*
Master Analysis Software Package (includes JTA2, XMATH and XDEV)	WR6-XMAP

### SERIAL DATA OPTIONS

I <sup>2</sup> C Trigger and Decode Option	WR6-I2Cbus TD
SPI Trigger and Decode Option	WR6-SPIbus TD
CANbus TDM Trigger, Decode, and Measure/Graph Option	CANbus TDM
CANbus TD Trigger and Decode Option	CANbus TD

### HARDWARE AND SOFTWARE OPTION

32 Digital Channel Oscilloscope Mixed Signal Option	MS-32†
---	--------

\* WR6200A oscilloscope required for full mask testing capability; lower bandwidth models will have reduced capabilities.

†MS-32 is compatible only with WR6000A 4-channel oscilloscopes.

## WAVERUNNER® 6000A SERIES

### ORDERING INFORMATION

### PRODUCT CODE

#### HARDWARE OPTIONS AND ACCESSORIES

IEEE-488 GPIB Control Interface Upgrade	WR6-GPIB
Graphics Printer	WR6A-GP
Removable Hard Drive	WR6-RHD
CD-RW Upgrade	WR6-CDRW
USB Floppy Drive	WR6-FLPY
Hard Transit Case	WR6-HARD
Soft Carrying Case	WR6-SOFT
Rackmount, 6U High	WR6-RACK
Accessory Pouch	WR6-POUCH
Mini Keyboard, USB	WR6-KBD
USB Flash Memory	MEM-USB
Video Trigger Module	VT75
Oscilloscope Cart with Additional Shelf and Drawer	OC1024
Oscilloscope Cart	OC1021
Ethernet Compliance Test Fixture for 10Base-T	TF-10BT
Ethernet Compliance Test Fixture for 100Base-T/1000Base-T [includes a Set of 2 Test Fixtures Signals on Twisted Pair Cables (UTP)]	TF-ENET
Telecom Adapter Kit for 100 Ω Bal., 120 Ω Bal., 75 Ω Unbal.	TF-ET
USB 2.0 Testing Compliance Test Fixture	TF-USB

#### PROBES AND PROBE ACCESSORIES

(Qty. 4) 1.5 GHz, 0.9 pF, 1 MΩ High Impedance Active Probe	ZS1500-QUADPAK
(Qty. 4) 1 GHz, 0.9 pF, 1 MΩ High Impedance Active Probe	ZS1000-QUADPAK
2.5 GHz, 0.7 pF Active Probe ( $\div 10$ ), Small Form Factor	HFP2500
1.5 GHz, 0.7 pF Active Probe ( $\div 10$ ), Small Form Factor	HFP1500
1 GHz, 0.7 pF Active Probe ( $\div 10$ ), Small Form Factor	HFP1000
WaveLink 4 GHz, Differential Probe Adjustable Tip Module	D300A-AT*
WaveLink 4 GHz, 5 V Differential Probe Small Tip Module	D350ST*
WaveLink ProBus Probe Body	WL300
1 GHz, Active Differential Probe ( $\div 1$ , $\div 10$ , $\div 20$ )	AP034
500 MHz, Active Differential Probe ( $\times 10$ , $\div 1$ , $\div 10$ , $\div 100$ )	AP033
30 A; 100 MHz Current Probe – AC/DC; 30 A <sub>rms</sub> ; 50 A <sub>peak</sub> Pulse	CP031
30 A; 50 MHz Current Probe – AC/DC; 30 A <sub>rms</sub> ; 50 A <sub>peak</sub> Pulse	CP030
30 A; 50 MHz Current Probe – AC/DC; 30 A <sub>rms</sub> ; 50 A <sub>peak</sub> Pulse	AP015
150 A; 10 MHz Current Probe – AC/DC; 150 A <sub>rms</sub> ; 500 A <sub>peak</sub> Pulse	CP150
500 A; 2 MHz Current Probe – AC/DC; 500 A <sub>rms</sub> ; 700 A <sub>peak</sub> Pulse	CP500
1,400 V, 100 MHz High-Voltage Differential Probe	ADP305
1,400 V, 20 MHz High-Voltage Differential Probe	ADP300
$\div 10$ HiZ 500 MHz Passive Probe	PP007-WR-1
Basic Adapter Kit for PP007-WR-1 and PP007-WS-1	PK701
Advanced Adapter Kit for PP007-WR-1 and PP007-WS-1	PK702
SMD Adapter Kit for PP007-WR-1 and PP007-WS-1	PK703
Microclip Adapter Kit for PP007-WR-1 and PP007-WS-1	PK704
1 Ch, 100 MHz Differential Amplifier with Precision Voltage Source	DA1855A

\*For a complete probe, order a WL300 Probe Body with the Probe Tip Module. Only applicable on WR6200A oscilloscope.

## WAVESURFER Xs SERIES

Anyone can appreciate a well-designed product with all the right performance, features, and design elements. The **WaveSurfer Xs oscilloscope** is just such a product. Validation and debug is fast and simple. The big display (but small footprint), simplified front panel, and graphical touch screen user interface will allow you to be efficient in a matter of minutes. And you'll love how it fits your budget.

### Features:

- 200 MHz to 1 GHz
- 2 or 4 channels
- WaveScan capture and search tool
- WaveStream fast viewing analog display mode
- Extensive connectivity options
- Up to 4 ms capture time at full sample rate
- Large 10.4" color LCD touch screen; only 6" deep

### Perfectly Balanced

The WaveSurfer Xs oscilloscope is designed for fast and efficient validation and debug. Its simple, uncluttered, touch screen interface has what you need, where you need it. It will quickly earn a permanent place on your bench.

Many oscilloscopes look great on paper—WaveSurfer Xs delivers in the real world. Its capabilities meet your needs for capturing, viewing, and measuring wave forms, and also provide unexpected capabilities for faster debug. WaveSurfer Xs—the new standard to judge other oscilloscopes by.

### Powerful Basic and Advanced Triggering

A multitude of powerful and flexible triggers are provided to meet any need. Use an advanced SMART Trigger™ to isolate a specific event of interest, and narrow the long capture around that event. Trigger on what you expect (widths, glitches, video, logic patterns, etc.) and also trigger on unusual signals (dropouts, intervals, runts, slew rates). LeCroy's exclusion triggering can exclude normal signals and capture only the abnormal ones, speeding up the debug of your circuits and systems. Trigger on signals down to 1 ns in width (500 ps for width and glitch trigger). Use an "A" condition to qualify a "B" trigger. Digital triggering is provided through the optional MS-32 Mixed Signal Oscilloscope option. (Some advanced triggering capability is optional).

### Long Capture Time

2.5 Mpts/Ch of fast acquisition memory standard (10 Mpts/Ch optional) provides long capture time—up to 400 ms at full sample rate, and longer times at lower sample rates. This greatly assists in debugging common circuit problems such as clock/data issues and timing errors. Use the touch screen to quickly "draw a box" around the area of interest and zoom all channels to the desired area. Then, adjust zoom position and ratio from the front panel or the graphical touch screen UI. WaveSurfer Xs long memory is also thoughtfully designed to respond quickly even when measurements, math, or serial decoders are being used.



WAVESURFER Xs

### WaveScan Advanced Search

#### Locate Problems Triggers Won't Find

*WaveScan is a powerful tool that provides the ability to locate unusual events in a single capture, or scan for an event in many acquisitions over a long period of time using more than 20 different search/scan modes. WaveScan uses measurement-based scanning modes, like frequency, to show statistical distribution of events. It overlays events for a quick and simple visual comparison.*



## WAVESURFER Xs SERIES

### LeCroy WaveScan Advanced Search

WaveScan offers powerful isolation capabilities that hardware triggers can't provide. WaveScan provides the ability to locate unusual events in a single capture (i.e. capture and search), or "scan" for an event in many acquisitions over a long period of time. Select from more than 20 search modes (frequency, rise time, runt, duty cycle, etc.), apply a search condition and begin scanning. Since the scanning "modes" are not simply copies of the hardware triggers, the utility and capability is much higher. For instance, there is no "frequency" trigger in any oscilloscope, yet WaveScan allows for "frequency" to be quickly "scanned". This allows the user to accumulate a data set of unusual events that are separated by hours or days, enabling faster debugging. When used in multiple acquisitions, WaveScan builds on the traditional LeCroy strength of fast processing of data. A LeCroy X-Stream oscilloscope will quickly scan millions of events looking for unusual occurrences, and do it much faster and more efficiently than other oscilloscopes can.

### WaveStream Fast Viewing Mode

WaveStream provides a vibrant, intensity graded (256 levels) display with a fast update rate to closely simulate the look and feel of an analog oscilloscope. WaveStream is most helpful in viewing signals that have signal jitter or signal anomalies, or for applying a visual check before creating an advanced trigger or WaveScan setup to locate an unusual event. Since the sampling rate in WaveStream mode can be as high as 5 GS/s (up to 2.5x that of other oscilloscopes), it is an excellent runt or glitch finder. Timing jitter is often visually assessed to understand approximate behavior. WaveStream makes it easy to understand jitter on edges or in eye diagrams. WaveStream also excels in allowing you to relate composite (WaveStream) to single-event (real-time sampled) behaviors. Just capture in WaveStream mode, toggle to view or zoom a single trace, then toggle back to WaveStream mode.

### Options for Increased Power and Functionality

#### *Mixed Signal Oscilloscope Option*

Add 32 digital channels to a 4-channel WaveSurfer Xs with the MS-32 Mixed Signal Oscilloscope option. Includes 32 Mpts of digital memory (1 Mpts/Ch) for long capture times.

#### *I2C, SPI, and CAN Serial Trigger and Decode (optional)*

- *Complete I2C, SPI, and CAN Serial Triggering*

Quickly and easily isolate specific serial data events on your embedded controller for better understanding and faster debug. Set up trigger conditions in binary, or hexadecimal formats. Use the EXT input for the clock signal and keep an additional analog oscilloscope channel open for other uses. Trigger on DATA in specific locations of long I2C EEPROM reads. Get complete control of your debug process and finish faster.

## WAVESURFER Xs SERIES

- **Powerful Conditional I<sup>2</sup>C Data Triggering Isolates Problems**

Use a conditional I<sup>2</sup>C DATA trigger to select a range of DATA values to trigger on, not just a single DATA value. Oftentimes, I<sup>2</sup>C utilizes DATA bytes to specify sub-addresses for accessing memory locations in EEPROMs. Conditional DATA trigger allows triggering on a range of DATA bytes that correspond to reads or writes to specific sub-address memory blocks in the EEPROM. It can also aid in monitoring DATA outputs from I<sup>2</sup>C-based sensors, such as analog-to-digital converters, and triggering when DATA is outside a safe operating range. In both cases, verifying proper operation becomes a simple task.

- **Intuitive, Color-Coded Decode Overlay**

Advanced software algorithms deconstruct the waveform into binary, hex, or ASCII protocol information, then overlay the decoded data on the waveform. Various sections of the protocol are color-coded to make it easy to understand. The decode operation is fast—even with long acquisitions.

- **Table Summary and Search/Zoom**

Turn your oscilloscope into a protocol analyzer with the Table display of protocol information. Customize the table, or export Table data to an Excel file. Touch a message in the table and automatically zoom for detail. Search for specific address or data values in the acquisition.

### Get Your Answers Fast

Keep your testing efficient with a thoughtfully designed user interface that provides the busy engineer with a GUI that is smooth, transparent, and easy to use.

### One-touch Access to 23 Measurements

Twenty three basic measurements have been built in to give you quick answers. Use the front panel Measure button; then, with one touch, quickly select your cursors from the graphical user interface.

### Additional Features:

- Dedicated Cursor, Push, and Zoom Control Knobs – For added ease of use and functionality
- Touch Screen with Built-in Stylus – The most time-efficient user interface is even easier to use with a built-in stylus.
- High Impedance Active Probes – 1 and 1.5 GHz active probes with 0.9 pF, 1 M $\Omega$  input impedance and an extensive probe tip and ground accessory selection.
- Local Language User Interface – Select from 10 language preferences. Add a front panel overlay with your local language.

### ZS Series High Impedance Active Probe Accessories

LeCroy's new ZS Series of high impedance active probes provide full bandwidth at the probe tip, and the high impedance (0.9 pF, 1 M $\Omega$ ) you want. A variety of standard and available probe tip and grounding accessories are offered to meet any requirement. What's more, ZS Series probes are available for a very affordable price. Use the ZS1000 with the 200, 400 and 600 MHz WaveSurfers and the ZS1500 with 1 GHz WaveSurfers to give full system bandwidth at the probe tip.

**WAVESURFER Xs SERIES**

SPECIFICATIONS	WAVESURFER 24Xs	WAVESURFER 44Xs	WAVESURFER 42Xs	WAVESURFER 64Xs	WAVESURFER 62Xs	WAVESURFER 104Xs
<b>VERTICAL SYSTEM</b>						
Bandwidth (@ 50 Ω)	200 MHz	400 MHz		600 MHz		1 GHz
Rise Time	1.75 ns	875 ps		625 ps		400 ps
Input Channels	4	4	2	4	2	4
Display	10.4" Color flat-panel TFT-LCD, 800 x 600 SVGA, touch screen					
Sample Rate (single-shot)	2.5 GS/s					2.5 GS/s (5 GS/s interleaved)
Sample Rate (RIS mode)	50 GS/s					
Standard Record Length	2.5 Mpts/Ch (all channels)					
Standard Capture Time	up to 1 ms at full sample rate on all four channels					
Vertical Resolution	8 bits					
Vertical Sensitivity (V/div)	2 mV/div–10 V/div (1 MΩ); 2 mV/div–1 V/div (50 Ω)					
Vertical (DC Gain) Accuracy	±1.0% of full scale (typical); ±1.5% of full scale ≥ 10 mV/div (warranted)					
BW Limit	20 MHz	20 MHz, 200 MHz				
Maximum Input Voltage	50 Ω: 5 V <sub>rms</sub> , 1 MΩ: 400 V max. (DC + Peak AC ≤ 5 kHz)					50 Ω: 5 V <sub>rms</sub> 1 MΩ: 250 V max. (DC + Peak AC ≤ 10 kHz)
Input Coupling	AC, DC, GND (DC and GND for 50 Ω)					
Input Impedance	1 MΩ    16 pF, or 50 Ω					1 MΩ    20 pF, or 50 Ω
Probing System	BNC or ProBus					
Probes	One PP009 (5 mm) per channel (standard)					One PP011 (5 mm) per channel (standard)
Timebase Range	200 ps/div–1000 s/div (roll mode from 500 ms/div–1000 s/div)					
Timebase Accuracy	10 ppm					
Trigger Modes	Normal, Auto, Single, and Stop					
Trigger Sources	Any input channel, External, Ext/10, or line; slope and level unique to each source (except for line trigger)					
Trigger Coupling	DC, AC, HFRej, LFRej					
Pre-trigger Delay	0–100% of full scale					
Post-trigger Delay	0–10,000 divisions					
Trigger Hold-off	1 ns to 20 s or 1 to 1,000,000,000 events					
Internal Trigger Level Range	±4.1 div from center					
External Trigger Range	EXT/10 ±4V; EXT ±400 mV					

## WAVESURFER Xs SERIES

### TRIGGERING

Standard	Edge, Glitch, Width, Logic (Pattern), TV-Composite Video
Advanced (WS Xs-ADVTRIG)	Runt, Slew Rate, Interval (Signal or Pattern), Dropout, Qualified (State or Edge)

### STANDARD TRIGGERS

Edge	Triggers when signal meets slope (positive, negative, or Window) and level condition
Glitch	Triggers on positive or negative glitches with widths selectable from 500 ps to 20 s or on intermittent faults. Includes exclusion mode (trigger on intermittent faults by specifying the normal width period).
Width	Triggers on positive or negative pulse widths selectable from 500 ps to 20 s or on intermittent faults. Includes exclusion mode (trigger on intermittent faults by specifying the normal width period).
Logic (Pattern)	Logic combination (AND, NAND, OR, NOR) of 5 inputs (Channels and external trigger input). Each source can be high, low, or don't care. The High and Low level can be selected independently.
TV-Composite Video	Triggers selectable fields (1, 2, 4, or 8), Positive or Negative slope, for NTSC, PAL, SECAM, or non-standard video (up to 1500 lines).

### OPTIONAL SMART TRIGGERS (WSXS-ADVTRIG OPTION)

Runt	Trigger on positive or negative runts defined by two voltage limits and two time limits. Select between 1ns and 20s. Includes exclusion mode (trigger on intermittent faults by specifying the normal runt width).
Slew Rate	Trigger on edge rates. Select limits for dV, dt, and slope. Select edge limits between 1 ns and 20 s. Includes exclusion mode (trigger on intermittent faults by specifying the normal slew rate).
Interval (Signal or Pattern)	Triggers on intervals selectable between 1 ns and 20 s.
Dropout	Triggers if signal drops out for longer than selected time between 1 ns and 20 s.
Qualified (State or Edge)	Triggers on any input source only if a defined state or edge occurred on another input source. Delay between sources is 1 ns to 20 s, or 1 to 1,000,000,000 events. Includes exclusion mode (trigger on intermittent faults by specifying the normal width).

### MEASURE, ZOOM, AND MATH TOOLS

Standard Parameter Measurements	Up to 6 of the following parameters can be calculated at one time on any waveform: Amplitude, Area, Base (Low), Cyclic Area, Cyclic Mean, Cyclic RMS, Cyclic Std. Deviation, Delay, Duty, Fall Time (90%-10%), Fall Time (80%-20%), Frequency, Maximum, Mean, Minimum, Overshoot+, Overshoot-, Period, Peak-Peak, Phase, Rise Time (10%-90%), Rise Time (20%-80%), RMS, Skew, Standard Deviation, Top (High), Width+, Width-. Measurements can be gated.
Zooming	Use front panel QuickZoom button, or use touch screen or mouse to draw a box around the zoom area.
Standard Math	Operators include Sum, Difference, Product, Ratio, and FFT (up to 25 kpts with power spectrum output and rectangular, VonHann, and FlatTop windows). 1 math function may be defined at a time.
Extended Math (WSXs-MATHSURF Option)	Adds the following additional math functions: Absolute Value, Averaging (summed and continuous), Derivative, Envelope, Enhanced Resolution (to 11 bits), Floor, Integral, Invert, Reciprocal, Roof, Square, and Square Root. Also adds chaining of two math functions and rescaling to different units, and 1 Mpts FFTs.



## WAVESURFER Xs SERIES

### WAVESTREAM FAST VIEWING MODE

Intensity	256 Intensity Levels, 1–100% adjustable via front panel control
Number of Channels	up to 4 simultaneously
Max. Sampling Rate	2.5 GS/s
Waveforms/second (continuous)	up to 8000 waveforms/second
Operation	Front panel toggle between normal Real-Time mode and LeCroy WaveStream Fast Viewing mode

### ANALOG PERSISTENCE

Type	Analog or color-graded.
Saturation	Variable saturation level, adjustable from front panel
Aging Time	Adjustable from 500 ms to infinity
Operation	Software user interface ON/OFF and type selectability. When ON, persistence applied to all waveforms.

### AUTOMATIC SETUP

Auto Setup	Automatically sets timebase, trigger, and sensitivity to display a wide range of repetitive signals. Vertical Find Scale automatically sets the vertical sensitivity and offset for the selected channel
------------	--

### SETUP AND WAVEFORM STORAGE

Front Panel and Instrument Status	Save to the internal hard drive, over the network, or to a USB connected peripheral device.
Waveform Traces	Save to one of four internal memories with 16 bit resolution for recall/comparison.
Waveform Data	Save to the internal hard drive, over the network, or to a USB connected peripheral device.

### DOCUMENTATION AND CONNECTIVITY

Printing	Connect to any Windows® XP-compatible printer using any of the available USB 2.0 ports. Load any standard Windows XP printer driver onto the unit as future needs require.
Email	Configure the unit to send an email of a screen image in a variety of formats using MAPI (i.e. through a default email program) or SMTP (no additional program needed).
Waveform Memories	Save waveform data as a reference trace to be compared to channels, zooms, or math functions.
Waveform File Data	Save waveform data in the following formats: Binary, ASCII, Excel, Mathcad, MATLAB.
Screen Image	Save a screen image to the internal hard drive, a user-supplied USB memory stick, or any other peripheral connected to one of the five USB 2.0 ports. Image can be saved in a variety of formats, and with white or black background.
Waveform Labeling (Annotation)	Attach up to 10 labels to any combination of waveforms. Labels appear on screen images.
Hardcopy Front Panel Button	Configure the front panel Hardcopy button to send an email, save a screen image, save waveform file data, and save to the clipboard.
Networking	Standard 10/100Base-T Ethernet interface (RJ-45 connector). Connect to any network using DHCP with automatically assigned IP address.
Remote Control	Via Windows automation, or via LeCroy Remote Command Set (via Ethernet or GPIB)
USB Ports	5 USB ports (one on front of instrument) support Windows compatible devices
External Monitor Port Standard	15-pin D-Type female SVGA-compatible connector for external color display
Parallel Port	Not supplied
Serial Port	9-pin D-type male (not for remote oscilloscope control)
Audio Port	Mic Input, Line Input, Line Output
GPIB Port (Accessory)	Supports IEEE – 488.2 (using NI USB-GPIB-B)

## WAVESURFER Xs SERIES

### OUTPUTS

Calibrator	1 kHz square wave, +1.0 V into 1 M $\Omega$ , output on front panel test point and ground lug
Control Signals	Rear Panel: TTL level, BNC output; Choice of trigger ready, trigger out, pass/fail status. (output resistance 300 $\Omega$ typical)

### ENVIRONMENTAL AND SAFETY

Temperature: Operating	+5 °C to +40 °C
Temperature: Non-Operating	-20 °C to +60 °C
Humidity: Operating	Maximum relative humidity 80% for temperatures up to 31 °C decreasing linearly to 50% relative humidity at 40 °C
Humidity: Non-Operating	5% to 95% RH (non-condensing) as tested per MIL-PRF-28800F
Altitude: Operating	Up to 2,000 m
Altitude: Non-Operating	12,190 m

### PHYSICAL DIMENSIONS

Dimensions (HWD)	260 mm x 340 mm x 152 mm (10.25" x 13.4" x 6"). Excluding accessories and projections.
Net Weight	6.95 kg (15.5 lbs). Excluding accessories.

### GENERAL

Power Requirements	90–264 V <sub>rms</sub> at 50/60 Hz; 115 V <sub>rms</sub> ( $\pm 10\%$ ) at 400 Hz, Automatic AC Voltage Selection Installation Category: 300V CAT II; Max. Power Consumption: 340 VA/340 W; 290 VA/290 W for 2 Channel
Warranty and Calibration	3-year warranty. Calibration recommended yearly.

**WAVESURFER Xs SERIES**

**ORDERING INFORMATION**

**PRODUCT CODE**

**WAVESURFER Xs DIGITAL OSCILLOSCOPES**

1 GHz, 2.5 GS/s, 4 Ch, 2.5 Mpts/Ch (5 GS/s interleaved) with 10.4" Color Touch Screen Display	WaveSurfer 104Xs
600 MHz, 2.5 GS/s, 4 Ch, 2.5 Mpts/Ch with 10.4" Color Touch Screen Display	WaveSurfer 64Xs
600 MHz, 2.5 GS/s, 2 Ch, 2.5 Mpts/Ch with 10.4" Color Touch Screen Display	WaveSurfer 62Xs
400 MHz, 2.5 GS/s, 4 Ch, 2.5 Mpts/Ch with 10.4" Color Touch Screen Display	WaveSurfer 44Xs
400 MHz, 2.5 GS/s, 2 Ch, 2.5 Mpts/Ch with 10.4" Color Touch Screen Display	WaveSurfer 42Xs
200 MHz, 2.5 GS/s, 2 Ch, 2.5 Mpts/Ch with 10.4" Color Touch Screen Display	WaveSurfer 24Xs

**INCLUDED WITH STANDARD CONFIGURATION**

±10 HiZ 500 MHz Passive Probe (Total of 1 Per Channel)	
Getting Started Manual and Quick Reference Guide	
CD-ROMs containing Utility Software	
Standard Ports: 10/100Base-T Ethernet, USB 2.0 (5), SVGA Video out, Audio in/out, RS-232	
Protective Front Cover	
Standard Commercial Calibration and Performance Certificate	
3-Year Warranty	

**MEMORY OPTIONS**

10 Mpts/Ch Memory Option (for 4 Ch WaveSurfer Xs)	WSXs-VL
10 Mpts/Ch Memory Option (for 2 Ch WaveSurfer Xs)	WSXs-VL2

**GENERAL ACCESSORIES**

Keyboard Accessory	WSXs-KYBD
Optical Mouse Accessory	WSXs-MOUSE
External GPIB Accessory	WS-GPIB
Hard Carrying Case	WSXs-HARDCASE
Soft Carrying Case	WSXs-SOFTCASE
Rack Mount Accessory	WSXs-RACK
Accessory Pouch	WSXs-POUCH

**MOUNTING ACCESSORY**

Clamp Mounting Stand	WSXs-MS-CLAMP
----------------------	---------------

**LOCAL LANGUAGE OVERLAYS**

German Front Panel Overlay	WSXs-FP-GERMAN
French Front Panel Overlay	WSXs-FP-FRENCH
Italian Front Panel Overlay	WSXs-FP-ITALIAN
Spanish Front Panel Overlay	WSXs-FP-SPANISH
Japanese Front Panel Overlay	WSXs-FP-JAPANESE
Korean Front Panel Overlay	WSXs-FP-KOREAN
Chinese (Tr) Front Panel Overlay	WSXs-FP-CHNES-TR
Chinese (Simp) Front Panel Overlay	WSXs-FP-CHNES-SI
Russian Front Panel Overlay	WSXs-FP-RUSSIAN

**SOFTWARE OPTIONS**

Advanced Trigger Software Package	WSXs-ADVTRIG
Extended Math Software Package	WSXs-MATHSURF
Electrical Telecom Mask Test Software Package	WSXs-ET-PMT
Windows Lockout Software Option	WSXs-LOCKOUT

## WAVESURFER Xs SERIES

### ORDERING INFORMATION

### PRODUCT CODE

#### SERIAL DATA OPTIONS

I <sup>2</sup> C Trigger and Decode Option	WSXs-I2Cbus TD
SPI Trigger and Decode Option	WSXs-SPIbus TD
CAN TD Trigger and Decode Option (for use with 400 MHz–1 GHz 4-channel models)	CANbus TD

#### MIXED SIGNAL OSCILLOSCOPE OPTIONS

32 Digital Channel Oscilloscope Mixed Signal Option (for use with 400 MHz–1 GHz 4-channel models)	MS-32
--	-------

#### PROBES AND AMPLIFIERS\*

(Qty. 4) 1.5 GHz, 0.9 pF, 1 M $\Omega$ High Impedance Active Probe	ZS1500-QUADPAK
(Qty. 4) 1 GHz, 0.9 pF, 1 M $\Omega$ High Impedance Active Probe	ZS1000-QUADPAK
1 GHz Active Differential Probe ( $\div 1$ , $\div 10$ , $\div 20$ )	AP034
500 MHz Active Differential Probe (x10, $\div 1$ , $\div 10$ , $\div 100$ )	AP033
30 A; 100 MHz Current Probe – AC/DC; 30 A <sub>rms</sub> ; 50 A <sub>peak</sub> Pulse	CP031
30 A; 50 MHz Current Probe – AC/DC; 30 A <sub>rms</sub> ; 50 A <sub>peak</sub> Pulse	CP030
30 A; 50 MHz Current Probe – AC/DC; 30 A <sub>rms</sub> ; 50 A <sub>peak</sub> Pulse	AP015
150 A; 10 MHz Current Probe – AC/DC; 150 A <sub>rms</sub> ; 500 A <sub>peak</sub> Pulse	CP150
500 A; 2 MHz Current Probe – AC/DC; 500 A <sub>rms</sub> ; 700 A <sub>peak</sub> Pulse	CP500
1,400 V, 100 MHz High-Voltage Differential Probe	ADP305
1,400 V, 20 MHz High-Voltage Differential Probe	ADP300
1 Ch, 100 MHz Differential Amplifier	DA1855A

\*A wide variety of other passive, active, and differential probes are also available. Consult LeCroy for more information.



## WAVESURFER® 400 SERIES



WAVESURFER 400

From its large 10.4" LCD touch screen to its space-saving small footprint, the [WaveSurfer oscilloscope](#) is a radical rethinking of the basic bench scope. It breaks the rules of conventional scope design to deliver dramatically improved signal viewing, 100x the capture time, and up-to-the-minute connectivity capabilities. But more importantly, it's designed for the way you like to work—big, sharp images of your signal, a simple, easy-to-use interface, and a strong tool set for testing and debugging.

### Features:

- 500 MHz, 350 MHz, and 200 MHz bandwidth
- 2 channels
- Large 10.4" color LCD touch screen; only 6" deep
- More than 100x the capture time at full sample rate compared to other scopes in its class
- Extensive connectivity options
- 1 ms long acquisition
- Zoom of detail while retaining high sample rate

The WaveSurfer 400 Series' 10.4" display is 2-1/2 times the size of the 6.4" screens found on competitive oscilloscopes. And its 6" deep footprint eliminates the space penalty that comes with conventional oscilloscopes. The 800 x 600 SVGA display boasts exceptional brightness and a wide viewing angle. Signal details are clearer than ever.

### Long Capture Time

Large screens show the detail—if you can capture it. The WaveSurfer oscilloscope provides all the detail you need by delivering more than 100x the capture time at full sample rate compared to other oscilloscopes in its class. It effectively eliminates the trade-off between high sample rate and long capture time. This high sample rate is especially important when capturing a mix of signals that are spaced widely apart in time, or when you require a long pre-trigger time. This means that the WaveSurfer 400 Series oscilloscope beats short-memory scopes when it comes to the debugging of common circuit problems like clock/data issues and timing errors.

### Communicate All the Ways You Want

Your list of connectivity options is extensive—from the front mounted USB port for your memory stick to the standard 10/100Base-T Ethernet port. You can document your work and communicate effectively with your group. Whether you want to save data to the oscilloscope's hard drive or a network drive, email other engineers, or send images to the printer, the WaveSurfer 400 Series oscilloscope gives you the flexibility to manage your communications easily and effectively.

## WAVESURFER® 400 SERIES

### Additional Features:

- One-touch Access to 23 Measurements – The WaveSurfer 400 Series oscilloscope fits your working style as comfortably as it fits your bench. Twenty-three basic measurements have been built in to give you quick answers.
- Smooth Cursor Control – You can use dedicated front panel cursor knobs to position your cursors at any time without invoking special menus. You can quickly choose your cursor by using the “type” button. Then apply them to any signal, zoom, or math trace. You won’t find an easier-to-use set of cursors on any other oscilloscope.
- Simple Zooming and Math – Zooming is so easy with this scope—simply draw a box around the area to be zoomed (or use the front panel QuickZoom button). Waveform math is also built in and easily applied. In addition, a power spectrum FFT is standard. It can be quickly invoked and easily set up, even by someone not familiar with FFTs.
- Zero Footprint – The WaveSurfer 400 Series desktop clamp-style mounting system attaches to the edge of your bench and frees up valuable working space. Viewing positions can be changed easily up to a maximum range of 23" (58 cm).
- The scope can also be pivoted to achieve the optimal viewing angle. Or purchase just a mounting bracket and provide your own 75 x 75 mm mounting solution.

### EXTEND WAVESURFER CAPABILITIES WITH OPTIONAL PACKAGES

#### Advanced Trigger Software Package

Includes Runt, Slew Rate, Qualified Edge, Qualified State, Interval (Signal or Pattern), and Dropout Triggers.

#### MathSurfer

Additional math functions, chained math functions, rescaling of units, and enhanced FFT capability.

#### ET-PMT Electrical Testing

Transforms your oscilloscope into a dedicated mask testing device for manufacturing and field testing of electrical telecom signals.

**WAVESURFER® 400 SERIES**

<b>SPECIFICATIONS</b>	<b>WAVESURFER 422</b>	<b>WAVESURFER 432</b>	<b>WAVESURFER 452</b>
<b>VERTICAL SYSTEM</b>			
Bandwidth (at probe tip)	200 MHz	350 MHz	500 MHz
Rise Time (typical)	1.75 ns	1 ns	750 ps
Input Channels	2		
Display	10.4" color flat-panel TFT-LCD, 800 x 600 SVGA, touch screen		
Sample Rate (single-shot)	1 GS/s (all channels), 2 GS/s max. (interleaved mode).		
Sample Rate (RIS mode)	50 GS/s		
Standard Record Length	1 Mpts/Ch (all channels), 2 Mpts/Ch (interleaved mode).		
Standard Capture Time	up to 1 ms at full sample rate		
Vertical Resolution	8 bits		
Vertical Sensitivity (V/div)	1 mV/div–10 V/div (1 M $\Omega$ ); 1 mV/div–2 V/div (50 $\Omega$ )		
Vertical (DC Gain) Accuracy	$\pm(1.5\% + 0.5\%$ of full scale)		
Vertical Offset Range	$\pm 1$ V (1–20 mV/div), $\pm 10$ V (50–200 mV/div), $\pm 100$ V (500 mV–10 V/div)		
Bandwidth Limit	20 MHz	20 MHz, 200 MHz	
Maximum Input Voltage	CAT I: 400 V max. (DC + Peak AC $\leq$ 5 kHz) with 1 M $\Omega$ input. 5 V <sub>rms</sub> with 50 $\Omega$ input		
Input Coupling	AC, DC, GND (DC and GND for 50 $\Omega$ )		
Input Impedance	1 M $\Omega$    16 pF, or 50 $\Omega$ $\pm 1\%$		
Probing System	BNC or ProBus		
Probes	One PP007 (2.5 mm) per channel standard		
Timebase Range	1 ns/div–1000 s/div	500 ps/div–1000 s/div	200 ps/div–1000 s/div
Timebase Accuracy	10 ppm		

**TRIGGERING**

Standard	Edge, Glitch, Width, Logic (Pattern), TV-Composite Video
Advanced (WS-ADVTRIG)	Runt, Slew Rate, Interval (Signal or Pattern), Dropout, Qualified (State or Edge)

**MEASURE, ZOOM, AND MATH TOOLS**

Standard Parameter Measurements	Up to 6 of the following parameters can be calculated at one time on any waveform: Amplitude, Area, Base (Low), Cyclic Area, Cyclic Mean, Cyclic RMS, Cyclic Std. Deviation, Delay, Duty, Fall Time (90%–10%), Fall Time (80%–20%), Frequency, Maximum, Mean, Minimum, Overshoot+, Overshoot-, Period, Peak-Peak, Phase, Rise Time (10%–90%), Rise Time (20%–80%), RMS, Skew, Standard Deviation, Top (High), Width+, Width-. Measurements may be gated.
Zooming	Use front panel QuickZoom button, or use touch screen or mouse to draw a box around the zoom area.
Standard Math	Operators include Sum, Difference, Product, Ratio, and FFT (up to 25 kpts with power spectrum output and rectangular, VonHann, and FlatTop windows). 1 math function may be defined at a time.
Extended Math (WS-MATHSURF Option)	Adds the following additional math functions: Absolute Value, Averaging (summed and continuous), Derivative, Envelope, Enhanced Resolution (to 11 bits), Floor, Integral, Invert, Reciprocal, Roof, Square, and Square Root. Also adds chaining of two math functions, rescaling to different units.

## WAVESURFER® 400 SERIES

### ORDERING INFORMATION

### PRODUCT CODE

#### WAVESURFER 400 DIGITAL OSCILLOSCOPES

500 MHz, 2 GS/s, 2 Ch, 2 Mpts/Ch (Interleaved), with 10.4" Color Display (1 GS/s, 1 Mpts/Ch)	WaveSurfer 452*
350 MHz, 2 GS/s, 2 Ch, 2 Mpts/Ch (Interleaved), with 10.4" Color Display (1 GS/s, 1 Mpts/Ch)	WaveSurfer 432*
200 MHz, 2 GS/s, 2 Ch, 2 Mpts/Ch (Interleaved), with 10.4" Color Display (1 GS/s, 1 Mpts/Ch)	WaveSurfer 422*

#### INCLUDED WITH STANDARD CONFIGURATION

10.4" 800 x 600 resolution TFT display
PP007-WS-1, $\pm 10$ HiZ 500 MHz Passive Probe
Operator's Printed Getting Started Manual and Quick Reference Guide
CD-ROM with Operator's On-Line Help, Getting Started Manual (multi-language), Quick Reference Guide, and Remote Control Manual
CD-ROM with Application Software
10/100Base-T Ethernet Port, 3 USB 2.0 Ports, SVGA Video Output, RS232-C Serial Port, Centronics Parallel Port
Protective Front Cover
Standard Commercial Calibration and Performance Certificate
3-Year Warranty

#### SOFTWARE OPTIONS

Advanced Trigger Software Package	WS-ADVTRIG
Electrical Telecom Test Software Package	WS-ET-PMT
Extended Math Software Package	WS-MATHSURF
Operating System Lockout Option for Businesses	WS-LOCKOUT-BUS
Operating System Lockout Option for Not-for-Profit Organizations	WS-LOCKOUT-NFP

#### HARDWARE OPTIONS AND ACCESSORIES

Basic Adapter Kit for PP007-WR-1 and PP007-WS-1	PK701
Advanced Adapter Kit for PP007-WR-1 and PP007-WS-1	PK702
SMD Adapter Kit for PP007-WR-1 and PP007-WS-1	PK703
Microclip Adapter Kit for PP007-WR-1 and PP007-WS-1	PK704
USB 2.0 to GPIB IEEE-488.2 Adapter	WS-GPIB
Mounting Bracket Only – 100 mm Square	WS-MB*
Mounting Stand – Desktop Clamp Style (includes WS-MB mounting bracket)	WS-MS-CLAMP*
Rackmount Ears Kit	WS-RMA-25*
Complete Battery System containing one (1) battery pack and one (1) charger	WS-BATT-SYS*
Additional Battery Pack	WS-BATTERY*
Hard Transit Case	WS-HARD
Accessory Pouch	WS-POUCH*
External Graphics Printer	GP-EXT*
Additional Graphic Printer Paper (10 Rolls Pkg.)	GPR10
$\pm 10$ HiZ 500 MHz Passive Probe	PP007-WS-1
Mini Keyboard, USB	42821000

\* Limited availability.



## WAVEJET® 300 SERIES



WAVEJET 300

The **WaveJet 300 Series** features unmatched performance and debugging tools not usually found in low bandwidth portable oscilloscopes. Engineers can simplify and shorten their debugging process with the Replay feature and long capture time not available in other oscilloscopes with bandwidths at 100 MHz. On top of great performance and capabilities the WaveJet is lightweight and portable, it is only 4" deep and features a large 7.5" color display.

### Features:

- 500 MHz, 350 MHz, 200 MHz, and 100 MHz bandwidth
- 2 or 4 channels
- Large 7.5" color LCD
- Small 4" footprint
- More than 200x the capture time at 2 GS/s compared to other scopes in its class

### Unique Capabilities in a Low Bandwidth Oscilloscope

- **Replay** – allows you to look back in time at your waveform to view those rare events, such as runts or glitches, and display them in the order they occurred, providing you with unique insight to simplify debugging and troubleshooting.
- **Long Capture** – The WaveJet eliminates the tradeoff between high sample rate and long capture time, by providing up to 200x the capture time, at 2 GS/s, compared to other oscilloscopes in its class. Long memory makes WaveJet the ideal oscilloscope for viewing a mix of low-frequency and high-frequency signals or low-speed signals with fast edges.
- **Automatic Measurements** – Save time making measurements on your signals by using the 26 automatic measurement parameters. See results color-coded to the channels, with minimum and maximum values displayed.
- **Waveform Math** – The WaveJet provides math capabilities for additional analysis. Available math functions include sum, difference, product, and FFT. Measurements can then be made on the calculated waveforms.
- **Oscilloscope Settings and Reference Waveforms** – Save captured waveforms and WaveJet settings to internal memory or a USB memory device. Recall those settings at a later time to compare testing results.
- **Acquisition Modes** – Peak detect and equivalent time acquisition modes offer flexibility capturing and measuring signals. The WaveJet can capture glitches as small as 1 ns with peak detect mode and can achieve a sample rate up to 100 GS/s with equivalent time mode.
- **Frequency Counter** – The built in 6-digit frequency counter simplifies how you make measurements. The counter is always displayed and easy to read at a glance.
- **Triggering** – Along with edge triggering, additional triggering capabilities include Pulse Width, Period, Pulse Count, and TV triggers to help capture the signals you need to see.

The WaveJet 300 Series oscilloscope can be fully controlled through a remote connection by using the WJ-GPIB or WJ-LAN interface cards. These cards plug directly into the rear panel option slots of the WaveJet and can be used to transfer waveform data, measurement values, and screen images to your PC. The interfaces also provide control for all the vertical, horizontal, trigger, and other settings remotely.



## WAVEJET® 300 SERIES

SPECIFICATIONS	WAVEJET 314	WAVEJET 312	WAVEJET 324	WAVEJET 322	WAVEJET 334	WAVEJET 332	WAVEJET 354	WAVEJET 352
Bandwidth	100 MHz		200 MHz		350 MHz		500 MHz	
Rise Time	3.5 ns		1.75 ns		1 ns		750 ps	
Input Channels	4	2	4	2	4	2	4	2
Display	7.5" Color flat-panel TFT-LCD, 640 x 480 VGA							
Sample Rate (single-shot)	1 GS/s		2 GS/s (Interleaved), 1 GS/s (all channel)					
Sample Rate (RIS)	100 GS/s							
Peak Detect Period	1 ns							
Memory Length	500 kpts/Ch (all channels)							
Capture Time	500 $\mu$ s at 1 GS/s, 250 $\mu$ s at 2 GS/s							
Vertical Resolution	8 bit							
Vertical Sensitivity	2 mV/div–10 V/div		2 mV/div–10 V/div, 2 mV/div–2 V/div (50 $\Omega$ )					
Vertical (DC) Gain Accuracy	$\pm$ (1.5% + .5% of full scale)							
BW Limiting Filters	20 MHz				20 MHz, 200 MHz			
Maximum Input Voltage	400 V CAT I				400 V CAT I, 5 V <sub>rms</sub> (50 $\Omega$ )			
Input Coupling	GND, DC 1 M $\Omega$ , AC 1 M $\Omega$				GND, DC 1 M $\Omega$ , AC 1 M $\Omega$ , DC 50 $\Omega$			
Input Impedance	1 M $\Omega$ $\pm$ 1.5%    20 pF				1 M $\Omega$ $\pm$ 1.5%    16 pF, 50 $\Omega$ $\pm$ 1.5%			
Probing System	BNC with Probe Sense Ring							
Probes	PP010 (One per Channel)				PP006A (One per Channel)			
Timebase Range	5 ns/div–50 s/div		2 ns/div–50 s/div		1 ns/div–50 s/div		500 ps/div–50 s/div	
Roll Mode	50 ms/div–50 s/div (100 kS/s maximum)							
Timebase Accuracy	10 ppm (typical)							

### TRIGGERING

Triggers Edge, Glitch Video, Period, Pulse Count, Video

### MEASURE, ZOOM, MATH AND REPLAY

Measure	Base, Cycle Mean, Cycle RMS, Duty Cycle, Fall Time (90–10%), Fall Time (80–20%), Frequency, Integral, Maximim, Mean, Minimum, Number of +Pulses, Number of -Pulses, +Overshoot, -Overshoot, Peak-Peak, Period, +Pulse Width, -Pulse Width, Rise Time (20–80%), Rise Time (10–90%), RMS, Skew, Skew@level, Top, Top-Base
Zoom	Use the front panel QuickZoom button to zoom all wavefo in a separate zoom grid
Math	Sum, Difference, Product, FFT (up to 8 kpts with Rectangular, Hanning or Flat Top)
Replay	Look back at the history of waveform acquisitions (Maximum 1024 acquisitions)

### PHYSICAL DIMENSIONS

Dimensions (HWD)	190 mm x 285 mm x 102 mm (7.5" x 11.2" x 4")
Net Weight	3.2 kg; 7 lbs.

## WAVEJET 300 SERIES

### ORDERING INFORMATION

### PRODUCT CODE

#### WAVEJET 4-CHANNEL/2-CHANNEL OSCILLOSCOPES

500 MHz, 4 Ch, 2 GS/s (max.), 500 kpts/Ch with 7.5" Color Display	WaveJet 354
500 MHz, 2 Ch, 2 GS/s (max.), 500 kpts/Ch, with 7.5" Color Display	WaveJet 352
350 MHz, 4 Ch, 2 GS/s (max.), 500 kpts/Ch with 7.5" Color Display	WaveJet 334
350 MHz, 2 Ch, 2 GS/s (max.), 500 kpts/Ch with 7.5" Color Display	WaveJet 332
200 MHz, 4 Ch, 2 GS/s (max.), 500 kpts/Ch with 7.5" Color Display	WaveJet 324
200 MHz, 2 Ch, 2 GS/s (max.), 500 kpts/Ch with 7.5" Color Display	WaveJet 322
100 MHz, 4 Ch, 1 GS/s, 500 kpts/Ch with 7.5" Color Display	WaveJet 314
100 MHz, 2 Ch, 1 GS/s, 500 kpts/Ch with 7.5" Color Display	WaveJet 312

#### INCLUDED WITH STANDARD CONFIGURATION

One Passive Probe per channel  
 Getting Started Manual, Quick Reference Guide  
 Calibration and Performance Certificate  
 3-Year Warranty

#### HARDWARE OPTIONS

GPIB Interface for WaveJet 300 Series	WJ-GPIB
10/100Base-T Interface for WaveJet 300 Series	WJ-LAN

#### PROBE ACCESSORY

±10; HiZ 500 MHz Passive Probe	PP006A
--------------------------------	--------

## I<sup>2</sup>C AND SPI TRIGGER AND DECODE

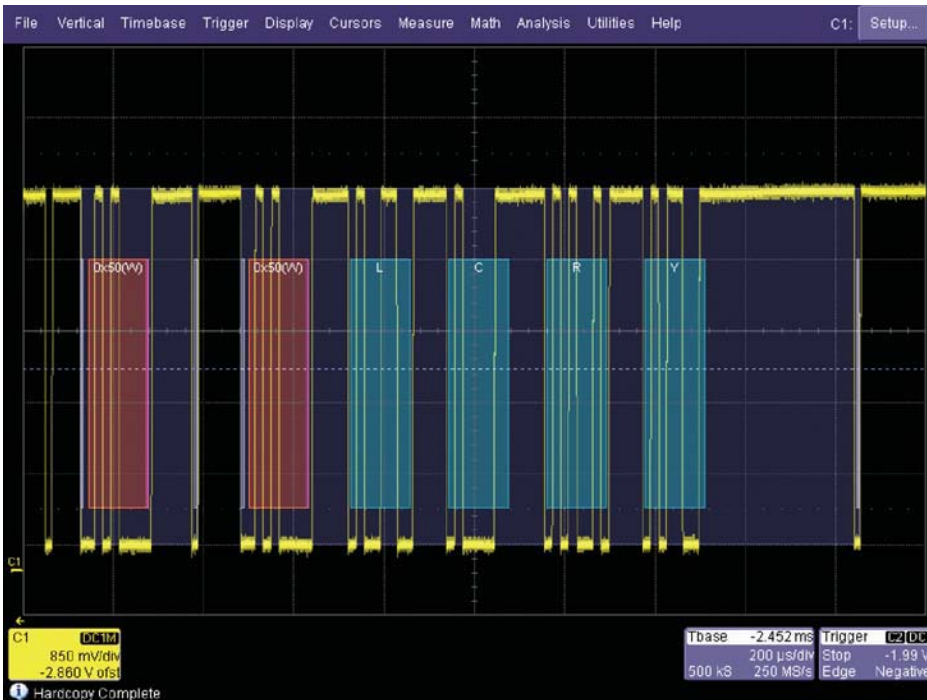

Color-coded overlaid protocol decode makes it easy to understand your serial data messages.



Trigger on exactly the messages you want with powerful conditional DATA triggering. Apply a color-coded, easy-to-understand decode over your DATA signal. Search for and find specific messages in long acquisitions.

### Powerful Conditional I<sup>2</sup>C Data Triggering

Completely isolate specific SPI or I<sup>2</sup>C message events for better understanding and debug. Use a conditional I<sup>2</sup>C DATA trigger to select a range of DATA values to trigger on, not just a single DATA value. Oftentimes, I<sup>2</sup>C utilizes DATA bytes to specify sub-addresses for accessing memory locations in EEPROMs. Conditional DATA trigger allows triggering on a range of DATA bytes that correspond to reads or writes to specific sub-address memory blocks in the EEPROM. It can also aid in monitoring DATA outputs from I<sup>2</sup>C-based sensors, such as analog-to-digital converters, and triggering when DATA is outside a safe operating range. In both cases, verifying proper operation becomes a simple task. Of course, all the basic I<sup>2</sup>C and SPI triggering capability you would expect is also included.

#### Features:

- Powerful and flexible triggering, including conditional I<sup>2</sup>C DATA/sub-address triggering
  - =
  - <
  - < =
  - >
  - > =
  - <>
  - in a range
  - outside of a range
- Set an ACK condition (ACK, NO ACK, Don't Care) in all frame trigger setups
- Color-coded decode overlaid on the waveform is easy to understand
- Decode is performed quickly, even on long records
- Hex, Binary, or ASCII decode (user selectable)
- Decode information expands as timebase is adjusted or zoomed
- Decode doesn't require CLOCK trace to be displayed
- Convenient table display with quick "zoom to message" capability
- Quick Search capability for specific messages



## I<sup>2</sup>C AND SPI TRIGGER AND DECODE

### The Most Intuitive Decode

Advanced software algorithms deconstruct the waveform into protocol information, then overlay the decoded data on the waveform. Decode information condenses or expands depending on the timebase/zoom ratio setting, so understanding messages is easy. Various sections of the protocol are color-coded to make it easy to understand, especially for users new to I<sup>2</sup>C or SPI serial data. The decode operation is fast—even with long acquisitions. The user can choose to decode into Hex, Binary, or ASCII formats.

LeCroy's decode algorithms allow the CLOCK signal to be input to the external channel, which saves valuable channels for other signals. Or, if the CLOCK signal is input to a channel, it can be turned OFF as desired to reduce display clutter.

Idx	Time	Addr Length	Address	R/W	Length	Data
8	240.494 ms	7	0x21	1	2	0xff 00 00
9	360.555 ms	7	0x21	0	1	0x08
10	360.698 ms	7	0x21	1	2	0x49 00 00
11	481.865 ms	7	0x21	0	1	0x0a
12	482.007 ms	7	0x21	1	2	0x00 00 00
13	606.294 ms	7	0x20	0	3	0x01 36 00
14	721.235 ms	7	0x20	0	1	0x00
15	721.377 ms	7	0x20	1	2	0x12 36 00
16	841.266 ms	7	0x20	0	1	0x02

Display your values in an easy-to-understand table. Touch a row to zoom, or export to Excel with one button push.

### Convenient Table Display Summarizes Results

Turn your oscilloscope into a protocol analyzer with the Table display of protocol information. Custom configure the Table to display only the information you want, and export Table data to an Excel file. Touch a message in the table and automatically zoom for detail. In all cases, the Table never obscures your waveform data.

### Search and Zoom

I<sup>2</sup>C and SPI messages can be quickly located by searching on Address (I<sup>2</sup>C) or DATA (I<sup>2</sup>C, SPI). Pressing an arrow button advances the single zoomed message view one message to the right or left of the current message.

ORDERING INFORMATION	PRODUCT CODE
I <sup>2</sup> C Trigger and Decode Option	I2Cbus TD
SPI Trigger and Decode Option	SPIbus TD
I <sup>2</sup> C Decode only Option	I2Cbus D
SPI Decode only Option	SPIbus D

I2Cbus TD and SPIbus TD are available with WaveRunner Xi and WaveSurfer Xs Series oscilloscopes.  
I2Cbus D and SPIbus D are available with WaveRunner 6000, WavePro 7000, and WaveMaster 8000 Series oscilloscopes.

### See Also:

Mixed Signal Oscilloscope Option on page 227.  
Automotive Solutions on page 281.

## I<sup>2</sup>C AND SPI TRIGGER AND DECODE

### SPECIFICATIONS

	I <sup>2</sup> Cbus TD	SPIbus TD
	<b>Definition</b>	
Protocol Setup	N.A.	Select CPOL, CPHA, DATA = MSB or LSB. Also, may select SIOP or SSPI defaults.
	<b>Decode Capability</b>	
Format	Hexadecimal, Binary, ASCII	Hexadecimal, Binary, ASCII
Decode Setup	Threshold definition required. Default is to Percent amplitude. Choose to Decode address values including/not including the R/W bit in address value.	Threshold definition required. Default is to Percent amplitude. Select CPOL, CPHA, DATA = MSB or LSB.
# of Decoded Waveforms	<b>Up to 4 buses may be decoded at one time.</b> Sources can be Channels or Memory Waveforms. In addition, zooms can be displayed (with decoded information).	<b>Up to 4 buses may be decoded at one time.</b> Sources can be Channels or Memory Waveforms. In addition, zooms can be displayed (with decoded information).
Location	Overlaid over DATA waveform, on Grid	Overlaid over DATA waveform, on Grid
Visual Aid	Color Coding for FRAME, START/ReSTART bit, ADDR, R/W, DATA, ACK, and STOP bit	Color Coding for FRAME and DATA
	<b>Trigger Capability</b>	
Format	Hexadecimal or Binary. ADDRESS and DATA can be set up with different formats.	Hexadecimal or Binary.
Trigger Setup	Trigger on START, ReSTART, STOP, ADDR, DATA, ADDR+DATA, Data Length, Missing ACK	Trigger on DATA
ADDRESS Condition Setup	Specify one ADDRESS with condition of = 7 or 10 bit ADDRESS supported with full Read, Write, or R/W="Don't Care" selectability on both 7 and 10 bit ADDRESSes Choose to Trigger on address values that include/don't include R/W bit in address value.	N.A.
DATA Condition Setup	<=, <, =, >, >=, <>, in range, out of range, don't care.	=
DATA Setup	Hexadecimal: # Data Bytes = 0 to 12. Data can be defined by nibble. Binary: Any combination of 0,1, or X for 1-96 bits. Data pattern can be set to start on any byte in a 2048-byte window (EEPROM mode only).	Hexadecimal: # Data Bytes = 0 to 8. Data can be defined by nibble. Triggers on that data pattern regardless of position. Binary: Any combination of 0,1, or X for 1-64 bits. Triggers on that data pattern regardless of position.
ACK Condition Setup	For any ADDR, ADDR+DATA, ADDR+DATA LENGTH, or EEPROM frame setup, select an ACK Condition of ACK, NO ACK, and DON'T CARE.	N.A.
Bit Rates	Full range over I <sup>2</sup> C specification for Standard, Fast, Fast-Mode Plus, and High-speed modes. Auto-detected	Any. Auto-detected
Trigger Input	Any analog Channel or the EXT input. Clock may be input to EXT to conserve available analog Channels.	Any analog Channel or the EXT input. Clock or Slave Select may be input to EXT to conserve available analog Channels.
Trigger Design	Internal to oscilloscope, settable like any other oscilloscope trigger	Internal to oscilloscope, settable like any other oscilloscope trigger
	<b>Search Capability</b>	
Pattern Search	Search by ADDRESS or DATA in Hexadecimal format	Search by ADDRESS or DATA in Hexadecimal format
	<b>Other</b>	
Compatible With ...	TD (Trigger & Decode) Option fully compatible with WaveRunner <sup>®</sup> Xi and WaveSurfer <sup>®</sup> Xs (retrofit kits available) D (Decode) Option fully compatible with WaveRunner <sup>®</sup> 6000, WavePro <sup>®</sup> 7000, and WaveMaster <sup>®</sup> 8000 Series.	TD (Trigger & Decode) Option fully compatible with WaveRunner <sup>®</sup> Xi and WaveSurfer <sup>®</sup> Xs (retrofit kits available) D (Decode) Option fully compatible with WaveRunner <sup>®</sup> 6000, WavePro <sup>®</sup> 7000, and WaveMaster <sup>®</sup> 8000 Series.



## MS-32



### Enhanced Test and Analysis Capabilities for Mixed Signal Environments

Finally, the ultimate solution for mixed signal oscilloscopes—enough channels. LeCroy's MS-32 and a LeCroy oscilloscope provide 4 analog and 32 digital channels for powerful measurement capability. LeCroy now offers the perfect solution for embedded controller testing where there are multiple analog signals coincident with digital signals. Analog signals include comparators, voltage sources, sensor/actuator signals, etc.; while digital signals include address or data lines, control signals, or peripheral serial data signals.

Users can capture all their signal information using long memory, or set up digital or analog trigger conditions to capture the event of interest. Signal debug is simple, using standard oscilloscope tools, such as cursors, measurement parameters, and zooming.

#### Features:

- 32 digital channels
- Long capture time (1 Mpts/Ch of digital memory, always available)
- Ability to capture up to 125 MHz digital clocks
- Simple oscilloscope setup and user interface

#### 4 Analog + 32 Digital Channel Capability

LeCroy introduces the first oscilloscope solution to combine 4 analog channels with 32 digital channels. This is ideal for the most efficient testing of 16-bit embedded controllers, where all 16 ADDR and 16 DATA lines can be viewed at one time. Or, a multitude of ADDR and DATA lines can be viewed, in addition to control lines and low-speed serial data lines (SPI, I<sup>2</sup>C, etc.). Testing and debugging efficiency is greatly enhanced by eliminating the need to continuously disconnect/reconnect signals to observe different behaviors.



## MS-32

**Functions:**

- **Long Digital Capture Time** – 1 Mpts of digital memory/channel (32 Mpts total) ensures that users can capture their area of interest. 1 Mpts is always available on every channel.
- **Parallel Bus Definition** – The digital information obtained by viewing parallel ADDR or DATA bus information can be defined as a bus display. Users can also define a digital trigger for a particular bus value. Up to 4 different buses can be defined.
- **User Interface** – A familiar interface eliminates the need to spend a lot of time learning a new tool.
- **Resize/Reposition** – Digital lines can be resized and repositioned anywhere on the oscilloscope grid by using the front panel controls or software menus.
- **Flexibly Trigger** – Select from a number of different analog triggers; or create a digital trigger by defining a digital trigger pattern, logic bus value, or interval.
- **Cursors** – Cursors will read time or bus information, as appropriate.
- **Quick Setup** – Unlike a traditional Logic Analyzer, the MS-32 is easy to use. A single module consolidates all of the MS-32/oscilloscope interconnections, so users can start viewing signals and debugging quickly. In addition, all standard oscilloscope tools are readily accessible.

## MS-32

**WaveSurfer Xs and 400 Series  
(350 to 600 MHz only)**

Designed for those customers requiring a basic oscilloscope for signal viewing and for performing basic timing measurements.

**Available for 434, 454, 44Xs, 64Xs, 104Xs**

Bandwidth Range	350 MHz–1 GHz
# Analog Channels	4
Analog Sample Rate	2.5 GS/s per channel (1 GS/s for 434, 454)
Analog Memory	2.5 Mpts/Ch (1 Mpts/Ch for 434, 454)
Digital Memory	1 Mpts/Ch (with MS-32)
Application Packages	I <sup>2</sup> C, SPI, CAN Bus
Display Size	10.4"
Operating System	Windows® XPe



WAVESURFER Xs

**WaveRunner Xi and 6000A Series**

Its higher performance capabilities and longer standard and optional memories are intended for customers who need to perform analysis on long records, or have specific application problems (such as CAN Bus testing).

**Available for 6030A, 44Xi, 6050A, 64Xi, 6100A, 104Xi, 6200A, 204Xi**

Bandwidth Range	350 MHz–2 GHz
# Analog Channels	4
Analog Sample Rate	Up to 5 GS/s per channel 10 GS/s max. (64Xi, 6100A, 6200A)
Analog Memory	10 Mpts/Ch for 44Xi, 64Xi, 104Xi, 204Xi 5 Mpts/Ch for 6030A, 6050A, 6100A, 6200A Options up to 12 Mpts/Ch for all models
Digital Memory	1 Mpts/Ch (with MS-32)
Application Packages	I <sup>2</sup> C, SPI CAN Bus, Power, Jitter & Timing, Digital Filter, Serial Data Mask, ENET (WR6200A only) USB2 (WR6200A only)
Display Size	10.4" (8.4" on WR6000A Series)
Operating System	Windows® XP



WAVERUNNER Xi

**WaveMaster 8000A and WavePro 7000A Series**

MS-32 is also compatible with LeCroy's WavePro and WaveMaster Series oscilloscopes, with bandwidths between 1–6 GHz for faster sampling rates and long memory capture.

**Available for WM8400A XXL, 8600A XXL, 8420A, 8620A  
WP7100A, 7200A, 7300A, 7100A XXL, 7200A XXL, 7300A XXL**

WAVEMASTER 8000A

MS-32

MS-32 System Components



- 1 Oscilloscope Interface Module
  - 2 Power Supply
  - 3 USB 2.0 Cable
  - 4 32 Channel Digital Logic Pod
  - 5 10.5" Digital Lead Set
  - 6 Foam Lined Soft Accessory Case
- 5x Magnifying Glass  
*(not pictured)*



MS-32 Gripper Probe Set Accessories

**PK400-1** – Large gripper probe set for 0.10" (2.54 mm) pin pitch, includes 10 probes with color-coded leads



**PK400-2** – Medium gripper probe set for 0.04" (1.0 mm) pin pitch, includes 10 probes with color-coded leads



**PK400-3** – Small gripper probe set for 0.008" (0.2 mm) pin pitch, includes 10 probes with color-coded leads

SPECIFICATIONS

DIGITAL CHANNELS

Number	32
Memory	1 Mpts/Ch
Probe Inputs	240 kΩ    10 pF
Threshold Levels	TTL, ECL, CMOS (2.5, 3.3, 5 V), PECL, or User Defined.
Sampling Rate	1 kS/s to 500 MS/s
Minimum Input Voltage Range	±300 mV around the threshold voltage setting
Maximum Clock Speed	125 MHz
Maximum Input Voltage	30 V
Digital Channel Grouping	4 digital groups can be defined. Each group may use any combination of 32 digital lines. Groups can be displayed as individual lines, or collapsed into a bus view.

Triggering User selectable analog (i.e., std. oscilloscope trigger) or digital trigger

DIGITAL TRIGGER

Setup Type	Logic, Logic Bus, or Interval
Logic Setup	Up to 32 digital lines, with any combination of 0, 1, or X (don't care). In addition, a Rising Edge, Falling Edge, or Either Edge condition may also be set (Note: multiple edges are OR combined).
Logic Bus Setup	Up to 32 digital lines, defined in hexadecimal format

## MS-32

## SPECIFICATIONS (CONTINUED)

## DIGITAL TRIGGER

Interval	Define a single digital line, the slope, the condition, and the time period in which the second occurrence of that digital line should occur. Available conditions are < or >.
Accuracy	±1 digital sample (based on digital sample rate)
Certifications	CE Approved. Conforms to EN61326-1 and EN61010-1

## PHYSICAL DIMENSIONS

Pod Dimensions (WLD)	3.8" x 6.3" x 1.2" (9.6 cm x 16 cm x 3 cm)
Pod Weight	14 oz. (397 g)
Complete System Dimensions (WLD)	12.5" x 9.8" x 2.5" (32 cm x 25 cm x 6.4 cm)

## ORDERING INFORMATION

## PRODUCT CODE

## OSCILLOSCOPE MIXED SIGNAL OPTION

32 Digital Channel Oscilloscope Mixed Signal Option (for WaveSurfer or WaveRunner Series)	MS-32
32 Digital Channel Oscilloscope Mixed Signal Option (for WavePro or WaveMaster Series)	MS-32-DSA
MS-32 with License to use on 2 Oscilloscopes	MS-32-2LIC
MS-32 with License to use on 5 Oscilloscopes	MS-32-5LIC

## INCLUDED WITH STANDARD CONFIGURATION

32 Digital Channel Logic Pod with Power Supply	
10.6" (27 cm) Lead Set	
6 ft. (1.8 m) USB 2.0 Cable	
Oscilloscope Interface Module with 5 ft. (1.5 m) Cables	
Soft Accessory Case	
Magnifying Glass (5x)	
Printed Operator's Manual (English)	
Quick Reference Guide (English)	
CE Conformance Certificate Contained in Manual	

## HARDWARE OPTIONS AND ACCESSORIES

Large Gripper Probe Set for 0.10" (2.54 mm) Pin Pitch, Includes 10 Probes with Color-coded Leads	PK400-1
Medium Gripper Probe Set for 0.04" (1.0 mm) Pin Pitch, Includes 10 Probes with Color-coded Leads	PK400-2
Small Gripper Probe Set for 0.008" (0.2 mm) Pin Pitch, Includes 10 Probes with Color-coded Leads	PK400-3
10" Digital Lead Set, 32 Digital Channel Lead Set (for Clock Speeds ≤ 125 MHz)	MS-32-STDLEADS
14" Digital Lead Set, 32 Digital Channel Lead Set (for Clock Speeds < 25 MHz)	MS-32-STDLEADS-L
Mictor Connection Cable, 3" long (7.6 cm), 38-pin (for Clock Speeds ≤ 125 MHz)	MS-32-Mictor-S
Mictor Connection Cable, 14" long (35.6 cm), 38-pin (for Clock Speeds < 100 MHz)	MS-32-Mictor-L
Retrofit GoLogic U36-1M to MS-32	RK-GOLOGIC-MS-32





## INSTRUMENT CARTS

LeCroy's new line of sturdy instrument carts create streamlined workstations designed to address space confines while adding mobility and versatility to oscilloscopes and related equipment.

### Features:

- Steel and aluminum frame finished with a durable powder-coat epoxy
- Height- and angle-adjustable shelves
- Base bin for storage of larger instruments and accessories
- Mounting straps to secure instruments
- High quality casters; 2 locking casters
- Drawer for storage of small, delicate leads, and cables (OC1024)
- Pegboard style side panels for storage of probes, cables, and accessories (OC1024)



OC1024/OC1021

### SPECIFICATIONS

#### OC1024

Width	57.9 cm (22.8")
Depth	55.9 cm (22")
Height	137 cm (54")
Weight	36 kg (79 lbs.)

#### OC1021

Width	54.8 cm (21.6")
Depth	55.9 cm (22")
Height	76.2 cm (30")
Weight	21.8 kg (48 lbs.)

#### Top Shelf

Width	50.8 cm (20") [46.48 cm (18.3") between side extrusions]
-------	---

#### Tilt Shelf

Width	45.9 cm (18.1")
Depth	50.8 cm (20")

#### Bottom Bin

Width	49.5 cm (19.5")
Depth	43.1 cm (17")
Height	4.0 cm (1.6")

### ORDERING INFORMATION

137 cm (54") high oscilloscope cart with height and angle adjustable tilt shelf, top shelf with drawer, bottom bin, mounting straps, and "pegboard" style side panels. Supports all models in LeCroy oscilloscope line.

### PRODUCT CODE

OC1024

76.2 cm (30") high oscilloscope cart with height and angle adjustable tilt shelf, bottom bin, and mounting straps. Supports all models in LeCroy oscilloscope line.

OC1021



OE555

OE525

OE455

OE425

## OE CONVERTERS

These wide-band multi-mode optical-to-electrical converters are designed for measuring optical communications signals. Their broad wavelength range and multi-mode input optics make these devices ideal for applications including Gigabit Ethernet and Fibre Channel, as well as SONET/SDH up to 2.5 Gb/s.

The OE425 and OE455 are ProBus modules compatible with WavePro and WaveRunner oscilloscopes as well as WaveMaster when used with a LPA-BNC adapter. The OE525 and OE555 are ProLink modules compatible with WaveMaster, SDA, and DDA oscilloscopes.

### Features:

- Frequency range to 5 GHz (6 GHz optical)
- 62.5  $\mu\text{m}$  or narrower multi-mode or single-mode fiber input
- Broad wavelength range:
  - 500–870 nm (OE425, OE525)
  - 950–1630 nm (OE455, OE555)
- High responsivity
- Low noise

SPECIFICATIONS	OE425/OE525	OE455/OE555
Wavelength Range	500–870 nm 460–870 nm (0.1 V/mW)	950–1630 nm 800–1630 nm (0.1 V/mW)
Conversion Gain	0.5 V/mW	1.1 V/mW
Bandwidth	5 GHz (6 GHz optical)	3.5 GHz (4.5 GHz optical)
Equivalent Noise	2.2 $\mu\text{W}_{\text{rms}}$	1.2 $\mu\text{W}_{\text{rms}}$
Maximum Optical Power (at 5% saturation)	2.2 mW	1.3 mW
Rise Time	90 ps	108 ps
Maximum Safe Input	5.5 mW	1.3 mW
Temperature Drift	0.00275 dB / °C	0.00275 dB / °C
Frequency Response Ripple	1.1 dB	1.1 dB
Connector Type	FC/PC	FC/PC

### ORDERING INFORMATION

### PRODUCT CODE

Optical-to-Electrical Converter, 500–870 nm ProBus BNC Connector	OE425
Optical-to-Electrical Converter, 950–1630 nm ProBus BNC Connector	OE455
Optical-to-Electrical Converter, 500–870 nm ProLink BMA Connector	OE525
Optical-to-Electrical Converter, 950–1630 nm ProLink BMA Connector	OE555

### INCLUDED ACCESSORIES

Multi-mode optical fiber jumper FC-FC  
FC to ST adapter  
FC to SC adapter

## TRANSIT CASES

### ORDERING INFORMATION

Soft Accessory Case for Probes – features inside flap for storing manuals, plus roomy interior for a probe and its many accessories.

SAC-01

Hard Transit Case for WaveMaster, DDA5005A, and SDA Series – molded high density polyethylene plastic case. Features pull handle and wheel with custom polyethylene foam interior. 25" x 23" x 14"

WM-TC1

Soft Carrying Case for WaveMaster, DDA5005A, and SDA Series – nylon and herculyte vinyl shell. Features accessory pouch, shoulder strap, diamond rubber feet, foam insert, and plastic reinforcement. 20.5" x 13.5" x 16.5"

WM-SCC

Soft Carrying Case for WaveRunner Xi

WRXi-SOFTCASE

Hard Transit Case for WaveRunner Xi

WRXi-HARDCASE

Hard Transit Case for WaveRunner 6000A

WR6-HARD

Soft Carrying Case for the WaveRunner 6000A

WR6-SOFT

Hard Carrying Case for WaveSurfer Xs

WSXs-HARDCASE

Soft Carrying Case for WaveSurfer Xs

WSXs-SOFTCASE

Hard Shell Transit Case

SDA11-TC1

(for SDA 18000, SDA 11000 and SDA 9000 only)



SAC-01



WM-TC1



WM-SCC

## AP-1M

The AP-1M offers a convenient method to provide high impedance input when using the WaveMaster Series oscilloscopes, DDA5005A, and SDA Series.

### Features:

- 500 MHz bandwidth (typical)
- 1 M $\Omega$  input impedance path
- FSR  $\pm 8$  V dynamic range

### Compatible with the following accessories:

- High impedance passive probes (not required for PP066)
- ADP300/ADP305/AP031 differential probes
- Cpxxx series current probes. Includes PP005A Passive Probe

### ORDERING INFORMATION

1 M $\Omega$  Adapter includes PP005A Passive Probe

### PRODUCT CODE

AP-1M



AP-1M



## VT75 VIDEO TRIGGER



VT75

VT75 is an accessory that provides video triggering on standard and custom video signals. The device is configured to allow the analog input signal to pass through to the input channel while picking off the triggering information. The input impedance is video standard 75 ohm, and the connector is a true 75 ohm BNC. In addition to standard settings, the VT75 has a custom option that allows users to set the field and line number to trigger on, as well as the sync polarity and interlace. By selecting TV Auto Setup, the oscilloscope sets the vertical and time scale factors, trigger, and other modes necessary to obtain a stable view of a video field.

### Features:

- Presets for standard NTSC, PAL, SECAM video signals
- CUSTOM mode allows selection of field and line numbers
- Standard 75 ohm video input

### SPECIFICATIONS

Preset Standards	NTSC, PAL, SECAM
Custom	Any line 1–1500, and field 1–8 Positive or negative sync, 8:1, 4:1, 1:2, or 1:1 interlace
Input Impedance	75 $\Omega$
Input Range	500 mV – 2 V <sub>p-p</sub>
Compatibility	X-Stream oscilloscope with ProBus interface
VT75 Includes	0.9 m (36") 75 $\Omega$ BNC cable, SAC-01 Soft Accessory Case

### ORDERING INFORMATION

### PRODUCT CODE

Video Trigger Module	VT75
Soft Accessory Case	SAC-01

## D11000PS DIFFERENTIAL PROBE SYSTEM

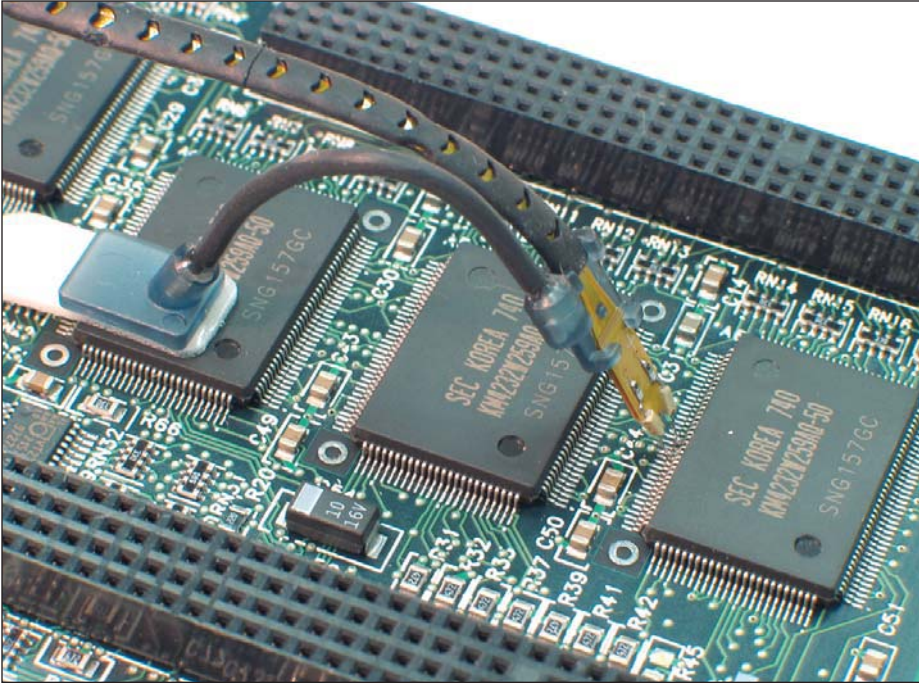

The D11000PS extends the full signal acquisition performance of the SDA 11000 and SDA 9000 to the probe tips. With 11 GHz system bandwidth, the probe enables direct measurement of high-speed serial data streams up to 6.25 Gb/s. The D11000PS also provides 11 GHz system bandwidth when used with the SDA 18000.

### Choice of Interconnect Styles Without Compromising Performance

The D11000PS provides both direct Solder-In and cabled SMA interconnect lead assemblies. Each interconnect lead comes with a dedicated probe amplifier module that has calibration data optimized for the respective lead. This eliminates the performance compromise of using a single calibration for multiple lead types. The Solder-In lead provides the highest possible signal integrity with a high loading impedance. The dual SMA interconnect leads provide a true differential 50  $\Omega$  input. This is a convenient alternative to direct cabling into the oscilloscope inputs, freeing up the second channel for other signal input, and eliminating the need to set up waveform math and match cable delays.

### Unsurpassed Waveform Accuracy

When used to acquire input signals for the SDA 11000, SDA 9000, or SDA 18000, the D11000PS provides unprecedented waveform fidelity, even with signals at higher serial data rates. The D11000PS utilizes third generation compensation calibration, the most advanced in use today, to provide optimal system response.

Each individual probe is characterized with this system. Information on the probe's frequency and time domain responses are stored in non-volatile memory within the probe amplifier module. This information is uploaded to the higher bandwidth SDA's when the probe is connected. The probe calibration data and the SDA oscilloscope's calibration data combine to generate new equalization filters for the composite system. The resulting compensation system corrects for frequency response deviations, as well as group delay correction and reflection cancellation.

## D11000PS DIFFERENTIAL PROBE SYSTEM

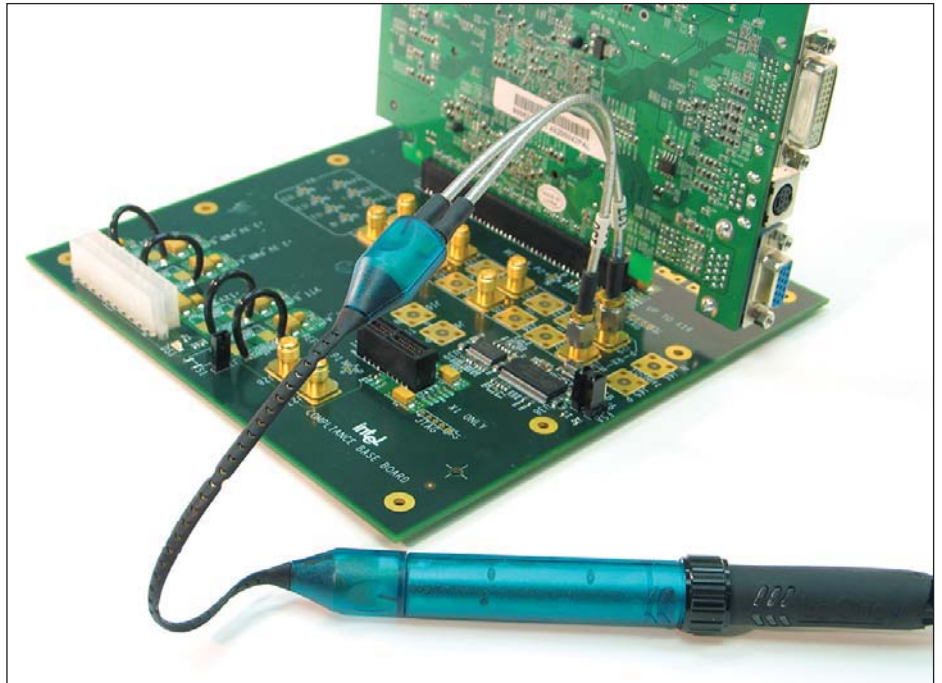

Reproducing accurate serial data eye patterns requires maintaining precise magnitude and phase relationships between the fundamental and the odd harmonics. The advanced calibration system used in the D11000PS assures the best eye pattern fidelity.

### Superior Probe Loading Characteristics

Accurate frequency response is not enough to assure good waveform fidelity. Excessive probe loading can cause waveform distortion. The D11000PS continues the legacy of LeCroy high-performance probe design, placing special emphasis on minimizing loading of the circuit under test.

The Solder-In lead and dedicated probe amplifier module have a high input resistance at DC and low frequencies, allowing the probe to be used in circuits which cannot drive the low resistance of a pure transmission line probe. The direct cabled SMA inputs have 50  $\Omega$  input impedance with low VSWR.

### Ease of Use

Attention to fine details during the D11000PS design process has resulted in several "ease of use" features. A common mode measure feature allows the user to measure the average common mode component with a single click in the probe control menu. AutoColor ID lights an indicator in the probe body, matching the color of the waveform trace. When multiple channels are used, this feature instantly identifies which waveform corresponds to which probe.

Several connection accessories designed specifically for the D11000PS provide convenient and secure mounting of the probe body and Solder-In tip to the test circuit. DC blocking adapters extend the common mode range of the SMA cabled input for use with higher common mode voltages such as Digital Video Interface (DVI). A finger wrench allows tightening of SMA connectors on dense test fixtures.

## D11000PS DIFFERENTIAL PROBE SYSTEM

### Compatibility

The D11000PS is designed specifically for use with the SDA 11000, SDA 9000, or SDA 18000. However, it does contain additional calibration data for use with all of the lower bandwidth WaveMaster, SDA, and DDA 5005A Series oscilloscopes and analyzers.

### SPECIFICATIONS

Bandwidth, System, -3 dB	11 GHz (Typical)*
Rise Time, System	< 50 ps (Typical)*
Rise Time, Probe only	< 40 ps
Attenuation, Nominal	÷3
LF Attenuation Accuracy	2% (20–30 °C)
Output Zero	< 15 mV referred to input
Noise, System	5 mV rms (Typical) <sup>1</sup>
Differential Mode Range	±1 V
Common Mode Range	±4 V, Solder-In tip ±2 V, SMA cable input <sup>†</sup>
Input Resistance at DC, (Solder-In lead)	40 kΩ differential 20 kΩ each side to ground
Minimum Input Impedance, (Solder-In lead, to 11 GHz)	> 175 Ω (Refer to graph)
Input Impedance, (SMA cable input)	50 Ω
Input VSWR, (Typical, each lead to ground)	< 1.5:1 DC–6 GHz < 2.0:1 6 GHz–11 GHz
CMRR, (Typical)	> 40 dB DC–1 GHz > 30 dB 1 GHz–4 GHz > 20 dB 4 GHz–11 GHz

\* Measured as a system with SDA 11000, SDA 9000 and SDA 18000.

† Can be extended by using DC Blocking Adapters.



**D11000PS DIFFERENTIAL PROBE SYSTEM**

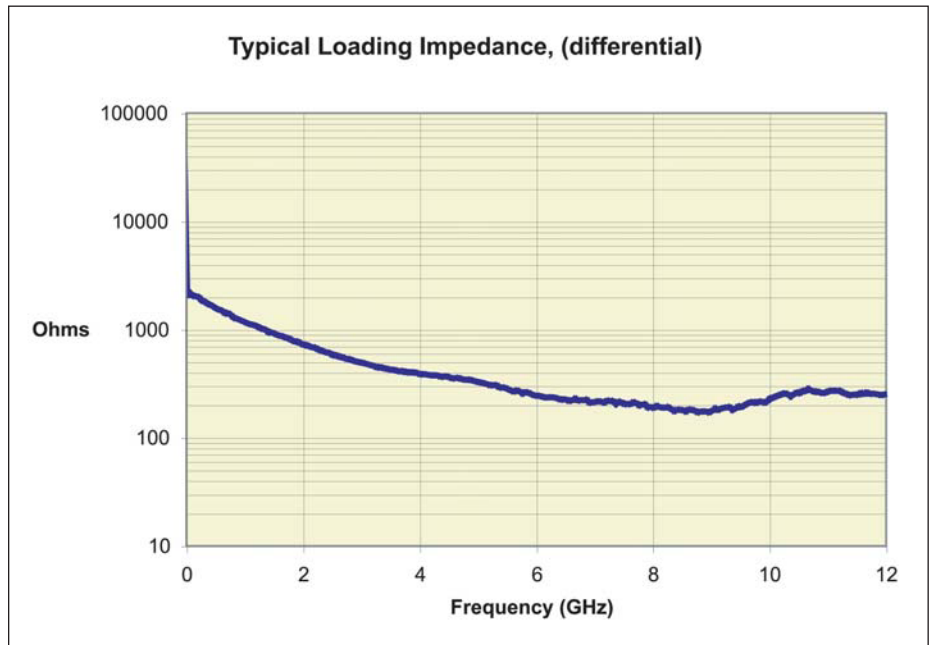

**D11000PS Includes:**

Probe amplifier modules (2–1 each for SMA input and Solder-In lead), Solder-In lead assembly (2), SMA interconnect lead, SMA input cables (matched pair), Probe body, SMA DC blocking adapters (2), ground lead and clip, SMA finger wrench (2), tip retaining clip kit for Solder-In lead, probe body mounting clamp set, FreeHand probe stand, ESD dissipating wrist strap, SAC-01 soft accessory case with insert, small accessory case, D11000PS Instruction Manual, certificate of traceable calibration.

**ORDERING INFORMATION**

**PRODUCT CODE**

Differential Probe System	D11000PS
Replacement Solder-In Tip Assembly	D11000SI
NIST Traceable Calibration with Test Data (one module)	D11000PS-CCNIST

## WAVELINK DIFFERENTIAL PROBES

WaveLink high bandwidth differential probes are designed to provide an optimum mechanical connection for signal measurement. They virtually eliminate distortion when measuring signals, which is particularly useful in eye pattern measurements—now routine for systems using fast serial data bus architecture. WaveLink probes provide industry-leading technology for wideband signal connection to test instruments. The first differential probes to employ SiGe technology, they deliver full system bandwidth when used with LeCroy 6 GHz, 5 GHz, and 3 GHz instruments. They are also the first differential probes to use a unique calibration process to achieve superb waveform fidelity for routine voltage measurements.

### Features:

- Unique adjustable tips for reliable contact
- Wide assortment of small tips ideal for restricted spaces
- Best-in-class probe loading for accurate signal measurement
- Superior loading characteristics and precise frequency response
- Outstanding fidelity for high-speed signals

### D600A-AT and D300A-AT Features:

- Built-in thumbwheel for precise positioning of tip; stays put after adjustment
- Maintains sharp points for good contact
- Tips made of “NiTiNOL,” a super-elastic nickel-titanium alloy
- Probe flexes as you apply pressure and consistently returns to original form

### D600ST and D350ST Features:

- Best-in-class mechanical design for optimum utility
- Small tip high bandwidth differential probe
- Three interconnect configurations for flexibility
- Very small form factor for accessing tight spaces
- Highly flexible long lead
- Inexpensive and easily replaceable

### D500PT Positioner Mounted Tip Features:

- Positioned tip assembly
- Very small tip geometry for accessing physically constrained locations
- Ideal for applications requiring multiple probes on adjacent pads
- Telescoping tips for reliable tip contact—even when probe is tilted
- Mounts in probe positioner or can be hand held
- EZ-Probe positioner available as an accessory

### WaveLink D600ST and D350ST

Best-in-class mechanical design for optimum utility:

- Small tip, high bandwidth differential probe
- Three interconnect configurations for flexibility
- Very small form factor for accessing tight spaces

Each of the interchangeable leads is a thin, highly flexible 145 mm (5.7”) long lead connecting the tip and the D600ST/D350ST probe tip module.



D600A-AT

D300A-AT

D600ST

D350ST

D500PT



## WAVELINK DIFFERENTIAL PROBES

### FLEXIBLE INTERCONNECTION OPTIONS —WITHOUT SACRIFICING PERFORMANCE

#### D500PT Positioner Mounted Probe Tip Module

The probe has a very thin form factor, allowing multiple probes to be used when several channels are required to monitor signals from the same small IC. It has 2 mm of Z-axis compliance through spring-loaded telescoping tips, allowing considerable angular freedom relative to the circuit board while still maintaining reliable contact with both inputs. A ball joint between the tip and mounting arm makes it even easier to adjust for placement when already mounted in a positioner. A small thumbscrew allows precise and secure adjustment of the tip spacing.

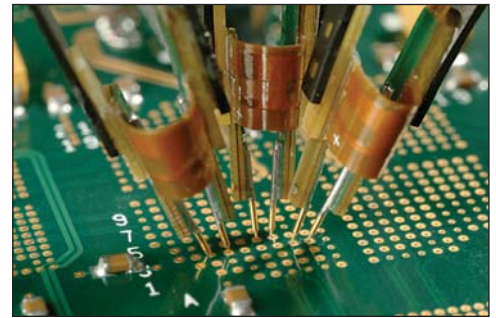

*The Probe Tip Modules contain the active amplifier circuitry. Different modules have different electrical and physical interconnect characteristics, allowing the user to select the module appropriate for the application.*

#### D600A-AT and D300A-AT Adjustable Tips

WaveLink adjustable tip probes are designed to provide an optimum mechanical connection for signal measurement.

- Built-in thumbwheel for precise positioning of tip—stays put after adjustment
- Maintains sharp points for good contact
- Tips made of “NiTiNOL,” a super-elastic nickel-titanium alloy
- Flexes as you apply pressure
- Consistently returns to original form

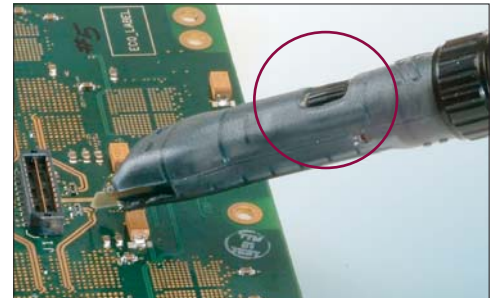

#### EZ-Probe Positioner

The EZ-Probe positioner provides stable, accurate positioning in the x-y-z axis. Ideal for use with the D500PT and D600A-AT/D300A-AT probe tips. The unique, 3:1 motion reduction joystick allows simple, precise positioning of the attached probe in both the horizontal and vertical measuring plane. The probe has a fully articulating arm, providing 30 cm (12") reach in virtually any direction.





## WAVELINK DIFFERENTIAL PROBES

### THREE DIFFERENT TIPS FOR INTERCONNECT FLEXIBILITY

#### Solder-In Lead

The Solder-In interconnect lead features the smallest physical tip size of any high bandwidth differential probe and the highest level of electrical performance. Two very small damping resistors are directly soldered into the connect points providing a reliable, intermittent free electrical connection. The resistors have highly flexible leads allowing connection to input points with a wide range of input spacing.



#### Quick Connect (D600ST only)

The Quick Connect interconnect lead enables you to quickly move the probe between multiple test points on the test circuit. Just solder a pair of damping resistors at each location where interconnection is required. A small connector mounted on the probe tip, plugs into the damping resistors, letting you quickly move between sets of test points.

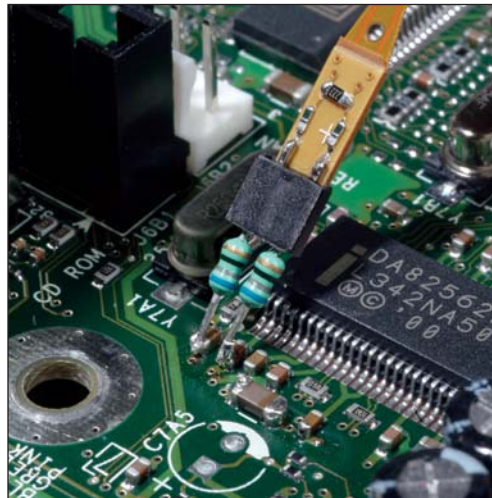

#### Square Pin

Many applications, such as IC characterization boards, use standard 0.025" square pins for interconnect. The Square Pin interconnect lead directly mates with a pair of 0.025" (0.635 mm) square pins which are mounted on standard 0.100" (2.54 mm) centers.

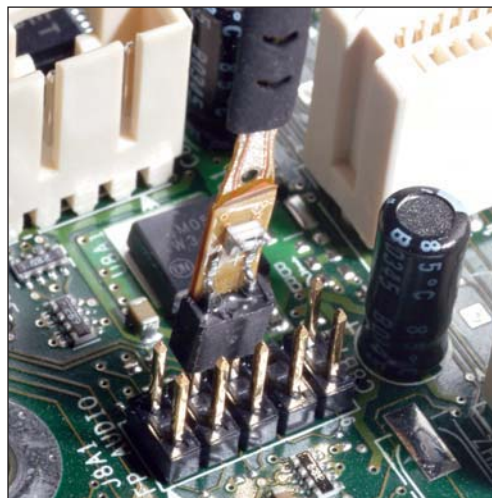



## WAVELINK DIFFERENTIAL PROBES

### SPECIFICATIONS

#### Rise Time, probe only

D600A-AT	< 70 ps*
D600ST-SI	< 65 ps*
D500PT	< 100 ps†
D300A-AT	< 95 ps‡
D350ST-SP	< 90 ps‡

#### LF Attenuation Accuracy (with 0 V common mode)

D600A-AT, D300A-AT, D600ST, and D500PT	2% 0 ±1.2 V 5% ±1.2 V ±2.4 V
D350ST	2% 0 ±2.5 V 5% ±2.5 V ±5 V

#### Output Zero

(within 15 minutes after Autozero)

D600A-AT, D300A-AT, D600ST, and D500PT	< 10 mV RTI
D350ST	< 20 mV RTI

#### Bandwidth, System DC to -3 dB (Typical)

D600ST-SI	6 GHz**
D600ST-QC	4 GHz**
D600ST-SP	3 GHz**
D600A-AT	6 GHz**
D300A-AT	3 GHz††
D350ST-SP	3 GHz††
D350ST-SI	3 GHz††
D500PT	5 GHz†

#### Input Dynamic Range

D600A-AT, D300A-AT, D600ST, and D500PT	±2.4 V
D350ST	±5 V

#### Common Mode Range

(Max. peak voltage either input to ground)

D600A-AT, D300A-AT, D600ST, and D500PT	±2.4 V
D350ST	±5 V

#### DC Input Resistance

D600A-AT, D300A-AT, D600ST, and D500PT	4 kΩ differential 2 kΩ either input to ground
D350ST	8 kΩ differential 4 kΩ either input to ground

\*Measured with 6 GHz or greater oscilloscope

†Measured with 5 GHz oscilloscope

‡Measured with 3 or 4 GHz oscilloscope

\*\*Typical, with 6 GHz or greater oscilloscope

††Typical, with 3 or 4 GHz oscilloscope

## WAVELINK DIFFERENTIAL PROBES

### SPECIFICATIONS (CONTINUED)

#### CMRR

D600A-AT		
DC to 1 GHz	> 40 dB	
1 GHz to 3 GHz	> 30 dB	
3 GHz to 7 GHz	> 20 dB	
D600ST		
DC to 1 GHz	> 30 dB	
1 GHz to 3 GHz	> 25 dB	
3 GHz to 7 GHz	> 20 dB	
D500PT		
DC to 1 GHz	> 25 dB	
1 GHz to 3 GHz	> 19 dB	
3 GHz to 5 GHz	> 16 dB	
D350ST		
DC to 1 GHz	> 30 dB	
1 GHz to 3 GHz	> 25 dB	
D300A-AT		
DC to 1 GHz	> 40 dB	
1 GHz to 3 GHz	> 30 dB	

#### Noise

D600A-AT, D600ST, D500PT	5.8 mV <sub>rms</sub> with 6 GHz oscilloscope
D300A-AT	5.0 mV <sub>rms</sub> with 3 GHz oscilloscope
D350ST	9.5 mV <sub>rms</sub> with 3 GHz oscilloscope

### ORDERING INFORMATION

### PRODUCT CODE

#### PROBE TIP MODULES

WaveLink 7.5 GHz, Differential Probe Adjustable Tip Module	D600A-AT*
WaveLink 4 GHz, Differential Probe Adjustable Tip Module	D300A-AT*
WaveLink 7 GHz, Differential Probe Small Tip Module	D600ST*
WaveLink 4 GHz, 5 V Differential Probe Small Tip Module	D350ST*
WaveLink 6 GHz, Differential Positioner Mounted Tip Module	D500PT*

#### PROBE BODIES

WaveLink ProLink Probe Body	WL600
WaveLink ProBus Probe Body	WL300

#### POSITIONER

Cascade Microtech EZ-Probe Positioner	EZ PROBE
---------------------------------------	----------

#### SERVICE OPTIONS

NIST Traceable Calibration with Test Data <sup>†</sup> (one module)	D600A-AT-CCNIST D300A-AT-CCNIST D600ST-CCNIST D350ST-CCNIST D500PT-CCNIST
--	---

\* For a complete probe, order a WL300 or WL600 Probe Body with Probe Tip Module.

<sup>†</sup>-CCNIST NIST traceable calibration with test data is an available option for D600ST, D350ST, D500PT, D600A-AT, or D300A-AT probe tip module only when ordered with either a WL600 or WL300 probe body.

## WAVELINK DIFFERENTIAL PROBES

### ORDERING INFORMATION (CONTINUED)

### PRODUCT CODE

#### CONSUMABLES AND REPLACEMENT PARTS

Replacement Quick Connect Lead Set for D600ST	D600ST-QC
Replacement Solder-In Lead Set for D600ST	D600ST-SI
Replacement Square Pin Lead Set for D600ST	D600ST-SP
Extra Solder-In Lead for D350ST	D350ST-SI
Extra Square Pin Lead for D350ST	D350ST-SP
Replacement Tip Assembly for D500PT	D500PT-TIP
Replacement Resistor Kit for D600ST-SI (10)	PK600ST-1
Replacement Resistor Kit for D600ST-QC (20)	PK600ST-2
Replacement Probe Tip Holder Kit	PK600ST-3
Replacement Probe Body Mounting Kit	PK600ST-4
Replacement Probe Tips for D500PT (pkg. of 4)	PK500PT-1
Replacement Resistor Kit for D350ST-SI (10)	PK350ST-1
Probe Characterization Fixture	PCF-200
WaveLink Probe Series Instruction Manual	WL-OM-E

#### **D600A-AT, D300A-AT Adjustable Tip Modules Include:**

Protective storage case, ground wire and clip, WaveLink Series instruction manual, Quick Start guide, calibration certificate.

#### **D600ST Small Tip Module Includes:**

Solder-In interconnect lead set with replacement damping resistors (10), Quick Connect interconnect lead set with additional damping resistors (20), Square Pin interconnect lead set, ground wire and clip, probe tip mounting kit, WaveLink Series instruction manual, Quick Start guide, calibration certificate.

#### **D350ST Small Tip Module Includes:**

Solder-In interconnect lead set with replacement damping resistors (10), Square Pin interconnect lead set, ground wire and clip, probe tip mounting kit, WaveLink Series instruction manual, Quick Start guide, calibration certificate.

#### **D500PT Positioner Mounted Tip Includes:**

Positioned tip assembly, Probe tip module, Module mounting clamp, Ground lead and clip, WaveLink Series instruction manual, Quick Start guide, Calibration certificate, FreeHand probe stand, Tip repair tool, Replacement tips (2)

#### **WL600, WL300 Probe Bodies Include:**

SAC-01 Soft accessory case with WaveLink Series insert, probe characterization fixture, probe body mounting clip, probe cable clamp (2), and small probe accessory case.

#### **WaveLink Probe Calibration**

When ordered with WL600 or WL300 also substitute: Certificate of NIST traceable calibration in place of calibration certificate.

## WAVELINK DIFFERENTIAL PROBES

### WAVELINK PROBE COMPATIBILITY CHART

	SDA 18000*					WR 204Xi		
	SDA 11000*					WR 104Xi		
	SDA 9000*				WP7300A	WR 64Xi		
	SDA 6020	WM8620A			WP7200A	WR 44Xi		
	SDA 4020	WM8420A	DDA 5005A	DDA 3000	WP7100A	WR 6KA	WL300	WL600
D600A-AT	•	•	•				RP	FP
D300A-AT				•	•	•	FP	FP
D600ST	•	•	•				RP	FP
D350ST	•	•	•	•	•	•	FP	FP
D500 PT	•	•	•	•	•	•	RP	FP
WL600	•	•	•	NC	NC	NC		
WL300	RP <sup>1</sup>	RP <sup>1</sup>	RP <sup>1</sup>	•	•	•		

•	Recommended
NC	Not Compatible
FP	Operates at Full Performance
RP	Operates with Reduced Performance with LPA adapters. Frequency response > 3 GHz may be altered
RP <sup>1</sup>	Operates with Reduced Performance with LPA adapters. Frequency response > 3 GHz may be altered

\*Operates on channels in 6 GHz mode only





## PASSIVE PROBES

Passive probes are the standard probe provided with most oscilloscopes. Typical passive probes provide a 10:1 attenuation and feature a high input resistance of 10 MΩ. This high input resistance means that passive probes are the ideal tool for low frequency signals since circuit loading at these frequencies is minimized. Passive probes are designed to handle voltages of at least 400 V, some as high as 600 V. LeCroy passive probes feature an attenuation sense pin which tells the oscilloscope to scale the waveforms automatically requiring no user input.

Each passive probe is recommended for a certain oscilloscope, using the right passive probe with the right oscilloscope means that the probe can be properly compensated across the entire bandwidth. Using probes with a different oscilloscope will only let you compensate for low frequencies.

### Features:

- Bandwidth from 200 MHz to 500 MHz
- Probe encoding ring for automatic scale factor readout on LeCroy oscilloscopes

Model	Bandwidth	Input R	Input C	Attenuation	Maximum Voltage	Diameter	Recommended Oscilloscope
PP005A	500 MHz	10 MΩ	11 pF	10:1	500 V	5 mm	1, 2, 12, 13
PP006A	500 MHz	10 MΩ	12 pF	10:1	600 V	5 mm	3, 11
PP007-WS	500 MHz	10 MΩ	9.5 pF	10:1	400 V	2.5 mm	4
PP007-WR	500 MHz	10 MΩ	9.5 pF	10:1	400 V	2.5 mm	5, 7, 9
PP008	500 MHz	10 MΩ	9.5 pF	10:1	400 V	2.5 mm	4, 6, 8
PP009	500 MHz	10 MΩ	9.5 pF	10:1	400 V	5 mm	4, 6, 8
PP010	200 MHz	10 MΩ	12.5 pF	10:1	600 V	5 mm	10
PP011	500 MHz	10 MΩ	9.5 pF	10:1	400 V	5 mm	5, 7, 9

### Recommended Oscilloscope

- |                                    |                                    |
|------------------------------------|------------------------------------|
| 1 9300 Series                      | 8 WaveSurfer Xs Series (≤ 600 MHz) |
| 2 LC Series                        | 9 WaveSurfer Xs Series (1 GHz)     |
| 3 LT Series                        | 10 WaveJet Series (≤ 200 MHz)      |
| 4 WaveSurfer 400 Series            | 11 WaveJet Series (≥ 350 MHz)      |
| 5 WaveRunner 6000 Series           | 12 WavePro 900 Series              |
| 6 WaveRunner Xi Series (≤ 600 MHz) | 13 WavePro 7000 Series             |
| 7 WaveRunner Xi (1 GHz–2 GHz)      |                                    |

### ORDERING INFORMATION

- ±10, 500 MHz 10 MΩ Passive Probe
- ±10, 500 MHz 10 MΩ Passive Probe
- ±10, 500 MHz 10 MΩ Passive Probe
- ±10, 500 MHz 10 MΩ Passive Probe
- ±10, 500 MHz 10 MΩ Passive Probe
- ±10, 500 MHz 10 MΩ Passive Probe
- ±10, 200 MHz 10 MΩ Passive Probe
- ±10, 500 MHz 10 MΩ Passive Probe

### PRODUCT CODE

- PP005A
- PP006A
- PP007-WS-1
- PP007-WR-1
- PP008
- PP009
- PP010
- PP011

**PASSIVE PROBES ACCESSORIES**

**ORDERING INFORMATION**

**PRODUCT CODE**

**PK001 – Standard Probe Accessory for PP002**

Ground Lead PP002	PP001/002-1
Probe Tip to BNC adapter	PP001/002-2
Sprung Hook PP002	PP001/002-3
M/F Lead – Long (4")	
M/F Lead – Short (2")	

**PK102 – Standard Probe Accessory Kit for PP005/PP005**

Sprung Hook (Black)	PP005-HOOK
Spring Tip (0.38 mm)	PP005-ST38
Spring Tip (0.8 mm)	PP005-ST8
Rigid Tip (0.8 mm)	PP005-RT
Probe Tip to BNC Adapter	PP005-BNC
Ground Lead (11 cm)	PP005-GL11
Ground Lead (22 cm)	PP005-GL22
Ground Lead (Spring)	PP005-GLPT
IC Insulating Tip	
Probe Tip to BNC Adapter	
Adjustment Screw Driver	

**PK106 – SMT Accessories for PP005/PP005A, PPEXkV**

Dual Lead Adapter	PK106-1
Single Lead Adapter	PK106-2
0.5 mm Clip (Orange)	PK106-3
Probe Tip to PCB Adapter	PK106-4
M/F Lead – Long (4")	PK106-5
M/F Lead – Short (2")	PK106-6
0.5 mm Clip (Yellow)	PK106-8

**PK101 – Microclip Accessory Kit for PP005/PP005A**

Single Lead Adapter	PK106-2
QFPIC Clip (0.5 mm Pitch)	PACC-CL001

**PK116 – Standard Probe Accessory Kit for PP006/PP006A**

Sprung Hook	PK116-1
Ground Lead	PK116-2
Ground Pin	PK116-3
Insulating Tip	
Screw Driver	

**PK006 – SMT Accessories for PP006/PP006A**

Dual Lead Adapter PK006	PK006-1
Single Lead Adapter PK006	PK006-2
0.5 mm Clip (Black and Red)	PK006-3
0.8 mm Clip (Black and Red)	PK006-4
M/F Lead – Long (4")	
M/F Lead – Short (2")	

**PASSIVE PROBES ACCESSORIES**

<b>ORDERING INFORMATION</b>	<b>PRODUCT CODE</b>
<b>PKIT1-5MM-102 – Basic Adapter Kit for PP009</b>	
Sprung Hook	PK1-5MM-101
Standard Ground Lead	PK1-5MM-102
Adjustment Tool	PK1-5MM-103
Rigid Tip, 0.8 mm	PK1-5MM-104
IC Cap, 2.54 mm pitch	PK1-5MM-108
Spring Tip 0.8 mm (Qty. 6)	PK1-5MM-109
BNC Adapter	PK1-5MM-110
Adapter, 4 mm plug	PK1-5MM-117
Ground Spring	PK1-5MM-118
High Frequency Compensated Ground Lead	PK1-5MM-123
Spring Tip 0.38 mm (Qty. 5)	PK1-5MM-124
<b>PKIT1-5MM-101 – Micro Clip Kit for PP009</b>	
Single Lead Adapter	PK1-5MM-111
Microclip Long, Green	PK1-5MM-114G
Microclip Long, Yellow	PK1-5MM-114Y
Microclip Short, Green	PK1-5MM-115G
Microclip Short, Yellow	PK1-5MM-115Y
<b>PKIT2-5MM-101 – Standard Accessory Kit for PP010</b>	
Sprung Hook	PK2-5MM-101
Standard Ground Lead	PK2-5MM-102
Adjustment Tool	
Ground Attachment	
IC Test Tip	
Color Coding Rings (set)	

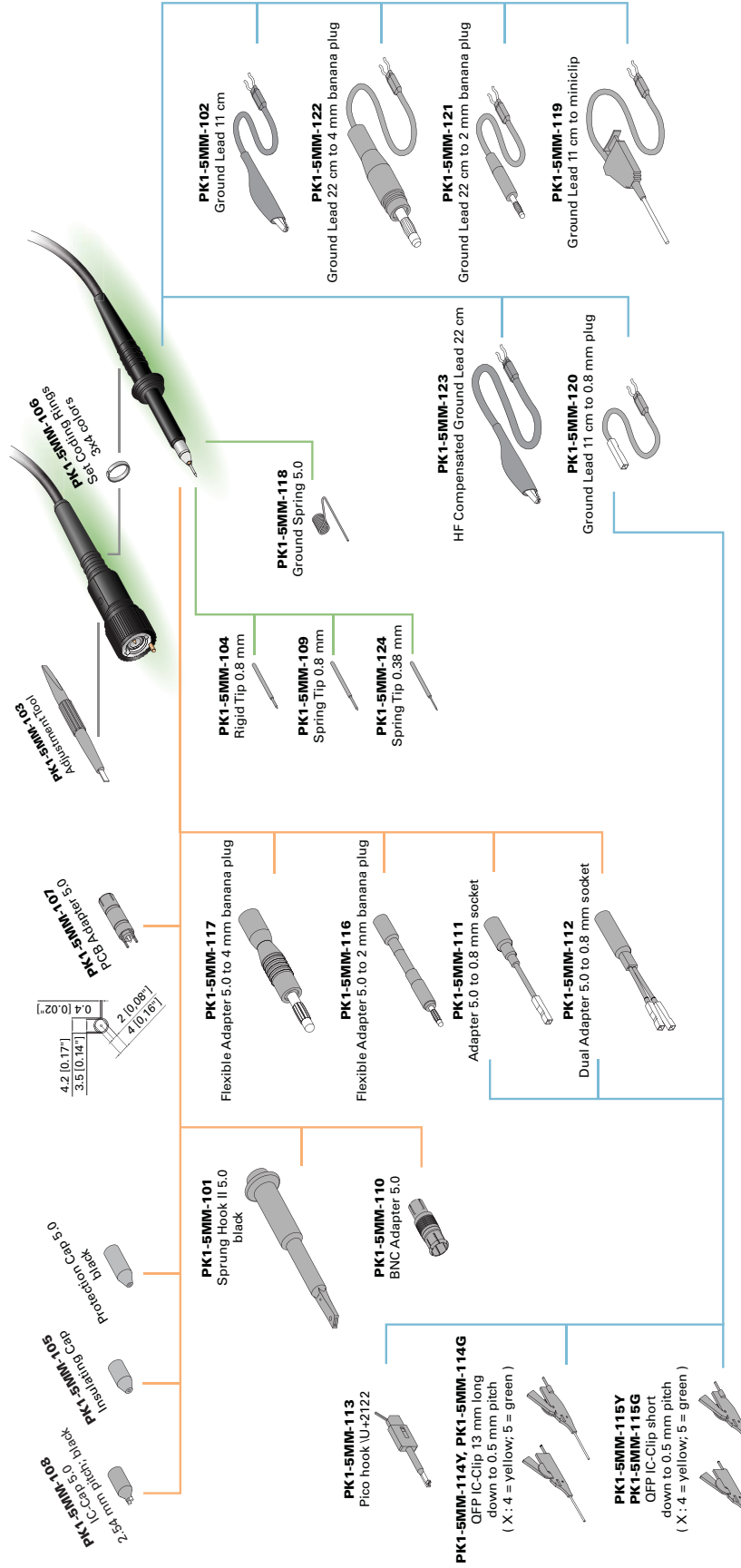

Passive Probe Accessories PP005, PP009, and PP011 Series





PP007-WR-1

PP007-WS-1

PP008-1

## PASSIVE PROBES

The PP007 and PP008 embody leading edge technology in passive probe design. A rugged, general-purpose probe, its small size is optimized for maximum waveform fidelity. The small 2.5 mm ground sleeve provides superior visibility, as well as a greater ability to probe dense circuits than traditional 3.5 mm and 5 mm probes. Its sharp probe tip\* is spring loaded, allowing it to retract into the narrow probe head. Low input capacitance and low inductance optimize functionality in high frequency applications. For best performance, the PP007-WR-1 version is designed to be used with the WaveRunner 6000A Series, while the PP007-WS-1 version is designed for the WaveSurfer 400 Series. The PP008-1 is designed for use with the WaveRunner Xi Series.

### Features:

- Compact probe head
- Fine pitch SMD probing support
- Rugged, sharp tip
- HF optimized connection accessories
- Over 30 accessories
- Low input capacitance

### SPECIFICATIONS

#### ELECTRICAL CHARACTERISTICS

Attenuation	÷ 10
Bandwidth	> 500 MHz
Input R	10 MΩ
Input C	9.5 pF
Max. Input Voltage	400 V CAT I (1250 V surge) 300 V CAT II

#### GENERAL CHARACTERISTICS

Ground Sleeve Diameter	2.5 mm
Input Pin Diameter	0.5 mm
Cable Length	1.3 m

### ORDERING INFORMATION

### PRODUCT CODE

Basic Adapter Kit	PK701
Advanced Adapter Kit	PK702
SMD Adapter Kit	PK703
Microclip Kit	PK704
÷10 HiZ 500 MHz Passive Probe for WaveRunner Xi Series Oscilloscopes	PP008-1
÷10 HiZ 500 MHz Passive Probe for WaveRunner 6000A Series Oscilloscopes	PP007-WR-1
÷10 HiZ 500 MHz Passive Probe for WaveSurfer 400 Series Oscilloscopes	PP007-WS-1
Instruction Manual	PP007-OM-E

\* A rigid tip is included

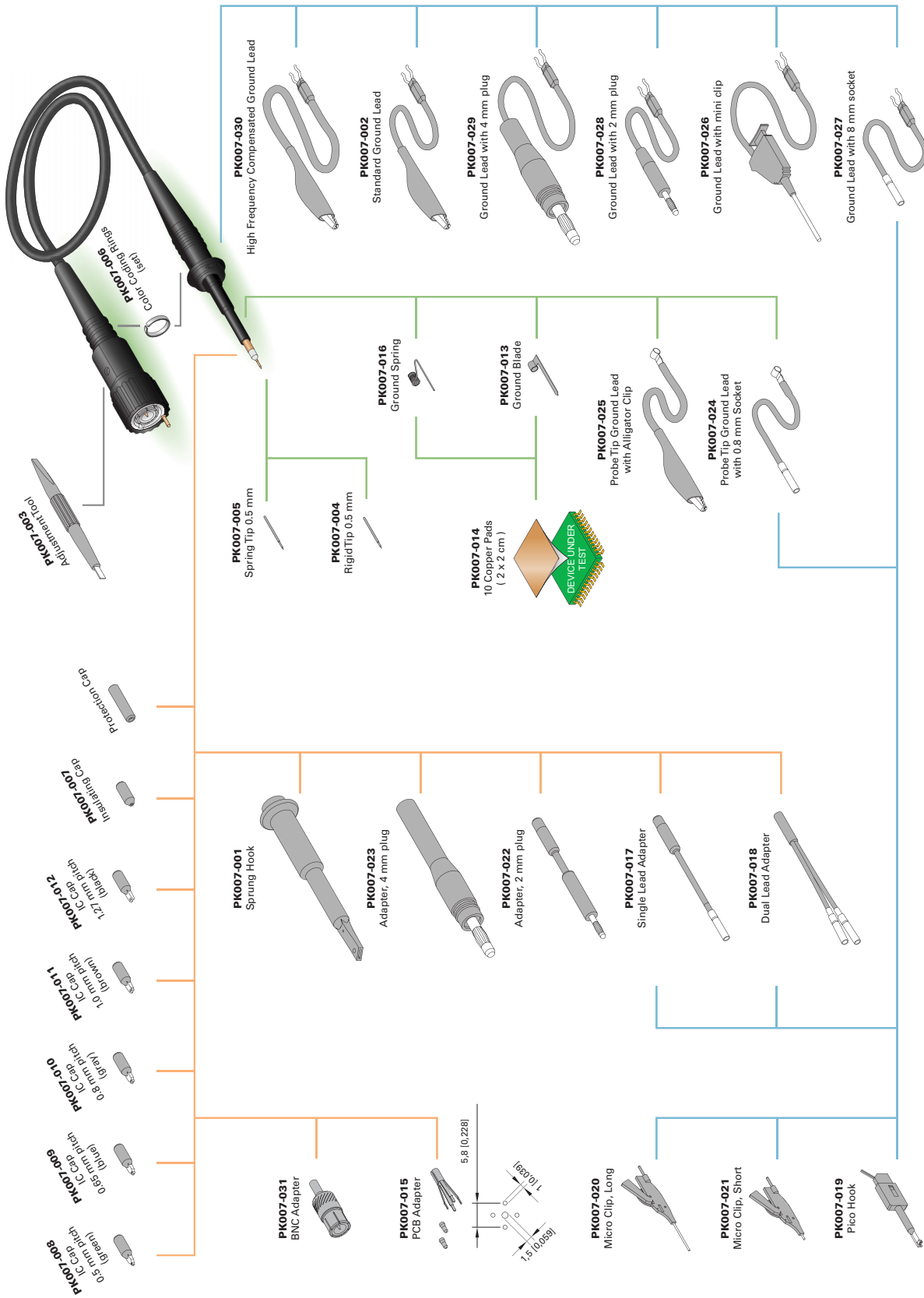

Passive Probe Accessories for PP007 and PP008 Series

**PASSIVE PROBE ACCESSORIES**

ORDERING INFORMATION PP007 AND PP008					PRODUCT CODE
PROBE ACCESSORIES	PK701	PK702	PK703	PK704	
Sprung Hook	2	1			PK007-001
Standard Ground Lead	2	1			PK007-002
Adjustment Tool	1	1			PK007-003
Rigid Tip	2	2			PK007-004
Spring Tip	2	1	2		PK007-005
Color Coding Rings (3 Red, 3 Yellow, 3 Blue, 3 Green)		2			PK007-006
Insulating Cap		2	2		PK007-007
IC-cap for 0.5 mm Pitch		1	2		PK007-008
IC-cap for 0.65 mm Pitch		1	2		PK007-009
IC-cap for 0.8 mm Pitch		1	2		PK007-010
IC-cap for 1.0 mm Pitch		1	2		PK007-011
IC-cap for 1.27 mm Pitch		1	2		PK007-012
Ground Blade		1	2		PK007-013
Copper Pad		1	2		PK007-014
PCB-adapter		5		1	PK007-015
Ground Spring	2	1	1		PK007-016
Single Adapter Lead			1	1	PK007-017
Dual Adapter Lead		1	1	1	PK007-018
Pico Hook		2			PK007-019
Microclip Long 0.5 mm		2	1	2	PK007-020
Microclip Short 0.5 mm		2	1	2	PK007-021
Adapter 2 mm Plug					PK007-022
Adapter 4 mm Plug					PK007-023
Probe Tip Ground Lead w/0.8 mm Socket		1	1		PK007-024
Probe Tip Ground Lead w/Alligator-clip					PK007-025
Ground Lead with Miniclip		1			PK007-026
Ground Lead with 0.8 mm Socket		1	1		PK007-027
Ground Lead with 2 mm Plug					PK007-028
Ground Lead with 4 mm Plug					PK007-029
HF-compensated Ground Lead		1	1		PK007-030
BNC-adapter		2			PK007-031
Product Description Brochure	1	1	1	1	PK007-032

## ACTIVE VOLTAGE PROBES

### ZS SERIES HIGH IMPEDANCE ACTIVE PROBES

The ZS Series probes provide high impedance and an extensive set of probe tips and ground accessories to handle a wide range of probing scenarios. The high 1 M $\Omega$  input resistance and low 0.9 pF input capacitance mean this probe is ideal for all frequencies. The ZS Series probes provide full system bandwidth for all LeCroy oscilloscopes having bandwidths of 1 GHz and lower.

### HIGH IMPEDANCE REDUCES CIRCUIT LOADING ACROSS FULL OSCILLOSCOPE BANDWIDTH

Engineers must commonly probe high frequency signals with high signal fidelity. Typical passive probes with high input R and C provide good response at lower frequencies, but inappropriately load the circuit, and distort signals, at higher frequencies. The ZS Series features both high input R (1 M $\Omega$ ) and low input C (0.9 pF) to reduce circuit loading across the entire probe/oscilloscope bandwidth. With low circuit loading, and a form factor that allows probing in confined areas, the ZS Series becomes the everyday probe for all different types of signals and connection points. The ZS1000 is ideal for 200–600 MHz oscilloscopes. The ZS1500 is ideal for 1 GHz oscilloscopes.



ZS1500

ZS1000

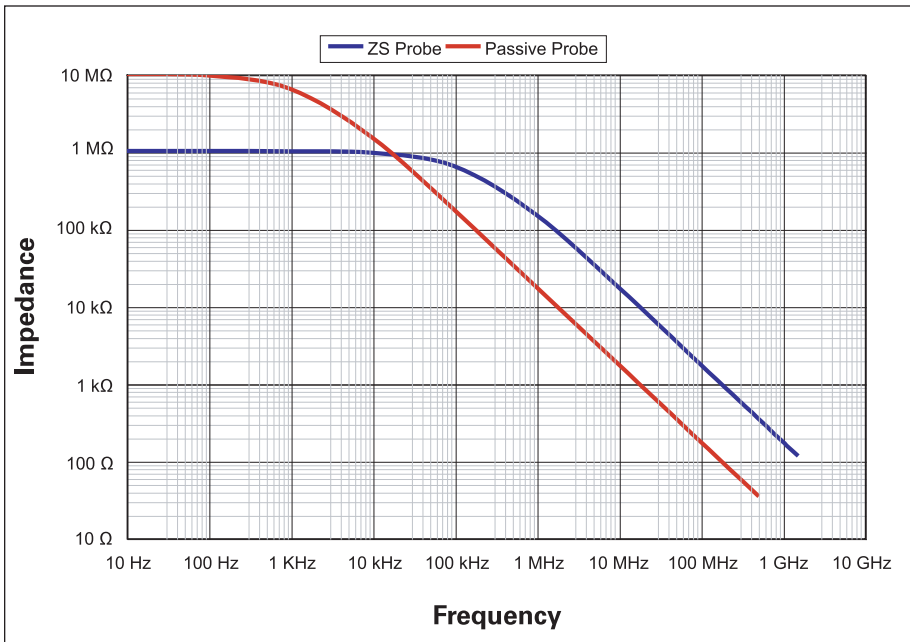

Passive probes are great for low frequency measurements; however, the input capacitance reduces impedance above 1 kHz. The 1 M $\Omega$  input resistance and 0.9 pF capacitance of the ZS probe provide high impedance across the entire probe bandwidth making it the ideal tool for all your probing needs.



## ACTIVE VOLTAGE PROBES

### A VARIETY OF PROBE TIPS FOR VARIED TASKS

Engineers often need to probe a variety of different test points in confined spaces. The extensive range of standard and optional tip accessories for the ZS Series of probes ensures that this probe can meet any difficult probing challenge. Various flexible leads and clips, such as right-angle leads, Y-adapters, and pico hooks, are also available for probing test points that are spaced farther apart.

### INNOVATIVE GROUNDING SOLUTIONS PROVIDE THE HIGHEST SIGNAL FIDELITY AND EASIEST CONNECTIONS

Making a good ground connection is just as important as keeping the ground loop short is critical to eliminating the effect of high inductance on the signal. The ZS Series of probes provides several grounding capabilities to offer the highest signal fidelity by shortening the ground loop and eliminating the effect of that loop on the signal. The standard Offset ground lead is a "twisted-Z" shape for probing signal and ground points that are extremely close together. The standard ground blade and copper pad provide the shortest ground loop possible, and provide a pulse response that cannot be achieved with traditional long ground leads. A variety of other ground connections are available for nearly any type of probing requirement.

SPECIFICATIONS	ZS1000	ZS1500
<b>ELECTRICAL CHARACTERISTICS</b>		
Bandwidth (probe only)	1 GHz	1.5 GHz
Bandwidth (system)	600 MHz at probe tip with 600 MHz oscilloscope	1 GHz at probe tip with 1 GHz oscilloscope
Input Capacitance	0.9 pF	0.9 pF
DC Input Resistance	1 M $\Omega$	1 M $\Omega$
Probe Offset Range	NA	$\pm 12$ V
Attenuation	$\div 10$	$\div 10$
Input Dynamic Range	$\pm 8$ V	$\pm 8$ V
Non-Destruct Voltage	20 V	20 V
<b>GENERAL CHARACTERISTICS</b>		
Cable Length	1.3 m	1.3 m
<b>INCLUDED WITH STANDARD CONFIGURATION</b>		
Instruction Manual, English		
Color Coding Clips (set of 4 colors)		
Certificate of Calibration		
1-Year Warranty		
Straight Probe Tip (PK-ZS-001)	4	4
Offset Ground (PK-ZS-002)	2	2
Short Lead (PK-ZS-003)	1	1
Long Lead (PK-ZS-004)	1	1
Y Lead Adapter (PK-ZS-005)	1	1
Right Angle Connector (PK-ZS-006)	1	1
Sprung Hook Red (PK-ZS-007R)	1	1
Sprung Hook Black (PK-ZS-007B)	1	1
Ground Blade (PK-ZS-008)	1	1
Copper Pad (PK-ZS-009)	2	2
Color Coding Rings (PK-ZS-010)	4 (sets)	4 (sets)

## ACTIVE VOLTAGE PROBES

EXTENSIVE SET OF PROBE TIPS AND GROUND LEADS FOR A WIDE RANGE OF PROBING SCENARIOS

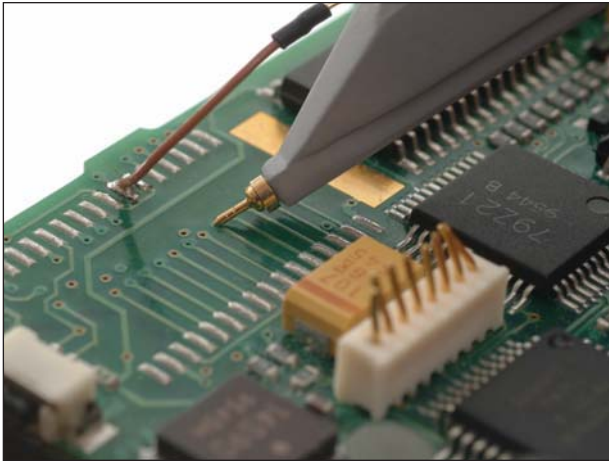

Use the Solder-In Ground with Straight Tip for general purpose browsing.

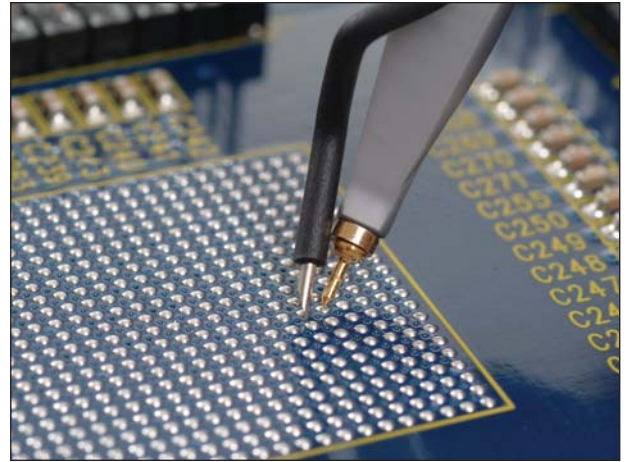

The Straight Tip and Offset Ground Lead can be used together for probing signal and ground points extremely close together.

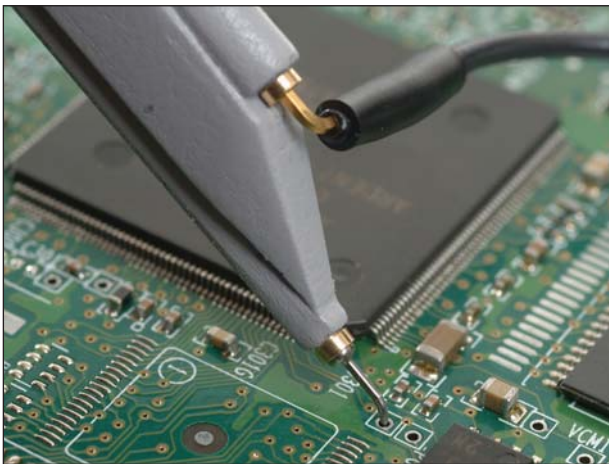

Hard-to-reach spaces can be probed with the Bent Sharp Tip and can be used with a range of ground leads like the flexible Short Right-angle Lead shown here.

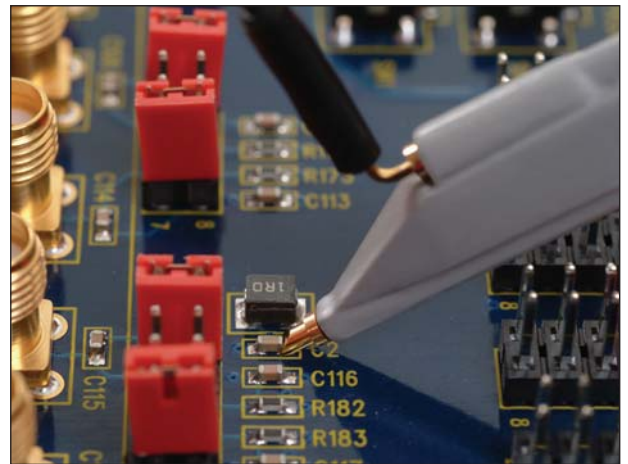

Probe directly on surface mount components, like resistors or capacitors, with the Discrete SMD Tip. Use this tip with any of the ground leads, like the flexible Long Right-angle Lead shown here.

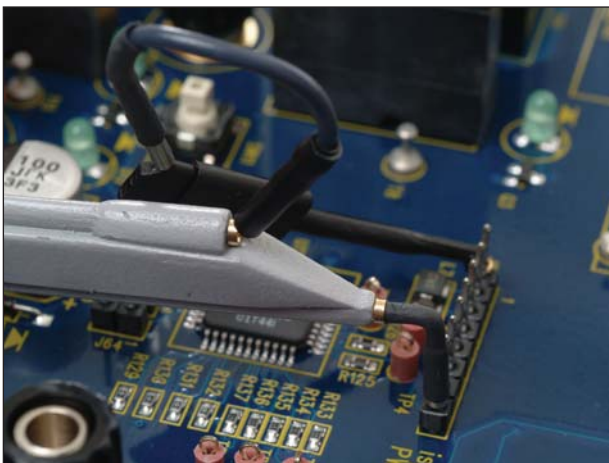

Use the Right-angle Connector and the Sprung Hook to probe square pins spaced far apart from each other.

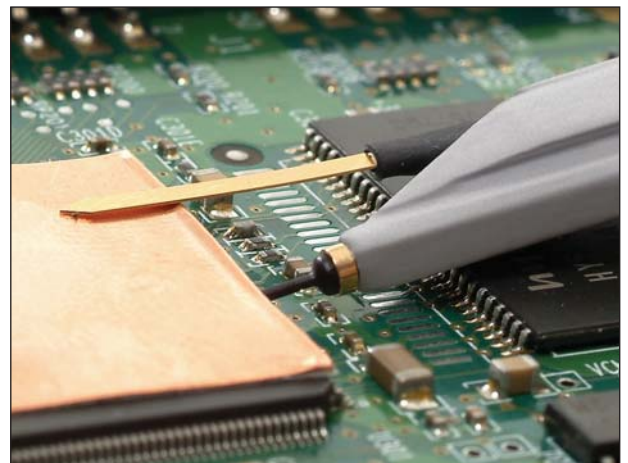

The Ground Blade and Copper Pad provide the shortest ground loop for excellent signal fidelity when probing an IC. Use them with the insulated IC Lead Tip to prevent shorting between test points.

## ACTIVE VOLTAGE PROBES

### ORDERING INFORMATION

	PRODUCT CODE
(Set of 4) ZS1500 Active Probes	ZS1500-QUADPAK
(Set of 4) ZS1000 Active Probes	ZS1000-QUADPAK
1.5 GHz, 1 M $\Omega$ , 0.9 pF Active Probe	ZS1500
1 GHz, 1 M $\Omega$ , 0.9 pF Active Probe	ZS1000

### REPLACEMENT ACCESSORIES

Replacement Accessory Kit for ZS Series Probes	PK-ZS
Straight Probe Tip	PK-ZS-001
Offset Ground	PK-ZS-002
Short Lead	PK-ZS-003
Long Lead	PK-ZS-004
Y Lead Adapter	PK-ZS-005
Right-Angle Connector	PK-ZS-006
Sprung Hook – Red	PK-ZS-007R
Sprung Hook – Black	PK-ZS-007B
Ground Blade	PK-ZS-008
Copper Pad	PK-ZS-009
Color Coding Rings	PK-ZS-010

### AVAILABLE ACCESSORIES

IC Lead Tip	PACC-PT003
Discrete SMD Tip	PACC-PT004
Bent Sharp Tip	PACC-PT005
Solder-In Ground	PACC-CD007
Bendable Pogo Ground	PACC-CD008
Ground Spring Hook	PACC-LD001
Square Pin Ground Spring	PACC-LD002
Short Right-angle Lead	PACC-LD003
Long Right-angle Lead	PACC-LD004

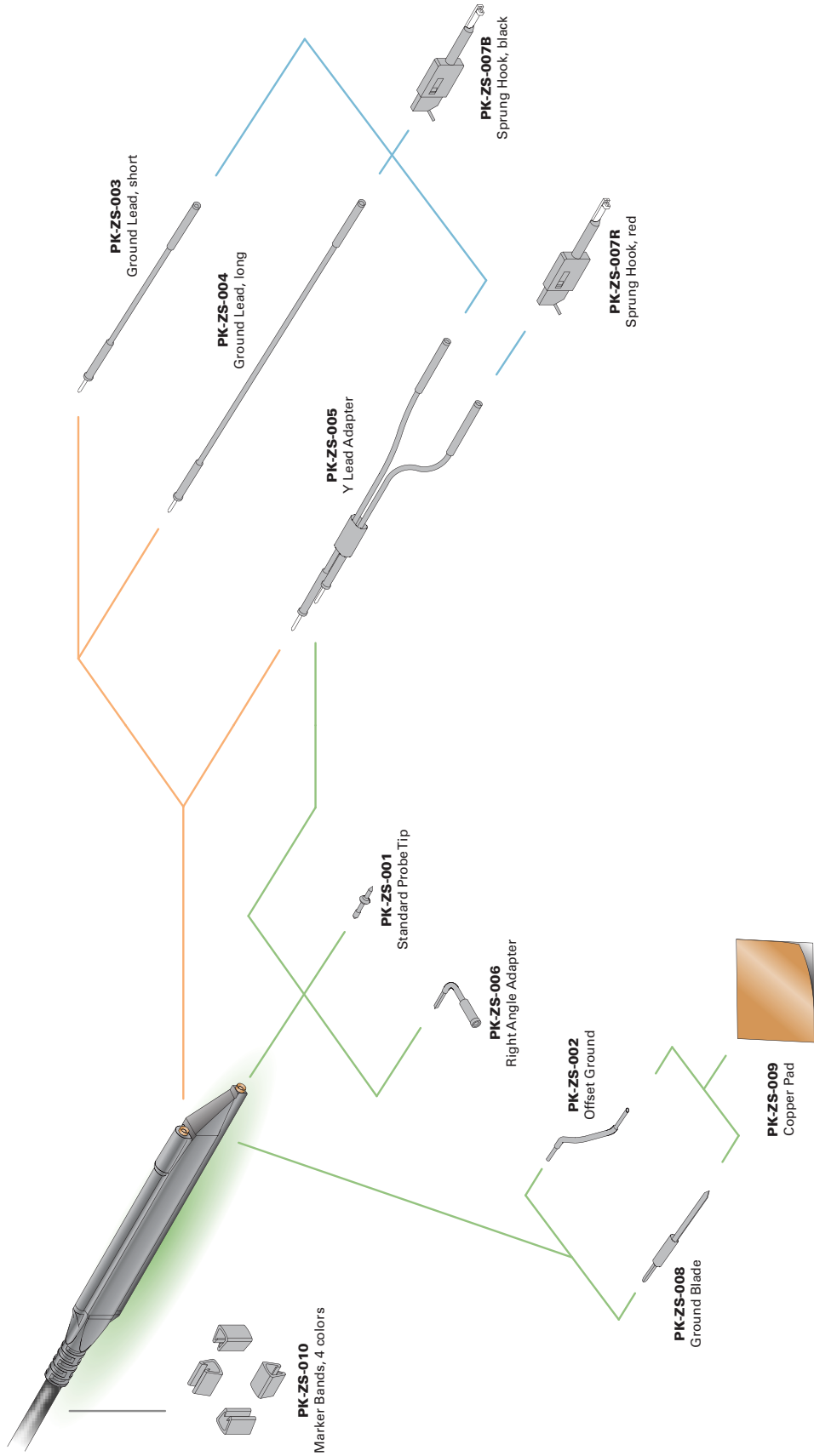

Accessories for ZS Series High Impedance Active Probes



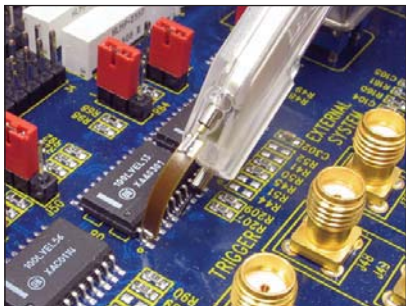

HFP2500

HFP1500

HFP1000

## ACTIVE VOLTAGE PROBES

### HFP ACTIVE PROBES

LeCroy's series of HFP active probes are versatile, small and lightweight, yet still maintain the high bandwidth needed for accurate measurement. Five interchangeable tips facilitate access regardless of tight fits and difficult locations. The FreeHand probe holder brings added versatility, allowing several probes to be used at the same time on a variety of test points while maintaining the short paths needed to preserve signal fidelity. The HFP probes also offer AutoColor ID, which automatically illuminates the probe head in a connected oscilloscope's trace color. This unique capability eliminates the need to manually apply plastic rings or colored tape to determine which channel the probe is connected to.

#### Features:

- 1 GHz to 3.5 GHz bandwidth
- 0.7 pF input capacitance
- $\pm 8$  V dynamic range
- $\pm 12$  V offset range (except HFP1000)
- 5 interchangeable tips for probing a variety of test points
- Replaceable probe tip socket
- Hands-free probing with FreeHand probe holder
- AutoColor ID feature matches the channel trace color

### SPECIFICATIONS

#### ELECTRICAL CHARACTERISTICS

##### BANDWIDTH (PROBE ONLY)

HFP1000	1 GHz
HFP1500	1.5 GHz
HFP2500	2.5 GHz
Input Capacitance	0.7 pF at 1 GHz
DC Input Resistance	100 k $\Omega$
Input Dynamic Range	$\pm 8$ V
Probe Offset Range	N/A (HFP1000) $\pm 12$ V (HFP1500, HFP2500)
Attenuation	$\div 10$
Attenuation Accuracy	$\pm 1\%$
Output Zero	< 4 mV, referred to input
Offset Accuracy (n/a for HFP1000)	$\pm (1\%$ of offset value +4 mV)

#### GENERAL CHARACTERISTICS

Cable Length	1.3 m
Probe Head Size (LWH)	61 mm x 7.3 mm x 13.1 mm
Input Sockets	Signal and ground sockets compatible with 0.635 mm (0.025") square pins, 0.91 mm (0.036") maximum diameter (for round pins)

#### INCLUDED WITH STANDARD CONFIGURATION

Instruction Manual, English  
Certificate of Calibration  
1-year Warranty

## ACTIVE VOLTAGE PROBES ACCESS.

### INCLUDED WITH STANDARD CONFIGURATION

	HFP1000	HFP1500	HFP25000
Straight Tip	4	4	4
Sharp Tip	4	4	4
Bent Tip		4	4
Discrete SMD Tip		4	4
IC Lead Tip		4	4
Square Pin Ground Spring	1	1	1
Flexible IC Ground	1	1	1
Bendable Pogo Ground	1	1	2
Solder-In Ground	1	1	2
Short Single Lead		1	1
Long Single Lead		1	
Right-angle Short Single Lead	1	2	1
Right-angle Long Single Lead	1	2	1
Clips (0.8 mm)	2	2	2
FreeHand Probe Holder		1	1
Replaceable Cartridge	1	1	1
Microclips (0.5 mm)			2
Low C Tip Cartridge			1
Soft Accessory Case		1	1

### ORDERING INFORMATION

### PRODUCT CODE

1 GHz, 0.7 pF Active Probe ( $\pm 10$ ), Small Form Factor	HFP1000
1.5 GHz, 0.7 pF Active Probe ( $\pm 10$ ), Small Form Factor	HFP1500
2.5 GHz, 0.7 pF Active Probe ( $\pm 10$ ), Small Form Factor	HFP2500
Standard Accessory Kit for HFP2500	PK108
Standard Accessory Kit for HFP1500	PK109
Standard Accessory Kit for HFP1000	PK110
Soft Accessory Case	SAC-01
Straight Tip	PACC-PT001
Sharp Tip	PACC-PT002
IC Lead Tip	PACC-PT003
SMD Discrete Tip	PACC-PT004
Bent Sharp Tip	PACC-PT005
Freehand Probe Holder	PACC-MS001
Replaceable Cartridge	PACC-MS002
Low C Cartridge	PACC-MS003
Solder-In Ground	PACC-CD007
Bendable Pogo Ground	PACC-CD008
Flexible IC Ground	PACC-CD009
Ground Spring Hook	PACC-LD001
Square Pin Ground Spring	PACC-LD002
Short Right-angle Lead	PACC-LD003
Long Right-angle Lead	PACC-LD004
Short Single Lead	PACC-LD005
Long Single Lead	PACC-LD006
0.8 mm Clips	PK006-4
Microclip	PACC-CL001
HFP1000 Instruction Manual, English	HFP1000-OM-E
HFP1500 Instruction Manual, English	HFP1500-OM-E
HFP2500 Instruction Manual, English	HFP2500-OM-E



PPO66

## HIGH-BANDWIDTH TRANSMISSION LINE

The PP066 is a high-bandwidth passive probe designed for use with the WaveMaster and other high-bandwidth oscilloscopes with 50 Ω input termination. This very low capacitance probe provides an excellent solution for higher frequency applications, especially the probing of transmission lines with 20–100 Ω impedance. The PP066 accommodates a wide range of applications, including probing of analog and digital ICs commonly found in computer, communications, data storage, and other high-speed designs.

### Features:

- Interchangeable attenuator tips
- Signal integrity at high bandwidth
- Standard SMA cable connection
- Ultra low capacitance

### SPECIFICATIONS

#### ELECTRICAL CHARACTERISTICS

Bandwidth	DC to 7.5 GHz
Risetime	< 47 ps
Input C	< 0.20 pF
Input R	500 Ω (÷10 cartridge) 1000 Ω (÷20 cartridge)
Maximum Voltage	15 V rms
Cable Length	1 m



PPO65

The PP065 is a transmission line probe designed for use at very high frequencies. The probe's input impedance remains nearly constant over its entire frequency range. Robust to over voltage and ESD exposure, it is particularly useful in applications producing fast rising, narrow pulses with amplitudes, which exceed the dynamic range of active probes.

### Features:

- 1 GHz
- Low capacitance
- ÷100 1 GHz 5 k passive probe

### SPECIFICATIONS

Input R Ohm	500 Ω
Maximum Voltage	22 V
Compatibility	LCXXX, 93XX, LA314, LA354, WaveRunner, and WavePro Scopes
Bandwidth	1 GHz
Attenuation	100:1
Input Capacitance	1.5 pF

### ORDERING INFORMATION

### PRODUCT CODE

7.5 GHz Low Capacitance Passive Probe (÷10, 1 kΩ; ÷20, 500 Ω)	PP066
1 GHz Low Capacitance Passive Probe (÷10, 5 kΩ)	PP065

### INCLUDED WITH PP066 PROBE

PACC-AD001	SMA to BNC Adapter
------------	--------------------

## DIFFERENTIAL PROBES

High bandwidth, excellent common-mode rejection ratio (CMRR) and low noise make these active differential probes ideal for applications such as disk drive design and failure analysis, as well as wireless and data communication design. With the ProBus interface, the AP034 and AP033 become an integral part of the oscilloscope, allowing sensitivity, offset and common-mode range to be displayed on the scope screen. Common mode sensing and input protection capabilities of the AP033 add additional functionality.



AP034

AP033

### Features for both probes:

- 500 MHz (**AP033**) and 1 GHz (**AP034**) bandwidths
- x10 gain to ÷ 10 attenuation range (**AP033**)
- 10,000:1 DC CMRR
- Low 9 nV/√Hz noise (**AP033**)
- 1.5 pF/side input C (**AP034**)
- 200 μV/div (**AP033**)
- Input ESD protection
- Autozero feature

### SPECIFICATIONS

	AP034	AP033
Bandwidth	1 GHz	500 MHz
Gain	x1 (÷10 and ÷20 with plug-on attenuators)	x10, x1, ÷10 (÷100 with plug-on ÷10 attenuator)
DC Accuracy	2% typical (probe only)	1% in x1 without external attenuator
Input Resistance	1 MΩ    1.5 pF each input to ground 2 MΩ    0.85 pF between inputs	1 MΩ each input to ground 2 MΩ differential between inputs
Differential Mode Range	±400 mV (x1) ±4 V (÷10) ±8 V (÷20)	±400 mV (x1) ±40 mV (x10) ±4 V (÷10) ±40 V (÷100)
Offset Range	±1.6 V (x1) ±16 V (±10) ±32 V (±20)	±400 mV (x1, x10) ±4 V (±10) ±40 V (±100)
Common-Mode Range	±16 V (x1) ±42 V (±10) +42 V (±20)	±42 V peak (±10) +4.2 V peak (±100)
CMRR	70 Hz 10,000:1 (80 dB) 1 MHz 100:1 (40 dB) 100 MHz 18.1 (25 dB) 500 MHz 9:1 (19 dB)	70 Hz 10,000:1 (80 dB) 100 kHz 10,000:1 (80 dB) 1 MHz 1000:1 (60 dB) 10 MHz 100:1 (40 dB) 250 MHz 5:1 (14 dB)



## DIFFERENTIAL PROBES

### SPECIFICATIONS (CONTINUED)

	<b>AP034/AP033</b>
Max. Nondestruct Voltage	±200 VDC continuous
Cable Length	1.2 m
Operating Temperature	0 °C to 50 °C
Standard Accessories	÷10 Plug-on Attenuator ÷20 Plug-on Attenuator ( <b>AP034 only</b> ) Plug-on AC Coupler
Probe Connection Accessory Kit	Flex Lead Set (1) Input 'Y' Lead (1) Mini Clip, 0.8 mm (3) Mini Clip, 0.5 mm (2) Ground Lead (1) Offset Pins, Round (4) Square Pin Header Strip (1)
Warranty	1 year
<b>PK033 – Standard Probe Accessory Kit for AP033/AP034</b>	
Dual Lead	AP03X-FLEX-LEAD
Single Lead	NA
Offset Pin (package of 10)	AP03X-OFFSET-PIN
0.5 mm Clip (red and black)	PK006-3
0.8 mm Clip (red and black)	PK006-4
1x6 Square Pin Header	NA
<b>Other Accessories for AP033/AP034</b>	
AC Coupler	AP03X-AC-COUPLER
÷10 Attenuator for AP033	AP033-ATTN
÷10 Attenuator for AP034	AP034-DA10
÷20 Attenuator for AP034	AP034-DA20

### ORDERING INFORMATION

### PRODUCT CODE

1 GHz Active Differential Probe (÷1, ÷10, ÷20)	AP034
500 MHz Active Differential Probe (x10, ÷1, ÷10 or ÷100)	AP033

## HIGH VOLTAGE PASSIVE PROBES

The PPE series includes five fixed-attenuation probes covering a range from 2 kV to 20 kV, and one switchable probe providing  $\div 10/\div 100$  attenuation for voltage inputs up to 1.2 kV. All fixed-attenuation, standard probes automatically rescale compatible LeCroy oscilloscopes for the appropriate attenuation of the probe.

### Features:

- Safe, accurate high-voltage measurement
- 1.2 kV to 20 kV

### HIGH-VOLTAGE PROBES SELECTION GUIDE SPECIFICATIONS

Types	Bandwidth (MHz)	Input R ( $\Omega$ )	Input C (pF)	Attenuation	Maximum Voltage	Probe Encoding	Cable
PPE1.2kV*	400	50 M	< 6	$\div 10 / \div 100$	600 V/1.2 kV	No	2 m
PPE2kV*	400	50 M	< 6	$\div 100$	2 kV	Yes	2 m
PPE4kV*	400	50 M	< 6	$\div 100$	4 kV	Yes	2 m
PPE5kV*	400	50 M	< 6	$\div 100$	5 kV	Yes	2 m
PPE6kV*	400	50 M	< 6	$\div 1000$	6 kV	Yes	2 m
PPE20kV†	100	50 M	< 2	$\div 1000$	20 kV (40 kV peak)	Yes	3 m



PPE1.2KV

PPE2KV

PPE4KV

PPE5KV

PPE6KV

PPE20KV

### ORDERING INFORMATION

### PRODUCT CODE

$\div 10/\div 100$ ; 200/300 MHz; 5 M $\Omega$ /50 M $\Omega$ High-Voltage Probe 600 V/1.2 kV max. Voltage DC	PPE1.2KV
$\div 1000$ ; 100 MHz; 50 M $\Omega$ High-Voltage Probe 20 kV (40 kV Peak) max. Voltage DC and Peak AC	PPE20KV
$\div 100$ ; 400 MHz; 50 M $\Omega$ High-Voltage Probe 2 kV max. Voltage DC and Peak AC	PPE2KV
$\div 100$ ; 400 MHz; 50 M $\Omega$ High-Voltage Probe 4 kV max. Voltage DC and Peak AC	PPE4KV
$\div 100$ ; 400 MHz; 50 M $\Omega$ High-Voltage Probe 5 kV max. Voltage DC and Peak AC	PPE5KV
$\div 1000$ ; 400 MHz; 50 M $\Omega$ High-Voltage Probe 6 kV max. Voltage DC and Peak AC	PPE6KV
Accessory Kit for PPE1.2kV, 2kV, 4kV, 5kV, and 6kV	PK103
Standard Probe Accessory Kit for PPE20kV	PK104
Ground Lead (15 cm)	PK104-1
Hook	PK104-2
Standard Probe Accessory Kit for PPE1.2kV, PPE2kV	PK103
Sprung Hook (red)	PK103-1
Ground Lead (22 cm)	PP005-G22
Crocodile Clip	PK30x-2
Probe Tip to BNC Adapter	PP005-BNC
IC Insulating Tip	
Screw Driver	
Probe Tip to Banana Plug Adapter	
Ground Lead with Banana Plug	
Spring Tip (0.8 mm)	PP005-ST8
Rigid Tip V2A	PP005-RT

### STANDARD ACCESSORY KIT FOR PPE20KV

Ground Lead (15 cm)	PK104-1
Hook	PK104-2

Supplied with probe:

\* Probe Kit: Trimming tool, ground lead, rigid tip, IC insulator, BNC adapter, tip insulator, sprung hook, red crocodile clip.  
4mm safety ground lead, and green/yellow crocodile clip.

† Probe Kit: trimming tool, and ground lead with a crocodile clip.



APO31

## HIGH VOLTAGE DIFFERENTIAL PROBES

The AP031 is a low cost, battery operated active differential probe intended for measuring higher voltages. The differential techniques employed permit measurements to be taken at two points in a circuit without reference to the ground, allowing the oscilloscope to be safely grounded without the use of opto-isolators or isolating transformers.

### Features:

- Safe floating measurements
- 15 MHz bandwidth
- 700 V maximum input voltage
- Works with any 1 M $\Omega$  input oscilloscope

### SPECIFICATIONS

Attenuation	$\div 10 / \div 100$
Bandwidth	15 MHz
Input R	4 M $\Omega$
Differential Mode Range	$\pm 70 \text{ V} / \pm 700 \text{ V DC} + \text{Peak AC}$
Common Mode Range	$\pm 700 \text{ V DC} + \text{Peak AC}$
CMRR	86 dB @ 50 Hz
Power Source (four AA batteries)	56 dB @ 200 kHz



ADP305

ADP300

### ORDERING INFORMATION

### PRODUCT CODE

700 V, 15 MHz Differential Probe ( $\div 10, \div 100$ )

AP031

ADP30X high-voltage active probes are safe, easy-to-use, and ideally suited for measuring power electronics. The ADP300 is designed for troubleshooting low-frequency power devices and other circuits where the reference potential is elevated from the ground or the location of the ground is unknown. The ADP305 is designed for measuring the high-speed floating voltages found in today's power electronics.

### Features:

- 20 MHz and 100 MHz bandwidth
- 1,000 V rms common mode voltage
- 1,400 V peak differential voltage
- EN 61010 CAT III
- 80 dB CMRR at 50/60 Hz
- ProBus system
- Full remote control

## HIGH VOLTAGE DIFFERENTIAL PROBES

### SPECIFICATIONS

#### ELECTRICAL CHARACTERISTICS

Bandwidth	20 MHz <b>(ADP300)</b>	
	100 MHz <b>(ADP305)</b>	
Differential Voltage	1,400 V peak	
Common Mode Voltage	1,000 V rms CAT III	
Low-Frequency Accuracy (probe only)	1% of Reading	
CMRR	50/60 Hz	80 dB (10,000:1)
	100 kHz	50 dB (300:1)
Max. Slew Rate (referenced to input)	60,000 V/μs <b>(ADP300)</b>	
	300,000 V/μs <b>(ADP305)</b>	
AC Noise (referenced to input)	50 mV rms	
Attenuation	÷100/÷1000 (automatically selected by scope)	
Input Impedance	Between inputs	8 MΩ, 6 pF
	Each input to ground	4 MΩ, 1 pF
Sensitivity	1 V/div to 350 V/div <b>(ADP300)</b>	
	200 mV/div to 350 V/div <b>(ADP305)</b>	
Interface	ProBus, 1 MΩ*	

#### GENERAL CHARACTERISTICS

Overall Length	2 m
Input Connectors	4 mm Shrouded Banana Plug
Operating Temperature	0 °C to 50 °C
Warranty	1 year

#### STANDARD ACCESSORIES

##### ADP305

##### All ADP300 Accessories

Safety Spade (1 Red, 1 Blue)  
 Plunger Clamp Clip (1 Red, 1 Blue)  
 Plunger Jaw Clip (1 Red, 1 Blue)  
 Safe Alligator Clip (1 Red, 1 Blue)  
 Soft Accessory Case

##### ADP300

Instruction Manual  
 Certification of Calibration  
 Plunger Hook Clip (1 Red, 1 Blue)  
 Straps for Holding Probe

\*Requires AP-1M for oscilloscopes with 50 Ω only inputs

#### ORDERING INFORMATION

#### PRODUCT CODE

1,400 V, 100 MHz High-Voltage Differential Probe

ADP305

1,400 V, 20 MHz High-Voltage Differential Probe

ADP300



## CURRENT PROBES

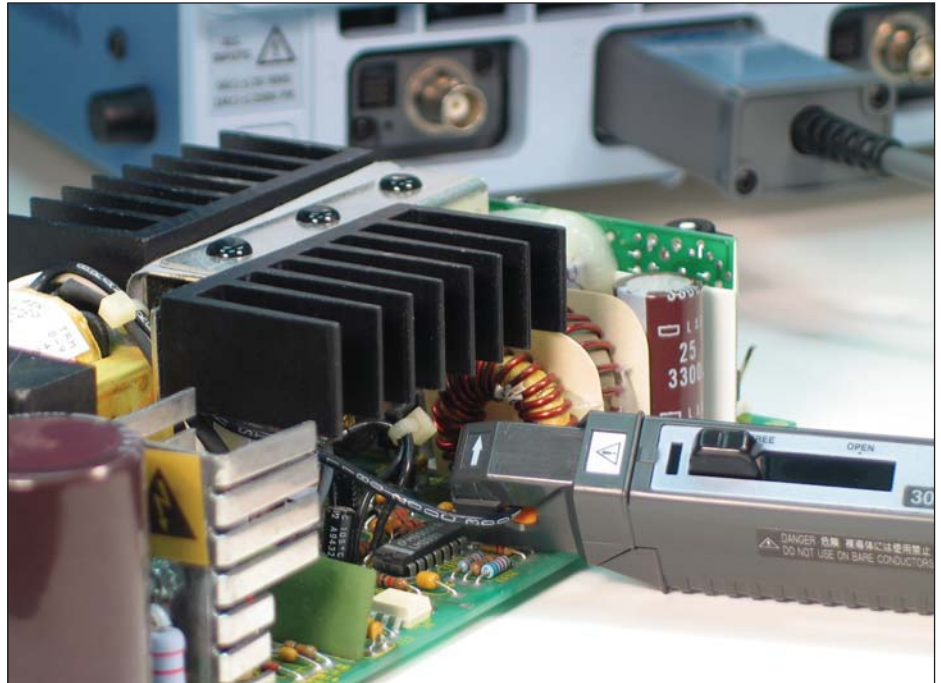

Accurately measure AC, DC, and impulse currents.

### MEASURE CURRENTS IN A WIDE RANGE OF APPLICATIONS

#### Measuring AC and DC Currents

LeCroy current probes do not require the breaking of a circuit or the insertion of a shunt to make accurate and reliable current measurements. Based on a combination of Hall effect and transformer technology, LeCroy current probes are ideal for making accurate AC, DC, and impulse current measurements.

#### Fully Integrated with Oscilloscope

Many current probes require external power supplies or amplifiers to display a waveform on the oscilloscope screen. All LeCroy current probes are powered through the LeCroy ProBus connection and require no additional hardware. Along with providing power, the ProBus connection allows the current probe and oscilloscope to communicate, resulting in current waveforms automatically displayed on screen in Amps, and calculated power traces scaled correctly in Watts. This full integration also allows for Degauss and Autozero functions to be done directly from the oscilloscope with a single button press.

#### Applications

LeCroy current probes are available in a wide range of models for a wide range of applications. The full range of LeCroy current probes includes models with bandwidths up to 100 MHz, peak currents up to 700 A and sensitivities to 10 mA/div. Multiple current probes can be used together to make measurements on three-phase systems, or a single current probe can be used with a voltage probe to make accurate instantaneous power measurements. LeCroy current probes are often used in applications such as the design and test of switching power supplies, motor drives, electric vehicles, and uninterruptible power supplies.

## CURRENT PROBES

### CP031 – 30A, 100 MHz

The CP031 is LeCroy's highest bandwidth current probe. Along with the high 100 MHz bandwidth the CP031 can probe continuous currents of 30 A<sub>rms</sub> and peak currents up to 50 A. The CP031 features a small form factor making it easier to probe on a crowded, compact board.

**Features:**

- 100 MHz bandwidth
- Small form factor accommodates large conductors with small jaw size
- 30 A<sub>rms</sub> continuous current, 50 A<sub>peak</sub> current



CP031

### CP030 – 30 A, 50 MHz

The CP030 was designed with a small form factor for today's crowded boards. The small jaw can probe currents in tight spaces and still clamp onto conductors up to 5 mm in diameter. Continuous currents of 30 A<sub>rms</sub> and peak currents of 50 A can be measured by the CP030, which also features a 50 MHz bandwidth.

**Features:**

- Small form factor accommodates large conductors with small jaw size
- 30 A<sub>rms</sub> continuous current, 50 MHz bandwidth
- 50 A<sub>peak</sub> current



CP030

### AP015 – 30 A, 50 MHz

The AP015 current probe can measure continuous current of 30 A<sub>rms</sub> and peak pulses of up to 50 A for durations up to 10 seconds. This probe also features an overheating protection circuit, which will display an on-screen warning to the user to prevent damage. A probe unlock detection feature is also built in to the AP015 to ensure accurate measurements.

**Features:**

- 30 A<sub>rms</sub> continuous current, 50 MHz bandwidth
- 50 A<sub>peak</sub> current for up to 10 seconds
- Overheating and Probe Unlock Detection



AP015

### CP150 – 150 A, 10 MHz

**Features:**

- 150 A<sub>rms</sub> continuous current
- 500 A<sub>peak</sub>
- 10 MHz bandwidth



CP150

### CP500 – 500 A, 2 MHz

**Features:**

- 500 A<sub>rms</sub> continuous current
- 700 A<sub>peak</sub>
- 2 MHz bandwidth



CP500

CURRENT PROBES

SPECIFICATIONS

ELECTRICAL CHARACTERISTICS

	CP031*†	CP030*†
Max. Continuous Input Current	30 A	30 A
Bandwidth	100 MHz	50 MHz
Max. Peak Current at Pulse Width	50 A ≤ 10 μs	50 A ≤ 10 μs
Rise Time (typical)	≤ 3.5 ns	≤ 7 ns
Minimum Sensitivity	20 mA/div	20 mA/div
Max. In-Phase Current	–	–
Low-Frequency Accuracy	1%	1%
AC Noise	≤ 2.5 mA	≤ 2.5 mA
Coupling	AC, DC, GND	AC, DC, GND

GENERAL CHARACTERISTICS

	CP031*†	CP030*†
Cable Length	1.5 m	1.5 m
Weight	240 g	240 g
Max. Conductor Size (diameter)	5 mm	5 mm
Interface	ProBus, 1 MΩ only‡	ProBus, 1 MΩ only‡
Usage Environment	Indoor	Indoor
Operating Temperature	0 °C to 40 °C	0 °C to 40 °C
Max. Relative Humidity	80%	80%
Max. Altitude	2000 m	2000 m
Maximum Insulated Wire Voltage	300 V CAT I, 150 V CAT II	300 V CAT I

\* Guaranteed at 23 °C ±3 °C

† The CP031 and CP030 are compatible with LeCroy X-Stream oscilloscopes running firmware version 4.3.1.1 or greater.

‡ Requires AP-1M for use with 50 Ω input only oscilloscopes.

ORDERING INFORMATION

PRODUCT CODE

30 A; 100 MHz Current Probe – AC/DC; 30 A <sub>rms</sub> ; 50 A <sub>peak</sub> Pulse	CP031
30 A; 50 MHz Current Probe – AC/DC; 30 A <sub>rms</sub> ; 50 A <sub>peak</sub> Pulse	CP030
30 A; 50 MHz Current Probe – AC/DC; 30 A <sub>rms</sub> ; 50 A <sub>peak</sub> Pulse	AP015
150 A; 10 MHz Current Probe – AC/DC; 150 A <sub>rms</sub> ; 500 A <sub>peak</sub> Pulse	CP150
500 A; 2 MHz Current Probe – AC/DC; 500 A <sub>rms</sub> ; 700 A <sub>peak</sub> Pulse	CP500

CP031 – 30 A, 100 MHz

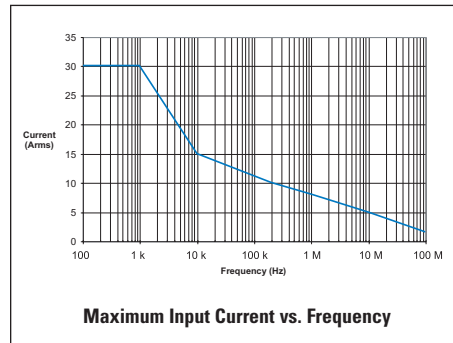

CP030 – 30 A, 50 MHz

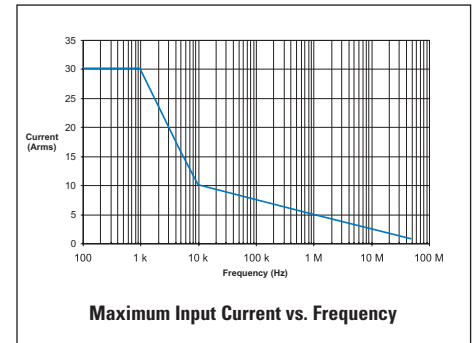

CP031 – 30 A, 100 MHz

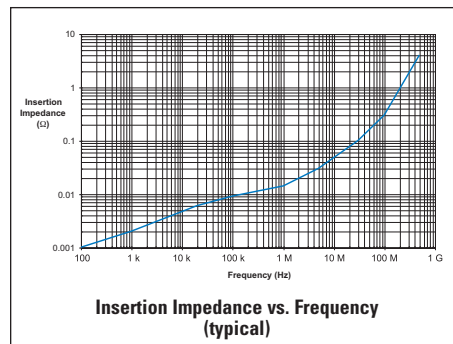

CP030 – 30 A, 50 MHz

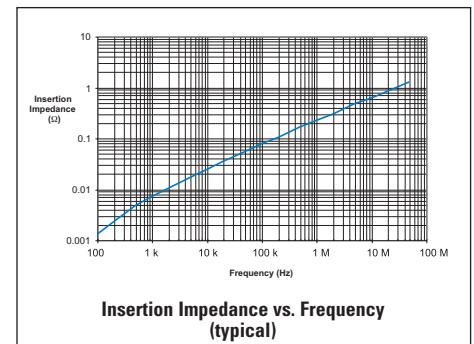

## CURRENT PROBES

AP015	CP150	CP500
30 A	150 A	500 A
50 MHz	10 MHz	2 MHz
50 A ≤ 10 s	500 A ≤ 30 μs	700 A
≤ 7 ns	< 35 ns	< 175 ns
10 mA/div	200 mA/div	200 mA/div
–	500 A	1150 A
1%	1%	1%
	≤ 25 mA	25 mA
AC, DC, GND	AC, DC, GND	AC, DC, GND
2 m	2 m	6 m
300 g	500 g	630 g
5 mm	20 mm	20 mm
ProBus, 1 MΩ only†	ProBus, 1 MΩ only†	ProBus, 1 MΩ only†
Indoor	Indoor	Indoor
0 °C to 40 °C	0 °C to 40 °C	0 °C to 40 °C
80%	80%	80%
2000 m	2000 m	2000 m
300 V CAT I	600 V CAT II, 300 V CAT III	600 V CAT II, 300 V CAT III

\* Guaranteed at 23 °C ±3 °C

† The CP031 and CP030 are compatible with LeCroy X-Stream oscilloscopes running firmware version 4.3.1.1 or greater.

‡ Requires AP-1M for use with 50 Ω input only oscilloscopes.

CP150 – 150 A, 10 MHz

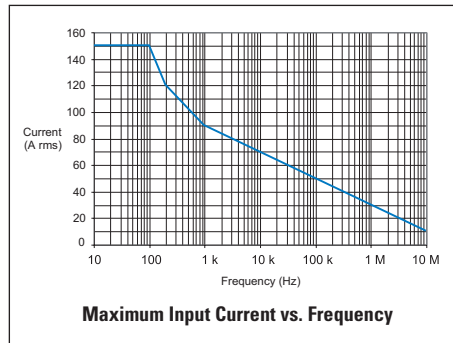

CP500 – 500 A, 2 MHz

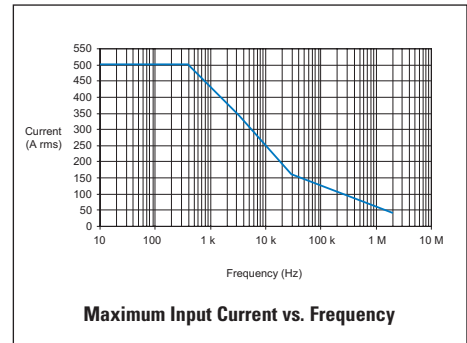

AP015 – 30 A, 50 MHz

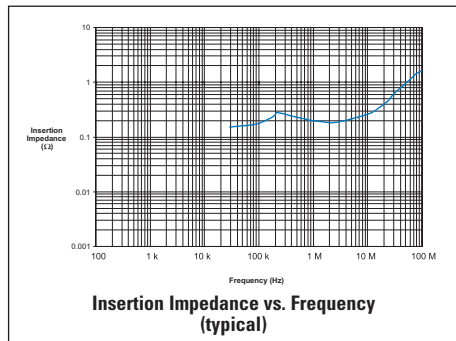

CP150 – 150 A, 10 MHz

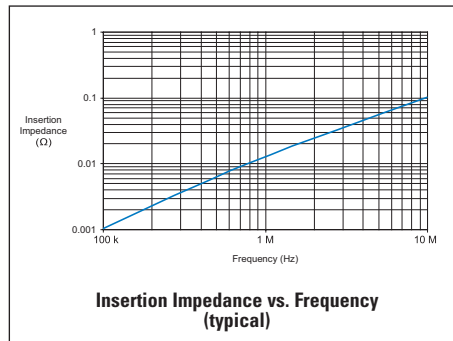

CP500 – 500 A, 2 MHz

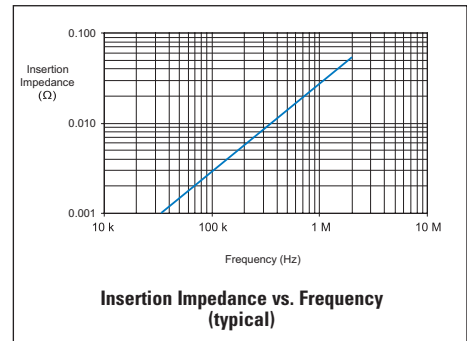



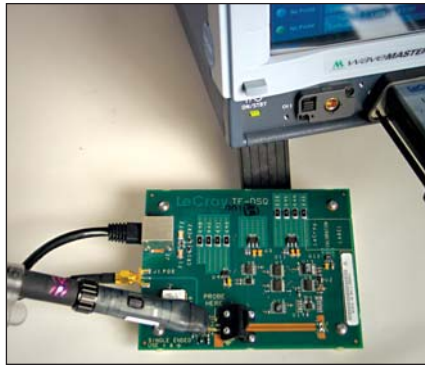

TF-DSQ

## PROBE DESKEW AND CALIBRATION

The TF-DSQ fixture facilitates calibration of timing measurements in single-ended and differential probes—a unique concern in high-speed measurements. By requiring only one connection of a probe to the fixture and one button press, the TF-DSQ ensures probe calibration results that are valid for the duration that the probe is connected to the circuit. An extremely fast edge with 75 ps risetime combines with probe gain and offset calibration capabilities for added accuracy.

### Features:

- Deskews to  $\pm 20$  ps typical accuracy
- Differential and single-ended drive
- 75 ps edge for precise deskewing
- Calibrates gain, offset and skew at the same probing point
- Accounts for risetime variations
- Accounts for common-mode voltage variations
- DC gain calibration accounts for probe loading effects
- Integrated operation with scope for fully automatic calibration

### SPECIFICATIONS

#### SCOPE COMPATIBILITY

(requires software version 3.6.0 or later)

#### SCOPES

WaveMaster (**WM8420A and WM8620A including all WaveMaster XXL models**)

Serial Data Analyzers (**SDA 18000, SDA 11000, SDA 9000, SDA 4020, and SDA 6020 including all SDA XXL models**)

Disk Drive Analyzers (**DDA 5005A and 5005A XXL**)

Scope Connection

ProLink

Probes Supported

WL600 and WL300 with all Probing Accessories PP  
**AP033, AP034, PP066**  
**HFP1000, HFP1500, HFP2500, ZS1500, ZS1000, D11000PS, DA18000**

DC Range

$\pm 5$  V Single-ended,  $\pm 10$  V Differential

DC Accuracy

$\pm(1\% + 600 \mu\text{V})$

Edge Risetime

75 ps (typical) < 95 ps (guaranteed)

Edge Amplitude and Rep Rate

Approximately 800 mV @ 10 MHz

Deskew Accuracy

$\pm 20$  ps (typical)

### ORDERING INFORMATION

### PRODUCT CODE

Probe Deskew and Calibration Fixture

TF-DSQ

**Included:** ProLink Extender 48" 50 ohm Cable with Male SMA Connectors Calibration Certificate Operator's Manual Soft Accessory Case

## EZ PROBE POSITIONER

The EZ-Probe Positioner provides stable, accurate X, Y and Z positioning in one fluid motion. Its unique 3-D joystick, with 3:1 motion reduction and single-clutch, fully-articulating arm, allow simple, precise positioning in anything from card cages to MCMs. Any current handheld probes can be easily attached, facilitating the measurement process and ensuring more precise connectivity.

### ORDERING INFORMATION

Cascade Microtech EZ-Probe Positioner

### PRODUCT CODE

EZ PROBE

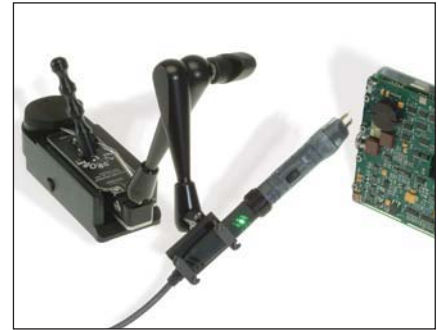

EZ PROBE

## ADPPS

Power Adapter for AP033, AP034 and HFP1000 Active Probes; allows the probe's output to be connected to other non-ProBus test equipment, including spectrum and network analyzers.

### ORDERING INFORMATION

ProBus-to-BNC and Power Adapter for AP033, AP034, and HFP Series (BW limited to 1 GHz)

### PRODUCT CODE

ADPPS



ADPPS

## TRANSIT CASE

Soft Accessory Case for probes—features inside flap for storing manuals, plus roomy interior for a probe and its many accessories.

### ORDERING INFORMATION

Soft Accessory Case for Probes

### PRODUCT CODE

SAC-01



SAC-01



## DIFFERENTIAL AMPLIFIERS AND ACCESS.

The DA1855A is a stand-alone, high-performance differential amplifier providing the fastest overdrive recovery of any commercially available product. This unique capability allows the amplifier to make measurements that would normally be limited by oscilloscope overdrive recovery.

### Features:

- Full control from oscilloscope through ProBus interface
- DC to 100 MHz bandwidth
- Outstanding 100,000: 1 Common Mode Rejection Ratio (CMRR)
- Gain of X1 or X10
- Industry-leading overdrive recovery
- Low noise
- Selectable BW limiting
- Two gain control modes when connected to a LeCroy oscilloscope
- Built-in Precision Voltage Generator (PVG)
- Comparator and true differential offset modes



DA1855A

## SPECIFICATIONS

### GENERAL

Amplifier Gain	1 or 10
Gain Accuracy	±1% + uncertainty of termination resistance
Output Zero	≤ 2 mV referred to input
Bandwidth	> 100 MHz (X1 gain)
Output Impedance	50 Ω
Intended Output Load	50 Ω
Maximum Output	limited at ±0.50 V into 50 Ω
Input Attenuation	÷1 or ÷10
Input Impedance	1 MΩ    20 pF 100 MΩ resistance selectable in ÷1 attenuation setting only

### MAX. DIFFERENTIAL LINEAR INPUT

(X1 Gain, ÷1 Attenuator)	±0.5 V
(X10 Gain, ÷1 Attenuator)	±0.05 V
(X1 Gain, ÷10 Attenuator)	±5.0 V
(X10 Gain, ÷10 Attenuator)	±0.5 V

### MAX. COMMON MODE INPUT

(÷1 Attenuator)	±15.5 V
(÷10 Attenuator)	±155 V

### DIFFERENTIAL OFFSET RANGE (VDIFF) MODE

(X1 Gain, ÷1 Attenuator)	±10 V
(X10 Gain, ÷1 Attenuator)	±1 V
(X1 Gain, ÷10 Attenuator)	±100 V
(X10 Gain, ÷10 Attenuator)	±10 V

### COMPARISON OFFSET RANGE (VCOMP) MODE

Effective Comparison Voltage Range	
(÷1 Attenuator)	±15.5 V
(÷10 Attenuator)	±155 V



## DIFFERENTIAL AMPLIFIERS AND ACCESS.

### COMMON MODE REJECTION RATIO, X1 OR X10 GAIN, $\pm 1$ ATTENUATION

$\geq 50,000 : 1$	1 (94 dB) @ 70 Hz
$\geq 50,000 : 1$	1 (94 dB) @ 100 kHz
$\geq 316 : 1$	1 (50 dB) @ 10 MHz

### OVERDRIVE RECOVERY

In X10 gain, amplifier settles to within 1 mV referred to the input within 100 nsec from 4 V input (8000% overdrive).

### BANDWIDTH LIMIT FILTERS (LOW PASS)

20 MHz, 1.0 MHz, and 100 kHz

### MAXIMUM NONDESTRUCT INPUT

250 V<sub>peak</sub>

### PRECISION VOLTAGE SOURCE

Output Range	$\pm 15.5$ V
DC Accuracy	0.05% of reading +500 $\mu$ V (15 °C to 45 °C)
Resolution	100 $\mu$ V (5 1/2 digit)

### POWER REQUIREMENTS

Line Voltage Requirement	100 to 250 VAC
Line Frequency Range	48–66 Hz
Power Consumption	$\approx 26$ W, $\approx 36$ VA $\approx 52$ W, $\approx 72$ VA (DA1855A-PR2)

### ENVIRONMENTAL CHARACTERISTICS

Operating Range	0 °C to 50 °C
Non-Operating	-4 °C to 75 °C

### PHYSICAL CHARACTERISTICS

Height	7.29 cm (2.87")
	8.75 cm (3.4") (DA1855A-PR2)
Width	21.2 cm (8.36")
	43.9 cm (17.3") (DA1855A-PR2 without rack mounting ears installed)
Depth	23.2 cm (9.12")
	42.5 cm (16.7") (DA1855A-PR2)
Weight	2.15 kg (4.75 lbs.)
	9.5 kg (21 lbs.) (DA1855A-PR2)
Shipping Weight	3.12 kg (6.88 lbs.)
	11.3 kg (25 lbs.) (DA1855A-PR2)

### WARRANTY

3 years

### ORDERING INFORMATION

### PRODUCT CODE

1 Ch, 100 MHz Differential Amplifier with Precision Voltage Source	DA1855A
2 Ch, 100 MHz Differential Amplifier with Precision Voltage Source	DA1855A-PR2
2 Ch, DA1855A with Rackmount	DA1855A-PR2-RM*

\*Must be ordered at time of purchase, no retrofit.

## DIFFERENTIAL AMPLIFIERS AND ACCESS.

The DXC100A is a high performance, passive, matched differential probe pair designed for use with the DA18xxA Series differential amplifiers. It allows for precise adjustment and matching of transient response, and optimization of the system Common Mode Rejection Ratio (CMRR).

### Features:

- DC to 100 MHz bandwidth with DA1855A
- Maximum input voltage 500 V
- Selectable  $\div 10$  or  $\div 100$  attenuation factor
- 1.2 meter cable length

### SPECIFICATIONS

Attenuation Factor	$\div 10$ or $\div 100$
System Bandwidth (-3 dB) (with DA1855A)	100 MHz
System Risetime (with DA1855A)	3.5 ns
Input Resistance	1 M $\Omega$ $\pm 1\%$
Input Capacitance	10.5 pF $\pm 0.5$ pF
Max. Nondestructive Input Voltage	500 V DC + peak AC
Length	1.2 meter

### ENVIRONMENTAL CHARACTERISTICS

Operating Range	0 °C to 50 °C
Non-Operating	40 °C to 71 °C

### PHYSICAL CHARACTERISTICS

Weight	0.18 kg (6.4 oz.)
Shipping Weight	0.45 kg (1 lb.)

### WARRANTY

1 year



DXC100A

### ORDERING INFORMATION

$\div 100$  or  $\div 10$  Selectable, 250 MHz  
Passive Differential Probe Pair

### PRODUCT CODE

DXC100A\*

\*Must be used with DA Series differential amplifiers



DXC200

## DIFFERENTIAL AMPLIFIERS AND ACCESS.

The DXC200 is a pair of  $\div 1$  probes matched for differential measurement applications. It is designed to minimize capacitive loading while still maintaining practical probe-to-circuit attachment. The DXC200 allows the user to take advantage of the DA18xxA Series' 100  $\Omega$  input resistance setting.

### Features:

- Low capacitance
- $\div 1$  differential probe pair
- 0.7 meter cable length

### SPECIFICATIONS

Attenuation Factor	$\div 1$
System Capacitance (with DA18xxA)	< 50 pF
Length	0.7 meter

### DXC200 AND DA1855A SYSTEM SPECIFICATIONS

Risetime	7 ns
Bandwidth (-3 dB)	50 MHz
Input Resistance (selectable)	1 or 100 M $\Omega$
Maximum Nondestructive Input Voltage	500 VDC + peak AC

### ENVIRONMENTAL CHARACTERISTICS

Operating Range	0 °C to 50 °C
Non-Operating	-4 °C to 75 °C

### PHYSICAL CHARACTERISTICS

Weight	0.14 kg (5 oz.)
Shipping Weight	0.45 kg (1 lb.)

### WARRANTY

1 year

### ORDERING INFORMATION

$\div 1$ , 50 MHz Passive Differential Probe Pair

\*Must be used with DA Series differential amplifiers

### PRODUCT CODE

DXC200\*

**DIFFERENTIAL AMPLIFIERS AND ACCESS.**

The DXC5100 is a passive, high voltage differential probe pair for use with DA18xxA Series differential amplifiers. It is ideal for motor drive and other applications with high bus voltages. Maximum differential input voltage is 500 volts (5 kV when used with DA101).

**Features:**

- Maximum input voltage 2500 V to ground
- $\div 100$  attenuation
- DC to 100 MHz bandwidth with DA1855A
- $< 2.75$  pF input capacitance

**SPECIFICATIONS**

Attenuation Factor	$\div 100, \pm 1.75\%$
Max. Input Voltage, each probe to ground	2500 V (DC + peak AC)
Input Resistance	10 M $\Omega$
Input Capacitance	$< 2.75$ pF
Cable Length	3.1 meter
Weight	275 g (10 oz.)
Shipping Weight	0.5 kg (1 lb. 1.6 oz.)

**WARRANTY**

1 year



DXC5100

**ORDERING INFORMATION**

$\div 100$ , 250 MHz 2.5 kV, High-Voltage Probe Pair

\*Requires DA101 for full performance

**PRODUCT CODE**

DXC5100\*

The DA101 is a  $\div 10$  passive external attenuator. When used with the DXC5100, it extends the probe pair's differential mode range to up to 5000 volts, provided that the common mode voltage of 2500 volts to ground for each probe is not exceeded.

**SPECIFICATIONS**

Attenuation Factor	$\div 10$
Weight	0.10 kg (3.5 oz.)
Shipping Weight	0.41 kg (0.9 lb.)

**ORDERING INFORMATION**

$\div 10$ , 1 M $\Omega$  External Passive Attenuator

† Recommended with DXC5100

**PRODUCT CODE**

DA101†



DA101





## CANBUS TD/TDM - TRIGGER AND DECODING

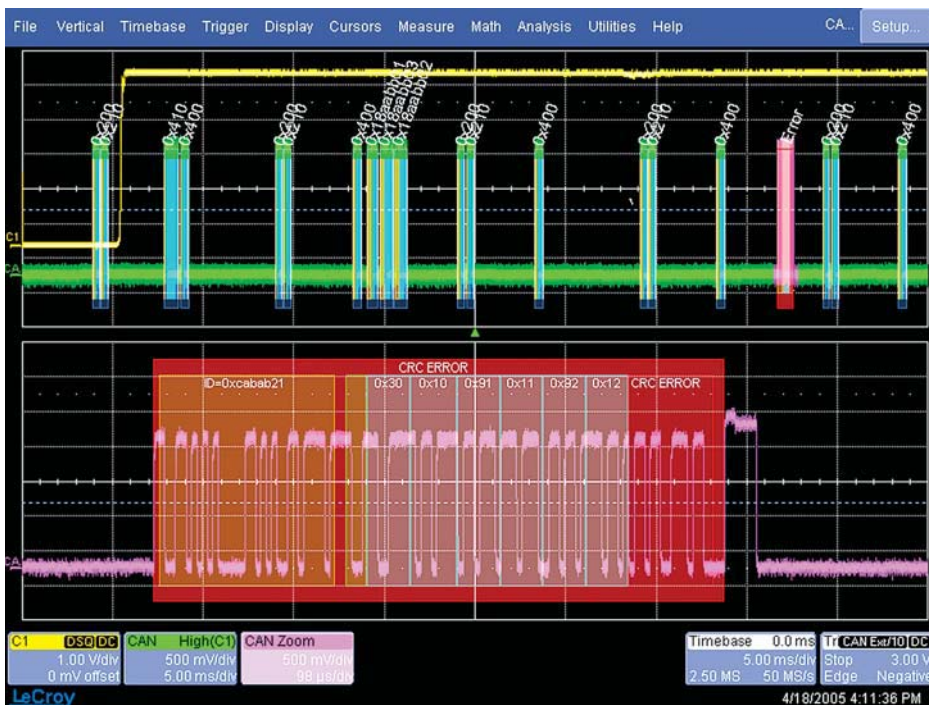

### Debug and Validate Faster. Improve Reliability. Lower Costs.

With the new CANbus TD/TDM, LeCroy provides a dramatically improved solution for testing and debugging CAN systems. Now Analog, CAN Message data, and Digital signals can all be viewed on a single instrument—an easy-to-use, everyday bench oscilloscope. With this single display and the robust CANbus TD/TDM toolset, engineers will capture more information and develop more insight easily and quickly. By eliminating the need for a variety of instruments and displays, the LeCroy CANbus TD/TDM system sets a new standard for CAN bus testing. The oscilloscope triggers on pre-defined CAN messages, then captures, decodes, and shows them on the display. Other analog or digital signals on the CAN ECU can also be captured and displayed. Cursors, measurement parameters, and graphing tools quickly characterize timing and other signal relationships.

### Features:

- Capture > 10,000 CAN messages in one acquisition.
- Trigger on CAN Data, Remote, or Error Frames.
- Decode CAN messages on the oscilloscope display.
- View analog, digital, and CAN signals.
- Measure performance and statistically analyze.
- Graph and plot performance data.

### Understanding Performance Has Never Been Easier

With CANbus TD/TDM, the right toolsets make all the difference in understanding CAN system performance. Anomalies are identified more readily; debugging proceeds more quickly.

### Performance Capabilities include the following:

- Trigger on CAN or Analog signals. Set CAN message ID and DATA conditions.
- Trigger on Data, Remote, or Error frames.
- One touch zooming of the CAN message is especially helpful with long acquisitions of thousands of CAN messages.

## CANBUS TD/TDM – TRIGGER AND DECODING

- Add digital measurement capability with LeCroy's MS-32 option.
- Error Frame Highlight allows users to intuitively locate error frames in long acquisitions.
- Optional memory (up to 12 Mpts/Ch) allows capture times of 10 s or more (5 Mpts/Ch standard).
- CAN Decode is done quickly and automatically, with information overlaid on the CAN physical layer signal.
- Utilize Statistical Views for numerical calculations and histograms, of millions of events.
- Quickly Search through CAN message data. Jump to next conditional frame. Automatically view the searched frame in a zoom window.
- Obtain Exact Node Matching by setting Tseg1, Tseg2, and other values exactly the same as your nodes under test, just like the tools that you are used to.

### Graphing Tools

CANbus TDM contains unique graphing and statistical analysis capability that can be used to validate and analyze CAN system performance

#### Histogram

A graphical plot of measurement data for any automatic measurement parameter, including CAN timing parameters, frequency, amplitude, etc. Worst-case values, modality, and stability can be intuitively understood quickly; and root cause of irregularities debugged. Up to 2 billion measurement values can be histogrammed.

#### Track

A graphical plot of measurement data values that is time-correlated to all other measurement signals. The vertical scale of the Track is the measurement value, and the horizontal scale is time. As the measurement value changes with time, the Track changes, which enables intuitive understanding of signal modulation and other behavior. Track is ideal for understanding PWM or F-V converter signals.

#### Trend

A graphical plot of measurement data that is very similar to chart recorder functionality. Like Track, Trend displays measurement values on the vertical axis, but data can be accumulated over many oscilloscope acquisitions (up to 1 million events). Trend is ideal for recording temperature, pressure, stress, strain, or other slow-speed analog signals.

### ORDERING INFORMATION

### PRODUCT CODE

#### STANDARD

CANbus TDM Trigger, Decode, and Measure/Graph Option

CANbus TDM

- Trigger Module with TC251-OPTO optically isolated Trigger Coupler installed (and room for one additional Trigger Coupler). Trigger Couplers are interchangeable.
- CANbus TD Series Oscilloscope Interface Module with 1.0 meter connection cable. Connects Trigger Module to LeCroy oscilloscope ProBus interface.
- Software for:
  - Trigger Setup
  - CAN Protocol Decode
  - CAN Measurement, (CAN-analog, CAN-CAN, and Time@CAN timing parameters, CAN bus load% and CAN-Value Data Extraction parameters)
  - Histogramming
  - Graphing (Track and Trend)

## CANBUS TD/TDM - TRIGGER AND DECODING

### ORDERING INFORMATION

### PRODUCT CODE

#### STANDARD (continued)

CANbus TDM Trigger, Decode, and Measure/Graph Option	CANbus TDM
--	------------

- 1.0 meter USB 2.0 cable from LeCroy external CANbus TD Trigger Module to LeCroy oscilloscope
- Black fabric storage case (SAC-01) with foam insert and room for storage of all equipment and 2 (two) additional Trigger Coupler accessories (not included)
- Quantity 1 (one) 9-pin DSUB socket to 2-wire adapter cable (for ISO 11898-2 CAN)
- Quantity 1 (one) 9-pin DSUB socket to 4-wire adapter cable (dual-use, for ISO 11519 CAN and GM-LAN/J2411 CAN)
- Quantity 2 (two) 9-pin to 9-pin DSUB 120 ohm terminations
- Quick Reference Guide in English
- Instruction Manual in English
- Quantity 1 (one) Phillips head screwdriver

CANbus TD Trigger and Decode Option	CANbus TD
-------------------------------------	-----------

- Same hardware package as CANbus TDM
- Software for
  - Trigger Setup
  - CAN Protocol Decode

CANbus TDM for use on 5 Oscilloscopes	CANbus TDM-5LIC
---------------------------------------	-----------------

One hardware package and a license to use the software on 5 different oscilloscopes.

CANbus TDM Trigger, Decode, and Measure/Graph Option	CANbus TD-5LIC
--	----------------

One hardware package and a license to use the software on 5 different oscilloscopes.

#### HARDWARE OPTIONS AND ACCESSORIES

CAN 1041 Opto-isolated High-speed Trigger Coupler	TC1041-OPTO
CAN 1050 Opto-isolated High-speed Trigger Coupler	TC1050-OPTO
CAN 1054 Opto-isolated Low-speed Trigger Coupler	TC1054-OPTO
CAN 251 Opto-isolated High-speed Trigger Coupler (one is included with CANbus TD)	TC251-OPTO
CAN 5790c Opto-isolated Single-wire Trigger Coupler	TC5790c-OPTO
CAN B10011S Opto-isolated Truck and Bus Trigger Coupler	TC10011-OPTO
CAN Cable Set (ISO 11898-2)	902329-00
CAN Cable Set (ISO 11519, GM-LAN/J2411)	902330-00
CAN Bus Y Connection Cable, 2 m, with Terminating Resistor	902393-00
1 GHz Active Differential Probe ( $\pm 1$ , $\pm 10$ , $\pm 20$ )	AP034
500 MHz Active Differential Probe ( $\times 10$ , $\pm 1$ , $\pm 10$ , $\pm 100$ )	AP033
1,400 V, 100 MHz High-Voltage Differential Probe	ADP305
1,400 V, 20 MHz High-Voltage Differential Probe	ADP300





VEHICLE BUS ANALYZERS

## VEHICLE BUS ANALYZERS

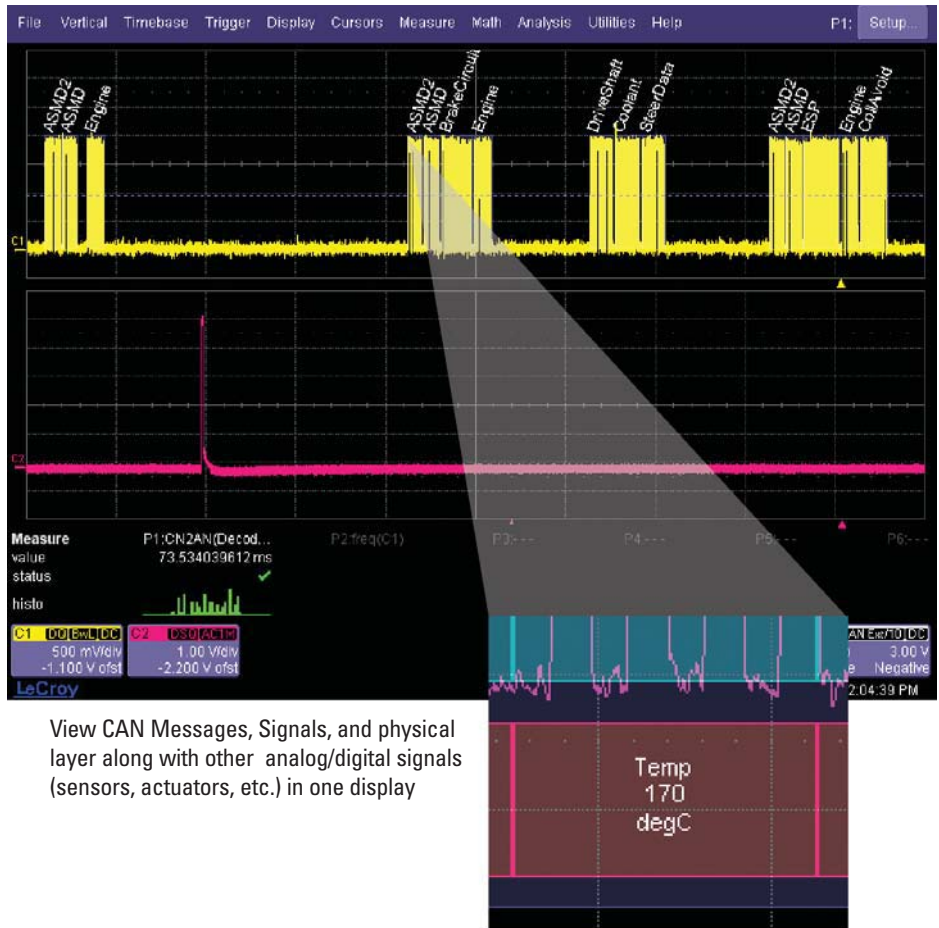

View CAN Messages, Signals, and physical layer along with other analog/digital signals (sensors, actuators, etc.) in one display

The Vehicle Bus Analyzer is the first conventional oscilloscope to decode CAN serial data into Symbolic (application layer) text. Now, for the first time, an engineer has both the full range of CAN protocol stack information—symbolic, hex, and electrical signal—and the ability to view additional in-circuit electrical signals (sensors and actuators, voltage levels, transients, etc.) that influence the CAN bus. In addition, up to four different CAN buses can be decoded at one time. Standard and specialized oscilloscope tools can be used to validate and debug designs.

### Features:

- Symbolic (Application Layer) decode of up to 4 CAN buses
- Compatible with DBC database format
- Display decoded results above waveform on oscilloscope screen
- CAN triggering with setup in symbolic format
- Gateway timing measurements (CAN message to CAN message across a gateway)
- Capture thousands (seconds) of CAN messages with 4 Mpts of memory (up to 24 Mpts optional)
- All CANbus TDM functionality, including:
  - Timing measurements
  - Bus Load measurements
  - CAN message data extraction
  - CAN message Bit Rate calculation
  - Statistical calculation of timing information for many events, and graphical display
  - Graphs/Plots of CAN message data

## VEHICLE BUS ANALYZERS

### Eliminate the Barriers to Fast Debug

Direct symbolic decoding and triggering allows fast and intuitive understanding of events. Simply load your existing DBC database file into the oscilloscope (no re-entry of data is required), capture CAN message traffic, and all electrical (signal), protocol (hex) and symbolic (application) layer information is quickly displayed on the oscilloscope screen. Use standard oscilloscope and specialized Vehicle Bus Analyzer tools to find rare events, automatically measure and statistically analyze event timing, and graph/plot information, including extracted CAN message data.

### The Single Tool Enhances Productivity

The VBA concentrates all your information in one place. Timing measurements across gateways are now possible. Understanding is fast, intuitive, and in a familiar format. Complete, time-correlated understanding of all ECU or circuit behaviors is simple. Time-consuming workarounds are a thing of the past.

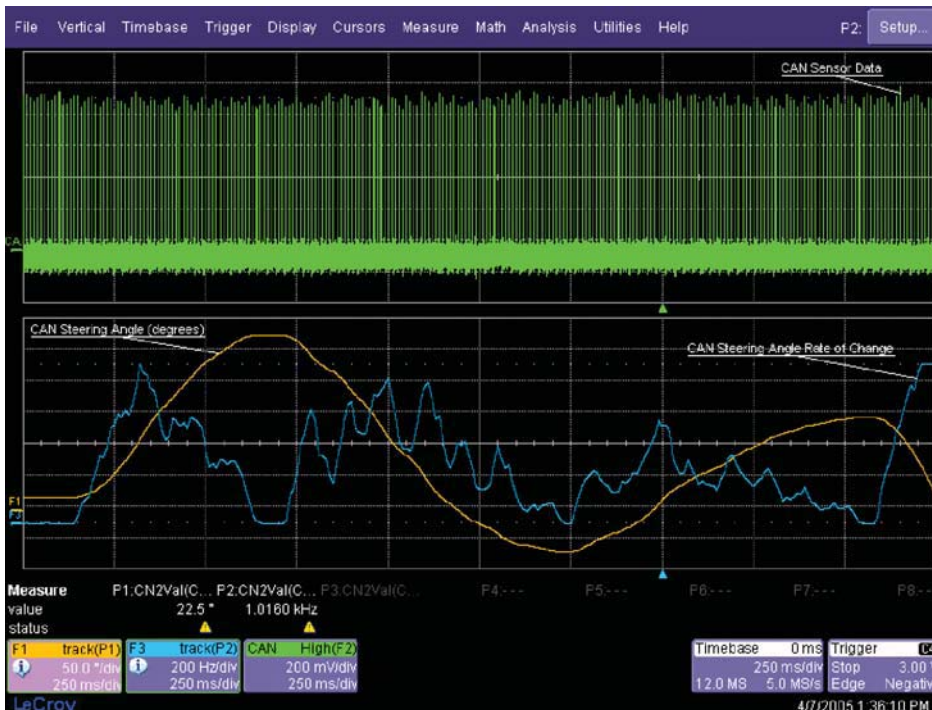

### Unique Measurement Tools

The VBA can make many measurements not possible with other instruments. Aside from timing measurements, the VBA can also extract CAN data from a CAN message stream, graphically plot that data on the oscilloscope display, and compare it to other electrical signals. Here, information on the steering angle and steering angle rate of change is extracted from the CAN message acquisition, rescaled to decimal values, and plotted as a time-correlated "Track" on the VBA display.

## VEHICLE BUS ANALYZERS

### ORDERING INFORMATION

### PRODUCT CODE

#### VEHICLE SOLUTIONS

2 GHz, 4 Ch, Vehicle Bus Analyzer	VBA204Xi
1 GHz, 4 Ch, Vehicle Bus Analyzer	VBA104Xi
600 MHz, 4 Ch, Vehicle Bus Analyzer	VBA64Xi
400 MHz, 4 Ch, Vehicle Bus Analyzer	VBA44Xi

All Vehicle Bus Analyzers are complete with a powerful LeCroy WaveRunner Xi Series oscilloscope, CANbus TDM software, and CANbus TD hardware (CAN bus triggering hardware kit). Reference the WaveRunner Xi Series brochure for complete information on WaveRunner Xi oscilloscopes. (Brochures available at [www.lecroy.com](http://www.lecroy.com))

#### VEHICLE BUS ANALYZER SOFTWARE CAPABILITIES

- Symbolic (application layer) decode of up to 4 separate CAN buses
- Symbolic CAN trigger setup
- Hexadecimal decode and trigger setup
- Binary trigger setup
- Automated timing measurements, including capability to measure timing across gateways:
  - CAN message to Analog signal
  - Analog signal to CAN message
  - CAN message to CAN message
- Bus Load % measurements (up to 2 billion events)
- CAN message extraction and display in scaled decimal values
- CAN message bit rate calculation
- Statistical calculations of many measurements
- Histogram (graphical) display of statistical data, including timing measurements
- Trend and Track plots of extracted CAN data
- Persistence trace, mean, and sigma functionality
- Complete set of Jitter and Timing (@level) parameters

#### CAN TRIGGERING HARDWARE CONTENTS

- Trigger Module with TC251-OPTO optically isolated Trigger Coupler installed (and room for one additional Trigger Coupler). Trigger Couplers are interchangeable.
- Oscilloscope Interface Module with 1.0 meter connection cable. Connects Trigger Module to LeCroy oscilloscope ProBus interface.
- 1.0 meter USB 2.0 cable from LeCroy external CANbus TD Trigger Module to LeCroy oscilloscope
- Black fabric storage case (SAC-01) with foam insert and room for storage of all equipment and two additional Trigger Coupler accessories (not included)
- Quantity 1 (one) 9-pin DSUB socket to 2-wire adapter cable (for ISO 11898-2 CAN)
- Quantity 1 (one) 9-pin DSUB socket to 4-wire adapter cable (dual-use, for ISO 11519 CAN and GM-LAN/J2411 single-wire CAN)
- Quantity 2 (two) 9-pin to 9-pin DSUB 120 ohm terminations
- Quick Reference Guide and Instruction Manual in English
- Quantity 1 (one) Phillips head screwdriver

## VEHICLE BUS ANALYZERS

ORDERING INFORMATION	PRODUCT CODE
<b>OPTIONS AND ACCESSORIES</b>	
25 Mpts max. (interleaved), 12.5 Mpts/Ch Memory Option	VBA-VL
32 Digital Channel Oscilloscope Mixed Signal Option	MS-32
CAN 1041 Opto-isolated High-speed Trigger Coupler	TC1041-OPTO
CAN 1050 Opto-isolated High-speed Trigger Coupler	TC1050-OPTO
CAN 1054 Opto-isolated Low-speed Trigger Coupler	TC1054-OPTO
CAN 251 Opto-isolated High-speed Trigger Coupler (one is included with CANbus TD)	TC251-OPTO
CAN 5790c Opto-isolated Single-wire Trigger Coupler	TC5790c-OPTO
CAN B10011S Opto-isolated Truck and Bus Trigger Coupler	TC10011-OPTO
CAN Cable Set (ISO 11898-2)	902329-00
CAN Cable Set (ISO 11519 and GM-LAN/J2411)	902330-00
CAN Bus Y Connection Cable, 2m with Terminating Resistor	902393-00
1 GHz Active Differential Probe ( $\div 1$ , $\div 10$ , $\div 20$ )	AP034
500 MHz Active Differential Probe ( $\times 10$ , $\div 1$ , $\div 10$ , $\div 100$ )	AP033
1,400 V, 100 MHz High-Voltage Differential Probe	ADP305
1,400 V, 20 MHz High-Voltage Differential Probe	ADP300
(Qty. 4) 1.5 GHz, 0.9 pF, 1 M $\Omega$ High Impedance Active Probe	ZS1500-QUADPAK
(Qty. 4) 1 GHz, 0.9 pF, 1 M $\Omega$ High Impedance Active Probe	ZS1000-QUADPAK













**LeCroy**

1-800-5-LeCroy  
[www.lecroy.com](http://www.lecroy.com)

**Local sales offices are located throughout the world.  
To find the most convenient one visit [www.lecroy.com](http://www.lecroy.com)**

© 2007 by LeCroy Corporation. All rights reserved. Specifications, prices, availability and delivery subject to change without notice.  
Product or brand names are trademarks or requested trademarks of their respective holders.

CAT2007\_2008\_05Jan07  
20K MTECH