

EVERYTHING 4 LESS

ENJOY YOUR BOOKS

PLEASE VISIT OUR STORE FOR EVEN MORE GREAT STUFF!

WWW.EVERYTHING4LESSSTORE.COM

COPYRIGHT NOTICE

ALL MATERIALS INCLUDING CD/DVD AND PDF FILES ARE COPYRIGHTED

WWW.EVERYTHING4LESSSTORE.COM VON WALTHOUR PRODUCTIONS AND MAY NOT BE REPRODUCED, COPIED OR RESOLD UNDER ANY CIRCUMSTANCES. YOU MAY HOWEVER MAKE A COPY FOR YOUR OWN PERSONAL BACKUP. MATERIALS ARE FOR PERSONAL USE ONLY.

IF YOU PURCHASED THIS FROM ANYWHERE BUT FROM US PLEASE NOTIFY US IMMEDIATELY SO THAT WE MAY CHECK IF YOU PURCHASED FROM AN AUTHORIZED RESELLER SO WE CAN LET YOU KNOW IF YOU NEED TO RETURN FOR FULL REFUND FROM AN UNAUTHORIZED SELLER.

THANKS AGAIN AND PLEASE TAKE THE TIME TO VISIT OUR STORE.

ATTENTION! EVERYTHING ON SALE NOW!!



HOT SALE!

LEADER

FUNCTION GENERATOR

INSTRUCTION MANUAL

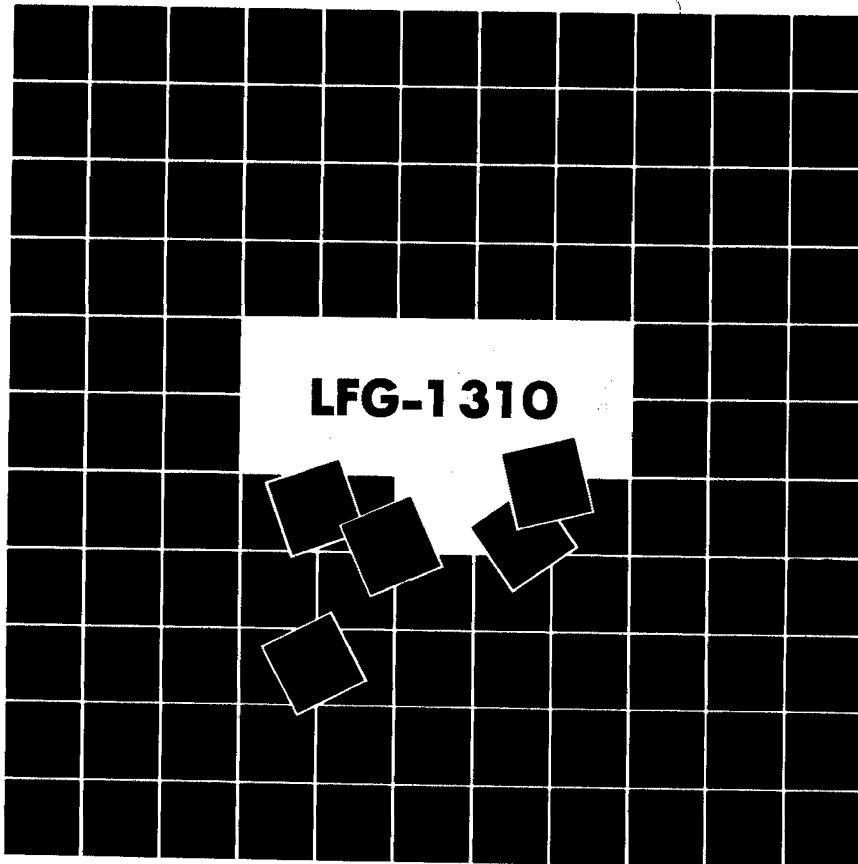

LEADER ELECTRONICS CORP.

TABLE OF CONTENTS

	Page
1. DESCRIPTION	2
2. FEATURES	2
3. SPECIFICATIONS	2
4. PANEL CONTROLS AND CONNECTORS	4
4.1 Front Panel	4
4.2 Rear Panel	7
5. OPERATING INSTRUCTIONS	9
5.1 Operating Precautions	9
5.2 Basic Signal Generation	10
5.3 Trigger/Gate Modes	11
5.4 BURST Mode	13
5.5 SWEEP Mode	14
5.6 Symmetry	16
5.7 DC OFFSET/DC OUT	16
5.8 Amplitude Modulation	18
5.9 VCG Operation	19
5.10 Combination of Functions	19
6. MAINTENANCE	22

1. DESCRIPTION

The LFG-1310 Function Generator generates a variety of waveforms, including sine, square, triangle, ramp, and pulse signals over a frequency range of 0.01 Hz to 10 MHz.

Because it provides such different operation modes as continuous generation, gate generation, trigger generation, burst wave generation, and sweep generation, the LFG-1310 can be used for diverse applications — for example, for frequency characteristic measurement of audio/video equipment and in the testing of automatic control devices.

2. FEATURES

- Wide frequency range of 0.01 Hz to 10 MHz.
- Gate and trigger generations are possible.

The LFG-1310 provides gate generation to supply signals for a fixed period of time, and trigger generation to supply signals for one cycle. The trigger points can be arbitrarily set.

- Burst waves can be generated by the built-in oscillator.
- Built-in linear/logarithmic sweep functions.
- VCG function for external control of output frequency.
- GCV function to generate a voltage in proportion to the frequency.
- Built-in amplitude modulation circuit with the suppressed-carrier mode.
- Variable waveform symmetry.
- DC offset function to superimpose DC voltage on output waveforms. In addition, DC voltage only can be obtained.

3. SPECIFICATIONS

Frequency Range:	0.01Hz to 10MHz, 9 ranges
Accuracy:	x0.01 to x100k ranges . . . $\pm 5\%$ of full scale x1M range . . . $\pm 10\%$ of full scale
Waveforms:	Sine wave, triangle wave, square wave, ramp wave, and pulse wave
Sine wave:	
Flatness:	0.01Hz to 100kHz . . . ± 0.3 dB 100kHz to 10MHz . . . ± 1 dB
Distortion:	10Hz to 50kHz . . . 0.5% or less
Triangle wave:	
Linearity error:	1% at 100Hz
Square wave:	
Rise/fall time:	25ns or less (with max. output)

Symmetry Variation:	20:80 to 80:20 (0.01Hz to 1MHz)
Operation Mode:	
CW:	Continuous generation
TRIG/GATE:	TRIG . . . one cycle oscillation triggered by input signal GATE . . . oscillation only when input is HI
Frequency range:	0.01Hz to 1MHz
Input voltage:	TTL
Input frequency:	DC to 100kHz
Start/stop phase:	Variable
BURST:	Burst wave oscillation for gate time of 1ms to 10s by built-in oscillator. ON/OFF time is symmetrical and variable.
SWEEP:	
Sweep mode:	Selection of linear and logarithmic sweeps
Sweep time:	1ms to 10s, 2 ranges, continuously variable. Fly-back line interval is symmetrical and variable.
Sweep width:	Max. 1:100, continuously variable (sweep start frequency can be specified.)
Output Characteristics:	
Output level:	20Vp-p into open circuit
Attenuator:	0, 20, 40, and 60dB, continuously variable
Output impedance:	50ohms \pm 10%
DC offset:	Max. \pm 10V (output opened)
SYNC output:	TTL level (duty cycle are symmetrical and variable.)
GCV output:	Voltage output in proportion to frequency, 0 to 5V (max. frequency in each range)
SWEEP output:	Sweep output in sweep mode, 0 to -5V
SWEEP/BURST gate out:	TTL level
Amplitude Modulation (AM):	Modulation level . . . 0 to 100%, continuously variable Input signal level . . . max. 5Vp-p Suppressed-carrier mode
External Control of Frequency (VCG):	
Frequency range:	Max. 1000:1, with frequency dial set to "10"
Input level:	0 to -5V (\pm 20%) (frequency is decreased by negative voltage)
Power Requirements:	100 VAC \pm 10%, 50/60Hz, 30VA 120, 200, 220, and 240V available by changing the power transformer tap
Size and Weight:	300(W) x 100(H) x 300(D)mm, approx. 3.5kg
Accessories:	Connection cable: LC-2048 (50-ohm BNC-clip cable) ... 1 Instruction manual 1
Option:	50-ohm terminator LT-2049

- Remarks: 1. The specifications described above are applicable at a temperature of 23°C \pm 5°C and a relative humidity of 40 to 85%.
2. Unless otherwise stated, the frequency dial is set to 1 to 10, and SYMMETRY is set OFF for the specification data.

4. PANEL CONTROLS AND CONNECTORS

4.1 Front Panel (See Fig. 4-1.)

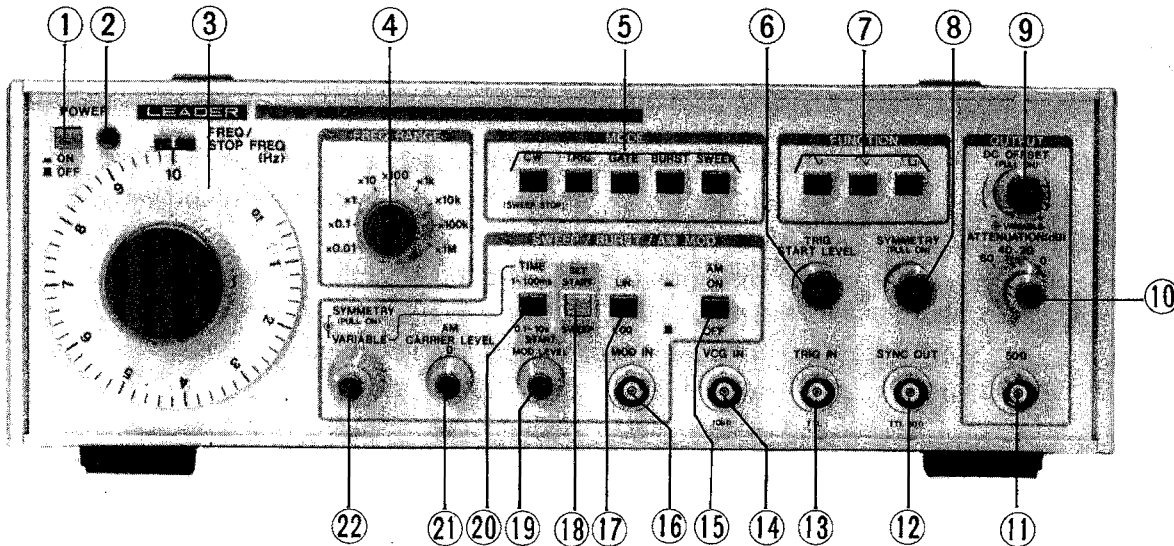

Fig. 4-1

- ① **POWER switch**
Press the switch () to turn the power on — the pilot lamp ② will light. Press again () to turn the power off.
- ② **Pilot lamp**
- ③ **FREQ /STOP FREQ (Hz) dial**
This is used to control the frequency of the output ⑪ . The operating frequency is determined by multiplying the dial reading by the FREQ RANGE ④ setting. With the MODE ⑤ set to SWEEP, this dial indicates the frequency at sweep end.
- ④ **FREQ RANGE switch**
This switch provides range selection for output ⑪ .
- ⑤ **MODE switch**
This switch is used to select one of five generation modes: CW, TRIG, GATE, BURST, or SWEEP.
- ⑥ **TRIG START LEVEL control**
This is used to specify start level when the MODE ⑤ is set to TRIG, GATE, or BURST.

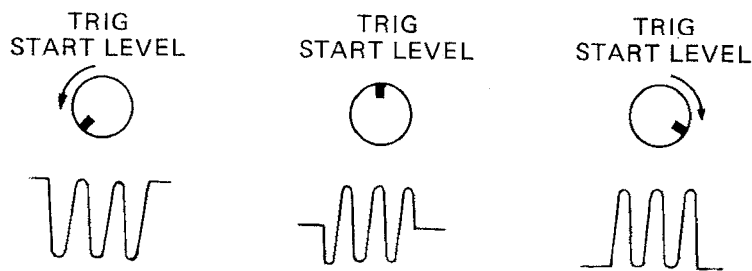

Fig. 4-2

- ⑦ **FUNCTION switches**
 These switches change the waveform of the output ⑪ to sine, triangle, or square wave. If all three switches are released (), DC voltage can be obtained by using the DC OFFSET ⑨ control.
- ⑧ **SYMMETRY control (pull-on)**
 Pull and turn this control knob to adjust the waveform symmetry of the output ⑪ and SYNC OUT ⑫ in the range of 20:80 to 80:20. When the control knob is pressed, the two waveforms are symmetrical.
- ⑨ **DC OFFSET control (pull-on)**
 This is used to superimpose DC voltage on the output ⑪. Pull this knob to use this function, and push it if superimposition is not necessary.
- ⑩ **ATTENUATION (dB) VARIABLE control**
 The outer knob controls the attenuation of the output ⑪ by 0, 20, 40, or 60dB. The inner VARIABLE knob is used to adjust the output level continuously. With DC OFFSET setting to ON, the outer knob is used to adjust DC voltage together with the output; however, DC voltage cannot be varied by using the inner VARIABLE knob.
- ⑪ **Output connector**
 This output connector has an impedance of 50 ohms. When terminated with 50 ohms, the connector generates signals of 10Vp-p (max.). (except for output with amplitude modulation)
- ⑫ **SYNC OUT connector**
 This is a TTL level output connector (with an impedance of 50 ohms) with a 180° phase difference from that of the output ⑪.
 The symmetry of the output can be adjusted by using the SYMMETRY control ⑧. This connector is used for synchronization with an external measuring instrument, TTL signal output, and checking the operating frequency by using a frequency counter.
- ⑬ **TRIG IN connector**
 This is the input connector for trigger/gate signals when the MODE ⑤ is set to TRIG or GATE. TTL level input signals are used.

⑭ VCG IN terminal

This is the input connector used to externally control the frequency of the output from connectors ⑪ and ⑫. A negative voltage applied to this connector decreases the frequency, and a positive voltage increases it.

With the FREQ dial set to "10", negative voltage is applied to decrease the frequency to 1/1000 (maximum frequency ratio). The maximum input voltage is $\pm 10V$ (AC + DC).

⑮ AM switch (ON , OFF)

Press this switch () for amplitude modulation. The MOD IN terminal ⑯ is used to input modulation signals.

⑯ MOD IN connector

This is the input connector for amplitude modulation. It provides an input impedance of about 10k ohms, a frequency range of DC to 1MHz, and a maximum input voltage of $\pm 10V$ (AC + DC). A sweep wave is output when mode is positioned at sweep.

⑰ LOG () / LIN () switch

With the MODE switch ⑤ set to SWEEP, the LOG/LIN switch enables logarithmic sweep or linear sweep to be selected.

⑱ SWEEP () / SET START () switch

This switch is used to set the sweep start frequency with the MODE ⑤ set to SWEEP. When the switch is pressed () for SET START, the sweep is stopped at the sweep start frequency. Then, connect the generator output to a frequency counter or oscilloscope, and specify a sweep start frequency by using the START knob ⑲. After the frequency is set, the sweep can be resumed by setting the switch to SWEEP (). The sweep stop frequency is set by using the FREQ dial.

⑲ START/MOD LEVEL control

This is used to set the sweep start frequency and to change the amplitude modulation level.

⑳ TIME 0.1 to 10s () / 1 ~ 100ms () switch

This switch is used to switch the time ranges for burst gate or sweep when the MODE switch ⑤ is set to BURST or SWEEP.

㉑ AM CARRIER LEVEL control

This is used to adjust carrier levels for amplitude modulation. With a setting around "0", carrier waves are suppressed and a double sideband (DSB) is obtained.

㉒ SYMMETRY (pull-on) / VARIABLE

VARIABLE (outer knob):

This is used to adjust the burst/sweep time continuously in the range selected by the TIME switch ⑳. Turning the VARIABLE counterclockwise decreases the time.

SYMMETRY (pull-on) (inner knob):

Pull out to adjust the ON/OFF time for a burst and sweep time (both ways).

When this knob is pushed in, the time ratio is 50:50.

4.2 Rear Panel (See Fig. 4-3.)

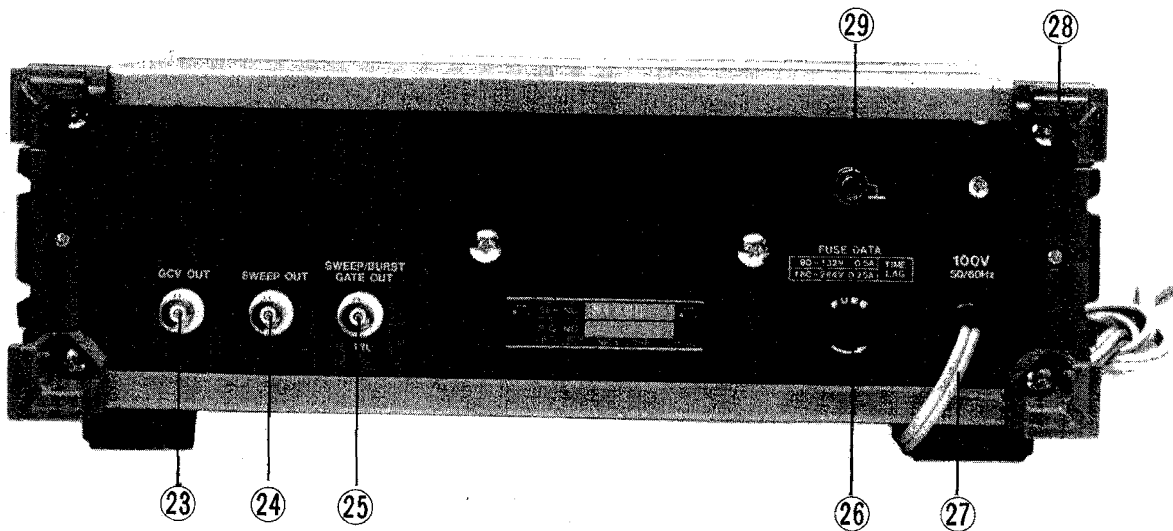

Fig. 4-3

23 GCV OUT connector

This connector outputs a DC voltage in proportion to the oscillation frequency. The output impedance is about 600 ohms and the output voltage is 0 to +5V (with the FREQ dial set to "10") in the frequency range selected by the FREQ RANGE control 4.

24 SWEEP OUT connector

This connector is used for sweep generator output. The output time and symmetry can be adjusted by using the TIME switch 20 and SYMMETRY/VARIABLE control 22.

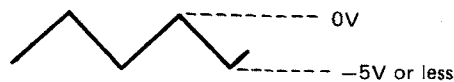

This output ignores the MODE switch 5 setting and can be used as an X-axis signal for an oscilloscope, or as a VCG signal.

25 SWEEP/BURST GATE OUT terminal

This is the gate signal (TTL level) output connector for the sweep/burst mode. Fig. 4-4 shows the relationship between signals and time.

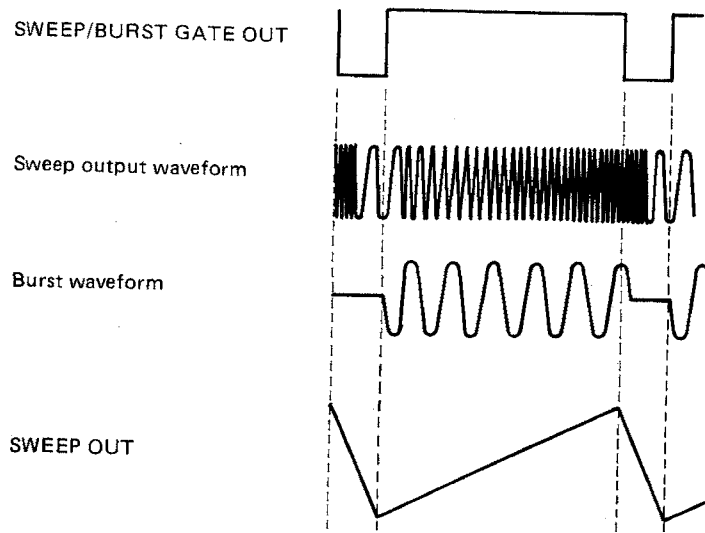

Fig. 4-4

- ②6 **Fuse**
 To remove the fuse, use a Philips screwdriver to turn the cap in the direction indicated by arrow. Make sure that the correct fuse type and rating are used.
 [See 5.1. (1)]
- ②7 **Power cord**
 This cord is to be connected to a power source of the rated voltage.
- ②8 **Power cord hook**
- ②9 **Grounding connector**
 This is connected to the main frame.

5. OPERATING INSTRUCTIONS

5.1 Operating Precautions

(1) Power voltage

The power voltage must be within $\pm 10\%$ of the rated voltage. If it is -10% or less, normal operation may not be achieved. If the voltage exceeds $+10\%$, the power supply unit may be damaged. Make sure that the local voltage matches the voltage and fuse ratings as indicated on the rear panel of the LFG-1310.

The power transformer is equipped with a serial/parallel wind tap for 100/120V. By adjusting the wiring on the tap, any of the five different voltage ranges shown in the table below can be used. Also be sure to check the fuse ratings.

Rated voltage	Applicable voltage range ($\pm 10\%$)	Fuse rating
100V 120V	90 to 110V 108 to 132V	0.5A Time lag
200V 220V 240V	180 to 220V 198 to 242V 216 to 264V	0.25A Time lag

Connections for each voltage

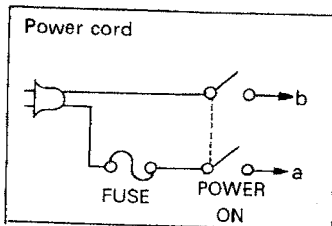
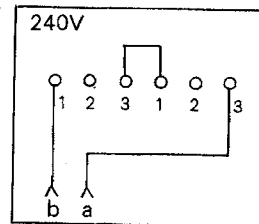
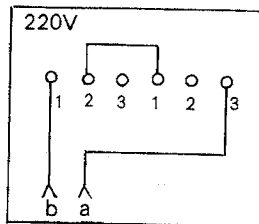
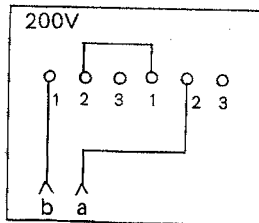
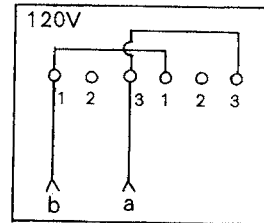
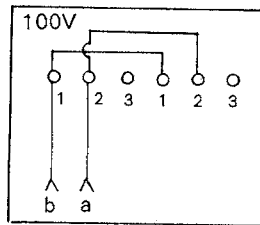
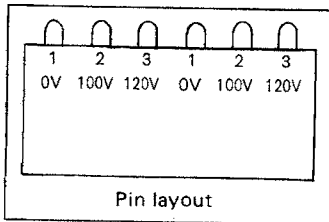

(2) Precautions for input voltage

All input and output connectors are connected for direct coupled circuitry. Do not apply external voltage to any output connector. The output connector ⑪ provides a maximum instantaneous input voltage of $\pm 5V$ (AC + DC). Consequently, if the voltage applied to the connector exceeds this value, the internal circuitry will be damaged.

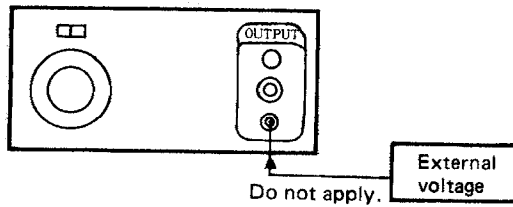

Fig. 5-1

Also, take care to prevent input voltage exceeding the maximum input voltage value from being applied to the input connectors.

(3) Output connections

The output connector ⑪ has an output impedance of 50 ohms. Use a 50-ohm coaxial cable and a 50-ohm terminator for the output to obtain the proper attenuation and better frequency characteristics.

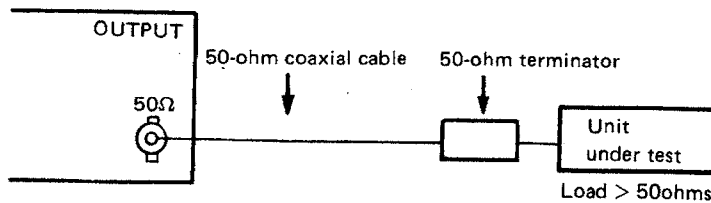

Fig. 5-2

(4) Grounding

All grounding connectors for the input and output connectors are connected to the main frame.

5.2 Basic Signal Generation (Sine, Triangle, and Square Waves)

The panel control settings required to generate sine, triangle, or square waves continuously, and to vary the output frequency manually are as follows.

Panel control	Setting
MODE (5)	CW
FUNCTION (7)	~ , ^ , or □
AM (15)	OFF
SYMMETRY (8)	Used if necessary
FREQ RANGE (4)	Desired range
FREQ dial (3)	Desired position
DC OFFSET (9)	Used if necessary
ATTENUATION (10)	Desired range

A waveform selected by the FUNCTION switches is output to the OUTPUT (11) connector by using these settings. Fig. 5-3 shows the three different waveforms and their relationship with SYNC OUT waveforms in terms of time.

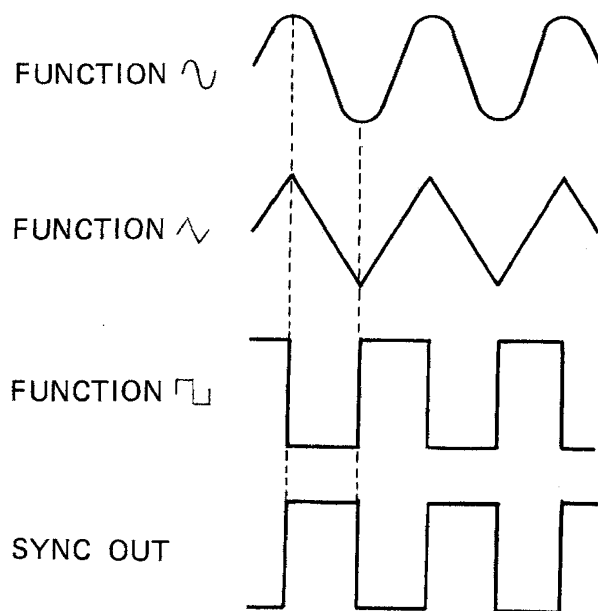

Fig. 5-3

5.3 Trigger/Gate Modes

Set the panel controls as follows to use the trigger or gate mode for signal generation.

Panel control	Setting
MODE (5)	TRIG or GATE
FUNCTION (7)	Desired setting
AM (15)	OFF
SYMMETRY (8)	Desired setting
TRIG START LEVEL (6)	Index up
FREQ RANGE (4)	Desired range
FREQ dial (3)	Desired position
DC OFFSET (9)	Used if necessary
ATTENUATION (10)	Desired range

By using these settings and the TTL signal input to TRIG IN (13), one of the waveforms shown in Fig. 5-4 is output to the OUTPUT (11) connector.

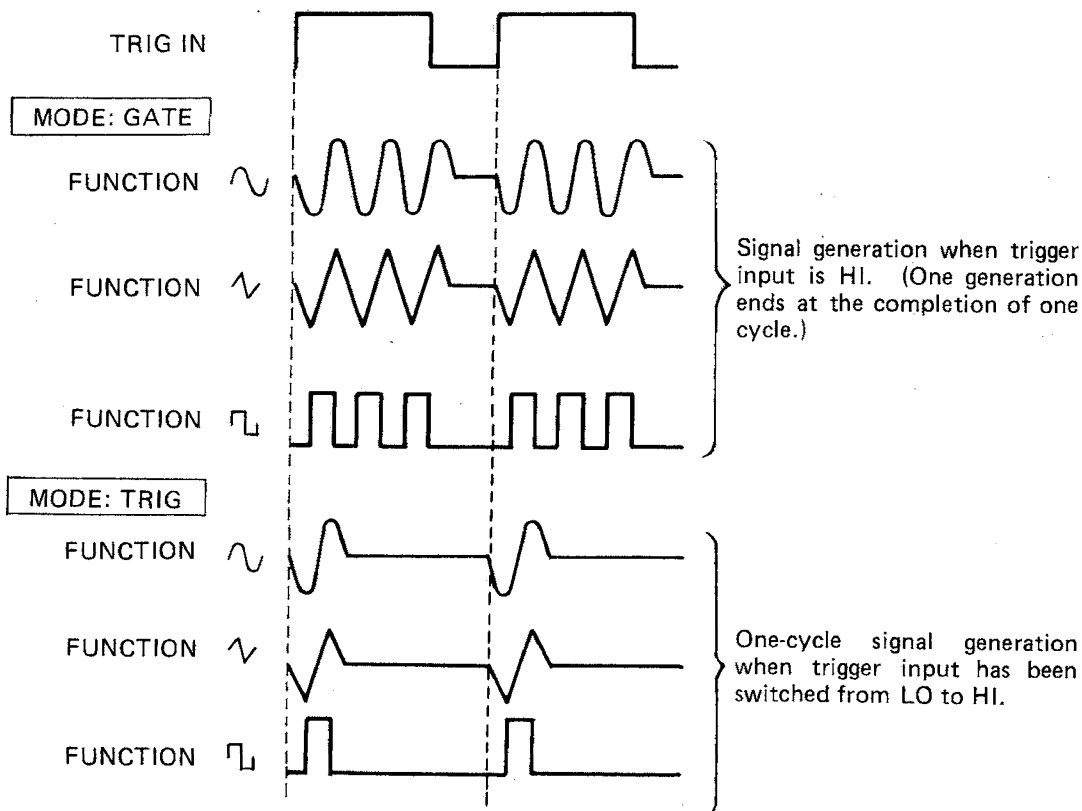

Fig. 5-4

In the trigger or gate mode, the output signal frequency range from 0.1Hz to 1MHz and trigger input frequency range is DC to 100kHz.

TRIG START LEVEL control

Fig. 5-4 shows the output waveforms obtained with the TRIG START LEVEL ⑥ set in the middle. The TRIG START LEVEL is turned to adjust the level to start signal generation.

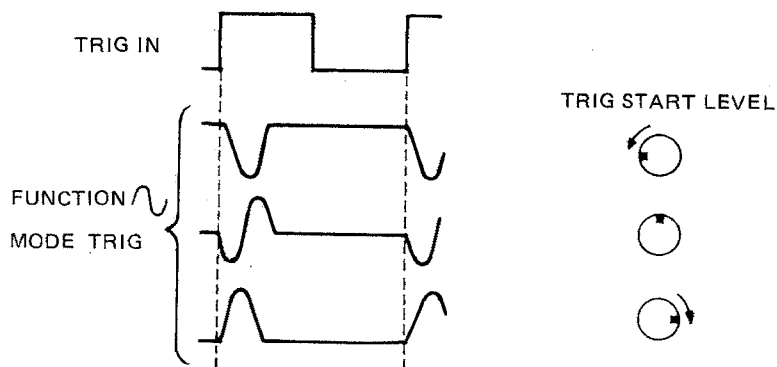

Fig. 5-5

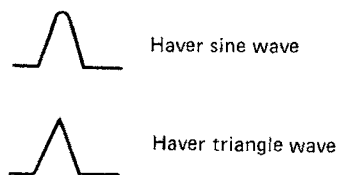

Fig. 5-6

Fig. 5-6 shows the waveforms called Haver sine waves and Haver triangle waves, which are used as trigger signals.

5.4 BURST Mode

The LFG-1310 has a built-in burst gate oscillator used to generate burst waves during a cycle of 1ms to 10s. The ratio of generation time and generation stop time can be adjusted by pulling and turning the inner knob of the SYMMETRY control ②② . The panel control settings for the BURST mode are as follows.

Panel control	Setting
MODE (5)	BURST
FUNCTION (7)	\sim , \wedge , or \square
AM (15)	OFF
SYMMETRY (8)	Pushed in
FREQ RANGE (4)	Desired range
FREQ dial (3)	Desired position
DC OFFSET (9)	Used if necessary
TRIG START LEVEL (6)	Index up
SET START/SWEEP (18)	SWEEP (\blacksquare)
TIME (20)	Desired range
SYMMETRY/VARIABLE (22)	Desired position
ATTENUATION (10)	Desired range

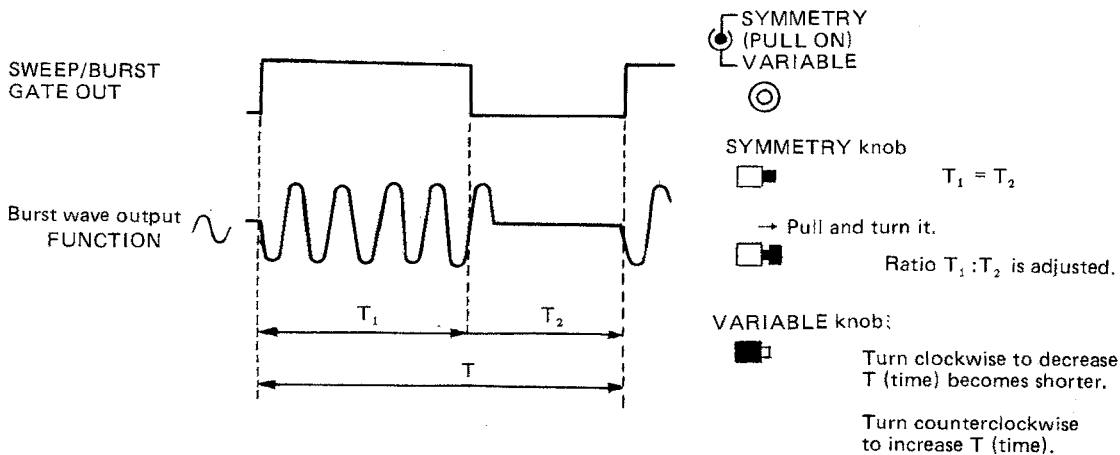

Fig. 5-7

Fig. 5-7 shows an output burst waveform. The trigger start level can be changed by using the same procedure as in 5.3 Trigger/Gate Modes.

5.5 SWEEP Mode

The sweep mode allows a linear or logarithmic sweep to be made at a sweep rate of 1 to 1:100 in a specified frequency range. The sweep time can be set from 1ms to 10s. Use the START/MOD LEVEL control (19) to set the sweep start frequency and the FREQ dial (3) to set the sweep end frequency.

The panel control settings for the sweep mode are as follows.

Panel control	Setting
MODE (5)	SWEEP
FUNCTION (7)	\sim , \wedge , or \sqcap
AM (15)	OFF
SYMMETRY (8)	Pushed in
FREQ RANGE (4)	Desired range
FREQ dial (3)	At desired sweep end frequency
DC OFFSET (9)	Used if necessary
SET START/SWEEP (18)	SET START (\blacksquare) (SWEEP \blacksquare , after a sweep start frequency setting)
TIME (20)	Desired range
SYMMETRY (22)	Pulled and turned fully clockwise
VARIABLE (22)	Desired time
LIN/LOG (15)	Desired setting
ATTENUATION (10)	Desired range

To set a sweep frequency range, connect a frequency counter or oscilloscope to the OUTPUT (11), turn the FREQ dial (3) to specify the sweep end frequency, and then specify a sweep start frequency by using the START/MOD LEVEL control (19). After the frequency range setting is made, the sweep is started when the pressed SET START \blacksquare / SWEEP \blacksquare switch (18) is pressed again and released (\blacksquare).

Fig. 5-8 shows the waveforms and their relationship.

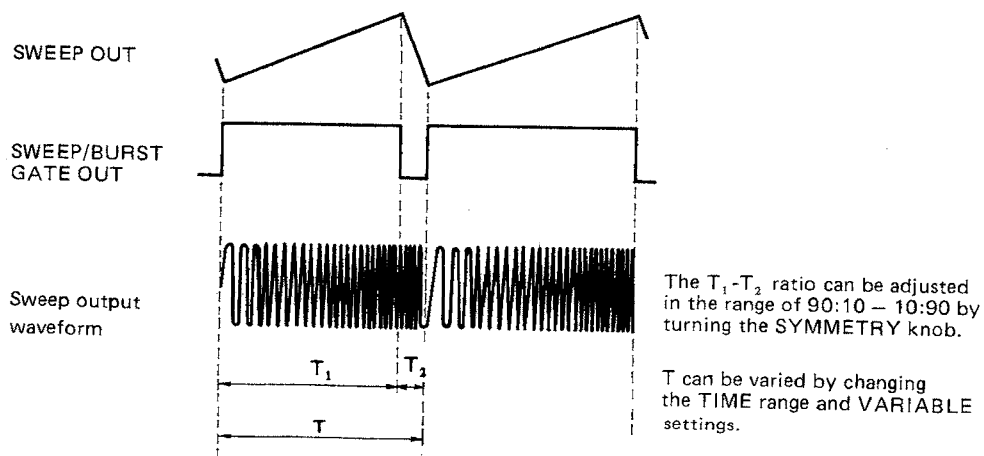

Fig. 5-8

When a sweep start frequency has been specified by using the SET START switch **■**, a sweep is started by pressing the switch. The sweep is ended at sweep completion.

5.6 Symmetry

The symmetry of output waveforms can be varied by using the SYMMETRY control **⑧**. When the control knob is pressed, output waveforms have a symmetry of 50:50. If the control knob is pulled out and turned, the symmetry can be adjusted in a range from 20:80 to 80:20. The frequency range is limited to 1MHz or less for symmetry control.

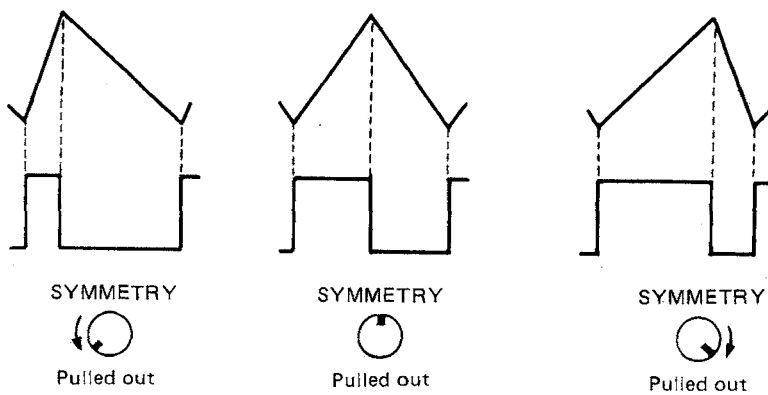

Fig. 5-9

Note: When SYMMETRY control is activated, output frequency fluctuation is increased.

5.7 DC OFFSET/DC OUT

The DC offset function enables superimposition of DC voltage on output waveforms. Superimposed voltage is limited to the waveform peak + DC with $\pm 5V$ when the output is terminated at 50 ohms. Without this termination, the voltage must be within $\pm 10V$. If all FUNCTION switches **⑦** are released (pushed out), only the DC voltage is output.

The DC offset function is activated by pulling the DC OFFSET knob **⑨** out. The knob must be turned clockwise to superimpose a positive voltage; it must be turned counterclockwise to superimpose a negative voltage. The VARIABLE knob of the ATTENUATION control **⑩** cannot be used to change the DC offset voltage, but can be used to change the amplitude of output waveforms.

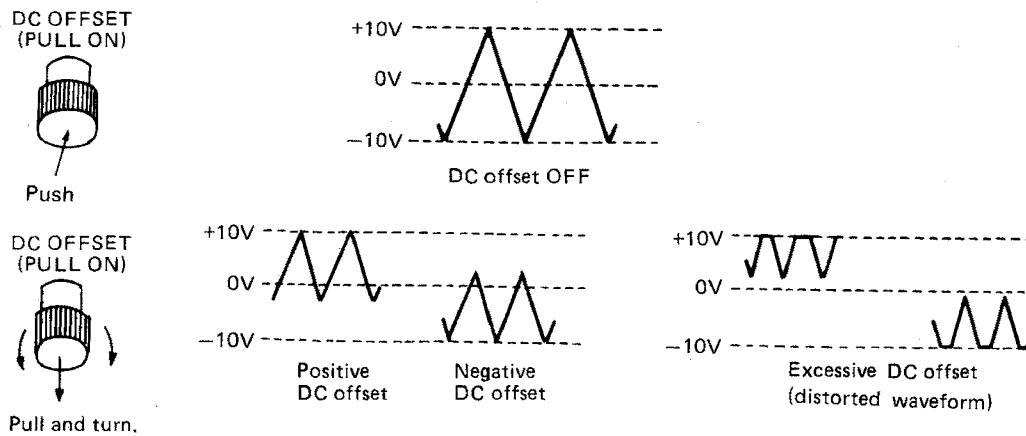

Fig. 5-10

Note: The DC offset voltage is attenuated by the attenuator (0 to 60dB). Even when the DC offset function is turned off, a residual offset voltage of several hundred millivolt (max.) remains.

The panel control setting used to output DC voltage only are as follows.

Panel control	Setting
FUNCTION ⑦	All buttons released (Push all buttons out.)
FREQ RANGE ④	Range of x100 or less
DC OFFSET ⑨	Pull the knob
ATTENUATION ⑩	0dB

A max. of ± 10 DCV output can be obtained at an open output connector by adjusting the DC OFFSET knob. Because the output impedance is set to 50 ohms, the relationship between the output voltage and max. load current is as shown in Fig. 5-11.

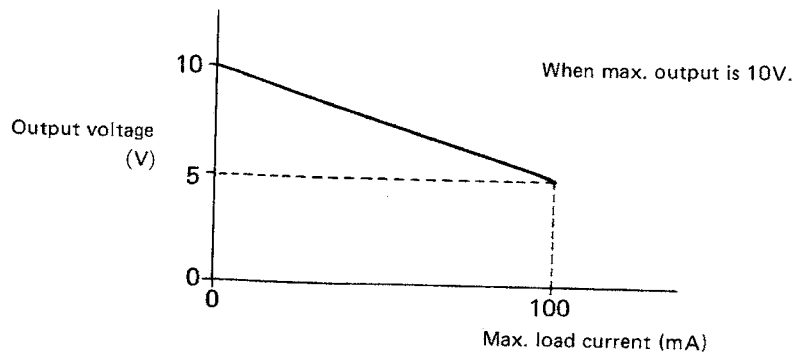

Fig. 5-11

5.8 Amplitude Modulation

The LFG-1310 provides an amplitude modulation when an external modulation signal is supplied from the MOD IN connector (16). The modulation signal frequency ranges from DC to 1MHz. The maximum input voltage required for full (100%) modulation is 5Vp-p. The input impedance is about 10k ohms. The control panel settings used for amplitude modulation are as follows.

Panel control	Setting
MODE (5)	CW
FUNCTION (7)	\sim , \wedge , or \square
AM (15)	ON
SYMMETRY (8)	Pressed
FREQ RANGE (4)	Desired range
FREQ dial (3)	Desired position
DC OFFSET (9)	Used if necessary
AM CARRIER LEVEL (21)	Desired level
MOD LEVEL (19)	Desired modulation level

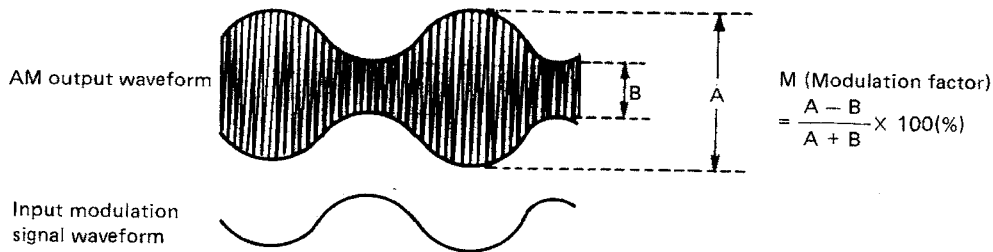
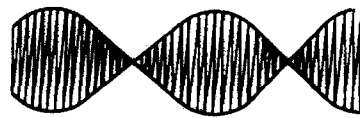

Fig. 5-12

If the AM CARRIER LEVEL (21) is turned around the middle ("0"), a double sideband with a suppressed carrier is obtained.



Double-sideband output waveform

Fig. 5-13

5.9 VCG Operation

The VCG (voltage controlled generator) provides output frequency control through the applied voltage to the VCG IN connector (14). By applying a voltage of 0 to $-5V$ to the VCG IN connector, a frequency of up to $\times 1000$ can be obtained. (The frequency multiplication of 1000 requires the FREQ dial setting to "10" and an input voltage of $-5V$.)

The frequency modulation can be achieved by sending a modulation wave to the VCG IN connector. The input impedance is about 10k ohms.

Fig. 5-11 shows the relationship between the VCG IN voltage and output frequency.

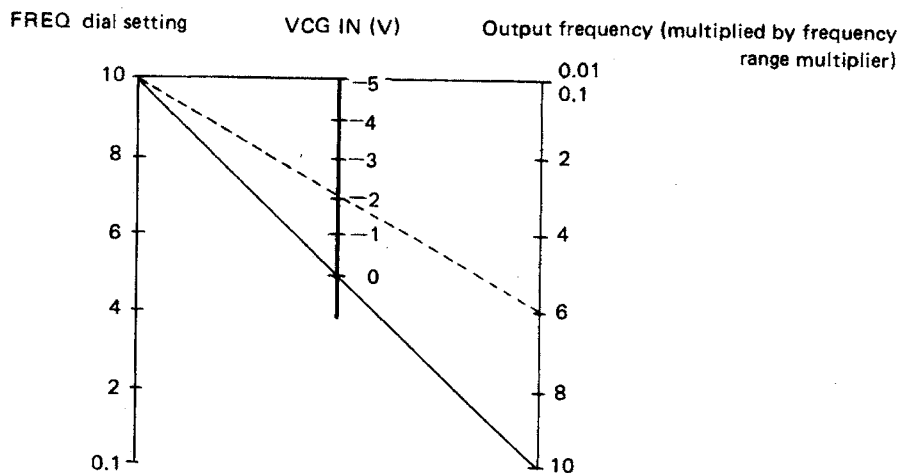

Fig. 5-14

When, for example, the frequency range is set for $\times 1k$ with a FREQ dial reading of "10" (10kHz), and $-2V$ is applied to the VCG IN connector, the output frequency is 6kHz as indicated by the dotted line in Fig. 5-14.

Note: The noise in the DC voltage or modulation signal supplied to the VCG IN may cause undesirable frequency modulation.

5.10 Combination of Functions

(1) Gated sweep

Gated sweep operation can be provided when SWEEP OUT (24) and SWEEP/BURST GATE OUT (25) are connected as follows:

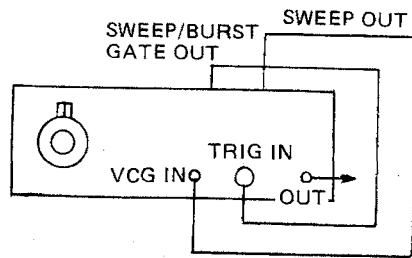

Fig. 5-15

Panel control	Setting
MODE (5)	GATE
FUNCTION (7)	\sim , \wedge , or \sqcap
AM (15)	OFF
SYMMETRY (8)	Pressed
FREQ RANGE (4)	Desired range
FREQ dial (3)	Desired position (sweep end frequency)
DC OFFSET (9)	Used if necessary
SET START/SWEEP (18)	SWEEP (\blacksquare)
TIME (20)	Desired range
SYMMETRY (22)	Pulled and turned clockwise fully
VARIABLE (22)	Desired time setting
ATTENUATION (10)	Desired range
TRIG START LEVEL (6)	Middle

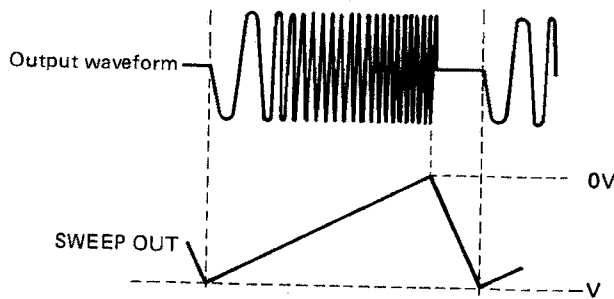

Fig. 5-16

The sweep end frequency is set by the FREQ RANGE control (4) and FREQ dial (3). When a sweep start frequency is to be changed, use external amplitude control (negative voltage) for the SWEEP OUT output.

(2) Output voltage sweep operation

An output voltage sweep is made by using the amplitude modulation of the SWEEP OUT output (24). Fig. 5-17 shows the required connections for this operation.

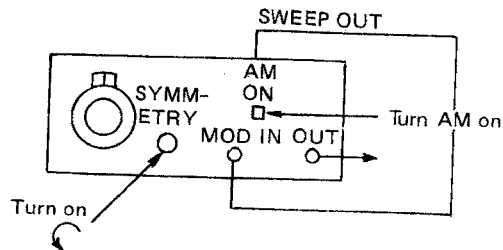
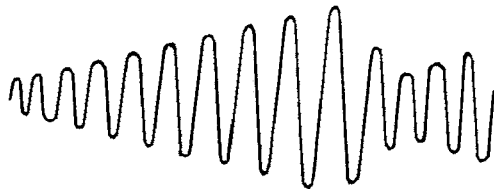

Fig. 5-17

See Section 5.8 Amplitude Modulation for details on the modulation factor adjustment.



Output waveform

Fig. 5-18

6. MAINTENANCE

The LFG-1310 is designed to provide stable operation when operated normally by users. If any parts abnormality or instrument malfunction occurs after a long period of operation, contact your dealer or our service department and request the necessary repairs/replacement.

Outer frame removal procedure:

Detach the four power cord hooks, and remove the top and bottom panels from the body.

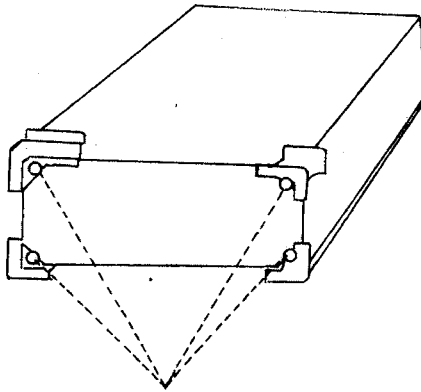

Remove the four screws.

Fig. 6-1

EVERYTHING 4 LESS



ENJOY YOUR BOOKS



**PLEASE VISIT OUR STORE FOR EVEN MORE GREAT
STUFF!**

WWW.EVERYTHING4LESSSTORE.COM

COPYRIGHT NOTICE

**ALL MATERIALS INCLUDING CD/DVD AND PDF
FILES ARE COPYRIGHTED**

**WWW.EVERYTHING4LESSSTORE.COM VON
WALTHOUR PRODUCTIONS AND MAY NOT BE
REPRODUCED, COPIED OR RESOLD UNDER ANY
CIRCUMSTANCES. YOU MAY HOWEVER MAKE A
COPY FOR YOUR OWN PERSONAL BACKUP.
MATERIALS ARE FOR PERSONAL USE ONLY.**

**IF YOU PURCHASED THIS FROM ANYWHERE BUT
FROM US PLEASE NOTIFY US IMMEDIATELY SO
THAT WE MAY CHECK IF YOU PURCHASED FROM
AN AUTHORIZED RESELLER SO WE CAN LET YOU
KNOW IF YOU NEED TO RETURN FOR FULL REFUND
FROM AN UNAUTHORIZED SELLER.**

**THANKS AGAIN AND PLEASE TAKE THE TIME TO
VISIT OUR STORE.**

ATTENTION! EVERYTHING ON SALE NOW!!



HOT SALE!

**THIS PAGE COPYRIGHT VON WALTHOUR PRODUCTIONS
WWW.EVERYTHING4LESSSTORE.COM**