

EVERYTHING 4 LESS

ENJOY YOUR BOOKS

PLEASE VISIT OUR STORE FOR EVEN MORE GREAT STUFF!

WWW.EVERYTHING4LESSSTORE.COM

COPYRIGHT NOTICE

ALL MATERIALS INCLUDING CD/DVD AND PDF FILES ARE COPYRIGHTED

WWW.EVERYTHING4LESSSTORE.COM VON WALTHOUR PRODUCTIONS AND MAY NOT BE REPRODUCED, COPIED OR RESOLD UNDER ANY CIRCUMSTANCES. YOU MAY HOWEVER MAKE A COPY FOR YOUR OWN PERSONAL BACKUP. MATERIALS ARE FOR PERSONAL USE ONLY.

IF YOU PURCHASED THIS FROM ANYWHERE BUT FROM US PLEASE NOTIFY US IMMEDIATELY SO THAT WE MAY CHECK IF YOU PURCHASED FROM AN AUTHORIZED RESELLER SO WE CAN LET YOU KNOW IF YOU NEED TO RETURN FOR FULL REFUND FROM AN UNAUTHORIZED SELLER.

THANKS AGAIN AND PLEASE TAKE THE TIME TO VISIT OUR STORE.

ATTENTION! EVERYTHING ON SALE NOW!!



HOT SALE!

10 kHz – 1.01 GHz AM/FM SIGNAL GENERATOR 2022E

Part No. 52022-950J

(Part of Signal Generator Set 52022-599L)

© Marconi Instruments Ltd. 1988
Printed in the UK

Manual part no. 46881-890E
Print code : A-9/88

CONTENTS

	Page
Preface	iii
Operating precautions	iv
Chapter 1 GENERAL INFORMATION AND DATA	1-1
Chapter 2 INSTALLATION	2-1
Chapter 3 OPERATION	3-1
Carrier frequency	3-4
RF level	3-5
Modulation	3-6
Second functions	3-10
GPIB functions	3-19
Chapter 4 BRIEF TECHNICAL DESCRIPTION	4-1
Index	v
List of tables	vi
List of figures	vi

ASSOCIATED PUBLICATIONS

Service Manual, H 52022-950J Vol. 2	Part No.
Operating Summary card	46881-891U
	46881-892Y

FIRMWARE STATUS

The operating firmware for this instrument is contained in EPROMs fitted inside the unit. The firmware version number is shown in the instrument display during the switch-on sequence.

This manual relates to instruments with firmware version no. 001

PREFACE

WARNINGS, CAUTIONS AND NOTES

These terms have specific meanings in this manual:-



WARNINGS contain information to prevent personal injury.

CAUTIONS contain information to prevent damage to the equipment.

Notes contain important general information.

HAZARD SYMBOLS

The meaning of hazard symbols appearing on the equipment is as follows:-

Symbol	Nature of hazard	Reference in manual
	Dangerous voltages	Page iv
	Beryllia	Page iv
	Static sensitive components	Page iv

MANUAL AMENDMENT STATUS

Each page in this manual bears the date of its original issue or, if it has been amended, the date and status number of the amendment. Any changes subsequent to the latest amendment status are included on Manual Change sheets coded C1, C2 etc at front of the manual.

OPERATING PRECAUTIONS

This product has been designed and tested in accordance with IEC Publication 348 – ‘Safety Requirements for Electronic Measuring Apparatus’. To keep it in a safe condition and avoid risk of injury, the precautions detailed in the WARNINGS below should be observed. To avoid damage to the equipment the precautions detailed in the CAUTIONS should also be observed.

WARNING – ELECTRICAL HAZARDS

⚠ AC supply voltage. This equipment conforms with IEC Safety Class 1, meaning that it is provided with a protective earthing lead. To maintain this protection the mains supply lead must always be connected to the source of supply via a socket with an earthing contact. Make sure that the earth protection is not interrupted if the supply is connected through an extension lead or an autotransformer.

Before fitting a non-soldered plug to the mains lead cut off the tinned end of the wires, otherwise cold flowing of the solder could cause intermittent contact.

Do not use the equipment if it is likely that its protection has been impaired as a result of damage.

Fuses. Note that there is a supply fuse in both the live and neutral wires of the supply lead. If only one of these fuses should rupture, certain parts of the equipment could remain at supply potential.

Make sure that only fuses of the correct rating and type are used for replacement. Do not use mended fuses or short-circuited fuse holders.

To provide protection against breakdown of the supply lead, its connectors (and filter if fitted), an external supply fuse with a continuous rating not exceeding 6 A should be used in the live conductor (e.g. fitted in the supply plug).

Removal of covers. Disconnect the supply before removing the covers so as to avoid the risk of exposing high voltage parts. If any internal adjustment or servicing has to be carried out with the supply on, it must only be performed by a skilled person who is aware of the hazard involved.

Remember that capacitors inside the equipment, including any supply filter capacitors, may still be charged after disconnection of the supply. Those connected to high voltage points should be discharged before carrying out work inside the equipment.

WARNING – OTHER HAZARDS

Parts of this equipment are made from metal pressing, therefore it should be handled with due care to avoid the risk of cuts or scratches.

Some of the components used in this equipment may include resins and other materials which give off toxic fumes if incinerated. Take appropriate precautions, therefore, in the disposal of these items.

⚠ Beryllia (beryllium oxide) is used in the construction of transistor TR20 in unit AB1/1. This material, if incorrectly handled, could cause a danger to health – refer to the Service Manual for safe handling and disposal precautions.

CAUTION – LCD HANDLING

When using this equipment take care not to depress the front or rear faces of the display module as this may damage the liquid crystal display elements.

CAUTION – STATIC SENSITIVE COMPONENTS

⚠ This equipment contains static sensitive components which may be damaged by handling – refer to the Service Manual for handling precautions.

Chapter 1

GENERAL INFORMATION

INTRODUCTION

The 2022E Signal Generator is supplied as part of the 52022–599L Signal Generator Set together with various accessories.

FEATURES

The 2022E is a light-weight synthesized signal generator having a frequency range of 10 kHz to 1.01 GHz and providing comprehensive amplitude, frequency and phase modulation facilities with an RF output level range of -127 dBm to +10 dBm. It is designed to cover a wide range of RF applications in development, production and maintenance. Output frequency is phase locked to an internal or external frequency standard and frequencies up to 100 MHz can be set to a resolution of 10 Hz, and above that to a resolution of 100 Hz.

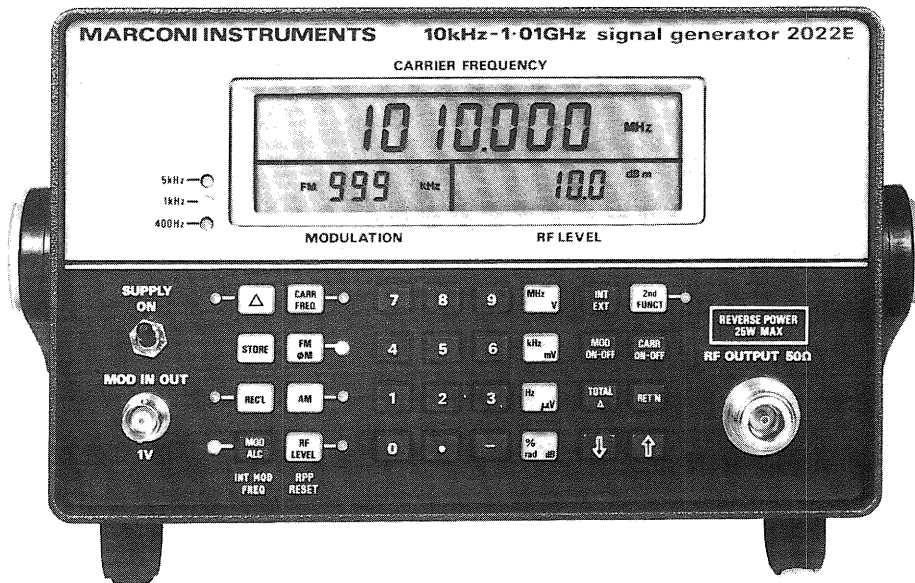

Fig. 1-1 10 kHz to 1.01 GHz Signal Generator 2022E

Front panel operation is carried out by direct entry of required settings via the keyboard. Microprocessor control ensures flexibility, simplicity of use and allows programming by the General Purpose Interface Bus (GPIB).* This enables the instrument to be used both as a manually operated bench mounted instrument or as part of a fully automated test system.

*GPIB: – Marconi Instruments General Purpose Interface Bus in accordance with IEEE Standard 488 – 1978 and IEC Publication 625-1.

Output

Calibrated output levels from -127 dBm to $+10$ dBm are provided. A choice of ten output level unit combinations can be obtained on the front panel. The RF output level can be set to a resolution of 0.1 dB over the entire output voltage range. Protection against the accidental application of up to 50 W of reverse power is provided by a fast responding relay trip. Full protection is also provided when the instrument is switched off.

An RF level offset capability allows the output level to be varied relative to the indicated value to compensate for external cable losses or to ensure that all instruments in a particular area give identical results.

Modulation

Amplitude, frequency and phase modulation can be provided from internal or external sources. AM depth can be set in 0.5% steps up to 99.5% , FM deviation up to 999 kHz and phase modulation up to 9.99 radians. An auxiliary modulation input allows dual modulation to be applied for receiver testing.

An internal modulation oscillator provides switch selected frequencies of 400 Hz, 1 kHz and 5 kHz.

Front panel

All data and units selected are visible on a single liquid crystal display. Data is entered on a keyboard that has been designed to be simple and logical to use. Carrier frequency, modulation and RF level functions may be incremented or decremented using the \uparrow (UP) and \downarrow (DOWN) keys. Non-volatile store and recall facilities are also provided using an electrically alterable read only memory that does not require a battery back-up system. A front panel cover for protecting the instrument in transit is available as an accessory.

Second function mode of operation

This enables a number of auxiliary functions such as setting the GPIB address, selection of alternative RF level calibration units, access to various calibration routines and an aid to diagnostic fault finding via the internal instrument bus.

PERFORMANCE DATA

Carrier frequency

Range:	10 kHz to 1.01 GHz.
Displayed resolution:	10 Hz up to 100 MHz. 100 Hz above 100 MHz. 1 kHz above 1000 MHz.
Selection:	By keyboard entry.
Accuracy:	Equal to the frequency standard accuracy – see under Frequency standard.
Display:	7 digit LCD – see under Keyboard and displays.

RF output

Output level range:	-127 dBm to +10 dBm. (0.1 μ V to 447 mV PD). (When AM is selected the maximum output power reduces linearly with AM depth to +4 dBm (224 mV PD) at maximum depth).
Selection:	By keyboard entry – units may be μ V, mV, EMF or PD; or dB relative to 1 μ V, 1 mV, EMF or PD; or dBm. Conversion between dB and voltage units may be achieved by pressing the appropriate unit key (dB or V, mV, μ V).
Output impedance:	50 Ω , Type N female socket to MIL 39012/3D.
VSWR:	<1.5:1 for all output levels.
Reverse power protection:	An electronic trip protects the generator output against reverse power of up to 50 W from a 50 Ω source and 25 W from a source with a VSWR up to 5:1 from DC to 1.01 GHz. For safety the output socket is automatically disconnected from the attenuator when the AC power is off. The trip may be reset from the front panel (or via the GPIB).
Output level flatness:	Better than ± 1 dB from 10 kHz to 1.01 GHz for all output levels.
Output level accuracy:	± 1 dB from 10 kHz to 1.01 GHz and levels above -10 dBm. ± 2 dB from 10 kHz to 1.01 GHz and levels below -10 dBm.
Displayed resolution:	0.1 dB or better.
Display:	4 digit LCD – see under Keyboard and displays.

Spurious signals

Harmonically related signals:	Better than -25 dBc for all carrier frequencies.
Sub-harmonics:	None for carrier frequencies below 500 MHz. -25 dBc for carrier frequencies above 500 MHz.
Non-harmonically related signals :	At offsets of 3 kHz or greater from the carrier:- <-70 dBc for carrier frequencies of 62.5 MHz and above. <-60 dB for carrier frequencies below 62.5 MHz.

GENERAL INFORMATION

Residual FM: (FM off) <7 Hz RMS (10 Hz equivalent peak) deviation in a 300 Hz to 3 kHz bandwidth at 499 MHz and improving by nominally 6 dB per octave with reducing carrier frequency down to 62.5 MHz. <3.5 Hz RMS (5 Hz equivalent peak) below 62.5 MHz.

RF leakage: <0.5 μV PD generated in a 50 Ω load by a 2 turn 25 mm loop, 25 mm or more from the case of the generator with the output level set to less than -10 dBm and the output terminated in a 50 Ω sealed load.

Frequency modulation

Range: Peak deviation from 0 Hz to 999 kHz depending on carrier frequency:

Frequency range	Available deviation
10 kHz to 125 MHz	0 to 125 kHz
125 to 250 MHz	0 to 250 kHz
250 to 500 MHz	0 to 500 kHz
500 to 1010 MHz	0 to 999 kHz

Displayed resolution: 10 Hz for deviations up to 9.99 kHz. 100 Hz for deviations from 10 kHz to 99.9 kHz.

Selection: By keyboard entry. Internal modulation (see Modulation Oscillator) or external modulation input may be selected.

Deviation accuracy: ±5% of deviation ±20 Hz at 1 kHz modulating frequency excluding residual FM.

Frequency response: ±1.5 dB from 50 Hz to 80 kHz relative to 1 kHz, using external modulation.

With ALC off the low frequency response is extended to 10 Hz with a peak deviation value limited to the lower of the value given in the table above or [0.047 x Modulation Freq. (in Hz) x {Carrier Freq. (in MHz) + 160 (if Carrier Freq. is below 62.5 MHz)}] kHz.

With ALC off can also be used for 10 Hz square wave switching with a peak deviation value limited to the lower of the value given in the table above or 0.6 times the value obtained by the formula above.

Distortion: <3% total harmonic distortion at 1 kHz modulation frequency and maximum deviation for any carrier above 250 kHz.

External modulation accuracy: With modulation ALC on, the deviation is calibrated for input levels between 0.9 V and 1.1 V RMS. A HI or LO message is indicated in the modulation display if the level is outside the range of the ALC. With modulation ALC off, the deviation is calibrated for an input level of 1 V PD.

Input impedance is 100 k Ω nominal.

Display: 3 digit LCD – see under Keyboard and display.

Phase modulation

Range: Peak deviation from 0 to 9.99 radians.

Displayed resolution: 0.01 radian.

Selection: By keyboard entry. Internal modulation (see Modulation Oscillator) or external modulation may be selected.

Deviation accuracy: $\pm 5\%$ of deviation at 1 kHz modulating frequency excluding residual phase modulation.

Frequency response: ± 1 dB from 10 Hz to 10 kHz relative to 1 kHz using external modulation input and ALC off.
 ± 1 dB from 50 Hz to 10 kHz relative to 1 kHz using external modulation input and ALC on.

Distortion: $< 5\%$ total harmonic distortion at 1 kHz modulating frequency and maximum deviation at any carrier frequency above 250 kHz.

External modulation accuracy: With modulation ALC on the deviation is calibrated for input levels between 0.9 and 1.1 V RMS. A HI or LO message is indicated in the modulation display if the level is outside the range of the ALC. With modulation ALC off the deviation is calibrated for an input of 1 V PD.

Input impedance is 100 k Ω nominal.

Display: 3 digit LCD – see under Keyboard and display.

Amplitude modulation

Range: 0 to 99.5%.

Resolution: 0.5%.

Selection: By keyboard entry. Internal modulation (see Modulation Oscillator) or external modulation may be selected.

GENERAL INFORMATION

Accuracy:	Better than $\pm(4\%$ of depth setting +1%) for 1 kHz modulating frequency and depths up to 80%.
Frequency response:	± 3 dB from 20 Hz to 50 kHz relative to 1 kHz at 80% depth using external modulation input, ALC on and DC coupled with ALC off.
Envelope distortion:	<5% total harmonic distortion at 1 kHz modulation frequency for depths up to 80%.
External modulation:	With the modulation ALC on the modulation depth is calibrated for input levels between 0.9 and 1.1 V RMS. A HI or LO message is indicated in the modulation display if the level is outside the range of the ALC. With the modulation ALC off the modulation depth is calibrated for an input of 1 V PD. Input impedance is nominally 100 k Ω DC coupled.
Display:	3 digit LCD – see under Keyboard and display.

Modulation oscillator

Frequencies:	400 Hz, 1 kHz and 5 kHz selected sequentially by repetitive pressing of the INT MOD FREQ key.
Accuracy:	$\pm 5\%$.
Distortion:	<1% total harmonic distortion.

Frequency standard

Internal standard:	10 MHz crystal oscillator.
Accuracy:	Better than $\pm 0.01\%$ at 20°C.
Temperature stability:	Better than 0.001%/°C over the temperature range 0 to 50°C.
Warm up time:	Within $\pm 0.01\%$ of final frequency after 5 minutes from switch on at ambient 20°C.

Auxiliary inputs and outputs

Modulation input/output:	A front panel BNC socket provides an output from the modulation oscillator when internal modulation is selected and becomes the external modulation input when external modulation is selected.
Internal modulation oscillator output:	1 V $\pm 10\%$ EMF from a nominal 600 Ω source impedance.

Internal modulation oscillator frequency:	400 Hz, 1 kHz or 5 kHz (see Modulation Oscillator).
Internal modulation oscillator distortion:	Less than 1% total harmonic distortion.
External modulation input:	Input level nominally 1 V into 100 k Ω – see under Frequency modulation and Amplitude modulation.
Auxiliary modulation input:	Sensitivity nominally 20% of the modulation depth/deviation set for a 1 V PD input. Input impedance 600 Ω nominal.
External frequency standard input:	A rear panel BNC socket accepts a 10 MHz signal of at least 1 V (max. 2 V) RMS into a 100 Ω nominal impedance. A 5 MHz or 1 MHz signal can be accepted by changing an internal link.
Alternative outputs:	A blanked hole is provided so that the user can fit the RF output socket to the rear panel for system use etc.
Keyboard and display	
Main and secondary keyboard functions:	These are described in Chap. 3, Operation. All instrument settings are controlled by the front panel keyboard.
Display:	Liquid crystal display provides simultaneous readout of carrier frequency, modulation and RF level.
Carrier frequency:	7-digit with annunciators to show frequency units, external frequency standard, GPIB service requests, remote operation selection and instrument addressed.
Modulation:	3-digit with annunciators to show modulation units, AM, FM, Φ M, modulation off and external modulation selected.
RF level:	4-digit with annunciators to show RF level units, RF output off, reverse power trip operated.
Modulation oscillator frequency:	3 LEDs show the currently selected modulation frequency.

GENERAL INFORMATION

GPIB interface: A GPIB interface is fitted.
All functions except the SUPPLY ON switch are remotely programmable.

Capabilities: Complies with the following subsets as defined in IEEE 488 – 1978 and IEC Publication 625-1: SH1, AH1, T6, TE0, L4, LE0, SR1, RL1, PP0, DC1, DT0, C0, E1.

Conditions of storage and transport

Temperature: -40°C to +70°C.
Humidity: Up to 90% relative humidity.
Altitude: Up to 2500 m (pressurized freight at 27 kPa differential i.e 3.9 lbf/in²).
Rated range of use: 0 to 55°C.
(Temperature over which the full specification is met)

Safety: Complies with IEC Publication 348.

Radio frequency interference: Conforms to the requirements of EEC Directive 76/889 as to limits of RF interference.

Power requirements

Voltage ranges: 94 to 121 V, 103 to 132 V, 188 to 242 V and 206 to 264 V.
Frequency: 45 to 440 Hz.
Consumption: 50 VA max.

Dimensions and Weight

Height: 152 mm (6 in)
Width: 256 mm (10 in)
Depth: 367 mm (14.5 in) (Excluding handle projection)
Weight: 7.5 kg (16.5 lb)

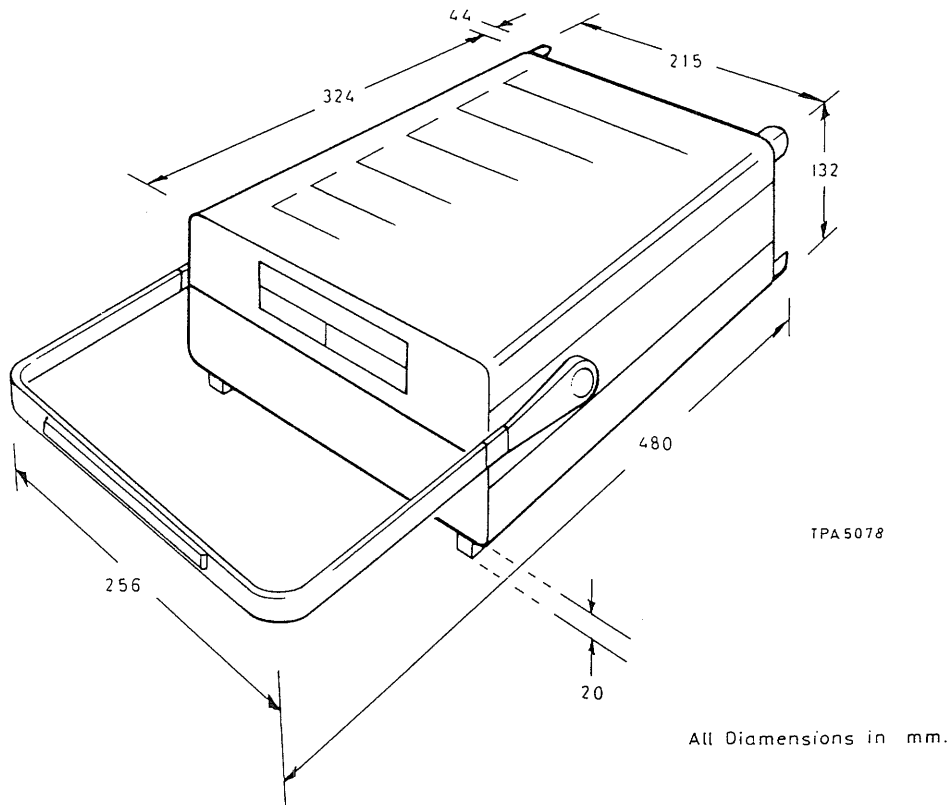

Fig. 1-2 Case dimensions (mm)

ACCESSORIES

Supplied accessories with 2022E - 52022-950J

	Part no.
GPIB Module (fitted to rear panel)	54433-003N
AC supply lead	43129-003W
Operating Manual H 52022-950J (Vol. 1)	46881-890E
Operating summary card	46881-892Y
Front panel blanking kit	46883-654E

Additional accessories supplied as part of the 52022-599L Signal Generator Set

	Part no.
Front panel protective cover	54124-023J
Coaxial adapter, type N to BNC	54311-092P
Impedance adapter 50/75 Ω (25 Ω series resistor)	54411-051X
RF coaxial cable (BNC)	43126-012S
Spare fuse kit	46884-243W

Optional accessories

	Part no.
Service Manual H 52022-950J (Vol. 2)	46881-891U
Rack mounting kit single	46883-717K
Rack mounting kit double	46883-716B
The GPIB Manual H 54811-010P (Contains details of general GPIB protocols)	46881-365R

GENERAL INFORMATION

	Part no.
GPIB lead assembly	43129-189U
Screened GPIB lead assembly (for enhanced RFI performance)	46883-962H
GPIB IEEE/IEC connector adapter	46883-408K
RF coaxial cable (N to N type)	54311-095C
Attenuator 6 dB, 500 MHz, BNC connectors	44425-002D
Attenuator 20 dB, 20 W, 1 GHz	54431-021B
Attenuator 20 dB, 1 GHz	54431-011D
Termination, 50 Ω	54422-011A

Chapter 2

INSTALLATION

UNPACKING AND REPACKING

Retain the container, packing material and the packing instruction note (if included) in case it is necessary to reship the instrument.

If the instrument is to be returned for servicing attach a label indicating the service required, type or model number (on rear label), serial number and your return address including name of contact. Pack the instrument in accordance with the general instructions below or with the more detailed information in the packing instruction note.

- (1) Place supply lead in a suitable plastic bag and tape it to the instrument's rear panel, between the rear feet.
- (2) Spread the inner "wrap-round" padded fitting flat and place the instrument into this with the carrying handle folded underneath and the four feet positioned into the four holes provided.
- (3) Wrap the instrument with the packing all around and seal the two ends together with adhesive tape.
- (4) Position the two end cushion protecting pieces at either end of the outer packing carton, then slide the instrument within its inner wrap round protection into the outer packing carton. Close and seal the outer carton.
- (5) Wrap the container in waterproof paper and secure with adhesive tape.

Mark the package FRAGILE to encourage careful handling.

Note ...

If the original container or materials are not available, use a strong double-wall carton packed with a 7 to 10 cm layer of shock absorbing material around all sides of the instrument to hold it firmly. Protect the front panel controls with a plywood or cardboard load spreader with holes drilled to avoid the projecting RF output, mod in-out sockets and the supply on-off switch; if the rear panel has guard plates or other projections a rear load spreader is also advisable.

CONNECTING TO SUPPLY

Excessive temperatures may affect the instrument's performance; therefore completely remove the plastic cover, if one is supplied over the case, and avoid standing the instrument on or close to other equipment that is hot. Before connecting the instrument to the AC supply check the position of the two voltage selector switches on the rear panel. A locking plate fixes both switches into one of four possible combinations and reveals only the selected voltage range. The instrument is normally despatched with the switches set to 230/240 V. To select a different voltage range remove the locking plate and reposition the switches to the required range as shown in Fig. 2-1 and refit the locking plate.

INSTALLATION

Note ...

The AC supply fuse may also have to be changed. An indication of the correct fuse rating is given with each displayed voltage range:-

- i.e. 0.5 A-TT (time lag) for the 105 to 120 V ranges
- 0.25 A-TT (time lag) for the 210 to 240 V ranges

The fuses are 20 mm x 5 mm cartridge type.

The spare fuse kit 46884-243W supplied with the instrument contains 4 fuses - 2 rated at 0.5 A and 2 rated at 0.25A

The free AC supply cable is fitted at one end with a female plug which mates with the AC connector at the rear of the instrument. When fitting a supply plug ensure that conductors are connected as follows:-

Earth	-	Green/yellow
Neutral	-	Blue
Live	-	Brown

When attaching the supply lead to a non-soldered plug it is recommended that the tinned ends of the lead are first cut off to avoid the danger of cold flow resulting in intermittent connections.

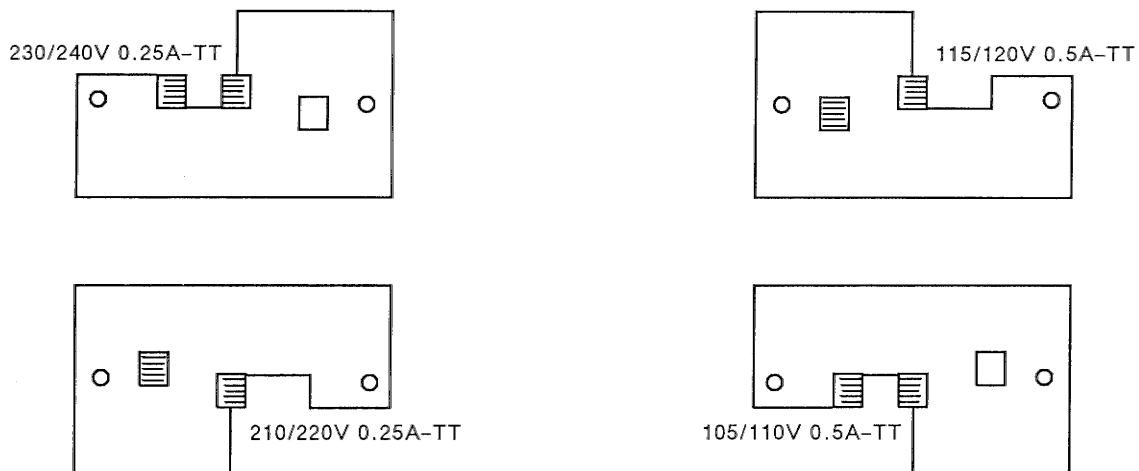

Fig. 2-1 Voltage ranges, showing switch and locking plate positions

SAFETY TESTING

Where safety tests on the AC supply input circuit are required, the following procedures can be applied. These comply with BS 4743 and IEC Publication 348. Tests are to be carried out as follows and in the order given, under ambient conditions, to ensure that AC supply input circuit components and wiring (including earthing) are safe.

(1) Earth lead continuity test from any part of the metal frame to the bared end of the flexible lead for the earth pin of the user's AC supply plug. Preferably a heavy current (about 25 A) should be applied for not more than 5 seconds.

Test limit : not greater than 0.5 Ω .

(2) 500 V DC insulation test from the AC supply circuit to earth.

Test limit : not less than 2 M Ω .

GPIB INTERFACE

The GPIB interface module is fitted to the rear panel of the instrument.

(1) The interface is ready for GPIB operation after setting the appropriate talker/listener address – see Chap. 3 : Second function 2.

(2) Connection to other equipment which has a 24-way bus connector to IEEE Standard 488 can be made with the GPIB lead assembly 43129-189U, available as an optional accessory. Where conformity with the radio frequency interference limits specified by VDE (Verband Deutscher Electrotechniker) is required, an alternative double screened GPIB lead assembly 46883-962H is available. An IEEE-to-IEC adapter 46883-408K is also available for interfacing with systems using a 25-way bus connector to IEC Recommendation 625 – see Fig. 2-2.

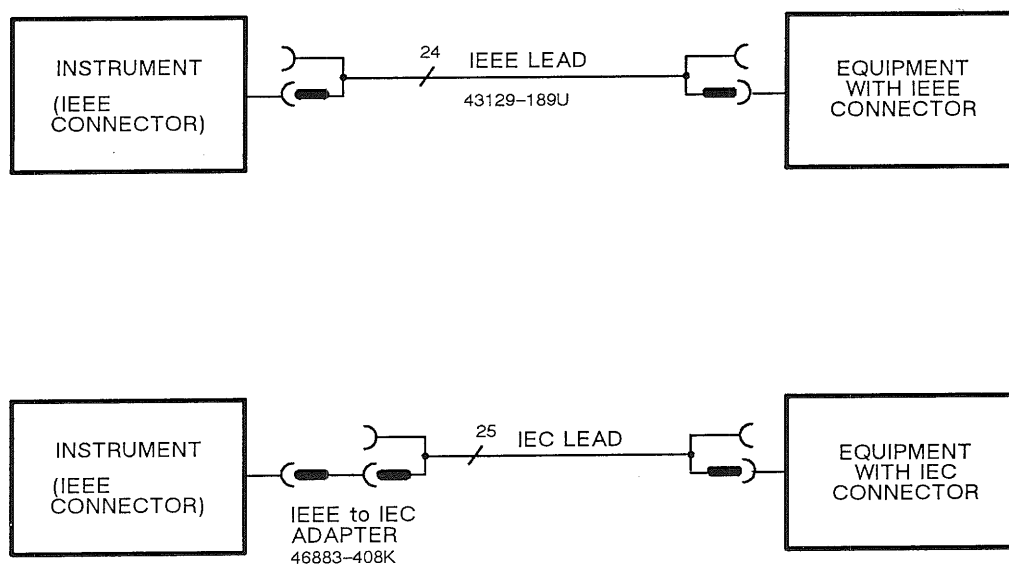

Fig. 2-2 GPIB interconnections

INSTALLATION

GPIB connector

The contact assignment of the GPIB cable connector and the device connector is as shown in Fig. 2-3.

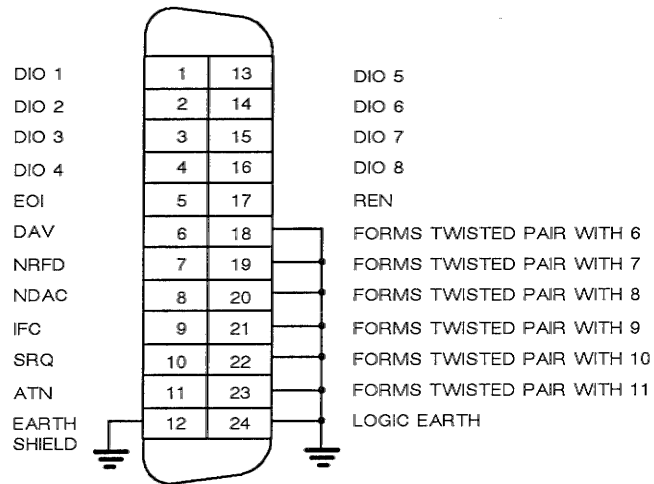

Fig. 2-3 GPIB connector contact assignments

RACK MOUNTING

The instrument may be mounted in a standard 19 inch rack as a single unit using the kit 46883-717K. This contains a pair of side angle plates wide enough to allow the instrument to sit centrally within the rack frame as shown in Fig. 2-4.

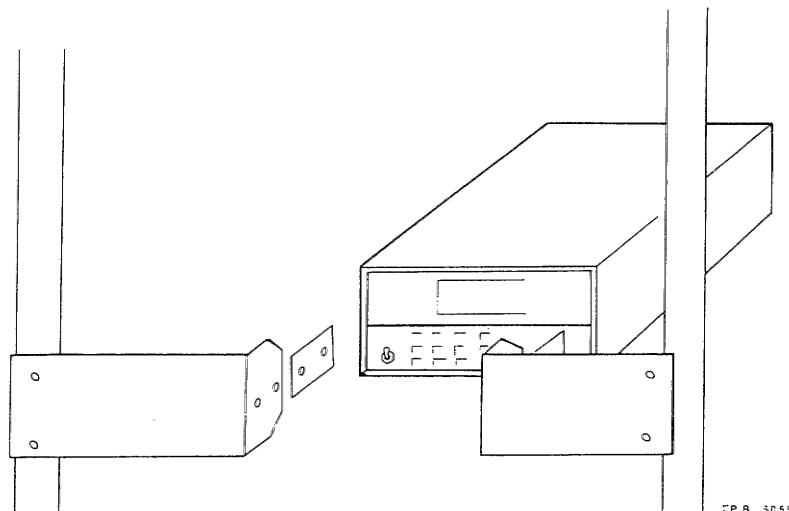

Fig. 2-4 Single unit rack mounting

For rack mounting the 2022E side-by-side with another instrument of similar modular construction, a double unit rack mounting kit 46883-716B is available. Fixings for joining the two instruments together and attaching both to the rack are shown in Fig. 2-5. For detailed information on kit parts, assembly etc., refer to the fitting instructions supplied with each rack mounting kit.

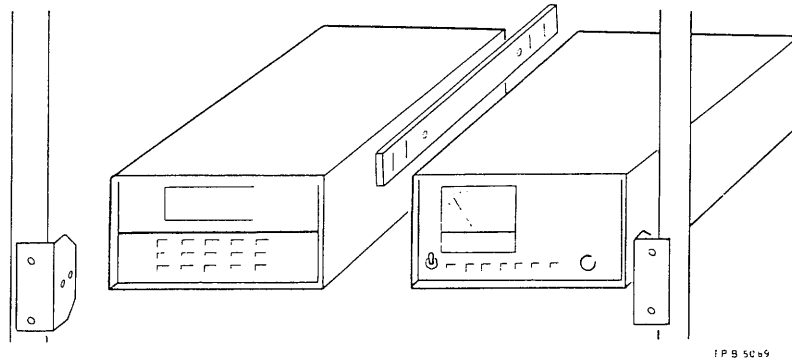

Fig. 2-5 Twinned unit rack mounting

If rear connection is required in a rack mounted system, the RF OUTPUT socket can be removed and repositioned on the rear panel – see the Service Manual for details.

Chapter 3 OPERATION

PRINCIPLES OF CONTROL

All operating functions of the generator are carried out from the front panel keyboard which is divided into five distinct colour coded areas. Remote operation from a GPIB controller is possible via the GPIB interface.

FRONT PANEL

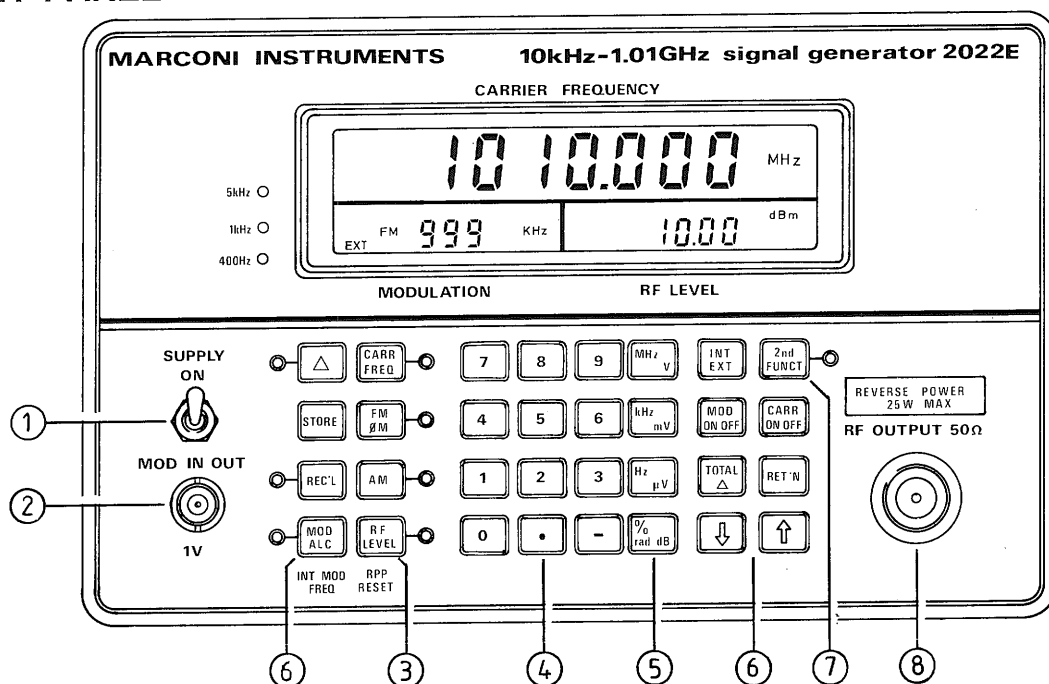

Fig. 3-1 Front panel controls

- ① **SUPPLY switch.** Applies the AC supply voltage.
- ② **MOD IN/OUT socket.** Provides a 600 Ω , nominal 1 V EMF output from the internal 1 kHz modulation oscillator or accepts a modulating input from an external source.
- ③ **Major function keys.** Six of the seven keys have an associated LED to indicate the function selected.
- ④ **Numerical keypad (brown).** For entering numerical value for the function selected, including minus sign and decimal point.
- ⑤ **Units keys (grey).** The four keys assign units of measure and also terminate the numerical entry.
- ⑥ **Miscellaneous functions (brown).** The right-hand group of seven keys is for switching the carrier and modulation on or off, incrementing/decrementing and selecting internal or external modulation. One further brown key on the left selects modulation ALC and the internal modulation frequency.
- ⑦ **2nd FUNCT (blue).** This key with its associated LED accesses additional secondary control and calibration facilities.
- ⑧ **RF OUTPUT.** 50 Ω N type output socket with reverse power protection.

REAR PANEL

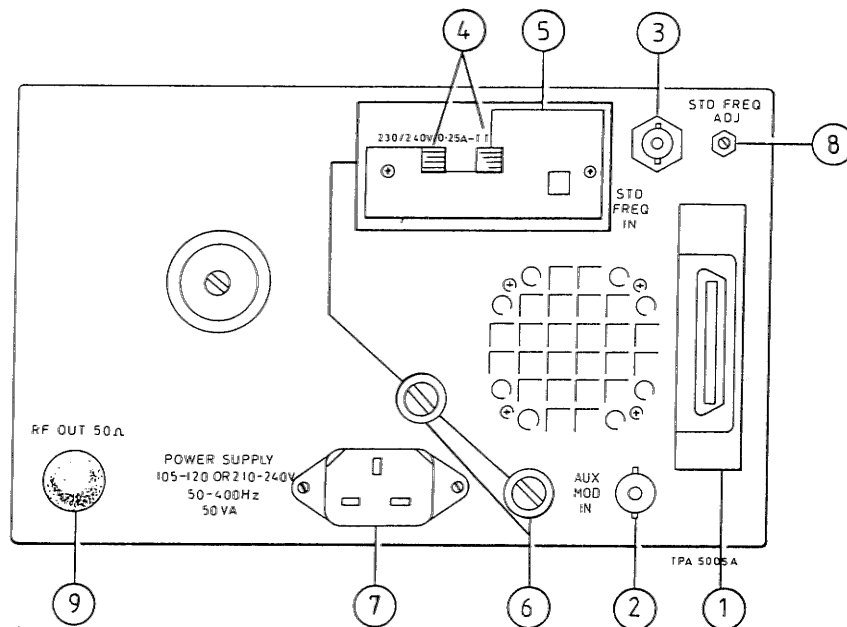

Fig. 3-2 Rear panel layout

- ① **REMOTE CONTROL GPIB INTERFACE.** This module allows remote control of the instrument. Accepts a 24-way IEEE GPIB connector.
- ② **AUX MOD IN.** A BNC socket which accepts an auxiliary external modulating signal. An input of 1 V RMS produces a secondary modulation at 20% of the indicated primary modulation.
- ③ **STD FREQ IN.** A BNC socket which allows an input from an external 10 MHz standard frequency (or 1 MHz or 5 MHz after resetting an internal link).
- ④ **VOLTAGE SELECTOR switches.** A combination of four positions which select ranges of 105/110 V, 115/120 V, 210/220 V or 230/240 V, each with a 10% tolerance to afford a complete cover over the ranges 95 to 132 V and 190 to 264 V.
- ⑤ **Selector switch plate.** Can be turned and/or reversed to secure the VOLTAGE SELECTOR switches in one of four pre-selected positions.
- ⑥ **AC fuses.** Supply input fuses are rated at 0.25 A (time lag) for the 190 V to 264 V range or 0.5 A (time lag) for the 95 V to 132 V range.
- ⑦ **AC supply input.** The AC supply is connected through this plug which mates with the connector fitted to the supply lead.
- ⑧ **STD FREQ ADJ.** Allows the internal standard to be set against a primary external standard.

CAUTION ...

Incorrect adjustment of this preset will impair the frequency accuracy of the generator and it should therefore only be adjusted by an authorized recalibration unit.

- ⑨ **RF OUT.** This blanked hole provides alternative connector locations when the instrument is rack mounted. Fitting instructions are included in Chap. 5 of the Service Manual.

PREPARATION FOR USE

(1) Switch SUPPLY ON and note that the following three display patterns appear in sequence:

(i) Instrument type no.

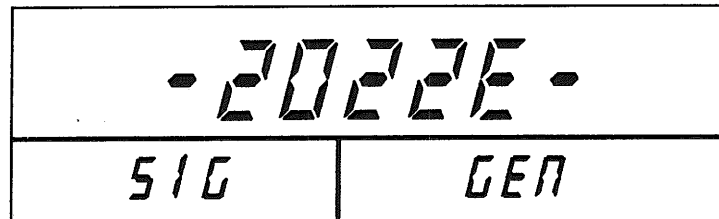

(ii) Software issue no.

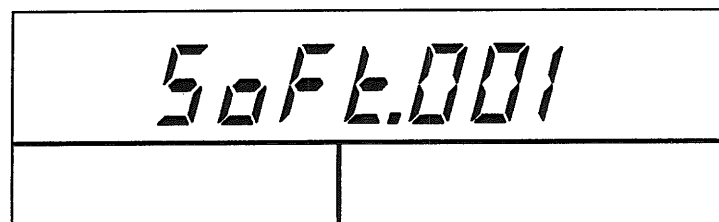

(iii) Initial operating mode

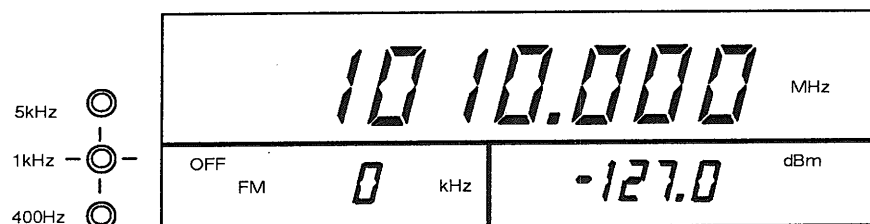

Fig. 3-3 Switch-on displays

Note ...

If second function 16 was in use before the instrument was switched off, the contents of store 10 will be recalled as the initial operating mode instead of the default conditions shown in Fig. 3-3. If store 10 contents are recalled when display blanking (second function 197) is on, none of the settings will be visible. Use REC'L 00 to obtain a visible display.

(2) Check that the CARRIER FREQUENCY window does not indicate EXT STD, unless an external frequency standard is being used. If this has been inadvertently selected error 11 will be displayed, in which case press CARR FREQ and INT/EXT keys to reselect internal frequency standard.

(3) During normal operation the instrument's internal reference standard will give an accuracy within the rated performance after a warm-up period of 5 minutes at normal ambient temperatures.

OPERATING PROCEDURES

The general procedure for selecting a numerical parameter such as frequency, modulation or RF level is to enter the following sequence:

FUNCTION (orange key) which lights the adjacent LED.

NUMERICAL VALUE (brown key) including decimal marker and negative sign if required.

UNITS (grey key) which acts as terminator.

If an error is made while keying clear the entry by re-selecting the function key. If value entered is outside the rated range, the instrument will set to the nearest end-of-range value.

CARRIER FREQUENCY

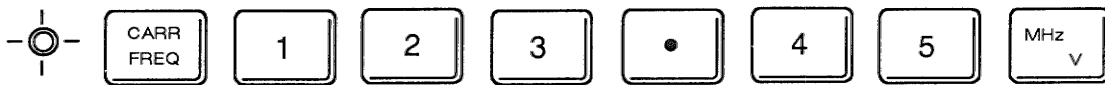

Press the orange CARR FREQ key (unless its LED is already lit). Enter the required value via the numerical key pad and note that the data entered appears in the CARRIER FREQUENCY display. Terminate the instruction by pressing the MHz, kHz or Hz key.

If the requested value of FM deviation exceeds that allowed by the new carrier frequency setting then the FM deviation sets to the maximum available for the carrier frequency selected.

Carrier on/off



The carrier may be switched off or on at any time by pressing the CARR ON-OFF key.

Internal/external frequency standard



At switch-on the instrument will set to either internal or external frequency standard, depending on its last state before switch-off. External standard control is indicated by the annunciator EXT STD in the CARRIER FREQUENCY display. Pressing the INT/EXT key will toggle between internal and external standard.

When INT is selected, the frequency is controlled by an internal 10 MHz crystal controlled oscillator.

When EXT is selected, an external 10 MHz* signal of at least 1 V RMS is required at the rear panel STD FREQ IN socket. The instrument will lock automatically to this signal.

Error no. 11 is displayed in the CARRIER FREQUENCY window if the input is of incorrect level (or not connected).

Error no. 12 is displayed if the input frequency is outside the locking range. This error message may also be displayed when the instrument is initially switched on until such time as the internal frequency standard synchronizing circuits have locked to the external frequency standard input. This will take approximately one minute. Subsequent reselections made when the instrument is at or near to its operating temperature will not incur this delay and therefore the error message will not then be displayed.

**Or 1 MHz or 5 MHz after resetting an internal link – for details see Service Manual.*

RF LEVEL



Press the RF LEVEL key and enter the required value including any decimal point or minus sign. The terminator keys give a choice of 3 linear units : volts, millivolts and microvolts and a logarithmic unit (decibels). These units can be further qualified by second function 14 – see page 3-15 – which offers the choice of EMF or PD and allows the logarithmic units to be expressed in dB μ V, dBmV or dBm.

The units in use will be shown on the RF level display. If the level requested is too high at the currently set AM depth then the RF level is set to the maximum available and a warning is given in the form of a flashing colon symbol (:) to the left of the RF LEVEL display.

Note ...

To convert an RF level indication from linear to log units or vice versa, simply press the new units key. For example, to convert an indication in mV to dBm press the dB key.

Reverse power protection

Accidental application of reverse power to the RF OUTPUT socket will trip the reverse power protection (RPP) unit and the REV PWR annunciator will flash on the RF LEVEL display. During this time the keyboard will not respond except to reset commands.

After the source of power has been disconnected reset the RPP by pressing the RF LEVEL function key. Attempting to reset the RPP with power still applied will result in the RPP tripping again.

When the instrument is switched OFF, the output socket is automatically disconnected from the output attenuator – a further safety feature.

Operation with 75 Ω loads

The performance specification for the instrument assumes operation into 50 Ω loads, but often it is desirable to work into mismatched loads. This is in general possible although an uncertainty of performance may be introduced. In the particular case of a 75 Ω load, this can be accurately matched for carrier frequencies up to 500 MHz by using the 50/75 Ω Impedance Adapter, Part No. 54411-051X. This 25 Ω series load maintains the correct (open circuit) voltage calibration and allows the reverse power protection circuit to function correctly.

MODULATION

Internal modulation source

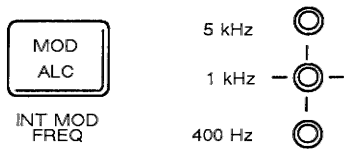

In the internal modulation mode, pressing the MOD ALC/INT MOD FREQ key causes the internal modulation oscillator to sequence through its available frequencies (400 Hz, 1 kHz and 5 kHz). Press the key repetitively until the required modulation frequency is obtained.

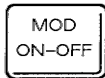

The MOD ON/OFF key controls the modulation signal in both internal and external modes.

External modulation



The instrument normally powers up in the internal mode with the 1 kHz oscillator frequency selected. To select external modulation press the INT/EXT key after selecting the AM or FM/ΦM function. This will set the EXT annunciator in the MODULATION display. Press the INT/EXT key again to return to internal modulation.

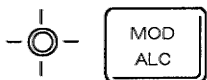

If external modulation has been selected the modulating signal can be set internally to the correct level (provided the applied voltage is between 0.9 V and 1.1 V) by pressing the MOD ALC key. If the input is outside the range of the ALC system either a HI or LO message will indicate this in the MODULATION display. Selection is indicated by the adjacent LED. The instrument will normally power up with MOD ALC off when in the external modulation mode. The modulation ALC is always on in the internal modulation mode.

Auxiliary modulation

A rear panel BNC socket (AUX MOD IN) allows an external modulation signal to be applied at the same time as the normal internal or external modulation source. A signal level of 1 V RMS at this socket will produce 20% of the indicated modulation setting. For example if the 2022E is set to produce 5 kHz deviation using the internal source and a 1 V RMS signal is applied to the AUX MOD IN socket the combined deviation will be 6 kHz.

The auxiliary modulation facility is particularly useful for tests on radio receivers when a low level sub-audible signalling tone needs to be applied in addition to the normal modulation.

Amplitude modulation



Press the AM function key (unless its LED is already lit). Enter the required value of modulation depth followed by the % terminator. If the requested value of AM exceeds that allowed by the current RF level setting then the level is reset to the maximum available for the AM depth selected and a warning is given in the form of a flashing colon symbol to the left of the RF LEVEL display.

Frequency or phase modulation

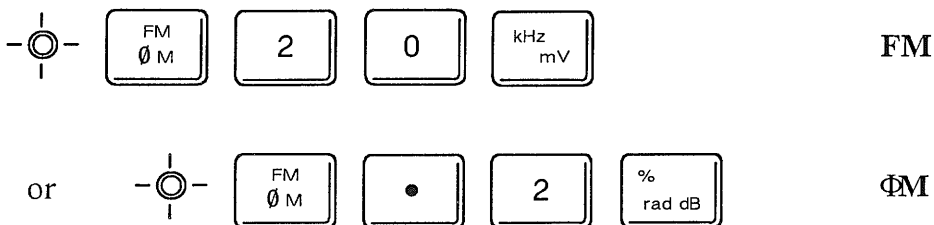

Press the FM/ΦM function key (unless its LED is already lit). Enter the required value of deviation followed by a terminator (MHz, kHz or Hz for FM; RAD for ΦM).

When the first digit of a new setting is entered both FM and ΦM annunciators are set; pressing the terminator key removes the unwanted annunciator. To change from FM to ΦM or vice versa press the FM/ΦM key again, re-enter data and re-select the required terminator key.

If the requested value of FM deviation exceeds that allowed by the current carrier frequency setting the FM deviation sets to the maximum allowable for the carrier frequency selected.

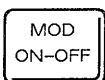

To turn FM or ΦM off whilst still retaining the current value of entered deviation, (for example in signal-to-noise ratio measurements) press the MOD ON/OFF key. The off condition is indicated by the setting of an OFF annunciator in the MODULATION display. Entering a new value of deviation will automatically restore the modulation.

INCREMENTS

Assigning increment values

To display the current set of increment values press the orange Δ (delta) key. Unless the values have been changed as below, the following default set will be displayed.

Carrier frequency: 1 kHz
 Modulation: FM 1 kHz or Φ M 0.1 rad or AM 1%
 RF level: 1dB

To return to the normal display without affecting the current increment values press any function key twice.



To change the increment value of any function press the Δ key followed by the function key; then enter the new value and the terminator. For example to select a carrier frequency increment of 10 kHz follow the sequence shown above. FM, Φ M, AM or RF LEVEL may be similarly incremented but note that for RF LEVEL increments the only valid terminator is the dB key.

Applying increments



Each press of the \uparrow (UP) key increments the function parameter by the selected value; likewise pressing the \downarrow (DOWN) key decrements by a similar amount.

Holding the UP or DOWN key pressed results in continuous incrementing or decrementing after a delay of one second.

To change from the incrementing mode to the decrementing mode without the one second delay keep the UP key continuously pressed, allowing the instrument to increment, then press the DOWN key also. When the UP key is released the instrument will immediately decrement. Similarly, to change from down to up without delay press the UP key before releasing the DOWN key, and when the DOWN key is released the instrument will immediately increment.



To find the total shift from the original setting press the TOTAL Δ key. While this key is pressed all the displays will show the total shift of each function from its starting value. To return to the initial value of the selected function press the RET'N key.

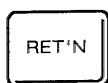

STORE AND RECALL

The instrument has 100 non-volatile stores available. Stores numbered 00 to 19 store complete instrument settings (including increment values and modulation oscillator frequency). Stores 20 to 99 store settings of carrier frequency only.

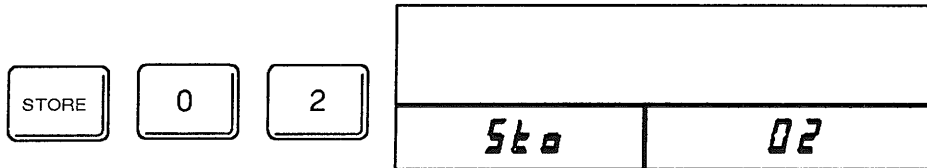

To store press STORE followed by a two-digit numeric entry. Holding the last entered digit key pressed will keep the store number on the display. The command will be executed only when the key is released.

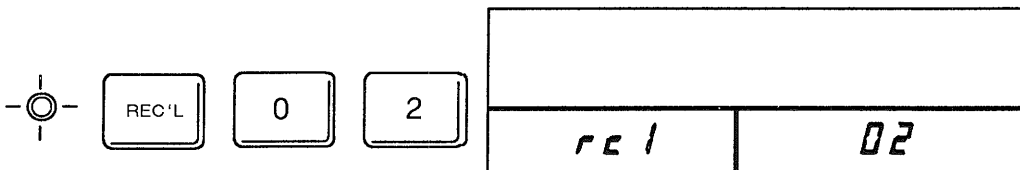

To recall press REC'L followed by the appropriate two digit numeric entry. Increment or decrement keys can then be used to sequence the recall of stores if required. Pressing the RET'N key will recall the first store selected before incrementing or decrementing took place.

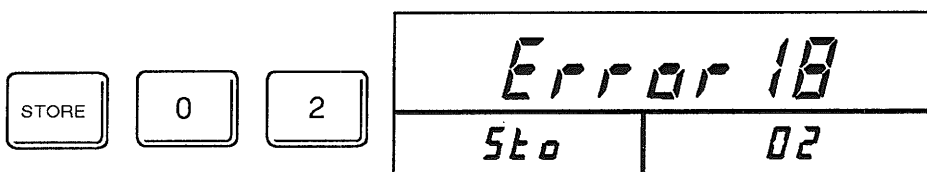

If an attempt is made to store values when second function 196 (protection of store settings) is in operation, this will not succeed and error message 18 will be displayed as shown above. A list of error numbers is given on page 3-24. Also if second function 197 (display blanking) is in operation only the numerals of the stored or recalled store will be displayed in the RF LEVEL window. Further details of second functions 196 and 197 (both of which are second degree protected) are contained in the Service Manual.

SECOND FUNCTIONS

Second function operations provide a means of controlling various secondary features and calibrations within the instrument. Access to many of these operations is generally not required during routine use of the instrument and some should only be accessed by skilled personnel during the course of realignment, fault finding or repair. There are three levels of operation as follows:

Normal operation. Second functions accessed by a single key entry (0–9) are unprotected.

First level operation. Second functions accessed by a two key entry (10–18) have first degree protection. Access to this level can be gained after operating an unlocking procedure – see ‘Second function 0’.

Second level operation. Second functions accessed by a three key entry (190–199) have second degree protection and can only be accessed by the operation of a special key code. Details of the code are given in the Service Manual.

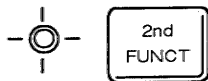

In general the second function mode is entered by pressing the blue 2nd FUNCT key followed by a number corresponding to the second function required. Pressing the 2nd FUNCT key inhibits the action of some keys, but the instrument can always be restored to its normal operating mode by pressing any of the orange function keys. This means of exit from second function operation is always safe, – it will not corrupt any data or alter any status bits, and the displays will revert to their normal functions.



No data will be permanently altered unless the STORE key is pressed. The operation of each of the secondary functions is as follows:–

Second function 0: ‘Unlock’



Switching on the instrument automatically locks all second functions that have a first or second degree of protection. Access to first level operation is obtained by the UNLOCK procedure:–

- (1) Press 2nd FUNCT and ‘0’ keys, and note that ‘0’ is displayed in the RF LEVEL window.
- (2) Then press the ↓ and MOD ALC keys simultaneously until ‘1’ is displayed in the FREQUENCY window (this will take approximately 5 seconds).

The instrument will then be unlocked to enable selection of the required second function within the first level group. If the sequence is in error, or aborted part way through, the instrument will remain locked. Once unlocked the instrument remains so until either the 2nd FUNCT and '0' keys are once more pressed or until the instrument power is switched off.

Note ...

Access to all second functions is always available over the GPIB . Access to second functions via GPIB selection should be restricted to personnel who have a full knowledge of these operations and require access to them in the course of realignment, fault finding or repair only. If inadvertent selections are made it is possible to invalidate the instrument's calibration.

Second function 1: 'Status'



Entering 2nd FUNCT followed by the numeral 1 key will result in the instrument displaying status information as shown in Fig. 3-4.

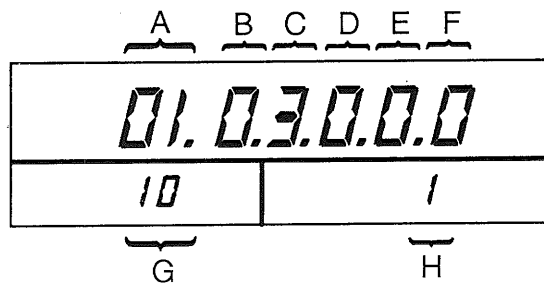

Fig. 3-4 'Status mode' display

where	A = GPIB address:	00 to 30
	B = Offsets:	'0' = off '1' = on (see second function 15)
	C = Level units code:	0 to 9 (see second function 14)
	D = Stores/offsets locking:	'0' = stores and offsets unlocked '1' = stores locked; offsets unlocked '2' = stores unlocked, offsets locked '3' = stores and offsets locked (see second function 196 in Service Manual)
	E = Display blanking of recalled stores:	'0' = off '1' = on (see second function 197 in Service Manual)

OPERATION

- F = Protection level: '0' = unprotected
 '1' = first level
 '2' = second level
- G = Ext. frequency standard: 1, 5 or 10 MHz
 (see second function 10)
- H = Indication of second function number currently selected.

GPIB data output in response to QU command when the 2022E is addressed to talk gives the following string, with '^' indicating a space:-

AA^B^C^D^E^F^GG

Second function 2: 'GPIB address setting'

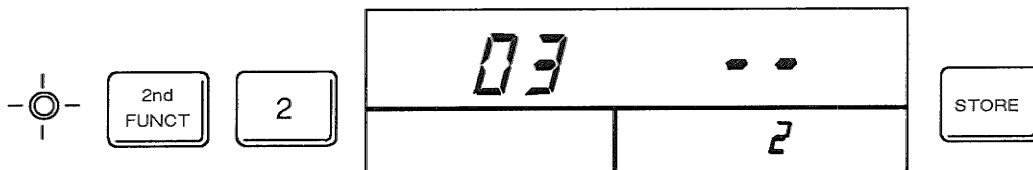

The current GPIB address is displayed in the CARRIER FREQUENCY window. If a new address is required, this may be entered via the keyboard. Numbers rotate in from the right. When the required address is displayed pressing STORE key will, if the address is acceptable (00 – 30), replace the previous one. If the address is invalid it will be ignored and the current address re-displayed. The GPIB address is stored in the non-volatile memory.

Second function 3: 'Manual latch setting'

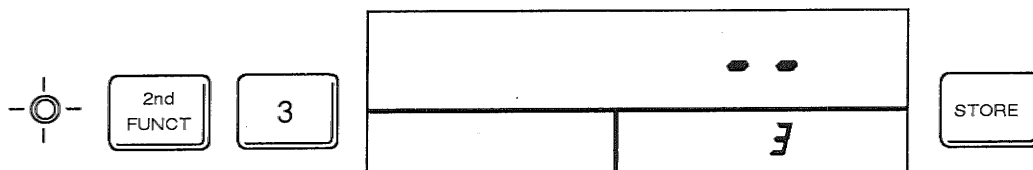

This function allows a 6 or 8 bit binary instruction to be directed to any of the instrument's internal latches for testing and fault finding. This facility is fully described in the Service Manual and is an invaluable aid when diagnosing internal instrument bus or latch faults. On exiting from second function 3 all latch data which may have been over-written is restored.

Second function 4: 'SRQ mask setting'

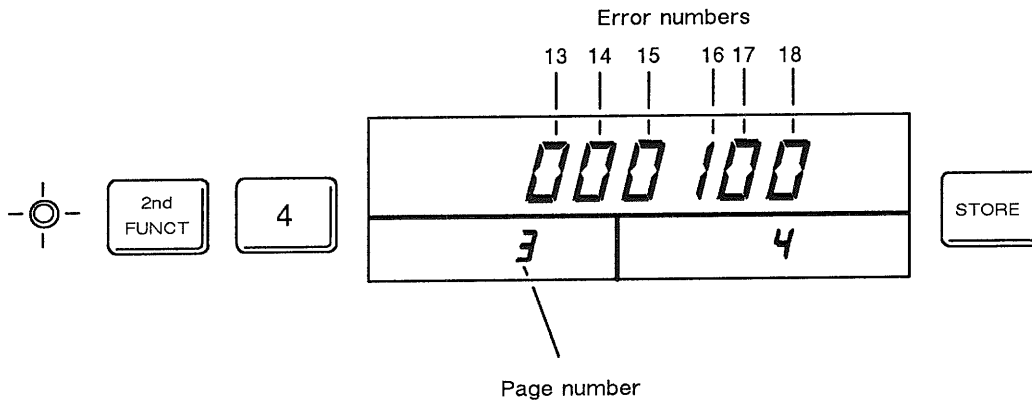

Fig. 3-5 SRQ mask setting display

Select 2nd FUNCT followed by numeral 4. The SRQ mask allows an instruction to be made for the 2022E *not* to request service over the GPIB for particular conditions. Error numbers are listed from 1 to 18 inclusive. At switch on all error numbers are unmasked '0'. Selection of second function 4 gives a six bit binary number in the frequency display.

To access all 18 error numbers three 'pages' are required. At switch on (default mode) page 1 is selected and the page number indicated in the modulation display. Error numbers 1 - 6 are represented in the frequency display, the lowest error on the left of the display.

To move to page 2 press the '.' (decimal point) key; the MODULATION display now indicates page 2 and error numbers 7 - 12 are represented from left to right. Again press the decimal point to give access to page 3 representing error numbers 13 - 18. Pressing the decimal point a further time will return you to page 1.

Ones and zeros are entered via the keyboard and rotate in from the right. Enter a bit '1' to mask the desired error and when in position press the STORE key. For more information on the significance of each digit see the paragraph - Error numbers (page 3-24). Fig. 3-5 shows the mask set to ignore a GPIB bus error (Error No. 16).

Second function 5: 'Read identity string'

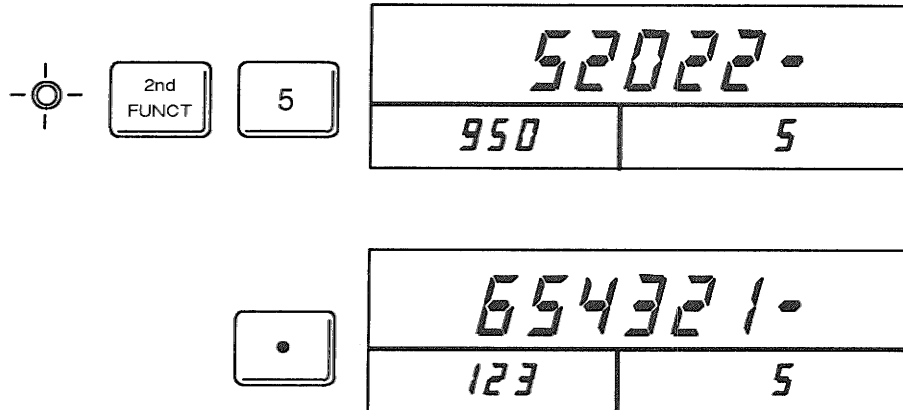

Selection of this facility enables you to confirm the instrument type number, then after pressing the decimal point, its serial number e.g. 52022-950, Ser. No. 654321-123. If QU command is sent via the optional GPIB interface the following string is put into the output buffer:

52022-950 001 654321-123

Software issue number (001), although not displayed, is inserted between type and serial number in the string.

Second function 6: 'Test display'

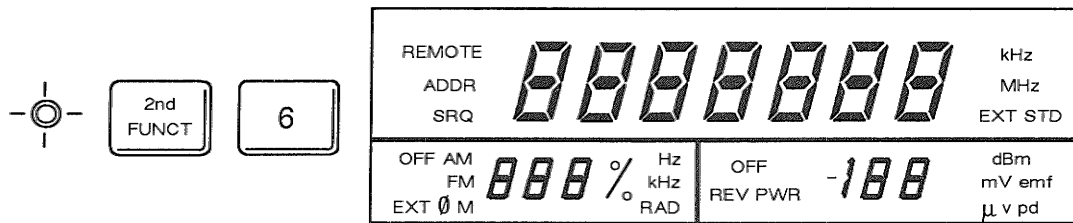

Select 2nd FUNCT followed by numeral 6. All display components are then set to give confirmation of the back-plane drive and LED operation, and also the CMOS logic and LCD segments on the CARRIER FREQUENCY, MODULATION and RF LEVEL displays.

Second function 9: 'Read elapsed time'

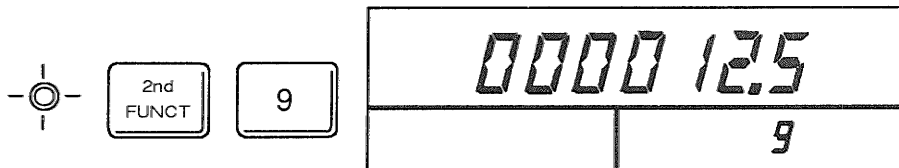

This facility enables you to observe the total number of instrument running hours from the last reset. It may be used to indicate, for instance, calibration intervals. The elapsed time is as shown above and has a resolution of 0.5 h. Display characters are not updated while being viewed. The elapsed time can be reset to zero – see Service Manual for details.

Second function 10: 'Record external frequency standard choice'

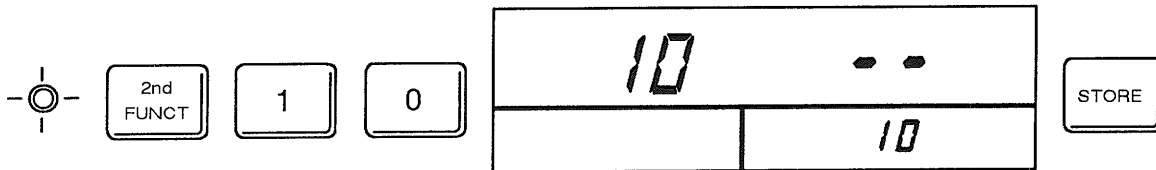

This facility enables the choice of external frequency standard (1, 5 or 10 MHz as set by the position of the internal link) to be recorded and displayed in the status display mode second function 1. Unlock the instrument to the first level of operation by means of the unlocking procedure – see second function 0. Then select 2ND FUNCT 10 followed by numeral(s) 1, 5 or 10 as appropriate and the STORE key.

Note ...

This function merely records, but does not change, the frequency accepted.

Second function 11: 'Read identity string'



This facility is the same as second function 5 and provides identical display features but is first degree protected. Unlock the instrument to the first level of operation by means of the unlocking procedure – see second function 0. Then select 2nd FUNCT followed by numerals 11.

The purpose of second function 11 is to provide compatibility with Signal Generator 2018A where an identical second function 11 facility allows commonality with GPIB controller instructions. As described in second function 5, if QU is sent via the GPIB the following string is placed in the output buffer, e.g. 52022-950 001 654321-123, to confirm the instrument type, software issue and serial number.

Second function 12: 'Write user definable string'

This is a GPIB only facility which enables you to store a string of up to 32 ASCII characters in a non-volatile memory. The second function number is displayed in the RF LEVEL display. Up to 31 ASCII characters can be accepted and then terminated by <lf>. Follow this with ST command to store,

e.g. SF12 – This is a user-defined string <cr> <lf> ST
would store 'This is a user-defined string'.

If an attempt is made to store too many characters then <lf> is automatically inserted as the 32nd.

Second function 13: 'Read user definable string'

This facility provides a means of reading back data set by means of SF12 write facility and is again a bus only facility. The second function number is displayed in the RF LEVEL display and in response to QU command places the user defined string into the GPIB output buffer.

Second function 14: 'RF level units setting'

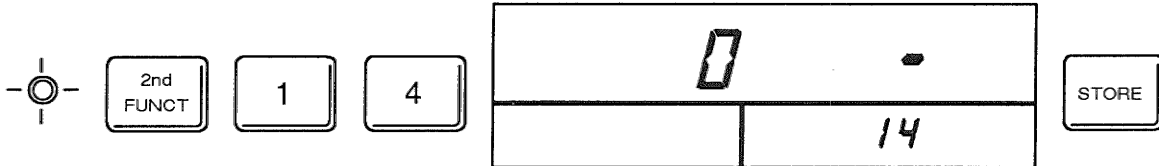

Unlock the instrument to the first level of operation by means of the unlocking procedure – see second function 0. Then select 2nd FUNCT followed by the numerals 1 and 4. On entering second function 14 a digit is displayed in the FREQUENCY window as shown above. This is the code number for the current RF level units, as shown in the table below. To change the units press the new unit code number. Then press STORE to terminate the entry.

arithmi

Unit code	Logarithmic unit	Linear unit
0	dBmV EMF	} EMF
1	dB μ V EMF	
2	dBmV PD	
3	dB μ V PD	
4	dBm	} PD
5	dBmV EMF	
6	dB μ V EMF	
7	dBmV PD	
8	dB μ V PD	
9	dBm	

Second function 15: 'RF level offsets'

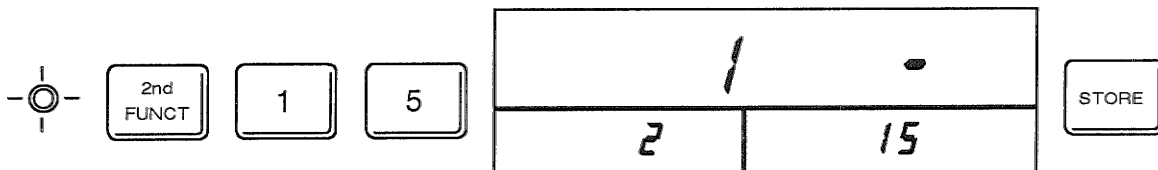

In addition to the standard calibration for RF output level, the instrument has a capability for overall level adjustment to facilitate matching with other equipment. The output level can be raised or lowered by approximately 2 dB in the offset mode. First select a carrier frequency within the chosen band followed by a suitable RF level.

Complete the unlocking procedure – see second function 0. Then select 2nd FUNCT followed by numerals 1 and 5. There are three carrier frequency bands, <250 MHz, 250–500 MHz and 500–1010 MHz, which are identified in the modulation display as 1, 2 or 3 respectively. One offset value may be set for each frequency band.



Selection of offsets 'on' is made with the numeral 1 key, or 'off' with the 0 key. Indication of the selected state is shown with either 1 or 0 in the CARRIER FREQUENCY display. Either terminate the selection by pressing the STORE key, or before doing so set a value of offset in the following manner.

Ensure offset 'on' (1) is selected and then press the ↑ (UP) key or the ↓ (DOWN) key to increment or decrement the RF level by 0.1 dB. Each successive operation of the key will increment/decrement the RF by a further 0.1 dB. When sufficient offset has been determined press the STORE key to terminate the selection which will, together with the offsets 'on' selection, remain valid until further adjustment is made.

Note ...

If error 18 appears while setting offsets, this indicates that the offset store has been protected by second function 196.

If an offset value of +0.1 dB is selected when the instrument is set to the limit of its operating range, i.e. +10 dBm or equivalent, a maximum RF level of +9.9 dBm will be displayed (a further +0.1 dB offset increment will decrease this to +9.8 dBm).

Note ...

When an offset value has been selected and stored it will remain valid for all subsequent power on sequences. RF level accuracy of the instrument may therefore be impaired and care should be taken to account for this.

Second function 16: 'Recall STORE 10 at switch on'

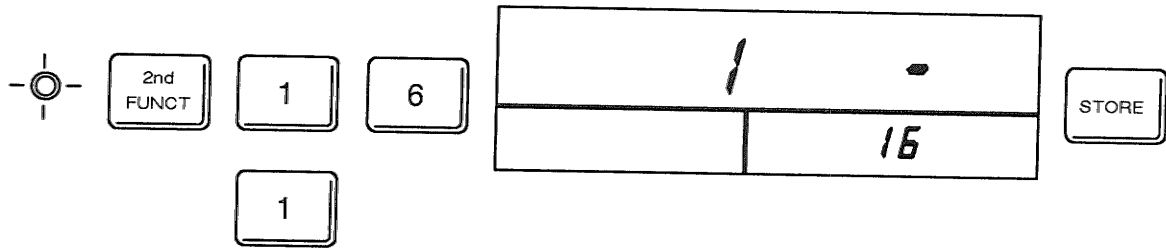

This facility allows the instrument to be operated in a remote or unattended location with a pre-selected set of conditions which will remain unchanged in the event of inadvertent switching off and on of the input supply voltage. If this were to happen in the normal operating mode, the instrument would resume the initial operating mode, that is CARRIER FREQ 1010 MHz, INT MOD with 1 kHz modulation oscillator frequency, no MODULATION and minimum RF LEVEL (-127 dBm or equivalent). These conditions can be superseded by storing the required operating conditions in STORE 10 and carrying out an automatic recall of the STORE 10 settings using the second function 16 mode.

- (1) First select the required CARRIER FREQ, MODULATION and RF LEVEL settings at the keyboard.
- (2) Press the STORE key followed by the numerals 10.
- (3) Complete the first level unlocking procedure - see second function 0. Then select 2nd FUNCT and numerals 1 and 6. Follow this by selecting the recall store 10 mode (numeral 1). Finally press the STORE key to terminate the entry.

If the supply voltage is interrupted and then restored, the instrument will automatically carry out a RECALL 10 instruction and reset to the STORE 10 conditions previously set. To disable the facility first unlock the instrument to first level operation, select 2nd FUNCT 16 followed by the numeral 0, and finally the STORE key. If second function 197 is in use all information normally shown on the front panel will be blanked. Details of this facility are given in the Service Manual.

Second functions 190 - 199: (Second level operation)

The following facilities all have second degree protection. Further information on these and details of the special key code used to unlock to this level are contained in the Service Manual.

Second Function	Facility
190	Identity string setting
191	FM tracking calibration
192	RF level calibration
193	Voltage tuned filter (VTF) calibration
194	AM calibration
195	Set checksum
196	Protection of store and offset settings
197	Display blanking of recalled stores
198	Read total instrument operating time
199	Reset elapsed time

GPIB FUNCTIONS

The GPIB interface allows the instrument to be coupled to a controller. The essential purpose of the GPIB function is described below. Further information on the general features and applications of the GPIB system can be obtained from 'The GPIB Manual' offered as an optional accessory.

The 2022E has both talker and listener capabilities. One address is used for both talking and listening and is set via the front panel or via the GPIB using second function 2. The instrument can request service (assert SRQ) on certain error conditions under the control of an SRQ mask which is set using second function 4.

SH1 : Source handshake (complete capability)

The source handshake sequences the transmission of each data byte from the instrument over the bus data lines. The sequence is initiated when the function becomes active, and the purpose of the function is to synchronize the rate at which bytes become available to the rate at which accepting devices on the bus can receive the data.

AH1 : Acceptor handshake (complete capability)

The acceptor handshake sequences the reading of the data byte from the bus data lines.

T6 : Talker function (no talk only function)

The talker function provides the 2022E with the ability to send device dependent messages over the bus to the controller. The ability of any device to talk exists only when it has been addressed as a talker.

L4 : Listener function (no listen only function)

The listener function provides a device with the ability to receive device dependent messages over the bus. The capability only exists where the device is addressed to listen via the bus by the controller.

SR1 : Service request function (complete capability)

The service request function gives the 2022E the capability to inform the controller when it requires attention.

RL1 : Remote/local function (complete capability)

The remote/local function allows the 2022E to be controlled either by the local front panel keys or by device dependent messages over the bus.

DC1 : Device clear function (complete capability)

Device clear is a general reset and may be given to all devices in the system simultaneously (DCL) or only to addressed devices (SDC). 2022E resets to the default power-up mode, that is:

OPERATION

Maximum carrier frequency (1010 MHz)
No AM, FM or Φ M
Minimum RF level (-127 dBm or equivalent)
Internal modulation
Modulation oscillator frequency 1 kHz
Increment settings:
Carrier frequency: 1 kHz
Modulation: 1 kHz FM, 0.1 rad Φ M or 1% AM
RF level: 1 dB

Note...

The instrument settings following Device Clear on Selective Device Clear are not affected by the settings of second functions 16 or 197.

Before these conditions are set, a checksum is calculated for the calibration data (FM tracking and RF level) and referred to a number held in the non-volatile memory. If this test of calibration validity fails, the instrument responds by asserting SRQ. The status byte will contain the error number 7 to signal a calibration data fault in addition to the 'SRQ asserted' bit. In order to continue with the device clear (and normal operation thereafter) the instrument must be restarted by sending any valid instruction code (e.g. "CF"). This serves only as a reset and will not be interpreted in the normal way.

E1 : Open collector drivers

The GPIB drivers fitted to 2022E have open collector, rather than tristate, outputs.

Setting the GPIB address

The instrument's talk/listen address is selected by means of second function 2. Acceptable addresses (00 to 30) can be set by this means and the instrument's internal address register will be updated by reading the address at power-on and on receipt of a device clear message. The current GPIB address is shown in the frequency display window when the interface is correctly installed.

GPIB programming codes

Functions	Miscellaneous functions
CF Carrier frequency	ST Store } followed by a
FM Frequency modulation	RC Recall } number 00-99
AM Amplitude modulation	IS Internal freq. standard
PM Phase modulation	XS External freq. standard
LV RF level	IM Internal modulation
DE Delta (Increment/Decrement)	XM External modulation
SF Second function (see note on page 3-11)	C0 Carrier off
RS Reset RPP	C1 Carrier on
QU Query - send current function setting to GPIB buffer	UP Increment up
	DN Increment down
	RT Return

Units		MOD OSC/ALC	
MZ	Megahertz	VL	Volts
KZ	Kilohertz	MV	Millivolts
HZ	Hertz	UV	Microvolt
PC	Percentage	DB	Decibel
RD	Radians		
		L0	Mod ALC off
		L1	Mod ALC on
		M0	Mod off
		M1	Mod on
		F1	400 Hz oscillator
		F3	1 kHz oscillator
		F6	5 kHz oscillator

Listening function

The 2022E is remotely controlled over the GPIB by strings of two-character codes and digits sent in upper case ASCII format. Where possible these codes correspond directly to the front panel keys; however, where the normal front panel control requires a knowledge of the previous state of the instrument (e.g. toggling controls such as on/off), special codes are provided to simplify programming.

In order to improve the readability of control strings, the codes may be separated by commas or spaces after each code pair or data group. These are ignored by the instrument. When data is entered, the syntax is the same over the GPIB as that used in control from the front panel. For example to enter a complex string of instructions such as a carrier frequency of 123.45 MHz with an increment of 25 kHz and an RF level of 1.2 μ V the string can be sent as follows:

“CF 123.45 MZ, DE CF 25 KZ, LV 1.2 UV”.

Similarly, if it is required to change the RF level units setting to dBm (second function 14, level unit code 4), the following string should be sent:

“SF 14,4, ST”.

Selection of a second function via the GPIB will result in a display of the SF number being shown in the instrument’s RF LEVEL display.

The MOD ON/OFF, CARR ON/OFF and INT/EXT controls operate on the function currently active for data entry. This may be specified, e.g. “FM M1”; “AM XM” or implied, e.g. “FM 1.5 KZ, IM” but it is recommended that the function is specified within the string to ensure that the string will always have the same result.

Talking function

On receipt of the QU command the current function setting (e.g. CF,FM) is transferred to the GPIB output buffer in a format corresponding to the GPIB commands needed to set the instrument to the current state. RF level will be displayed in log. or linear units but without a specific reference since this information cannot be re-entered directly. Increment settings are also available if QU is sent whilst in DELTA mode with a current function LED lit. The following tables give the format for each type of string.

TABLE 3-1 MODULATION STRING (18 characters)

Number of characters in field							
2	2	4	2	2	2	2	2
DE **	FM PM AM	3 digits or leading spaces plus decimal point or space	MZ KZ HZ PC RD	M0 M1	IM XM	L0 L1 **	F1 F3 F6 **

* Represents a space which is used when the field has no relevance such as the levelling field when internal modulation is selected.

e.g. DE FM 1.00 KZ M1 IM ** F3

TABLE 3-2 FREQUENCY STRING (17 characters)

Number of characters in field				
2	2	9	2	2
DE **	CF	7 digits or leading spaces plus decimal point or space	MZ KZ	IS XS

e.g. ** CF 123.4567 MZ IS

TABLE 3-3 RF LEVEL STRING (14 characters)

Number of characters in field						
2	2	1	1	4	2	2
DE **	LV	- *	1 0 *	3 digits or leading spaces plus decimal point or space	DB VL MV UV	C0 C1

e.g. ** LV * 100.0 MV C1

Provision for talking second function values can also be made by a similar use of QU when the function is engaged, the format being numeric strings only for calibration data etc., e.g. FM tracking, and a numeric string representing hours for the elapsed time indicator. Three further data strings are available, Status string, Identity string and a User string, which are accessed by means of second function controls and the QU function.

The external modulation input level status indicated by the modulation window HI and LO is also accessed. The current status, if outside the specified limit, is transferred to the GPIB output by means of an error message which may be accessed by carrying out a serial poll:

Error No. 9 – input too low
 Error No. 10 – input too high

Requesting a string to be output will overwrite any string data waiting to be sent. Addressing the instrument to talk without specifying a string to be sent or re-addressing to talk after a string has been completed will result in an error (and SRQ if not masked).

SF1, QU Status string

When accessed by SF1, QU the status of the instrument is sent to the controller, each data field being delimited by one space in the following format:-

XX	X	X	X	X	X	X
GPIB	OFFSETS	LEVEL	STORES	DISPLAY	PROTECTION	FREQ STD
ADDRESS	ON/OFF	UNITS	OFFSETS	BLANKING	LEVEL	1,5 or
		CODE	LOCKING			10 MHz

GPIB address:	00 to 30
Offsets:	‘0’ = off ‘1’ = on
Level units code:	0 to 9 (see second function 14)
Stores/offsets locking:	‘0’ = stores and offsets unlocked ‘1’ = stores locked, offsets unlocked ‘2’ = stores unlocked, offsets locked ‘3’ = stores and offsets locked (see second function 196 in Service Manual)
Display blanking of recalled stores:	‘0’ = off ‘1’ = on (see second function 197 in Service Manual)
Protection level:	‘0’ = unprotected ‘1’ = first level ‘2’ = second level
Ext. frequency standard:	1, 5 or 10 MHz (see second function 10)

SF11, QU Identity string (read only)

The identity string accessed by SF11, QU allows instrument type number, software issue number and serial number to be read by the controller. The information is stored in non-volatile memory. The string is displayed as described in second function 11. Each data field is delimited by one space.

SF12, User string write facility

Up to 32 ASCII characters can be stored in non-volatile memory by the user. This bus only facility is useful for recording such information as the date the next calibration is due, test gear numbers etc. The string is terminated by the LINEFEED character <lf>, (ASCII code 10) which is included as the last character stored. If an attempt is made to store too many characters then <lf> is automatically inserted as the 32nd.

SF13, QU User string read facility

This facility provides a means of reading back data set by means of SF12 write facility and is again a bus only facility.

Service requests (SRQ)

The 2022E can request service to warn the controller of certain error conditions. In response to a serial poll after asserting the SRQ line, the 2022E will provide a status word (8 bits) in which bit 6 is set to indicate an SRQ request and the first five bits (0 to 4) indicate an error number. The error number is also displayed briefly in the carrier frequency window. Errors 06 and 08 will result in the instrument not functioning. Error 07 can be overridden with a restart command (any function code or digit).

Error numbers

No.	Error condition	Action taken
00	NO ERROR	
01	REQUEST OUTSIDE LIMITS	
02	INCORRECT KEY CODE SEQUENCE	
03	TOO MANY DIGITS	
04	INCORRECT UNIT	
05	RPP TRIP	Wait for reset instruction (RS)
06	RAM CHECK FAILURE (IC9)	
07	EAROM CHECKSUM FAILURE (IC10)	Wait for restart instruction (any function code or digit)
08	EPROM CHECKSUM FAILURE (IC5-IC8)	
09	EXTERNAL MODULATION OUTSIDE ALC RANGE (LOW)	
10	EXTERNAL MODULATION OUTSIDE ALC RANGE (HIGH)	
11	EXT STD SELECTED BUT NOT APPLIED	None

No.	Error condition	Action taken
12	EXT STD FREQ NOT LOCKING	None
13	LATCH WRITE ERROR	
14	EAROM WRITE ERROR	
15	EAROM RECALL ERROR	
16	GPIB BUS ERROR	
17	UNRECOGNIZED GPIB MNEMONIC/ CHARACTER	Ignore both characters: e.g. if the string "P,CF,M0" was received, the P,C would result in error 17 being displayed and the rest of the string would be inter- preted as "FM,0".
18	ATTEMPT TO WRITE TO PROTECTED STORE	

SRQ mask

The SRQ response to the errors listed above can be suppressed by setting a 3-page 6-bit mask, via second function 4. The bits of the mask refer directly to the errors, i.e. the left-most bit set indicates no response to error 1, the second from left no response to error 2, etc.

The mask is displayed by selection of second function 4, and may be changed by entering '1's and '0's via the keyboard. The STORE key is pressed to finalize a change. The SRQ mask is not stored in the non-volatile memory when power is removed. When the instrument is initially switched on the mask is set to all '0's.

Reverse power protection

When tripped by an overload applied to the RF OUTPUT socket, the GPIB SRQ line is asserted, and the status byte (obtainable by the controller conducting a serial poll) will contain the value 69 (decimal). The RPP can be reset via the bus by sending the RS command.

Note ...

If error 05 has been masked using second function 4 the service request action will not be initiated.

Clear, switch on, and return to local

SDC and DCL clear 2022E to the following state:-

Maximum carrier frequency (1010 MHz)

No AM, FM or Φ M

Minimum RF level (-127 dBm or equivalent)

Internal modulation

Modulation oscillator frequency 1 kHz

Increment settings:

Carrier frequency: 1kHz

Modulation: 1 kHz FM, 0.1 rad Φ M or 1% AM

RF level: 1 dB

To revert from GPIB to front panel control, press the RET'N key.

OPERATION

If a local lock out command has been given the RET'N key operation will be ignored.

Notes ...

- (1) INT/EXT frequency standard selection, the GPIB address and instrument stores are unaffected by the SDC and DCL commands.
- (2) Switching on clears the 2022E to the same state as SDC or DCL unless 'Recall STORE 10 at switch on', conditions apply.

Chapter 4

BRIEF TECHNICAL DESCRIPTION

Frequency synthesizer and signal processing

2022E is a synthesized AM, FM or phase modulated signal generator covering a frequency range of 10 kHz to 1 GHz. Frequencies in the range 250 to 500 MHz are generated from two voltage controlled oscillators. In the range 62.5 to 250 MHz signal frequencies are obtained by divider circuits and in the range 10 kHz to 62.5 MHz by a beat frequency oscillator system. A frequency doubler is used to cover the band 500 to 1010 MHz.

The output frequency is phase locked to a frequency standard and frequencies up to 100 MHz can be set to a resolution of 10 Hz. Above 100 MHz the resolution is 100 Hz. A fractional division scheme allows this resolution to be obtained whilst still keeping the phase locked loop bandwidth reasonably high. Provision is also made for the use of an external frequency standard when this is preferred. Frequencies of 10, 5 or 1 MHz can be used depending on the position of an internal link.

Note...

A full technical description appears in the Service Manual H 52022-950J (Vol. 2) part number 46881-891U.

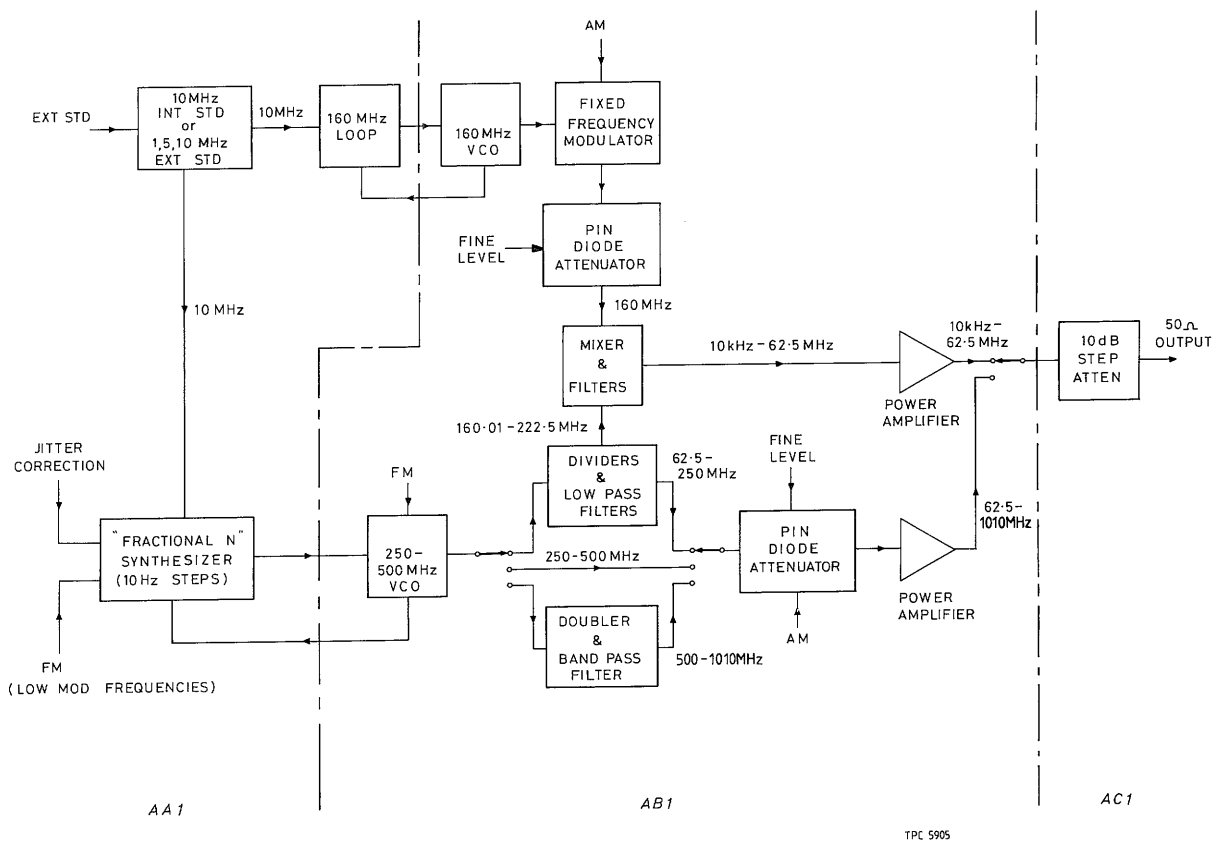

Fig. 4-1 Block schematic diagram

Output

Calibrated output levels from -127 dBm to $+10$ dBm are provided. A combination of ten output level calibration units can be selected on the front panel. The RF output level can be set to a resolution of 0.1 dB over the entire output voltage range with a total cumulative accuracy of ± 2 dB. A precision attenuator provides 120 dB in 10 dB steps and is a self contained module. Three 30 dB, one 20 dB and one 10 dB pad are used, each operated by TO5 relays. 16 dB of fine level control is provided by PIN diode attenuators.

Modulation

Amplitude, frequency and phase modulation can be provided internally from a modulation source at a frequency of 400 Hz, 1 kHz or 5 kHz.

Amplitude modulation. For carrier frequencies greater than 62.5 MHz, modulation depths up to 80% are obtained using PIN diode attenuators and envelope feedback. At carrier frequencies less than 62.5 MHz a fixed frequency modulator operating at a frequency of 160 MHz allows up to 95% depth of modulation. AM is DC coupled.

Frequency modulation. FM is created by applying the modulation signal to varactor(s) in the 250 to 500 MHz oscillator. Simultaneous modulation of the reference frequency prevents fall off in response below the loop bandwidth. FM off (CW mode) gives the lowest residual FM noise. The low frequency response is tailored to optimize the modulation accuracy of low frequency square waves.

Phase modulation. This is obtained using a differentiator in the modulation signal path and then applying the treated signal in the same manner as for FM.

Modulation signal ALC. This is always in circuit when internal modulation is in use and may be selected when switched to external modulation. The circuit uses a JFET and allows up to 10% error in a 1 V input before a HI or LO message in the modulation display indicates that the applied modulation signal level is outside the range of the ALC.

Control

Front panel operation is carried out by direct entry of required settings via the keyboard. Microprocessor control ensures flexibility, simplicity of use and allows programming by the General Purpose Interface Bus (GPIB). This facility allows the instrument to be used both as a manually operated bench mounted instrument or as part of a fully automated test system.

INDEX

	Page
A	
AC supply connection	2-1
Accessories	1-9
Amplitude modulation	3-7
Auxiliary modulation	3-7
C	
Carrier frequency setting	3-4
Carrier on/off	3-4
Connecting to supply	2-1
D	
Display blanking	3-3
F	
Features	1-1
Firmware status	ii
Frequency standard int/ext	3-4
Frequency modulation	3-7
Front panel controls... ..	3-1
Functional description	4-1
Fuses	2-2
G	
General purpose interface bus (GPIB)	3-19
Address setting	3-20
Connector pin assignments	2-4
Error numbers	3-24
Interface fitting	2-3
Listening function	3-21
Programming codes	3-20
Return to local command	3-25
Service requests	3-24
Strings	3-23
Talking function	3-21
I	
Increments	3-8
M	
Modulation ALC	3-6
Modulation int/ext	3-6
Modulation oscillator	3-6
O	
Operating precautions	iv
P	
Performance data	1-2
Phase modulation	3-7
Preparation for use	3-3
Principles of control... ..	3-1

	Page
R	
Rack mounting	2-4
Rear panel layout	3-2
Reverse power protection	3-5
RF level setting	3-5
S	
Safety precautions	iv
Safety testing	2-2
Second functions	3-10
GPIB address setting	3-12
Manual latch setting	3-12
Read elapsed time	3-14
Read identity string	3-14,15
Read user definable string	3-16
Recall STORE 10 at switch on	3-18
Record ext. freq. std. choice	3-15
RF level offsets	3-16
RF level units setting	3-16
Second level operation	3-18
SRQ mask setting	3-13
Status	3-11
Test display	3-14
Unlock	3-10
Write user definable string	3-15
Store and recall	3-9
Switching on	3-3
U	
Unpacking and repacking	2-1
75 Ω load operation	3-6

LIST OF TABLES

TABLE

3-1 GPIB modulation string	3-22
3-2 GPIB frequency string	3-22
3-3 GPIB RF level string	3-22

LIST OF FIGURES

Fig.

1-1 10 kHz to 1.01 GHz Signal Generator 2022E	1-1
1-2 Case dimensions	1-9
2-1 Voltage ranges, showing switch positions	2-2
2-2 GPIB interconnections	2-3
2-3 GPIB connector contact assignments	2-4
2-4 Single unit rack mounting	2-4
2-5 Twinned unit rack mounting	2-5

								Page
3-1	Front panel controls	3-1
3-2	Rear panel layout	3-2
3-3	Switch-on displays	3-3
3-4	Status mode display	3-11
3-5	SRQ mask setting display	3-13
4-1	Block schematic diagram...	4-1

EVERYTHING 4 LESS



ENJOY YOUR BOOKS



PLEASE VISIT OUR STORE FOR EVEN MORE GREAT STUFF!

WWW.EVERYTHING4LESSSTORE.COM

COPYRIGHT NOTICE

ALL MATERIALS INCLUDING CD/DVD AND PDF FILES ARE COPYRIGHTED

WWW.EVERYTHING4LESSSTORE.COM VON WALTHOUR PRODUCTIONS AND MAY NOT BE REPRODUCED, COPIED OR RESOLD UNDER ANY CIRCUMSTANCES. YOU MAY HOWEVER MAKE A COPY FOR YOUR OWN PERSONAL BACKUP. MATERIALS ARE FOR PERSONAL USE ONLY.

IF YOU PURCHASED THIS FROM ANYWHERE BUT FROM US PLEASE NOTIFY US IMMEDIATELY SO THAT WE MAY CHECK IF YOU PURCHASED FROM AN AUTHORIZED RESELLER SO WE CAN LET YOU KNOW IF YOU NEED TO RETURN FOR FULL REFUND FROM AN UNAUTHORIZED SELLER.

THANKS AGAIN AND PLEASE TAKE THE TIME TO VISIT OUR STORE.

ATTENTION! EVERYTHING ON SALE NOW!!



HOT SALE!

**THIS PAGE COPYRIGHT VON WALTHOUR PRODUCTIONS
WWW.EVERYTHING4LESSSTORE.COM**