



SHENZHEN KIRISUN ELECTRONICS CO.,LTD



Professional Two-way Radio

PT3600

**FM HANDHELD TRANSCEIVER
INSTRUCTION MANUAL**







INSTRUCTION MANUAL

PT3600

FM HANDHELD TRANSCEIVER

We are very grateful for your purchasing  brand two-way radios produced by Shenzhen Kirisun Electronics Co., Ltd.

We believe  two-way radio, which always incorporates the latest technology, can bring great convenience to your life and work;

We also believe that the quality and function of  two-way radio can meet your demands for reliable communication.

Notice to the User:

- * Government laws prohibit radio communication without permission in government districts.
- * Illegal operation is subject to punishment by fine and/or imprisonment.
- * Refer service to the well-trained professional technicians only.

Safety

It is important that user is aware of and understands hazards common to the operation of any radios.

Warning!

Turn off your radio before entering any area with a potentially explosive atmosphere (where the air contains gas, dust and smog, etc.), such as while taking on fuel, or while parking at a gasoline service station.

Attentions:

Please comply with the following attentions to avoid

fire, bodily injury and damage to the radio.

- * Long time transmitting or continuous working in high power mode will make the rear side of the radio generate heat.
- * Please do not disassemble or assemble the radio under any circumstance.
- * Please do not expose the radio to direct sunlight for a long time; do not place the radio near any heating device, either.
- * Please do not put the radio in extremely dusty, moist or dabbling places; do not place it on any unstable surface, either.
- * If the radio emits smoke or strange odors, turn it off and remove the battery from the radio and contact your local authorized Kirisun dealer without delay.

Content

1. Unpacking and Checking.....	2	6. Scan Function.....	12
2. Preparation.....	3	7. Auxiliary Functions.....	13
2.1 Charging the Battery.....	3	7.1 Time-Out Timer (TOT).....	13
2.2 Installing/Removing the Battery.....	4	7.2 Busy Channel Lockout (BCL).....	14
2.3 Installing the Antenna.....	5	7.3 Battery Saving.....	14
2.4 Installing the External Speaker/MIC.....	6	7.4 Low Battery Warning.....	14
2.5 Installing/Removing the Belt Clip.....	6	7.5 Monitor.....	14
3. Radio Overview.....	7	7.6 CTCSS/DCS.....	15
4. Basic Operations.....	8	7.7 PTT ID.....	15
4.1 Switching On.....	8	8. Troubleshooting.....	16
4.2 Adjusting the Volume.....	8	9. Major Specifications.....	18
4.3 Selecting a Channel.....	9	10. Status Setting.....	18
4.4 Sending a Call.....	9		
4.5 Receiving a Call.....	9		
5. Functions of Programmable Buttons.....	10		

1. Unpacking and Checking

Unpack the radio carefully. We recommend that you check the radio and the supplied accessories listed in the following table before discarding the packing material. If any damage or loss has occurred during shipment, please contact the dealer without delay.

Supplied Accessories

Item	Quantity
Antenna	1
Li-Poly Battery	1
Belt Clip	1
Charger	1
Power Adapter	1
Hand Strap	1
Instruction Manual	1

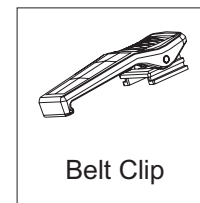
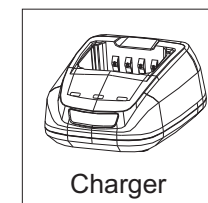
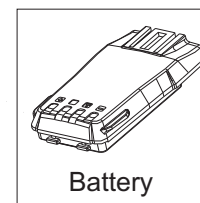
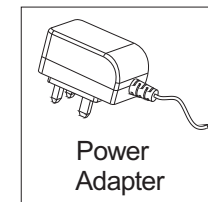
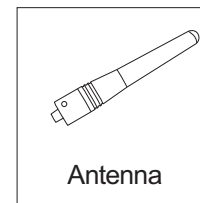

2. Preparation

2.1 Charging the Battery

Plug the power adapter into an applicable AC outlet and connect the power adapter to the battery charger. The green LED will light up.

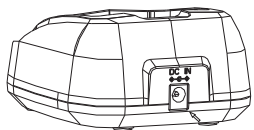

Insert the battery to be charged or the radio into the charger slot.

Make sure the battery is well connected with the charger. Then the red LED will light up, and the green LED will be out, which indicates that the charging starts.

After about 3~4 hours of charging, the red LED will be out, and the green LED will light up, which indicates

that the battery is fully charged, then you can remove the battery from the charger.

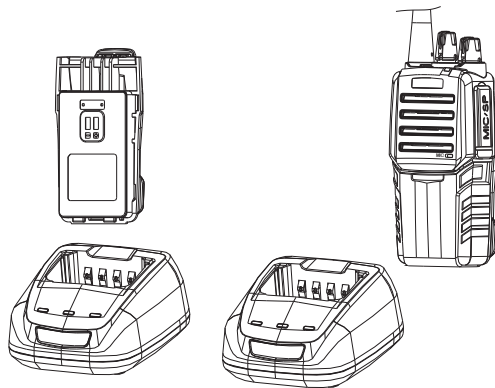

Note:

- The radio battery is not fully charged in the factory. Before the initial use, please charge the new battery.
- KB-31A Li-poly battery of Kirisun is applicable to this radio.
- When charging the battery for the first time after purchase or long-time storage (over 2 months), please repeat charging several times for the battery to achieve normal capacity.
- Do not recharge the battery if it has been fully charged or the radio is not in the low battery alarm state; otherwise, it will have bad effects on the battery's service life and performance. Remove the battery from the charger after charging.

2.2 Installing/Removing the Battery

Match the two bulges at the bottom of the battery pack with the corresponding slots at the rear bottom of the radio.

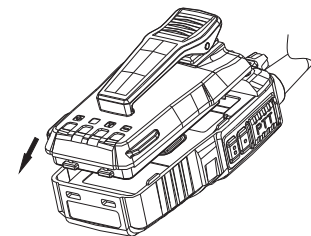

Press the top part of the battery towards the radio to lock it in place until a click is heard.

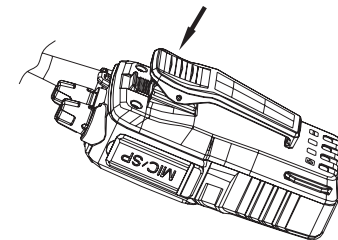

To remove the battery pack, push the battery latch upwards, and then remove the battery away from the radio.

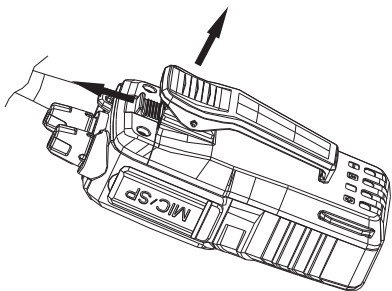

Note:

- Do not short-circuit the battery terminals or dispose battery in fire.
- Do not disassemble the battery casing by yourself.

2.3 Installing the Antenna

Hold the base of the antenna and turn the antenna clockwise into the connector on the top of the radio until secure.

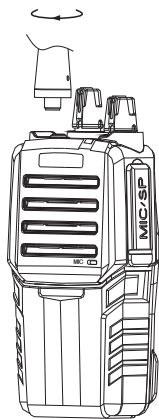

2.4 Installing the External Speaker/MIC

Open the cover for external speaker/MIC jacks, and then insert the external speaker/MIC plug into the jacks on the radio.

Note: When using the external speaker/MIC, the radio will not be waterproof.

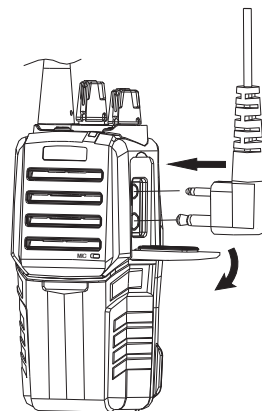

2.5 Installing/Removing the Belt Clip

Align the grooves of the belt clip with those on the rear of the battery. Then press the belt clip downwards until a click is heard. To remove the belt clip, use your fingernail or a tool to press the belt clip tab away from the battery. Then slide the belt clip upwards to remove it.

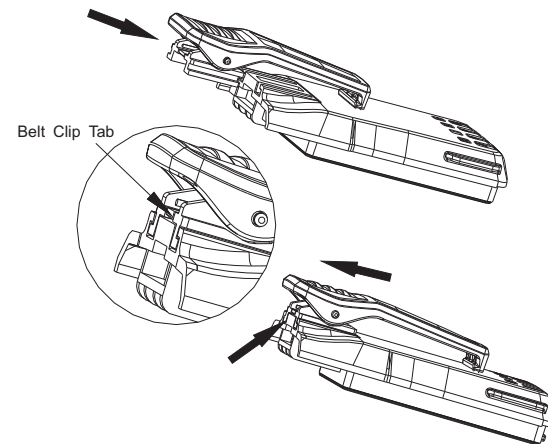

3. Radio Overview

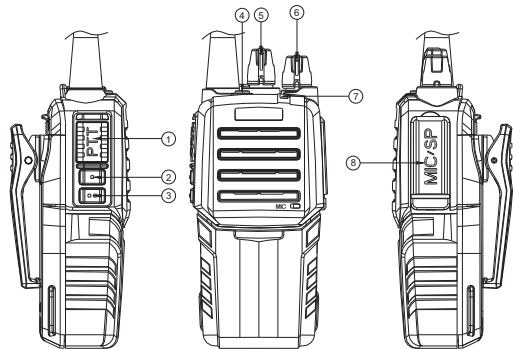

① PTT (Push-To-Talk) Button

To make a call, press and hold the PTT button, then speak into the microphone. Release the PTT button to receive signals.

② Programmable Button 2

You can assign functions to this button through PC software.

③ Programmable Button 1

You can assign functions to this button through PC

software.

④ Emergency Button

Press the button to activate warning tone. Press it again to exit the emergency alert state.

Note: When the warning tone sounds, all the other buttons are disabled.

⑤ Channel Selector Knob

Rotate it to select channel 1 – 16.

⑥ On-Off/Volume Control Knob

Turn clockwise until you hear a click to turn the radio power on. Turn counterclockwise until you hear a click to turn it off. Rotate it to adjust the volume after turning on the radio.

⑦ LED Indicator

Lights red while transmitting; lights green while receiving; flashes red when the radio is in low power while transmitting.

⑧ External Speaker/MIC Jacks

For connecting external speaker/MIC. Open the MIC/SP cover to see the jacks.

4. Basic Operations

4.1 Switching On

Turn the On-Off/Volume Control Knob clockwise until a click is heard to switch on the radio. The radio will make a sound of “Di...” If programmed, the current channel number will be annunciated.

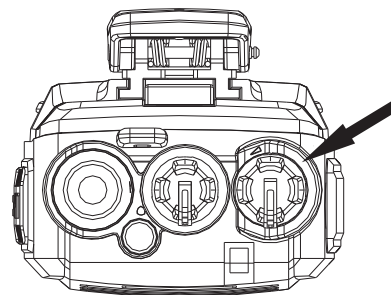

4.2 Adjusting the Volume

Turn the On-Off/Volume Control Knob to adjust the radio volume.

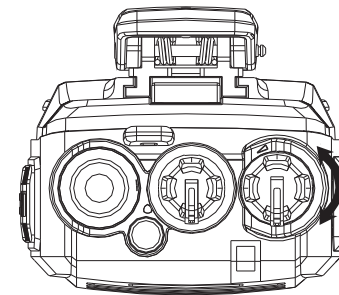

4.3 Selecting a Channel

Turn the channel selector knob to your desired channel. If voice annunciation has been set, the radio will announce the current channel number. You will hear voice from the speaker while receiving valid signals.

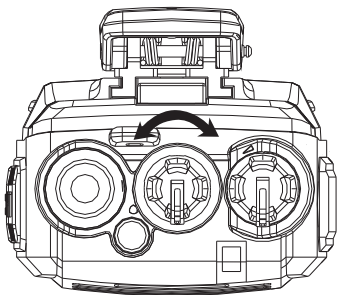

4.4 Sending a Call

To make a call, press and hold the PTT button and speak to the microphone in normal voice. Please keep your mouth 3 - 8 cm away from the microphone.

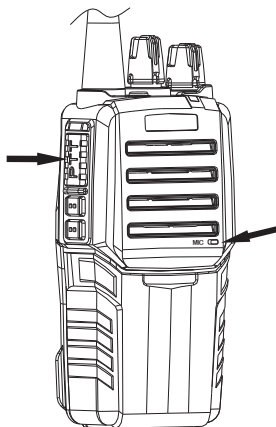

4.5 Receiving a Call

Adjust the volume to a proper level. Release the PTT button to receive a call.

5. Functions of Programmable Buttons

Long Press Duration: Amount of time that the radio-user is required to press (and hold down) a button, for the press to be interpreted by the radio as a long press. A short press is defined as any button-press that is shorter than the duration.

The dealer can assign one of the following auxiliary functions to the long press or short press of the programmable button 1 and programmable button 2:

- None: No function is assigned.
- Monitor Momentary

Press and hold the preprogrammed Monitor Momentary button to open squelch for monitoring the transmission on the channel whether the CTCSS/DCS, audio squelch conditions match or not. Release it to exit monitor mode.

- Monitor

Press the preprogrammed Monitor button to open squelch for monitoring the transmission on the channel whether the CTCSS/DCS, audio squelch conditions match or not. Press it again to exit monitor mode.
- Squelch Off Momentary

Press and hold the preprogrammed Squelch Off Momentary button to open squelch momentarily, and release it to resume normal operation.
- Squelch Off

Press the preprogrammed Squelch Off button to open squelch, and press it again to resume normal operation.
- Channel Annunciation

Press the preprogrammed Channel Annunciation button, the current channel number can be heard.
- Scan

Press the preprogrammed Scan button to start scanning (the scan list should be effective), press it

again during the scanning to stop scanning.

- High/Low Power Switch

Press the preprogrammed High/Low Power Switch button to switch the current channel power between high and low.

- Battery Check

Press the preprogrammed Battery Check button, the current battery power level can be heard. There are four levels in all. Level 4 indicates that the battery power is full, and level 1 indicates that the battery power is low.

- Squelch Adjust

Press the preprogrammed Squelch Adjust button to change the current squelch level, and the squelch level after the change can be heard.

- VOX

VOX function enables you to use the radio without manual operations. This function can only be set by the dealer, and you have to be equipped with the specified earphones.

Before using VOX, you must set VOX gain level.

Such setting enables the radio to identify the voice volume. If the microphone is too sensitive, the background noise will trigger the radio to transmit. If the microphone is not sensitive enough, it cannot receive your voice when you speak. Make sure to adjust the VOX gain level to proper sensitivity.

6. Scan Function

(this function can be disabled by the dealer)

If the scan function is enabled, you can press the preprogrammed Scan button to start scanning and press it again to stop scanning.

Explanations:

- After scan pauses, there are two ways to resume scanning:

(1) Time operate: After pausing on an active channel, the radio will resume scanning after a preprogrammed delay. The scan delay time can be preset from 0.5 to 5 seconds.

(2) Carrier operate: After pausing on an active channel, the radio will resume scanning after a preprogrammed delay after the channel becomes inactive. The scan delay time can be preset from 0.5 to 5 seconds.

- The revert channel during scan can be designated through PC software. There are following options

available:

(1) Last Rx channel:

When pressing the PTT button during scanning, the radio will transmit from the last channel that received a call.

(2) Designated Tx channel:

When pressing the PTT button during scanning, the radio will transmit from the selected channel.

(3) Priority channel (the priority channel must be set)

When pressing the PTT button during scanning, the radio will transmit from the priority channel in the scan list.

(4) Last Tx channel:

When pressing the PTT button during scanning, the radio will transmit from the last channel that transmits signals.

(5) Selected channel:

When pressing the PTT button during scanning, the radio will transmit from the channel selected by the channel selector knob.

- You can choose to set one of the following 3 operations when the channel is switched during scanning:

(1) No operation.

(2) Scan the current channel: The scanning will pause on the current channel, and the pause time will be the Dropout Delay Time. However, this channel will not be added to the scan list.

(3) Exit scanning.

- Power-on scanning: If this function is enabled, the radio will start scanning after the radio power is turned on.

7. Auxiliary Functions

7.1 Time-Out Timer (TOT)

(1) TOT Function

The time-out-timer can prevent the user from continuously talking overlong and prevent the radio from heating due to continuous transmitting.

If you continuously transmit longer than the preset TOT time, the radio will make an alert tone and stop transmitting. To stop the warning tone, release the PTT button.

(2) TOT Pre-alert

The radio will make an alert tone in advance before the TOT terminates the transmission. After the alert tone, when the time of transmission exceeds the preset time, the TOT timer will act.

(3) TOT Rekey Time

A period in which the radio is forbidden to transmit after its overtime activity.

During the period, if the PTT button is pressed, an

alert tone will be sounded, and the transmission is forbidden.

(4) TOT Reset Time

The time delay from releasing the PTT button to the resetting of the timer is limited.

The countdown will go on if the time after releasing the PTT key is shorter than the reset time.

7.2 Busy Channel Lockout (BCL)

If the channel on which a user attempts to transmit is being used by another party, BCL function restricts the transmission in order to avoid interfering with the other parties' communication, and the radio will make an alert tone, and returns to the receiving state.

7.3 Battery Saving

The battery saving function can reduce power consumption of the radio when no signal is received and no operation is conducted (no button is pressed and no knob is turned).

If the radio hasn't receive any signal or no operation

is being conducted for 8 seconds, the radio will enter Battery Saving Mode. When a signal is received or any operation occurs, the radio will exit the Battery Saving Mode automatically.

7.4 Low Battery Warning

When the battery voltage drops too low while transmitting, the LED flashes red, low battery warning tone sounds, and the radio stops transmitting. You need to recharge or change the battery.

7.5 Monitor

When there is no signal received, the radio's squelch circuit will mute the speaker automatically so that the background noise will not be heard by the user. You can press and hold the preprogrammed Monitor button to open squelch manually. This function is especially useful when you need to adjust the volume level or to receive weak signals.

When the Monitor button is pressed and held, the LED indicator lights green, and the radio is in the

monitoring state.

7.6 CTCSS/DCS

CTCSS/DCS tones may have been pre-programmed on some radio channels. A CTCSS/DCS tone is a sub-audible tone, which allows you to ignore (not hear) calls from other irrelevant parties who are using the same channel. When you receive a signal that has a tone different from the one set on your radio, you will not hear the signal. Likewise, signals that you transmit will only be received by parties whose CTCSS/DCS tones are the same as yours.

Note: Using a CTCSS/DCS channel doesn't mean your calls are private. If other parties' CTCSS/DCS tones are identical with yours, they can hear your calls.

7.7 PTT ID

PTT ID uses DTMF code. The preset DTMF sequence can be sent at the beginning of the transmission or at the end of the transmission. It is

used to notify the identity of the callers to the monitoring center, or used to activate the repeater.

The encoder sequence and the encoder type can be set for each channel. There are 16 groups of sequences for your selection.

PTT ID Keydown Code: The radio will send DTMF sequence when the PTT button is pressed.

PTT ID Dekey Code: The radio will send DTMF sequence when the PTT button is released.

8. Troubleshooting

No.	Problem	Causes and Solutions
1	The radio cannot be switched on or no display after being switched on.	A. The battery power may be insufficient. Please recharge or replace the battery pack. B. The battery pack may not be installed properly. Please remove the battery pack and install again.
2	The battery power consumes quickly after charging.	A. The battery life is finished. Please replace it with a new battery pack.
3	Cannot talk to or hear other group members.	A. Make sure the CTCSS/DCS signal is the same as that of your group members. B. The radio is out of effective communication range.
4	Other voices from non-group members are heard on the channel.	A. Change the CTCSS/DCS signal, and make sure to change the CTCSS/DCS signal of all radios in your group.

No.	Problem	Causes and Solutions
5	The communication range is too short.	<p>A. Make sure the antenna is well connected.</p> <p>B. Make sure the antenna is the original supplied one.</p> <p>C. Check if the battery power is in normal state.</p> <p>D. Ask your local dealer to adjust the squelch level.</p>

9. Major Specifications

Model	PT3600	
Frequency	136-174MHz VHF 400-470MHz UHF	
RF power	4W(UHF)	5W(VHF)
Tx clusters and harmonics	<-70dB	
Frequency stability	±5ppm	
Max. deviation	±5KHz(W)/ ±2.5KHz(N)	
Rx sensitivity	≤0.18μV	
Channel selectivity	>60dB	
Intermodulation	>60dB	
Max. audio power	≥1000mW	
Channel number	16(15+S)	
Power supply	DC 7.4V	
External dimension	47mm×107mm×33mm	
Weight	225g (with battery and antenna)	

10. Status Setting (by the dealer)

Model:

Serial No.:

1. Channel setting

Channel No.	Tx frequency	Rx frequency	CTCSS/DCS
1			
2			
3			
4			
5			
6			
7			
8			
9			
10			
11			
12			
13			
14			
15			
16			

