



INSTRUCTION MANUAL

PT6700
FM TRANSCEIVER

Notice to the User:

Before using this radio, read this operating instruction carefully for safe and convenient usage. When you begin to use it, we deem that you have read this manual.

Keep this manual in a safe place and make it available to other operators in case the product is passed on to other people.

When purchasing our product, please fill in the WARRANTY CARD with truth information, and ask for the valid proof of purchase so as to protect your legal rights.

Kirisun and our authorized partners own the intellectual property of all the parts of this product (include accessories). Any design and materials may not be modified, copied, extracted or translated without the authorization of Kirisun or its authorized parties.

Due to the update or modification of the product, Kirisun owns the right to change the specifications of software and hardware described in this manual without further notice. Specifications and information contained in this manual are for reference only.

Kirisun reserves the right to interpret the mistakes and errors occurring in this manual, though all the contents are checked carefully.

◆ Safety

Before using this radio, read this operating instruction carefully for safe and convenient usage.

This product can only be maintained by the professional

technicians. Do not disassemble the radio by yourself.

To avoid of the problems caused by electromagnetic interference or electromagnetic compatibility, turn off the radio in any facilities where posted notices instruct you to do so, such as hospital and other health care facilities. And when on board an aircraft, turn off the radio if instructed to do so too.

In the vehicle with an air bag, do not place the radio in the area over an air bag or in the air bag deployment area.

Turn off the radio before entering any area with a potentially explosive atmosphere or blasting caps.

Do not operate the radio, disassemble or charge the battery in the potentially flammable and explosive atmosphere (such as gas station, coal gas station, etc.).

Do not place the radio under the direct sunlight or near the area with heating devices.

Do not place the radio in the area with great dust, moisture or drips, or on the unstable surface.

Contact us or your local dealer for help if you want to re-develop or modify the radio.

Do not use any portable radio that has a damaged antenna. If a damaged antenna comes into contact with your skin, a minor burn can result.

Make sure the antenna is correctly installed when using. The radio without antenna may cause damage in the process of transmission.

Keep the radio vertically and away from your mouth about 5cm in the process of transmission.

When worn on your body, make sure the antenna is at least 2.5cm away from your body in the process of transmission.

◆Battery

All batteries can cause property damage and/or bodily injury, such as burns, if a conductive material such as jewelry, keys, or beaded chains touches exposed terminals. The conductive material may complete an electrical circuit (short circuit) and become quite hot. Excessive care in handling any charged battery, particular when placing it inside a pocket, purse, or other container with metal objects. To reduce the potentially damage, do not expose the battery in the fire, or disassemble and extrude the battery.

The maximum ambient temperature around the adapter or transformer for the charger should not exceed 40°C (104°F).

Turn off the radio when charging. If not, the battery's capacity will be affected.

Do not insert the battery pack into the charger when charging is not necessary. The continuous charging will shorten the battery's lifetime. Do not use the charger as the pedestal for the radio.

To realize the best performance of the battery, change the battery once a year.

Kirisun Communications Co.,Ltd.

CONTENT

| | |
|--|----|
| ■ Unpacking and Checking | 1 |
| ■ Preparation | 2 |
| ◆ Charging the Battery | 2 |
| ◆ Installing/Removing the Battery | 3 |
| ◆ Installing the Antenna | 4 |
| ◆ Installing the External Speaker/Microphone | 4 |
| ◆ Installing the Belt Clip | 5 |
| ■ Radio Overview | 5 |
| ■ Basic Operation | 7 |
| ■ Functions of Programmable Buttons | 8 |
| ■ Auxiliary Functions | 10 |
| ■ Wired Clone Mode | 16 |
| ■ Troubleshooting | 17 |
| ■ Specifications | 19 |
| ■ FCC Notice | 20 |

■ Unpacking and Checking

Unpack the radio carefully. We recommend that you check the radio and the supplied accessories listed in the following table before discarding the packing material. If any damage or loss has occurred during shipment, please contact the dealer without delay.

◆ Supplied Accessories

| Item | Quantity |
|--------------------|----------|
| Antenna | 1 |
| Battery | 1 |
| Belt Clip | 1 |
| Charger | 1 |
| Power Adapter | 1 |
| Hand Strap | 1 |
| Instruction Manual | 1 |

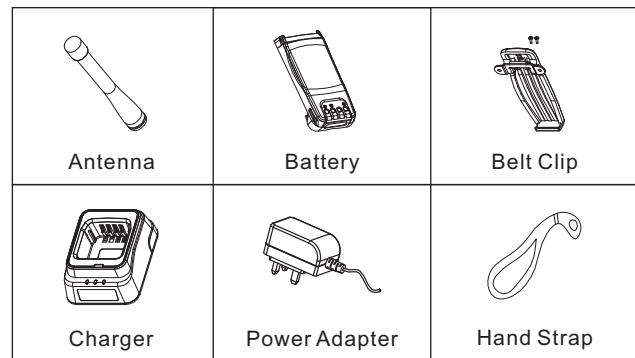

■ Preparation

◆ Charging the Battery



Plug the adapter into an applicable AC outlet and connect the power adapter to the battery charger. Three LED indicators light up for 1s and then green LED lights up.

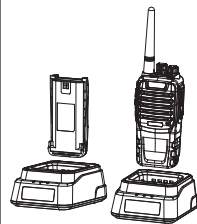

Plug the battery or radio into the charger slot, and make sure the radio has been turned off.

Make sure the battery is well connected with the charger. Then red LED lights up, which indicates that the charging starts.

After about 5 hours of charging, red LED lights off, and green LED lights up. This indicates that the battery is fully charged.

Before taking out the battery, keep it in this state for 1~2 hours to achieve its best performance. Then plug off the adapter from AC outlet.

If the temperature or the circuit is abnormal, and the LED flashes yellow, the charger enters protection mode. At this moment, do not charge the battery by force. Please remove the battery and cut off the power supply of the charger.

Note:

* The radio battery is not fully charged in the factory. Before the initial use, please charge the new battery.

* KB-78B Li-poly battery of Kirisun is applicable to this radio.

* When charging the battery for the first time after purchase or long-time storage (over 2 months), please repeat charging several times for the battery to achieve normal capacity. Meanwhile, please make sure the battery is charged at least once every three months.

* Do not recharge the battery if it has been fully charged or the radio is not in the low battery alarm state; otherwise, it will have bad effects on the battery's service life and performance. Remove the battery from the charger after charging.

* When the radio is in the low battery alarm state, please recharge the battery before use. Do not turn the radio power on by force; otherwise, it will have bad effects on its service life and performance.

* KB-78B has built-in protection circuit. When the battery voltage is too low, the battery stops supplying power automatically. Plug the battery into the charger, red LED lights up after 1~5 minutes, and the charging begins.

◆ Installing/Removing the Battery

Installing the Battery:

Press and hold the top of the belt clip; match the battery with the two slots on the radio and push forward until a click is heard. Then the battery is fixed.

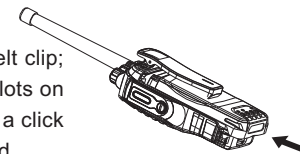

Removing the battery

Press down the battery latch, and push the battery pack downwards until it separates from the radio.

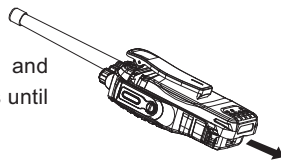

Note:

- * Do not short-circuit the battery terminals or dispose battery in fire.
- * Do not disassemble the battery casing by yourself.

◆ Installing the Antenna

Hold the bottom of the antenna and turn the antenna clockwise into the connector on the top of the radio until secure.

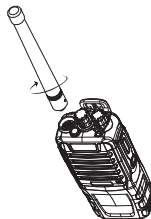

◆ Installing the External Speaker /Microphone

Open the cover for external speaker/microphone jack, and then insert the external speaker/microphone plug into the jack on the radio.

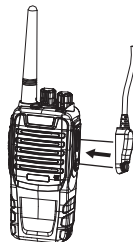

◆ Installing the Belt Clip

Match the two holes of the belt clip with those on the rear of the radio, and then fix the belt clip to the radio with two 2.5*8.0 screws. Loose the fixing screws to remove the belt clip.



■ Radio Overview

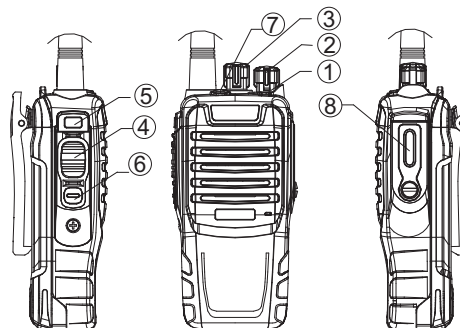

① LED Indicator

Lights up red while transmitting; lights up green while receiving; flashes red when the radio is in low voltage.

② On/Off/Volume Control Knob

Turn clockwise until you hear a click to turn the radio power on. Turn counterclockwise until you hear a click to turn it off.

Rotate it to adjust the volume after turning on the radio.

③ Channel Selector Knob

Rotate to select channel 1-16.

④ PTT (Push-To-Talk) Button

Press and hold the PTT button and speak into the microphone, your voice can be sent to the recipient. Release the PTT button to receive.

⑤ Side Button 1 (programmable button)

⑥ Side Button 2 (programmable button)

⑦ Top Button (programmable button)

⑧ External Speaker/Microphone Jack

External speaker/microphone can be connected to the radio through this jack.

■ Basic Operation

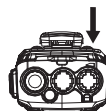

Switch On

Switch on the radio by turning the On/Off/ Volume control knob clockwise until a click is heard. If programmed, a beep tone will be heard.

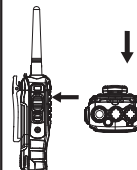

Adjust Volume

Press the programmed "Squelch Off" button to hear background noise. Then rotate the On/Off/Volume control knob to adjust the volume.

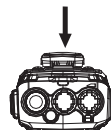

Select a Channel

Rotate the channel selector knob to select the required channel. You will hear voice from the speaker while receiving valid signals.



Make a Call

To make a call, select the desired channel, press and hold the PTT button, and speak to the microphone in normal voice. Please keep your mouth 5-10cm away from the microphone.

Receive a Call

Release the PTT button to receive a call.

Your dealer can set QT/DQT signaling on your radio channels by PC software. If you select a channel that has been preset with the signaling, you will not hear other calls except those from your own system.

■ Functions of Programmable Buttons

The dealer can assign one of the following auxiliary functions to the top button, side button 1 or side button 2.

| No. | Function | Description |
|-----|--------------------|--|
| 0 | None | No function is assigned. |
| 1 | Voice Annunciation | Press the preprogrammed "Voice Annunciation" button to change the language and mode of voice annunciation, meanwhile, the current channel number can be heard. |
| 2 | Talkaround | When the preprogrammed "Talkaround" button is pressed, the next transmission will be at the same frequency as at which it is received. |
| 3 | Lone Worker | Press the preprogrammed "Lone Worker" button to start/stop lone working. |
| 4 | Emergency Alarm | Press the preprogrammed "Emergency Alarm" button to make an alarm tone according to the setting of the programming software or send your ID or background sound to your partner or the system. |

| | | |
|----|-----------------------------|--|
| 5 | Emergency Alarm Off | Press the preprogrammed "Emergency Alarm Off" button to quit the Emergency Alarm Mode. |
| 6 | Scan | Press the preprogrammed "Scan" button to start/stop scanning. |
| 7 | Nuisance Delete (temporary) | If the radio stays at a noise channel while scanning, press the preprogrammed "Nuisance Delete" button to delete the noise channel temporarily. |
| 8 | High/Low Power Switch | Press the preprogrammed "High/Low Power Switch" button to switch between high and low transmitting power of the radio. |
| 9 | Momentary Monitor | Press and hold the preprogrammed "Momentary Monitor" button to disable QT, DQT signaling, and release the button to resume normal operation. |
| 10 | Monitor | Press the preprogrammed "Monitor" button to disable QT, DQT signaling, and you can receive signals that cannot be heard under normal operation. Press it again to resume normal operation. |
| 11 | Momentary Squelch Off | Press and hold the preprogrammed "Momentary Squelch Off" button to open squelch; release it to resume normal operation. |
| 12 | Squelch Off | Press the preprogrammed "Squelch Off" button to open squelch. Press it again to resume operation. |
| 13 | Lone Worker Reset | Press the preprogrammed "Lone Worker Reset" button while the radio is in Lone Worker Mode to reset the lone worker timer, and the timer starts again. |

■ Auxiliary Functions

◆ TOT (Time-Out-Timer)

1) TOT Function

a) The time-out-timer can prevent the user from continuously talking overlong and occupying one certain channel for an extended period of time, and prevent the radio from heating due to continuous transmitting.

b) The radio is set with a continuous transmitting limit. If the radio is continuously transmitting longer than the time preset by the dealer, the radio will make alarm and stop transmitting.

2) TOT Rekey Time

a) A period in which the radio is forbidden to transmit after its overtime activity.

b) During the period, if the PTT button is pressed, an alert tone will be sounded, and the transmission is forbidden.

3) TOT Pre-alert

a) The pre-alert will sound before the TOT action.

b) After the pre-alert tone, the timer will action when the transmitting time has gone beyond the limit.

4) TOT Reset Time

a) The time delay from releasing the PTT button to the resetting of the timer is limited.

b) The countdown will go on if the time after releasing the PTT key is shorter than the reset time.

◆ Battery Saving

The dealer can set the power saving mode by programming.

If this function is enabled, and the radio hasn't receive any signal or no operation is being acted for 10 seconds, the radio will enter Battery Saving Mode. When a signal is received or any operation occurs, it will exit the Battery Saving Mode automatically.

There are four types for battery saving: 1:1, 1:2, 1:4 and Off.

The automatic battery saving function can reduce power consumption of the radio.

◆ Low Battery Warning

When the battery voltage drops too low, the LED will flash. When the battery voltage drops too low while transmitting, the LED flashes red and then the radio stops transmitting. You need to recharge or change the battery.

◆ Voice Annunciation

This function can be enabled or disabled by the dealer. There are two languages available: Chinese and English. After selecting a channel by turning the channel selector knob, the channel number will be annunciated.

◆ QT/DQT

The dealer can set QT/DQT tones on radio channels, which enables

you to ignore (not hear) calls from other irrelevant parties who are using the same channel. When you receive a signal that has a tone different from the one set on your radio, you will not hear the signal. Likewise, signals that you transmit will only be received by parties whose QT/DQT tones are the same as yours.

Note:

* Using a QT/DQT channel doesn't mean your calls are private. If other parties' QT/DQT tones are identical with yours, they can hear your calls.

* Set the battery saving mode to be "Off" or "1:1" if the QT/DQT decoding time is long.

◆ **Talkaround**

You can expand the communication range of your network through a repeater. If the radio is out of the communication range, you can connect with other radios through "Talkaround" mode.

Press the preprogrammed "Talkaround" button to switch between "Talkaround" mode and "Repeater" mode.

◆ **Scan Function**

In order to receive calls from many different channels, the radio can be programmed to scan these channels.

Starting/Stopping Scan

a) Press the button set as "Scan" to start scanning. While in scanning, the radio checks every channel in the scan list and stops

on which a signal is detected until that signal disappears. If interval between signal disappearing and continuing scanning has been preset, the radio will remain on that channel.

b) Priority Scan:

One channel in the scan list can be set as the priority channel, which enables it to have the highest priority during scanning. The radio will scan a non-priority channel firstly, then the priority channel, and then the next non-priority channel, and then the priority channel again, and the scan goes on like this.

If the priority channel and the "lookback time" have been set for the scan list, when the radio is receiving signals on a non-priority channel, and the scanning is paused, the radio will check the priority channel at the preset intervals. If there are signals in the priority channel, it will stay at the priority channel; if there is no signal, it will return to the original channel.

c) The revert channel (Tx channel) during the scan can be designated by the dealer. There are following options available:

Selected Channel: When pressing the PTT button, the radio will transmit from the first channel of the scan list.

Selected Channel + Currently Working Channel: When pressing the PTT button during scanning, the radio will always transmit from the first channel in the scan list. When pressing the PTT button during the scanning pause, the radio will always transmit from the currently working channel.

Priority Channel: The radio will transmit from the priority channel in

the scan list when pressing the PTT button.

Priority Channel + Currently Working Channel: When pressing the PTT button during scanning, the radio will always transmit from the priority channel. When pressing the PTT button during the scanning pause, the radio will transmit from the currently working channel.

Last Called Channel: When pressing the PTT button, the radio will transmit from the last channel that received a call.

Last Used + Currently Working Channel: When pressing the PTT button during the scanning, the radio will transmit from the last channel that transmits signals. When pressing the PTT button during the scanning pause, the radio will transmit from the currently working channel.

Nuisance Delete

During scanning, if a channel continually generates unwanted noise or interference, you can press the preprogrammed "Nuisance Delete" button to remove the channel from the scan list temporarily.

Note:

* The priority channel and the last channel in the scan list cannot be deleted.

* Quit the scan mode and enter it again, the deleted channel will be added to the scan list again.

◆ **Lone Worker**

If lone worker function is enabled by PC software, you can press the button set as lone worker to start lone working. This mode is to ensure the safety of the user while using the radio separately. The lone worker timer starts upon pressing the preprogrammed "Lone Worker" button. If the preset lone worker time expires, the radio will make an alert tone. If the preset remind time expires, the radio will enter Emergency Mode and make alarm.

In the Lone Worker Mode, press the preprogrammed "Lone Worker" button again to quit Lone Worker Mode.

In the Lone Worker Mode, press the preprogrammed "Lone Worker Reset" button (if a button is designated as the lone worker timer reset button) or any button (if any button is designated as the lone worker timer reset button) to restart the lone worker timer.

◆ **Emergency Alarm**

Press the preprogrammed "Emergency Alarm" button (the pressing time should be longer than the debounce time of the emergency alarm switch) to enter the Emergency Alarm Mode. You can give the warning tone according to the programming software, or send the background sound to your partner or the system.

Press the preprogrammed "Emergency Alarm Off" button to quit the Emergency Alarm Mode, the radio stops the alert and resumes normal operation.

■ Wired Clone Mode

If the wired clone function is enabled by PC software, after entering the Wired Clone Mode, the radio needs to be restart to return to user mode.

The operating steps go as follows:

1. Press and hold side button 2 while turning the radio power on to enter Clone Mode. If the wired clone function is disabled, the radio will enter User Mode.
2. Connect the slave radio with the master radio by a clone cable. Then switch on the slave radio.
3. Press side button 1 of the master radio, the cloning starts. During the data transmission process, the Led indicator of master radio will light red, and that of the slave radio will light green. When the cloning is finished, the red LED of the master radio will be off, and the slave radio will restart automatically.
4. You can continue to clone data according to step 3.

Note:

The wired clone function can be enabled or disabled by the PC programming software. Once the wired clone function is disabled, the radio cannot enter Wired Clone Mode.

■ Troubleshooting

| No. | Problem | Causes and Solutions |
|-----|--|--|
| 1 | The radio cannot be switched on or no display after being switched on. | A. The battery and the radio are not reliably connected. Please reinstall the battery. B. The fuse of the power supply is burnt out. Please change it. C. The power switch is in failure. Please change it. D. The battery is out of power, please recharge it or change it. E. The CPU is broken, please change it. |
| 2 | Phase lock loop unlocked (Beeping) | A. The channel frequency setting is out of range, please reset the channel data. B. The crystal oscillator of phase lock loop is broken, please change it. C. The oscillating tube is broken, please change it. D. The phase lock loop IC is broken, please change it. |
| 3 | Cannot transmit | A. The frequencies of both users are not the same. Please select the same frequency channel again. B. The QT/DQT signals of both users are not the same. Please reset it. C. The radio is out of effective communication range. |

| No. | Problem | Causes and Solutions |
|-----|--|--|
| 4 | No signal | A. The antenna is in poor contact. Please fasten the antenna head. B. The HF amplifier is broken, please change it. C. The squelch level is so high that the squelch cannot be opened. Please reset the squelch level. D. The mixer tube is broken, please change it. E. The FM processing IC is broken, please change it. |
| 5 | The transmitting red light is on, but no voice is heard. | A. The power module is broken, so there is no power output. Please change it. B. The microphone is broken, please change it. |
| 6 | The receiving green light is on, but no voice is heard. | A. The speaker is broken, please change it. B. The audio amplifier is broken, please change it. |

■ Specifications

| General Specification | PT6700 |
|--------------------------|-------------------------------------|
| Frequency | 136~174MHz, VHF |
| | 400~470MHz, UHF |
| Number of channels | 16 |
| Channel spacing | 25kHz(W) / 12.5kHz(N) |
| Dimension(H×W×D) | 122mm x54mmx33mm |
| Weight | 298g(including battery and antenna) |
| Operating temperature | -25℃ ~+55℃ |
| Receiving sensitivity | ≤ 0.28μV |
| Frequency stability | ±2.5ppm |
| Tx power | 4W (UHF) , 5W (VHF) |
| Max. frequency deviation | <2.5 KHz (W) / <5 KHz (N) |
| Max. audio power | ≥ 1000mW(16Ω) |
| Power supply | DC7.4V |

■ FCC Notice



Your KIRISUN radio generates RF electromagnetic energy during transmit mode. This radio is designed for and classified as “Occupational Use Only”, meaning it must be used only during the course of employment by individuals aware of the hazards, and

the ways to minimize such hazards. This radio is NOT intended for use by the “General Population” in an uncontrolled environment.

This radio has been tested and complies with the FCC RF exposure limits for “Occupational Use Only”. In addition, your KIRISUN radio complies with the following Standards and Guidelines with regard to RF energy and electromagnetic energy levels and evaluation of such levels for exposure to humans:

FCC OET Bulletin 65 Edition 97-01 Supplement C, Evaluating Compliance with FCC Guidelines for Human Exposure to Radio Frequency Electromagnetic Fields.

American National Standards Institute (C95.1-1992), IEEE Standard for Safety Levels with Respect to Human Exposure to Radio Frequency Electromagnetic Fields, 3 kHz to 300 GHz. American National Standards Institute (C95.3-1992), IEEE Recommended Practice for the Measurement of Potentially Hazardous Electromagnetic Fields—RF and Microwave.

The aforementioned accessories are authorized for use with this product. Use of accessories other than those (listed in the instruction) specified may result in RF exposure levels exceeding the FCC requirements for wireless RF exposure.



To ensure that your exposure to RF electromagnetic energy is within the FCC allowable limits for occupational use, always adhere to the following guidelines

DO NOT operate the radio without a proper antenna attached, as this may damage the radio and may also cause you to exceed FCC RF exposure limits. A proper antenna is the antenna supplied with this radio by the manufacturer or antenna specifically authorized by the manufacturer for use with this radio.

DO NOT transmit for more than 50% of total radio use time (“50% duty cycle”). Transmitting more than 50% of the time can cause FCC RF exposure compliance requirements to be exceeded. The radio is transmitting when the “TX indicator” lights red. You can cause the radio to transmit by pressing the “PTT” switch.

ALWAYS keep the antenna at least 2.5 cm (1 inch) away from the body when transmitting and only use the KIRISUN belt-clip which is listed in instructions when attaching the radio to your belt, etc., to ensure FCC RF exposure compliance requirements are not exceeded. To provide the recipients of your transmission the best sound quality, hold the antenna at least 5 cm (2 inches) from your mouth, and slightly off to one side.

The information listed above provides the user with the information needed to make him or her aware of RF exposure, and what to do to assure that this radio operates with the FCC RF exposure limits of this radio.

Electromagnetic Interference/Compatibility During transmissions, your KIRISUN radio generates RF energy that can possibly cause interference with other devices or systems. To avoid such interference, turn off the radio in areas where signs are posted to do so. **DO NOT** operate the transmitter in areas that are sensitive to electromagnetic radiation such as hospitals, aircraft, and blasting sites.

Occupational/Controlled Use The radio transmitter is used in situations in which persons are exposed as consequence of their employment provided those persons are fully aware of the potential for exposure and can exercise control over their exposure.

IMPORTANT

READ ALL INSTRUCTIONS carefully and completely before using the transceiver

SAVE THIS INSTRUCTION MANUAL- This instruction manual contains important operating instructions for the Two-Way Radio

EXPLICIT DEFINITIONS

| WORD | DEFINITION |
|----------------|---|
| WARNING | Personal injury, fire hazard or electric shock may occur. |
| CAUTION | Equipment damage may occur. |
| NOTE | If disregarded, inconvenience only, No risk of personal injury, fire or electric shock. |

OPERATING NOTES

When transmitting with a portable radio, hold the radio in a vertical position with its microphone 5 to 10 cm (2 to 4 inches) away from your mouth. Keep the antenna at least 2.5 cm (1 inch) from your head and body.

If you wear a portable two-way radio on your body, ensure that the antenna is at least 2.5 centimeters (1 inch) from your body when transmitting.

PRECAUTIONS WARNING!

NEVER hold the transceiver so that the antenna is very close to, or touching exposed parts of the body, especially the face or eyes, while transmitting. The transceiver will perform best if the microphone is 5 to 10 cm (2 to 4 inches) away from the lips and the transceiver is vertical.

WARNING!

NEVER operate the transceiver with a headset or other audio accessories at high volume levels.

CAUTION!

NEVER short the terminals of the battery pack. **NEVER** connect the transceiver to a power source other than the Battery listed above. Such a connection will ruin the transceiver.

DO NOT push the PTT when not actually desiring to transmit.

AVOID using or placing the transceiver in direct sunlight or in areas with temperatures below -30°C (-22°F) or above +60°C (+140°F).

DO NOT modify the transceiver for any reason.

