

MODEL **2015R**  
0-20 VDC • 0-1.5A

SEMICONDUCTORIZE  
POWER SUPPLY

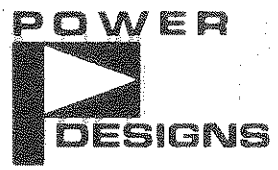

TESTED TO MIL-STD-883C  
DOCUMENT 11407-101-1000-1000

SERIAL NUMBER \_\_\_\_\_

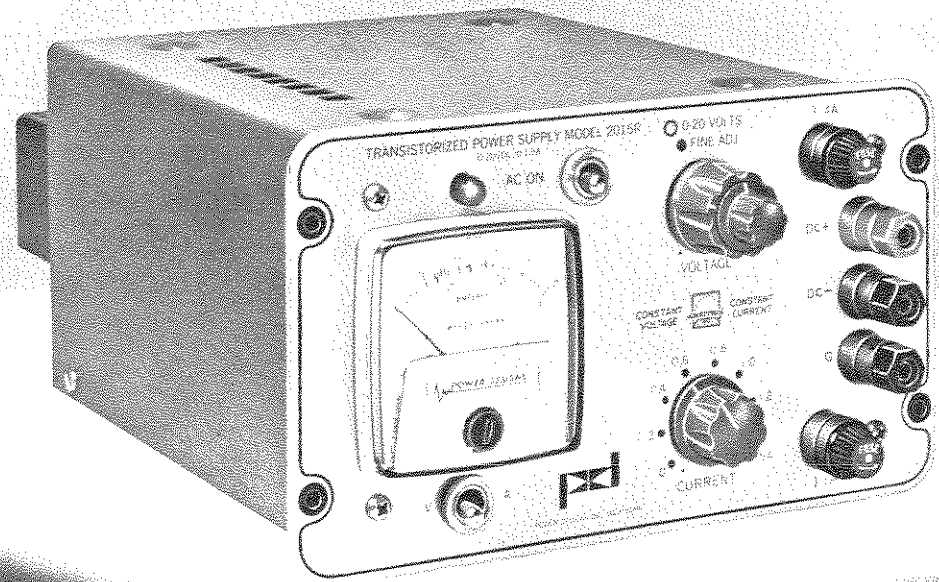

*All Silicon*

**CONSTANT** | **VOLTAGE**  
**POWER SUPPLY** | **CURRENT**

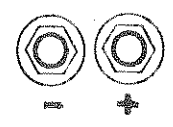

WITH **AMBITROL®**

RECOGNIZED RELIABILITY

**MODEL 2015R**

0-20 VDC • 0-1.5A

*All Silicon Semiconductorized***DC POWER SUPPLY****WITH AMBITROL®****MODES OF OPERATION:**

- Constant Voltage Regulation
- Constant Current Regulation
- Remote Voltage Programming
- Remote Current Programming
- Automatic Transfer from Voltage to Current Regulation at any Predetermined Operating Point.
- Automatic Transfer from Current to Voltage Regulation at any Predetermined Operating Point.
- Constant Voltage Regulation with Continuously Adjustable Current Limiting.
- Constant Current Regulation with Continuously Adjustable Voltage Limiting
- Series Operation
- Parallel Operation

**APPLICATIONS**

- Versatile laboratory power source with controlled regulation from no load to a short circuit.
- Precision automatic battery charger for sealed batteries. Control accuracy of 0.1%.
- Safety power supply for component protection in experimental circuitry.
- Supplementary power source to increase capacity of an external d-c supply. Voltage locks in automatically.
- Automatic Test Set power supply for current limited or voltage limited testing of semiconductor devices.
- Current and Voltage controlled source for electroplating, tantalum capacitor forming and other electro-chemical processes.
- Controlled power source for electrophoresis, microbiological and chemical analysis.

**DESIGN FEATURES:**

- AMBITROL Dual amplifier control system permits continuous control of voltage or current with automatic electronic crossover to either mode of operation.
- HEATRAN Electronic power transistor dissipation control.
- Performance specifications based on anticipated ratings at end of five years of service life.
- New Silicon power transistors assure high stability and provides major breakthrough in predictable reliability.
- Pre-aged transistors with "reliability controlled" parameters for insured long life.
- "Controlled Avalanche" Silicon rectifiers to prevent line transient failures.
- Built-in circuitry eliminates the possibility of turn-on and turn-off transients.
- Dual concentric controls for coarse and fine voltage adjustment.
- Front and rear access output terminals.
- Silicon diode voltage references with complementary temperature coefficients.
- Semiconductor devices derated to 50% of rated voltage and current.
- Volt-ammeter monitors output voltage or current.
- Computer quality electrolytic capacitors.
- Line and load circuits separately fused. Accessible at front panel.
- Fifty hour pre-aging of power supplies prior to test, guarantees field service reliability.
- Modular package construction suitable for rack mounting. Single or dual mounting in 5 1/4" x 19" panel. See catalogue RPA-62 for rack panel adapters.

**ELECTRICAL SPECIFICATIONS****MODEL 2015R****CONSTANT VOLTAGE**

**RANGE:** 0-20 vdc, 0-1.5 amps continuously adjustable.

**REGULATION:** .03% or 5 millivolts max., whichever is greater for  $\pm 10\%$  line or 0-100% load.

**RIPPLE:** .0008% or 150 microvolts rms maximum.

**RESPONSE TIME:** less than 25 microseconds for 100% step changes in rated load.

**SOURCE IMPEDANCE:** 0.02  $\Omega$  to 20 kc, 0.5  $\Omega$  to 1 mc.

**STABILITY:** Less than 20 millivolts drift per 24 hours at constant ambient temperature with fixed load and external low temperature efficient programming resistor.

**TEMPERATURE COEFFICIENT:** D-C output voltage change less than .02% per degree Centigrade.

**REMOTE PROGRAMMING RESISTANCE:** 200  $\Omega$  per volt.

**VOLTAGE CONTROL:** Dual concentric fine and coarse adjustment with 2.5 millivolts resolution.

**INPUT:** 105-125 VAC 50-440  $\sim$ , single  $\phi$

**OPERATING TEMPERATURE:** 0-60°C.

**OUTPUT TERMINALS:** Front panel binding posts and rear access terminal strip. Either positive or negative output terminal may be grounded.

**CONSTANT CURRENT**

**RANGE:** 0-1.5 Amperes, continuously adjustable.

**REGULATION:** .02% or 200 microamperes, whichever is greater, for line or load variations down to a short circuit across the output terminals.

**VOLTAGE COMPLIANCE:** 20 volts maximum.

**RIPPLE:** Ripple component of the output current less than .02% or 150 microamperes, whichever is greater.

**SOURCE IMPEDANCE:** 100,000  $\Omega$  approx.

**STABILITY:** Less than 0.1% or 1 MA. drift per 24 hours at constant ambient temperature with fixed load and low temperature efficient external programming resistor.

**TEMPERATURE COEFFICIENT:** D-C output current change less than .04% per degree Centigrade change in ambient.

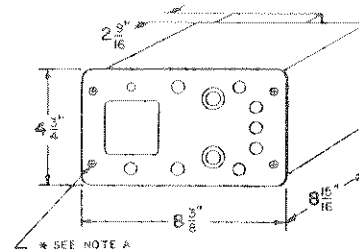
**MECHANICAL SPECIFICATIONS****MODEL 2015R**

WEIGHT: 9 1/2 lbs.

**FINISH:** Brushed anodized natural aluminum panel with etched black lettering. Cabinet finished in blue enamel. Chassis, golden irridite.

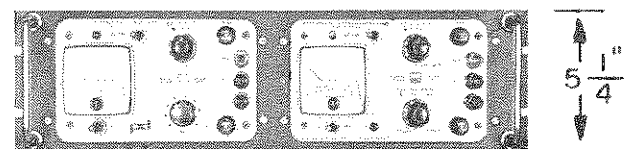

MODEL 2015R ..... \$175<sup>50</sup> FOB WESTBURY

**POWER DESIGNS INC.**

1700 SHAMES DRIVE, WESTBURY NEW YORK  
516 Edgewood 3-6200 TWX: 516 333-5698

**POWER DESIGNS PACIFIC, INC.**

3381 Junipero Serra, Palo Alto, Calif.  
415-321-6111 TWX: 415-492-9219

# POWER SUPPLY MODEL 2015R

## SECTION 1 GENERAL DESCRIPTION

### 1-1. GENERAL

The Model 2015R is a general purpose DC power source designed to furnish regulated voltage or current for electronic and scientific laboratory instrumentation.

Using silicon semiconductor devices exclusively and such field proven proprietary techniques as Ambitrol<sup>®</sup> and Heatran<sup>®</sup>, the power supply has a reliability and versatility not normally available in equipment of this type.

The Ambitrol<sup>®</sup> dual amplifier control system permits operation of the Model 2015R as a constant voltage or constant current source over its entire operating range with automatic electronic transfer to either mode at any predetermined operating point. The supply is completely protected against internal damage for any load condition and may be operated continuously into a short circuit. Protection of the load is assured by continuously adjustable current limiting in the constant voltage mode and continuously adjustable voltage compliance in the constant current mode.

The Heatran<sup>®</sup> technique of power transistor dissipation control makes possible the transfer of up to 90% of the normal power dissipation of the series pass transistors into external vitreous enamel resistors, reducing the junction temperature of the transistors and lowering internal ambient temperatures in the equipment.

The output voltage or current may also be controlled from a remote location by means of external fixed or variable resistors.

Compact and light, the power supply is self-contained in any integral housing for laboratory bench use. Tapped rivnuts are provided on the face of the unit for panel mounting in a test console or in a relay rack. Accessory panel adapters with a height of 8-3/4" are available for mounting one or two units in a standard 19" relay rack.

### 1-2. ELECTRICAL SPECIFICATIONS

Refer to Table 1 for a complete list of the electrical specification

### 1-3. MECHANICAL SPECIFICATIONS

a. Dimensions: 8-3/8 inches wide by 4-3/4 inches high by 8-15/16 inches deep (without Heatran case). Heatran case is 2-9/16 inches deep.

b. Finish: The panel is finished in brushed anodized natural aluminum with etched black lettering; the housing in blue enamel; the chassis gold iridited.

c. Weight: 9½ pounds

TABLE 1. ELECTRICAL SPECIFICATIONS

Input	105 to 125 volts, 55 to 440 Hz, single phase, 65 watts (nominal).	
Operating Temperature Range	0 to 60°C	
<u>Output</u>	<u>Constant Voltage Mode</u>	<u>Constant Current Mode</u>
Range	0 to 20 VDC, 0 to 1.5 A, continuously adjustable.	0 to 1.5 amperes, continuously adjustable.
Regulation	0.01% +3 millivolts for line voltage change of $\pm 10\%$ or 100% change in rated load.	0.02% or 200 microamperes, whichever is greater, for line change of $\pm 10\%$ or load variations down to a short circuit across the output terminals.
Ripple	Less than 0.0008% or 150 microvolts rms.	Less than 0.02% or 150 microamperes, whichever is greater.
Voltage Compliance	20 volts maximum	
Response Time	Less than 25 microseconds to return within regulation limits for a step change (1 microsecond rise time) of 10 to 100% or 100 to 10%.	
Source Impedance	Less than 5 milliohms at DC, 0.02 ohm at 20 KHz, 0.5 ohm at 1 MHz.	Greater than 100,000 ohms.
Stability	Better than 20 millivolts drift per 24 hours at constant ambient temperature, fixed line and load, and with external low temperature coefficient programming resistance.	Better than 0.1% or 1 MA drift per 24 hours at constant ambient temperature, fixed line and load, and with low temperature coefficient external programming resistance.
Temperature Coefficient	Less than 0.02% per degree C.	Less than 0.02% plus 300 microamperes per degree C.
Remote Programming Constant	200 ohms per volt.	
Voltage Control	Dual concentric fine and coarse adjustment with 2.5 MV resolution.	
Output Terminals	Front panel binding posts and rear access terminal strip. Either positive or negative output terminal may be grounded, or the supply may be left floating.	

SECTION 2  
INSTALLATION AND OPERATION

## 2-1. INSTALLATION

The Model 2015R has been thoroughly inspected and tested prior to shipment and is ready for operation as received.

## 2-2. CONSTANT VOLTAGE OPERATION

- a. Turn CURRENT control to 1.5A.
- b. Turn both concentric VOLTAGE controls to the extreme counterclockwise position.
- c. Make sure the AC ON toggle switch is in the off position. Connect AC power cord into convenient source of 115 volts AC, 50 to 440 Hz.
- d. Turn AC ON toggle switch to its on position. The red neon pilot indicator should light. If not, check the AC line power and the 3/4 ampere panel fuse.
- e. Turn the V-A meter function switch to V and set the VOLTAGE controls to the desired value. The small concentric knob is a fine adjustment with a range of approximately 50 millivolts and permits setting of the output voltage with a resolution of 0.25 millivolts approximately.

Current Limiting

a. The maximum power supply output may be limited by adjustment of the CURRENT control to the desired value as indicated on the panel. These panel calibrations are accurate to approximately  $\pm 10\%$ . For more precise setting, turn the CURRENT control to its extreme counterclockwise position.

NOTE

This control covers the full range of output current and when adjusted below the 0 calibration point, it will cause the output voltage of the supply to collapse to zero since no current is available for the voltage regulator amplifiers, meter, etc. This control may therefore be used as a means for placing the supply in a stand-by condition. It also provides another operational advantage in that, if the output voltage of the supply is preset before application of the load; the CURRENT control set to its extreme counterclockwise position; the load connected and the CURRENT control slowly advanced with the meter switch in the "A" position, the load current may then be monitored. If the load current rises to excessive values as the CURRENT control is advanced, the condition can be observed before destructive currents can flow into the load circuits.

b. Connect a milliammeter or ammeter with the desired accuracy directly across the output terminals of the supply and advance the CURRENT controls to the maximum desired current value as indicated on this instrument.

c. The CURRENT control may also be adjusted with a short circuit across the output terminals and the power supply ammeter as an indicating device with the N-A switch in the A position.

#### Front and Rear Terminals

a. The power supply output may be obtained by connecting the load to the front panel binding posts or the rear access screw terminals marked DC+ and DC-. A jumper may be connected from either output terminal to the ground or chassis binding post marked G on the front panel, or the supply may be left floating.

#### 2-3. REMOTE VOLTAGE PROGRAMMING

To operate the power supply as a constant voltage source controlled from a remote location:

- a. Turn AC ON toggle switch off.
- b. Remove the wire jumper between screw terminals RV1 and RV2 on the rear access terminal strip.
- c. Connect the external programming resistor between terminals RV1 and DC+. The output voltage is proportioned to the resistance by a factor of 200 ohms per volt of output. This value is approximate and may have to be trimmed slightly to produce the exact output voltage required. A constant current of 5 milliamperes will flow through this resistor and its wattage rating and temperature coefficient should be chosen to minimize drift.
- d. Restore AC power to the supply.

#### 2-4. CONSTANT CURRENT OPERATION

- a. Turn both concentric VOLTAGE controls to the extreme clockwise position.
- b. Turn CURRENT control to the extreme counterclockwise position.
- c. Set meter function switch to A. Connect a short circuiting jumper across the output terminal of the supply.
- d. Adjust CURRENT control to desired output current. Remove short circuit and connect external load. For more precise setting an external meter may be used (as described in Current Limiting). A jumper may be connected from either output terminal to the G or chassis ground binding post on the front panel or the supply may be left floating. Since the nature of a constant current supply is that of a high impedance source, the electrostatic (capacitive) relationship of the constant current source of the external load to external ground and/or the AC line may affect the ripple component of the current output. Reversing the AC line cord to the supply and experimentally selecting an optimum grounding point at the load or operating the supply ungrounded, may reduce this ripple component to a minimum. Leave the meter switch in the A position. If the switch is in the V position, the constant current load regulation will increase by 1 MA.

e. Voltage Compliance - To limit the maximum output voltage remove the load and adjust the VOLTAGE controls to the desired value as indicated on the panel meter. This limits the maximum voltage compliance of the supply even if the load should become open circuited.

## 2-5. REMOTE CURRENT PROGRAMMING

To operate the power supply as a constant current source, controlled from a remote location:

- a. Turn VOLTAGE control to the desired voltage compliance.
- b. Turn CURRENT control to its maximum clockwise position.
- c. Connect the external programming resistor between screw terminals RC and DC+ on the rear access terminal strip. The value of this resistor can be determined by the relationship:

$$R = \frac{174 I}{1.6 - I}$$

where: R = external programming resistor in ohms  
I = required output current in amperes

### NOTE

The value of R is approximate and may require additional adjustment for the desired output current.

## 2-6. ELECTRONIC CROSSOVER FROM VOLTAGE TO CURRENT OR VICE VERSA

The Model 2015R power supply may be operated to switch electronically from a constant voltage source to a constant current source, or vice versa, at any predetermined voltage or current in its operating range. The power supply will then function as a voltage or current regulator determined solely by the preset voltage or current values and the value of the load resistance in accordance with the Ohm's Law:

$$E = IR$$

where: E is the preset voltage (set as directed in 2-2)  
I is the preset current (set as directed in 2-4)  
R is the external load resistance

For example: If R is sufficiently large in value so that at the preset value of E a current lower than the preset value of I will flow, the power supply will function as a constant voltage source. If R is sufficiently small in value so that at the preset value of E a current equal to or greater than the preset value of I can flow, the power supply will function as a constant current source to maintain the preset value of I and E will vary accordingly with the load resistance. The power supply will automatically switch back and forth to either mode depending upon the load resistance.

## 2-7. PARALLEL OPERATION

- a. On power supply No. 1, rotate the VOLTAGE controls fully

clockwise. Connect a short circuit across the DC output terminals. Set the meter switch to A and the AC ON switch to on. Adjust the CURRENT control until the meter indicates 1.5 amperes.

b. Set the meter switch to V. Disconnect the short circuit from the output terminals. Adjust the VOLTAGE controls until the meter indicates the desired output voltage.

c. Repeat a and b for power supply No. 2. Connect the positive output terminal of No. 1 supply through a 50 MA meter to the positive terminal of No. 2 supply. Connect the two negative terminals with heavy gauge wire.

d. Adjust the voltage control on power supply No. 2 until the milliammeter indicates zero.

e. Disconnect the milliammeter and connect the positive terminals. The load may now be connected.

f. To limit the current to less than 3 amperes, the CURRENT controls should be set so that the sum of the two short circuit currents is equal to the maximum desired load current. It is not necessary to set the supplies to share the load current equally.

g. Note that the supplies do not share the load current equally for all values of load resistance. One supply may be in the current limiting mode, the other will provide the voltage regulation.



## APPENDIX

### 1. INTRODUCTION

This appendix contains an electrical parts list, schematic diagram, parts location diagram and equipment warranty.

### 2. ELECTRICAL PARTS LIST

All electrical and electronic parts are listed in the sequence of their circuit numbers, as shown on the schematic diagram. A brief description of each part is given, followed by the code number of the manufacturer and his part number. All manufacturers' code numbers are taken from Cataloging Handbooks H4-1 and H4-2, Federal Supply Code for Manufacturers. These handbooks are available through Federal Agencies. They may also be ordered directly from the Superintendent of Documents, U. S. Government Printing Office, Washington, D. C. 20402.

We recommend that all parts having the code number 98095 be ordered directly from Power Designs Inc. The commercial equivalents of these parts have either wide parameter tolerances or require special factory inspection or modification before they are suitable for use in the power supply.

All components used in the power supply or supplied as replacements are carefully inspected at the factory. Inspections are performed on a 100% basis or at AQL levels in accordance with Military Specification MIL-Q-9858 under which Power Designs Inc. has been qualified.

All semiconductors are inspected on a 100% basis. They are inspected not only for operating parameters, but also for critical characteristics related to reliability and predictable life expectancy. Some of these characteristics are observed when the device is taken beyond its normal operating regions. These test techniques have been developed under a "predictable-reliability" program in operation at Power Designs Inc. for the past ten years. Under this program, quality-control procedures are constantly reevaluated and updated as new advances are made in solid-state technology and additional experience is gleaned from field history.

Semiconductor manufacturers are constantly modifying their products. Complete lines are frequently discontinued to be replaced by devices having improved gain, operating voltage levels, and frequency response. The high-gain, closed-loop DC amplifiers used in regulator circuits are particularly sensitive to slight changes in these parameters. Commercial or military "equivalent" transistors used as replacements may affect the power supply performance. Compliance with the original specifications can be assured if replacement semiconductors are ordered from the factory.

All replacement semiconductors are processed and stocked at the factory to insure complete interchangeability with the devices in the original equipment. To insure that proper replacements are provided, the original devices are coded with a Power Designs Inc. part number as follows:

<u>MS</u>	<u>696</u>	<u>A</u>
Semiconductor manufacturer's code	Power Designs Inc. type	Suffix identifying special parameters

When ordering replacements, please identify the device as completely as possible, listing the model and serial number if available.

In some cases, the replacement part received may have a different part number from that given in the Electrical Parts List. This can be due to several factors:

- a. A different prefix indicates that Power Designs Inc. is using a different vendor source. The operating characteristics of the devices are identical.
- b. A completely different part number indicates:
  1. The original vendor discontinued manufacture of the item or could no longer manufacture it to the original specifications.
  2. A better device for use in the particular circuit has been substituted.
  3. Tighter controls for interchangeability have provided greater assurance of improved reliability with the new replacement.

## ELECTRICAL PARTS LIST

NOTE: When replacing semiconductors or investigating their part numbers, note the information in paragraph 2 above.

<u>Circuit Number</u>	<u>Description</u>	<u>Mfr Code Number</u>	<u>Part Number</u>
C1	Capacitor, ceramic disc, 0.01 uf, 1 kvdc	98095	CC-13-10
C2	Capacitor, electrolytic, 4300 uf, 40 vdc	98095	CE-73-.4
C3	Capacitor, electrolytic, 20 uf, 100 vdc	98095	CE-103-1
C4,*C5	Capacitor, plastic film, 0.1 uf, 200 vdc	98095	CP-17-2
*C6	Capacitor, ceramic, 330 pf, 500 vdc	98095	CC-26-5
C7	Capacitor, electrolytic, 8 uf, 100 vdc	98095	CE-42-1
C8	Capacitor, electrolytic, 50 uf, 50 vdc	98095	CE-75-.5
C9	Capacitor, electrolytic, 2000 uf, 25 vdc	98095	CE-74-.25
C10,C11	Capacitor, electrolytic, 8 uf, 25 vdc	98095	CE-21-.25
*C12	Capacitor, plastic film, 0.0033 uf, 200 vdc	98095	CP-18-2
C14	Capacitor, plastic film, 0.01 uf, 200 vdc	98095	CP-16-2
C15	Capacitor, electrolytic, 50 uf, 50 vdc	98095	CE-75-.5
C16	Capacitor, ceramic disc, 0.01 uf, 1 kvdc	98095	CC-13-10
C17	Capacitor, plastic film, 0.01 uf, 200 vdc	98095	CP-16-2
CR1,CR2	Diode, silicon	98095	ST241
CR3,CR4	Diode, silicon	98095	GI44
CR5	Diode, silicon	98095	D10
CR6	Diode, silicon, zener	98095	CD410
CR7	Diode, silicon, zener	98095	CD310
CR8 thru CR11	Diode, silicon	98095	D10
CR12	Diode, silicon, zener	98095	WZ734B
CR13	Diode, silicon	98095	ST241
CR14	Diode, silicon	98095	D10
F1	Fuse, "Slo-Blo," 3/4 ampere	71400	MDL3/4
F2	Fuse, "Slo-Blo," 2 amperes	71400	MDL2
F3	Fuse, "Slo-Blo," 3/4 ampere	71400	MDL3/4
I1	Pilot light assembly	98095	PLA-3
M1	Meter, dual, 0-25 v/0-1.5 amp.	98095	MVA-99
Q1,Q2	Transistor, silicon, NPN	98095	RC1700
Q3	Transistor, silicon, NPN	98095	2N2270
Q4	Transistor, silicon, NPN	98095	MS2270/U
Q5	Transistor, silicon, PNP	98095	MS1028A
Q6	Transistor, silicon, NPN	98095	MS2270/U
Q7	Transistor, silicon, PNP	98095	MS1028A
Q8,Q9	Transistor, silicon, NPN	98095	MS2270/U
Q10	Transistor, silicon, PNP	98095	MS1028A
R1, R2	Resistor, wirewound, 12.5 ohms, 5%, 45 w	98095	RWF-125-P3
R3	Resistor, composition, 3.9 k ohms, 10%, 1 w	01121	GB3921
R4	Resistor, composition, 56 ohms, 10%, 1/2 w	01121	EB5601
R5	Resistor, wirewound, 200 ohms, 5%, 5 w	98095	RW-201-3DA
R6	Resistor, wirewound, 100 ohms, 5%, 5 w	98095	RW-101-3DA
R7	Resistor, composition, 150 ohms, 10%, 1/2 w	01121	EB1511
R8	Resistor, wirewound, 1 ohm, 5%, 7 w	98095	RW-010-3RA
R9	Resistor, variable, wirewound, 200 ohms, 10%, 1 1/4 w	98095	RWT-201-C4
*R10	Resistor, composition, 56 ohms, 10%, 1/2 w	01121	EB5601

\*Stabilization networks. Values indicated are design centers.

<u>Circuit Number</u>	<u>Description</u>	<u>Mfr Code Number</u>	<u>Part Number</u>
R11	Resistor, composition, 150 ohms, 10%, $\frac{1}{2}$ w	01121	EB1511
R13	Resistor, variable, wirewound, 200 ohms, 10%, 3 w	98095	RWV-201K4.68
R14	Resistor, composition, 820 ohms, 10%, $\frac{1}{2}$ w	01121	EB8211
R15, R16	Resistor, composition, 2.7 k ohms, 10%, $\frac{1}{2}$ w	01121	EB2721
R17	Resistor, composition, 1.5 k ohms, 10%, $\frac{1}{2}$ w	01121	EB1521
R18	Resistor, variable, wirewound, 500 ohms, 10%, $1\frac{1}{4}$ w	98095	RWT-501-C4
R19	Resistor, composition, 1 k ohm, 10%, $\frac{1}{2}$ w	01121	EB1021
R20	Resistor, composition, 1 megohm, 10%, $\frac{1}{2}$ w	01121	EB1051
*R21	Resistor, composition, 1 k ohm, 10%, $\frac{1}{2}$ w	01121	EB1021
R22	Resistor, composition, 2.2 k ohms, 10%, $\frac{1}{2}$ w	01121	EB2221
R23	Resistor, composition, 150 ohms, 10%, $\frac{1}{2}$ w	01121	EB1511
R24	Resistor, variable, wirewound, 500 ohms, 10%, $1\frac{1}{4}$ w	98095	RWT-501-C4
R25	Resistor, wirewound, 2 k ohms, 5%, 5 w	98095	RW-202-3DA
R26	Resistor, composition, 560 k ohms, 10%, $\frac{1}{2}$ w	01121	EB5641
R27	Resistor, var., wirewound, dual concentric, 4 k ohms, 5%, 4 w; 100 ohms, 10%, 4 w	98095	RWWT-5802
R28	Resistor, composition, 10 megohms, 10%, $\frac{1}{2}$ w	01121	EB1061
R29	Resistor, composition, 270 ohms, 10%, 2 w	01121	HB2711
R30	Resistor, composition, 56 ohms, 10%, $\frac{1}{2}$ w	01121	EB5601
R31	Resistor, composition, 270 k ohms, 10%, $\frac{1}{2}$ w	01121	EB2741
R32	Resistor, composition, 220 ohms, 10%, $\frac{1}{2}$ w	01121	EB2211
R33	Resistor, composition, 1 k ohm, 10%, $\frac{1}{2}$ w	01121	EB1021
R34	Resistor, wirewound, 700 ohms, 5%, 5 w	98095	RW-701-3DA
R35	Resistor, wirewound, 500 ohms, 5%, 5 w	98095	RW-501-3DA
R36	Resistor, composition, 560 ohms, 10%, $\frac{1}{2}$ w	01121	EB5611
R37	Resistor, precision, metal film, 24.9 k ohms, 0.5%, $\frac{1}{4}$ w	98095	RW-2492-6Q
R38	Resistor, wirewound, variable, 50 ohms, 10%, $1\frac{1}{2}$ w	98095	RWT-500-C4
R39	Resistor, meter shunt	98095	RWF-00067
R40	Resistor, composition, 5.6 ohms, 10%, 1 w	01121	GB56G0
*R41	Resistor, composition, 150 ohms, 10%, $\frac{1}{2}$ w	01121	EB1511
R42, R43	Resistor, composition, value determined at final factory calibration	01121	Type EB
S1	Switch, toggle, SPST	98095	ST-5
S2	Switch, toggle, DPDT	98095	ST-16
T1	Transformer, power	98095	TTM-45

\*Stabilization networks. Values indicated are design centers.

#### CODE LIST OF MANUFACTURERS

<u>Code Number</u>	<u>Manufacturer</u>	<u>Address</u>
01121	Allen-Bradley Company	Milwaukee, Wisconsin
71400	Bussman Manufacturing Div.	St. Louis, Missouri
98095	Power Designs Inc.	Westbury, New York

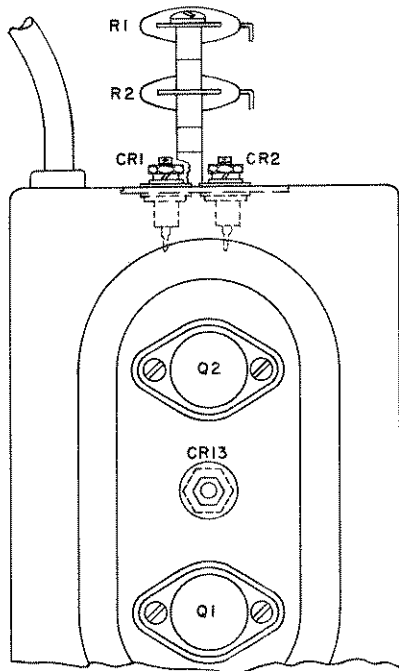

PARTIAL VIEW OF CHASSIS WITH COVER & HEATRAN CAGE REMOVED SHOWING LOCATION OF COMPONENTS

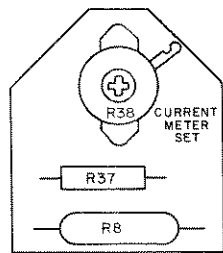

LOCATION OF COMPONENTS METER BOARD

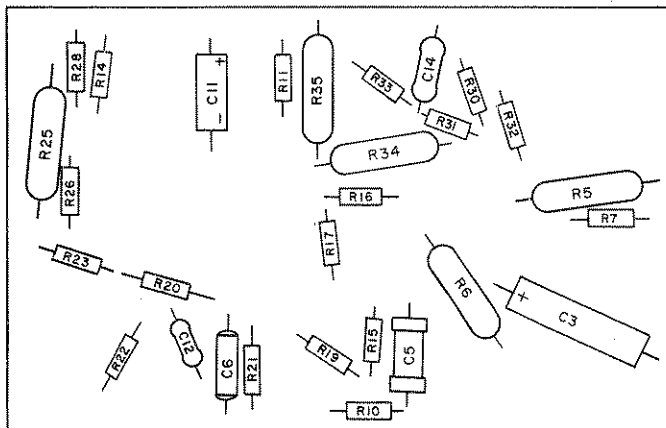

LOCATION OF COMPONENTS-AMPLIFIER BOARD-REAR VIEW

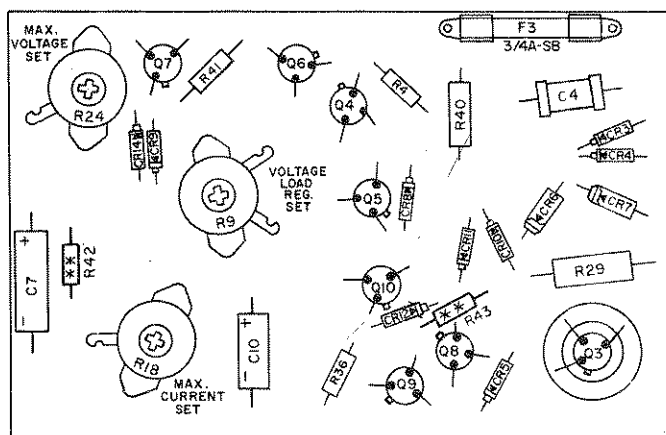

LOCATION OF COMPONENTS-AMPLIFIER BOARD-FRONT VIEW

\* R10, C5, R21, C6 & R41, C12 ARE STABILIZATION NETWORKS. SEE MANUAL

\*\* R42 & R43, WHEN USED, ARE SELECTED VALUES. SEE MANUAL.

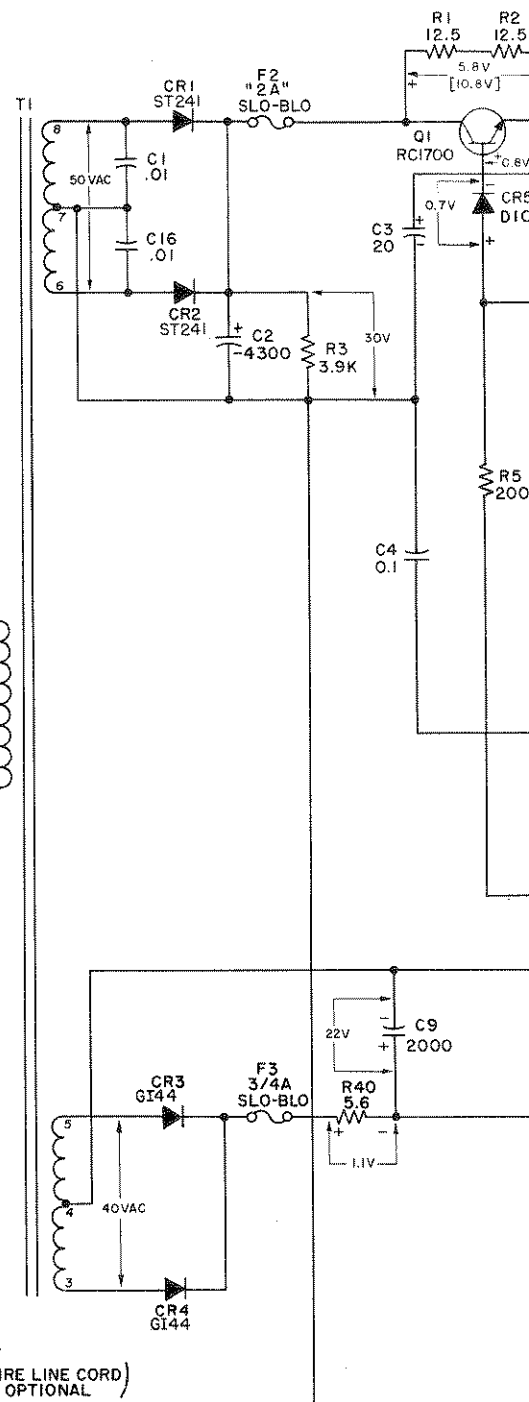

UNLESS OTHERWISE SPEC.  
ALL RESISTORS ARE IN OHMS  
ALL CAPACITORS ARE IN MICROFARADS

VOLTAGES INDICATED ARE MEASURED WITH A 20,000Ω/VOLT METER WHERE OTHERWISE INDICATED.  
CONSTANT VOLTAGE MEASURE THE "CURRENT" CONTROLS R13 IS SET  
CONSTANT CURRENT MEASURE THE "VOLTAGE" CONTROLS R27A  
WHERE DUAL VOLTAGES ARE INDICATED CONSTANT CURRENT MODE.

DWG. NO. PS-2015R-13 REV. L

MODEL 2015R  
TRANSISTORIZED POWER SUPPLY

0-20V  
CONSTANT VOLTAGE

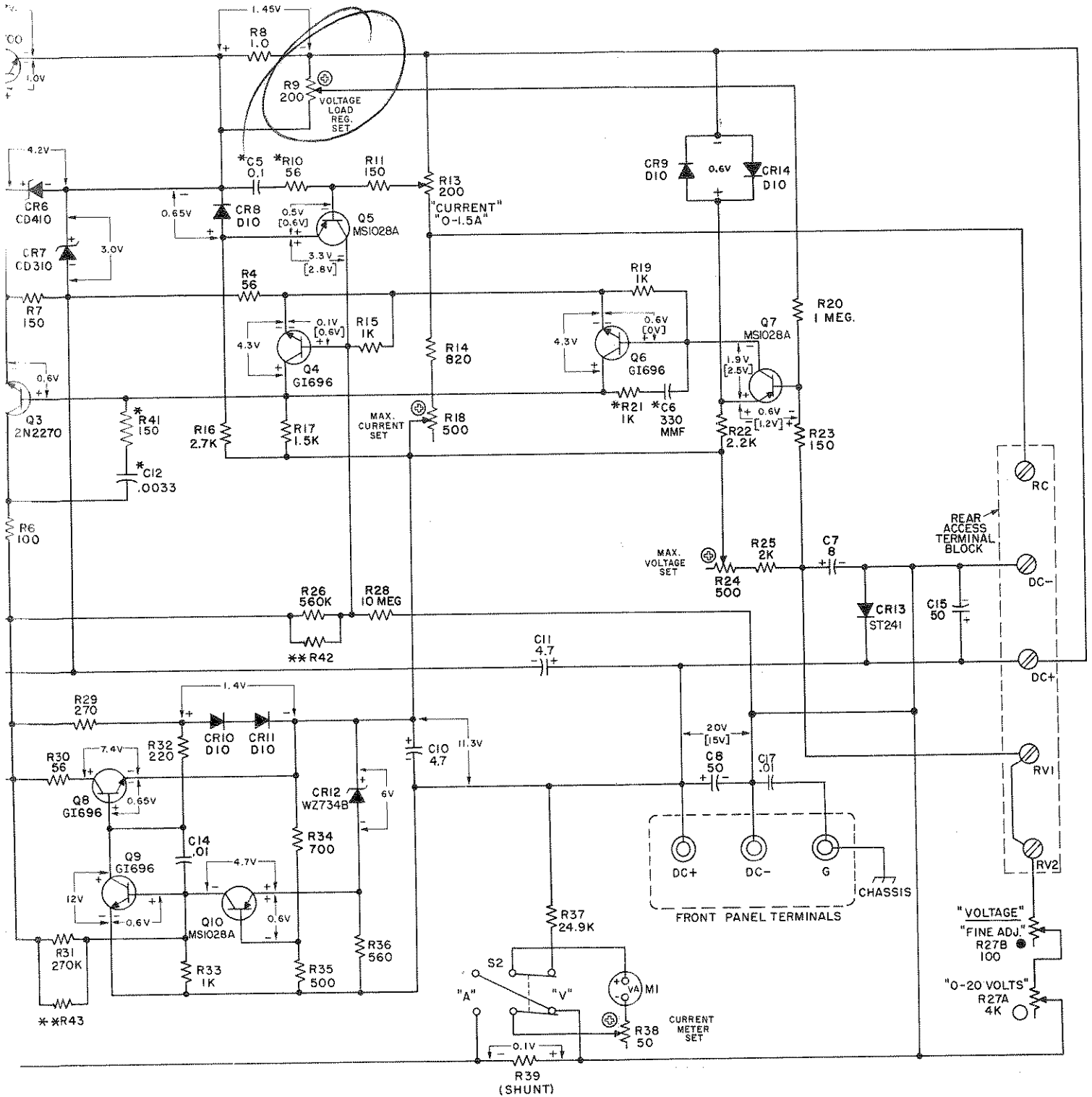

WITH 115VAC, 60HZ INPUT. MEASUREMENTS ARE MADE DC AND 1000Ω/VOLT FOR AC. VOLTAGES ARE DC EXCEPT

ARE MADE WITH 20VDC OUTPUT AND A 1.5A LOAD. THE MAX. CLOCKWISE POSITION.

ARE MADE WITH A 1.5A OUTPUT INTO A 10Ω 25W LOAD. B ARE SET TO MAX. CLOCKWISE POSITION.

ED, THOSE IN BRACKETS " [ ] " PERTAIN TO THE

NOTICE  
 PATENTS HAVE BEEN GRANTED. PATENT APPLICATIONS ARE PENDING OR IN PROCESS OF PREPARATION ON THE PROPRIETARY PORTIONS OF THE CIRCUITS SHOWN ON THIS DRAWING. REPRODUCTIONS IN WHOLE OR IN PART MAY NOT BE MADE WITHOUT PERMISSION.

L	REVISED, ECN 1185.	FRAS 11/30/66
SYM.	DESCRIPTION	APPD. DATE
REVISIONS		
DRAWN <i>R.A.S.</i>	CHECKED <i>AS</i>	APPD. <i>[Signature]</i>
DATE 12/6/62	DATE 12/13/62	DATE 12/13/62

-1.5A  
 INSTANT CURRENT

POWER DESIGNS INC.  
 NEW YORK