

RF & Bench Essentials Reference Guide

A quick-reference guide to the essentials of
RF & Bench test and measurement equipment

ENTEST

ROHDE & SCHWARZ



Back to Basics

Much has been written, published and presented about the basics of RF and Wireless fundamentals. Basics are often told from the perspective of reviewing academic concepts focusing on design optimization. This reference guide attempts to bring you back to some of the essential elements of both digital and RF testing and measurement. While test tools play an important part of any technician or engineer's bench, those who are not using them all of the time, or only come back to them once a design is received back as a prototype, might not have a ready grasp of common measurement tool fundamentals.

Focused on the practical measurement basics and essentials as they relate to choosing and/or setting up each measurement tool found on a common RF bench, this reference guide should sit close by as you embark on setting up, or getting back to the bench for basic and more common measurements. Covering a wide range of both time domain and RF test equipment, most tools you would want to understand in a little more detail should be covered here.

In addition to explaining some of the common specifications you will see from test equipment manufacturers, this reference guide can also be a gateway to dig into some of the details contained in a more in depth fundamentals or primers guide on specific measurement instruments. These can always be located at our website or through one of our distribution partners.



RF & Bench Essentials Reference Guide

A quick-reference guide to the essentials of
RF & Bench test and measurement equipment

In This Guide



04 Spectrum Analyzers

Broad portfolio of handheld and benchtop instruments that set standards in accuracy, RF performance and usability, for applications from education and embedded design to next-generation chipset design.



06 Signal Generators

Switch it on and generate signals with ease. Performance-leading generators that are easy to use and full of application specific capabilities at a remarkable price.



08 Vector Network Analyzers (VNAs)

VNAs from 3 GHz to 500+ GHz with industry-leading performance. The perfect tools for analyzing passive and active components such as cables, filters, amplifiers, mixers, and complex multiport devices (up to 48 ports).



10 Oscilloscopes

Truly uncompromising performance for all debugging tasks. Designed by the RF experts at Rohde & Schwarz, all of our oscilloscopes feature exceptional signal integrity, high value and excellent reliability.



12 RF Power Sensors

Get accurate results faster. Our power sensors are the most accurate and have the least amount of uncertainty of any on the market, enabling users to quickly make reliable measurements even at low power levels.



14 Power Supplies & Meters

More flexible channels in far less space. Rohde & Schwarz Power Supplies offer excellent performance and are compact to fit on your bench.



16 Other Bench Products

Rohde & Schwarz offers many cost effective instruments commonly found on the lab bench. These include digital multimeters, LCR meters, power analyzers, arbitrary waveform generators, and audio analyzers. These high quality instruments adhere to the same strict manufacturing guidelines as all Rohde & Schwarz products and deliver outstanding measurement characteristics.

Spectrum Analyzers

Handheld, Portable, or Benchtop Performance

Spectrum analyzers are single-channel receivers that measure basic signal amplitude characteristics like carrier level, sidebands and harmonics ranging from as low as 2Hz up to 85GHz.

More advanced models demodulate and measure more complex signals. A spectrum analyzer can also be used for scalar component test with a tracking generator or external source.

Frequency Coverage

“Does the spectrum analyzer have the necessary frequency range to capture your signal of interest?”

Different measurement applications may require a larger frequency sweep range to evaluate harmonics, spurs and Intermodulation Distortion (IMD) effects in alternate channels (ACPR). This may warrant consideration of a higher bandwidth solution than previously thought to ensure the capture of all potential signals of interest.

Lower ranges also need to be a consideration for those interested in EMC applications.

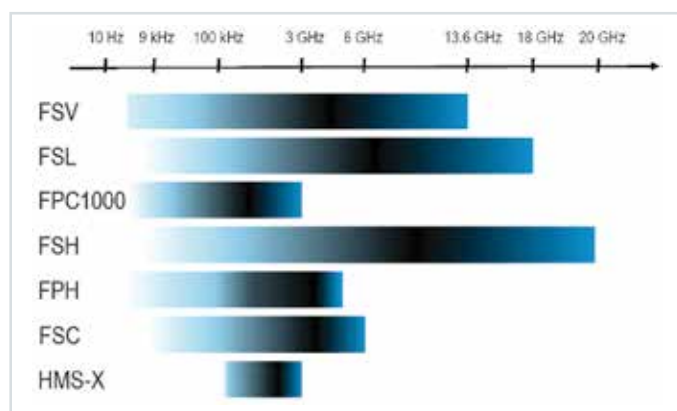

R&S® Spectrum Analyzers cover a range of frequencies



R&S®FPC1000

Resolution Bandwidth (RBW) and Dynamic Range

“Does your application require measurements of multiple signals (or modulation components) with varying power levels and narrow frequency spacing?”

There are various definitions of dynamic range which are shaped by the parameters of ‘Displayed Average Noise Level’ (DANL), ‘Third Order Intercept’ (TOI) and resolution bandwidth settings on a spectrum analyzer.

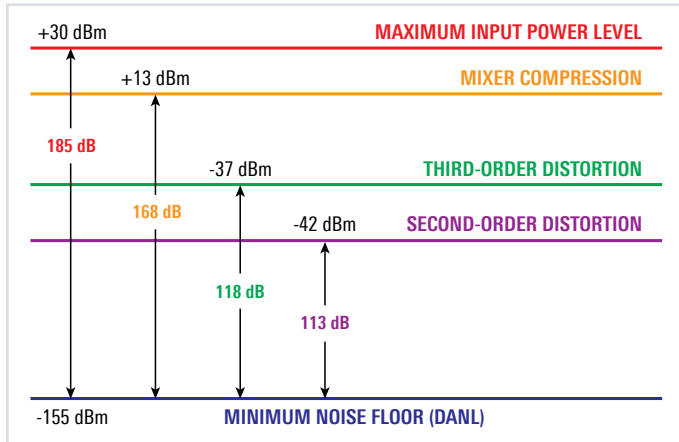

A large range of RBW settings, coupled with low DANL and high TOI values, will improve the analyzer’s ability to detect weak signals in the presence of strong signals. This is especially important for measurement of spurious emissions (“spurs”).

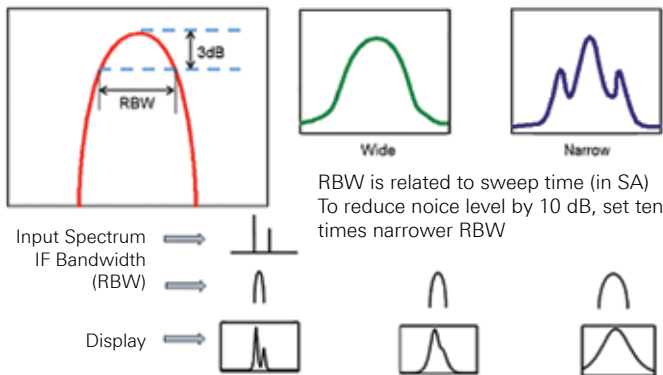

Phase Noise

“Do you need to perform phase noise measurements on signal sources or make measurements that are sensitive to phase noise?”

Phase noise is a key spectrum analyzer parameter which will have an impact on measurements close to the carrier signal. A spectrum analyzer’s inherent phase noise will dictate the measurement margin. Additionally, the analyzer’s inherent phase noise may adversely impact Error Vector Magnitude (EVM) measurements of digitally-modulated signals.

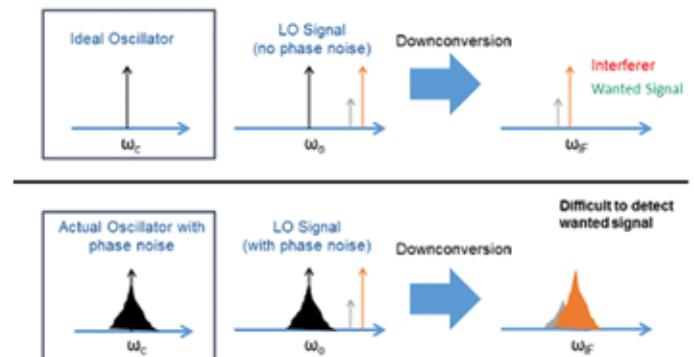

Demodulation

“Does your application require demodulation capability?”

Some applications may require the ability to measure signals employing amplitude, frequency, and/or phase modulation. Some may also require the ability to measure digitally modulated signals such as those comprising many of today’s wireless standards. Spectrum analyzers offer varying degrees of flexibility for addressing these modulation techniques.



Signal Generators

A Flexible Tool for A Broad Scope of Applications

The signal generator's wide frequency range, high output power and variety of modulations make it a flexible tool for a broad scope of applications. Signal generators with a minimum frequency of 9 kHz permit applications in Electromagnetic Compatibility or EMC measurements. Frequency coverage up to 12.75 GHz covers ISM bands as well as all important mobile radio bands. Microwave signal generators support frequencies up to 20 GHz, 40 GHz and even 110 GHz.

Output power, phase noise, frequency range, and harmonics are just a few of the key parameters when it comes to selecting the right analog signal generator. However, many real-world measurements require to focus on more than just one aspect simultaneously. This section provides an overview of some of the key signal generation specifications you will need to consider.

Analog vs. Vector

One of the most important factors to determine upfront is whether an analog or vector signal generator is best for your application. Analog signal generators have the ability to generate CW signals or to vary the amplitude, frequency and phase of a signal to create different forms of modulation such as amplitude modulation (AM), frequency modulation (FM) and phase modulation (PM). Modulation formats may also be combined, such as adding FM onto an AM signal. Vector signal generators, on the other hand, have the ability to vary two or more of these modulation types—at the same time.

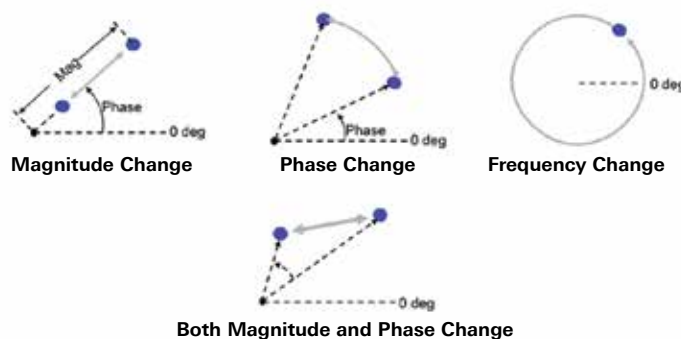

R&S®SMBV100A

Output Power

Another important specification on a signal generator is output power. However, it is important to note that the actual maximum output level from a signal generator may be significantly higher than the specified output power level. Most signal generators will allow users to enter values well above the maximum specified power level. Datasheets for signal generators contain charts that show maximum available output power that can be obtained.



Actual maximum output power of a signal generator is often found in the products data sheet. Example of the R&S SMF with and without the high output power option in the frequency range 1 to 22 GHz.

Phase Noise

In the frequency domain, an ideal carrier signal would appear as a small thin line. The typical signal however, will have sidebands created by random AM and FM noise from the oscillator. All oscillators do this as no design is perfect. Designers care about phase noise because it influences the signal quality and adds unwanted noise into the DUT.

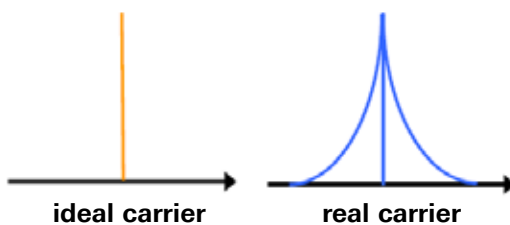

An ideal carrier would have no phase noise, but a real signal would look like this.

For low phase noise measurements, a clean signal source is required. Normally, the performance of the signal source must show a considerable margin in order not to introduce additional errors.

Frequency Setting Time

Frequency setting time, or frequency switching time as it is sometimes called, is the amount of time it takes for a signal generator to stabilize at a given frequency for an accurate measurement. Setting times are typically less than 1 ms, so it is only an issue in automated test environments (ATE) where test time is critical.

ATE systems are not just found in manufacturing; they can be found in the R&D lab as devices are put through long testing cycles at various frequencies, temperatures, power levels, etc., so that their performance can be fully characterized before the design is finalized and moved into production.

Real-Time Generation of Digital Modulation

A vector signal generator creates digitally modulated signals (e.g., LTE, W-LAN, etc.) although some generators do it more efficiently than others. The R&S SMBV100A creates all the signals internally, in real time. This means as soon as the user configures the signal from the front panel, the R&S SMBV creates the signal and plays it out.

Not all products do this. They create some signals in real time, but the majority must be created with offline software. Files from the offline software must then be transferred to the generator. This adds an extra step that can become extremely time-consuming when the user wants to continually modify the signals (e.g., when troubleshooting a design).

Vector Network Analyzers

Exceptional Performance, High Value and Reliability

Like spectrum analyzers, radio frequency network analyzers (VNAs) are also extensively used in RF design. Network analyzers are often used to measure microwave and mm-wave devices, but they can also be used for common IF-frequency components (< 200 MHz).

They can be used for analyzing the different properties of electrical networks, related to the transmission and reflection of electrical signals. VNAs include at least one source to stimulate the device under test (DUT) in the forward and reverse direction.

Dynamic Range

Dynamic range is the maximum measurement range of a VNA. It is limited by the noise floor (at the low end) and output power (at the high end) as well as the IF bandwidth setting of the VNA. Wide dynamic range is especially important for measuring filters with sharp cutoff transitions, and for achieving fast measurement speed via a wide IF bandwidth setting.

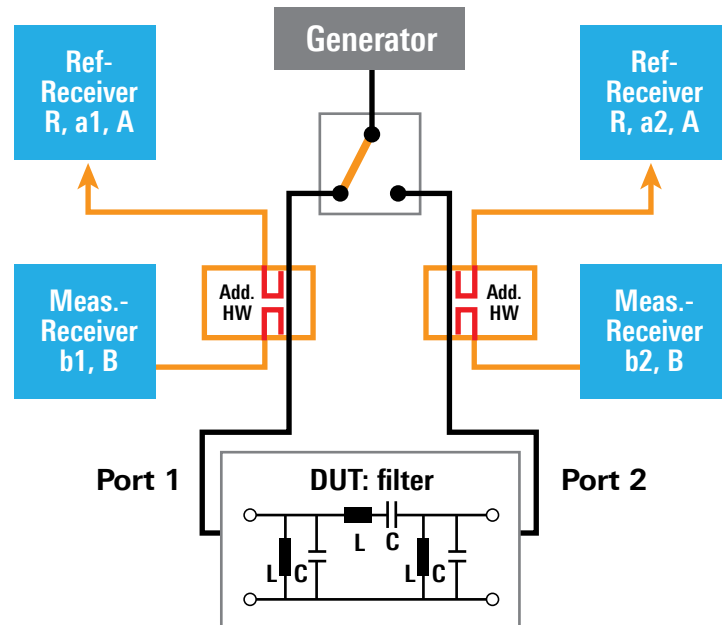

One reference and measurement receiver only.



R&S®ZNB

Familiar Interface with Enhanced Usability

Since a VNA makes complex measurements, usability is paramount. Operation based on familiar VNA interfaces but modernized with easy wizard-driven measurements can make the job much easier. A touchscreen adds a welcome level of convenience to the already intuitive user interface.

Other things to look for are the ability to arrange the display area as needed with functions such as 'drag-and-drop' for traces and display areas. A multi-level undo and redo option is available, as well as an "Auto Cal" function which saves setup time.

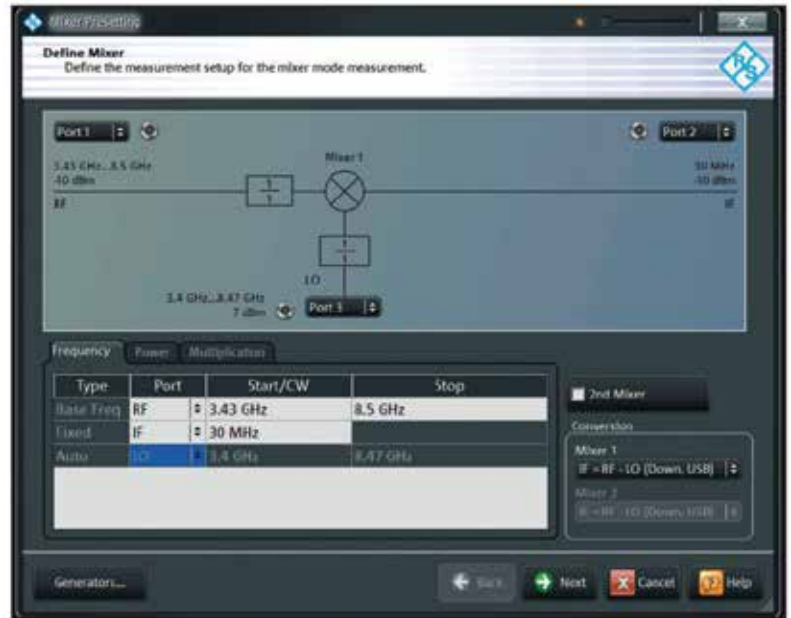

Power Sweep Range

Power sweep range determines the range of power that can be applied to a DUT. It is especially important for amplifier characterization as well as nonlinear measurements. The maximum and minimum output power also determines if external components are required for your amplifier testing.

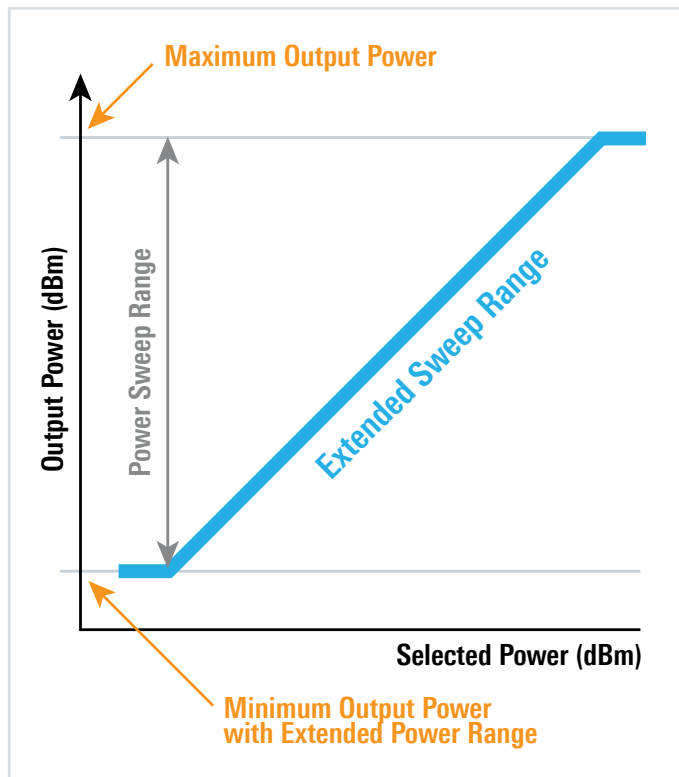

Measurement Speed

A complete VNA measurement consists of:

- (1) sending a stimulus
- (2) measuring its response
- (3) applying an error correction
- (4) de-/embedding and offset
- (5) generating a trace to display measurement results

Measurement speed depends on many different factors including the IF bandwidth, the settling time, the number of ports, frequency range, automatic level control (ALC) setting, the error correction model and the trace type. Measurement speed is critical, especially in a production environment.

Oscilloscopes

Exceptional Signal Integrity, High Value, and Excellent Reliability from 50 MHz to 6 GHz

The Rohde & Schwarz digital oscilloscope portfolio offers options from low cost yet powerful, 50 MHz scopes to full-featured 6 GHz oscilloscopes. Designed by the RF experts at Rohde & Schwarz, all our oscilloscopes feature exceptional signal integrity, high value and excellent reliability.

Bandwidth Selection

Bandwidth selection is typically the most crucial parameter for choosing a scope. Bandwidth is defined as the frequency at which a sine wave is attenuated to -3 dB or is ~30% smaller.

Since most signals are not sine waves (they look like square waves), you have to take into account the other frequency components that make up the signal. For example, you can't measure a 1 GHz square wave with a 1 GHz scope. It won't look like a square wave, but rather a sine wave since only the fundamental frequency is captured.

Rule of thumb: The simplest way to determine how much bandwidth you may need to take 3x to 5x the clock frequency of the signal you want to measure. For example, a USB high-speed signal at 480 Mb/s has a clock frequency of 240 MHz which would require a 720 MHz to 1.2 GHz scope. Generally choosing a higher bandwidth (5x the clock frequency) will give you better signal representation, but obviously the higher the frequency, the more expensive the test solution.

Sample Rate/Memory Depth

Sample rate and memory depth are directly related. The sample rate is how often the oscilloscope samples and digitizes the waveform, but those samples have to be stored somewhere, which is why memory is important. Since storing waveforms at a faster rate consumes more memory, a deep memory buffer allows you to keep your sample rate high, which also allows you to take advantage of the full bandwidth of the scope.

Rule of thumb: For the sample rate, you typically want it to be 5x the bandwidth of the scope to accurately reproduce the signal. For example, for a 1 GHz scope, you want a sample rate of 5 GS/s. There are a few times that you can get by with less (down to 2.5x), but in general, use a sample rate at least 5x the bandwidth.

As mentioned, memory depth is directly related to the sample rate. The more memory depth you have, the longer amount of time you can capture at high sample rates. You may have an idea of the time capture you desire, or simply know you want to capture as much time as possible to ensure you are able to see any issue present on the signals.

See the chart on the next page for some examples of time versus sample rates.

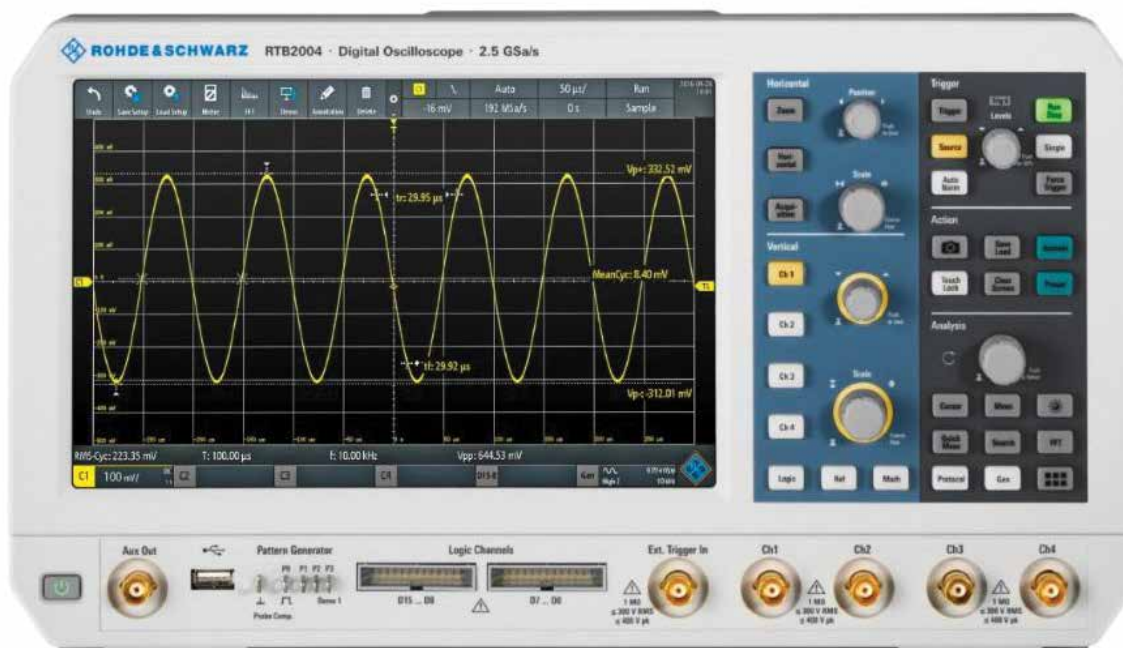

R&S®RTB2000

Time vs. Sample Rate

		Oscilloscope Memory Depth					
		200MSa	100MSa	20MSa	10MSa	4MSa	2MSa
Oscilloscope Sample Rate	Max frequency of signal that can be captured	Time Captured					
5 GSa/s	1GHz	40ms	20ms	4ms	2ms	800us	400us
2.5 GSa/s	500MHz	80ms	40ms	8ms	4ms	1.6ms	800us
1 GSa/s	200MHz	200ms	100ms	20ms	10ms	4ms	2ms
500 MSa/s	100MHz	400ms	200ms	40ms	20ms	8ms	4ms
100 MSa/s	20MHz	2 secs	1 sec	200ms	100ms	40ms	20ms

Update Rate

Although often called “real time” all digital oscilloscopes have “dead time” or “blind time”. Update rate is how fast the scope can trigger on a waveform (basically one screen’s worth of data), process it and then plot it to the display. The faster it can do this, the more likely you are to see infrequent events. Update rate is typically specified in “waveforms per second” or “wfms/s”.

For example, with an update rate of 50,000 wfms/s, a scope captures a waveform every 20 μ S. If the screen is set to acquire 100 nS of time, the rest of that 20 μ S (20 μ S - 100 nS = 19.9 μ S) is left to processing and

plotting which means the scope is “dead” for 99.5% of the time. If an infrequent anomaly (as is highlighted in red) happens during that “dead time,” the engineer will never see it.

Seek an update rate as fast as possible, but be careful of trading something else off to get it (like memory depth). Update rates >20,000wfms/s help ensure you don’t miss a rare glitch and keep the oscilloscope responsive. If you are just interested in single shot trigger and capture (e.g. power supply turn-on or low speed serial decode and trigger), update rate is not important.

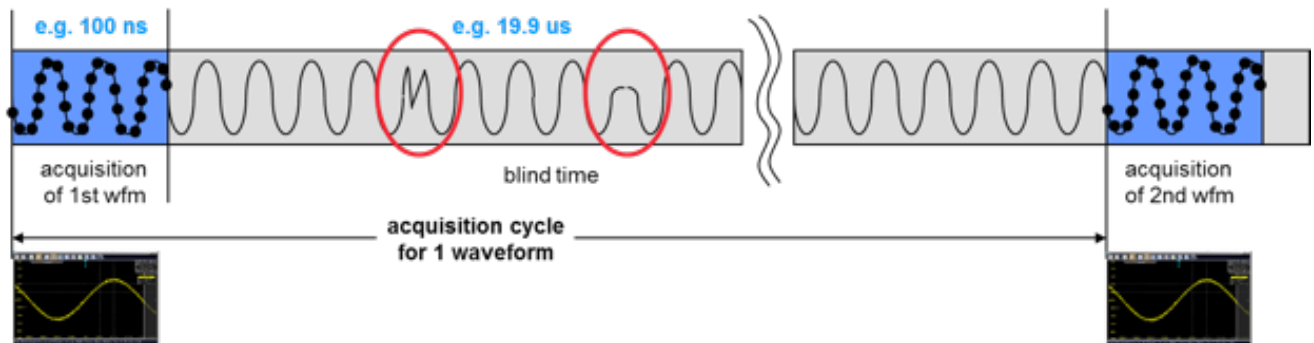

Vertical Resolution

The vertical resolution, sometimes called “bits,” is the number of buckets, or discrete vertical levels, an oscilloscope can put voltages into for a given sample. When the oscilloscope analog to digital converter (ADC) is sampling the waveform, it doesn’t have an infinite number of levels to put the sample in. It has to choose a level to put that sample in. The more levels it has to choose from, the more precise it can be. An 8-bit scope has 256 levels. A 10-bit scope has 1024. A 16-bit scope has 65,536 levels.

Rule of thumb: Many oscilloscopes utilize an 8-bit ADC. In general, additional vertical resolution (10-bit for example) is most useful for signals where you are trying to see the details of a small signal riding on top of a much larger signal. Without the additional levels, the small signal would be lost in the larger signal. Typically, larger signals are slow and not high in frequency.

RF Power Sensors

Get Accurate Results, Faster

Rohde & Schwarz Power Sensors are the most accurate with the least amount of uncertainty, enabling users to quickly make accurate measurements, even at low power levels.

Selecting the Correct Sensor Type

Choosing the right power sensor type can make all the difference when it comes to getting accurate results. The type of signals and the required measurements greatly influence the sensor choice. Knowing this information is the first step in determining what type of sensor you will need.

Is it a CW signal? Does the signal have any analog or digital modulation? Or are you trying to characterize a pulsed signal?

Next, what measurements do you need to make? Average power (CW and/or modulated signals), Time slotted measurements, Envelope power versus time, Statistical analysis such as CCDF, CDF and PDF or others?



R&S®NRP Series Power Sensors

Measurement vs Sensor Type	Multi Path	Wideband	Average	Thermoelectric
Average power (CW)	Y	Y	Y	Y
Average power (modulated signals)	Y	Y	Y	Y
Average power (modulated signals, gated)	Y	Y		
Pulse power	Y	Y		
Envelope power	Y	Y		
Envelope statistics		Y		
Pulse analysis		Y		
Time analysis		Y		

Measurement Speed

Power sensor specifications state speed or measurement rate. This is not the same as the number of measurements that can be made in a second, but rather the speed at which measurements are made. All sensors have a buffer that stores measurement results. Once this buffer is full, information needs to be sent to the controlling device so the sensor can start making more measurements. The majority of

vendors spec sensors this way, however it is good to note that the R&S®NRPxxS and R&S®NRPxxSN families of sensors are the fastest available today, with a measurement/second spec of 50,000, translating into 8192 measurements in 81.92 msecond. After 8192 measurements, the buffer is full and the data needs to be transferred to the PC.

Measurement Accuracy

One of the biggest factors affecting measurement accuracy, especially at low power levels, is the noise floor of the power sensor. As the signal level gets lower, the noise levels inside the sensor start to have more of an effect on the measurement results. This leads to the sensor having to make more measurements to average out the effects of the noise. This can significantly lengthen the time it takes to get results. Using a sensor with the lowest noise floor, minimizes this effect and gives results faster (less averaging is needed as there is

less noise). Dropping the noise floor by 3 dB yields 50% less noise. The R&S®NRPxxS and R&S®NRPxxSN families of sensors have the lowest noise floor on the market at -70 dBm. Let's look at a measurement example to understand the interaction between speed and accuracy. In this example we need to measure a signal that's -60 dBm, with an accuracy of ± 0.1 dB. For this measurement, we use two sensors and let us assume that they have the same measurement speed and the same uncertainty specifications.

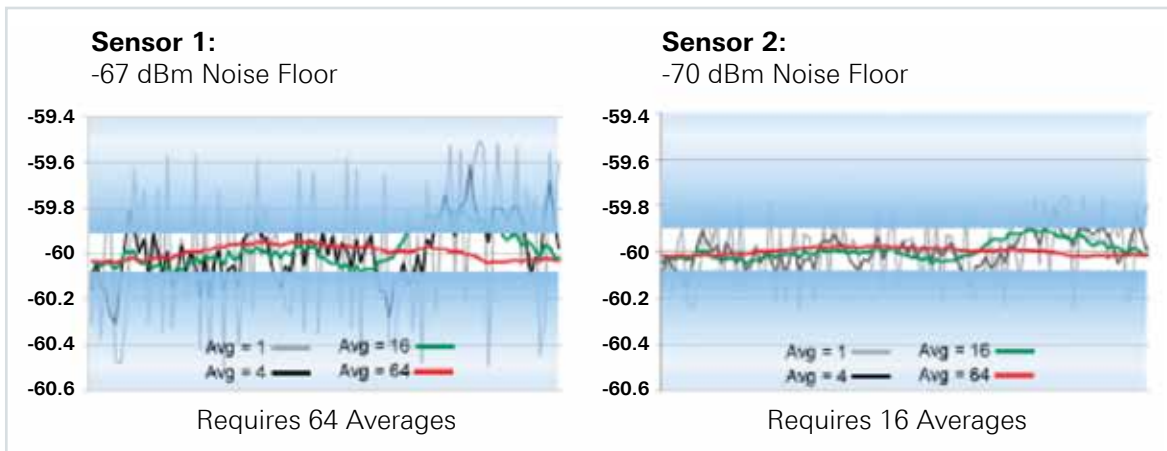

Two sensors with similar speeds and uncertainty, but one having a lower noise floor, get the same results four times faster.

Sensor Operation

The power sensor makes all the measurements itself and stores the results onboard, but the user needs some way to control the sensor and get access to the measurement results. There are four ways to operate a power sensor; from a PC by the USB interface, with a traditional power meter, over the Internet with sensors that have an Ethernet connector, or connected to another supporting instrument. Ethernet control is especially useful when working with remote

monitoring sites. It could be a transmission tower out in the field or on top of a building with a power sensor installed and connected to the Ethernet. No need to go to the site to make the measurements, you can just log on from any one of your devices – laptop, mobile phone or tablet, and make measurements in real-time. Many of the leading LAN sensors have a built-in Web server, which greatly simplifies how measurements are made.

Power Supplies & Meters

A High Channel Count in a Compact Package

A variable DC power supply appears to be a straightforward device. But it has to reliably deliver stable, precise, clean voltage and current, no matter its load. Resistive, capacitive, inductive, low- or high-impedance, stable or variable.

Selecting the right power supply for your application requires an understanding of how they are specified. The most important questions to have answered are covered in the following four sections.

Number of Channels

How many channels are needed? How many DUTs need to be powered?

Depending on the application and needs you can select a power supply unit with 1, 2, 3 or 4 channels.

Output Power

How much power does the device need?

The maximum power is determined by the maximum voltage and current demanded by the device. Is there a need for all of the power to be bundled to achieve higher current output? This is called parallel operation mode. Is there a need to combine channels to a higher maximum combined output voltage? This is called serial operation mode.

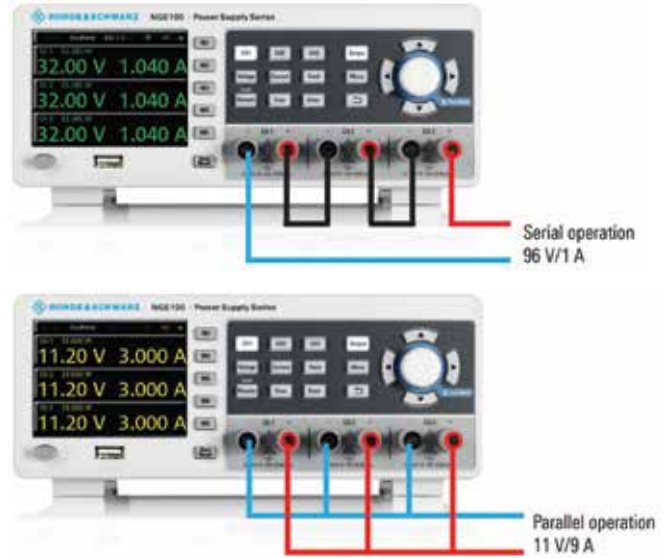

Modulation and Arbitrary Functionality

Is a function-variable output level necessary? If so, at which speed?

With a power supply, it is possible to define functions to vary the output voltage level over time. This can also be described as time/current flow or time/voltage curve that is freely programmable by channel. Some are programmable with an arbitrary sequence remotely or on the instrument.

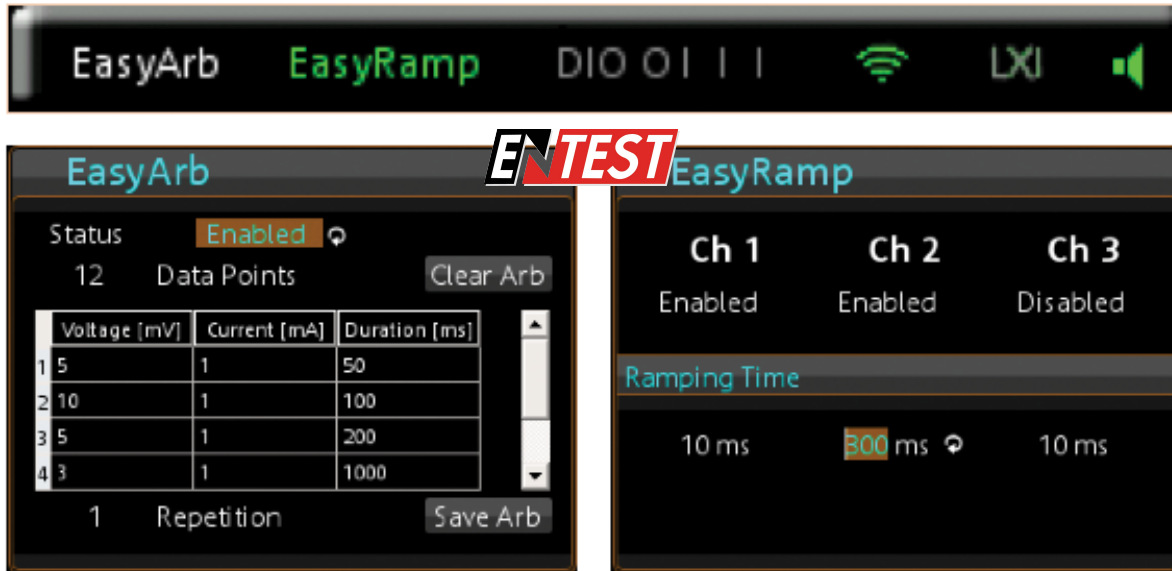

Protection

If an overvoltage event occurs, the user can configure the response of each channel independently.

In some scenarios it is necessary to shut down one channel and leave another one active. For instance, to let a fan continue running while all other channels are switched off. Some instruments, such as the R&S®NGE100, allow for independent overvoltage, overcurrent, and overpower protection.

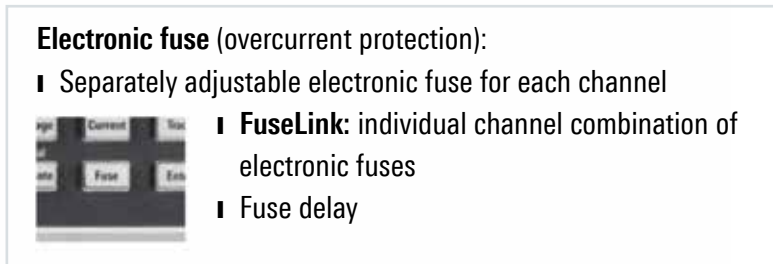
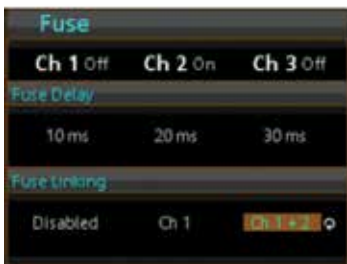

Other Bench Products

Multimeters

Voltage, Current and Resistance

A multimeter is a measurement instrument that provides electrical values such as voltage, current and resistance. A multimeter is a combination of a multirange DC voltmeter, multirange AC voltmeter, multirange ammeter, and multirange ohmmeter. It is widely used to perform quick measurements or troubleshooting, either manually or remote controlled, in electric and electronic devices. In a digital multimeter the signal under test is converted to a voltage and an amplifier with electronically controlled gain preconditions the signal.

Important elements in choosing a multimeter:

- I Number of Digits/Resolution:** While the measurement accuracy of a multimeter is principally limited by its resolution, an easier reference is the number of digits which indicates how many steps the display can show.
- I Measurement Breadth:** How many and which different measurements are important for you to make?
- I Measurement Speed:** How fast can the measurements be done?
- I Interfaces:** Are you integrating the multimeter in a system? Which remote control interfaces do you need?

Multimeters can have an extensive list of measurements making them versatile instruments.

Example Measurement Functions:

VDC, IDC, VAC, IAC, DC Power, True RMS AC and AC+DC, Frequency, 2- and 4-Wire Resistance, Capacitance, Continuity, Diode Test, Temperature, Power



For system integration, multimeters may come with connectivity options such as LAN, USB and GPIB. Additionally, rack mount kits might be available.



Audio Analyzers

A Universal Test Instrument

An audio analyzer is a universal test instrument to measure all kinds of audio equipment wherever music or speech is recorded, transmitted or processed.

It usually includes a generator which provides all types of test signals and an analyzer which provides a variety of measurements such as level, frequency response, distortion, FFT analysis, etc.

Often, equipment needs to be tested on analog and digital interfaces including audio/video combining interfaces such as HDMI.

Audio analyzers can be configured to have multiple audio interfaces, such as S/P DIF, AES/EBU, I2S, HDMI, and Dolby.

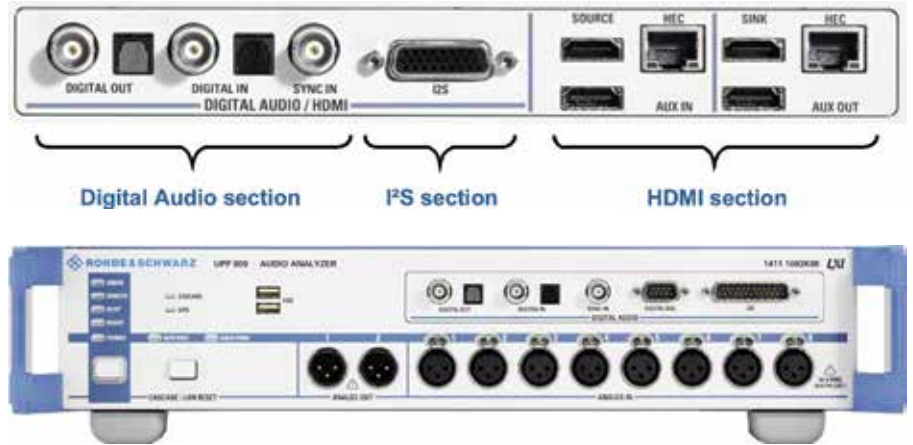

Some audio analyzers feature multiple inputs and outputs for measuring multiple channels.

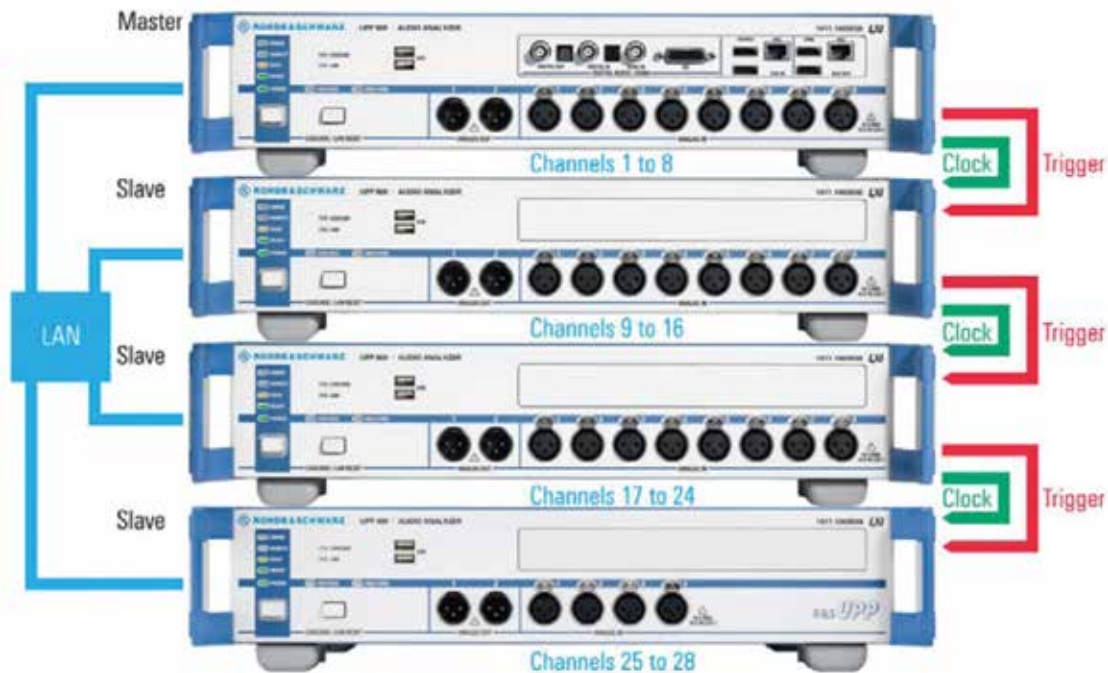

When audio testing requires very high analog channel count, audio analyzers may have options to cascade multiple units together.

LCR/Bridge Meters

Impedance Parameters Measurement

An LCR bridge measures impedance parameters (inductance, capacitance and resistance) of an electronic component. Benchtop LCR meters typically have selectable test frequencies of more than 100 kHz to create data points at multiple spot frequencies. They often include options to superimpose a DC voltage or current on the AC measuring signal.

In addition, benchtop meters allow the usage of special fixtures to measure Surface Mount Devices (SMD) components, air-core coils or transformers. Often used in a general capacity, components used in development can be validated and tested both incoming and for variation between parts.

With fast measurements that shorten test times, and binning interfaces to control a handler/sorter, LCR Bridge/Meters can also be used in production facilities.



R&S®HM8118

Power Analyzers

Fast and Accurate Power Consumption Testing

Single Phase Power Analyzers are designed to provide fast and efficient, precision measurement of power consumption testing and compliance to international standards.

Power Analyzers can make policy compliance testing easier by offering built in test cases. Modern power analyzers have options to test standards such as Energy Star, EN50160, EN50564, EN61000-3-2 and IEC62301

In addition to testing policy compliance, power analyzers have options to display measured data in ways to make analysis easier, such as Waveform Mode, Trendchart, Inrush Mode, and Harmonics View.

Power analyzers need to make a wide variety of measurements. They usually have a very deep toolbox of measurements, making them versatile instruments in applications such as power electronics, battery, solar, and embedded design.

Function	Description
P	Active power (W)
S	Apparent power (VA)
Q	Reactive power (var)
PF	Lambda power factor (λ)
PHI	Phase shift (ϕ)
FU	Voltage frequency value (Hz)
FI	Current frequency value (Hz)
FPLL	Acquisition frequency (Hz)
URMS	RMS voltage (U RMS)
UAVG	Average voltage (U AVG)
IRMS	RMS current (I RMS)
IAVG	Average current (I AVG)
UTHD	Total harmonic distortion U
ITHD	Total harmonic distortion I
WHM, WHP, WH, AHM, AHP, AH	Energy counter (integrator values)
Logging	Measured value logging (CSV)
USB, Ethernet (GPIB optional - R&S®HMC8015-G)	Remote control interfaces
UPPeak	Maximum voltage (U PEAK)
UMPeak	Minimum voltage (U PEAK)
IPPeak	Maximum current (I PEAK)
IMPeak	Minimum current (I PEAK)
PPPeak	Maximum power (P PEAK)
PMPeak	Minimum power (P PEAK)



R&S®HMC8015

Arbitrary Waveform Generators

Electrical Waveform Generation

An arbitrary waveform generator (AWG) is a piece of electronic test equipment to generate electrical waveforms generally used to test all aspects of a receive (RX) device to determine performance limits and unexpected behavior. AWGs can be used to generate signals that closely approximate real-world signals, either transmitted or interfering. They can also generate signals that can be modified in precise ways to operate the receivers (RX) as usual or at performance limits.

Unlike function generators, AWGs can generate any arbitrarily defined waveshape as their output. Some AWGs also operate as conventional function generators. These can include standard waveforms such as sine, square, ramp, triangle, noise and pulse. Some units include additional built-in waveforms such as exponential rise and fall times, $\sin x/x$, and cardiac. Some AWGs allow users to retrieve waveforms from a number of digital and mixed-signal oscilloscopes.

An Arbitrary Generator will have the ability to create standard waveforms such as sine, square, triangle, and pulse. Additionally, there will be the ability to create custom waveforms either on the unit or load waveforms created on a computer.



R&S®HMF2500 Series

Sine Square Triangle Pulse Custom

Rohde & Schwarz GmbH & Co. KG
Mühldorfstraße 15
81671 Munich, Germany

Regional contact

- Europe, Africa, Middle East | +49 89 4129 12345
customersupport@rohde-schwarz.com
- North America | 1 888 TEST RSA (1 888 837 87 72)
customer.support@rsa.rohde-schwarz.com
- Latin America | +1 410 910 79 88
customersupport.la@rohde-schwarz.com
- Asia Pacific | +65 65 13 04 88
customersupport.asia@rohde-schwarz.com
- China | +86 800 810 82 28 | +86 400 650 58 96
customersupport.china@rohde-schwarz.com

About Rohde & Schwarz

The Rohde & Schwarz electronics group offers innovative solutions in the following business fields: test and measurement, broadcast and media, secure communications, cybersecurity, radiomonitoring and radiolocation. Founded more than 80 years ago, this independent company has an extensive sales and service network and is present in more than 70 countries.

The electronics group is among the world market leaders in its established business fields. The company is headquartered in Munich, Germany. It also has regional headquarters in Singapore and Columbia, Maryland, USA, to manage its operations in these regions.

Sustainable product design

- Environmental compatibility and eco-footprint
- Energy efficiency and low emissions
- Longevity and optimized total cost of ownership

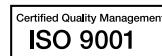

www.rohde-schwarz.com



PAD-T-M: 3573.7380.02/02.05/EN/

This and the supplied programs may only be used subject to the conditions of use set forth in the download area of the Rohde & Schwarz website.

R&S® is a registered trademark of Rohde & Schwarz GmbH & Co. KG. Trade names are trademarks of the owners.

©2017 Rohde & Schwarz GmbH & Co. KG | 81671 Munich, Germany