

## Chipper Check Adapter Schematics

Adapter: 1550000B  
(RCA212121)

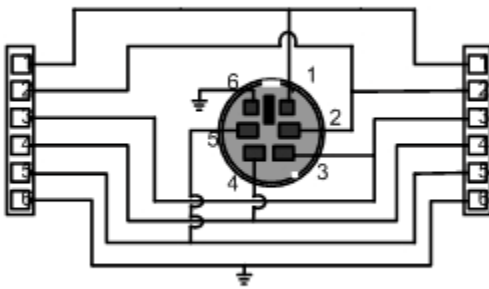

- CTC175
- CTC176
- CTC184
- CTC186
- CTC187
- CTC195
- CTC197
- CTC203
- ATC113

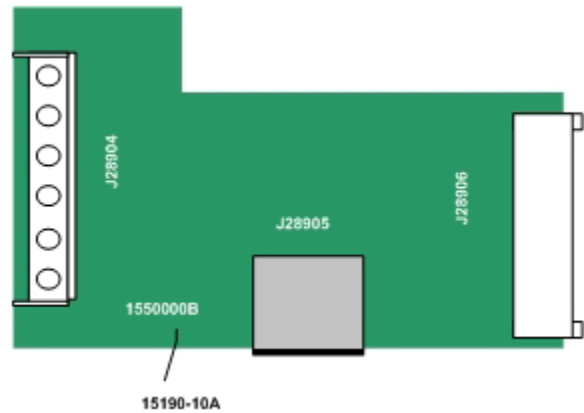

Adapter: 1550001B  
(RCA212117)

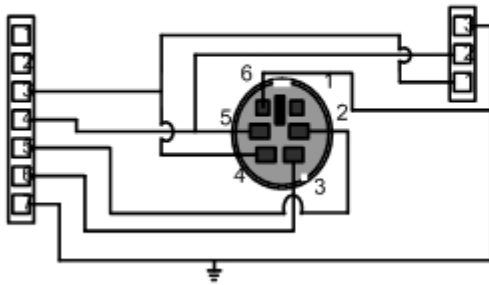

- CTC178
- CTC179
- CTC185
- CTC188
- CTC189

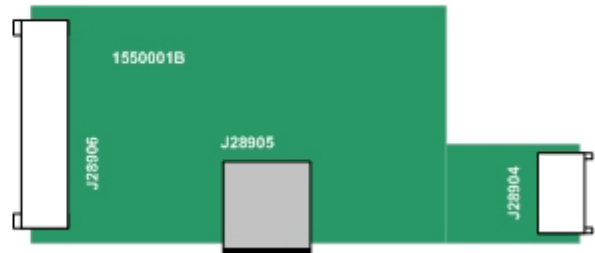

Adapter: 1550002B, 363, 371  
(RCA253684)

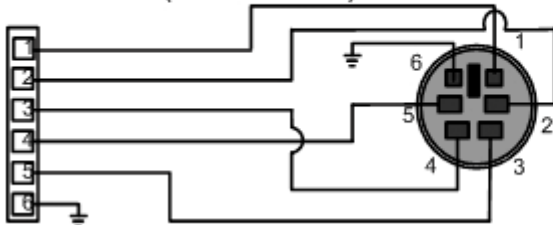

- MM101
- CTC210
- DTV306
- LCOS

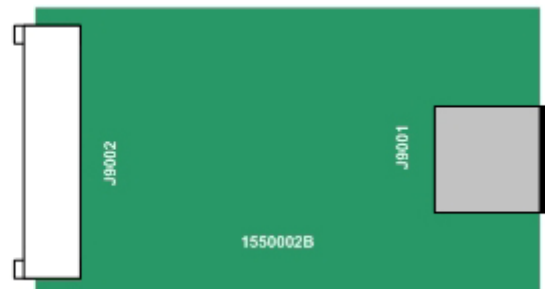

#CC1 100#

Adapter: 15906830, 370, MM102  
(RCA254685)

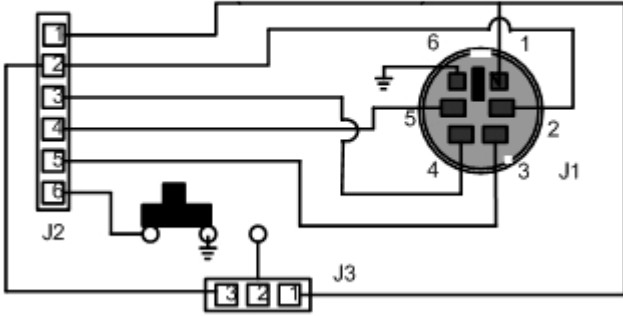

MM102  
CTC211  
DTV307

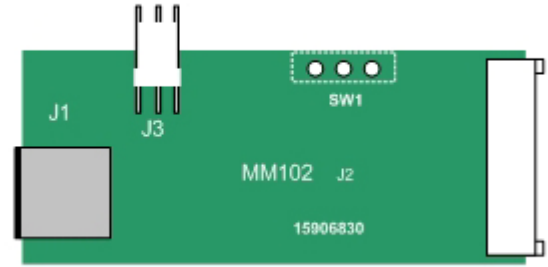

### USEFULL REFERENCES THOMSON CHIPPER CHECK-

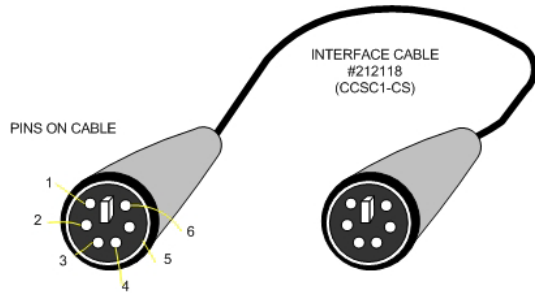
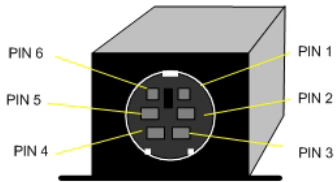

J28902 Output Connector  
(Bottom PC Board View)

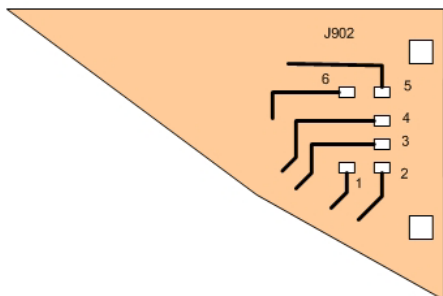

**For More Information**  
**Call Toll Free 1-800-SENCORE**  
**(1-800-736-2673)**

**SENCORE**

3200 Sencore Drive, Sioux Falls, SD 57107  
[www.sencore.com](http://www.sencore.com)

#CC1  
100#