

Operating Manual and
Programming Reference

IGC100
Ion Gauge Controller



Certification

Stanford Research Systems certifies that this product met its published specifications at the time of shipment. Stanford Research Systems further certifies that its calibration measurements are traceable to the United States National Institute of Standards and Technology (NIST).

Warranty

This Stanford Research Systems product is warranted against defects in materials and workmanship for a period of one (1) year from the date of shipment.

Service

For warranty service or repair, this product must be returned to a Stanford Research Systems authorized service facility. Contact Stanford Research Systems or an authorized representative before returning this product for repair.

Information in this document is subject to change without notice.

Copyright © Stanford Research Systems, Inc., 2001, 2002. All rights reserved.

Stanford Research Systems, Inc.
1290-C Reamwood Avenue
Sunnyvale, California 94089
www.thinksrs.com

Printed in U.S.A.

Safety and Preparation For Use

CAREFULLY READ THE IMPORTANT SAFETY INSTRUCTIONS AND NOTES INCLUDED IN THIS SECTION BEFORE USING THE IGC100 ION GAUGE CONTROLLER AND ITS ACCESSORIES. SAFETY PAYS!

Within this section, the word '**product**' specifically refers to the **IGC100 Ion Gauge Controller and any of its accessories**.

Safety risks are associated with all research and production activities. Though long experience has proven high vacuum instrumentation to be remarkably safe, hazards are always associated with vacuum system operation. The most effective way to minimize risk to yourself and others is to read, and strictly follow, all safety instructions and warnings during the installation, operation and maintenance of the equipment connected to your vacuum system.

The intent of this section is to collect, in a single place, the most common risks associated to the installation, operation and maintenance of this product. The instructions are also repeated, with additional information, at the appropriate points throughout this manual.

This product has been designed with user-safety as a priority and has been proven to show reasonably safe operation provided it is installed, operated and serviced in strict accordance with all the safety instructions included in its manual

Safety Instructions and Warnings

- **SAFETY PAYS!** Safety instructions must be strictly followed during all stages of installation, operation and service of this product. Failure to comply with these precautions and warnings violates the safety standards expected of users of this product.
- If you have any doubts about how to use this product safely, contact Stanford Research Systems at the address listed in this manual.
- Retain these safety and operating instructions for future reference.
- Identify and adhere to all warnings posted on the product.
- Failure to comply with these instructions may result in serious personal injury, including death, as well as significant property damage.
- Due to the variety of vacuum system configurations and applications, it is impossible to account for all safety concerns that may arise during the installation, operation and maintenance of this product. Please contact the factory for any specific safety concerns not addressed directly by this manual.
- It is the installer's responsibility to ensure the safe operation of automated vacuum systems. Carefully check manual operation of the system and the setpoint programming instructions before switching to automatic operation.
- Provide for fail-safe operation wherever an equipment malfunction could lead to a hazardous situation.

Electrical Shock Risks

The most common risk associated with the operation of vacuum equipment is electrical shock.

- Dangerous voltages capable of causing injury and death are present during the operation of this product. **Do not remove the covers while the unit is plugged into a live outlet.**
- **Always operate the unit in its proper horizontal orientation.** Do not operate the unit on its side as foreign objects or liquids may enter through the ventilation slots, creating an unsafe condition.
- **Do not use this product if it has unauthorized modifications.** Unauthorized modifications may result in fire, electric shock and other hazards.
- Do not install substitute parts or perform any unauthorized modifications to this instrument.
- **The line fuse is internal to the instrument and may not be serviced by the user.** If the red 'Line' LED does not turn on when line power is provided, contact Stanford Research Systems. The fuse on the rear panel is for the ion gauge, NOT line power.
- The IGC100 has a detachable, three-wire power cord for connection to the power source and to a protective ground. The exposed metal parts of the instrument are connected to the outlet ground to protect against electrical shock. **Always use an outlet which has a properly connected protective ground.** Consult with an electrician if necessary. Be aware that grounding this product does not assure proper grounding of the rest of the vacuum system.
- The most important safety measure required to eliminate electric shock risks is to **provide an earth ground to all conductive parts of the vacuum chamber, gauges and controllers.**
- GFCI (Ground Fault Circuit Interrupter) protected outlets are often available in production and laboratory environments, particularly in proximity to water sources. GFCI's are generally regarded as an important defense against electrocution. However, **the use of a GFCI in conjunction with IGC100's and vacuum systems must not be regarded as a substitute for proper grounding and careful system design.** GFCI's must also be tested regularly to verify their functionality. Always consult an electrician when in doubt.
- Do not use accessories not recommended in this manual as they may be hazardous.
- 180 Vdc is present in the controller, on the cable and at the ionization gauge when the ionization gauge tube is turned on. This voltage increases to $\approx 500\text{Vdc}$ during degas operation. **Do not touch any cable connections when power is being applied to the unit.**
- **Always turn off the power to the instrument before connecting any cable to the controller or to an ionization gauge tube.**

- High-voltage ion-producing equipment such as a hot-cathode ionization gauge can, under certain circumstances, provide sufficient electrical conduction via a plasma to couple a high voltage potential to the vacuum chamber walls. Any exposed conductive parts of a gauge or vacuum chamber may attain high voltage potentials through this process if not properly grounded.
- All conductors in, on, or around the vacuum system that are exposed to potential high voltage electrical discharges must either be shielded at all times to protect personnel or must be connected to the system earth-ground at all times.
- All parts of a vacuum system utilized with this or any similar high voltage product must be maintained at earth ground for safe operation. There should be an **explicit heavy duty earth-ground connected to the vacuum chamber**. Check with an electrician if necessary. All electronic instrumentation must be connected to properly grounded electrical outlets and include a chassis grounding lug that must be tied to the common earth-ground of the vacuum system. Beware! Failure to safely ground your vacuum system can be fatal!
- The electrical insulation in this product may become less effective at preventing electrical shock after ten years of normal use (or even non-use). Products placed in harsh environments might deteriorate even faster. Inspect all electrical insulation periodically for signs of cracking and deterioration. Return the product to the factory for service if the insulation has become unsafe.
- To reduce the risk of fire and electrocution do not expose this product to rain or moisture. Be careful not to spill liquid of any kind onto or into the product.
- This product is intended for use only in a clean and dry laboratory environment. Operation in other environments may cause damage to the product and reduce the effectiveness of the safety features.
- Keep in mind that **O-ring seals without metal clamps or bolt connections can isolate big portions of a vacuum system from its safety ground**. Verify that the vacuum port to which any new component is mounted is electrically grounded. Use a ground lug on a flange bolt if necessary.
- Keep all electrical wiring in your vacuum system neatly organized and in good working conditions. Label and color-code all high voltage cables. Inspect all HV wires periodically for problems as part of your safety checkups.
- Use tie downs and cable channels to hold all electrical wiring in place (i.e. no dangling cables).
- Keep all electronic instrumentation neatly organized, and remove unconnected cables and connectors from the vacuum setup.
- If possible, rack mount your vacuum instrumentation.
- Only use instrumentation with high quality cables and connectors that properly shield all high voltage terminals. Eliminate homemade connections from your vacuum setups.
- High voltage cables from ion gauge controllers, ion guns, photomultiplier tubes, mass spectrometer probes, power supplies, etc , can be inadvertently damaged if pinched while tightening flange bolts. Keep all cables away from vacuum ports frequently opened to air.

- The voltages delivered by this product can be lethal, particularly during electron bombardment degas. Do not touch any of its connection pins even if the gauge is off.
- Do not push objects of any kind into this product through openings as they may come in contact with dangerous voltage points or short out parts that could result in a fire or electric shock.
- Verify that the vacuum port to which the ionization or Pirani gauge is mounted is electrically grounded. It is essential for personnel safety as well as proper operation that **the envelope of every ionization gauge be properly connected to the facility earth-ground**. Use a ground-lug on a flange bolt if necessary.
- **Perform regular electrical ground checkups** on your entire vacuum system, particularly if it is shared by multiple users running unrelated experiments. During a ground checkup carefully examine all vacuum system components: Are all exposed connectors and conductors on the vacuum chamber grounded? Are all ground connections properly connected to a solid earth (i.e. facility) ground? Some vacuum systems rely on water piping for the earth-ground connection. Proper ground connection can be easily lost by inadvertently inserting a plastic interconnect into the water lines. Refer to the step-by-step vacuum system grounding test procedure in Chapter 1 of this manual.
- Operation of this product with line voltages other than those accepted by the power supply can cause damage to the instrument and injury to personnel.

Burn Risks

Another common safety concern for vacuum system operators is burns.

- Filament based devices, such as Bayard-Alpert ionization gauges radiate heat to areas adjacent to the filament, sometimes making them too hot to touch.
- Do not touch hot-cathode Ionization Gauges during degassing operation. Serious burns can occur.
- Acetone, toluene and isopropyl alcohol are highly flammable and should not be used near an open flame or energized electrical equipment.

Explosion Risks

Injury due to explosion is another important safety concern during the operation of a vacuum system and gas manifold system.

Explosion is possible in systems that are routinely cycled from vacuum to pressures above atmosphere and can be caused by many different reasons. Dangerous overpressure conditions can be established if a pressure regulator is set to the wrong value, the wrong gauge or gauge calibration is used for positive pressure measurements or even if a bad setpoint value is programmed into an automated process control setup. Explosions can also occur if flammable or explosive gases are exposed to hot elements such as the hot filaments of a Bayard-Alpert gauge or the sensor wire of a Pirani gauge.

- Check that the right cylinders, with the right gases, are connected to the gas handling system before starting any process.
- **Check the pressure regulator settings** before starting any process.
- **Confirm that the right units were used** to program the setpoints of all automated process control channels.
- Install suitable devices that will limit the pressure to the level that the vacuum system, and its gas manifold, can safely withstand.
- Use pressure relief valves in the gas manifold and in the vacuum chamber, that will release pressure at a level considerably below that pressure which the system can withstand.
- **Do not use the product to measure the pressure of flammable, explosive, combustible or corrosive gases or mixtures of gases.** Turn off hot filament gauges during the exposure to flammable or explosive gases. Do not use this product to measure the pressure of unknown gases.
- The sensor wire of the Pirani gauge (PG105 or PG105-UHV) operates at about 120° C, but it is possible that controller malfunction might increase the sensor temperature above the ignition temperature of combustible gases. Turn off all PG105 gauges exposed to flammable or explosive gases.
- Avoid enhanced Pirani and thermocouple gauges for pressure measurements in systems routinely pressurized above atmosphere (capacitance diaphragm gauges are much safer and recommended instead).
- If used improperly, Pirani gauges can supply incorrect pressure readings. For example, using the N₂ calibration of a convection-enhanced Pirani gauge (i.e. PG105 or PG105-UHV) to pressurize a vacuum system above 1 Torr with certain other gases can cause dangerously high pressures and may lead to explosion.
- **Do not use compression fittings for positive pressure applications.** Pirani, thermocouple and even capacitance diaphragm gauges mounted in this fashion can be forcefully ejected and injure anybody in their path.

Implosion Risks

The risk of implosion must also be considered in high vacuum systems using glass windows, glass tubulation and glass-envelope ionization gauges. Dropping a tool on a gauge under vacuum, or pulling on the cables can easily break the glass. The resulting implosion may then throw glass fragments around the room injuring personnel.

- Glass-tubulated ionization gauges should not be treated roughly or be bumped.
- Install the ion gauge cable on glass tubulated gauges before the gauge reaches vacuum pressures.
- **Stress relief all cables attached to glass tubulated ionization gauges.**
- Do not allow the gauge tube temperature to exceed 100° C in glass tubulated gauges. Sustained high temperatures can damage the tube, causing air leakage into the vacuum system and increasing the chances of dangerous implosion.
- Make all glass windows as small and thick as possible.

- Wherever feasible, replace glass-tubulated gauges with all-metal ones.
- Protect all glass components with internal vacuum with tape or metal shields.

References

For additional information on vacuum technology safety recommendations consult:

1. Charles F. Morrison, "Safety Hazard From Gas Discharge Interactions with the Bayard-Alpert Ionization Gauge", J. Vac. Sci. Technol. A 3 (5) (1985) 2032.
2. R. N. Peacock, "Safety and Health Considerations Related to Vacuum Gauging", J. Vac. Sci. Technol. A 11(4) (1993) 1627.
3. John T. Yates, Jr., "Experimental Innovations in Surface Science. A Guide to Practical Laboratory Methods and Instruments", Springer-Verlag, New York, Inc., 1998: (1) Section 238, p. 832, titled: 'Electrical Shocks in the Laboratory'; and (2) Section 239, p. 836, titled: 'Accidental Electrical Charging From Ionization Gauge'.
4. Gerardo Brucker, "Prevention is Key to Vacuum System Safety", R&D Magazine, February 2001, p. 57.
5. Donald M. Mattox, "Safety Aspects of Vacuum Processing", Vacuum Technology and Coating Magazine, March 2001, p. 22.

Contents

Safety and Preparation For Use	i
Contents	vii
Front Panel Overview	xiii
Touchscreen Display Overview	xiv
Back Panel Overview	xv
Connector Pinouts	xvi
Specifications	xxiii
Command List	xxvii
Damage Requiring Service	xxxi
Declaration of Contamination of Vacuum Equipment	xxxii

Chapter 1 Getting Started

Unpacking	1-3
Installing the IGC100 Controller	1-5
Before You Install a Vacuum Gauge	1-7
Installing an Ionization Gauge	1-9
Connecting an Ionization Gauge	1-13
Installing a Pirani Gauge	1-24
Connecting a Pirani Gauge	1-28
Installing a Capacitance Manometer	1-31
Connecting a Capacitance Manometer	1-32
Measuring Pressure	1-35
IGC100 Quick Setup	1-35
Gauge Setup Procedure	1-37
Setting Gauge Parameters	1-39
Pressure Measurement	1-44
Pressure Display Formats	1-50
Proper Grounding Test Procedure	1-55

Chapter 2 IGC100 Basics

IGC100 Overview	2-3
Front Panel	2-15
Back Panel	2-19
Maintenance and Service	2-32

Chapter 3 Displays and Menus

- QuickKeys 3-5**
- Menu Buttons 3-8**
- Pressure Display 3-11**
- Gauges Display 3-14**
 - Ion Gauge Setup Menu 3-16
 - Advanced 3-20
 - Overpressure 3-24
 - Auto-Start 3-25
 - Pirani Gauge Setup Menu 3-27
 - Zero 3-29
 - Atm 3-29
 - Analog I/O Menu 3-30
 - Zero Manometer 3-34
- Logging Display 3-35**
 - Logging Setup Menu 3-37
 - Chart Y Axis Menu 3-39
 - Chart X Axis Menu 3-40
- Process Control Display 3-41**
 - Edit Rules Menu 3-44
 - Edit Messages Menu 3-48
- Main Menu 3-50**
 - Utilities Menu 3-51
 - Selftest 3-51
 - Security Menu 3-53
 - Security Settings 3-54
 - Remote Menu 3-57
 - RS-232 3-57
 - GPIB 3-58
 - Web 3-59
 - Web Control 3-61
 - Screen Menu 3-63
 - Backlight Menu 3-64

Chapter 4 Analog I/O Ports

- Analog I/O Ports (AN1-AN4) 4-3**
- Capacitance Manometers (CM1-CM4) 4-6**

Chapter 5 Process Control

- Process Control Warnings 5-3**
- Why Use Process Control? 5-4**
- Process Control Basics 5-5**
 - Relay Connections 5-10
 - Digital I/O Module 5-16
 - Remote Control Inputs 5-21
- Automated Pumpdown Example 5-25**

Chapter 6 Memory Card

- Overview 6-3**
- Calibrated Ion Gauges 6-5**
- Password Cards 6-8**

Chapter 7 Programming

- Index of Commands 7-3**
- Alphabetical List of Commands 7-7**
- Introduction 7-11**
- Command Syntax 7-15**
- Gauges and Measurement Commands 7-17**
 - Ion Gauge Setup 7-20
 - Pirani Gauge Setup 7-24
 - Analog Port Setup 7-25
- Logging Commands 7-26**
 - Charting 7-29
- Process Control Commands 7-31**
- Backlight Commands 7-37**
- Security Commands 7-38**
- System Commands 7-40**
- Interface Commands 7-42**
- Status Reporting 7-44**
- Status Reporting Commands 7-47**

Chapter 8 Embedded Web Server

- EWS Quick Start 8-3**
- Installing the EWS 8-5**
- Using the EWS 8-18**
- Networking Terms 8-29**

Chapter 9 Troubleshooting

- Warnings 9-3
- Resetting the IGC100 9-3
- Error Detection 9-4
- Error Messages 9-6
- Basic Troubleshooting 9-9
- Maintenance 9-14
- Damage Requiring Service 9-22

Chapter 10 Testing

- Getting Ready 10-3
- Preparation for Testing 10-7
- Performance Tests 10-11
- Performance Test Record 10-20

Appendices

- Appendix A Bayard-Alpert Ionization Gauges**
 - Principle of Operation A-3
 - Limiting Factors for Low Pressure Operation A-17
 - Mechanical Construction A-25
 - Filament Considerations A-34
 - Accuracy and Stability A-38
 - Degassing A-41
 - Safety and Health Considerations A-43
 - References A-45
- Appendix B Manufacturer Cross-Reference for Bayard-Alpert Gauges**
 - Manufacturer Cross Reference Table B-3
 - Specifications of SRS Bayard-Alpert Gauges B-5
- Appendix C Using the IGC100 with STABIL-ION[®] Gauges**
 - Compatibility C-3
 - Gauge Setup Parameters C-3
 - Final Comments C-5
 - References C-6
- Appendix D Gas Correction Factors for Bayard-Alpert Gauges**
 - Gas Correction Factors D-3
 - References D-5
- Appendix E Selecting a Bayard-Alpert Gauge**
 - BAG Designs E-3
- Appendix F SRS Bayard-Alpert Gauge Calibration Service**
 - Introduction F-3
 - Who Needs to Calibrate a BAG? F-5
 - Calibration Storage in the IGC100 F-6

	SRS High Vacuum Calibration Facility	F-7
	Calibration at a Standards Laboratory	F-10
	Important Terms	F-12
	References	F-13
Appendix G	Hot vs. Cold Ionization Gauges	
	Introduction	G-3
	Hot-Cathode Gauges	G-4
	Cold-Cathode Gauges	G-6
	Conclusions	G-8
Appendix H	PG105 Convection Enhanced Pirani Gauge	
	Principle of Operation	H-3
	Construction	H-6
	Calibration	H-8
	Accuracy and Stability	H-9
	Operation Below 10^{-3} Torr	H-10
	Mounting Orientation	H-10
	Mounting Recommendations	H-11
	Contamination	H-13
	Application Examples and Tips	H-15
	Safety Considerations	H-17
	Electrical Connection	H-19
	PG105 Gauge Test Procedure	H-20
	References	H-21
Appendix I	Gas Correction Curves for PG105 Readings	
	Gas Correction Curves and Factors	I-3
	Overpressure Risks	I-5
	References	I-6
Appendix J	PG105 vs. Thermocouple Gauges	
	Introduction	J-3
	Pressure Range Considerations	J-4
	Response Times	J-5
	Remote Sensing	J-5
	Controller/Gauge Interchangeability	J-6
	Contamination Resistance	J-6
	UHV Compatibility	J-6
	Price/Performance Ratio	J-7
	Freeze-Drying Processes	J-7
	Leak Testing	J-7
Appendix K	Conversion Factors for Pressure Units	
Appendix L	Dual Ion Gauge Connector Option (SRS# O100IGC)	
	What is Included?	L-3
	Installation	L-3
Appendix M	Using MICRO-ION[®] Gauges	
	Wiring Requirements	M-3
	Gauge Setup Parameters	M-4
	References	M-6

Appendix N Parts Lists and Schematics

Warnings N-3

Circuit Board Locations N-4

Circuit Descriptions N-5

Parts Lists N-12

Front Panel Overview

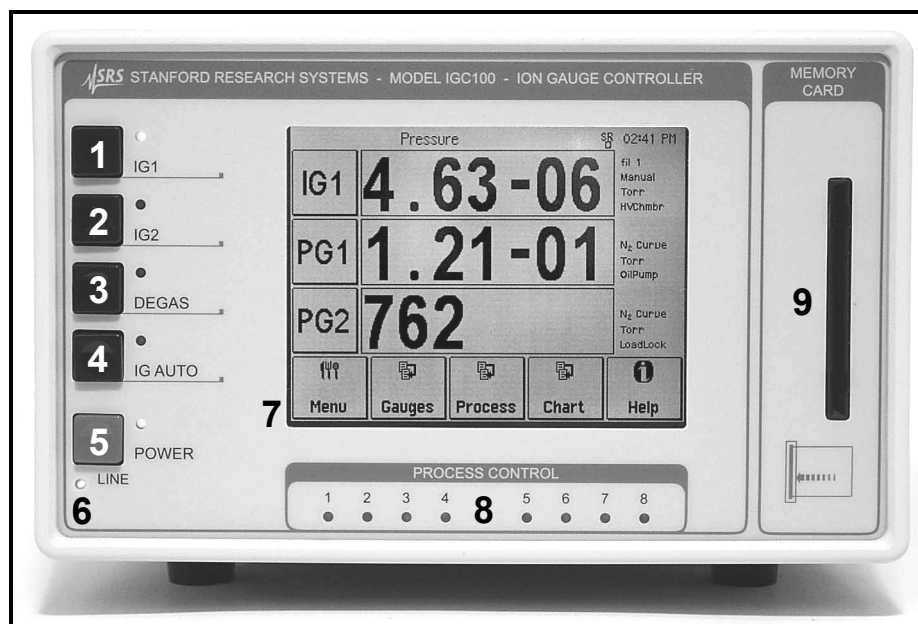
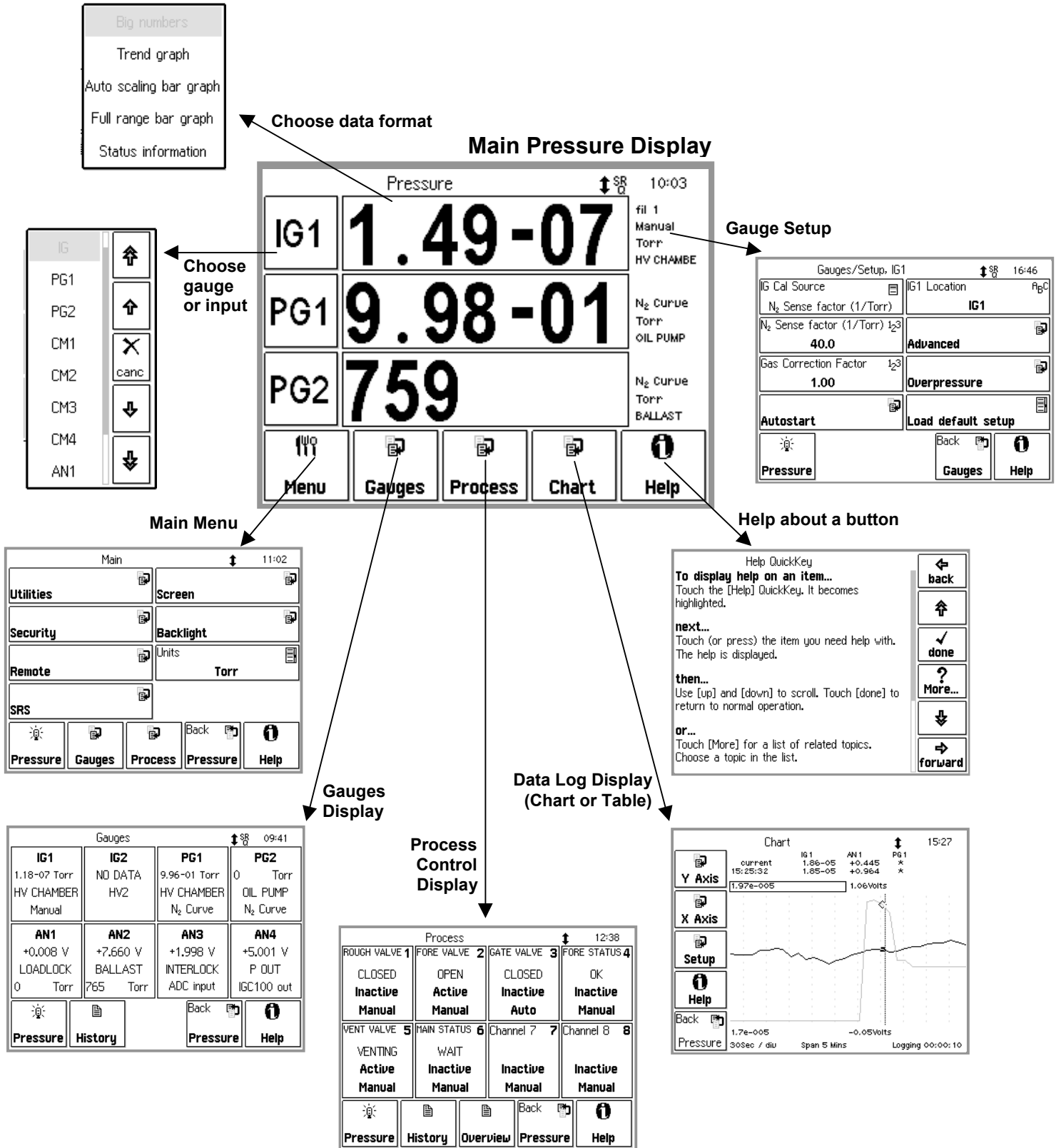

Figure i. IGC100 Front Panel.

1. IG1 BUTTON (Black w/green LED). Ionization gauge 1 power switch.
2. IG2 BUTTON (Black w/green LED). Ionization gauge 2 power switch.
3. DEGAS Button (Black w/red LED). Degas Power switch.
4. IG AUTO Button (Black w/yellow LED). IG AUTO-START switch.
5. POWER Button (Red w/green LED). Controller power switch.
6. LINE LED (Red). Line voltage indicator.
7. LCD Display (w/touchscreen). Pressure and menu display area.
8. PROCESS CONTROL LEDs (green). Process control channel indicator lights.
9. MEMORY CARD Module. Memory card slot.

Touchscreen Display Overview



Back Panel Overview

WARNING!

- Read the entire **Safety and Preparation for Use** section of this manual before using the IGC100.
- Read Chapter 1 for detailed instructions and safety information regarding the installation of the IGC100 and connection of gauges.



Figure ii. The IGC100 back panel.

1. Power - Power Entry Module, CHASSIS GND.
2. Ionization Gauge - ION GAUGE POWER.
3. Ionization Gauge - COLLECTOR (IG1 & IG2).
4. Pirani Gauge - PIRANI.
5. Capacitance Manometer – ± 15 V AUX POWER.
6. Analog I/O - BNC Ports AN1-4
7. Computer Interfaces - RS-232, GPIB (IEEE-488) (Opt 01), and ethernet 10BASE-T (Opt 02).
8. Process Control (Opt. 03) - RELAY CONTACTS, DIGITAL I/O.

Connector Pinouts

WARNING!

- Read the entire **Safety and Preparation for Use** section of this manual before using the IGC100.
- Read Chapter 1 for detailed instructions and safety information regarding the installation of the IGC100 and connection of gauges.

Ion Gauge Power Connector

Use the 14-pin ION GAUGE connector to power an ionization gauge.

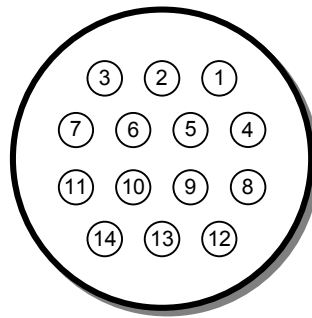

Figure iii. The ion gauge power connector.

Pin	Name	Description
1	O100IG_ID	This pin is used by the IGC100 to verify the presence of option O100IG (Dual Ion Gauge Connector Box)
2	unused	
3	O100IG_24V_SUPPLY	This pin provides 24 VDC (100 mA) to the relays of option O100IG when: (1) O100IG is detected (pin 1) and (2) IG2 is selected.
4	GND	Chassis Ground Connection
5	FIL_RETURN	Filament power return. Return path for the power provided by pins 8 and 11 (both filaments). +30 VDC bias, independently monitored through pin 6 at the gauge head.
6	BIAS_SUPPLY	Filament Bias Monitor +30 VDC bias.
7	O100IG_24V_RETURN	This pin provides the return path for the 24 VDC (100 mA) power provided by pin 3.
8	FIL2_SUPPLY	Filament 2 power supply [7 Amps DC, 7 VDC].
9	unused	
10	unused	
11	FIL1_SUPPLY	Filament 1 power supply [7 Amps DC, 7 VDC].
12	unused	
13	GRID_SUPPLY	Anode Grid Supply. +180 VDC (10 μ A-12 mA), normal emission. \approx 500 VDC (2-160 mA max), Degas.
14	unused	

- 1) Use only O100C1, O100C2 and O100C3 signal cables provided by Stanford Research Systems to connect ionization gauges to the IGC100 controller.
- 2) The ION GAUGE connector is also compatible with the STABIL-ION[®] gauge signal cables (part numbers 360112, 360114 or 360116) available directly from Granville-Phillips (Helix Corporation).
- 3) For maximum accuracy, independent of cable length, pins 5 and 6 of SRS ion gauge cables are connected together at the end that attaches to the gauge head.
- 4) Pins 1, 3 and 7 are for the optional Dual Ion Gauge Connector Box (O100IG). Do not make connections to those pins.

The ION GAUGE connector of a standard IGC100 is treated as the IG1 port. If the Dual Gauge Option (SRS# O100IG) is installed, this connector is used to power the option box. In this case, two gauges may be connected to the option box.

Pirani Gauge Connector

Use the DB-15 PIRANI port to connect up to two PG105 Pirani gauges to the IGC100 controller. Use only SRS# O105C4 Dual Pirani Gauge cables.

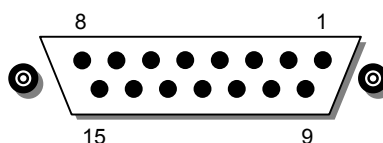

Figure iv. The dual Pirani gauge connectors

Pin	Pirani Gauge	Description
1		unused
2		unused
3	1	GND_Sense
4	1	GND_PWR
5	1	NULL (+) (filament side)
6	1	NULL (-) (divider side)
7	1	Vbr_PWR
8	1	Vbr_Sense
9	2	GND_PWR
10	2	GND_Sense
11	2	NULL (+) (filament side)
12	2	NULL (-) (divider side)
13	2	Vbr_PWR
14	2	Vbr_Sense
15		unused

±15 V AUX Power Connector

Use this 3-pin, ±15 V (100 mA max), connector to provide electrical power to standard (i.e. non-heated) capacitance manometers.

Process Control (Opt. 03)

Relay Contacts

Use these two 12-Position Terminal Block Plugs to connect to the eight process control relays. All relays are SPDT, form C, 5A/250VAC/30VDC, resistive load only.

Process Action	Relay Common Connected to	Rear Panel Label
INACTIVE	Normally Closed pin (NC)	I
ACTIVE	Normally Open pin (NO)	A

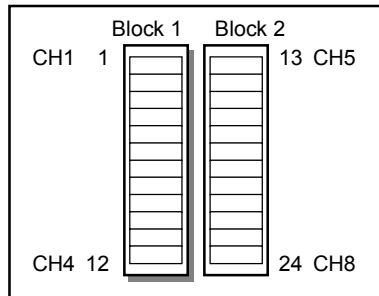

Figure v. The 2 12-position terminal blocks for process relay connections.

Block	Pin	Process Channel	Process Control Label	Relay Pin	
1	1	1	Common (C)	C	
	2		Inactive (I)	NC	
	3		Active (A)	NO	
	4	4	2	Common (C)	C
		5		Inactive (I)	NC
		6		Active (A)	NO
	7	7	3	Common (C)	C
		8		Inactive (I)	NC
		9		Active (A)	NO
	10	10	4	Common (C)	C
		11		Inactive (I)	NC
		12		Active (A)	NO
2	13	5	Common (C)	C	
	14		Inactive (I)	NC	
	15		Active (A)	NO	
	16	16	6	Common (C)	C
		17		Inactive (I)	NC
		18		Active (A)	NO
	19	19	7	Common (C)	C
		20		Inactive (I)	NC
		21		Active (A)	NO
	22	22	8	Common (C)	C
		23		Inactive (I)	NC
		24		Active (A)	NO

DIGITAL TTL I/O

Use the female DB37 port to connect to the (1) eight Process Control TTL Outputs, (2) eight Process Control TTL inputs and (3) twelve Remote Control TTL inputs of the Process Control Board. A male DB37 connector is provided to facilitate connection to the controller.

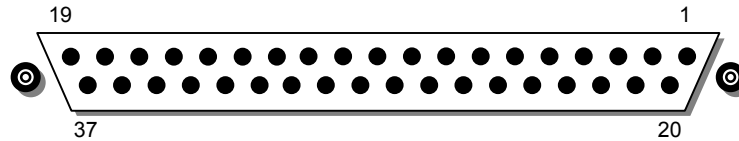

Figure vi. The DB37 TTL I/O connector.

Pin	Module	Name	Description
1		IGC100 Vcc	+5 V OUT
2	Remote Control TTL IN	ANODE COM	External User +5 V IN
3		IG1_On	Edge trigger: ↓=IG1 On, ↑=IG1 Off
4		IG2_On	Edge trigger: ↓=IG2 On, ↑= IG2 Off
5		Degas_On	Edge trigger: ↓= Degas On, ↑=Degas Off
6		IG_Lockout	Level: LOW=IG1 and IG2 emission Off
7		IG_Key_Disable	Level: LOW=Disable front panel IG Keypad.
8		PG1_Off	Edge trigger: ↓=PG1 Off, ↑=PG1 On
9		PG2_Off	Edge trigger: ↓=PG2 Off, ↑=PG2 On
10		Clear_Data_Log	Edge trigger: ↓=clear the data log
11		IG_Remote_Enable	Level: HIGH=Ignore IG1_On, IG2_On, Degas_On, FIL1_On, FIL2_On pins.
12		FIL1_On	Edge trigger: ↓=FIL1 ON, ↑=FIL1 Off
13		FIL2_On	Edge trigger: ↓= FIL2 ON, ↑= FIL2 Off
14		Front_Panel_Disable	Level: LOW=Disable Touchscreen and Keypad
15			IGC100 Vcc
16	Process Control TTL OUT	TTL_OUT_5	TTL OUT for Channel 5. LOW=ACTIVE
17		TTL_OUT_6	TTL OUT for Channel 6. LOW=ACTIVE
18		TTL_OUT_7	TTL OUT for Channel 7. LOW=ACTIVE
19		TTL_OUT_8	TTL OUT for Channel 8. LOW=ACTIVE

Pin	Module	Name	Description
20	Process Control TTL IN	ANODE COM	External User +5 V IN
21		TTL_IN_1	TTL Input Signal for Channel 1. Active LOW
22		TTL_IN_2	TTL Input Signal for Channel 2. Active LOW
23		TTL_IN_3	TTL Input Signal for Channel 3. Active LOW
24		TTL_IN_4	TTL Input Signal for Channel 4. Active LOW
25		TTL_IN_5	TTL Input Signal for Channel 5. Active LOW
26		TTL_IN_6	TTL Input Signal for Channel 6. Active LOW
27		TTL_IN_7	TTL Input Signal for Channel 7. Active LOW
28		TTL_IN_8	TTL Input Signal for Channel 8. Active LOW
29		unused	
30		IGC100 Ground	
31		IGC100 Ground	
32	Process Control TTL OUT	COM_EMTR_REF	External User Ground
33		COM_COLTR_PULLUP	External User +5 V IN
34		TTL_OUT_1	TTL OUT for Channel 1. LOW=ACTIVE
35		TTL_OUT_2	TTL OUT for Channel 2. LOW=ACTIVE
36		TTL_OUT_3	TTL OUT for Channel 3. LOW=ACTIVE
37		TTL_OUT_4	TTL OUT for Channel 4. LOW=ACTIVE

Note: ↓=HIGH-to-LOW, ↑=LOW-to-HIGH transition.

Process Control TTL OUT

These outputs are opto-isolated from the IGC100. For isolated operation of ALL outputs, connect pin 33 to the external +5 V supply and pin 32 to the external ground. For non-isolated operation of ALL outputs, connect pin 33 to IGC100 Vcc (pin 1 or 15) and pin 32 to IGC100 Ground (pin 30 or 31).

Process Control TTL IN

These inputs are opto-isolated from the IGC100. For isolated operation of ALL Process Control inputs, connect pins 2 and 20 to the external +5 V supply. Pull inputs to external ground for low inputs. For non-isolated operation of ALL Process Control inputs, connect pins 2 and 20 to IGC100 Vcc (pin 1 or 15) and pull inputs to IGC100 Ground (pin 30 or 31) for low inputs.

Remote Control TTL IN

These inputs are opto-isolated from the IGC100. For isolated operation of ALL Remote Control inputs, connect pins 2 and 20 to the external +5 V supply. Pull inputs to external ground for low inputs. For non-isolated operation of ALL Remote Control inputs, connect pins 2 and 20 to IGC100 Vcc (pin 1 or 15) and pull inputs to IGC100 Ground (pin 30 or 31) for low inputs.

RS-232 Connector

The IGC100 uses a DIN8 connector for its RS-232 port while most PC computers use DB9 connectors. A DIN8-DB9 connector adapter cable is provided with every IGC100 controller. The female DB9 connector of the DIN8-DB9 connector adapter cable is configured as a DCE.

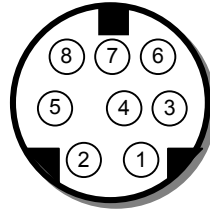

Figure 2-8. The IGC100 DIN8 RS-232 connector.

Pin	Signal
1	handshake out
2	handshake in
3	Transmit data
4	ground
5	Receive data
6	unused
7	unused
8	ground

Specifications

Specifications apply after 1 hour of warm-up and assume single filament (Fil1 or Fil2) ionization gauge operation with a signal cable shorter than 50 ft.

General

Pressure Range	1000 Torr to UHV ($<10^{-11}$)
Compatible gauges	Bayard-Alpert type ionization gauges, convection enhanced Pirani gauges, capacitance manometers with 0 to 10 Vdc linear output.
Dual Pirani gauge	Simultaneous readout of two Pirani gauges (std.)
Dual ion gauge	Sequential readout of a second ion gauge (opt.)
Auto-Start	Use PG1 or PG2 to automatically turn IG1 or IG2 on/off when pressure goes through user-defined level.
Interfaces	RS-232 (std.), optional GPIB (opt. 01) or Ethernet interface with embedded web server (opt. 02)
Power	90 to 264 VAC, 47 to 63 Hz, 240 W
Operating temperature	0°C to 40°C, non-condensing Less than 90% humidity
Weight/Dimensions	15 lbs. / 8.5"x5.25"x16" (WHD)
Warranty	One year parts and labor

Display

Type	Back-lit, touchscreen LCD (4.7" diag)
Resolution	320 x 240 pixels
Modes	Numeric, bargraph, P vs. T
Units	Torr, mbar, bar, Pa and micron
Numeric resolution	3 digit mantissa plus exponent
Update rate	2 samples per second

Electrical (20°C to 30°C)

Electron Emission Current

Range	10 μ A to 12 mA
Stabilization	Electronically controlled
Accuracy	$\pm 1\%$ of setting

Anode

Potential	+180 Vdc
Accuracy	$\pm 0.3\%$ of setting

Filament

Potential	+30 Vdc
Accuracy	$\pm 0.3\%$ of setting
Filament power (max)	7 Amps DC, 7 Vdc

Degas

Mode	Electron bombardment
Power	1 to 75 W, adjusted in 1 Watt steps
Time	1 to 30 min., adjusted in 1 min. steps
Anode potential	500 Vdc
Emission current	2 to 150 mA
Display	Approximate pressure, degas power and remaining time

Electrometer

Accuracy	±1% of reading
Zero drift	0.4 pA

Analog I/O

Ports	4 configurable analog ports
Range	±12 Vdc
Resolution	14-bit (In), 12-bit (Out)
Update rate	2 Hz
Connector	BNC

Gauges**Ionization Gauge**

Gauge type	Bayard-Alpert type ionization gauges including glass tubulated (std. and broad-range), nude, nude-UHV, STABIL_ION [®] , MICRO_ION [®] . Supports tungsten (W) and ThO ₂ Ir filaments.
Pressure range	10 ⁻¹¹ to 10 ⁻¹ Torr Lower limit: X-ray limit of Bayard-Alpert gauge Upper limit: Maximum operating pressure specified by manufacturer
Pressure calculation	From sensitivity constant or full range calibration curve
Sensitivity constant	0.1/Torr to 100/Torr
Filament selection	Filament 1, Filament 2, or both
Overpressure protection	Programmable trip points, auto-start protection
Analog output	log, 1V/decade, 1 to 10 V

Convection Enhanced Pirani Gauge

Gauge type	PG105 & PG105-UHV Convection Enhanced Pirani gauges, CONVECTRON [®] and HPS/MKS Series 317 Convection-Enhanced Pirani gauges.
Pressure range	999 to 10 ⁻³ Torr. Lower pressure limit extends to 10 ⁻⁴ Torr w/ zero adjustment.
Gas type calibration	Direct readings for air, N ₂ and Ar. Menu driven zero and atmospheric adjustments.
Analog output	log, 1V/decade, 1 to 8 V

Capacitance Manometer

Number of gauges	Simultaneous readout of up to four capacitance manometers using the auxiliary inputs.
Auxiliary power output	±15 Vdc, 100 mA (for CM power)

Process Control (opt. 03)

Number of channels	8 channels with programmable setpoint, polarity, hysteresis, delay, audio signal and text messages.
Input signals	Pressure (any gauge), voltage (I/O ports), time (internal clock), TTL and gauge status.
Output signals	Relay and TTL level
Relays	SPDT, form C, 5A/250VAC/30VDC, resistive load
TTL outputs	Active low, opto-isolated
Manual control	All channels can be operated from front panel.
Remote TTL control	12 opto-isolated TTL channels (Remote Enable, IG1 on/off, IG2 on/off, Degas on/off, Fil 1/Fil 2 select, IG lockout, IG Control keypad lockout, PG1 on/off, PG2 on/off, data logging time reset, touchscreen enable/disable)

Index of Commands

Important

Always use the GPMU command at the start of a program to ensure that the desired units are in effect. Use front panel lockout if a units change would result in system malfunction.

Use VERB 0 to set the RS-232 serial interface to terse mode for computer programs. Use VERB 1 to use verbose mode for serial console communications.

Variables

i, j, d, n, p	integers
x	real number
s, t	text strings

Measurements

GPMU (?) {n} {s}	Pressure Units
GDAT ? p	Read Gauge/Port
GDTX ? p	Read Gauge/Port With Units
GPBA (?) n {, i}	Data Bar Assign
GPDF (?) n {, i}	Display Format

Gauges

GDES (?) p {, s}	Gauge Location
GSTA ? p	Gauge Status
GSTT ? p	Gauge Status Time

Ion Gauge Setup

GPOW (?) p {, i}	Power
CSEN (?) p {, x}	Sensitivity Factor
CGCF (?) p {, x}	Gas Correction Factor
CRVI (?) p {, i}	Calibration Source
IGEC (?) p {, x}	Emission Current
GFIL (?) p {, i}	Filament Select
GOSD (?) p {, i}	Overpressure Shutdown
GOTH (?) p {, x}	Overpressure Threshold
GODE (?) p {, n}	Overpressure Delay
GOAA (?) p {, i}	Overpressure Audio Alarm
DGAS (?) {i}	Degas On/Off
DENA (?) {i}	Degas Enable/Disable
DPOW (?) p {, n}	Degas Power
DTIM (?) p {, x}	Degas Time
AOPG (?) {i}	Auto-Start Pirani Gauge
AOIG (?) {i}	Auto-Start Ion Gauge
AOTH (?) {x}	Auto-Start Threshold
AOCN (?) {i}	Auto-Start On/Off
GHGF ?	Read Gauge History First
GHGN ?	Read Gauge History Next

Pirani Gauge Setup

GPOW (?) p {, i}	Power
CGCF (?) p {, x}	Gas Correction Factor
CRVP (?) n {, i}	Calibration Curve

xxviii Commands

Analog Port Setup

GADM (?) n {, i}	I/O Mode
GDAS (?) n {, i}	DAC Source
ANDF (?) n {, i}	Display Format
GDAV (?) n {, x}	Output Value
CMPX (?) n {, x}	CM PMax

Logging

PLDS (?) {i}	Chart/Table Display
PLCL	Clear Data Log
PLGF ?	Read Data Log First
PLGN ?	Read Data Log Next
PLIN (?) {n}	Logging Interval
PLWT (?) {n}	Log Length
PLEN (?) {i}	Logging Enable
PLDD (?) {i}	Display Date
PLTR (?) {i}	TTL Reset Enable

Charting

LCPN (?) {x}	Pmin
LCPX (?) {x}	Pmax
LCVN (?) {x}	Vmin
LCVX (?) {x}	Vmax
LCSA	Autoscale Y-Axis
LCRG (?) {n}	Time Range
LCSF	Scale X-Axis to Full

Process Control

RDES (?) d {, s}	Channel Description
RLCL (?) d {, s}	Channel Active Label
RLOP (?) d {, s}	Channel Inactive Label
RBEP (?) d {, i}	Channel Beep
RMOD (?) d {, i}	Channel Mode
RSTA (?) d {, i}	Channel State
RAMS (?) d {, i}	Channel Input
RGOS (?) d {, i}	Gauge Off State
RTRP (?) d {, x}	Pressure Setpoint
RPHY (?) d {, n}	Percent Hysteresis
RTRV (?) d {, x}	Voltage Setpoint
RVHY (?) d {, x}	Voltage Hysteresis
RPOL (?) d {, i}	Setpoint Activation
RDEL (?) d {, n}	Setpoint Delay
RTCL (?) d {,n} {,s}	Activation Time
RTOP (?) d {,n} {,s}	Deactivation Time
RTIL (?) d {, i}	TTL Activation Level
TTL ?	Read TTL Inputs
RHGF ?	Read Process Log First
RHGN ?	Read Process Log Next
RHCL	Clear Process Log
RBAD ?	Relay Failure Status

Backlight

BLEN (?) {i}	Backlight Saver Enable
BLIT (?) {i}	Backlight On/Off
BLOF (?) d {,n} {,s}	Backlight Turn-Off Time
BLON (?) d {,n} {,s}	Backlight Turn-On Time
BLTD (?) {n}	Backlight Delay

Security

LOCK ?	Query Locked
PWDL i, s	Lock/Unlock
CPWD	Copy Password to Card
STPW s	Set Password.
SECF (?) d {, i}	Security Flags
WSEN (?) {i}	Web Server Enable

System

NAME (?) {s}	System Name
SNUM?	Serial Number
TIME (?) {s}	Time
DATE (?) {s}	Date
VOLC (?) {n}	Volume
MENU d	Display Screen
MESG (?) {s}	Message
DHWR ? d	Detect Hardware
*TST ?	Self-Test
FREV ?	Firmware Revision
VRDT ?	Firmware Build

Interface

VERB (?) {i}	Verbose RS-232
*IDN ?	Identification
*RST	Reset
*OPC (?)	Operation Complete
*WAI	Wait to Continue

Status

*CLS	Clear Status
*PSC (?) {i}	Power-On Status Clear
*STB ? {i}	Read Serial Poll Status
*SRE (?) {i} {,j}	Serial Poll Enable
*ESR ? {i}	Read Standard Event Status
*ESE (?) {i} {,j}	Standard Event Enable
ERSW ? {i}	Read Error Status
ERSE (?) {i} {,j}	Error Status Enable
GSSW ? {i}	Read Gauge Status
GSSE (?) {i} {,j}	Gauge Status Enable
RSSW ? {i}	Read Process Status
RSSE (?) {i} {,j}	Process Status Enable

Damage Requiring Service

Caution

Do not use this product if it has unauthorized modifications. Unauthorized modifications may result in fire, electric shock and other hazards.

Do not use accessories not recommended in this manual as they may be hazardous.

Note

Within this section, the word 'product' specifically refers to the IGC100 Ion Gauge Controller, any of its accessories, or any SRS manufactured vacuum gauge.

Contact the factory for instructions on how to return the instrument for authorized service and adjustment.

Service of this product, by Authorized Service Personnel only, may be required under any of the following conditions:

- Any cable or plug is damaged.
- The product does not operate properly even after strictly following the operating instructions.
- The product exhibits a distinct change in performance.
- A liquid has spilled inside the product.
- The product has been exposed to rain or water.
- An object has fallen into the product.
- The product has been dropped or the enclosure has been damaged.
- The product contains unauthorized modifications. Do not substitute parts or modify the product. No user-serviceable parts are inside the controller. All service and repair information in this manual is for the use of Authorized Service Personnel only.
- If the product is a vacuum gauge, a Declaration of Contamination, describing the condition of the product and listing the gases it has been exposed to, must be submitted to Stanford Research Systems for review before a return authorization can be issued.
- The repair and/or service of products exposed to vacuum systems can only be carried out if a completed Declaration of Contamination has been submitted. Stanford Research Systems reserves the right to refuse acceptance of vacuum equipment where the Declaration of Contamination has not been fully or correctly completed. SRS also reserves the right to deny return authorizations for any vacuum equipment that could potentially be harmful to the personnel carrying out the repair and service of the product.

Declaration of Contamination of Vacuum Equipment

The repair and/or service of vacuum equipment or components can only be carried out if a completed **Declaration of Contamination** has been submitted to Stanford Research Systems (SRS). The completed declaration must be reviewed by qualified personnel before a return authorization number (RMA#) can be issued. Contact SRS to request additional copies of this form or if you have any questions regarding the contents of this declaration.

- SRS reserves the right to refuse acceptance of vacuum equipment submitted for repair or maintenance work where the declaration has been omitted or has not been fully or correctly completed.
- SRS reserves the right to refuse to service any vacuum equipment which could potentially be harmful to the personnel carrying out the repair and service of the equipment.
- SRS will not accept any equipment which has been radioactively or explosively contaminated.
- SRS will not service any equipment that might contaminate its vacuum calibration equipment.

Description of equipment

Equipment type/model: _____

Serial No.: _____ Date of Purchase: _____

Reason for return (circle one): • Repair • Maintenance

Please describe symptoms and problems:

Equipment condition

Has the equipment been used ? (circle one) • Yes • No

Describe the operating environment the instrument was exposed to:

Declaration of Contamination of Vacuum Equipment (cont.)

Was any of the equipment exposed to potentially harmful substances? (circle one)

- No
- Yes.

Please attach list of all known harmful substances including chemical name and symbol, precautions associated with the substance and first aid measures in the event of accident.

Were any of the harmful substances:

- Radioactive? • Yes • No
- Toxic? • Yes • No
- Corrosive? • Yes • No
- Explosive? • Yes • No

Was the equipment decontaminated/cleaned before being shipped to SRS?

- Yes • No • Not Applicable

Legally Binding Declaration

I hereby declare that the information supplied on this form is complete and accurate. The dispatch of equipment will be in accordance with the appropriate regulations covering Packaging, Transportation and Labeling of Dangerous Substances.

Name (print): _____

Job Title: _____

Organization: _____

Address: _____

Telephone: _____ Fax: _____

Email: _____@_____

Legally binding signature: _____ Date: _____

SRS Use Only.
RMA#: _____
Form reviewed by:
Signature _____
Name/Initials _____
Date: _____

Chapter 1

Getting Started

This chapter provides instructions for

- unpacking, checking and installing the IGC100 Ion Gauge Controller and its gauges
- connecting the cabling between the controller and its gauges
- setting up the controller
- measuring pressures

In This Chapter

Unpacking	1-3	Installing a Pirani Gauge	1-24
Before You Open the Box	1-3	Compatible Gauges	1-24
Checklist	1-3	SRS Gauges	1-24
Standard Equipment/Supplies	1-3	Third-Party Gauges	1-24
Optional Equipment	1-3	Handling	1-25
Installing the IGC100 Controller	1-5	Mounting Orientation	1-25
Mounting Options	1-5	Below 1 Torr	1-25
Line Power Connection	1-5	Above 1 Torr	1-25
Grounding	1-6	Vibration Isolation	1-26
Before You Install a Vacuum Gauge	1-7	Proper Grounding	1-26
Recommendations and Warnings	1-7	Fitting Options	1-26
Installing an Ionization Gauge	1-9	Compression fittings	1-26
Compatible Gauges	1-9	1/8" NPT Fittings	1-26
SRS Gauges	1-9	Other fittings	1-27
SRS Calibrated Gauges	1-9	Connecting a Pirani Gauge	1-28
Third-Party Gauges	1-9	SRS Gauges	1-28
Installing a Glass-Tubulated Gauge	1-10	Third-Party Gauges	1-28
Installing a Nude Gauge	1-11	Connection to IGC100 Control Unit	1-28
Installing STABIL-ION [®] and MICRO-ION [®]		Connection to Gauge Head(s)	1-29
Gauges	1-12	PG1 Port (RED)	1-29
Connecting an Ionization Gauge	1-13	PG2 Port (GREEN)	1-29
Cable Options	1-13	Installing a Capacitance Manometer	1-31
Connecting to the IGC100 Controller	1-14	 Connecting a Capacitance Manometer	1-32
Single Gauge Connection (IG1)	1-14	Grounding	1-32
Dual Gauge Connection (O100IG Option)	1-15	Pressure Signal Connection	1-33
Connecting a Single Filament Glass-Tubulated		Power Connection	1-33
Ion Gauge, (O100C1 Cable)	1-15	Measuring Pressure	1-35
Connecting a Dual Filament Glass-Tubulated		 IGC100 Quick Setup	1-35
Ion Gauge, (O100C2 Cable)	1-18	Power-On Procedure	1-35
Connecting a Nude Ionization Gauge, Single		 Gauge Setup Procedure	1-37
or Dual Filament (O100C3 Cable)	1-21		
Connecting a STABIL-ION [®] or MICRO-ION [®]			
Gauge	1-23		

1-2 Getting Started

Setting Gauge Parameters	1-39
Uncalibrated Ionization Gauge (IG1, IG2)	1-39
Default Setup Files	1-39
Calibrated Ionization Gauge (Memory Card)	1-42
Pirani Gauge (PG1 and PG2)	1-42
Capacitance Manometer (CM1-4)	1-43
Pressure Measurement	1-44
Warm-up times	1-44
Ionization Gauge (IG1)	1-44
Degassing an Ionization Gauge	1-45
Pirani Gauge	1-48
Capacitance Manometer	1-48
Pressure Display Formats	1-50
Pressure Units	1-50
Display Types	1-50
Big Numbers	1-50
Trend Graph	1-50
Auto Scaling Bar Graph	1-51
Full Range Bar Graph	1-51
Status Information	1-51
Logging	1-52
IG Auto-Start mode (IG AUTO)	1-53
RS232 Serial Cable Connection	1-54
Proper Grounding Test Procedure	1-55
Ground Test Procedure:	1-56

Unpacking

Before You Open the Box

Read the entire **Safety and Preparation for Use** section of this manual before starting any installation procedure.

Take a moment at this time to read the installation, operation and safety instructions for any ionization, capacitance manometer or Pirani gauges not purchased directly from Stanford Research Systems.

Read and strictly follow all installation instructions in this chapter to ensure that the performance of this instrument is not compromised by an incorrect installation.

Read and follow all safety and warning instructions in this manual to minimize the risk of injury and death to yourself and others.

Do NOT power up the instrument until specifically directed by the instructions.

Checklist

Open the box(es) and inspect all components of the IGC100 system.

Report any damage to Stanford Research Systems immediately.

Compare the contents of the shipping boxes against your original order and the checklist below. Report any discrepancies to Stanford Research Systems immediately.

Standard Equipment/Supplies

- IGC100 Ion Gauge Controller Box.
 - Power cord.
 - Operating Manual and Programming Reference.
 - DIN8-DB9 Connector Adapter for Serial RS-232 Communication.
 - Three (3) Position Terminal Block Plug for AUX ± 15 Vdc output.
 - Three (3) blank Password Cards.
-

Optional Equipment

- Dual Ionization Gauge Connector Box (SRS# O100IG)
 - GPIB Computer Interface (Opt. 01). Preinstalled at the factory.
 - Web Interface (Opt 02). Preinstalled at the factory.
-

1-4 Unpacking

- ❑ Process Control Board (Opt 03). Preinstalled at the factory.
Includes: (1) one DB37 Digital I/O Connector (male)
(2) two 12-position Terminal Block Plugs for relay connections.
- ❑ Rack Mount Shelf, for up to two IGC100's (SRS# O100IGRM).
- ❑ Bayard-Alpert Ionization Gauge(s).
- ❑ Ionization Gauge Signal Cable(s) (SRS# O100C1, O100C2 or O100C3).
- ❑ Cable Adapter(s) for Granville Phillips MICRO-ION[®] gauge (SRS# O100CA1).
- ❑ Convection-Enhanced Pirani Gauge(s) (PG105 or PG105-UHV).
- ❑ Pirani Gauge Signal Cable for PG105 and PG105-UHV (SRS# O105C4).
- ❑ Connector Adapter(s) for Granville Phillips Convectron[®] Pirani Gauge (SRS# O105CA1).
- ❑ Connector Adapter(s) for HPS[®] Series 317 Convection-Enhanced Pirani Gauge (SRS# O105CA2).

Installing the IGC100 Controller

Read the entire **Safety and Preparation for Use** section of this manual before starting any installation procedure.

Mounting Options

The IGC100 offers a variety of mounting options to fit your needs: (1) bench-top, (2) half-rack and (3) two units, side-by-side, in full-rack width.

Place the controller in a secure place on your bench-top or mount it into an equipment rack tray (SRS# O100IGRM, compatible w/standard 19 inch rack). In all cases, provide adequate ventilation for the control unit to dissipate heat - *≈1 inch clearance around the side ventilation slots is recommended*. Allow at least 6 inches at the back of the controller for cable routing. Do not mount the unit above other equipment that generates excessive heat. The IGC100 is designed to operate over the range 0-40°C. Ambient temperatures above that value may damage the instrument. For optimum electrometer stability (especially while using calibrated gauges) the ambient temperature should be 25±5°C.

Line Power Connection

Line Voltage Selection

The IGC100 operates from a 100 V, 120 V, 220 V, or 240 V nominal AC power source having a line frequency of 50 or 60 Hz.

Use the power entry module on the back panel of the IGC100 to power the unit from a wall outlet. Make sure that suitable power is available for the controller: 100-240 Vac, 50-60 Hz, 500 W. Use the three-wire power cord, provided by Stanford Research Systems, to connect the IGC100 to a **properly grounded** wall outlet. Contact Stanford Research Systems if a power cord compatible with your outlets was not included with your unit.

The connection of LINE power to the box is clearly indicated by a lighted LINE LED (red) located below the POWER button at the lower left corner of the front panel.

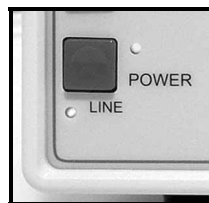

Figure 1-1. LINE LED below the POWER button indicates that Line Power is **connected**.

WARNING!

Do not switch on the power yet! Wait until instructed to do so later. Make sure that the green POWER LED is off.

Grounding

Connect a heavy duty ground wire, #12 AWG or larger, from the CHASSIS GND lug on the back of the IGC100 **directly to your facility earth ground**. This will provide an earth ground for the IGC100 in case the power cable is not in place. *Do not connect the CHASSIS GND lug to the vacuum system or other electrical component.* Connect it directly to the facility grounding system such as a grounded outlet box or a grounded copper water supply line. Do not rely on small metal water lines to ground a component. Get professional help from an experienced electrician if necessary.

WARNINGS!

- Connecting the power cord to a properly grounded outlet is necessary, but not sufficient with this (or any similar) high voltage producing vacuum equipment.
- Grounding the IGC100 does not and cannot guarantee that other components of the vacuum system are all maintained at earth ground.
- Perform a **Proper Grounding Test** on your vacuum system (described at the end of this chapter) if uncertain about the electrical safety of your vacuum setup. Consult an experienced electrician if necessary.



Figure 1-2. Power and chassis-ground connection on the back of the IGC100 controller.
1. Power entry module with power cord (connected to grounded wall outlet on the other end),
2. CHASSIS GND lug with heavy gauge ground wire connected **directly** to facility earth ground.

Before You Install a Vacuum Gauge

Read the entire **Safety and Preparation for Use** section of this manual before starting any installation procedure.

The IGC100 Ion Gauge controller measures pressures between 10^{-11} and 1000 Torr using a combination of gauges that includes: Ionization (hot-cathode, Bayard-Alpert type), Convection-Enhanced Pirani and Capacitance Manometers. It is not unusual for all of these types of gauges to coexist in a high-vacuum setup, each monitoring gas pressures in different sections of the system. To take advantage of the wide-pressure range of IGC100, only use gauges known to be fully compatible with this instrument.

This chapter describes the basic steps required for the safe and successful installation of the three types of gauges compatible with IGC100 onto a vacuum system. With the exception of capacitance manometers, the gauge installation information is tailored towards gauges purchased directly from Stanford Research Systems. Keep in mind that gauges purchased from third-party vendors will have specific installation and warning instructions and requirements that are not covered by these instructions.

WARNINGS!

- Take a moment at this time to review the specific installation, operation and safety instructions for any ionization, capacitance manometer or Pirani gauges purchased from third-party sources.
- It is the responsibility of the end-user to assure the safe installation and compatibility of third-party gauges with the IGC100 controller.

Recommendations and Warnings

- Perform a **Proper Grounding Test** on your vacuum system (as described at the end of this chapter). If you are uncertain about the electrical safety of your vacuum system, get professional help from an experienced laboratory electrician.
- **Do not use compression fittings for positive pressure applications.** The gauge may be forcefully ejected causing injury to personnel.
- For best results, locate gauges close to where the pressure needs to be measured.
- High pressure areas might develop around gas sources, such as valves, orifices and contaminated areas.
- If a gauge is placed near a pump, the pressure at the gauge might be much lower than in the rest of the system.
- Always maintain a high conductance connection between the gauge and the pressure being measured. Avoid small diameter tubulation. Eliminate all gas flow restrictions such as orifices.

1-8 Before You Install a Vacuum Gauge

- Minimize temperature effects by locating pressure gauges away from heat sources and in a region where the temperature is reasonably constant. This is particularly critical for measurements with calibrated gauges.
- If your vacuum system has an electron beam source, all ionization gauge tube electrodes must have a shield around them to keep spurious charged particles away.
- Gauges can get hot during normal operation. Keep your hands away from ionization gauges during use. Prevent low-temperature rated material, such as wire insulation, from touching the hot parts of your gauges.
- Verify that the vacuum port to which your gauge is being mounted is electrically grounded.
- To reduce the chances of contamination, do not remove pressure gauges from their protective shipping containers until moments before they are ready to be attached to the vacuum system.
- Follow good high-vacuum practice at all times. Avoid contaminating the vacuum gauges and your vacuum system. Wear gloves! Do not talk or breathe into open vacuum ports.
- Set aside a clean, dust free, work area next to the vacuum chamber before installation begins.
- To avoid leaks with ConFlat[®] flanges, use high tensile-strength stainless steel bolts and NEW, clean OFHC copper gaskets. Do not use non-metal gaskets.
- High voltage can couple through a gas to the internal electrodes of a gauge if a plasma discharge is established. Never touch the exposed pins of any gauge installed on a vacuum system where high voltage is present. Typical high voltage sources include plasma sources, ionization gauges, mass spectrometers and electron multiplier detectors.
- When high voltage is present, all exposed conductors of a gauge must be rigorously grounded or shielded from contact.

Installing an Ionization Gauge

Read the entire **Safety and Preparation for Use** section of this manual before starting any installation procedure.

This section describes the basic steps required for the safe and successful installation of ionization gauges compatible with IGC100 onto a vacuum system. Keep in mind that gauges purchased from third-party vendors will have specific installation and warning instructions and requirements that are not covered by these instructions.

Compatible Gauges

To take advantage of the full pressure range of IGC100, and to avoid the risks of injury and damage to equipment, you must always use compatible ionization gauges.

Industry-wide standardization of the Bayard-Alpert Gauge (BAG) design allows the IGC100 to be compatible with virtually every commercially available Bayard-Alpert ionization gauge. This includes glass-tubulated, nude, nude-UHV, STABIL-ION[®] (Granville-Phillips) and MICRO-ION[®] (Granville-Phillips) products.

Appendix A includes detailed information on the principle of operation of Bayard-Alpert ionization gauges. Consult Appendix E regarding the selection of Bayard-Alpert ionization gauges for new applications.

SRS Gauges

The IGC100 is fully compatible with all Bayard-Alpert Ionization gauges available directly from Stanford Research Systems.

SRS Calibrated Gauges

IGC100 users may opt to have their new ionization gauges calibrated at the SRS High Vacuum Calibration Facility. The BAG response is calibrated below 10^{-3} Torr by comparison against a NIST-traceable secondary standard and the information is stored in a Memory Card that is provided with each calibrated gauge. The calibration curve, including all relevant controller setup information, can then be easily transferred into the IGC100 using the Memory Card. For details on ionization gauge calibration options, consult Appendix F of this manual.

Note

SRS calibrated ionization gauges include a Memory Card in their package. Keep the card in a safe place after gauge installation since it will be required later during IGC100 setup.

Third-Party Gauges

A manufacturer cross-reference table (Appendix B) lists some popular ionization gauges known to be compatible with the IGC100. The specifications of third-party ionization gauges should always be compared against the IGC100 specifications before a final connection is established. Stanford Research Systems is not responsible for changes in design or specifications of third-party products that might render them incompatible with

the IGC100 controller. While checking for gauge compatibility, particular attention must be given to gauge sensitivity, grid bias voltage, filament bias voltage, recommended emission current settings, filament drive requirements and degas power specifications. The IGC100 can be programmed to accommodate a large range of gauge sensitivities, emission currents and degas power levels. The grid (+180 Vdc) and filament (+30 Vdc) bias potentials are not adjustable. Consult your gauge manufacturer and Stanford Research Systems if you are unsure about the compatibility of your third-party ionization gauges.

Installing a Glass-Tubulated Gauge

WARNING!

To reduce the risk of dangerous explosions, do not use glass-tubulated gauges in vacuum systems routinely pressurized above atmosphere.

Glass-tubulated gauges are fragile and present a safety hazard due to implosion if not adequately shielded. Place glass tubulated gauges where they cannot be bumped, use metal shields, and be very gentle during installation.

Most glass-tubulated gauges are connected to the vacuum system through an O-ring compression fitting. *The most common problem during gauge installation is crushed side tubes due to excessive tightening of compression fittings!* Whenever possible, use metal (i.e. Kovar) side tubulation to avoid this problem. Kovar side tubulation is most often welded to ConFlat[®] and Klein flanges for compatibility with standard vacuum ports. While slightly more expensive, flanged tubulated gauges offer better vacuum integrity and higher bakeout temperatures than standard compression fittings. To minimize the possibility of leaks in flanged connections, use only new and clean OFHC copper gaskets with ConFlat[®] Flanges. Pyrex is the material of choice when the side tube must be directly glass-blown on to the vacuum system.

If possible, install the gauge so that the filament is visible at all times- a quick visual check might save a tungsten filament from burnout during a venting or gas loading process.

The preferred mounting orientation is with the electrode assembly and filament in a *vertical position* to minimize electrode and filament distortion caused by gravity and thermal cycles. To avoid the possibility of excessive temperature at the electrical connector, it is best to install the gauge with *the electrical connection pins below the glass tube*.

WARNING!

Do not connect the glass-tubulated ionization gauge to the IGC100 cable until instructed to do so later in this chapter.

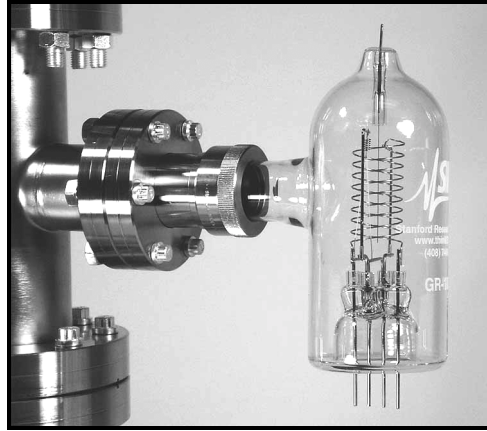

Figure 1-3. A glass-tubulated Bayard-Alpert gauge attached to a vacuum system through a compression fitting and mounted with the recommended vertical orientation - base pointing down.

Installing a Nude Gauge

In the nude Bayard-Alpert ionization gauge, the electrode structures are welded on to insulating feedthroughs mounted on a 2.75" ConFlat® Flange and inserted directly into the vacuum chamber environment. Before removing the nude Bayard-Alpert gauge from its shipping container, locate the SRS# O100C3 cable package. This cable is required to connect your nude ionization gauge to the IGC100 controller. Separate the metal ring from the package. Before you begin, make sure you also have: 1. a *new and clean* OFHC copper gasket (for 2.75" ConFlat® flanges) and 2. the required bolts (see Figure 1-4) and wrenches.

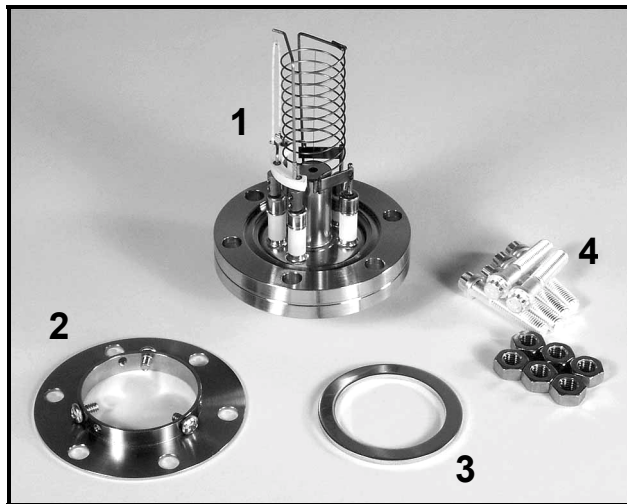

Figure 1-4. Nude-BAG Installation Hardware: 1. Nude-UHV gauge, 2. Metal ring (from O100C3 cable kit), 3. OFHC copper gasket (new and clean), 4. High tensile strength stainless steel bolts (wrench not shown).

Remove the gauge from its protective packaging. Position a new and clean OFHC copper gasket on the ConFlat® port of the vacuum system and carefully insert the nude gauge into the vacuum system port. Since the delicate electrodes are exposed, *be very careful*

1-12 Installing an Ionization Gauge

during installation to avoid distorting and damaging the filament and/or anode grid structure.

Place the O100C3 metal ring against the back of the feedthrough flange, as shown in Figure 1-5, and rotate the feedthru-flange and the ring until all six bolt-holes line up. Fasten the gauge and seal the port connection using high-tensile strength stainless steel bolts.

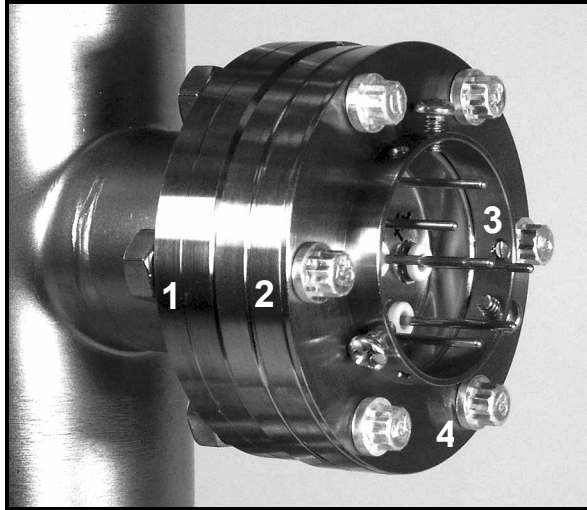

Figure 1-5. The nude ionization gauge attached to the vacuum system (2.75" ConFlat®) Port. 1. Vacuum system port, 2. Gauge feedthrough flange, 3. Metal ring, 4. Bolts (6 places).

WARNING!

Do not connect the ionization gauge to the IGC100 cable until instructed to do so later in this chapter.

Important

The sensitivity value of a nude gauge is dependent on the way it is mounted on the system. This is not new knowledge, but there is no widespread appreciation of the effect among many users of nude gauges. Fillipeli investigated the influence of envelope size and shape on the nitrogen sensitivity of conventional 'nude' BAGs (see A. R. Filippelli, "Influence of envelope geometry on the sensitivity of 'nude' ionization gauges", J. Vac. Sci. Technol. A 14(5) (1996) 2953). His report showed that changes in gauge envelope can result in measurement errors as large as 50% with some BAGs. Thus, *the envelope must be considered a part of an ionization gauge*, and a specification of 'nude' gauge sensitivity is not complete unless the geometry and potential of its envelope are also given. It is common practice to calibrate and operate nude ion gauges inside a nipple 38 mm ID x 100 mm long, with a metal screen at the input port.

Installing STABIL-ION® and MICRO-ION® Gauges

The IGC100 is fully-compatible with Granville Phillips' STABIL-ION® and MICRO-ION® gauges. Consult Appendix C or Appendix M for detailed installation, wiring and operating instructions.

Connecting an Ionization Gauge

Once the gauge and the controller are installed and properly grounded, the next step involves the connection of the IGC100 controller to the vacuum gauge through the signal cable. This section describes the connection of ionization gauges to the IGC100 controller using signal cables - SRS# O100C1, O100C2 and O100C3 - purchased directly from Stanford Research Systems. Both single and dual gauge connections are described.

WARNINGS!

- **Do not use homemade connections in your vacuum system.** The use of homemade gauge signal cables (i.e. not purchased directly from Stanford Research Systems) automatically voids the IGC100's warranty and can lead to dangerous operating conditions and expensive equipment damage.
- **Do not** switch the controller or gauge power on until instructed to do so. The green POWER LED on the IGC100 front panel should be off.
- Connect all gauge signal cables to the IGC100 controller *first*, before establishing a connection to the gauge heads.
- Do not attach signal cables to a glass-tubulated gauge pins while it is under vacuum. Accidental bending of the pins while pushing the connector plug may crack the glass base and cause a dangerous implosion of the gauge envelope.
- Cables, once installed, must be secured to provide strain relief for the gauge pins.

Cable Options (O100C1, O100C2 and O100C3)

There are three different signal cables for connecting ionization gauges to an IGC100 controller:

- O100C1 for a glass-tubulated ion gauge with single filament
- O100C2 for a glass-tubulated ion gauge with dual filaments
- O100C3 for a nude (all-metal) ion gauge with single or dual filaments.

Appendix B includes a list of the specific signal cables required by each ionization gauge model available from Stanford Research Systems, as well as for some third-party ionization gauges known to be electrically compatible with the IGC100 controller. All cables are identical at the end that connects to the IGC100, but different at the end that connects to the ionization gauge header. Separate instructions are required for the connection of each of the three signal cables to their respective ionization gauges.

WARNING!

Confirm the compatibility between your signal cable and your specific ionization gauge before proceeding further with these instructions. Consult Appendix B if necessary. Contact Stanford Research Systems if still in doubt!

Connecting to the IGC100 Controller (All Cables)

All signal cables are the same on the end that connects to the IGC100 controller (i.e. no gauge-specific instructions are required.)

Single Gauge Connection (IG1)

- (i) Connect the signal cable's BNC connector to the upper COLLECTOR BNC (labeled '1'), located on the back of the IGC100. Push the BNC connector all the way into the BNC receptacle, then turn the connector one-quarter-turn clockwise until it clicks firmly into place
- (ii) Connect the 7-pin plug to the ION GAUGE receptacle on the back of the IGC100 controller. Align the connector with the receptacle and then turn the plastic-ring clockwise to fasten the connection. Figure 1-6 shows the finalized connections on the back of an IGC100.



Figure 1-6. Single Ionization Gauge cable connection to the IGC100 controller.
1. 7-pin plug connection to ION GAUGE receptacle, 2. BNC connection to upper COLLECTOR input (labeled '1').

Note

The standard IGC100 has a single ionization gauge connector, labeled ION GAUGE, on its back panel and can control only one ionization gauge. When connected to a gauge, the ION GAUGE port is treated as 'IG1' by the IGC100 controller. This means that the IG1 Power button activates the gauge and the Pressure Display is set to 'IG1'.

Dual Gauge Connection (O100IG Option)

An optional Dual Ionization Gauge Connector Box (SRS# O100IG) can be plugged into the ION GAUGE receptacle, and used to simultaneously connect two ionization gauges (i.e. IG1 and IG2 port connections) to the back of the IGC100. This makes it possible for the controller to switch operation between two separate gauges (i.e. *sequential* operation) from the front panel, and measure pressure at two locations at a small fraction of the cost of a second instrument.

For information on the proper configuration and connection of the Dual Ionization Gauge Connector Box to the controller, consult the instructions provided with the Dual Ionization Gauge Connector Box (also included in Appendix L.)

Connecting a Single Filament Glass-Tubulated Ion Gauge, (O100C1 Cable)

WARNING!

- Make sure that the IGC100 is **NOT** turned on. The green POWER LED on the IGC100 front panel should be *off*.
- Connect the cable to a properly grounded IGC100 *before* attaching the cable to the gauge.

The SRS# O100C1 signal cable is specifically designed for connection to glass-tubulated ionization gauges with a single filament design.

Single filament, glass-tubulated gauges are easily identified by the in-line, 4-pin arrangement at the base connector of the gauge envelope.

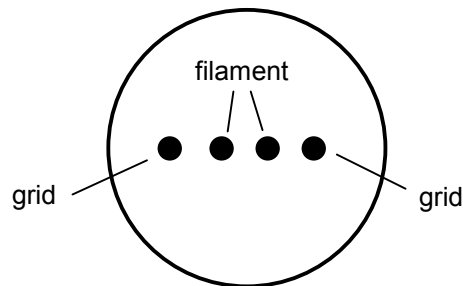

Figure 1-7. Pin Alignment for base connector of glass-tubulated gauge with single filament. IGC100 cable SRS# O100C1.

Connect the 4-pin cable connector to the base of the ion gauge as shown in Fig. 1-8. Align the connector with the pins, then gently push the connector onto the pins until it seats firmly in place.

Note

The 4-pin connector can attach to the ion gauge in two ways - one is rotated 180° from the other about the cylindrical axis of its plug. Since, the pin arrangement of glass-tubulated ionization gauges is symmetric, rotating from one connection orientation to the other *does not* affect the operation of the gauge.



Figure 1-8. O100C1 connection to a single filament, glass-tubulated, ionization gauge with 4-pin header configuration.

When the 4-pin connector is properly attached to the ionization gauge, it is recessed into the base of the gauge offering protection from the high voltages present on the pins.



Figure 1-9. O100C1 4-pin connector safely attached to the base of the glass-tubulated gauge.

Connect the remaining single-pin connector, attached to the coaxial cable, to the collector pin located on top of the ionization gauge envelope. Push the connector into the pin until it seats firmly in place.

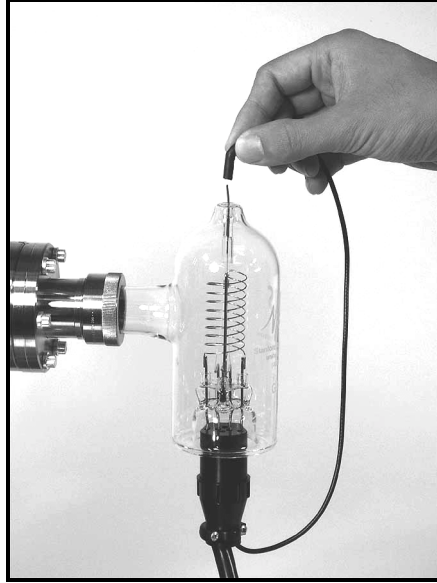

Figure 1-10. Single pin connection to the collector electrode.

The connectors of the O100C1 cable are specifically designed to completely shield the contact pins protecting vacuum users from dangerous high voltages. Once attached, the signal cable must be properly secured to provide strain relief for the gauge tube pins.

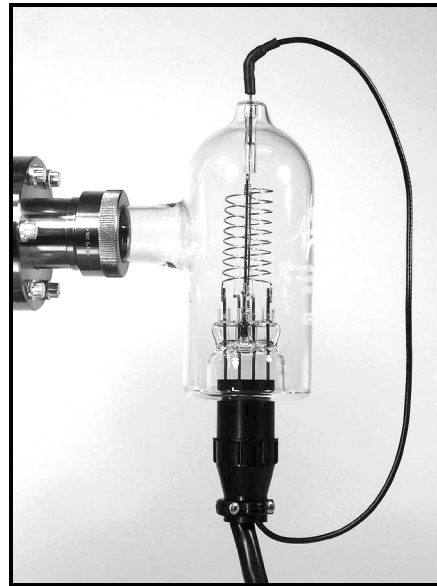

Figure 1-11. Picture of properly and safely connected glass-tubulated ionization gauge.

Connecting a Dual Filament Glass-Tubulated Ion Gauge, (O100C2 Cable)

WARNING!

- Make sure that the IGC100 is **NOT** turned on. The green POWER LED on the IGC100 front panel should be *off*.
- Connect the cable to a properly grounded IGC100 *before* attaching the cable to the gauge.

The SRS# O100C2 cable is specifically designed for connection to glass-tubulated ionization gauges with dual filament design.

Dual filament, glass-tubulated gauges are easily identified by the 6-pin connector pattern located at the base of the gauge envelope.

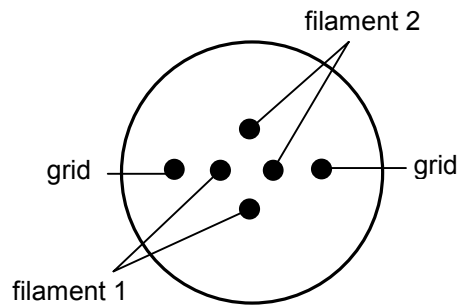

*Figure 1-12. Pin alignment for base connector of a glass-tubulated gauge w/dual filament.
IGC100 Cable SRS# O100C2*

Connect the 6-pin cable connector to the base of the ion gauge as shown in Fig. 1-13. Align the connector with the pins, then gently push the connector onto the pins until it seats firmly in place.



Figure 1-13. O100C2 connection to a dual filament, glass-tubulated, ionization gauge with 6-pin connector header.

Note

The 6-pin connector can connect to the ion gauge in two ways - one is rotated 180° from the other about the cylindrical axis of the plug. Since, the pin arrangement of glass-tubulated ionization gauges is symmetric, rotating from one connection to the other simply switches the Fil1/Fil2 assignment for the filaments. This is important to keep in mind for calibrated ionization gauges since the sensitivity is usually slightly different for both filaments. In order to avoid errors, the use of *single* filament electrodes is often recommended for calibrated ionization gauges.

When the 6-pin connector is properly attached to the ionization gauge, it is recessed into the base of the gauge offering protection from the high voltages present on the pins.



Figure 1-14. O100C2 6-pin connector properly attached to the base of the glass-tubulated gauge.

Connect the single pin connector attached to the thin coaxial cable to the top of the Ion Gauge. Push the connector into the pin until it sits firmly in place.

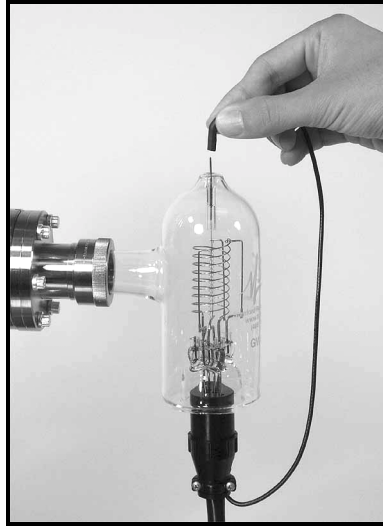

Figure 1-15. Single pin connection to the collector electrode of the gauge.

The connectors of the O100C2 cable are specially designed to completely shield the contact pins protecting vacuum users from dangerous high voltages. Once attached, the signal cable must be properly secured to provide strain relief for the gauge tube pins



Figure 1-16. Picture of the properly and safely connected glass-tubulated ionization gauge.

Connecting a Nude Ionization Gauge, Single or Dual Filament (O100C3 Cable)

WARNING!

- Make sure that the IGC100 is **NOT** turned on. The green POWER LED on the IGC100 front panel should be *off*.
- Connect the cable to a properly grounded IGC100 *before* attaching the cable to the gauge.

The SRS# O100C3 cable is specifically designed for connection to nude (i.e. all-metal) ionization gauges with both single and dual filament electrode structures.

The end of the cable that connects to the gauge head has six (6) individual push-on connectors housed inside a plastic connector-shield. In order to easily identify which connector attaches to which pin on the ion gauge feedthru flange, five (5) of the connectors are labeled: GRID [red], FIL 1 [yellow], FIL 2 [green], FIL RET [black], and FIL RET [black]. The sixth connector, which connects to the collector pin located in the middle of the feedthru flange, is black, unlabeled and the only one attached to a black coaxial cable. A plastic connector-shield, specifically designed to mate with the metal ring mounted on the back of the gauge's flange (see Fig. 1-17), provides protection against the high voltages present on the electrical connectors during regular operation.

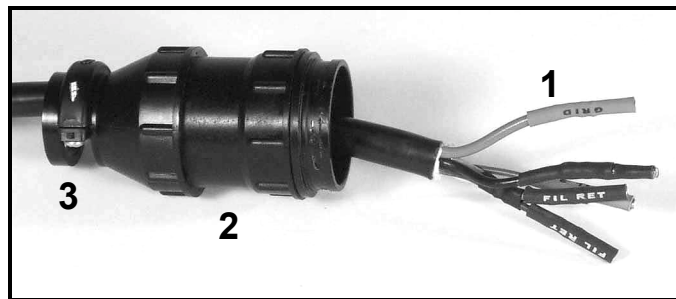

Figure 1-17. Gauge end of O100C3 signal cable: 1. Six (6) connector pins (labeled), 2. Plastic connector-shield, 3. Cable clamp w/screws. Note that the connector shield has been pushed back to expose the connectors and facilitate connection to the gauge pins.

Recommendation

In order to facilitate connection to the gauge, loosen the connector-shield cable clamp (3. in Fig. 1-17) with a #2 Phillips screwdriver and slide the entire assembly back until the connector ends are fully exposed and accessible before attaching them to the gauge pins.

Figure 1-18 describes the pin assignments for nude ionization gauges with one and two filament assemblies, viewed from the base.

1-22 Connecting an Ionization Gauge

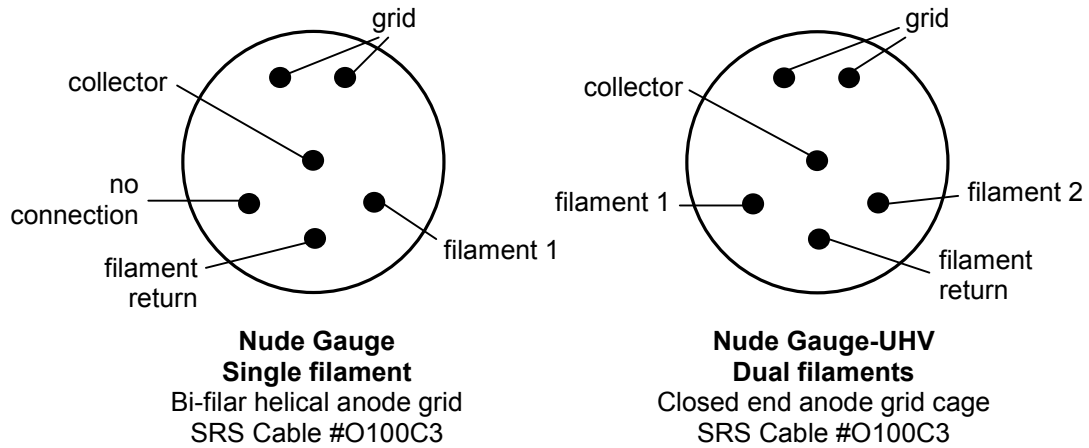

Figure 1-18. Pin assignments for nude ionization gauges, viewed from the base.

Connect the cable connectors to the appropriate pins on the base of the ionization gauge (consult Fig. 1-18). Both FIL-RET cable connectors are identical and only one needs to be connected to the gauge (fold the unconnected FIL RET cable connector back into the connector-shield with its end facing away from the metal flange). Push all connectors into the pins until they seat firmly in place.

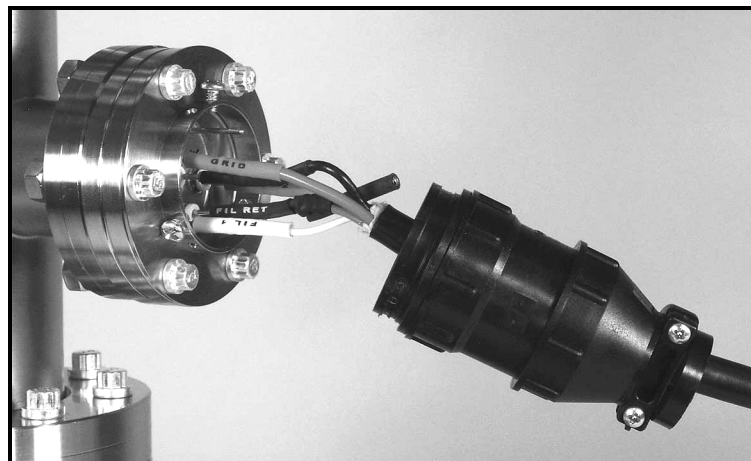

Figure 1-19. Cable connection to the base of a nude ionization gauge.

Slide the connector-shield assembly towards the gauge and fasten it to the metal ring on the gauge flange using its three side screws and a Phillips screwdriver. Fasten the connector-shield cable-clamp to firmly hold the entire connector assembly firmly in place.



Figure 1-20. Cable connection to the base of a nude ionization gauge with connector shield in place.

Connecting a STABIL-ION[®] or MICRO-ION[®] Gauge

IGC100 is fully-compatible with Granville Phillips' STABIL-ION[®] and MICRO-ION[®] gauges. Please consult Appendix C or Appendix M for detailed installation, wiring and operation instructions.

Installing a Pirani Gauge

Read the entire **Safety and Preparation for Use** section of this manual before starting any installation procedure.

Compatible Gauges

To take advantage of the full pressure range of IGC100, and to avoid the risks of injury and damage to equipment, you must always use compatible convection-enhanced Pirani gauges. The IGC100 is a generic controller, compatible with several commercially available Pirani Gauges, including: PG105 and PG105-UHV (SRS), HPS/MKS Series 317 and Convectron[®] (Granville-Phillips) models.

WARNING!

Do not connect a Pirani gauge to the IGC100 cable until instructed to do so later in this chapter.

SRS Gauges

SRS has developed its own line of convection-enhanced Pirani Gauges (PG105 and PG105-UHV) to complement the IGC100. Consult Appendix H of this manual for detailed information on the principle of operation, installation and operation of PG105 and PG105-UHV gauges. The installation instructions presented in this section are specific for PG105 and PG105-UHV gauges.

WARNING!

PG105 gauges should not be used in the presence of fluorine or mercury vapors. Both gases can react with the gold plated sensor and change its emissivity and/or overall diameter irreversibly. Consult Appendix H for additional gas compatibility details.

Third-Party Gauges

The IGC100 is also compatible with HPS/MKS Series 317 and Convectron[®] (Granville-Phillips) convection-enhanced Pirani gauges. Connector adapters (SRS# O105CA2 and O105CA1, respectively) are required to connect these gauges to the IGC100 dual connector cable (SRS# O105C4). The specifications of Pirani gauges manufactured by third-parties should always be compared against the IGC100 specifications before a connection is established. Stanford Research Systems is not responsible for changes in design or specifications of third-party products that might render them incompatible with the IGC100 controller. Consult your gauge manufacturer for specific gauge installation requirements and Stanford Research Systems if uncertain about the compatibility of IGC100 with your third-party Pirani gauge product.

Handling

WARNING!

All Pirani gauges include a very thin sensor wire that is easily damaged. Avoid dropping the gauge during installation.

Mounting Orientation

Below 1 Torr

The PG105 (-UHV) convection gauge will operate and report accurate pressures in any orientation.

Above 1 Torr

The PG105 (-UHV) convection gauge will accurately read pressures only while mounted with its axis horizontal.

WARNING!

- Erroneous readings can result in over or underpressure conditions which may damage equipment and/or injure personnel.
- In all cases, it is recommended that the gauge be installed with the port oriented *vertically downward* to ensure that no system condensates or other liquids collect inside the gauge tube. Care must be taken not to mount the PG105 tube in a way such that deposition of process vapor impurities may occur through direct line-of-sight access from the vacuum chamber to the interior of the gauge.

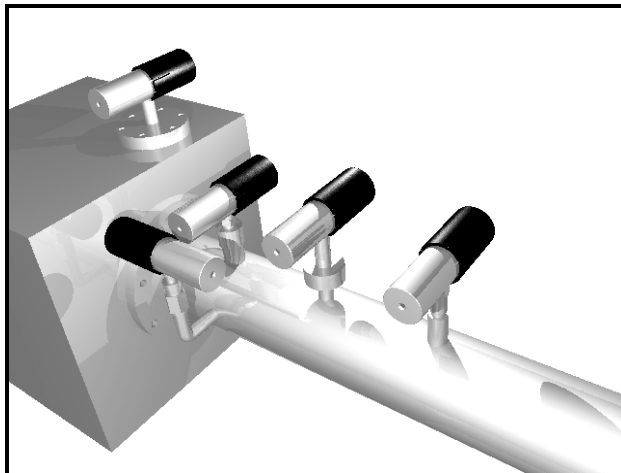

Figure 1-21. PG105 Gauge mounting examples.

Vibration Isolation

Mount PG105 gauges where they will not experience excessive vibrations. Vibration causes convection cooling of the sensor and results in high readings at the high pressure end. Damage to the filament is also possible.

Proper Grounding

Verify the proper electrical grounding of the vacuum port before connecting the PG105 gauge head to the vacuum system. *The gauge envelope must be properly grounded during operation.* If necessary, use a ground lug on a flange bolt to establish a dedicated connection to a facility ground. Alternatively, the gauge envelope may be grounded by using a metal hose clamp on the gauge connected to the system's safety ground by a #12 AWG copper wire.

Fitting Options

Compression fittings

The standard PG105 gauge port is designed to fit into any standard 1/2" compression fitting such as an Ultra-Torr[®] fitting.

WARNING!

Do not use compression fittings for positive pressure applications!

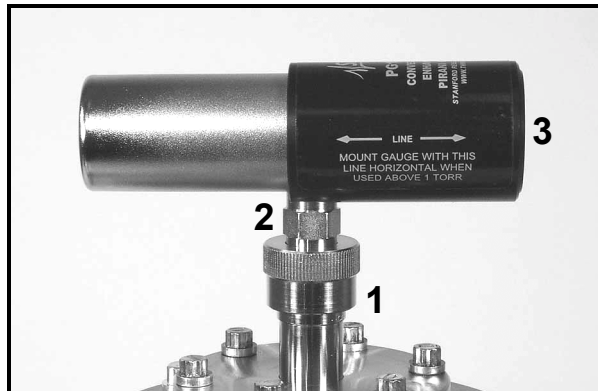

Figure 1-22. PG105 gauge mounted on a 1/2" compression fitting in the horizontal mounting orientation required for pressure readings above 1 Torr. 1. Ultra-Torr[®] fitting, 2. Side port tube (OD 1/2") with built-in nut, 3. PG105 Body.

1/8" NPT Fittings

The threads on the standard PG105 side port will fit a standard 1/8" NPT female fitting. Wrap the gauge threads with Teflon[®] tape and screw the gauge into the female fitting. Twist the gauge body by hand until the first sign of resistance is felt. *Do not use the body of the gauge as its own wrench past this point.* Instead, finish tightening with a wrench

(1/2" or 13 mm) applied to the nut built into the side tube until a proper seal is achieved. Do not overtighten as that might stress the tube port!

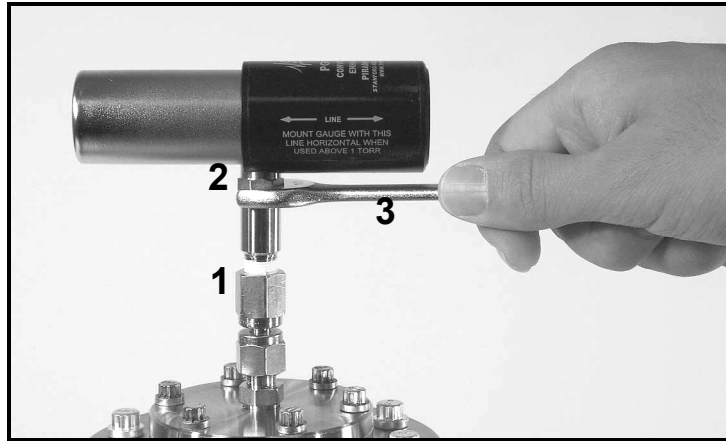

Figure 1-23. Proper installation of a PG105 gauge on a 1/8 NPT port. 1. Female 1/8 NPT Fitting, 2. built-in nut, 3. 1/2" (or 13 mm) wrench.

Other fittings

In addition to the standard tube, which provides a compression port and a 1/8" NPT male thread, a variety of other mounting options are available. They include: NW16KF, NW25KF, 1.33" and 2.75" ConFlat[®], Cajon[®] SS-4-VCR and SS-6-VCO, etc. Consult Stanford Research Systems for additional information on available fittings.

Connecting a Pirani Gauge

Once the gauges and the controller are installed and properly grounded, the next step involves the connection of the IGC100 controller to the Pirani gauge through the signal cable. This section describes the connection of up to two Pirani gauges to the IGC100 controller using the O105C4 dual-gauge signal cable, optionally available from Stanford Research Systems.

WARNINGS!

- Connect all gauge signal cables to the IGC100 controller first, *before* establishing a connection to the gauge heads.
- **DO NOT** switch the controller or gauge power on until instructed to do so.
- Cables, once installed, must be secured to provide strain relief for the gauge pins.
- **Do not use homemade connections in your vacuum system.** The use of homemade gauge signal cables (i.e. not purchased directly from Stanford Research Systems) automatically voids the IGC100's warranty and can lead to dangerous operating conditions and expensive equipment damage.

SRS Gauges

SRS has developed its own line of convection-enhanced Pirani Gauges - models PG105 and PG105-UHV. These gauges use RJ-45 connector receptacles. The connection instructions presented in this section are specific for those gauges. Consult Appendix H of this manual for detailed information on the principle of operation, installation and operation of PG105 and PG105-UHV gauges.

The standard IGC100 box has a DB-15 receptacle on its back panel for interfacing up to two Pirani gauges with the controller (PG1 and PG2 ports). Accordingly, the O105C4 signal cable has a DB-15 plug on one end that leads to two separate connection cables. Each cable is terminated in a colored-coded RJ-45 connector plug at the other end:

RED PG1 port
GREEN PG2 port.

Third-Party Gauges

IGC100 is also compatible with Series 317 (HPS/MKS) and Convectron® (Granville-Phillips) convection-enhanced Pirani gauges. However, connector adapters (SRS# O105CA2 and O105CA1, respectively) are required to electrically connect those third-party gauges to the RJ-45 ends of the O105C4 signal cable.

Connection to IGC100 Control Unit

Push the DB-15 plug of the O105C4 signal cable into the DB-15 receptacle (labeled PIRANI) on the back plane of the IGC100 controller. Securely fasten the connector in place with its two locking screws (a small flat head screwdriver will be required).

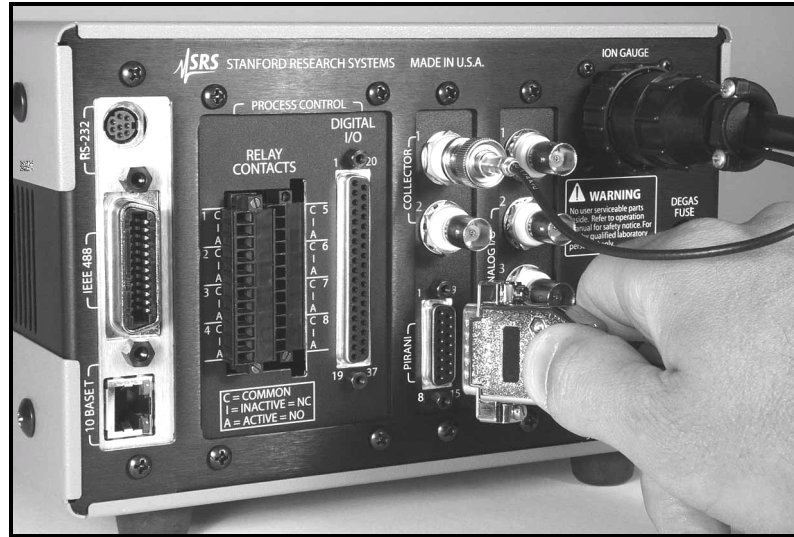

Figure 1-24. Pirani Gauge signal cable connection to the IGC100 controller: DB-15 plug connects to PIRANI receptacle.

Connection to Gauge Head(s)

PG1 Port (RED)

Push the RED RJ-45 connector into the matching receptacle located on the back-side of the detachable plastic connector of the first PG105 Pirani gauge.

Note

Data from the gauge connected to the red RJ-45 plug (PG1 port) is displayed on the PG1 Data Bar of the Pressure display window.

PG2 Port (GREEN)

For dual gauge operation, connect the GREEN RJ-45 connector into the second PG105 Pirani gauge.

Note

Data from the gauge connected to the green RJ-45 plug (PG2 port) is displayed on the PG2 Data Bar of the Pressure display window.

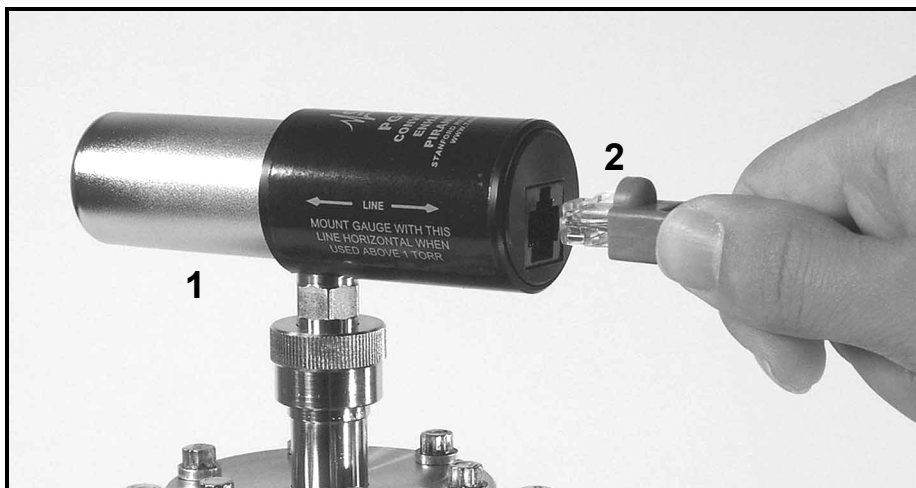

Figure 1-25. Pirani gauge signal cable connection to PG105 Pirani Gauge head.
1. PG105 Gauge, 2. RJ-45 connector (1 of 2) on O105C cable.

Installing a Capacitance Manometer

Read the entire **Safety and Preparation for Use** section of this manual before starting any installation procedure.

Capacitance manometers are also called Capacitance Diaphragm Gauges.

The IGC100 can display pressure as measured from standard capacitance manometers (CMs). Up to four independent CM readings can be monitored simultaneously using the four ANALOG I/O ports located on the back panel of the controller. The IGC100 also supplies auxiliary power (± 15 Vdc, 100 mA) sufficient to operate a pair of standard (i.e. non-heated) capacitance manometers. The IGC100 precisely measures the 0 to 10 Vdc linear output signal from the CM to determine pressure. Full-scale ranges up to 1000 Torr are supported by the controller.

CMs may be ordered from several commercial sources. The specifications of CMs should always be compared with the IGC100 specifications before a connection is established. Stanford Research Systems is not responsible for changes in design or specifications of third-party products that might render them incompatible with the IGC100 controller. Consult your gauge manufacturer for specific gauge installation requirements and Stanford Research Systems if uncertain about the compatibility of IGC100 with your third-party capacitance manometer.

It is generally recommended CMs be mounted with the inlet port pointing vertically downward. Although the gauge can be mounted in any orientation, mounting it as suggested allows any foreign matter entering the pressure port to fall away from the diaphragm. Isolate the unit from vibration as much as possible. While not susceptible to gas damping, the diaphragm may become susceptible to resonance. The low range transducers (≤ 1 Torr) are particularly sensitive and should be carefully isolated from any vibrations. Isolate the vibration through the cable as well as through the port.

WARNING!

Do not connect a capacitance manometer gauge to the IGC100 until instructed to do so later in this chapter.

Connecting a Capacitance Manometer

WARNINGS!

- Connect all gauge signal cables to the IGC100 controller first, *before* establishing a connection to the gauge heads.
- **DO NOT** switch the controller or gauge power on until instructed to do so.
- *The gauge chassis must be properly grounded* during operation to assure operator safety.
- Cables, once installed, must be secured to provide strain relief for the gauge pins.

This section describes the electrical connection of Capacitance Manometers (CM) to the IGC100 controller. Capacitance Manometers are also known as Capacitance Diaphragm Gauges. Up to four independent CM readings can be monitored, logged and displayed, simultaneously. Full-scale ranges up to 1000 Torr are supported by the controller software.

Unfortunately, there are a variety of conventions for connecting CMs. Consult your installation and operation manuals for gauge-specific information including connector type, pin assignments, electrical specifications, cable requirements and grounding recommendations.

In many cases, pin assignments are conveniently silk-screened on the gauge casing close to the electrical connector. *Be prepared to manufacture your own custom cables to interface CMs to the IGC100 controller.*

IMPORTANT!

General guidelines for the manufacturing of generic interface cables are often listed in the CM manual, or can be obtained directly from the gauge manufacturer.

Standard CMs require three basic connection steps:

- Grounding
- Pressure Signal Connection
- Power Connection

Grounding

The gauge chassis must be properly grounded during operation to assure operator safety. Most CMs feature a chassis grounding lug that must be directly connected to the facility ground by a #12 AWG copper wire. If necessary, use a ground lug on a flange bolt, or a metal hose clamp on the sensor port, to establish a dedicated connection to the facility ground.

IMPORTANT!

Consult the CM's manual for gauge specific grounding requirements.

Pressure Signal Connection

To read CM pressures, the Pressure Output Signal must be connected to one of the four ANALOG I/O ports - BNC connectors labeled '1' through '4' on the back panel. Identify the two pins assigned to the pressure output signal on the gauge's interface connector (typically labeled signal out (+) and signal common (-)). Construct a cable from these pins to a BNC connector, center pin connected to signal out (+) and outer shield connected to signal common (-). Other names for the signal pins are: PRESS OUT/OUTPUT RTN, Pressure Signal Output/Pressure Signal Output Return, SIGN OUT/SIGN COM, etc.

Power Connection

For convenience, the IGC100 also includes an auxiliary ± 15 Vdc (100 mA) CM Power connector (3-position terminal block) on its back panel. This output is usually sufficient for the simultaneous operation of a pair of standard gauges (i.e. non-heated, ± 15 Vdc, 35 mA typ.). Additional gauges or heated gauges will generally require help from an external source of power.

IMPORTANT!

Consult your CM manual or contact its manufacturer directly if you are uncertain about the power requirements of your gauges. Consult Stanford Research systems if uncertain about the compatibility of your CM(s) with the IGC100 controller.

Identify the three pins assigned to the ± 15 Vdc power connection (typically labeled -15 VDC, +15 VDC, and Power Return) and use three wires to connect the gauge to the auxiliary ± 15 VDC, 3-position, terminal block located on the back of the controller.



Figure 1-26. Capacitance Manometer Connection Ports.
1. Signal - Four ANALOG I/O BNC Ports. 2. Power - 3-position, terminal block.

Recommendation

Heated CMs often include additional pin connections assigned to heater status signals such as: 1. At Temperature Status/At Temperature Status Return pair and, 2. Heater Failure Status/ Heater Failure Status Return pair. In many cases these pin pairs act as semiconductor switches and their contact signals can be interfaced to the Process Control ports and used to trigger events in response to heater failure. This can be used to assure the reliability of your CM gauges at all times, and to protect delicate and expensive components sensitive to inaccurate pressure readings. Consult your gauge manual for availability of these options in your gauge heads.

Measuring Pressure

IGC100 Quick Setup

This section describes the setup steps required to prepare the IGC100 for accurate pressure measurements with ionization, Pirani and capacitance manometer gauges.

The steps in this section assume:

- The IGC100 box has been properly installed and grounded.
- Line power is connected to the controller (LINE LED on).
- The controller is turned off (POWER LED off)
- At least one gauge is connected to the controller, either an ionization gauge (IG1 port), a Pirani gauge (PG1 port) or a capacitance manometer (ANALOG I/O 1 = CM1 port).
- All pressure gauges are (1) mounted on the vacuum system, (2) properly grounded, (3) known to be compatible with the controller, and (4) safely connected to your IGC100 using Stanford Research System's cables (except for CMs).
- All ionization gauge(s) are exposed to a high vacuum environment with a known pressure $< 10^{-3}$ Torr, and the gas composition is either: air, nitrogen or residual gas (i.e. typical base pressure composition of a clean high vacuum system).
- You are reasonably familiar with the general theory of operation of hot-cathode ionization and convection-enhanced Pirani Gauges (consult Appendices A and H, respectively, if necessary).
- The Relay and Logic Process Control ports (if available) are not physically connected to any devices or in a safe MANUAL mode status.
- The Remote Control TTL inputs are not connected or disabled.
- Manual gauge operation - i.e. the controller is not under the control of an external computer via one of its interfaces (RS232, GPIB or web).

Power-On Procedure

Power-up the controller. Press the red POWER button located at the lower left corner of the front panel. The green POWER LED turns on, a brief Power-On Self-Test procedure is executed, and the Pressure Display Screen is displayed on the touch-screen LCD.

For all new units (i.e. straight out of the shipping box) the Pressure Display Screen, preset at the factory, includes: (1) three Data Bars, corresponding to gauges connected to the IG1, PG1 and PG2 ports (top to bottom), plus (2) [Menu], [Gauges], [Process], [Chart], and [Help] QuickKeys lined up along the bottom of the screen (left to right.)

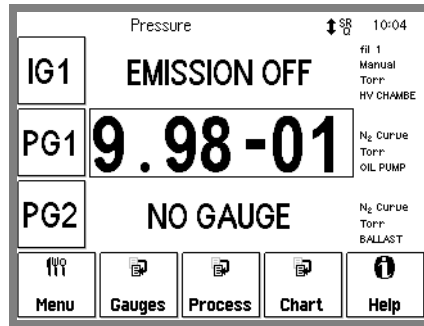

Figure 1-27. IGC100 Pressure Display Screen. IG, PG1 and PG2 Data Bars display pressures from gauges connected to the corresponding ports (Notice that no Pirani gauge is connected to the PG2 port and IG1 is off).

Reset

If your Pressure Display Screen does not appear like the one in Figure 1-27 at this point, it is possible to force the IGC100 to revert to its factory-preset settings by holding down the IG AUTO button during the Power-On procedure. However, keep in mind that this will also revert many other important settings of the instrument to factory default values (you might lose some important setup information). Holding down the IG AUTO Button should not be required for new instruments being powered right out of the shipping box.

As a factory default, all Pirani gauges connected to the controller become active during power-up and their pressures are displayed on the front panel. The PG1 and PG2 Data Bars display pressures from Pirani Gauges connected to the PG1 and PG2 ports, respectively. A "NO GAUGE" message (as displayed on the PG2 Data Bar of Figure 1-27) indicates that no gauge is physically connected (detected) at that port.

The IG1 Data Bar of your IGC100 should display an "EMISSION OFF" message at this time - the ionization gauge is not yet activated.

Gauge Setup Procedure

IGC100 is a generic instrument compatible with a large number of vacuum gauges. Individual setup information is required, and *must* be entered into the controller, for each new and/or replacement gauge connected to the: IG1, IG2, PG1, PG2, and CM1-4 interface ports.

IMPORTANT!

Setup of a new gauge requires knowledge of the gauge's operating parameters. Recommended parameters for third-party gauges are usually listed as part of the specifications provided by the gauge manufacturer. Contact the gauge manufacturer directly if specifications are not available.

IGC100 has a menu-driven user interface. All operating parameters are grouped into menus. Consult Chapter 3 of this manual for detailed menu information.

Help

Help for any menu button is available on screen by touching the [Help] QuickKey and then the menu button.

In order to enter new gauge setup parameters into the IGC100 controller, the user must follow the simple gauge setup procedure below. This procedure must be repeated for every new vacuum gauge connected to the controller.

Step 1

Starting from the Pressure Display Screen, touch the [Gauges] QuickKey to access the Gauge Display.

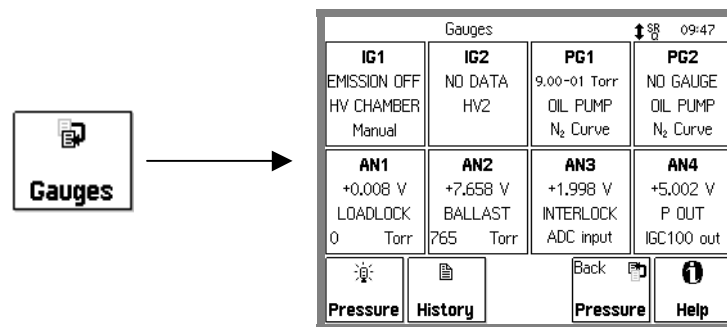

Fig 1-28. Gauge Display.

Step 2

Select a gauge port IG1, IG2, PG1, PG2, AN1-4 by touching its display button (Data Box). This brings up a Gauge Setup menu for the selected gauge port.

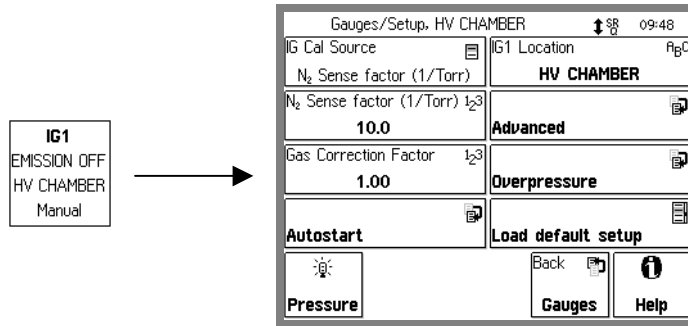

Figure 1-29. Gauge Data Box and Gauge Setup menu for the IG1 Port.

Step 3

Modify the gauge setup parameters for the selected port according to the gauge manufacturer's specifications. There are two basic approaches to this.

Setting Parameters Manually

Each gauge parameter can be modified individually (based on manufacturer's recommended values) through the menu-driven user interface. See 'Setting Gauge Parameters' below for details.

Loading a Default Setup

All gauge parameters can be updated simultaneously by recalling a Default Setup File compatible with the gauge (where available).

Default Setup Files are pre-loaded at the factory and are accessed by the [Load Default Setup] button (where available) in a Gauge Setup menu. The use of Default Setup Files minimizes the chances of errors and is highly recommended whenever available as an option.

Default Setup Files are pre-loaded for commercially available ionization gauges of standard design only.

Individual parameters may still be modified after loading a Default Setup File.

Step 4

Once finished modifying parameters, touch the [Pressure] QuickKey  to return to the original Pressure Display.

Setting Gauge Parameters

A different set of parameters must be considered for each type of gauge technology (i.e. ionization, Pirani or capacitance manometer) compatible with the IGC100 controller.

Uncalibrated Ionization Gauge (IG1, IG2)

The basic set of parameters that needs to be configured for any uncalibrated ionization gauge includes:

- IG Calibration Source (select N2 Sense Factor for uncalibrated gauges)
- N2 Sense Factor
- Gas Correction Factor
- Emission Current (Advanced submenu)
- Filament (Advanced submenu)
- Degas Power (Advanced submenu)
- Degas Time (Advanced submenu)
- Gauge Location
- Gauge Protection

These parameters depend on (1) gauge design (see Table 1-1) and (2) the type of gas being measured (Appendix D). The Gauge Location is an on-screen label to easily identify the position or function of the gauge in multiple gauge setups. The calculation of pressure from uncalibrated ionization gauges is based on their sensitivity factor (nominal or calibrated) - select N2 Sense Factor as the Calibration Source and enter the manufacturer recommended value for the N2 Sense Factor parameter before performing any measurements.

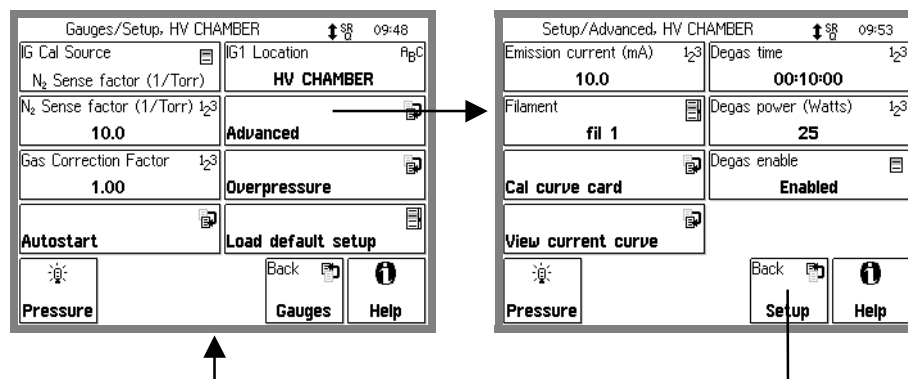

Figure 1-30. Touch [Advanced] to display the Advanced submenu, then [Back] to return.

Default Setup Files

Factory pre-loaded Default Setup Files are available for most commercially available Bayard-Alpert Ionization Gauge designs, including: Glass-Tubulated, Nude, Nude-UHV, Stabil-Ion[®], Stabil-Ion[®] -UHV and Micro-Ion[®] gauges.

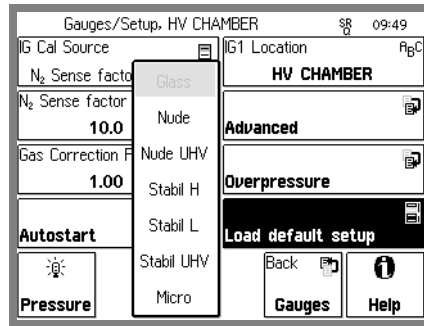

Figure 1-31. Default Setup Files for Ionization gauges. Touch the [Load Default Setup] button in the Gauge Setup menu to access the available choices.



Use Table 1-1 to select a file compatible with your ionization gauge(s). Consult Appendices B, C and M for additional details.

The parameter values used by the Default Setups in Table 1-1 are based on nominal specification numbers compiled from multiple commercial sources and known to be compatible with most modern Bayard-Alpert gauge designs. However, it is recommended to check your gauge manufacturer's specifications against the contents of the selected setup file to assure the safest and most accurate operation of your gauge(s). Consult your gauge manufacturer and Stanford Research Systems if unsure about the compatibility of IGC100 default setup files with your third-party ionization gauge products. Whenever available, replace the nominal sensitivity factor (N₂ Sense Factor) provided by the default setup file with the actual (known or calculated) sensitivity factor for your gauge. Fil2 and Both are only available as Filament options for gauges with dual filament electrode design. Use Appendix D of this manual to obtain gas correction factors for pressure readings from gases other than nitrogen.

For More Information

Detailed recommendations for the proper operation of hot-cathode ionization gauges, have been compiled and reported by the Vacuum Group of the National Institute of Standards and Technology (Maryland, USA): C. R. Tilford, A. R. Filipelli and P. J. Abbott, "Comments on the stability of Bayard-Alpert Ionization Gauges", J. Vac. Sci. Technol. A13(2) (1995) 485. Additional recommendations are also included in Appendix A.

For a very recent review of the state of ionization gauge technology, including essential practical information, consult J. H. Singleton, "Practical Guide to the use of Bayard-Alpert Ionization Gauges", J. Vac. Sci. Technol. A19(4) (2001) 1712.

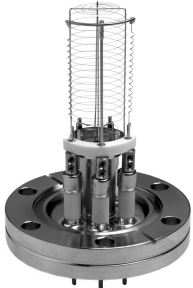
Table 1-1. Default Setup Files for Common Ionization Gauges							
Gauge Design	Setup File Name	N ₂ Sense Factor [1/Torr]	Emission Current [mA]	Degas Time (min)	Degas Power (Watts)	Over Pressure Threshold (Torr)	Gauge Protection
Glass-Tubulated 	GLASS	10	10	10	40	5×10^{-3}	Normal
Nude (Bi-filar helix anode grid) 	NUDE	10	10	10	40	5×10^{-3}	Normal
Nude-UHV (closed end anode grid) 	NUDE-UHV	25	4	10	25	2×10^{-4}	Normal
STABIL-ION[®]-H (1) (5×10^{-8} – 5×10^{-3} Torr) Use for $P > 10^{-4}$ Torr	STABIL-H	46	0.1	10	40	2×10^{-2}	Normal
STABIL-ION[®]-L (1) (2×10^{-10} – 5×10^{-4} Torr) Use for $P < 10^{-7}$ Torr	STABIL-L	42	4	10	40	1×10^{-3}	Normal
STABIL-ION[®]-UHV (2)	STABIL-UHV	21	4	10	25	10^{-4}	Normal
MICRO-ION[®] (3)	MICRO	20	0.02	2	3	5×10^{-2}	Micro-Ion

(1) Granville-Phillips Part# 360120 and 370120 (5×10^{-10} - 10^{-3} Torr). See Appendix C.

(2) Granville-Phillips Part# 370121 (5×10^{-11} - 2×10^{-5} Torr). See Appendix C.

(3) Granville-Phillips Part# 355001 (10^{-6} - 5×10^{-2} Torr). See Appendix M.

Calibrated Ionization Gauge (Memory Card)

Ionization gauges calibrated at the SRS High-Vacuum Calibration Facility, are the only gauges that do not require the Gauge Setup Procedure.

The IGC100 can store a single full-calibration curve for each ionization gauge port (IG1 and IG2) in its internal memory. Gauge-specific calibration data, including all relevant controller setup information, is stored at the factory in a memory card provided with the calibrated gauge. The calibration data is easily transferred into the controller through the MEMORY CARD interface of the front panel. Consult Chapter 6 of this manual for a step-by-step description of the procedure required to transfer gauge-specific calibration data from a memory card into the controller.

Once the calibration data is successfully loaded into the controller, choose Cal Curve as the IG Cal Source in the Gauge Setup menu, and the IGC100 will automatically be configured to match the setup conditions of the calibration data.

Important

The gauge setup parameters: (1) emission current, and (2) filament selection are fixed by the calibration data when Cal Curve is selected as the IG Cal Source. This is purposely done to assure the maximum accuracy of results obtained using Cal Curve data.

Pirani Gauge (PG1 and PG2)

Pirani gauges rarely require setup. The only setup parameters that might require adjustment include: (1) PG Calibration Curve (select between nitrogen and argon), (2) Power (on/off), (3) Gas correction factor, and (4) Gauge Location.

Calibration Curves

IGC100 is factory loaded with the required nitrogen and argon calibration curves required to convert Pirani Gauge signals into nitrogen-equivalent or argon-equivalent pressure readings. Use the PG Cal Curve parameter to select the appropriate calibration curve.

Power Off

Use the Power Off setting to cool down the Pirani gauge hot wire sensor while in the presence of explosive, flammable and combustible gases. There is no need to physically disconnect the gauge from the IGC100 during exposures to dangerous gases.

Gas Correction

Gas Correction factors (valid for pressure measurements below 1 Torr) are available in Appendix I of this manual to convert nitrogen-equivalent pressure readings to direct pressure readings for other gases.

Gauge Label

The Gauge Location label is very convenient and its use is highly recommended in multi-gauge setups. IGC100 allows you to assign a location name to each gauge port. Gauge locations are displayed next to their pressure readings. Use the Gauge Location to differentiate between identical gauges in a dual Pirani gauge setup.

Capacitance Manometer (CM1-4)

Configure an Analog Port

All Analog I/O ports are configured as inputs as a factory default. Configure an Analog port (AN1-4 corresponding to the 4 BNCs on the back) to read a capacitance manometer by touching the appropriate display button in the Gauges Display. This brings up the Analog I/O port setup menu. The I/O Mode should be set to Input (A/D) and the Input Signal should be set to CM Press Out. The two setup parameters that need to be adjusted for Capacitance manometers are:

Pmax

Pmax is the full scale range of the capacitance manometer (i.e. the pressure at which its pressure output signal =10 Vdc). Its value is usually indicated on the outer casing of the gauge head. The full scale ranges most commonly encountered in commercial capacitance manometers are: 50 and 100 mTorr, and 1, 2, 10, 100 and 1000 Torr. Consult your gauge manufacturer(s) directly if unsure about your gauge's full-scale range.

Gauge Location

The Gauge Location label is very convenient and its use is highly recommended in multi-gauge setups. IGC100 allows you to assign a location name for each gauge port. Gauge locations are displayed next to their pressure readings. Use the Gauge Location to differentiate between identical gauges in a multiple gauge setup.

Pressure Measurement

This section describes the steps required to measure and display pressures from ionization, Pirani and capacitance manometer gauges connected to the IGC100. This is the final step of the installation procedure.

It is assumed that at least one gauge – ionization (IG1), Pirani (PG1) or capacitance manometer (CM1) - is connected to the back ports, and that the controller has been completely configured, using the instructions of the previous section. Only manual operation of the gauges is discussed.

Readings may be displayed in various formats, in several different units and are continuously updated. When logging is enabled, data from all the gauges and analog inputs are stored in an internal data log at a user-programmable rate. The data log can be displayed in either table or chart (P vs. time) formats.

Warm-up times

The accuracy specifications of the IGC100 apply when the unit has warmed up for at least 1.5 hours and assume single filament operation (Fil1 **or** Fil2) of ionization gauges and signal cable lengths shorter than 50 ft. Longer warm-up times might be required by some capacitance manometers and even third-party Pirani gauges. Consult your gauge specifications and/or contact the gauge manufacturers for additional details.

To minimize temperature-induced drift in ionization gauge pressure readings, warm-up times must include operation of the filament at the selected emission current. Simultaneous operation of both filaments at high emission current settings in dual filament gauges can cause additional heating and may, in some cases, push the IGC100 slightly beyond its published accuracy specifications. This effect is aggravated by long signal cables, old filaments, the use of tungsten as filament material and operation at high pressures.

Recommendation

The accuracy specifications of the IGC100 should be relaxed by a factor of two for dual filament operation.

Ionization Gauge (IG1)

WARNING!

- Do not operate ionization gauges in the presence of explosive, flammable or combustible gases.
- Do not operate the ionization gauge at pressures $>10^{-3}$ Torr since that will significantly affect the filament's lifetime.

In order to perform pressure measurements with an ionization gauge, its filament must first be turned on. For manual operation, press the IG1 power button located on the front panel of the controller. The green IG1 LED to the right of the IG1 button lights up to

indicate the presence of electron emission. *The filament current ramps up over a few seconds* minimizing pressure bursts in the vacuum system and emission current overshoot in the gauge head. As soon as full emission current is established, the pressure in the ionization gauge head is displayed on the IG1 Data Bar of the Pressure Display Screen. Press the IG1 power button again to turn the emission off – "EMISSION OFF" is displayed in the IG1 Data Bar.

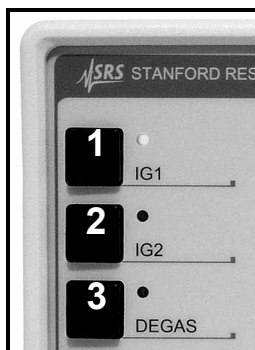

Figure 1-32. Front panel Ionization Gauge controls. 1. IG1 power button and emission LED, 2. IG2 power button and emission LED, 3. Degas button and LED

The amount of time required to establish full emission current in a gauge head depends on the emission current setting. As a rule-of-thumb, the larger the emission current, the shorter the turn on time. It is not unusual to experience turn on times of a few seconds at emission current settings <0.1 mA. This is considered normal and is designed to prevent large emission current overshoots that could overheat the gauge head damaging sensitive components inside the vacuum system. Turn on times are on the order of 1 second for emission current settings >1 mA.

A "WAIT" message is displayed in the IG1 Data Bar while electron emission current is being established, and all pressure readings are ignored until full (and stable) emission current is established. No process control action is performed based on ionization gauge readings during the time the emission current is established.

Dual Gauge Operation

If the dual ionization gauge option (SRS# O100IG) is installed, use the IG2 power button to turn on the second ionization gauge. *Only one gauge can be on at any time.* See Appendix L for more information.

Degassing an Ionization Gauge

WARNING!

- Degassing is not gentle on thoriated/iridium filaments. Experiment with Degas Time settings until you reach a good compromise between Degas Power and Degas Time. As a rule of thumb, choose the longest time you can wait and the minimum amount of power (under the manufacturer's maximum specification) that will be compatible with your contamination tolerance. Maximum recommended degas powers for common gauge designs are listed in Table 1-1 of this chapter.

- Set the Degas Power and Time in the Advanced Gauge Setup described in the previous section.
- No process control action is performed based on ionization gauge readings while degassing takes place.

IMPORTANT!

To degas IG1 (or IG2), *the gauge must be on and the pressure must be under 2×10^{-5} Torr, and Degas Enable (in the Advanced Gauge Setup) must be set to Enabled.*

Press the DEGAS button on the front panel to degas the active ionization gauge. The red DEGAS LED next to the button turns on and an approximate indication of pressure and remaining degas time are displayed. Degassing may be stopped at any time by simply pressing the DEGAS button again. Observing the pressure indication rise, peak and then fall, is an excellent means of determining the optimum Degas Time. A setting of 10 minutes is adequate for most applications and should not be extended unless proven to be insufficient.

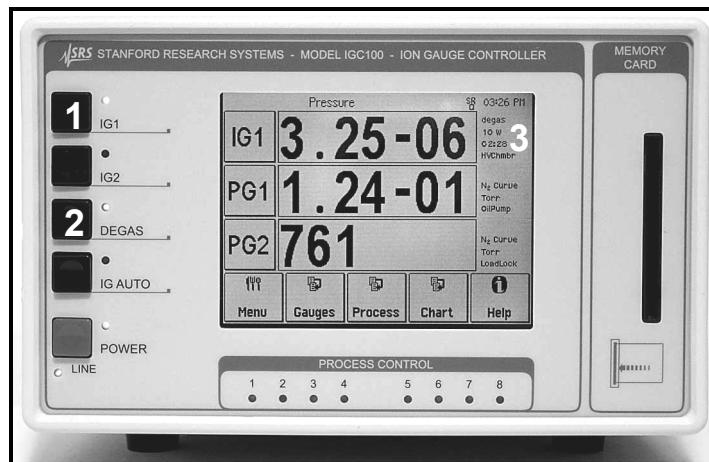

Figure 1-33. Front panel with Ionization Gauge 1 (IG1) degassing. 1. IG1 power switch with Emission LED on, 2. DEGAS Power Switch with DEGAS LED on, 3. Pressure Display Screen with approximate pressure and remaining degas time displayed.

The IGC100 employs electron bombardment degassing which is considered the most efficient means to remove contaminants from the gauge electrodes. During degassing, high energy electrons (500 eV) strike and heat the anode grid structure, removing impurities, while an increased filament temperature outgasses the filament surface. To complete the cleaning cycle, it is necessary to actively pump the outgassed molecules out of the gauge head. This requires pressures $< 10^{-5}$ Torr for the removal process to be effective.

Degassing cannot be activated in the IGC100 unless (1) the ionization gauge is turned on and (2) the pressure is below the 2×10^{-5} Torr threshold. Degassing above this pressure threshold is inefficient and very damaging to the filament(s), and may cause pressure bursts that can strike an electrical gas discharge capable of coupling dangerous high

voltages to the vacuum chamber wall. This creates an electrical-shock hazard if the system is not properly grounded.

An approximate indication of pressure within the ionization gauge head is available during degassing. Observing the pressure indication rise, peak out and then fall (see Trend Graph later in this chapter) is an excellent way to determine ideal degassing parameters such as Degas Time and Power. The Degas Power and the remaining Degas Time are displayed in the gauge's Port Info Box of the Pressure Display Screen (Fig. 1-33).

In order to remove pressure bursts and allow efficient removal of impurities, the degas power is ramped up slowly (i.e. 1W/sec) at the beginning of a degas cycle. For convenience and improved safety, degas power is carefully regulated throughout the entire degas process to prevent excessive pressure rise and reduce the possibility of striking a gas discharge. The degas power is immediately reduced if the pressure rises above the 2×10^{-5} Torr pressure threshold, and degas is aborted entirely if the pressure exceeds 5×10^{-5} Torr at any time. As a result of this power limitation feature, it is not unusual to see the Degas Power and pressure indications fluctuate significantly while degassing at pressures close to the 2×10^{-5} Torr threshold.

Recommendations

As a rule of thumb, pressure measurements below 10^{-8} Torr, require one degassing in the 10^{-6} Torr range followed by one more at or around the base pressure.

Degassing changes the surface conditions inside the gauge head. Allow sufficient time for new steady state conditions to be established before attempting to make accurate measurements.

If the pressure in the gauge is above the 2×10^{-5} Torr threshold, perform a bakeout of the ionization gauge applying an external heat source, to reduce the outgassing levels.

The recommendation from the NIST High Vacuum Group is to eliminate degassing by high temperature heating of the grid (whether resistive or electron bombardment). For baked systems, their observation is that gauges can be effectively outgassed by simply operating them at normal emission currents while the BAG and vacuum system are baked. For unbaked systems, the gauge can be baked and outgassed by thermally insulating it with fiberglass. Degassing by electron bombardment is only recommended if (1) the gauge is heavily contaminated or (2) after exposure to surface active gases such as O_2 . Whenever possible minimize the emission current during degas and extend the degas time to compensate. For additional recommendations on the operation of ionization gauges, consult C. R. Tilford, A. R. Filipelli and P. J. Abbott, "Comments on the stability of B-A ionization gauges", J. Vac. Sci. Technol. A13(2) (1995) 485. See comments on second column of p. 486.

Degassing MICRO-ION[®] Gauges

Consult Appendix M for degassing information specific to MICRO-ION[®] gauges.

Pirani Gauge

By factory default, all Pirani gauges connected to IGC100 are automatically activated during power-up and their pressures are displayed on the front panel. *Pirani Gauge Power is On as the factory default.* The PG1 and PG2 Data Bars display pressures from Pirani Gauges connected to the PG1 and PG2 ports, respectively. A "NO GAUGE" message indicates that no gauge is detected by the controller on that port.

Use the Gauge Setup menu to turn Pirani gauge power on and off.

Capacitance Manometer

Displaying pressure readings from a capacitance manometer connected to an Analog I/O port requires assigning one of the Data Bars on the Pressure Display screen to the gauge's connection port (i.e. CM1 for a gauge connected to ANALOG I/O 1 port, and so on).

Each Data Bar consists of three boxes: Port ID (left), Port Data (center) and Port Info (right). Customize a Data Bar by touching the Port ID or the Port Data boxes.



Figure 1-34. Data Bar: Port ID (left), Data Bar (center), and Info (right).

The Port ID box shows the source of the readings for the data bar, IG, PG1, PG2, CM1-4 or AN1-4. For example, the Data Bar in Fig. 1-34 displays pressure readings from the Pirani gauge connected to the PG1 port. Touch the Port ID box to select a different source (any gauge or analog input port) for that Data Bar. In the case of a capacitance manometer, identify the Analog I/O port (1-4) connection and choose the appropriate CM port (CM1-4). For example, choose CM1 for a capacitance manometer connected to the Analog I/O 1 port.

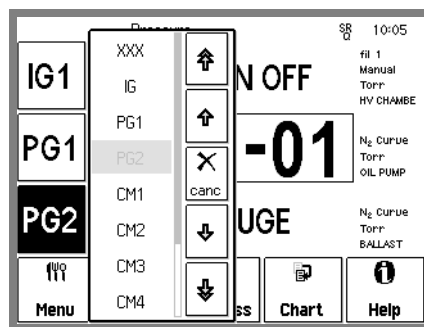

Figure 1-35. Select CM1 for the lower Data Bar.

Pressure Output Signal Display

It is also possible to display the pressure output signal (0-10 Vdc) of a capacitance manometer. Touch the Port ID box of the CM1-4 Data Bar and choose the appropriate

AN1-4 port as the Data Bar source. For example: choose AN1 for the CM1 capacitance manometer (CM connected to analog I/O 1 port). The Pressure Output signal is displayed in the Data Bar in units of Volts. This capability is very useful while debugging the proper connection and operation of a gauge and while calibrating capacitance manometer gauges.

Note

The analog and pressure output display will show 'OVERLOAD' if the Pressure Output signal exceeds 12 V.

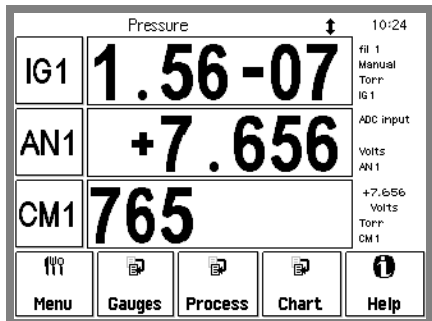



Figure 1-36. IGC100 displaying pressures from: IG1, AN1 and the CM pressure output signal at Analog I/O 1 port.

Pressure Display Formats

Use the [Pressure] QuickKey  to bring up the IGC100 Pressure Display at any time.

Pressure Units

The factory default for pressure units is Torr (1 Torr = 1 mm Hg).

Use the [Menu] QuickKey  to display the Main menu. Touch [Units] to choose a different units system: Torr, micron, mbar, bar, or Pascal.

Consult Appendix K for conversion factors between the different pressure units supported by IGC100.

Display Types

The Pressure Display has three Data Bars, each displaying a pressure (or analog input). Readings may be displayed in various formats and are updated twice a second.

Each Data Bar consists of three boxes (See Fig. 1-34): Port ID (left), Data (center) and Info (right). Customize a Data Bar by touching the Port ID or the Port Data boxes.

The Port Data area of the Data Bar is where the readings are displayed. Touch inside the Port Data box to choose a display format. Five (5) options are available:

Big Numbers

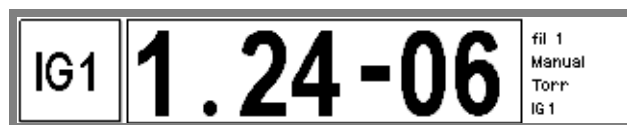

Figure 1-37. Big Numbers data display.

Best display for accurate, easy to view, pressure readings. Easily visible across the room.

Trend Graph



Figure 1-38. Trend Graph display.

Best display for trend analysis. A stamp-sized 'P vs. time' plot of the most recent 10 readings, sampled at the data logging interval (see 'Logging' below). It also includes a small instantaneous reading next to the plot. Use trend graphs to see pressure changes in time-dependent processes such as leak testing, pump downs, venting, bakeout, etc.

Auto Scaling Bar Graph



Figure 1-39. Auto Scaling Bar graph.

Best display to detect instantaneous changes in pressure readings. Three decade logarithmic bargraph display scaled about the current reading. Often used during leak testing procedures. This display preserves the 'feel' of the old analog needle displays preferred by some vacuum users.

Full Range Bar Graph



Figure 1-40. Full Range Bar Graph display.

Best display to view the overall status of your vacuum system at any given time. Fifteen decade logarithmic bargraph display, covering the entire useful range of the instrument (10^{-12} to 10^3 Torr). The scale covers the entire range from UHV to atmosphere. For example, use the length of the bargraph of a Pirani Gauge measurement to quickly determine whether the system is pumped down or at atmosphere, without having to read actual pressure values.

Status Information

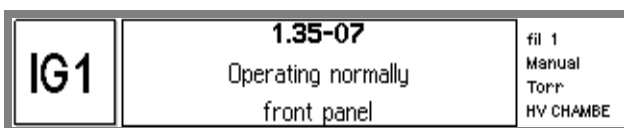

Figure 1-41. Status Information display.

Use this display to learn more about the state of a gauge. This is especially useful if the gauge is in a fault or error condition.

The lowest line in this display shows who last modified the status of the gauge (front panel user, remote user, etc.).

Logging

When Logging is enabled (factory default), data from all gauges and analog inputs are stored in a circular data buffer at a rate specified by a user adjustable Logging Interval.

The logged data for the three ports selected in the Pressure Display screen can be viewed at any time in the Data Log Display in either table or chart format. This allows users to switch readily between instantaneous and logged readings for the gauges of interest.

In order to access the Data Log display, follow these simple steps:

Step 1

Bring up the Pressure Display by touching the [Pressure] QuickKey .

Step 2

Touch the [Chart] or [Table] QuickKey to display the log in Chart/Table format.

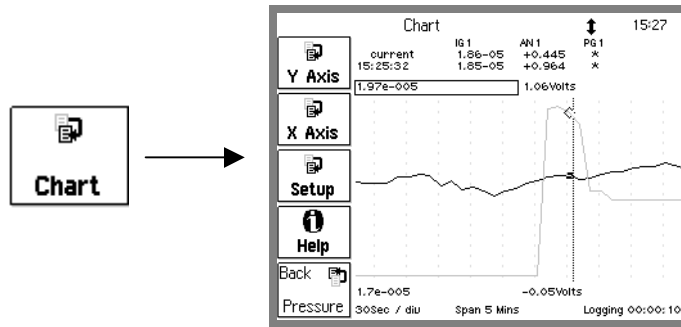

Figure 1-42. Press [Chart] to display the chart of the data log.

Step 3

Touch the [Setup] button to access the Logging Setup menu.

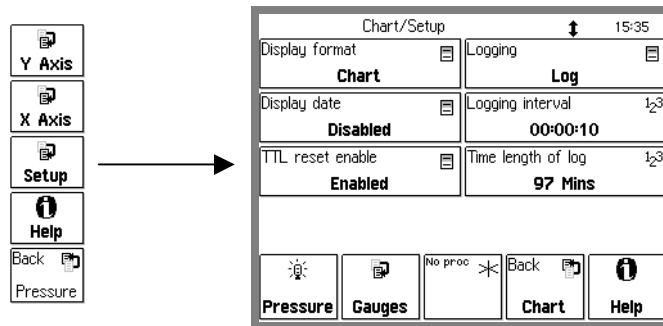

Figure 1-43. Logging Setup menu. Choose between Chart and Table display formats or adjust Logging Parameters.

Step 4

Select Table or Chart display format. Activate Logging or change the Logging Interval as required using the menu.

IG Auto-Start mode (IG AUTO)

The common combination of one ionization gauge and two Pirani gauges, standard in all IGC100 controllers, allows you to monitor system pressures between atmosphere and UHV without any blind spots.

If one of the Pirani gauges is exposed to the same gas environment as the ionization gauge, the IG AUTO mode automatically turns the ionization gauge ON when the Pirani pressure readings drop below a user programmed threshold. IG AUTO continues to protect the filament during subsequent operation. The ionization gauge will be turned OFF if the Pirani pressure rises above 1.2 times the threshold. For example, if the threshold is 1.0×10^{-3} Torr, the ion gauge turns on at 1.0×10^{-3} and shuts off if the pressure ever rises back above 1.2×10^{-3} Torr.

Auto-Start is used to provide complete unattended system control, and protect the ionization gauge filaments, during system pumpdowns and ventings. Auto-Start can also be activated remotely, through the computer interface.

The Auto-Start threshold and gauges are selected in the Gauge Setup menu of each ionization gauge. From the Gauge Setup menu, touch [Autostart] to display the Auto-Start setup menu.

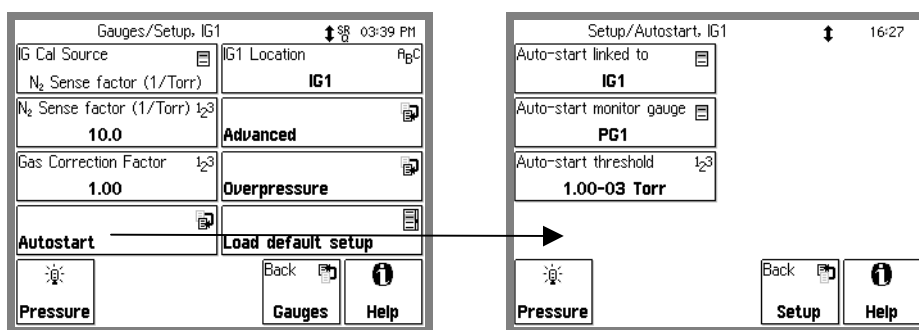

Figure 1-44. Touch [Autostart] in the Gauge Setup menu to display the Autostart Setup menu. Choose the Pirani Gauge, Ion Gauge and Threshold for Autostart operation BEFORE turning IG Auto on.

Choose which Pirani gauge is monitoring the Ion Gauge pressure and the safe pressure threshold for the Ion Gauge. In dual ionization gauge systems (with option O100IG) the Auto-Start function may be linked to either ionization gauge port. The user specifies the ionization gauge (IG1 or IG2) which will auto-start. Since the IGC100 only operates one ion gauge at a time, IG2 is automatically turned off if IG1 is put in Auto-Start (and vice-versa).

Auto-Start is activated/deactivated manually by pressing the IG AUTO button of the IG Control Keypad on the front panel. Pressing either IG1 or IG2 will deactivate IG AUTO operation.

RS232 Serial Cable Connection

The IGC100 is a stand-alone instrument - there is no need to connect the controller to an external computer for normal operation. However, a serial RS232 connection to a computer will be required for:

- External software control of the IGC100 and vacuum system (also available via optional GPIB or web interfaces).
- Download of firmware updates into the controller.
- Transfer of logged history and data into a PC for off-line analysis.
- Download of calibration data into the controller (also available via optional GPIB interface).

The IGC100 is delivered with a DIN8-DB9 Adapter cable for serial RS-232 communication with a PC. Connect the DIN8 (circular connector) end of the cable to the back of the IGC100 controller at this time.

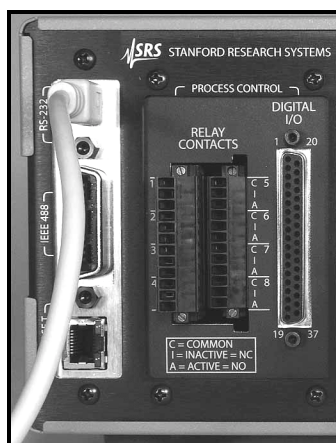

Figure 1-45. DIN8-DB9 Connector Adapter Cable, connected to the back of the IGC100 controller.

The DB-9 connector end of the cable provides a standard connection to serial connectors available in most PC computers. Use a DB-9 to DB-25 adapter if necessary.

Note

Attaching the cable to the controller at this time minimizes the chances of misplacing the cable in your lab, and not being able to find it when you really need it.

Proper Grounding Test Procedure

Read the entire **Safety and Preparation for Use** section of this manual before starting any installation procedure.

WARNING!

- Safe operation of any high-voltage, ion-producing vacuum equipment, including the IGC100, requires proper grounding of its electronics control unit and vacuum chamber. **LETHAL VOLTAGES** may be established under certain operating conditions if proper grounding is not assured.
- **This risk is not specific to the IGC100!**

As a rule-of-thumb, *all parts of a vacuum system* utilized with the IGC100, or any similar high voltage product, *must be maintained at earth-ground for safe operation.*

- **The vacuum chamber should be directly, and explicitly, connected to a heavy-duty earth-ground** (minimum 12 AWG ground lead wire).
- All electronic instrumentation must be connected to properly grounded 3-prong electrical outlets. **A chassis grounding lug must also be directly tied to an earth-ground electrode** (minimum 12 AWG wire). *Do not connect the controller's ground lug to the vacuum system or another component.* Connecting the power cord to a properly grounded outlet is a necessary, but not sufficient grounding condition with this (or any similar) high voltage producing vacuum equipment.
- **All conductors** in, on, or around the vacuum system that are exposed to potential high voltage electrical discharges **must either be shielded** at all times to protect personnel **or be permanently connected to the facility's earth-ground**. Consult an experienced electrician if necessary!!!
- High-voltage ion-producing equipment such as a hot-cathode ionization gauge can, under certain circumstances, provide sufficient electrical conduction via a plasma to couple a high-voltage potential to the vacuum chamber walls. *Any exposed conductive parts of a gauge or vacuum chamber may attain high voltage potentials through this process if not properly grounded.* Grounding the IGC100 does not and cannot guarantee that other components of the vacuum system are all maintained at earth ground.

Perform regular electrical ground-tests on your entire vacuum system, particularly if it is shared by multiple users who often perform custom modifications on the chamber's configuration.

Ground Test Procedure:

Step 1

Carefully examine your vacuum system:

- ❑ Are all exposed connectors and conductors on the vacuum chamber grounded?
- ❑ Are all ground connections properly connected to a solid earth or facility ground?
- ❑ Beware! Some vacuum systems rely on water piping for the earth-ground connection. Proper ground connection can be easily lost by inadvertently inserting a plastic interconnect into the water line.
- ❑ Keep in mind that the use of O-ring seals without metal clamps or bolt connection can isolate big portions of a vacuum system from its safety ground. Add metal clamps if necessary.
- ❑ Verify that the vacuum port to which any new component is about to be mounted is electrically grounded. Use a ground lug on a flange bolt if necessary.

Step 2

With the IGC100 controller turned off (but still plugged into an outlet):

- ❑ Test for both AC and DC voltages between the metal parts of the vacuum system and the controller's chassis. No voltage differences should be detected.
- ❑ If no voltages are detected, measure resistance between all parts of the vacuum system, and between the vacuum system and the controller: <2 Ohms assures a commonality of grounds between the different parts of the vacuum setup and prevents the development of high voltages between different sections of the vacuum setup in the presence of a high voltage plasma discharge.
- ❑ If AC or DC voltages exist or more than 2 ohms is detected, professional help is recommended.