

Tektronix

492 & 492P
Spectrum Analyzers
Operator Manual

070-2726-03

TABLE OF CONTENTS

	Page		Page
LIST OF ILLUSTRATIONS	iii	Section 2	INSTALLATION AND REPACKAGING
LIST OF TABLES	iv		INTRODUCTION
OPERATOR'S SAFETY SUMMARY	v		2-1
SERVICE SAFETY SUMMARY	vii		UNPACKING AND INITIAL INSPECTION
			2-1
Section 1	GENERAL INFORMATION AND SPECIFICATION		PREPARATION FOR USE
	GENERAL INFORMATION		2-1
	INTRODUCTION		POWER SOURCE AND POWER REQUIREMENTS
	DOCUMENTS STANDARDS, AND REFERENCES USED		2-1
	CHANGE AND HISTORY INFORMATION		REPACKAGING FOR SHIPMENT
	PRODUCT DESCRIPTION		2-2
	SPECIFICATION	Section 3	OPERATION
	ELECTRICAL CHARACTERISTICS		CONTROLS, INDICATORS, AND CONNECTORS
	Frequency Related		3-1
	Amplitude Related		FIRMWARE VERSION AND ERROR MESSAGE READOUT
	Input Signal Characteristics		3-7
	Output Signal Characteristics		TURN-ON PROCEDURE AND PREPARATION FOR USE
	General Characteristics		3-8
	Power Requirements		1. Initial Turn On
	ENVIRONMENTAL CHARACTERISTICS		3-8
	PHYSICAL CHARACTERISTICS		2. Calibrate Center Frequency Readout
	ACCESSORIES		3-9
	OPTIONS		3. Calibrate Reference Level and Dynamic Range
	Option 01		3-9
	Option 02		4. Check Span Accuracy and Linearity
	Option 03		3-9
	Option 08		FUNCTIONAL OR OPERATIONAL CHECK
	Option 11		3-10
	Option 20		Equipment Required
	Option 21		3-10
	Option 22		Preliminary Preparation
	Option 30		3-10
	Option 31		1. Check Operation of Front Panel Pushbuttons and Controls
	Option 32		3-10
	Option 41		2. Check Frequency Readout Accuracy
	Option 42		3-13
	Options for Power Cord Configuration		3. Check Frequency Span/Div Range and Accuracy
			3-13
			4. Check Resolution Bandwidth and Shape Factor
			3-14
			5. Check Reference Level Gain and RF Attenuator Steps
			3-14
			6. Check Sensitivity
			3-15

TABLE OF CONTENTS (cont)

Section 3	OPERATION (cont)	Page	Section 3	OPERATION (cont)	Page
	7. Check Frequency Drift or Stability	3-16		492P GPIB CONTROLS, INDICATORS, and CONNECTORS .	3-34
	8. Check Residual FM	3-17		RESET TO LOCAL (REMOTE)	3-34
	9. Digital Storage (Option 02) . .	3-18		ADDRESSED	3-34
	10. 492P GPIB Verification Program	3-19		GPIB Function Readout	3-35
	GENERAL OPERATING INFORMATION	3-26		Setting the GPIB ADDRESS Switches	3-35
	Firmware Version and Error Message Readout	3-26		492P TALK/LISTEN ONLY OPERATION	3-36
	Crt Light Filters	3-26		TALK ONLY, LISTEN ONLY Switches	3-36
	Intensity Level, Focus, and Beam Alignment	3-26		Data Logging	3-37
	Signal Application	3-26		Restoring Control Settings and the Display	3-39
	RF INPUT Connector	3-26		CONNECTING TO A SYSTEM	3-39
	Amplitude Conversion	3-26		OPERATIONAL PRECAUTIONS	3-39
	Connecting to 75 Ω Source	3-26		1. Measurements Outside the Specified Frequency and Tuning Range Versus Span of the Display	3-39
	Resolution Bandwidth, Frequency Span, and Sweep Time	3-27		2. Signal FM	3-39
	Using the PEAKING Control	3-28		3. Correct Trigger Mode	3-39
	Phase Lock Operation	3-28		4. Level of Pulsed Signals	3-40
	Using the Signal Identifier	3-28		5. Level of Continuous Wave Signals	3-40
	Using the Video Filters	3-28		6. Excessive Input Signal Level	3-40
	Time Domain Operation	3-29		7. No Crt Trace	3-40
	Triggering the Display	3-29		8. Digital Storage Effects on Signal Analyses	3-40
	Sweeping the Display	3-29		9. Stored Display Averaged in Wide Spans	3-40
	Manual Scan of the Spectrum	3-29		10. Cold Storage or Power Interrupt initialization	3-40
	Reference Level, RF Attenuation, and Vertical Display	3-30		SERVICE MANUAL	3-41
	Delta A Mode	3-30		PRODUCT SERVICE	3-41
	MIN NOISE/MIN DISTORTION . .	3-30		Emergency Repair	3-41
	Digital Storage (Option 02)	3-31		Maintenance Agreements	3-41
	WAVEGUIDE MIXERS AND EXTERNAL DIPLEXER	3-31		Section 4 OPTION INFORMATION	4-1
	Introduction	3-31		Appendix A GLOSSARY	A-1
	Reference Level Readout for Waveguide Mixers	3-32		CHANGE INFORMATION	
	Handling	3-32			
	Installation	3-32			
	Operation	3-33			
	Analyzing Signals	3-33			

LIST OF ILLUSTRATIONS

Fig. No.		Page No.
	492/492P Spectrum Analyzer	viii
1-1	Probe Power Connector	1-10
1-2	Dimensions	1-12
1-3	International power cord and plug configuration for the 492/492P	1-22
3-1	Front panel selectors, controls, and connectors ..	3-1
3-2	Rear panel connectors	3-7
3-3	Crt readout for power-up state	3-8
3-4	Typical display of calibrator markers in MAX SPAN position	3-8
3-5	Displays that illustrate how bandwidth and shape factor are determined	3-14
3-6	Typical display using digital storage with MAX HOLD activated, to measure drift ...	3-17
3-7	Display to illustrate how residual FM is measured	3-18
3-8	Using digital storage to measure the differential between two events	3-18
3-9	Volts-dBm-Watts conversion chart for 50 Ω impedance	3-27
3-10	Circuit of a 75 Ω to 50 Ω matching pad (ac coupled)	3-27
3-11	Graph to illustrate the relationship between dBm, dBmV, and dB μ V (matching attenuator included where necessary)	3-28
3-12	Integrating the display with the Video Filter	3-29
3-13	External (Waveguide) mixer installation ...	3-32
3-14	Typical display generated by a signal into the waveguide mixer	3-33
3-15	Identifier mode displays	3-33
3-16	GPIB control and indicators on the front panel	3-34
3-17	Status of GPIB functions indicated when active	3-35
3-18	The 492P GPIB Port and Switches	3-36
3-19	GPIB Address switches on the rear panel .	3-36
3-20	The TEKTRONIX 4924 Digital Cartridge Tape Drive in a talk/listen-only system	3-37
3-21	Controls on the 4924 and 492P used for talk/listen-only data transfers	3-38

LIST OF TABLES

Table No.		Page
1-1	Electrical Characteristics	1-2
1-2	Environmental Characteristics	1-10
1-3	Physical Characteristics	1-11
1-4	Accessories	1-13
1-5	Option 01 Electrical Characteristics	1-14
1-6	Option 03 Electrical Characteristics	1-17
1-7	Option 20 Electrical Characteristics	1-18
1-8	Option 21 Electrical Characteristics	1-19
1-9	Option 22 Electrical Characteristics	1-19
1-10	Environmental Characteristics for Rackmount/Benchtop Versions	1-20
1-11	Physical Characteristics for Rackmount/Benchtop Versions	1-21
1-12	Option 41 Specification	1-22
1-13	Option 42 Electrical Characteristics	1-22
2-1	Shipping Carton Test Strength	2-2
3-1	Span/Div Ranges versus Band and Option	3-3
3-2	Narrow and Wide Spans versus Frequency Band	3-12
3-3	Sensitivity without Preselector	3-15
3-4	492/492P Option 01 Sensitivity	3-16

OPERATORS SAFETY SUMMARY

The general safety information in this part of the summary is for both operating and servicing personnel. Specific warnings and cautions will be found throughout the manual where they apply, but may not appear in this summary.

TERMS

In This Manual

CAUTION statements identify conditions or practices that could result in damage to the equipment or other property.

WARNING statements identify conditions or practices that could result in personal injury or loss of life.

As Marked on Equipment

CAUTION indicates a personal injury hazard not immediately accessible as one reads the marking, or a hazard to property including the equipment itself.

DANGER indicates a personal injury hazard immediately accessible as one reads the marking.

SYMBOLS

In This Manual



This symbol indicates where applicable cautionary or other information is to be found.

As Marked on Equipment



DANGER — High voltage.



Protective ground (earth) terminal.



ATTENTION — refer to manual.

Power Source

This product is intended to operate from a power source that will not apply more than 250 volts rms between the supply conductors or between either supply conductor and ground. A protective ground connection by way of the

grounding conductor in the power cord is essential for safe operation.

Grounding the Product

This product is grounded through the grounding conductor of the power cord. To avoid electrical shock, plug the power cord into a properly wired receptacle before connecting to the product input or output terminals. A protective ground connection by way of the grounding conductor in the power cord is essential for safe operation.

Danger From Loss of Ground

Upon loss of the protective-ground connection, all accessible conductive parts (including knobs and controls that may appear to be insulating) can render an electric shock.

Use the Proper Power Cord

Use only the power cord and connector specified for your product.

Use only a power cord that is in good condition.

For detailed information on power cords and connectors, see Fig. 1-3.

Refer cord and connector changes to qualified service personnel.

Use the Proper Fuse

To avoid fire hazard, use only the fuse of correct type, voltage rating and current rating as specified in the parts list for your product.

Refer fuse replacement to qualified service personnel.

Do Not Operate in Explosive Atmospheres

To avoid explosion, do not operate this product in an explosive atmosphere unless it has been specifically certified for such operation.

Do Not Remove Covers or Panels

To avoid personal injury, do not remove the product covers or panels. Do not operate the product without the covers and panels properly installed.

SERVICE SAFETY SUMMARY

FOR QUALIFIED SERVICE PERSONNEL ONLY

Refer also to the preceding Operators Safety Summary

Do Not Service Alone

Do not perform internal service or adjustment of this product **unless** another person capable of rendering first aid and resuscitation is present.

Use Care When Servicing With Power On

Dangerous voltages exist at several points in this product. To avoid personal injury, do not touch exposed connections and components while power is on.

Disconnect power before removing protective panels, soldering, or replacing components.

Power Source

This product is intended to operate from a power source that will not apply more than 250 volts **rms** between the supply conductors or between either supply conductor and ground. A protective ground connection by way of the grounding conductor in the power cord is essential for safe operation.

SERVICE SAFETY SUMMARY

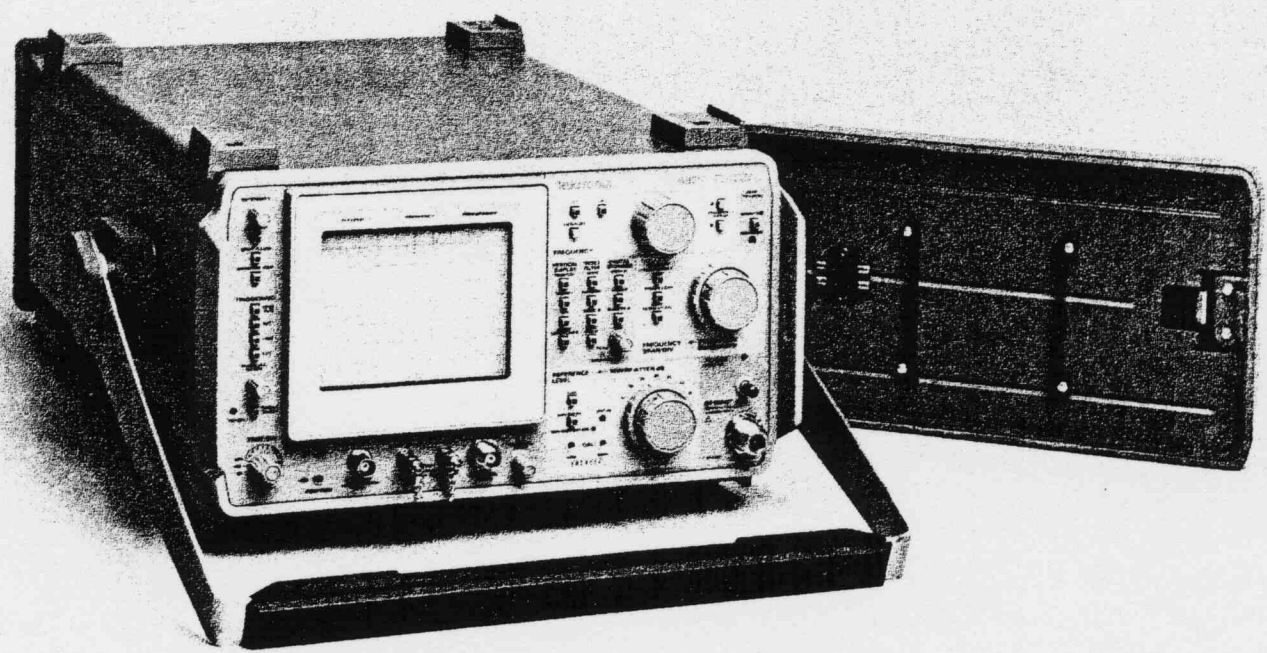
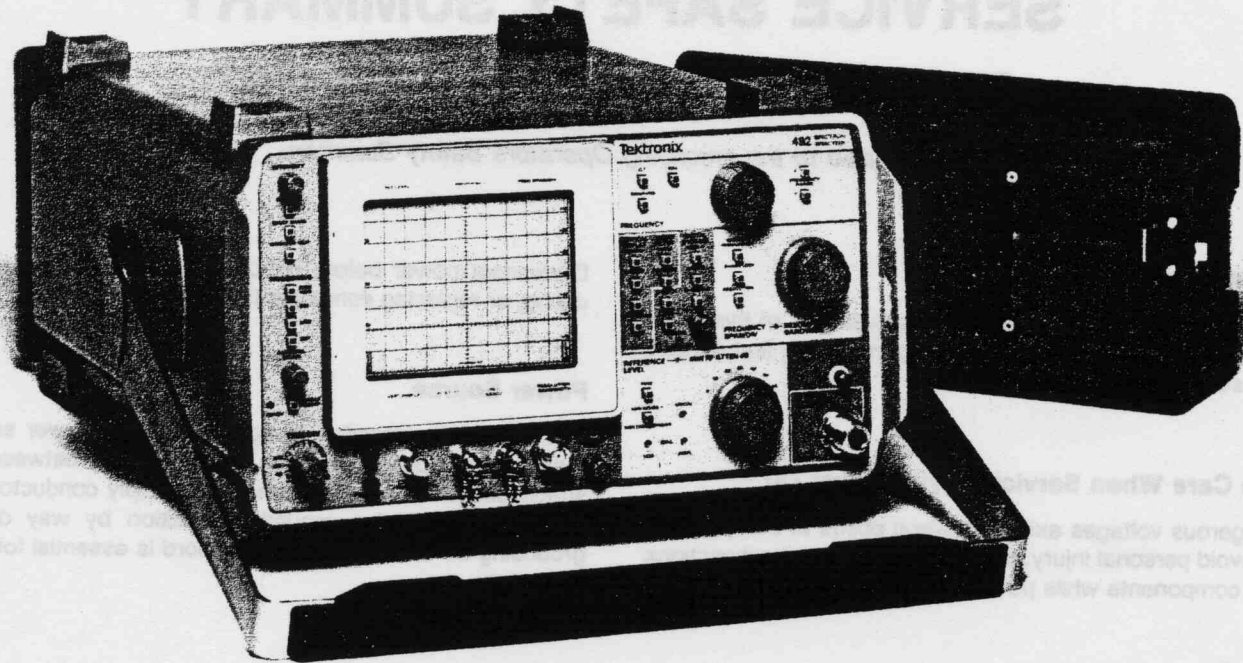

2726-22

492/492P Spectrum Analyzer

GENERAL INFORMATION AND SPECIFICATION

GENERAL INFORMATION

Introduction

This manual contains information pertinent to the installation and operation of the 492/492P Spectrum Analyzer. Contents and organization of the manual are described in the Table of Contents preceding this section. These instructions assume the user is knowledgeable in frequency domain analysis. The intent is to provide information necessary to effectively operate the 492/492P. Service information is in separate service manuals.

Document Standards, and References Used

Terminology used in the manual is in accordance with industry practice. Abbreviations are in accordance with ANSI Y1.1-1972, with exceptions and additions explained in parentheses after the abbreviation. Graphic **symbology** is based on ANSI Y32.2-1975. Logic symbology is based on ANSI Y32.14-1973 and the manufacturer's data books or sheets. A copy of ANSI standards may be obtained from the Institute of Electrical and Electronic Engineers, 345, 47th Street, New York, NY 10017.

Change and History Information

Change information that involves manual corrections and/or additional data is **located** at the back of the manual in the CHANGE INFORMATION section.

History information with the update data is integrated to the text or diagrams when a page or diagram is updated.

Product Description

The 492/492P Spectrum Analyzer is a high performance, compact, portable spectrum analyzer that displays absolute amplitude and frequency information of signals within the frequency spectrum of 50 kHz to 21 GHz with the internal coaxial mixer, and up to 140 GHz with optional external TEKTRONIX High Performance Waveguide Mixers. The 8.4 X 10.2 cm crt face reads out all major display parameters.

Some features of the 492 are: Simplified operation through the use of an internal microcomputer. Display dynamic range of 80 dB with calibrated reference level readout from -123 dBm to $+30$ dBm, in 10 dB and 1 dB steps. When using the AA mode, to measure the amplitude difference between two signals, the steps are 0.25 dB. Resolution bandwidths from 1 kHz to 1 MHz in decade steps, have a shape factor of 7.5:1 or better (options provide additional bandwidth selections of 100 Hz). Intermodulation products are: 70 dB or more down, harmonic distortion is down 70 dB or better. Sensitivity is -115 dBm to 7.1 GHz, at 1 kHz resolution bandwidth. Frequency response is ± 1.5 dB to 7.1 GHz and ± 2.5 dB to 18 GHz. Digital storage (with Option 02) features peak detection and digital signal averaging.

The 492P adds remote control capability to the features of the 492. The front panel controls (except those intended for local use, such as INTENSITY and POSITION controls) can be remotely operated through the GPIB port which allows the 492P to be used with a variety of systems and controllers. This operation is described in detail in the Programmer's manual.

The rackmount version (Option 30) of the 492/492P Spectrum Analyzer is the 492 or 492P instrument in a cabinet designed to mount in a standard 19 inch rack. Option 31 includes semi-rigid coaxial cabling from the front to the back of the cabinet which provides access to all front panel connectors via the cabinet rear panel.

A **benchtop** version (Option 32) is the 492 or 492P mounted in the rackmount version cabinet with side panels and feet on the bottom of the cabinet. Both the rackmount and bench top cabinets include a larger fan for additional cooling. This fan must be installed and operating before power can be applied to the instrument.

Electrical and environmental specifications that are unique to the **rackmount/benchtop** versions are described following the 492/492P specifications under the Options part of this section.

SPECIFICATION

The following list of instrument characteristics and features apply to the basic 492/492P Spectrum Analyzer after a 30 minute warmup, except as noted. Changes to the basic specifications due to the addition of options, follow this listing.

Requirements are provided in the Calibration section of the Service Instructions. These Performance Check procedures require sophisticated equipment as well as technical expertise to perform.

The Performance Requirement column describes quantitative limits of the characteristic, the Supplemental column explains performance requirements or provides performance information. Procedures to verify performance re-

The Operators manual contains a procedure that checks all functions of the 492/492P. This check is recommended for incoming inspection to verify that the instrument is operating properly.

Table 1-1
ELECTRICAL CHARACTERISTICS

Characteristic	Performance Requirement	Supplemental Information
FREQUENCY RELATED		
Center Frequency		
Range (Internal Mixer)	50 kHz to 21 GHz.	Frequency response degraded 1.0dB below 100 kHz.
Accuracy (after 2 hour warmup)	$\pm (5 \text{ MHz} + 20\% \text{ of span/div})$ or $+ (0.2\% \text{ of the center frequency} + 20\% \text{ of the span/div})$ whichever ever is greater.	
Readout Resolution		Within 1 MHz.
TUNE command accuracy (492P only under remote control) after a 2 hour warmup.		
1st LO Tuning		
Band	Freq Span/Div	$(+ 7\% \text{ of tune amount, or } + 150 \text{ kHz})n$ whichever is greater. (See listing of IF frequency, LO range, and harmonic number that follows for the value of n)
1-3	$> 50 \text{ kHz}$	
4	$> 100 \text{ kHz}$	
5-11	$> 200 \text{ kHz}$	
2nd LO Tuning		
1-3	$\leq 50 \text{ kHz}$	$\pm 7\% \text{ of tune amount}$
4	$\leq 100 \text{ kHz}$	
5-11	$\leq 200 \text{ kHz}$	
Repeatability accuracy (return to a previous frequency setting) with an ambient temperature change $\leq 10^\circ\text{C}$. (492P only under remote control)		$\pm (2 \text{ MHz} + 10\% \text{ of Span/div})$ or $\pm (0.1\% \text{ of frequency} + 10\% \text{ of Span/div})$ whichever is greater.

Table 1-1 (cont)

Characteristic	Performance Requirement	Supplemental Information		
FREQUENCY RELATED (cont)				
Residual FM (short term)	≤(1 kHz peak-to-peak) n for a period of 20 ms. The 1st LO harmonic number used in the 1st mixer conversion is n, and relates to the selected frequency range (band).	No video filter.		
Frequency Drift, after 2 hour warmup at a fixed frequency and stable ambient temperature.	≤200 kHz/hour, fundamental mixing.	A re-stabilization time of 10 minutes per GHz of 1st LO frequency change must be allowed if the frequency is returned.		
"Static" Resolution Bandwidth (6 dB down)	1 kHz to 1 MHz in decade steps, plus an automatic (AUTO position). Resolution bandwidth (6 dB down) is within 20% of the bandwidth selected.	In AUTO position the bandwidth is computed by an internal computer, based on the span/div, video filters, time/div, and vertical display selections. When both the TIME/DIV and RESOLUTION BANDWIDTH are in AUTO position, the resolution bandwidth is a function of the FREQUENCY SPAN/DIV selection.		
Shape Factor (60 dB/6 dB)	7.5:1 or better			
Noise Sidebands	At least -75 dBc at 30 times the resolution bandwidth offset for fundamental mixing.			
Video Filter				
Narrow		Reduces video bandwidth to approximately 1/300th of the selected resolution bandwidth.		
Wide		Reduces video bandwidth to approximately 1/30th of the selected resolution bandwidth.		
Frequency Span/Div				
Range		Band	Narrow Span	Wide Span
		1—3 (0—7.1 GHz)	10 kHz/Div	200 MHz/Div
		4—5 (5.4—21 GHz)	50 kHz/Div	500 MHz/Div
		6 (18—26 GHz)	50kHz/Div	1 GHz/Div
		7—8 (26—60 GHz)	100 kHz/Div	2 GHz/Div
		9 (60—90 GHz)	200kHz/Div	2 GHz/Div
		10 (90—140 GHz)	500 kHz/Div	5 GHz/Div
		11 (140—220 GHz)	500 kHz/Div	10 GHz/Div
		Two additional positions provide full band (MAX span) display or 0 Hz (time domain) display.		

Table 1-1 (cont)

Characteristic	Performance Requirement		Supplemental Information
FREQUENCY RELATED (cont)			
Accuracy	Within 5% of the span/div selected over the center eight divisions of a ten division display.		
Frequency Response and Display Flatness			Frequency response is measured with an RF attenuation of ≥ 10 dB and PEAKING optimized for each center frequency setting, when applicable. Response includes the effects of input vswr, mixing mode (n), gain variation, pre-selector , and mixer. Display flatness is typically 1 dB greater than the frequency response. Refer to Rackmount/Benchtop section for variance to this performance.
Coaxial (direct) Input	About the mean	Referenced to 100 MHz	
Band 1 100 kHz—4.2 GHz 50 kHz—4.2 GHz	± 1.5 dB ± 2.5 dB		
Band 2 1.7—5.5 GHz	± 1.5 dB	± 2.5 dB	
Band 3 3.0—7.1 GHz	± 1.5 dB	± 2.5 dB	
Band 4 5.4—18.0 GHz	± 2.5 dB	± 3.5 dB	
Band 5 15.0—21.0 GHz	± 3.5 dB	± 5.0 dB	
External High Performance Waveguide Mixers			TEKTRONIX High Performance Waveguide Mixers.
Band 6 18.0—26 GHz	+3.0 dB		
Band 7 26—40.0 GHz	± 3.0 dB		
Band 8 40—60 GHz	± 3.0 dB		
Band 9 60—90 GHz			Dependent on external mixer
Band 10 90—140 GHz			Dependent on external mixer
Band 11 140—220 GHz			Dependent on external mixer

Table 1-1 (cont)

Characteristic	Performance Requirement	Supplemental Information															
AMPLITUDE RELATED (cont)																	
Accuracy	± 1.0 dB/10 dB to maximum cumulative error of ± 2.0 dB over the 80 dB window and ± 0.4 dB/2 dB to a maximum cumulative error of ± 1.0 dB over the 16 dB window. LIN mode is $\pm 5\%$ of full screen.																
RF Attenuator																	
Range		0 to 60 dB in 10 dB steps.															
Accuracy																	
DC to 4 GHz	Within 0.3 dB/10 dB to a maximum of 0.7 dB over the 60 dB range.																
4 GHz to 18 GHz	Within 0.5 dB/10 dB to a maximum of 1.4 dB over the 60 dB range.																
IF Gain																	
Range		83 dB of gain increase, 10 dB of gain decrease (MIN NOISE activated) in 10 dB and 1 dB steps.															
Accuracy	Within 0.2 dB/1 dB except at the 10 dB reference level transition from -29 to -30 dBm, -39 to -40 dBm, -49 to -50 dBm, -59 to -60 dBm, and -69 to -70 dBm, where the accuracy is 0.5 dB; and within 0.5 dB/10 dB to a maximum of ± 2 dB over the 90 dB range.																
Differential Amplitude Measurement (A A mode)		Provides differential measurements in 0.25 dB increments.															
Accuracy	<table border="1" style="width: 100%; border-collapse: collapse;"> <thead> <tr> <th>dB Difference</th> <th>Steps</th> <th>Error</th> </tr> </thead> <tbody> <tr> <td>0.25 dB</td> <td>1</td> <td>0.05 dB</td> </tr> <tr> <td>2 dB</td> <td>8</td> <td>0.4 dB</td> </tr> <tr> <td>10 dB</td> <td>40</td> <td>1.0 dB</td> </tr> <tr> <td>50 dB</td> <td>200</td> <td>2.0 dB</td> </tr> </tbody> </table>	dB Difference	Steps	Error	0.25 dB	1	0.05 dB	2 dB	8	0.4 dB	10 dB	40	1.0 dB	50 dB	200	2.0 dB	Within the reference level range of -123 dBm to +30 dBm.
dB Difference	Steps	Error															
0.25 dB	1	0.05 dB															
2 dB	8	0.4 dB															
10 dB	40	1.0 dB															
50 dB	200	2.0 dB															
Range	From 10 dB above to 40 dB below the reference level established when the A A mode was activated.	Do not use A A outside the -123 dBm to +30 dBm reference level range. Total range is at least 50 dB.															
Signal Amplitude Variation With Resolution Switching	Less than 0.5 dB. <0.8 dB. (For Serial Number B056123 & up.)																

AMPLITUDE RELATED (cont)

Sensitivity

The following tabulation shows the equivalent maximum input noise for each resolution bandwidth, with the internal mixer for frequency bands 1—5 (100 kHz—18 GHz) and TEKTRONIX High Performance Waveguide Mixers for bands 6—10 (18 GHz—140 GHz). The NARROW video filter is activated, for narrow resolutions (1 kHz or less); WIDE filter for wide resolution.

SENSITIVITY VERSUS BANDWIDTH

Frequency/Band	Equivalent Input Noise for Resolution Bandwidths			
	1 kHz	10 kHz	100 kHz	1 MHz
50 kHz—7.1 GHz (Bands 1—3)	-115 dBm	-105 dBm	-95 dBm	-85 dBm
5.4—18.0 GHz (Band 4)	-100 dBm	-90 dBm	-80 dBm	-70 dBm
15—21.0 GHz (Band 5)	-95 dBm	-85 dBm	-75 dBm	-65 dBm
18.0—26 GHz (Band 6) ^a	-100 dBm	-90 dBm	-80 dBm	-70 dBm
26—40.0 GHz (Band 7) ^a	-95 dBm	-85 dBm	-75 dBm	-65 dBm
40.0—60.0 GHz (Band 8) ^a	-95 dBm	-85 dBm	-75 dBm	-65 dBm
60.0—90.0 GHz (Band 9)	External Mixer Dependent			
90.0—140 GHz (Band 10)	External Mixer Dependent			
140—220 GHz (Band 11)	External Mixer Dependent			

^aTEKTRONIX High Performance Waveguide Mixers.

Table 1-1 (cont)

Characteristics	Performance Requirement	Supplemental Information
AMPLITUDE RELATED (cont)		
Spurious Response		
Residual (no input signal, referenced to mixer input, and fundamental mixing for bands 1, 2, and 3)	- 100 dBm or less.	
Third order intermodulation products (MIN DISTORTION mode)	Typically -60 dBc for a full screen signal.	
Harmonic Distortion	At least -60 dBc with -40 dBm input.	
LO Emissions (referenced to input mixer)	- 10 dBm or less.	

INPUT SIGNAL CHARACTERISTICS

RF INPUT		Type N female connector, specified to 18GHz, usable to 21 GHz.
Input Impedance		50 Ω; vswr with ≥ 10 dB of RF attenuation: 50 kHz—2.5 GHz; 1.3:1 (typically 1.2:1) 2.5—6.0GHz; 1.7:1 (typically 1.5:1) 6.0—18.0GHz, 2.3:1 (typically 1.9:1) 18.0—21 GHz; 3.5:1 (typically 2.7:1)
Input Level		
Optimum level for linear operation	- 30 dBm, referenced to input mixer.	This is achieved by being in MIN DISTORTION and not exceeding full screen.
1 dB compression point		- 18 dBm. no RF attenuation.
Maximum input level		
RF Attenuation at 0 dB		+ 13 dBm (Input mixer limit).
With 20 dB or more RF Attenuation		+ 30 dBm (1 W) continuous, 75 W peak, pulse width 1 μs or less with a maximum duty factor of 0.001 (attenuator limit). Do not apply dc voltage to the RF INPUT.
External Mixer		Input for IF signal and the source of negative-going bias for external waveguide mixers. Bias range +1.0 to -2.0 V.
EXT IN HORIZ/TRIG		DC coupled input for horizontal drive and ac coupled for trigger signal.

Table 1-1 (cont)

Characteristic	Performance Requirement	Supplemental Information
INPUT SIGNAL CHARACTERISTICS (cont)		
Input Voltage Range Sweep		0 to +10 V (dc + peak ac) for full screen deflection.
Trigger Serial #B030000 & up	1.0 V peak (minimum). Frequency 15 Hz to 1 MHz	Maximum input: 50 V (dc + peak ac) Maximum ac input: 30 V rms to 10 kHz then derate linearly to 3.5 V rms @ 100 kHz and above. Pulse width 0.1 μ s minimum
Serial #B010000– B029999	0.5 V peak, frequency 15 Hz to 1 MHz.	Must be terminated into 1 k Ω or less. Maximum input 50 V peak. Pulse width 0.1 MS minimum
ACCESSORY (J104)		This connector may be used for future applications.
OUTPUT SIGNAL CHARACTERISTICS		
Calibrator (CAL OUT)	–20 dBm \pm 0.3 dB at 100 MHz \pm 1.7 kHz.	100 MHz comb markers are provided for frequency and span calibration.
1st LO and 2nd LO		Provides access to the output of the respective local oscillators (1st LO +7.5 dBm minimum to a maximum of +15 dBm, 2nd LO –22 dBm minimum to a maximum of +15 dBm). These ports must be terminated in 50 Ω at all times.
VERTICAL		Provides 0.5 V \pm 5% of signal per division of video above and below the centerline. Centerline represents 0 V. Source impedance approximately 1 k Ω .
HORIZ OUT		Provides 0.5 V/Div either side of center. Full range –2.5 V to +2.5 V \pm 10%. Source impedance approximately 1 k Ω .
PEN LIFT		TTL compatible, nominal +5 volts to lift pen.
IF OUT		Access to the 10 MHz IF. Output level is approximately –16 dBm for a full screen signal at –30 dBm reference level. Nominal impedance approximately 50 Ω .
PROBE POWER		Provides operating power for active probe systems. Output voltages and pin-out are shown in Fig. 1-1.

PROBE POWER. The PROBE POWER connector on the rear panel of this instrument provides operating power for active probe systems. It is not recommended that these connectors be used as a power source for applications other than the compatible probes or other accessories which are specifically designed for use with this source.

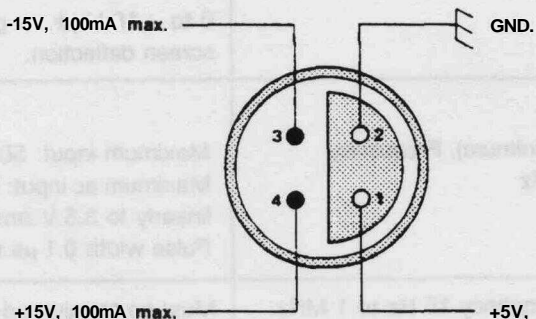

2726-21

Fig. 1-1. Probe Power Connector.

Characteristic	Performance Requirement	Supplemental Information
----------------	-------------------------	--------------------------

GENERAL CHARACTERISTICS

Sweep		! Triggered, auto, manual, and external.
Sweep Time	20 μ s/Div to 5 s/Div in 1-2-5 sequence (10 s/Div in Auto).	
Accuracy	\pm 5%.	
Triggering	\geq 2.0 division of signal for internal, and 1.0 V peak minimum for external.	Internal, external, free run, and single sweep. Internal is ac coupled (15 Hz to 1 MHz).
Crt Readout		Displays: Reference level, frequency, vertical display mode, frequency span/div, frequency range, resolution bandwidth and RF attenuation.

POWER REQUIREMENTS

Characteristic	Description
Input Voltage	90 to 132 Vac or 180 to 250 Vac, 48 to 440 Hz.
Power (Options 01, 02, 02)	At 115 V, 60 Hz; 210 watts maximum, 3.2 amperes.
Leakage Current	5 mA maximum.

NOTE

If power to this instrument is interrupted, it may be necessary to *re-initialize* the microcomputer; when power is restored, turn the POWER switch Off for 5 seconds then back On.

Table 1-2

ENVIRONMENTAL CHARACTERISTICS

Meets MIL T-28800B, type III class 3, style C specifications, comprised of the following:

Characteristic	Description
Temperature	
Operating and humidity	-15°C to +55°C/95% (+5%, -0%) relative humidity.
Non-operating	-62°C to +75°C.

NOTE

After storage at temperatures below the operating range, the microcomputer may not initialize on power-up. If so, allow the instrument to warm up for 20 minutes and re-initialize the microcomputer by turning the POWER Off for 5 seconds then back On.

Altitude																	
Operating	15,000 feet.																
Non-operating	40,000 feet.																
Humidity (non-operating)	Five cycles (120 hours) of MIL-Std-810.																
Vibration	Method 514 Procedure X MIL-Std 810C (modified).																
Operating (Instrument secured to a vibration platform during test)	Resonant searches along all three axes at 0.025 inch, frequency varied from 10-55 Hz, 15 minutes. All major resonances must be minimum per axis plus dwell at resonant frequency of 55 Hz for 10 minutes minimum per axis. Instrument secured to vibration platform during test. Total vibration time about 75 minutes.																
Shock (Operating and Non-operating)	Three shocks of 30 g, one-half sine, 11 ms duration, each direction along each major axis. Guillotine-type shocks. Total of 18 shocks.																
Transit drop (free fall)	12 inch, one per each of six faces and eight corners.																
Electromagnetic Interference (EMI)	Within limits described in MIL-Std-461.																
	<table border="1"> <thead> <tr> <th>Test Method</th> <th>Remarks</th> </tr> </thead> <tbody> <tr> <td>Conducted emissions</td> <td></td> </tr> <tr> <td> CE01</td> <td>10 kHz to 20 kHz only.</td> </tr> <tr> <td> CE03</td> <td>20 kHz to 50 MHz power leads. Except 30 kHz to 35 kHz, relaxed by 15 dB.</td> </tr> <tr> <td>Conducted susceptibility</td> <td></td> </tr> <tr> <td> CS01</td> <td>30 Hz to 50 kHz power leads. Full limits.</td> </tr> <tr> <td> CS02</td> <td>50 kHz to 400 MHz power leads. Full limits.</td> </tr> <tr> <td> CS06</td> <td>spike power leads. Full limit.</td> </tr> </tbody> </table>	Test Method	Remarks	Conducted emissions		CE01	10 kHz to 20 kHz only.	CE03	20 kHz to 50 MHz power leads. Except 30 kHz to 35 kHz, relaxed by 15 dB.	Conducted susceptibility		CS01	30 Hz to 50 kHz power leads. Full limits.	CS02	50 kHz to 400 MHz power leads. Full limits.	CS06	spike power leads. Full limit.
Test Method	Remarks																
Conducted emissions																	
CE01	10 kHz to 20 kHz only.																
CE03	20 kHz to 50 MHz power leads. Except 30 kHz to 35 kHz, relaxed by 15 dB.																
Conducted susceptibility																	
CS01	30 Hz to 50 kHz power leads. Full limits.																
CS02	50 kHz to 400 MHz power leads. Full limits.																
CS06	spike power leads. Full limit.																

Table 1-2 (cont)

Characteristic	Description	
	Test Method	Remarks
Radiated emissions	RE01 30 Hz to 30 kHz magnetic field	Relaxed by 10 dB for fundamental, 2nd and 3rd harmonic of power line.
	RE02 14 to 10 GHz.	Full limit.
Radiated susceptibility	RS01 30 Hz to 30 kHz magnetic field.	Full limit.
	RS03 up to 1 GHz.	Full limit.

Table 1-3

PHYSICAL CHARACTERISTICS

Characteristics	Description
Weight (standard accessories and cover except manuals)	44 pounds (20 kg) maximum.
Dimensions (Fig. 1-2)	
Without front cover and handle or feet	6.9 X 12.87 X 19.65 inches (1750 mm X 3269 mm X 4991 mm).
With front cover, feet and handle	9.15 X 15.03 X 23.1 inches (handle folded back over instrument), 25.85 inches (handle fully extended).

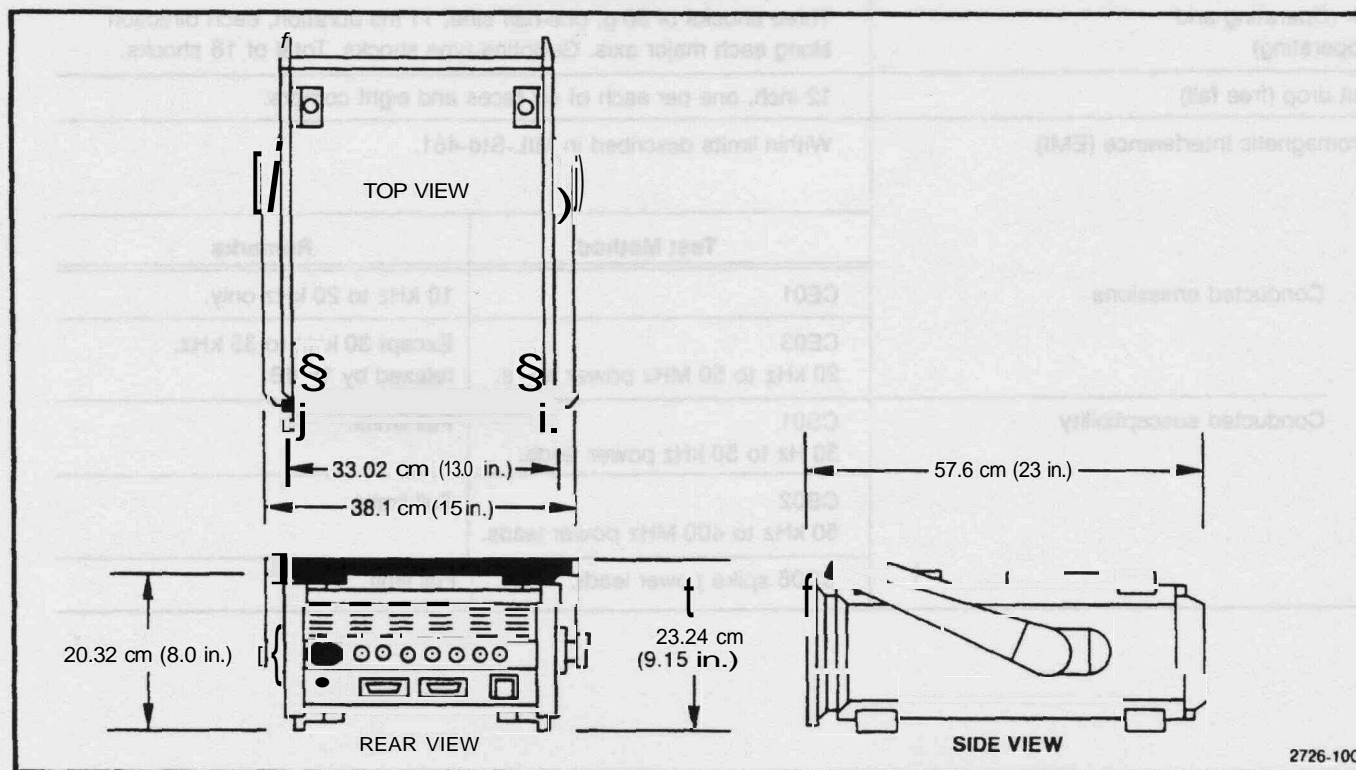

Fig. 1-2. Dimensions.

ACCESSORIES

Table 1-4

STANDARD ACCESSORIES

(Refer to Accessories listing in the service manual for part numbers.)

Description	Qty.	Storage
50 1) Coax Cable, n to n conn, 6 Feet	1	Front Cover or Drawer
50 Ω Coax Cable, bnc to bnc conn, 18 Inch	1	Front Cover or Drawer
Manual, Operators	1	
Manual, Operators, Handbook	1	Front Cover or Drawer
Manual, Programmer's (492P only)	1	Front Cover or Drawer
Manual, Service, Volume 1	1	
Manual, Service, Volume 2	1	
Adapter, n Male to bnc Female	1	Front Cover or Drawer
Fuses 4 A, fast ^a	2	Front Cover or Drawer
Power Cord (115 V nominal)	1	Front Cover or Drawer
Cord Clamp	1	Front Cover or Drawer
Crt Light Filter, Amber	1	Front Cover or Drawer
Crt Light Filter, Grey	1	Front Cover or Drawer
Crt Mesh Filter	1	Front Cover or Drawer
Diplexer Assembly ^b	1	Front Cover or Drawer
Adapter, tnc-to-sma	1	Part of Diplexer Assembly
Cable, Semi-rigid, 50 Ω	1	Part of Diplexer Assembly
GPIB Interconnect Cable (492P only)		

^aIf the instrument is wired for 220-240 V operation (Options A1, A2, A3, or A4) the fuses are replaced with 2A slow blow.

^bOption 08 deletes the Diplexer assembly.

OPTIONS

Options available for the 492/492P and their resultant changes to the specifications are listed below. Options are factory installed at the time of the initial order. Contact your local Tektronix Field Office for additional information.

OPTION 01

This option provides calibrated preselection to the first (1st) mixer for the 1.7 to 18 GHz frequency range and limiter protection below 1.8 GHz. Band 1 becomes 100kHz to 1.8GHz using an input low-pass filter; the preselector starts at Band 2 (1.7 GHz).

Table 1-5

OPTION 01 ELECTRICAL CHARACTERISTICS

The following changes and additions in electrical characteristics apply:

Characteristic	Performance Requirement	Supplemental Information
Spurious Responses		
Intermodulation Products		
1.8—18 GHz	At least -70 dBc from any two on-screen signals within any frequency span.	\geq -100 dBc when signals are separated 100 MHz or more.
1.7—1.8 GHz	At least -70 dBc from any two -40 dBm signals within any frequency span.	
Harmonic Distortion (cw signal 1.7—18GHz)	-100 dBc or more for full screen signal (MIN DISTORTION mode).	
LO emission, referenced to input mixer and with zero RF attenuation	Less than -70 dBm to 18 GHz.	
Input Level		
Maximum Safe Input with zero RF attenuation		1 watt or +30 dBm .
1 dB Compression Point (minimum):		
1.7—2.0 GHz		-28 dBm , no RF attenuation.
Otherwise		-18 dBm , no RF attenuation.

Table 1-5 (cont)

Characteristic	Performance Requirement		Supplemental Information	
Frequency Response and Display Flatness			Frequency response is measured with 10 dB of RF attenuation and PEAKING optimized for each center frequency setting, when applicable. Response includes the effects of input vswr, mixing mode (n), gain variation, preselector, and mixer. Display flatness is typically 1 dB greater than the frequency response.	
Coaxial (direct) Input	About the mean	Referenced to 100 MHz		
Band 1 100 kHz—1.8 GHz 50 kHz—1.8 GHz	± 1.5 dB ± 2.5 dB			
Band 2 1.7—5.5 GHz	± 2.5 dB	± 3.5 dB		
Band 3 3.0—7.1 GHz	± 2.5 dB	± 3.5 dB		
Band 4 5.4—18.0 GHz	± 3.5 dB	± 4.5 dB		
Band 5 15.0—21.0 GHz	± 5.0 dB			
External High Performance Waveguide Mixers	About the mean	Referenced to 100 MHz		TEKTRONIX High Performance Waveguide Mixers.
Band 6 18.0—26 GHz	± 3.0 dB	± 6.0 dB		
Band 7 26—40.0 GHz	± 3.0 dB	± 6.0 dB		
Band 8 40—60 GHz	± 3.0 dB	± 6.0 dB		
Band 9 60—90 GHz			Dependent on external mixer.	
Band 10 90—140 GHz			Dependent on external mixer.	
Band 11 140—220 GHz			Dependent on external mixer.	

SENSITIVITY
(OPTION 01)

Sensitivity

The following tabulation shows the equivalent maximum input noise for each resolution bandwidth, with the internal mixer for frequency bands 1—5 (100kHz—18 GHz), and TEKTRONIX High Performance Waveguide Mixers for bands 6—10 (18 GHz—140 GHz). The NARROW video filter is activated, for narrow resolutions (1 kHz or less); WIDE filter for wide resolution.

Frequency/Band	Equivalent Input Noise for Resolution Bandwidths			
	1 kHz	10 kHz	100 kHz	1 MHz
50 kHz—7.1 GHz (Bands 1—3)	-110 dBm	-100dBm	-90 dBm	-80 dBm
5.4—12.0 GHz (Band 4)	-95dBm	-85 dBm	-75 dBm	-65 dBm
12.0—18.0 GHz (Band 4)	-90 dBm	-80dBm	-70 dBm	-60 dBm
15.0—21.0 GHz (Band 5)	-85 dBm	—	—	—
18.0—26.5 GHz (Band 6) ^a	-100 dBm	-90 dBm	-80 dBm	-70 dBm
26.5—40.0 GHz (Band 7) ^a	-95 dBm	-85 dBm	-75 dBm	-65 dBm
40.0—60.0 GHz (Band 8) ^a	-95 dBm	-85 dBm	-75 dBm	-65 dBm
60.0—90.0 GHz (Band 9)	External Mixer Dependent			
90.0—140 GHz (Band 10)	External Mixer Dependent			
140—220 GHz (Band 11)	External Mixer Dependent			

^aHigh Performance TEKTRONIX Waveguide Mixers.

OPTION 02

This option provides digital storage. The following are the changes and additions to the instrument.

Multiple memory (A & B) display storage is provided with: Save A, Max Hold, B memory minus Save A memory, digital display averaging, and storage bypass for non-store display.

When digital storage is used, an additional quantization error of 0.5% of full screen must be added to the measured amplitude characteristics (i.e., frequency response, sensitivity, etc.).

OPTION 03

This option provides first (1 st) local oscillator stabilization by phase locking to an internal reference to reduce residual FM when narrow bands are selected. The microcomputer automatically selects phase lock for a span/division of 50 kHz or less in Bands 1 through 3, 100 kHz or less in Band 4, and 200 kHz or less in Bands 5 and above. This option also adds a 100 Hz resolution filter. The instrument characteristics that are changed are listed below.

**Table 1-6
OPTION 03 ELECTRICAL CHARACTERISTICS**

Characteristic	Performance Requirement	Supplemental Information				
		Band	Narrow Span	Wide Span		
Frequency Span/Div Range		1—3 (0—7.1 GHz)	500 Hz/Div	200 MHz/Div		
		4—5 (5.4—21 GHz)	500 Hz/Div	500 MHz/Div		
		6 (18—26 GHz)	500 Hz/Div	1 GHz/Div		
		7—8 (26—60 GHz)	500 Hz/Div	2 GHz/Div		
		9 (60—90 GHz)	500 Hz/Div	2 GHz/Div		
		10 (90—140 GHz)	500 Hz/Div	5 GHz/Div		
		11 (140—220 GHz)	500 Hz/Div	10 GHz/Div		
		Two additional positions provide full band display (MAX span) or 0 Hz (time domain display).				
		Accuracy	Within 5% of the span/div selected over the center eight divisions of a ten division display.			
		Resolution	Additional resolution bandwidth of 100Hz with 7.5:1 shape factor except instruments prior to B040000 that have the cavity 2nd LO A20, Part No. 119-1022-00 and 119-1022-01. Shape factor for these instruments with 100Hz resolution is 15:1.			
Noise Sidebands	At least -75 dBc at 30 times the resolution bandwidth offset (—70 dBc for 100 Hz resolution bandwidth) for fundamental mixing.					

Table 1-6 (cont)

OPTION 03 (cont)

Characteristic	Performance Requirement	Supplemental Information
Residual FM (short term) after 2 hour warmup	$\leq (50 \text{ Hz peak-to-peak}) n$ for a period of 20 ms. n is the 1st LO harmonic number used in the 1st mixer conversion, and related to the selected frequency range (band).	No video filter.
Frequency Drift, at a fixed frequency and stable ambient temperature		
B039999 and below, after a 2 hour warmup	± 25 kHz/hour, fundamental mixing.	
B040000 and up, after a 30 minute warmup	≤ 15 kHz/10 minutes, fundamental mixing.	≤ 5 kHz/10 minutes, typical
B040000 and up, after a 1 hour warmup.	≤ 3 kHz/10 minutes, fundamental mixing	≤ 1 kHz/10 minutes, typical.
Sensitivity (100 Hz)	8 dB better than 1 kHz sensitivity.	

OPTION 08

Deletes Extnal Mixer capability. Standard accessories do not include the Diplexer cable, and adapter (see Accessories listing). Frequency range of the instrument is 50 kHz to 21 GHz.

OPTION 11

Provides internal automatic preselector, and external mixer peaking for 492P's ordered with Option 01, 02, 03 or 492P's with Option 01, 02, 03, 08.

OPTION 20

Includes: General Purpose Waveguide Mixers: 12.5 to 40 GHz. Tektronix Part No. 016-0640-00.

Table 1-7
OPTION 20 ELECTRICAL CHARACTERISTICS

Frequency Range	Part No.	Sensitivity: Equivalent Input Noise @ 1 kHz Bandwidth (Typical)
12.4—18 GHz	119-0097-00	-75 dBm
18.0—26.5 GHz	119-0098-00	-70 dBm
25.6—40 GHz	119-0099-00	-60dBm

Cable: TNC to SMA male connectors, 012-0748-00

OPTION 21

(WM-490-2)

Includes: High Performance Waveguide Mixers: 18 to 40 GHz. Mixers and cable as listed.

Table 1-8
OPTION 21 ELECTRICAL CHARACTERISTICS

Frequency Range	Nomenclature	Sensitivity: Equivalent Input Noise @ 1 kHz Bandwidth (Maximum)	Frequency Response	
			About the Mean	Referenced to 100 MHz
18.0—26.5 GHz	WM 490K	- 100 dBm	±3.0 dB	± 6 dB
26.5—40 GHz	WM 490A	-95 dBm	± 3.0 dB	± 6 dB

Cable: SMA to SMA connector, 012-0649-00

OPTION 22

(WM-490-3)

Includes: High Performance Waveguide Mixers: 18 to 60 GHz mixers and cable as listed.

Table 1-9
OPTION 22 ELECTRICAL CHARACTERISTICS

Frequency Range	Nomenclature	Sensitivity: Equivalent Input Noise @ 1 kHz Bandwidth (Maximum)	Frequency Response	
			About the Mean	Referenced to 100 MHz
18.0—26.5 GHz	WM 490K	- 100dBm	±3.0 dB	± 6 dB
26.5—40 GHz	WM 490A	-95 dBm	± 3.0 dB	± 6 dB
40—60 GHz	WM 490U	- 95dBm	±3.0 dB	± 6 dB

Cable: SMA to SMA male connector, 012-0649-00

NOTE

These characteristics assume that the waveguide mixer is connected to a *cw* signal source and that the **PEAKING** control is adjusted for maximum signal amplitude. The signal must be stable (not frequency modulated more than the resolution bandwidth), otherwise, frequency response specifications cannot be met.

Two additional millimeter waveguide mixers are also available. The type and frequency are: **WM 490E (40—90 GHz)** and **WM 490F (90—140 GHz)**.

OPTION 30

This is a rackmount version of the 492/492P. The instrument is installed in a rackmount cabinet. Additional cooling is provided and a front panel accessories drawer provides storage for most accessories used with the 492/492P. Rackmount versions subjected to external vibrations, from rack cooling fans or surrounding equipment, may show degradation of the FM characteristic. Because of different rack configurations, this degradation cannot be specified. In a typical fan cooled rack, degradation increases by a factor of two.

The following changes to environmental characteristics apply.

ENVIRONMENTAL

Rackmount versions meet MIL T-28800B, type III, class 5, style F, specification. Benchtop versions meet MIL T-28800B, type III, class 5, style E specification.

For vibrations specifications, the rackmount version (Option 30 and 31) shall have the instrument secured to the rack at the front and back. Option 31 instruments shall also have the semi-rigid cables, between the front panel connectors and the cabinet grill connectors, removed.

**Table 1-10
ENVIRONMENTAL CHARACTERISTICS FOR RACKMOUNT/BENCHTOP VERSIONS**

Characteristic	Performance Information	
	Temperature °C	Relative Humidity %
Temperature and Humidity	Operating	95 +5, -0
		75 ±5
		45 ±5
Non-operating	- 55 to 75	95 ±5, -0
Humidity (non-operating)	Same as 492/492P	
Altitude	Operating	10,000 Feet
	Non-operating	40,000 Feet
Vibration	Method 514 Procedure X (modified)/MIL-STD-810C. Vibration limit is 1 G. Resonance searches along all three axes at 0.0065 inch, frequency varied from 10 to 55 Hz, 15 minutes per axis, plus dwell at resonant frequency of 33 Hz for 10 minutes per axis. Total vibration time 75 minutes. Instrument secured to vibration platform during test.	
	Operating	
Transportation		
Package Vibration	Meets National Safe Transit Association's pre-shipment test (project 1A-B-1) when correctly packaged. One hour vibration of 1 G.	
Package Drop	Operable after a 24 inch drop on any corner or flat surface.	

Electromagnetic Interference (EMI)

Within limits described in MIL-STD-461 (same as 492/492P)

Table 1-11
PHYSICAL CHARACTERISTICS FOR RACKMOUNT/BENCHTOP VERSIONS

Characteristic	Description
Weight (standard accessories except manual)	70 pounds maximum for the rackmount version. 68 pounds maximum for the benchtop version.
Dimensions	
Rackmount (without side rails)	8.75 X 16.89 X 25.00 inch (2225 X 4290 X 6350 mm)
Benchtop (with feet and handles)	9.25 X 17.9 X 25.00 inch (2350 X 4547 X 6350 mm)
Benchtop (without feet or handles)	8.75 X 16.89 X 25.00 inch (2225 X 4290 X 6350 mm)

ACCESSORIES

STANDARD

Standard accessories are the same as the 492/492P with the addition of rack slides for the rackmount (Tektronix Part No. 351-0375-01). An accessories drawer provides the storage space in place of the front cover.

OPTIONAL

Same as the 492/492P except the transit case.

OPTION 31

Option 31 includes the necessary cabling to provide access of all the front panel connectors at the cabinet rear panel. This provision may degrade the response flatness and sensitivity at the high end of the frequency range. Degradation above 3.0 GHz is typically up to -2 dB.

Environmental characteristics are the same as Option 30 instruments. The semi-rigid cables between the front panel connectors and the connectors on the cabinet grill must be removed for vibration shock, and bench handling, tests.

OPTION 32

Option 32 is a benchtop version of the 492/492P and consists of the rackmount version with the side rails removed. Environmental and electrical characteristics are the same as the Option 30 instrument. The bail for tilting the instrument must be folded for bench-top handling characteristics.

OPTION 41

Option 41 (formerly Custom Mod UB) provides enhanced measurement capability for certain types of pulse-modulated signals used in Digital Microwave Radio. These include:

- A wider bandwidth preselector for better signal symmetry in digital radio bands.
- A narrow 30 Hz video filter for resolution bandwidth setting of 100kHz (approximately 1/3000 of the resolution bandwidth) to improve amplitude variation analysis at specific frequencies and frequency spans unique to the digital radio measurements.
- Improved frequency span/div accuracy at 5 MHz/Div span to enable accurate signal bandwidth measurements.

Table 1-12
OPTION 41 SPECIFICATION

Characteristic	Performance Requirement	Supplemental Information
Frequency Span/Div at Center Frequency of 6 and 11 GHz	5 MHz/Div is within +0, -1% over the center 6 divisions of the display	30 MHz equals 6.00 to 6.06 div.

OPTION 42

In Option 42 instruments the MARKER/VIDEO input port on the rear panel is replaced with a 110MHz IF output port. It provides a signal with a bandwidth greater than 5 MHz, which makes the spectrum analyzer suitable for broadband swept-receiver applications.

Table 1-13
OPTION 42 ELECTRICAL CHARACTERISTICS

Characteristic	Performance Requirement	Supplemental Information
110 MHz		
center frequency	108.5 MHz-111.5 MHz	
3 dB bandwidth	>5 MHz	
bandpass ripple	<0.5 dB	
symmetry about 110 MHz	± 1.0 MHz	
Power output with -30 dB input and signal at full screen (band 1)	≤0 dBm	nominal output impedance 50 Ω
(band 5)	≥-40 dBm	in MIN DISTORTION Mode only
		1 dB compression of output ≥0 dBm

OPTIONS FOR POWER CORD CONFIGURATION

Tektronix has implemented options that provide international approved power cord and plug configurations. These are shown and illustrated in Fig. 1-3.

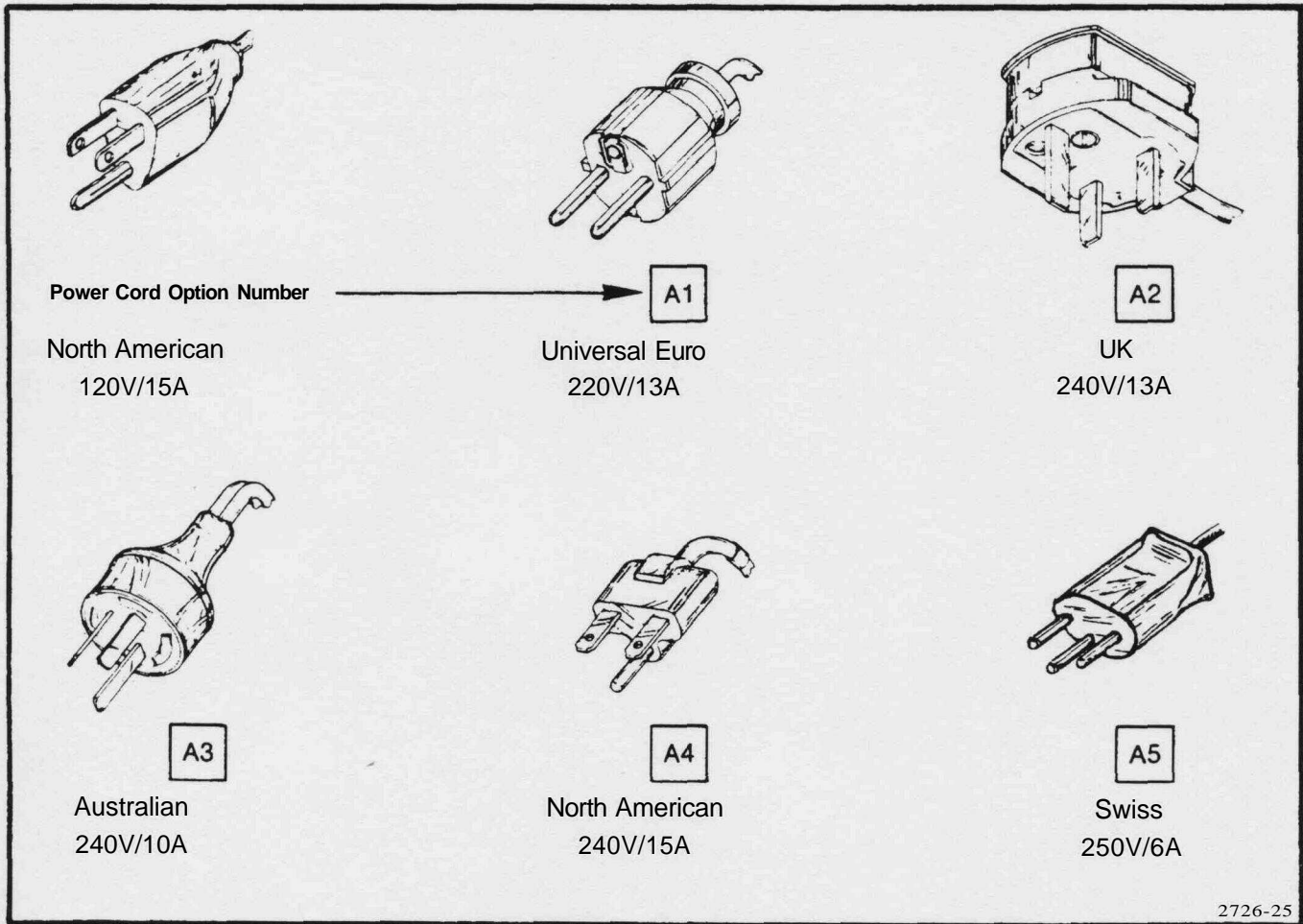

Fig. 1-3. International power cord and plug configuration for the 492/492P.

INSTALLATION AND REPACKAGING

Introduction

This section describes unpacking, installation, power requirements, and repackaging information for the 492/492P Spectrum Analyzer.

Unpacking and Initial Inspection

Before unpacking the 492/492P from its shipping container or carton, inspect for signs of external damage. If the carton is damaged, notify the carrier. The shipping carton contains the basic instrument and its standard accessories. Optional accessories are shipped in separate containers. Refer to the Accessories listing in the Specification section for a complete listing.

If the contents of the shipping container are incomplete, if there is mechanical damage or defect, or if the instrument does not meet operational check requirements, contact your local Tektronix Field Office or representative. If the shipping container is damaged, notify the carrier as well as Tektronix, Inc.

The instrument was inspected both mechanically and electrically before shipment. It should be free of mechanical damage and meet or exceed all electrical specifications. Procedures to check functional or operational performance are in the Operation section. The functional check procedure verifies proper instrument operation. This check should satisfy the requirements for most receiving or incoming inspections. The electrical performance check procedure is part of the Service instructions.

Preparation for Use

The 492/492P can be installed in any position that allows air flow in the bottom and out the rear of the instrument. Feet on the four corners allow ample clearance even if the instrument is stacked with other instruments. A fan draws air in through the bottom and expels air out the back. Avoid locating the 492/492P where paper, plastic, or like material might block the air intake.

The front panel cover provides a dust-tight seal. Use the cover to protect the front panel when storing or transporting the instrument. The cover is also used to store accessories and external waveguide mixers. The cover is removed by first pulling up and in on the two release latches then pulling

up on the cover. The door to the accessories compartment is unlatched by pressing the latch to the side and lifting the cover.

The handle of the 492/492P can be positioned at several angles to serve as a tilt stand, or it can be positioned at the top rear of the instrument between the feet and the rear panel, so instruments can be stacked. To position the handle, press in at both pivot points and rotate the handle to the desired position.



Removing or replacing the cabinet on the instrument can be hazardous. The cabinet should only be removed by qualified service personnel.

Installation instructions for the rackmount/benchtopy versions of the instrument are described in the Volume 1 Service Instruction manual. Refer installation to qualified service personnel.



If the rackmount version is extended out of the rack and tipped up to gain access to the bottom or back panels of the cabinet, it can fall back into the rack unless it is held. Use care when doing this to avoid damaging the front panel or equipment that may be mounted above the 492/492P.

Power Source and Power Requirements

The 492/492P is designed to operate from a single-phase power source that has one of its current-carrying conductors (neutral) at ground (earth) potential. Operating from power sources where both current-carrying conductors are isolated or above ground potential (such as phase-to-phase on a multi-phase system or across the legs of a 110-220 volt single-phase, three-wire system) is not recommended, since only the line conductor has over-current (fuse) protection within the unit. Refer to the Safety Summary at the front of this manual.

Installation and Repackaging—492/492P Operators

The ac power connector is a three-wire polarized plug with the ground (earth) lead connected directly to the instrument frame to provide electrical shock protection. If the unit is connected to any other power source, the unit frame must be connected to an earth ground.

Power and voltage requirements are printed on a back panel plate mounted below the power input jack. The 492/492P can be operated from either 115Vac or 230 Vac nominal line voltage with a range of 90 to 132 or 180 to 250 Vac, at 48 to 440 Hz. A multipin (harmonica) type connector on the power supply etched circuit board can be positioned to accommodate either voltage range. When the power supply circuitry is changed to accommodate a different power source, the information plate on the back panel must also be changed to reflect the new power requirements. Refer power input changes to qualified service personnel. Instructions are contained in the Service Information section.

WARNING

Only qualified service personnel should attempt to change the power input requirements. Unfamiliarity with safety procedures can result in personal injury. Refer to the Safety Summary at the front of this manual.

Repackaging for Shipment

When the 492/492P is to be shipped to a Tektronix Service Center for service or repair, attach a tag showing: owner and address, name of individual at your firm that can be contacted, complete serial number, and a description of the service required. If the original packaging is unfit for use or not available, repackage the equipment as follows:

1. Obtain a carton of corrugated cardboard having inside dimensions that are at least six inches more than the equipment dimensions, to allow for cushioning. Table 2-1 lists instrument weights and carton strength requirements.

2. Install the front cover on the 492/492P and surround the equipment with polyethylene sheeting to protect the finish.

3. Cushion the equipment on all sides with packing material or urethane foam between the carton and the sides of the equipment.

4. Seal with shipping tape or industrial stapler.

Table 2-1
SHIPPING CARTON TEST STRENGTH

Gross Weight		Carton Test Strength	
Pounds	Kilograms	Pounds	Kilograms
0—10	0—3.73	200	74.6
10—30	3.73—11.19	275	102.5
30—120	11.19—44.76	375	140.0
120—140	44.76—52.22	500	186.5
140—160	52.22—59.68	600	223.8

If you have any questions, contact your local Tektronix Field Office or representative.

OPERATION

This section describes the function of the controls, indicators, and connectors for the 492/492P, operational checkout of the instrument, and a detailed description of some functions.

The controls, indicators, and connectors unique to the 492P and its functions are described at the end of this section.

CONTROLS, INDICATORS, AND CONNECTORS

Because most operational functions of the 492 are microprocessor controlled, they are switch selected rather than vernier adjusted.

The following describes the function of the controls, indicators, and connectors on the front and rear panels of the

492. Figures 3-1 and 3-2 illustrate their locations. All options are covered in this description and some functions are described in greater depth under Operating Information.

Front Panel (Fig. 3-1)

- (1) **INTENSITY.** Controls brightness of the crt trace and crt readout. (Focus is automatically adjusted electronically.)
- (2) **READOUT.** Switches crt readout on or off. All spectrum analyzer parameters are read out except Time/Div. Brightness is proportional to the trace brightness and the ratio can be readjusted by service personnel.
- (3) **GRAT ILLUM.** Switches graticule light on or off.
- (4) **BASELINE CLIP.** When activated, the baseline of the display is clipped or subdued to increase the contrast between the display and the baseline.

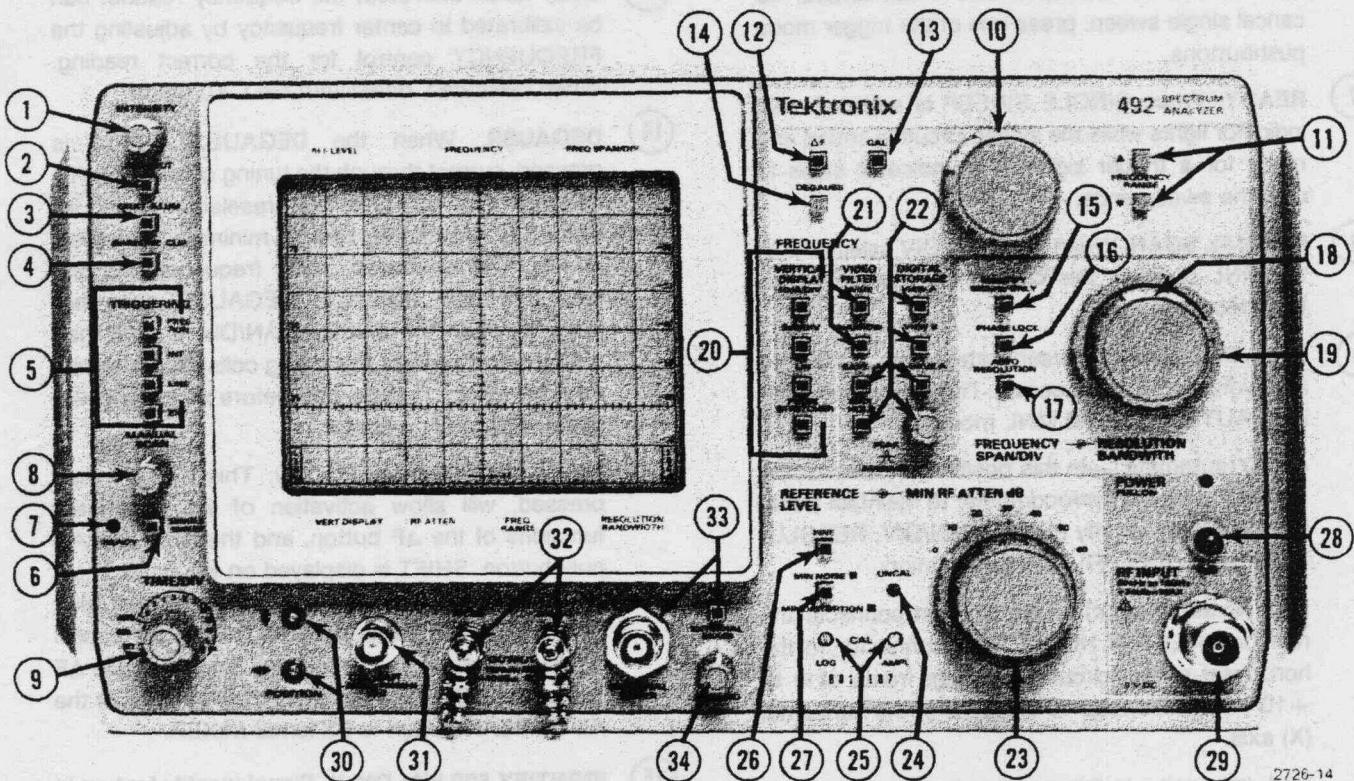

Fig. 3-1. Front panel selectors, controls, and connectors.

5 TRIGGERING. One of four triggering modes can be selected by pushbuttons that illuminate when activated. A SINGLE SWEEP pushbutton plus a READY indicator provide single sweep operation.

FREE RUN—When activated, the sweep is free running without regard to trigger signals. When selected, all other triggering modes are canceled.

INT—When activated, the sweep is triggered by any signal at the left edge of the display with an amplitude of 2.0 division or more. Other trigger modes are canceled.

LINE—When activated, a sample of the ac power line voltage is used to trigger the sweep. All other modes are canceled when selected.

EXT—When selected, the sweep is triggered by signals between 1.0 volt peak (minimum) to 50 volts peak (maximum) that are applied through the back panel EXT IN HORIZ/TRIG connector. When EXT is selected, the other modes are canceled.

6 SINGLE SWEEP. When selected, one sweep is initiated after the sweep circuit has been triggered. Pushing this button does not cancel the trigger modes. The button must be pressed to rearm the sweep circuit after the sweep has run. When single sweep mode is first selected, the present sweep is aborted and the sweep circuit is not armed. To cancel single sweep, press one of the trigger mode pushbuttons.

7 READY. When SINGLE SWEEP is selected, this indicator lights while the sweep circuit is armed and ready for a trigger signal. The indicator stays lit until the sweep ends.

8 MANUAL SCAN. When the TIME/DIV selector is in the MNL position, this control will manually scan the spectrum.

9 TIME/DIV. Selects sweep rates from 5 s/div to 20 μ s/div in 5-2-1 sequence. This switch also selects AUTO, EXT, and MNL modes.

AUTO (automatic)—In this position the sweep rate is selected by the microcomputer to maintain a calibrated display for any **FREQ SPAN/DIV**, **RESOLUTION**, and **VIDEO FILTER** combination.

EXT (external input)—This position connects the rear panel EXT IN HORIZ/TRIG connector to the horizontal sweep circuit. A voltage ramp of 0 to +10 volts will sweep 10 divisions of the horizontal (X) axis.

MNL (manual)—In this position the horizontal axis can be swept with the **MANUAL SCAN** control.

10 FREQUENCY. Tunes the center frequency. Tune rate is proportional to the selected **FREQ SPAN/DIV**. Any given signal moves across the display at a constant rate for all spans. In **MAX** span, the tuning range depends on the band; for example, in Band 2 (1.7—5.5 GHz) the frequency dot will not tune to the extreme left edge of the graticule, or in Band 6 (15—21 GHz) the dot will tune only to the right of center. Range of tuning is limited to 4.5 MHz in the narrow spans because a second oscillator is used to improve stability.

11 FREQUENCY RANGE (band). These two pushbuttons shift the center frequency range up or down. Frequency range of the band is displayed on the crt readout.

12 AF. A convenience for measuring frequency difference between signals (see Operational Procedure). When selected, the frequency readout goes to zero. It will then read out the deviation from this reference as the FREQUENCY is tuned.

492P Option 11 Only. When the SHIFT button, (14), and (12) are pressed, the secondary function of the Δ F pushbutton, **DEGAUSS**, is activated (shown on the frontpanel in blue lettering). See description of **DEGAUSS** below.

13 CAL. When activated, the frequency readout can be calibrated to center frequency by adjusting the FREQUENCY control for the correct reading. When calibrated, deactivate the CAL mode.

14 DEGAUSS. When the DEGAUSS button is pressed, current through the tuning coils of the YIG oscillator (1st LO) and YIG preselector (when installed) is reduced to zero to minimize hysteresis effects. This enhances center frequency and display amplitude accuracy. DEGAUSS does not function when the **FREQ SPAN/DIV** is less than 1 MHz/Div. Degauss the tuning coils after a significant frequency change and before calibrating the center frequency readout.

SHIFT. 492P Option 11 Only. This button when pressed, will allow activation of the secondary functions of the AF button, and the **AUTO PEAK** pushbutton. **SHIFT** is displayed on the crt to show that the front panel keys are shifted to their blue lettered function. Pressing **SHIFT** again will cancel the **SHIFT** mode. The secondary function of the AF button is **DEGAUSS**; the secondary function of the **AUTO PEAK** button is **EXTernal MIXER**.

15 IDENTIFY 500 kHz ONLY. Signal identify feature is functional only when the **FREQ SPAN/DIV** is 500 kHz. When activated (button lit) true signals

will change amplitude each sweep; images and spurious response signals will shift horizontally or off screen. To ensure that the signal is changing amplitude every sweep, decrease the sweep rate so each sweep can be analyzed; or, if the instrument has digital storage, activate SAVE A, VIEW B.

When the true signal is centered under the dot marker after degauss, the FREQUENCY readout is the signal frequency (within specification). Degauss by pressing DEGAUSS at FREQ SPAN/DIV setting of 1 MHz or 2 MHz.

- 16 **PHASE LOCK (Option 03).** The 1st LO is locked to a stable internal reference and the 2nd LO swept to reduce residual FM in narrow spans; the button lights when phase lock is active. In narrow spans phase lock can be turned off or back on by pressing the button. Spans for which the microcomputer automatically selects phase lock are:

Band	Span/Div
1, 2, 3	50 kHz and below
4	100 kHz and below
5 and above	200 kHz and below

Switching PHASE LOCK off may cause the signal to shift position. In narrow spans the signal could shift off screen. The signal will usually return to its phase locked position after a few moments.

- 17 **AUTO RESOLUTION.** This is a pushbutton that activates automatic bandwidth selection for the selected FREQ SPAN/DIV and TIME/DIV and VIDEO FILTER. An internal microcomputer selects bandwidth to maintain a calibrated display. When the TIME/DIV is in AUTO mode, resolution bandwidth becomes a function of the FREQ SPAN/DIV selection.

- 18 **FREQUENCY SPAN/DIV.** This is a continuous detented control that selects frequency span/div. Span/div is indicated by the crt readout. Range of the span/div selection depends on the frequency band and options. Table 3-1 lists the range for the various bands and options. Selection is a 1-2-5 sequence plus MAX span and 0 Hz span positions.

When MAX span is selected, the span displays the full band. Sweep beyond the band is clamped to the baseline. A dot marker near the top of the screen indicates the position on the span of the crt frequency readout. This dot and the frequency point will be center screen when the FREQ SPAN/DIV is reduced below MAX span position. When zero span is selected Time/Div is read out instead of Span/Div.

- 19 **RESOLUTION BANDWIDTH.** This is also a continuous detented control that selects resolution bandwidth. Bandwidth is indicated by crt readout. Range of selection is 1 kHz to 1 MHz in decade steps. An additional resolution bandwidth of 100 Hz, when Option 03 is installed, is provided. Changing the resolution bandwidth with this control deactivates AUTO RESOLUTION.

- 20 **VERTICAL DISPLAY.** These four pushbuttons select the display mode. The crt readout indicates scale factor.

10 dB/DIV—When activated, the dynamic range of the display is a calibrated 80 dB with each major graticule representing 10 dB.

2 dB/DIV—Increases resolution so that each major graticule division represents 2 dB.

LIN—Selects a linear display between zero volt (bottom graticule line) and the reference level (top graticule line) scaled in volts/division. See REFERENCE LEVEL.

Table 3-1
SPAN/DIV RANGES VERSUS BAND AND OPTION

Band	Narrow Span/Div		Wide Span/Div
	Standard	Option 03	All Instruments
1—3 (0—7.1 GHz)	10 kHz	500 Hz	200 MHz
4—5 (5.4—21 GHz)	50 kHz	500 Hz	500 MHz
6 (18—26 GHz)	50 kHz	500 Hz	1 GHz
7—8 (26—60 GHz)	100 kHz	500 Hz	2 GHz
9 (60—90 GHz)	200 kHz	500 Hz	2 GHz
10 (90—140 GHz)	500 kHz	500 Hz	5 GHz
11 (140—220 GHz)	500 kHz	500 Hz	10 GHz

PULSE STRETCHER—Increases the fall time of pulse signals so very narrow pulses in a line spectrum display can be seen. The effect is most apparent for discrete signals analyzed at resolution bandwidths that are narrow compared to the span; PULSE STRETCHER may be necessary for digital storage of such signals, especially if they are averaged.

21 **VIDEO FILTER.** One of two (NARROW and WIDE) filters can be activated to reduce the video bandwidth and reduce high frequency components for display noise averaging. The NARROW filter is approximately 1/300th of the selected resolution bandwidth; the WIDE filter is about 1/30th the bandwidth. Activating either filter cancels or deactivates the other filter. Press the pushbutton to switch the filters off.

22 **DIGITAL STORAGE** (Option 02). Five pushbuttons and one control operate the digital storage functions. With none of the pushbuttons activated, the 492/492P display is not stored.

VIEW A, VIEW B—When either or both of these pushbuttons are selected, the pushbutton illuminates and the contents of memory A and/or memory B are displayed. With Save A mode off, all memory locations are displayed and updated continuously. Data in A memory is interlaced with data from B memory.

SAVE A—When activated, this mode holds data in A memory and inhibits further updating. With SAVE A and VIEW A active, data in A memory is displayed but not updated, serving as a reference to compare contents of B memory.

B—SAVE A—When activated, the differential (arithmetic difference) of data in B memory and the saved data in memory A is displayed. SAVE A mode is activated and SAVE A button illuminated. The zero difference point is nominally set at the middle graticule line with positive differences displayed above this line and negative differences below. (The zero difference position on screen is internally switch selectable.)

MAX HOLD—When activated the digital storage memory retains the maximum signal amplitude at each memory location. This permits visual monitoring of signal frequency and amplitude at each memory location over an indefinite period of time. This feature is used to measure drift, stability, and record peak amplitudes.

PEAK/AVERAGE—This control selects the amplitude at which the vertical display is either peak de-

tected or averaged. Video signals above the level set by the control (shown by a horizontal line or cursor), are peak detected and stored; video signals below the cursor are digitally averaged and stored. See Peak/Average Control (Digital Storage) under General Information.

23 **MIN RF ATTEN/REFERENCE LEVEL.** Concentric controls that set the analyzer reference level and minimum RF input attenuation, see below:

REFERENCE LEVEL. Continuous control that requests the microcomputer to change the reference level one step for each detent. In the 10 dB/DIV Vertical Display mode, the steps are 10 dB and 1 dB when FINE is activated. In the 2 dB/DIV mode, the steps are 1 dB or 0.25 dB for the FINE mode. When FINE is activated in the 2 dB/DIV mode, the ΔA mode is operational. The REFERENCE LEVEL goes to 0.00 dB then steps in 0.25 dB increments from an initial 0.00 dB reference level.

MIN RF ATTEN dB. selects the lowest value of attenuation allowed; actual RF attenuation is set by the microcomputer according to the algorithm selected by the MIN NOISE/MIN DISTORTION button. If RF attenuation is increased by changing MIN RF ATTEN, the microcomputer automatically changes IF gain to maintain the current reference level.

24 **UNCAL.** This indicator lights when the display amplitude is no longer calibrated (e.g., selecting a sweep rate that is not compatible with the frequency span/div and resolution bandwidth).

25 **LOG and AMPL CAL.** These adjustments calibrate the dynamic range of the display. The LOG calibrates the logarithmic gain in dB/Div, the AMPL calibrates the reference level of the top graticule line at the top of the screen.

26 **FINE.** When activated, REF LEVEL switches in 1 dB increments for 10 dB/DIV display mode, and 0.25 dB for 2 dB/DIV display mode. In the 2 dB/DIV display mode, FINE activates ΔA mode. See Delta A Mode description under General Operating Information.

Vertical Display Mode	FINE Increment
10 dB/DIV	1 dB
2 dB/DIV	0.25 dB (AA mode) ^a
LIN	Voltage equivalent to 1 dB

^aFor AA mode description see Delta A Mode under General Operating Information.

- (27) **MIN NOISE/MIN DISTORTION.** One of two algorithms is selected to control attenuator and IF gain. **MIN NOISE** (button illuminated) reduces the noise level by reducing attenuation 10 dB and reducing IF gain 10 dB. **MIN DISTORTION** reduces IM distortion due to input mixer overload. To observe any change, the **RF ATTEN**, displayed by the CRT readout, must be 10 dB higher than that set by the **MIN RF ATTEN** selector.

In **MIN DISTORTION** mode (button not illuminated) distortion is minimum.

- (28) **POWER.** Pull type switch that switches the main power supply on.
- (29) **RF INPUT.** A 50 Ω coaxial input connector for signals 21 GHz or below. With 0 dB attenuation, the maximum input level is limited to +13 dBm by the input mixer.



With 20 dB or more attenuation the maximum input level is limited to +30 dBm (1 watt average, 75 watts peak, pulse width 1 μs, with a duty cycle that does not exceed 0.001). Burn-out occurs above 1 watt.

*If **MIN NOISE** is activated and **RF ATTEN** is 60 dB, the +30 dBm rating could be exceeded. If the input signal level is increased for a full screen display the input level will be +40 dBm. Reduce high level signals with external attenuators. Use external attenuators and the **MIN RF ATTEN** to reduce the level into the 1st mixer to -10 dBm or less. Input voltage to the input mixer must not contain any dc component. Refer to Signal Application (under General Operating Instructions) discussed later in this section.*

- (30) **POSITION** . These controls position the display on the horizontal and vertical axes.
- (31) **CAL OUT** (Calibrator output). The source of a calibrated -20 dBm (±0.3 dB) 100 MHz (±0.01%) signal, and a comb of frequency markers 100 MHz apart. The calibrated 100 MHz marker is used as a reference for calibrating reference level and log scale. The comb of 100 MHz markers is used to check span and frequency readout accuracy.
- (32) **OUTPUT** 1st and 2nd LO. These connectors provide access to the output of the respective local oscillators. The connectors must be terminated into 50 Ω when they are not connected to some external device.

- (33) **EXT MIXER.** When the **EXT MIXER** button is activated, bias is provided out the **EXT MIXER** port for external waveguide mixers. The IF output from the external mixer is then applied through the **EXT MIXER** port to the 2nd converter. External mixer connection and operation is described under General Operating Information.



Do not exceed mixer input limits. Refer to the external mixer operating instructions at the end of the General Operating Information part of this section.

NOTE

*Option 08 instruments do not have **EXT MIXER** provision.*

492P Option 11 Only. When the **SHIFT** button and (33) are pressed, the secondary function of the **AUTO PEAK** pushbutton, **EXTernal MIXER**, is activated (shown on the frontpanel in blue lettering). State of the **EXTernal MIXER** can be determined from the **RF ATTENUation** readout. If a number is displayed, **EXTernal MIXER** is off, if **EXT** is displayed, **EXTernal MIXER** is on. See description of **EXT MIXER** above.

AUTO PEAK. 492 Option 11 Only. When turned on, if a signal is present within the center two horizontal divisions of the screen, the processor will run an auto peaking algorithm once. This algorithm will **adjust** the peaking of the analyzer to maximize the amplitude of the signal in the center two divisions. If no signal is present, the instrument still performs **AUTOPEAK**, but it will default to the previous peak adjustment.

The resulting peak setting is stored in memory to be used when that particular band is used, and **AUTO PEAK** is on. For initial preselector peaking on bands 2, 3, and 4, couple the second LO output to the **RF INPUT** via a short coaxial cable and the **SMA-to-type-N** adapter which is supplied as a standard accessory with Option 11. This calibration will be required each time the instrument is powered up. When using the instrument in external mixer bands, the **AUTO PEAK** algorithm needs to be run on each signal of interest, as no peak setting is stored in memory. Pressing **AUTO PEAK** again at any time will cause an auto peaking operation to be aborted, if one is in progress. It will also turn the auto peak function off, which causes the internal peaking circuitry to be driven by the front-panel **MANUAL PEAK** knob.

Auto Peaking is useful when switching between bands, and a signal is not available in the new band. If previously calibrated after power up as described above, a nominal peaking value will be used for each band. So for most measurements, peaking of individual signals is not required. If accurate amplitude measurements are desired, re-run Auto Peak for the signal to be measured by pressing the button to turn Auto Peak off, then turning it on, or return to the manual mode by pressing the button a second time and peak the response with the MANUAL PEAK control.

- 34 PEAKING. This control varies mixer bias for external mixers in the EXT MIXER mode. If the 492/492P has a preselector (Option 01), the control also adjusts the preselector tracking for the 1.7 to 21 GHz frequency range (Bands 2—5). In both cases it is adjusted for maximum signal amplitude. Refer to External Mixer Operation for more detailed information.

Rear Panel (Fig. 3-2)

- C PROBE POWER. The PROBE POWER connector on the rear panel of this instrument provides operating power for active probe systems. It is not recommended that these connectors be used as a power source for applications other than the compatible probes or other accessories which are specifically designed for use with this source.

- 2 EXT IN HORIZ/TRIG. DC coupled input for horizontal drive voltages and ac coupled for trigger signal. A 0 to +10 volt ramp produces full sweep. 1.0 to 50 volt peak signals are required for trigger (0.1 μ s minimum pulse width), 15 Hz to 1 MHz. Selection as to HORIZ or TRIG mode depends on front panel TRIGGERING and TIME/DIV selections.

- 3 MARKER/VIDEO (B053575 and up) or EXT PRESELECTOR (B053574 and below). MARKER/VIDEO interfaces the 492/492P with a TV Sideband Adapter, such as Tektronix 1405, so a marker from the adapter is displayed on the internal video. External video applied to this connector will also be displayed if pin 1 of the ACCESSORIES connector is grounded.

EXT PRESELECTOR provides a variable voltage (approximately -0.2 V to +10 V) that is proportional to center frequency, for preselector bands of Option 01 instruments, to drive an external preselector.

In OPTION 42 instruments, this port is relabeled and provides 110 MHz IF output with a bandwidth greater than 5 MHz. External video signals used for calibration purposes may be injected into the PEN LIFT connector. See 6 PEN LIFT. This port is not compatible with a TV Sideband Adapter.

- C HORIZ (output). Source of a signal that is 0.5 V for each division of display.
- 5 VERT (output). Source of a signal that is 0.5 V for each division of display. If signal is used to drive a chart recorder, digital storage should be off. If signal drives a slave monitor and PEN LIFT is used for blanking, the screen will blank during retrace time.
- 6 PEN LIFT. TTL compatible, nominal +5 V provided to lift the pen of a chart recorder.

In OPTION 42 instruments this port may also be used for inputting external video, if pin 1 of the ACCESSORIES connector is grounded.



High level signals (such as a line voltage) previously injected into the VIDEO/MARKER connector may cause damage to the output amplifier if injected into the 110 MHz output.

- C 10 MHz IF (+20 dBm max). Access to the 10 MHz IF signal. Output level is about -10 dBm with a full screen signal at -30 dBm reference level, maximum output is +20 dBm.

- C J104 ACCESSORY. For instruments B053575 and up, this connector provides bi-directional access to the 492P instrument bus. It is not RS-232 compatible. TTL logic 0, applied to pin 1, will select External Video which connects video signals, applied to the rear panel MARKER/VIDEO connector, to the video path ahead of the video filters. Pins 2 and 3 provide the output and return lines to drive an external preselector for instruments that have Option 01.

For instruments B053574 and below, this connector has no application.

- C GPIB Connector—(492P Only). This interfaces the 492P with a GPIB bus. Connect the GPIB cable after the instrument is switched on to avoid interference on the bus.

TURN ON PROCEDURE AND PREPARATION FOR USE

The following procedure initiates a display and calibrates center frequency readout, display reference level, and dynamic range.

1. Initial Turn On

a. Connect the 492/492P power cord to an appropriate power source (see Power Requirements under Installation instructions) and switch POWER on. Allow three to four minutes for the instrument to warm up and stabilize before proceeding. Note that the crt readout is functioning (see Fig. 3-3).

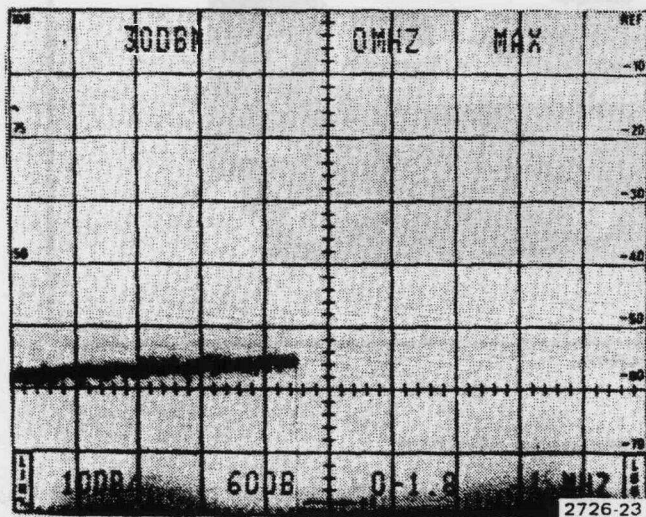

Fig. 3-3. Crt readout for power-up state.

When POWER is switched on (power up), the operating functions and modes of the 492/492P initialize to the following "power up" state:

FREQUENCY	0 MHz
VERTICAL DISPLAY	10 dB/DIV
REF LEVEL	+30 dBm
RF ATTENUATION	60 dB
FREQUENCY RANGE	0.0—4.2 GHz (0.0—1.8 GHz with Option 01)
AUTO RESOLUTION	On
RESOLUTION BANDWIDTH	1 MHz
FREQ SPAN/DIV	MAX
TRIGGERING	FREE RUN
READOUT	On
Digital Storage (Option 02)	VIEW A/VIEW B on
All other pushbuttons	Inactive or off

b. Set MIN RF ATTEN to 0 dB and PEAK/AVERAGE control fully ccw. Set the TIME/DIV to AUTO, the REFERENCE LEVEL to -20 dBm, and adjust the INTENSITY for a display with the desired brightness. Note, the RF ATTEN readout is now 10 dB.

c. Apply the CAL OUT to the RF INPUT by connecting a 50 n coaxial cable between the CAL OUT connector and the RF INPUT.

d. In the MAX frequency span mode, a dot marker in the upper portion of the screen indicates the location on the display to which the 492/492P center frequency is tuned. With a frequency readout of 0 MHz, it will be in the upper left portion of the screen. Adjust the center FREQUENCY control and note the dot marker move across the display.

e. Note the comb of 100 MHz markers at the left side of the display (see Fig. 3-4). Tune the dot marker to a position above the first 100 MHz marker.

f. Change the FREQ SPAN/DIV to 100 MHz. Note that the dot marker is now centered horizontally and the 100 MHz signal is at or near center screen.

g. Position the dot marker to the graticule centerline with the horizontal (◀ ▶) POSITION control. Adjust the center frequency control to tune the signal over the dot marker.

h. Press the 2 dB/DIV Vertical Display button, then position the baseline of the display to the bottom graticule line with the vertical (▲ ▼) POSITION control.

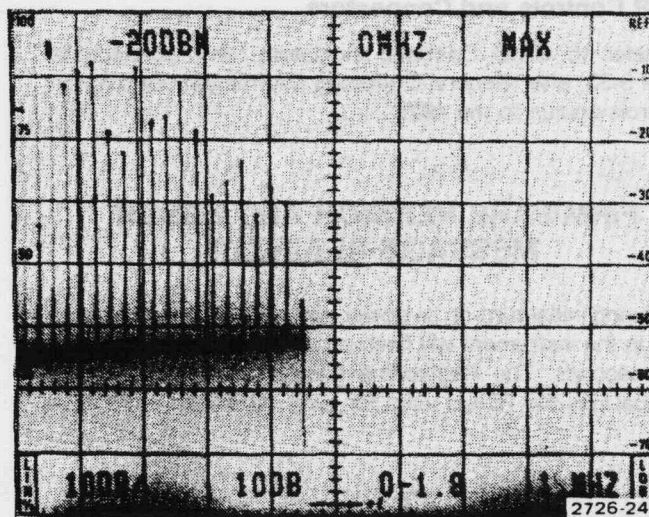

Fig. 3-4. Typical display of calibrator markers in MAX SPAN position.

2. Calibrate Center Frequency Readout

a. Change the Vertical Display to 10 dB/DIV. If the instrument has phase lock, ensure that the PHASE LOCK is deactivated or the FREQ SPAN/DIV is above 50 kHz (recommended setting of 100 MHz).

b. Tune the FREQUENCY to place the 100 MHz calibrator signal over the center-span dot marker. Reduce FREQ SPAN/DIV to 1 MHz, press the DEGAUSS button, and fine tune center frequency.

NOTE

Degauss function is inoperative when the FREQ SPAN/DIV is less than 1 MHz.

c. Press the CAL button to activate the calibration function (button illuminated); then adjust the FREQUENCY tuning control for a readout of 100 MHz. Press the CAL button to deactivate the CAL mode and increase FREQ SPAN/DIV to 20 MHz.

d. **Check—center frequency accuracy** at other multiples of the 100 MHz calibrator signal. Approach each check point from the low frequency side and degauss the tuning coils of the oscillator as each check point is approached. Readout should be within $\pm(5 \text{ MHz} + 20\% \text{ span/div})$ or $\pm(0.2\% \text{ of center frequency} + 20\% \text{ of span/div})$ whichever is greater.

e. Return the frequency to 100 MHz.

3. Calibrate Reference Level and Dynamic Range

a. With the 100 MHz calibrator signal tuned to center screen and the REF LEVEL at -20 dBm , set the FREQ SPAN/DIV to 20 kHz, as indicated by the crt readout.

b. Alternately switch Vertical Display from 10 dB/DIV to 2 dB/DIV and adjust AMPL CAL so the peak amplitude of the signal is the same for each logarithmic display mode.

c. With the Vertical Display mode at 10 dB/DIV, set the top of the calibrator signal to the top graticule line with the LOG CAL adjustment so the top graticule line is a calibrated -20 dBm .

d. **Check—the display log scale** over 50 dB of dynamic range by switching REF LEVEL in 10 dB steps from

-20 dBm to $+30 \text{ dBm}$ and noting that the display amplitude decreases 10 dB or one division per step.

e. Set the REF LEVEL at -20 dBm and the Vertical Display to 2 dB/DIV.

f. With the REF LEVEL selection in coarse mode, change the REF LEVEL to -10 dBm in 1 dB steps. Check that the amplitude and REF LEVEL readout reduces 1 dB/step for a total of $10 \text{ dB} \pm 1.3 \text{ dB}$.

g. Return the REF LEVEL to -20 dBm and activate FINE for the ΔA mode. Note signal amplitude.

h. Change the REF LEVEL $+2 \text{ dB}$. Check that the REF LEVEL readout changes in 0.25 dB steps and the display amplitude decreases $2 \text{ dB} \pm 0.4 \text{ dB}$ (1 division ± 1 minor division) to match the 2 dB change in readout. Return the REF LEVEL to 0.00 dB.

i. Change the display mode to 10 dB/DIV, switch the REF LEVEL from -20 dBm to -10 dBm . Check that the REF LEVEL changes in 1 dB increments and the total change in display amplitude is $10 \text{ dB} \pm 1.0 \text{ dB}$ (1 division ± 0.5 minor division).

j. Return the REF LEVEL to -20 dBm and cancel FINE for coarse steps.

4. Check Span Accuracy and Linearity

Span accuracy is the displacement error of calibrator markers from the center reference over ± 4 divisions of span. Linearity is the displacement error of markers from their specified points over the display area, with the 1st graticule line as the reference.

a. Set the FREQ SPAN/DIV to 50 MHz and the frequency to about 500 MHz. Tune the 500 MHz calibrator marker to center screen so it is below the center frequency dot marker.

b. Check span accuracy by noting that the 100 MHz markers are within 5% of their reference graticule line over the center eight divisions.

c. Tune one of the markers to the 1st graticule line. Check linearity by noting that the displacement between successive markers over the center eight divisions and from the left edge, with respect to the FREQ SPAN/DIV setting over the display area, does not exceed 5%.

conditions determined by TRIGGERING are met. Single sweep mode is canceled when any TRIGGERING button is pressed. The effect of SINGLE SWEEP may be more apparent if VIEW A, VIEW B, and B-SAVE A are off.

TIME/DIV. Selects sweep rate and manual scan operation. In MNL position, MANUAL SCAN control should vary the crt beam across the full horizontal axis of the crt graticule.

VERTICAL DISPLAY. Display modes are activated by three pushbuttons. Pressing any of these buttons cancels the other mode.

10 dB/DIV. Active, display is a calibrated 10 dB/division, 80 dB dynamic range. Calibration is checked later in this procedure.

2 dB/DIV. Active, display is calibrated 2 dB/division, 16 dB dynamic range. Calibration is checked later in this procedure.

LIN. Active, display is linear between the reference level (top of graticule) and zero volt (bottom of graticule); the crt VERT DISPLAY reads out in volts/division.

PULSE STRETCHER. Active, increases the fall time of video signals to make narrow pulses on the display easier to see. With **FREQ SPAN/DIV** at MAX, **TIME/DIV** at 5 ms and Digital Storage off, the markers should increase in brightness when PULSE STRETCHER is active.

VIDEO FILTER. Two filters, independently selected to provide WIDE (1/30th) or NARROW (1/300th) of the resolution bandwidth for noise reduction.

DIGITAL STORAGE (Option 02). Either or both sections of memory can be selected to provide digital storage. When either or both are activated, signal amplitude should remain constant. Vary the PEAK/AVERAGE control and note that noise level below the PEAK/AVERAGE cursor is averaged.

VIEW A. Active, half of digital storage memory is displayed.

VIEW B. Active, the B section or other half of memory is displayed.

When both VIEW A and VIEW B are active, contents of A and B memory are interlaced and displayed. Both sections are updated each sweep. Update of A memory depends on the state of SAVE A.

SAVE A. Active, contents in A memory are saved and not updated. Verify operation by changing REF LEV-

EL and observe that the VIEW A display does not change when VIEW B is inactive.

MAX HOLD. Active, stores maximum signal amplitude at each memory location. Verify operation by changing FREQUENCY or REF LEVEL and note that the maximum level at each location is retained.

B-SAVE A. Active, the difference between updated data in B section of memory and that saved in A is displayed. Verify by saving data in A, then changing the reference level and pressing B-SAVEA; only the difference can be observed by canceling VIEW A and VIEW B. The reference (zero difference) level is normally set at graticule center, but can be internally adjusted by service personnel.

PEAK/AVERAGE. When digital storage is activated with VIEW A or VIEW B, this control positions a horizontal line or cursor on the display. Signals above the cursor are peak detected; signals below the cursor are averaged. The cursor should position anywhere within the graticule window.

IDENTIFY 500 kHz/ONLY. When activated, the FREQUENCY SPAN must be 500 kHz/div. True signals change amplitude, spurious signals shift horizontally. Set **FREQ SPAN/DIV** at 500 kHz and press the button. Note the action of the calibrator marker. True signals should not shift horizontally.

PHASE LOCK (Option 03). Active to reduce residual FM when narrow spans are selected. The button lights when active; pressing the button turns phase lock off. The microcomputer automatically selects phase lock for a span/division of 50 kHz or below in bands 1 through 3, 100 kHz or below in band 4, and 200 kHz or below in bands 5 and above.

AUTO RESOLUTION. When activated, RESOLUTION BANDWIDTH changes so bandwidth is compatible with **FREQ SPAN/DIV** selection. Check by changing **FREQ SPAN/DIV** and noting that RESOLUTION BANDWIDTH changes. UNCAL indicator should not light over the **SPAN/DIV** range if **TIME/DIV** selector is in AUTO position.

FREQUENCY SPAN/DIV. As this control is rotated clockwise or counterclockwise, frequency span/div should change between 0 and MAX span. Display should indicate this change.

RESOLUTION BANDWIDTH. As this control is rotated, resolution bandwidth should range from 1 MHz to 1 kHz (100 Hz Option 03) in decade steps.

ΔF. When activated, center frequency readout initializes to 0 MHz. The frequency difference, to a desired signal or point on the display, can now be determined by tuning that point to center screen and noting the readout. Check by measuring the difference between calibrator markers. Deactivate and note that the readout returns to center frequency. If the frequency is tuned below "0", the readout will indicate (-) sign.

DEGAUSS. When pressed, hysteresis in the local oscillator tuning system is reduced. Switch **FREQ SPAN/DIV** to 1 MHz and tune the calibrator marker to center screen. Note the signal position, then press the **DEGAUSS** button. The signal should shift horizontally and then return to a new location. Press again and the signal should return to the same new location. Return **FREQ SPAN/DIV** to 100 MHz.

FREQUENCY RANGE. Two pushbuttons that shift the 492/492P frequency bands. Press the **A** button and note the up shift of bands; then press the **T** button and note that the bands shift down to the 0 to 4.2 GHz range (0 to 1.8GHz Option 01).

CAL. Checked when performing Turn On Procedure.

REFERENCE LEVEL. Continuous control that requests the microcomputer to change the reference level one step for each detent. In the 10 dB/DIV Vertical Display mode, the steps are 10 dB. When **FINE** is activated, the steps are 1 dB. In the 2 dB/DIV mode, the steps are 1 dB or 0.25 dB for the **FINE** mode. When **FINE** is activated in the 2 dB/DIV mode, the **ΔA** mode is operational. The **REFERENCE LEVEL** goes to 0.00 dB then steps in 0.25 dB increments from an initial 0.00 dB reference level.

Set the **MIN RF ATTEN** to 0 dB, Vertical Display to 10 dB/DIV, and rotate the **REFERENCE LEVEL** control counterclockwise to +30 dBm then clockwise to -120 dBm. Note the change in the display. Return the **REF LEVEL** to -20 dBm and note that the 10dB of **RF ATTEN** is switched in at -20 dBm.

MIN RF ATTEN. Sets the minimum amount of RF attenuation. Changing **REF LEVEL** will not decrease RF attenuation below that set by the **MIN RF ATTEN** selector.

FINE. When activated, **REF LEVEL** switches in 1 dB increments for 10 dB/DIV display mode, and 0.25 dB for 2 dB/DIV display mode. In the 2 dB/DIV display mode, **FINE** actuates **ΔA** mode. See Delta A Mode description under General Operating Information.

MIN NOISE/MIN DISTORTION. One of two algorithms is selected to control attenuator and IF gain. **MIN NOISE** (button illuminated) reduces the noise level by reducing attenuation 10 dB and decreasing IF gain 10 dB. **MIN DISTORTION** reduces IM distortion due to input mixer overload. To observe any change, the **RF ATTEN**, displayed by the **crt readout**, must be 10 dB higher than that set by the **MIN RF ATTEN** selector.

UNCAL. This light comes on when the display is uncalibrated. Set the **TIME/DIV** to 50 ms, deactivate the **AUTO RESOLUTION**, and set the **RESOLUTION BANDWIDTH** to 10 kHz. **UNCAL** should light and remain lit until the **FREQ SPAN/DIV** is reduced to 200 kHz or the **RESOLUTION BANDWIDTH** is increased to 1 MHz. Return the **TIME/DIV** to **AUTO** and decrease the **AUTO RESOLUTION**. Set the **FREQ SPAN/DIV** to 100 MHz.

EXTERNAL MIXER/PEAKING. In active mode, bias for external waveguide mixers is provided at the **EXT MIXER** connection. Activate the External Mixer mode by changing the **FREQUENCY RANGE** to 18—26GHz and then measure the bias with a **VOM** between the center conductor and ground of the **EXT MIXER** port. Bias should range from about -2.0 to +1.0 volts as the **PEAKING** control is varied.

If the instrument has preselector (Option 01), the control also varies the preselector tuning to augment tracking for the coaxial bands (0—21 GHz).

FOR 492P ONLY. Check remote operation of the **PEAKING** control using a 4050-Series controller connected to the 492P on the **GPIB**. Instead of manually varying the bias voltage with the **PEAKING** control, enter and run the following program. (It is assumed the **GPIB ADDRESS** switches are set for a value of 1.)The program waits for you to enter values of 0 to 1028—the full range of the control. Measure the voltage in the same manner as above. Press **BREAK** twice to stop the program.

```
100 INPUT A$
110 PRINT @1:"PEAK";A$
120 GO TO 100
```

If the 492P is an Option 08 (no external mixer capability) and Option 01 (preselector) instrument, remote operation of the **PEAKING** control can be checked by watching its effect on a displayed signal.

1. Select Band 2 and tune to a harmonic of the **CAL OUT** signal (connected to the **RF INPUT**).

2. Vary PEAKING for best signal response (greatest amplitude).

3. Change PEAKING to reduce signal response.

4. Running the same program as above, enter the argument AUTO instead of a number. Observe that signal amplitude is restored to the value you obtained in step 2.

This completes the functional check of the front panel controls and pushbuttons.

AUTO PEAK. 492 Option 11 only. Pressing AUTO PEAK runs an automatic peaking routine once, then sets the peaking setting to the value obtained. The manual PEAK knob is disabled. The signal to be peaked must be within the center two horizontal divisions. Connect a cable from the 2nd LO output to the RF INPUT, and tune to the signal at 2182 MHz. Span down to 10 MHz/DIV, and center the signal. Press AUTO PEAK and note that PEAKING is displayed on the crt, and several sweeps are taken with varying peaking settings. After a number of sweeps the normal readout returns, and the signal is peaked. Change the frequency range to another band, then back to Band 2. Note that the signal is still peaked. Pressing SHIFT EXTERNAL MIXER will switch to the external mixer mode.

2. Check Frequency Readout Accuracy

Readout accuracy $\pm(5 \text{ MHz} + 20\% \text{ of span/division})$ or $\pm(0.2\% \text{ of center frequency} + 20\% \text{ of span/division)$, whichever is greater.

NOTE

Due to hysteresis in the 1st (YIG) oscillator, accuracy of the frequency readout should be checked after the

tuning coil has been degaussed by pressing the DEGAUSS button with the FREQ SPAN/DIV at either 2 MHz or 1 MHz. before reducing the FREQ SPAN/DIV to narrower span settings.

a. Calibrate the frequency readout as described under Initial Operation. Now check frequency readout accuracy by tuning to successive 100 MHz calibrator markers. As a given marker is tuned toward center screen, degauss the oscillator tuning coils by pressing the DEGAUSS button with the FREQ SPAN/DIV either at 2 MHz or 1 MHz. Reduce the FREQ SPAN/DIV to 500 kHz and center the marker under the frequency dot before noting the readout for center frequency. Readout should be within $\pm(5 \text{ MHz} + 20\% \text{ of span/division})$ of the calibrator marker; for example, the 10th marker should represent 1 GHz. In Bands 2 and 3 it may be necessary to activate WIDE Video Filter and MIN NOISE. Set the FREQ SPAN/DIV to 10 MHz and use RESOLUTION BANDWIDTH of 100 kHz. Adjust PEAKING, if the 492/492P has Option 01 (preselector), as you approach each check point. In some instruments, the calibrator harmonic signals may be very small. Either ignore these check points or try reducing the resolution bandwidth more to increase sensitivity. Sweep time must be very long when using narrow resolution bandwidths.

b. Since the other bands operate on harmonics of the oscillator fundamental, accuracy or error will be the same as that measured for the fundamental band multiplied by the harmonic number (n) of the band or frequency range in use.

3. Check Frequency Span/Div Range and Accuracy

Range is in a 5-10-20 sequence and depends on frequency band and option as shown in Table 3-2.

Span accuracy specifies the maximum displacement error of calibrator markers from the center screen reference

**Table 3-2
NARROW AND WIDE SPANS VERSUS FREQUENCY BAND**

Band	Narrow Span		Wide Span
	Standard	Option 03	AM Instruments
1—3	10 kHz/Div	500 Hz/Div	200 MHz/Div
4—5	50 kHz/Div	500 Hz/Div	500 MHz/Div
6	50 kHz/Div	500 Hz/Div	1 GHz/Div
7—8	100 kHz/Div	500 Hz/Div	2 GHz/Div
9	200 kHz/Div	500 Hz/Div	2 GHz/Div
10	500 kHz/Div	500 Hz/Div	5 GHz/Div
11	500 kHz/Div	500 Hz/Div	10 GHz/Div

Accuracy: Within 5% of selected span/div over center 8 divisions of display.

Operation—492/492P Operators

over the center 8 divisions of span. Linearity is the displacement error between successive markers with respect to the FREQ SPAN/DIV setting over the center 8 divisions of span.

a. Tune the center FREQUENCY to the 1.0 GHz (900 MHz for Option 01 instruments) calibrator harmonic signal and set the REF LEVEL at -30 dBm. Set the FREQ SPAN/DIV to 200 MHz and activate AUTO RESOLUTION.

b. Check—for 2 GHz (1.8 GHz Option 01) of span. Check span/div accuracy by noting marker displacement from the respective graticule line. Deviation should not exceed 5% or 2 minor divisions.

c. Check—the range and accuracy for FREQ SPAN/DIV selections to 10 MHz using the calibrator 100 MHz comb of markers as the reference.

d. Change FREQUENCY RANGE and check range for all bands as per specification. Accuracy will remain consistent with that noted in part b of this step.

4. Check Resolution Bandwidth and Shape Factor (bandwidth, 1 kHz to 1 MHz $\pm 20\%$ in decade steps; shape factor, 7.5:1 or less)

a. Tune the center frequency to 100 MHz and center the 100 MHz calibrator signal. Set the REF LEVEL to -20 dBm. FREQ SPAN/DIV to 500 kHz, RESOLUTION BANDWIDTH to 1 MHz, TIME/DIV to AUTO, Vertical Display mode to 2 dB/DIV, and MIN NOISE on.

b. Measure the 6 dB bandwidth (see Fig. 3-5A). Bandwidth should equal 1 MHz ± 200 kHz.

c. Change the Vertical Display mode to 10 dB/DIV.

d. Measure the -60 dB bandwidth (see Fig. 3-5B). Calculate the shape factor by dividing the -60 dB bandwidth by the -6 dB bandwidth. The shape factor should equal 7.5:1 or less.

e. Switch RESOLUTION BANDWIDTH to 100 kHz and the FREQ SPAN/DIV to 100 kHz.

f. Check the bandwidth and shape factor of the 100 kHz filter by repeating the foregoing procedure.

g. Switch the RESOLUTION BANDWIDTH to the remaining selections, adjusting the FREQ SPAN/DIV as necessary to check the bandwidth and shape factor of each selection. Bandwidth should be within 20% of that selected and the shape factor 7.5:1 or better.

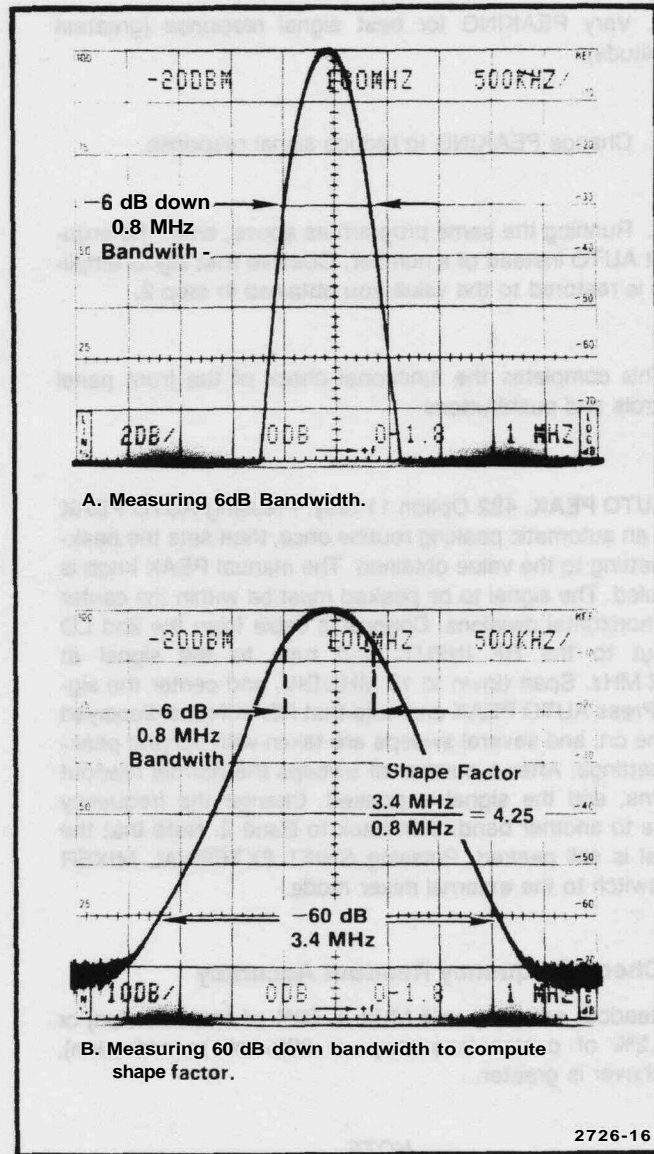

Fig. 3-5. Displays that illustrate how bandwidth and shape factor are determined.

NOTE

This procedure checks functional operation but does not verify accuracy. If deviation seems significant, refer to qualified service personnel for a performance check.

5. Check Reference Level Gain and RF Attenuator Steps

a. With the calibrator signal applied to the RF INPUT, set the front panel controls as follows:

FREQUENCY RANGE	Band 1 (0—4.2 or 0—1.8 Option 01)
FREQ SPAN/DIV	10 MHz
RESOLUTION BANDWIDTH	1 MHz

Video Filter	NARROW
Vertical Display	10 dB/DIV
RF LEVEL	-30 dBm
MIN RF ATTEN	0 dB
TIME/DIV	AUTO
MIN NOISE	ON

6. Check Sensitivity (refer to Table 3-3 or 3-4)

NOTE

Sensitivity is specified according to the input mixer average noise level. The 492/492P calibrator signal is the reference used to calibrate the display. Accuracy of the calibrator output level can be verified using a 100 MHz bandpass filter with known loss and an accurate power meter.

b. Tune FREQUENCY to the 200 MHz marker, then decrease FREQ SPAN/DIV and RESOLUTION BANDWIDTH to 100 kHz, keeping the marker centered.

c. Check the attenuator by increasing REF LEVEL to 40 dBm in 10 dB steps, noting that the signal peak drops 1 division per step and RF ATTEN increases to 60 dB in 10 dB steps.

d. Return REF LEVEL to -20 dBm and increase MIN RF ATTEN dB to 60 dB, noting that the noise level rises about 1 division per step.

e. Check IF gain steps by switching REF LEVEL from -20 dBm to +40 dBm; observe that the signal peak and noise level decreases 1 division per step.

f. Activate FINE; then check that the trace rises in 1 dB (0.1 division) steps as REF LEVEL is changed to +30 dBm.

g. Switch FINE off and reduce MIN RF ATTEN dB to 0. Deactivate MIN NOISE and note that the noise level rises about 1 division as the RF ATTEN changes 10 dB (50 dB to 60 dB) when MIN NOISE is switched off (REF LEVEL should not change and the trace peak should remain relatively constant).

h. Adjust REF LEVEL to position the signal peak near the top of the graticule. Change Vertical Display mode to 2 dB/DIV.

i. Check that REF LEVEL and signal amplitude changes in 1 dB steps as the REFERENCE LEVEL control is rotated.

j. Turn on FINE and note that the REF LEVEL readout changes to *0.00 dB. This denotes the delta A mode. Check that REF LEVEL and signal amplitude changes in 0.25 dB steps as the REFERENCE LEVEL is rotated.

k. Switch FINE off and set REF LEVEL to a multiple of 10 dBm. Change Vertical Display mode to 10 dB/DIV.

a. Set the front panel controls as follows:

FREQUENCY RANGE	0.0—4.2 GHz (0.0—1.8 GHz, Option 01)
FREQUENCY	Within band 1
Vertical Display	10 dB/DIV
MI RF ATTEN dB	0
REF LEVEL	-30 dBm
FREQ SPAN/DIV	5 MHz
RESOLUTION BANDWIDTH	1 MHz
TIME/DIV	0.5 s
Digital Storage (Option 02)	VIEW A/VIEW B
MAX HOLD	Off
PEAK/AVERAGE Cursor	Fully cw
Video Filter	WIDE

b. Disconnect the calibrator signal from the RF INPUT.

c. Check—noise level below the -30 dBm reference level. Noise floor (level) should not be above that specified in Table 3-3 or 3-4.

d. Change REF LEVEL to -40 dBm, FREQ SPAN/DIV to 1 MHz, and RESOLUTION BANDWIDTH to 100 kHz.

e. Check—noise level of 100 kHz and 10 kHz resolution bandwidths. Compare these levels with those listed in Table 3-3 or 3-4.

f. Change the REF LEVEL to -60 dBm, FREQ SPAN/DIV to 10 kHz, VIDEO FILTER to NARROW, TIME/DIV to AUTO, and RESOLUTION BANDWIDTH to 1 kHz.

g. Check—average noise level for 1 kHz resolution bandwidth against that listed in Table 3-3 or 3-4.

h. If Option 03 is installed, change RESOLUTION BANDWIDTH to 100 Hz and FREQ SPAN/DIV to 500 Hz.

Table 3-3
SENSITIVITY WITHOUT PRESELECTOR

Frequency Range	Average Noise Level dBm (max)				Option 03
	1 MHz	100 kHz	10 kHz	1 kHz	100 Hz
100 kHz—4.2 GHz (Bands 1—3)	-85	-95	-105	-115	-123
5.4—18 GHz (Band 4)	-70	-80	-90	-100	-108
15—21.0 GHz (Band 5)	-65	-75	-85	-95	-103
18—26 GHz (Band 6) ^a	-70	-80	-90	-100	-108
26—40 GHz (Band 7) ^a	-65	-75	-85	-95	-103
40—60 GHz (Band 8) ^a	-65	-75	-85	-95	-103
60—90 GHz (Band 9)	Function of external mixer				
90—140 GHz (Band 10)	Function of external mixer				
140—220 GHz (Band 11)	Function of external mixer				

•High Performance TEKTRONIX Waveguide Mixers.

i. CHECK—sensitivity for Option 03 instruments. See Table 3-3 or 3-4.

j. Return PEAK/AVERAGE control to the fully ccw position and switch VIDEO FILTER off.

NOTE

This procedure may be used to check sensitivity characteristics with optional external waveguide mixers when an accurate signal source is used to establish the reference.

k. Repeat this procedure for the remaining coaxial input frequency range (100 kHz-21 GHz).

7. Check Frequency Drift or Stability (within 200 kHz/hour without phase lock, within 25 kHz/hour with Option 03 phase lock for B039999 and below, within 15 kHz/10 minutes for B040000 and up).

NOTE

This measurement and residual FM are dependent on oscillator stability. Therefore, the instrument must have at least a two hour warm-up period and stable ambient temperature.

a. Select a Vertical Display of 10 dB/DIV, FREQUENCY RANGE 0.0—4.2 GHz (0—1.8 GHz, Option 01), REF LEVEL of -20 dBm, FREQ SPAN/DIV to 10 MHz, TIME/DIV at AUTO, and activate AUTO RESOLUTION.

b. Connect the CAL OUT signal to the RF INPUT then tune one of the calibrator comb markers to center screen. Press the DEGAUSS button to remove any residual magnetism as the signal is centered.

c. Set REF LEVEL for a signal amplitude of about seven divisions. Reduce FREQ SPAN/DIV to 100 kHz, cancel PHASE LOCK (if Option 03 instrument), and adjust FREQUENCY to center the signal on screen. Allow a period of at least 30 minutes at fixed frequency before proceeding with drift check.

d. If the instrument has digital storage (Option 02), select VIEW B, SAVE A, and MAX HOLD; cancel VIEW A.

e. Check frequency drift over the specified period. If the instrument has digital storage, activate MAX HOLD to observe drift (see Fig. 3-6). If the instrument does not have digital storage, measure drift by observing the drift of the marker over the time period.

f. If the instrument has phase lock (Option 03), activate PHASE LOCK and reduce FREQ SPAN/DIV to 10 kHz. Recenter the marker signal on screen. Cancel MAX HOLD, then check drift as in parts d and e.

Table 3-4
492/492P (Option 01) SENSITIVITY

Frequency Range	Resolution Bandwidth				Option 03
	1 MHz	100 kHz	10 kHz	1 kHz	100 Hz
100 kHz—7.1 GHz (Bands 1—3)	-80	-90	-100	-110	-118
5.4—12.0 GHz (Band 4)	-65	-75	-85	-95	-103
12.0—18 GHz (Band 4)	-60	-70	-80	-90	-98
15—21 GHz (Band 5)	—	—	—	-85	-93
18.0—26.5 GHz (Band 6) ^a	-70	-80	-90	-100	-108
26.5—40.0 GHz (Band 7) ^a	-65	-75	-85	-95	-103
40.0—60 GHz (Band 8) ^a	-65	-75	-85	-95	-103
60—90 GHz (Band 9)	Depends on mixer				
90—140 GHz (Band 10)	Depends on mixer				
140—220 GHz (Band 11)	Depends on mixer				

•High Performance TEKTRONIX Waveguide Mixers.

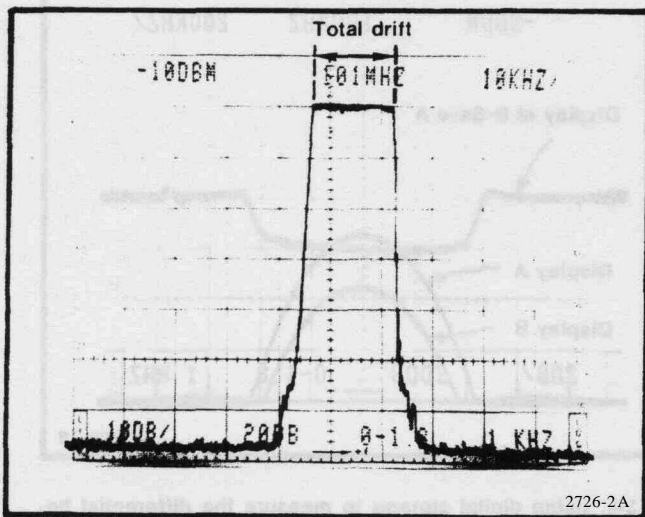

Fig. 3-6. Typical display using digital storage with MAX HOLD activated, to measure drift.

g. If the instrument has digital storage, cancel MAX HOLD and SAVE A.

8. Check Residual FM (within 1 kHz for 20 ms without phase lock, and within 50 Hz for 20 ms with Option 03 phase lock)

a. Set the FREQUENCY RANGE to Band 1 (0—4.1 GHz or 0—1.8 GHz Option 01). If the 492/492P has phase lock, cancel PHASE LOCK and center the calibrator signal with the FREQUENCY control. (Increase FREQ SPAN/DIV to locate signal if off screen, then return to 10 kHz/div.)

b. Set RESOLUTION BANDWIDTH to 10 kHz and the Vertical Display to LIN. Activate FINE and adjust REF LEVEL for a full screen display.

c. Position the marker signal with the FREQUENCY control so the slope (horizontal versus vertical excursion) of the response can be measured as illustrated in Fig. 3-7A. SINGLE SWEEP may be advantageous to freeze the display if the instrument has digital storage.

d. Switch FREQ SPAN/DIV to zero (time domain), TIME/DIV to 20 ms, and adjust FREQUENCY to position the display near center screen as shown in Fig. 3-7B. Note the peak-to-peak amplitude of the display within any horizontal division, scaling the vertical deflections according to the slope estimated in part c. Residual FM must not exceed 1 kHz for 20 ms.

e. If the instrument has phase lock (Option 03) proceed as follows:

1) Switch TIME/DIV to AUTO and activate PHASE LOCK. Increase FREQ SPAN/DIV to bring the signal on screen, then reduce the span to 500 Hz/div and the RESOLUTION BANDWIDTH to 1 kHz. Keep the signal centered with the FREQUENCY control.

2) Calculate the slope as described in part c.

3) Switch FREQ SPAN/DIV to 0 and TIME/DIV to 10 ms/div; then measure residual FM using the same technique described above. Residual FM, for Option 03 instruments, must not exceed 50 Hz for a 20 ms period or two divisions.

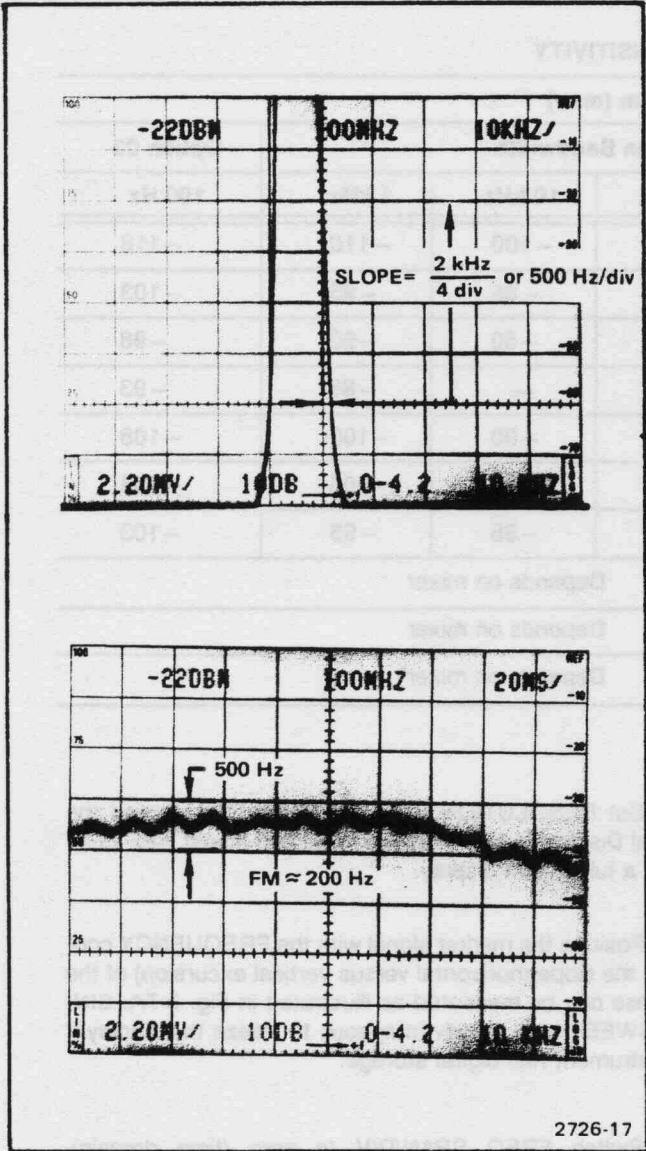

Fig. 3-7. Display to illustrate how residual FM is measured.

9. Digital Storage (Option 02)

a. Set the front panel controls as follows:

REFLEVEL	-10 dBm
Vertical Display	10 dB/DIV
RESOLUTION	
BANDWIDTH	1 MHz
FREQUENCY	100 MHz
TIME/DIV	AUTO
Digital Storage (Option 02)	VIEW A

b. With the calibrator signal applied to the RF INPUT, tune the signal to center screen while reducing the FREQ SPAN/DIV to 200 kHz. Change the Vertical Display to 2 dB/DIV, then activate SAVE A.

c. Change the REF LEVEL to -8 dBm and activate VIEW B. Display B of the calibrator signal should be 2 dB less than display A.

d. Activate B-SAVE A and check display. Display should show the difference between display B and display A (see Fig. 3-8).

e. Deactivate both SAVE A and B-SAVE A functions and activate MAX HOLD.

f. Change both FREQUENCY and REF LEVEL and note that MAX HOLD function retains and holds the maximum signal amplitude and frequency excursion.

g. Deactivate MAX HOLD and select VIEW A and AUTO BANDWIDTH. Reduce the FREQ SPAN/DIV to 100 kHz and change the Vertical Display to 10 dB/DIV.

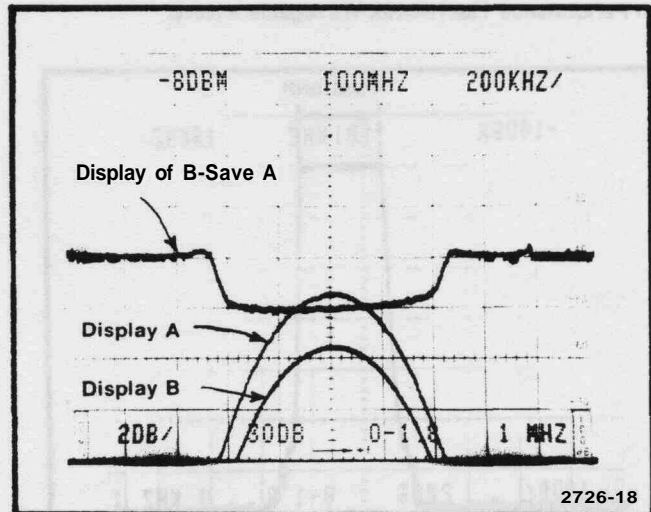

Fig. 3-8. Using digital storage to measure the differential between two events.

h. Vary the PEAK/AVERAGE control to shift the cursor over the screen height and note that signal and noise are averaged below the cursor.

10. 492P GPIB Verification Program

This verification program for TEKTRONIX 4050-Series Computer Terminal checks functional operation of the GPIB interface in a 492P Spectrum Analyzer. All interface lines

are verified as well as all interface message, except those for parallel poll. In addition, the instruments' interface is checked for operation on other primary addresses, as well as the talk-only and listen-only modes.

The program is written in TEKTRONIX 4050 BASIC, and is divided into individual tests, each for a specific interface line, message, or function. The tests start on even 1000 line numbers to allow easy modification of the program.

The following describes the function of each test in the program.

- Lines 1—5000: Interfaces to user definable keys for recovery from a failed test.
- Lines 5000—6000: Inputs the primary address of the 492P under test (1 should be used).
- Lines 6000—7000: ID query response test. The instrument must be able to talk and listen, to send out its ID? response and manipulate all eight of the DIO lines for the test to be successful.
- Lines 7000—8000: Local lock-out test. Tests correct operation of the interface message that should disable all programmable front panel controls.
- Lines 8000—9000: GO TO LOCAL test. Tests correct operation of the interface message that should enable all front panel controls.
- Lines 9000—10000: Group Execute Trigger test. Checks that a GET message does cause the 492P to abort the present sweep and re-arm the trigger, causing a sweep to start and end, sending out an End-of-Sweep SRQ. Thus, the SRQ line, as well as the GET message, is verified.
- Lines 10000—11000: Selected Device Clear Test. This test verifies that an SDC message does indeed reset the 492P's GPIB output buffer clearing out its ID? response.
- Lines 11000—12000: Device clear test. This test is identical to the selected device clear test, except the universal command DCL is used instead.
- Lines 12000—13000: Addressed as listener, talker test. This test checks to see that the 492P microprocessor correctly recognized that the GPIA chip has been addressed to listen or talk, and sends the appropriate character to the crt readout (L or T).
- Lines 13000—14000: Serial Poll test. This checks correct operation of the serial poll enable (SPE) and serial poll disable (SPD) interface messages. The status byte is read, and if anything other than ordinary operation is indicated, the instrument fails the test.
- Lines 14000—15000: GPIB rear panel switch test. All five primary address switches are checked for correct operation. Three subroutines are called in the process of testing one address switch. The first two send a formatted message to the 4050 display, and the third performs the address switch test.
- Lines 15000—16000: Line feed or EOI switch test. Checks for correct selection of line feed as a termination when selected by this switch by sending an ID? terminated only by a line feed.
- Lines 16000—17000: Talk-only mode test. When selected, this mode should cause the instrument to send a SET? response and (optionally) a CURVE? response whenever the RESET-TO-LOCAL button is pressed. The string received from the instrument is thus examined for existence of a portion of the correct SET? response after the RESET-TO-LOCAL button is pressed.
- Lines 17000—18000: Listen-only mode test. When selected, this mode will cause the instrument to respond to any message on the bus, since it is always addressed to listen. The command "REF 0" is sent to the bus without addressing the instrument, then the listen-only mode is deselected and the instrument interrogated to see if it did respond to the REF command while in the listen-only mode.

Operation—492/492P Operators

Lines 18000—19000: Interface clear (and Remote Enable) test. This IFC line on the GPIB will unaddress the instrument's interface. This fact is verified by noting that the "L" is not present in the CRT readout, indicating that the IFC line worked; also the REN line will be unasserted when the end statement is executed (except for some early 4052 and 4054's). Thus, a front panel in the local mode is evidence that the REN line was successfully unasserted. (Evidence it was asserted is that the instrument was able to execute commands sent to it by previous tests.)

Lines 19000—end: Utility routines. "Rear panel interface switch test text routine" puts headers on the interface switch test display. The "rear panel test text routine" tells the operator what to do after changing the address switches. "Test address switch" acquires an ID? response from the instrument on its new address during the address switch test. The "SRQ handler" will handle any 49X SRQ's that occur, although none, except the power-up SRQ, would be expected. (The end of sweep SRQ during the GET test is handled by another SRQ handler.) "Delay Generator" generates delays for other tests. The "Failure Decision Handler" allows the program to be restarted with the user definable keys if any test fails.

```
1 GO TO 5000
4 B2=1
5 RETURN
20 B2=5
21 RETURN
5000 REM — 49XP GPIB VERIFICATION PROGRAM ***
5030 INIT
5040 ON SRQ THEN 19280
5050 DIM V$(400),W$(400)
5060 I7=0
5070 PAGE
5080 PRINT "JJJENTER 49XP'S PRIMARY ADDRESS (DEFAULT = 1) ";
5090 INPUT T$
5100 IF T$ <> "" THEN 5130
5110 A1=1
5120 GO TO 5180
5130 A1=VAL(T$)
5140 IF A1 >0 AND A1 <31 THEN 5180
5150 PRINT "JJGERROR ";A1;" IS NOT A VALID ADDRESS";
5160 PRINT " ONLY 0 THRU 30 ARE VALID ADDRESSESKK"
5170 GO TO 5080
5180 PAGE
5190 REM
5200 REM
5210 REM
5220 REM
5230 REM
6000 REM *** "ID" QUERY RESPONSE ***
6010 PRINT "****"ID" QUERY RESPONSE ****"
6020 PRINT "@A1:"INI;ID?;SIG"
6030 INPUT @A1:T$
6040 V$=SEG(T$,1,9)
6050 IF V$="ID TEK/49" THEN 6080
6060 PRINT "JJJ— "ID" QUERY RESPONSE *** FAIL ***G"
6070 GO TO 19530
6080 WBYTE @32+A1:64,128,-127
6090 PRINT @A1:"WFM ENC:BIN;CUR?"
6100 PRINT @37,0:37,255,255
6110 INPUT %A1:T$
6120 WBYTE @64+A1:
6130 RBYTE R,R,R,T6
6140 WBYTE @95:
6150 IF R=>128 AND T6<128 THEN 7000
6160 PRINT `JJJ*** DIO8 TEST *** FAIL ***G"
6170 GO TO 19530
```

```

6180 REM
6190 REM
6200 REM
6210 REM
6220 REM
7000 REM — LOCAL LOCK-OUT.....LLO ***
7010 PRINT "*** LOCAL LOCK-OUT.....LLO ***"
7020 WBYTE @32+A1,17:
7030 PRINT @A1:"SET?"
7040 INPUT @A1:V$
7050 PRINT "II49XP IN LOCAL LOCK-OUT MODE (LLO)"
7060 PRINT "IIATTEMPT TO USE 49XP CONTROLS"
7070 PRINT " IIPRESS RETURN <CR> WHEN DONE ";
7080 INPUT T$
7090 PRINT @A1:"SET?"
7100 INPUT @A1:W$
7110 IF W$<>V$ THEN 7130
7120 GO TO 8000
7130 PRINT "J*** LOCAL LOCK-OUT.....LLO *** FAIL ***G"
7140 GO TO 19530
7150 REM
7160 REM
7170 REM
7180 REM
7190 REM
8000 REM *** GO TO LOCAL.....GTL ***
8010 PRINT @A1:"INI;TIM?"
8020 INPUT @A1:R
8030 PRINT @A1:"TIM INC"
8040 PRINT "*** GO TO LOCAL.....GTL ***"
8050 WBYTE @32 + A1,1:
8060 PRINT @A1:"TIM?"
8070 INPUT @A1:T6
8080 IF R<>T6 THEN 8100
8090 GO TO 9000
8100 PRINT "J**** GO TO LOCAL.....GTL *** FAIL ***G"
8110 GO TO 19530
8120 REM
8130 REM
8140 REM
8150 REM
8160 REM
9000 REM *** GROUP EXECUTE TRIGGER.....GET ***
9010 PRINT "*** GROUP EXECUTE TRIGGER...GET ***"
9020 ON SRQ THEN 9120
9030 I7 = 0
9040 PRINT @A1:"INIT;TIM 100M;SIG;EOS ON"
9050 WBYTE @32 + A1,8:
9060 T6 = 3
9070 GOSUB 19390
9080 PRINT @A1 : "EOS OFF"
9090 IF I7<>1 THEN 9150
9100 ON SRQ THEN 19280
9110 GO TO 10000
9120 WBYTE @20:
9130 I7 = 1
9140 RETURN
9150 PRINT "GROUP EXECUTE TRIGGER...GET *** FAIL ***G"
9160 GO TO 19530
9170 REM
    
```

Operation—492/492P Operators

```

9180 REM
9190 REM
9200 REM
9210 REM
10000 REM *** SELECTED DEVICE CLEAR...SDC ***
10010 PRINT **** SELECTED DEVICE CLEAR...SDC ****
10020 PRINT @A1:"ID?"
10030 WBYTE @32+A1,4:
10040 WBYTE @64+A1:
10050 RBYTE R
10060 IF ABS(R)<>255 THEN 10080
10070 GO TO 11000
10080 PRINT **** SELECTED DEVICE CLEAR.....SDC *** FAIL ***G*
10090 GO TO 19530
10100 REM
10110 REM
10120 REM
10130 REM
10140 REM
11000 REM *** DEVICE CLEAR.....DCL ***
11010 PRINT **** DEVICE CLEAR.....DCL ****
11020 PRINT @A1:"ID?"
11030 WBYTE @20:
11040 WBYTE @64+A1:
11050 RBYTE R
11060 IF ABS(R)<>255 THEN 11080
11070 GO TO 12000
11080 PRINT **** DEVICE CLEAR.....DCL *** FAIL ***G*
11090 GO TO 19530
11100 REM
11110 REM
11120 REM
11130 REM
11140 REM
12000 REM ** ADDRESSED AS LISTENER, TALKER ***
12010 PRINT **** 49XP ADDRESSED AS LISTENER..****
12020 WBYTE @32+A1:76,79,82,68,79,-63
12030 T6=1
12040 GOSUB 19390
12050 INPUT @A1:V$
12060 T$=SEG(V$,16,1)
12070 IFT$="L" THEN 12100
12080 PRINT "J*** 49XP ADDRESSED AS LISTENER *** FAIL ***G*
12090 GO TO 19530
12100 PRINT **** 49XP ADDRESSED AS TALKER....****
12110 PRINT @A1 : "INI;TIM 50M;SIG;SIG;WAI;LORDO?"
12120 INPUT @A1:V$
12130 T$=SEG(V$,16,1)
12140 IFT$="T" THEN 13000
12150 PRINT **** 49XP ADDRESSED AS TALKER *** FAIL ****
12160 GO TO 19530
12170 REM
12180 REM
12190 REM
12200 REM
12210 REM
13000 REM *** SERIAL POLL ***
13010 PRINT **** SERIAL POLL.....SPD/SPE ****
13020 WBYTE @95,63,24,64+A1:
13030 RBYTE R
13040 WBYTE @95,25:
13050 IF R=0 OR R=16 THEN 13080

```

```

13060 PRINT "J*** SERIAL POLL *** FAIL ***G"
13070 GO TO 19530
13080 T6=3
13090 GOSUB 19390
13100 REM
13110 REM
13120 REM
13130 REM
13140 REM
14000 REM *** GPIB INTERFACE REAR PANEL SWITCH TEST ***
14010 PAGE
14020 A1=2
14030 GOSUB 19000
14040 PRINT " 01010100010"
14050 GOSUB 19070
14060 GOSUB 19190
14070 PAGE
14080 A1=4
14090 GOSUB 19000
14100 PRINT " 01010100100"
14110 GOSUB 19070
14120 GOSUB 19190
14130 PAGE
14140 A1=8
14150 GOSUB 19000
14160 PRINT " 010101010000"
14170 GOSUB 19070
14180 GOSUB 19190
14190 PAGE
14200 A1=16
14210 GOSUB 19000
14220 PRINT " 010101100000"
14230 GOSUB 19070
14240 GOSUB 19190
14250 REM
14260 REM
14270 REM
14280 REM
14290 REM
15000 REM *** 'LF' OR 'EOI' SWITCH ***
15010 PAGE
15020 A1=1
15030 GOSUB 19000
15040 PRINT " 01011100001"
15050 GOSUB 19070
15060 PRINT "JJTESTING LF' OR EOI' SWITCH"
15070 GOSUB 19190
15080 WBYTE @32+A1:73,68,63,10
15090 INPUT @A1:T$
15100 T$=SEG(T$,1,9)
15110 IF T$="ID TEK/49" THEN 15140
15120 PRINT "JLF' OR EOI' SWITCH *** FAIL ***G"
15130 GO TO 19530
15140 T6=2
15150 GOSUB 19390
15160 REM
15170 REM
15180 REM
15190 REM
15200 REM
16000 REM — TALK ONLY MODE ***
16010 PAGE
    
```

Operation—492/492P Operators

```
16020 GOSUB 19000
16030 PRINT " 0 1 1 1 0 1 0 0 0 0 1"
16040 GOSUB 19070
16050 PRINT "JJJTESTING TALK ONLY"
16060 INPUT @A1:V$
16070 I7 = POS(V$,"FINE OFF",1)
16080 IF I7<>0 THEN 17000
16090 PRINT "JJJTALK ONLY MODE *** FAIL ***G"
16100 GO TO 19530
16110 REM
16120 REM
16130 REM
16140 REM
16150 REM
17000 REM — LISTEN ONLY MODE ***
17010 PAGE
17020 GOSUB 19000
17030 PRINT " 1 1 0 1 0 1 0 0 0 0 1"
17040 GOSUB 19070
17050 PRINT "JJJTESTING LISTEN ONLY"
17060 PRINT @A1:"INI"
17070 T6=0.5
17080 GOSUB 19390
17090 WBYTE 82,69,70,32,-48
17100 PAGE
17110 GOSUB 19000
17120 PRINT " 0 1 0 1 0 1 0 0 0 0 1"
17130 GOSUB 19070
17140 PRINT @A1:"REF?"
17150 INPUT @A1:V$
17160 IF V$<>"REFLVL +0.0" THEN 17180
17170 GO TO 18000
17180 PRINT "JJJLISTEN ONLY MODE *** FAIL ***G"
17190 GO TO 19530
17200 REM
17210 REM
17220 REM
17230 REM
17240 REM
18000 REM *** INTERFACE CLEAR AND REMOTE ENABLE TEST.....IFC & REN ***
18010 PAGE
18020 PRINT "JJJTESTING IFC(INTERFACE CLEAR), AND REN(REMOTE ENABLE)"
18030 WBYTE @32 + A1:
18040 T6=3
18050 GOSUB 19390
18060 PRINT "JJCHECK THE 49XP CRT, FOR AN 'L' BETWEEN THE VERTICAL"
18070 PRINT "DISPLAY AND THE MIN RF ATTEN READOUTS."
18080 PRINT "JPRESS RETURN TO CONTINUE.";
18090 INPUT P$
18100 INIT
18110 PRINT "JIF AN 'L' IS STILL PRESENT, THE IFC LINE IS FAULTY,"
18120 PRINT "IF THE 'L' VANISHED, IFC TESTED OK."
18130 PRINT "JJCHECK ALSO THE 49XP FRONT PANEL FOR PROPER LOCAL CONTROL"
18140 PRI "IF THE FRONT PANEL IS LOCKED OUT, THE REN LINE IS FAULTY, IF"
18150 PRINT "NOT, REN TESTED OK"
18160 PRINT "JJGPIB VERIFICATION COMPLETEG"
18170 END
18180 REM
18190 REM
18200 REM
19000 REM *** REAR PANEL INTERFACE SWITCH TEST TEXT ROUTINE ***
19010 PRINT "SET GPIB ADDRESS SWITCHES TO:"
```



```

19020 PRINT "JLISTENITALKILF ORI ADDRESS"
19030 PRINT " ONLYIONLYIEOII16 8 4 2 1"
19040 PRINT "-----|-----|-----"
19050 RETURN
19060 REM
19070 REM *** REAR PANEL TEST TEXT ROUTINE ***
19080 PRINT "JJAFTER CHANGING THE SWITCHES, ";
19090 PRINT "PRESS THE REMOTE/LOCAL BUTTON ONCEJJ"
19100 PRINT "I(NOTE: IF YOU GET A GPIB INTERFACE ERROR MESSAGE,"
19110 PRINT "I IT MEANS THAT THE SWITCH(ES) WERE"
19120 PRINT "I READ CORRECTLY. TO RE-TEST, TYPE"
19130 PRINT "I 'RUN' FOLLOWED BY THE LINE NUMBER IN THE"
19140 PRINT "I ERROR MESSAGE "
19150 PRINT "JJIPRESS RETURN <CR> WHEN DONE ";
19160 INPUT TS
19170 RETURN
19180 REM
19190 REM *** TEST ADDRESS SWITCH ***
19200 PRINT @A1:"ID?"
19210 INPUT @A1:TS$
19220 TS$=SEG(TS$,1,9)
19230 IF TS$="ID TEK/49" THEN 19260
19240 PRINT "ADDRESS SWITCH TEST FAIL"
19250 GO TO 19530
19260 RETURN
19270 REM
19280 REM *** SRQ HANDLER ***
19290 T6=3
19300 GOSUB 19390
19310 POLL Z1,Z1:A1
19320 PRINT @A1:"ERR?"
19330 INPUT @A1:S$
19340 PRINT "GGAN INTERRUPT OCCURED ON THE BUS, THE 49XP RETURNS ";S$
19350 PRINT "JPRESS RETURN <CR> TO CONTINUE ";
19360 INPUT TS$
19370 RETURN
19380 REM
19390 REM *** DELAY GENERATOR *** LFG OCT 79 ***
19400 REM *** LATEST UP-DATE: 24JUL80 AJB ***
19410 REM *** T6 GIVEN IN SEC (GLOBAL) *** I9 SCRATCH ***
19420 IF T6<0 THEN 19510
19430 IF RND(0)>0.5 THEN 19490
19440 REM *** 4051 ***
19450 T6= T6*220
19460 FOR I9=1 TO T6
19470 NEXT I9
19480 GO TO 19510
19490 REM — 4052
19500 CALL "WAIT",T6
19510 T6=0
19520 RETURN
19530 REM **** FAILURE DECISION HANDLER ****
19540 PRINT "JJISELECT A UDK:"
19550 PRINT "I (1) RE-START"
19560 PRINT "I (5) END"
19570 SET KEY
19580 B2=0
19590 IF B2<>1 AND B2<>5 THEN 19590
19600 IF B2=5 THEN 19630
19610 PAGE
19620 GO TO 6000
19630 END

```

This completes the operational check of the 492/492P.

REV JUL 1984

GENERAL OPERATING INFORMATION

Firmware Version and Error Message Readout

For information, refer to subsection following Controls, Indicators, and Connectors.

Crt Light Filters

Two light filters are supplied with the 492/492P accessories: amber and grey. Filter selection depends on ambient light conditions, light reflections, and operator's viewing needs. The filter is installed by pulling the top of the plastic mask out and placing the filter behind the crt bezel. It is best to remove the light filter when taking display photographs.

Intensity Level, Focus, and Beam Alignment

Operate the instrument with the intensity level no higher than that required to clearly observe the display. Trace alignment and beam focus are internal adjustments that must be performed by qualified service personnel.

Intensity level for some displays, such as pulsed spectra, must be higher which may produce a display with a very bright baseline. This bright baseline can be clipped or subdued by activating the BASELINE CLIP.

Signal Application

Signal frequencies up to 21 GHz are applied through a short, high quality, 50 Ω coaxial cable, to the RF INPUT connector. These signals pass through an internal RF attenuator to the first (1st) mixer. Option 01 version of the 492/492P has a filter selector that automatically selects either a low-pass filter or tuned preselector (depending on frequency band) between the RF attenuator and the 1st mixer.

Signals above 21 GHz are applied to an external waveguide mixer. The output of the waveguide mixer is then applied through the EXT MIXER port to the second converter of the 492/492P. Waveguide mixers and their application are described later.

RF INPUT Connector. The nominal input impedance of the coaxial RF INPUT is 50 Ω . Because cable losses can be significant at microwave frequencies, it is important to keep the cables as short as possible. Impedance mismatch between the signal source and the RF INPUT will produce reflections and degrade flatness, frequency response, sensitivity, and increase spurious responses. Impedance mismatch can be caused by poor connections, incorrect signal source impedance, long or low quality coaxial cable, etc.

When optimum flatness or frequency response is desired and signal strength is adequate, set the **MIN RF ATTENUATION** for 10 dB or more. The addition of the attenuator helps minimize reflections to improve the input characteristics.

CAUTION

With MIN NOISE activated and 60 dB of MIN RF ATTEN, the REF LEVEL can be set to +40 dBm. The front end of the 492/492P is specified at +30 dBm maximum. Do not increase input signal level to full screen with a REF LEVEL of +40 dBm because this will exceed the attenuator rating. DC input is limited to zero (0) volt.

As stated in the preceding CAUTION, too much power can cause signal compression or if excessive, it can destroy the 1st mixer. Signals greater than -30 dBm or -20 dBm in MIN NOISE mode, should be attenuated by the RF ATTENUATOR. Signals above the safe input level (+30 dBm) must be attenuated by external attenuators. Ensure that the frequency range of external attenuators is adequate.

Line stabilizing networks used for conducting EMI/RF measurements, will often have several volts of 60 Hz signal at the output. A dc block, such as Tektronix Part No. 015-0221-00, will protect the input mixer and prevent destruction.

Signal levels of -10 dBm or more (-28 dBm Option 01, for 1.7 to 1.8 GHz range, see Specifications) may be compressed. This may degrade signal reference level measurements and generate spurious responses.

Spurious responses can be minimized if the signal amplitude is kept within the graticule window. A recommended procedure is to select a REF LEVEL that places stronger signals just within the graticule window. In some cases, as previously described, it may be best to add RF ATTENUATION.

Amplitude Conversion. The 492/492P reads out signal levels in dBm. A conversion chart shown in Fig. 3-9 provides a way to determine input signal levels from a voltage or power source.

Connecting to 75 Ω Source: The 492/492P can be used with a 75 Ω signal source at the lower frequencies (100 kHz—1 GHz) by using a 75 Ω to 50 Ω minimum loss attenuator. This attenuator is available as an optional accessory (refer to the optional accessories list in the catalog for ordering information).

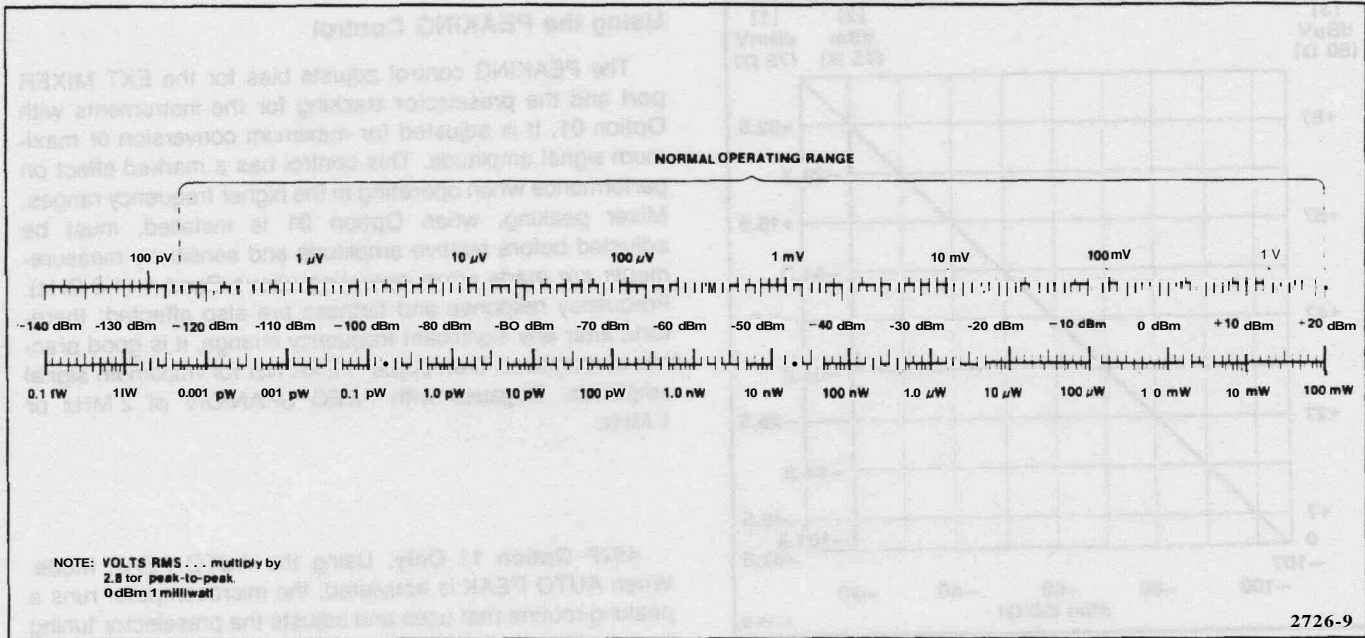

Fig. 3-9. Volts-dBm-Watts conversion chart for 50 Ω impedance.

Sensitivity and power levels are often rated in dBm (dB with reference to 1 mW regardless of impedance). Sensitivity and power levels for 75 Ω systems are usually rated in dBmV (dB with reference to 1 mV across 75 Ω). Figure 3-10 is a circuit diagram of a suitable matching pad for this purpose. Figure 3-11 shows the relationship between 50 Ω and 75 R units, with matching attenuators included; the conversion is described as follows:

- (1) dBmV (75 R) = dBm (50 R) + 54.47 dB.
e.g., -60 dBm (50 R) + 54.47 dB = -5.5 dBmV (75 R).
- (2) dBm (75 R) = dBm (50 Ω) + 5.72 dB.
e.g., -60 dBm (50 Ω) + 5.72 dB = -54.3 dBm (75 Ω).
- (3) For some applications you may wish to know the relationship between dBm and dBμV.

For 50 R systems dBμV = dBm + 107 dB.

Resolution Bandwidth, Frequency Span, and Sweep Time

Resolution is the ability of a spectrum analyzer to display discrete frequency components within a frequency span. This ability is a function of the analyzer bandwidth, sweep time, frequency span, and incidental FM. Frequency span and sweep time are normally selected to provide the minimum resolution bandwidth setting for a particular cw signal. Bandwidth also has an affect on noise level. As the bandwidth decreases, signal-to-noise ratio or sensitivity increases. Maximum sensitivity is therefore attained at the narrow resolution bandwidth settings.

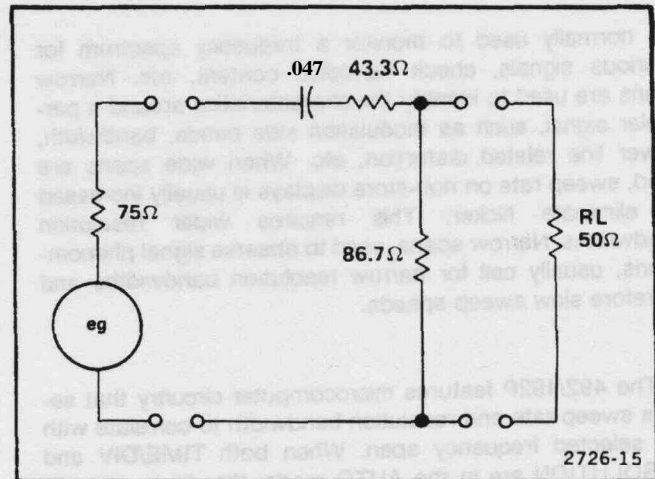

Fig. 3-10. Circuit of a 75 Ω to 50 Ω matching pad (ac coupled).

As the analyzer sweep rate is increased, a critical rate is reached where both sensitivity and resolution are degraded. Therefore, sweep time for a calibrated display is dependent on resolution bandwidth and the frequency span.

In spans other than MAX SPAN, frequency span is symmetrical about the center frequency. In MAX SPAN the display represents the full frequency range of the selected band. A frequency dot above the display indicates the location on the spectrum of the FREQUENCY readout. The frequency span used depends on the application. Wide spans

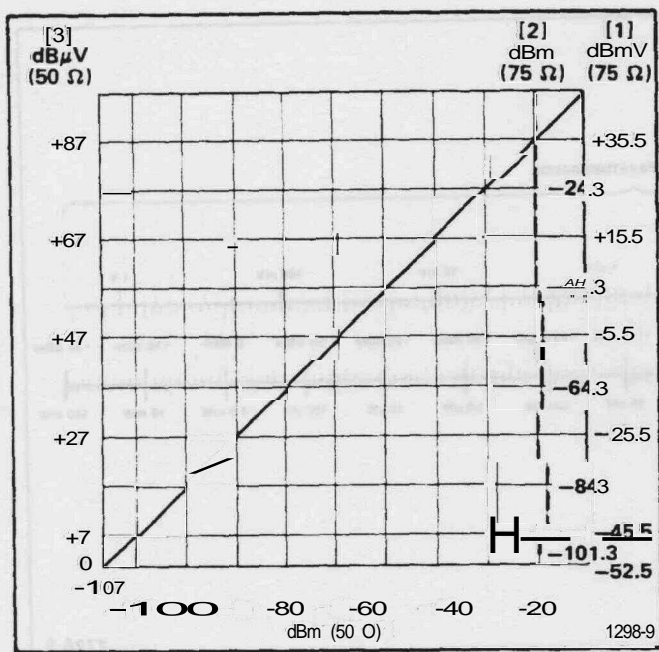

Fig. 3-11. Graph to illustrate the relationship between dBm, dBmV, and dBμV (matching attenuator included where necessary).

are normally used to monitor a frequency spectrum for spurious signals, check harmonic content, etc. Narrow spans are used to identify the characteristics around a particular signal, such as modulation side bands, bandwidth, power line related distortion, etc. When wide spans are used, sweep rate on non-store displays is usually increased to eliminate flicker. This requires wider resolution bandwidths. Narrow spans, used to observe signal phenomena, usually call for narrow resolution bandwidths and therefore slow sweep speeds.

The 492/492P features microcomputer circuitry that selects sweep rate and resolution bandwidth to correlate with the selected frequency span. When both TIME/DIV and RESOLUTION are in the AUTO mode, the display is calibrated for each FREQ SPAN/DIV selection. The AUTO position of the TIME/DIV selector ties the sweep speed to the analyzer span/div and resolution bandwidth. The AUTO mode of the RESOLUTION BANDWIDTH optimizes bandwidth for the selected FREQ SPAN/DIV and TIME/DIV settings unless either is outside the range of correction. When this occurs, the UNCAL indicator lights and a ">" symbol prefixes the REF level readout on the crt display.

When analyzing pulse signals, a wider bandwidth than that provided by AUTO is usually desired. The resolution bandwidth should be on the order of 1/10 the side lobe frequency width, or the reciprocal of the pulse width, in order to ensure adequate resolution. The RESOLUTION BANDWIDTH is usually set for optimum main lobe detail after the sweep rate has been selected.

Using the PEAKING Control

The PEAKING control adjusts bias for the EXT MIXER port and the preselector tracking for the instruments with Option 01. It is adjusted for maximum conversion or maximum signal amplitude. This control has a marked effect on performance when operating in the higher frequency ranges. Mixer peaking, when Option 01 is installed, must be adjusted before relative amplitude and sensitivity measurements are made when operating above Band 1 (1.8 GHz). Frequency response and flatness are also affected; therefore, after any significant frequency change, it is good practice to degauss, then adjust PEAKING for maximum signal amplitude. Degauss with FREQ SPAN/DIV of 2 MHz or 1 MHz.

492P Option 11 Only. Using the AUTO PEAK Mode. When AUTO PEAK is activated, the microcomputer runs a peaking routine that uses and adjusts the preselector tuning signal within the center two divisions of the screen. When the response is peaked, it stores the setting in RAM. If no signal is present for the peaking routine, couple the second LO output to the RF Input via a short coaxial cable and a SMA-to-type-N connector. This calibration will be required each time the instrument is powered up. When using the instrument in external mixer bands, the AUTO PEAK algorithm needs to be run on each signal of interest.

Phase Lock Operation (Option 03)

Phase lock, in Option 03 instruments, is activated for the narrower spans (see description under Controls, Indicators, and Connectors) to lock the 1st LO to a stable reference. If phase lock mode is active and PHASE LOCK button is pressed to deactivate phase lock, the signal may shift position and in narrow spans it may shift off screen.

Using the Signal Identifier

Conversion in the 1st mixer generates many spurious responses. This is due to the multiple harmonics of the local oscillator converting input signals to an intermediate frequency within the bandpass of the IF. This is especially true for the basic 492/492P (without the Option 01 preselector) and when the waveguide mixers are used.

To help identify true signals, the 492/492P features an "identify" mode. With the FREQ SPAN/DIV at 500 kHz, press the IDENTIFY 500 kHz/ONLY button. True signals will alternately shift vertically while spurious signals shift horizontally or off screen. Identify mode will operate only when the frequency span is 500 kHz/div.

Using the Video Filters

The video filters restrict the video bandwidth so that noise or beat signals are reduced (see Fig. 3-12). When signals are closely spaced, the filter may be useful to reduce modulation between two signals so they can be more easily analyzed. The filters can also be used to average the envelope of pulsed RF spectra that has a relatively high prf (pulse repetition frequency); however, because the filter is basically an integrating circuit, selecting a Video Filter when measuring low prf spectra produces poor results.

The WIDE filter reduces the bandwidth to approximately 1/30th the selected resolution bandwidth; the NARROW filter about 1/300th. Using the filter may require a reduction in the sweep rate to maintain a calibrated display. Again the UNCAL indicator will light if the sweep speed is too fast for a calibrated display.

Time Domain Operation

When the FREQ SPAN/DIV is reduced to zero, the analyzer functions as a tunable receiver to display time domain characteristics within the capabilities of the resolution bandwidth. The TIME/DIV selector can now be used to analyze such characteristics as modulation pattern, pulse repetition rates, etc.

Triggering the Display

Triggering is usually FREE RUN for spectrum displays; however, it may be desirable or necessary to trigger the display when the event is time related to some source or when the frequency span has been reduced to zero for time domain analysis. In the FREE RUN mode the sweep will not synchronize with any input signal.

The sweep can be triggered internally from the vertical or video signal, at the line frequency rate of the power supply, or from an external signal applied to the EXT IN HORIZ/TRIG jack on the back panel. The amplitude of trigger signal required to trigger the sweep is two (2.0) divisions or more, for internal triggering, and 1.0 volt to a maximum of 50 volts (dc + peak ac) for external triggering.

Trigger source is selected by activating one of the triggering pushbuttons. In addition to the four trigger source selections, SINGLE SWEEP mode can be selected. The sweep will run once after the circuit has been armed and trigger signal arrives. The READY indicator lights when the circuit is armed and waiting for a trigger signal and remains lit until the sweep has run. Pushing the SINGLE SWEEP button once activates single sweep mode; pushing it again arms the trigger circuit so it is ready for a trigger signal.

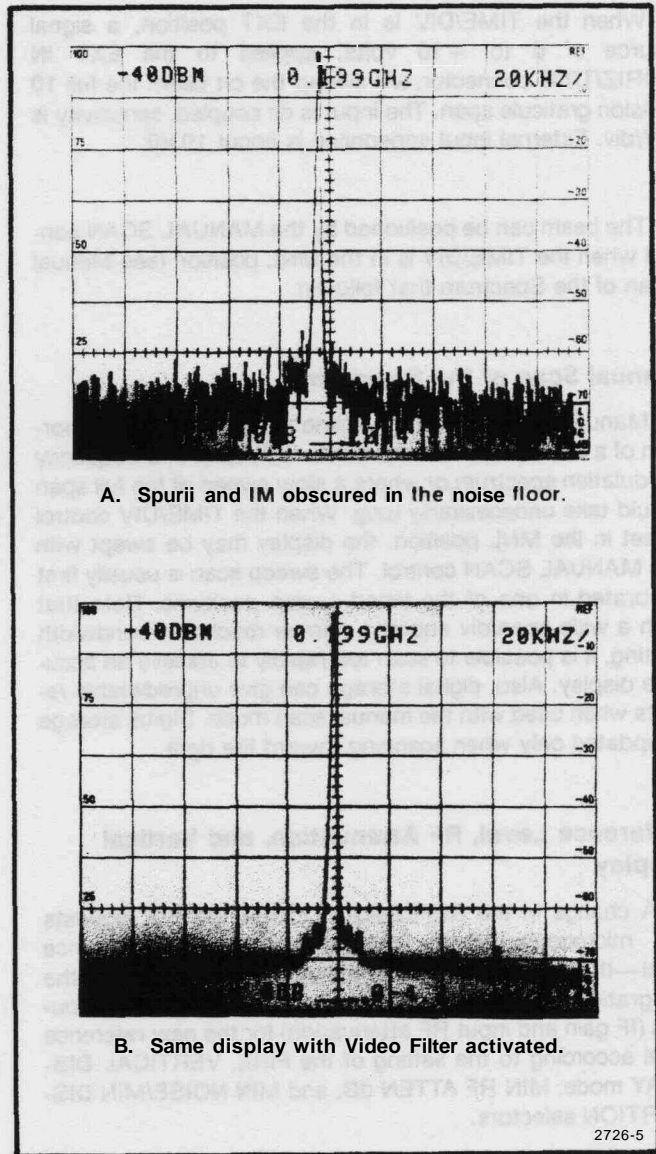

Fig. 3-12. Integrating the display with the Video Filter.

Sweeping the Display

Horizontal sweep for the display is either internal or from an external sweep source. Sweep rate and source are selected by the TIME/DIV switch. When the TIME/DIV switch is in the AUTO position, the sweep rate is controlled by an internal microcomputer.

When the TIME/DIV is in the EXT position, a signal source of 0 to +10 volts, applied to the EXT IN HORIZ/TRIG connector, will sweep the crt beam the full 10 division graticule span. The input is dc coupled, sensitivity is 1 V/div. External input impedance is about 10 k Ω .

The beam can be positioned by the MANUAL SCAN control when the TIME/DIV is in the MNL position (see Manual Scan of the Spectrum that follows).

Manual Scan of the Spectrum

Manual scan is used to examine a particular point or portion of a display such as one of the null points of a frequency modulation spectrum or where a slow sweep of the full span would take unnecessarily long. When the TIME/DIV control is set in the MNL position, the display may be swept with the MANUAL SCAN control. The sweep scan is usually first calibrated in one of the timed sweep positions. Note that with a wide span/div and/or a narrow resolution bandwidth setting, it is possible to scan too rapidly to achieve an accurate display. Also, digital storage can give unpredictable results when used with the manual scan mode. Digital storage is updated only when scanning toward the right.

Reference Level, RF Attenuation, and Vertical Display

A change in the REFERENCE LEVEL control requests the microcomputer to change the display reference level—the absolute amplitude represented by the top of the crt graticule. The microcomputer selects the gain distribution (IF gain and input RF attenuation) for the new reference level according to the setting of the FINE, VERTICAL DISPLAY mode, MIN RF ATTEN dB, and MIN NOISE/MIN DISTORTION selectors.

The amount of attenuation between the RF INPUT and the first mixer, set by the microcomputer, is based on the reference level requested and the mode of the MIN RF ATTEN dB and MIN NOISE/MIN DISTORTION selectors. The microcomputer assumes the MIN RF ATTEN dB selection is the minimum attenuation required for the expected signal levels. It does not reduce RF attenuation below this value. It also selects the best ratio of RF attenuation and IF gain according to the MIN NOISE/MIN DISTORTION mode (see description that follows). MIN RF ATTEN selects the lower limit reference level range. As MIN RF ATTEN dB is increased, the lower limit reference level is raised an equal amount. At 0 dB minimum attenuation, the lower limit reference level is -123 dBm. At 10 dBm minimum attenuation, the reference level goes to -113 dBm, etc.

The reference level increments depend on the Vertical Display mode and FINE selector mode. Reference level

steps for the log displays are 10dB and 1 dB with FINE off, and 1 dB and 0.25 dB with FINE activated (0.25 dB steps apply to the AA mode). For LIN displays with FINE off, the microcomputer selects the reference level, which is the equivalent of an 8-division signal, where the bottom of the crt graticule is zero volt and the top of the crt graticule is eight times the vertical display factor. The display factor changes in a 1-2-5 volts/division sequence. For LIN displays with FINE on, the reference level changes in 1 dB steps and the scale factor is 1/8 the voltage equivalent of the reference level.

Delta A Mode

To select this mode, activate 2 dB/DIV and FINE; the REF LEVEL readout becomes *0.00 dB and the REFERENCE LEVEL steps in 0.25 dB increments.

The AA mode is useful for measuring relative amplitude differences of signals more accurately. This is because the gain distribution (IF gain and RF attenuation) is not changed when AA mode is activated. The REF LEVEL is changed by shifting the log amplifier offset. The measurement range of the AA mode is at least from 10 dB above to 40 dB below the reference level established when the mode was activated; however, the overall instrument display characteristic of -123 dBm to +30 dBm cannot be exceeded. The asterisk in the REF LEVEL readout remains until the AA mode gain distribution is changed.

The AA mode is canceled when either FINE or 2 dB/DIV are deactivated, or a selector that could change gain distribution (MIN RF ATTEN or MIN NOISE) is changed. The analyzer also deactivates AA mode when EXT MIXER or an external mixer frequency range is selected.

Signals with large differences in amplitude that are within the AA range can be compared without the distortion usually introduced when signals are driven off-screen. Signals shifted off-screen by changes in the AA reference level are not overdriving the input because the attenuator and IF gain are not changed; thus the mixers do not see any change in signal levels due to the AA reference level changes.

To measure amplitude level differences of two signals:

- 1) Select AA mode by activating 2 dB/DIV and FINE.
- 2) Using the REF LEVEL control, set the larger amplitude signal to a graticule line.
- 3) Press the FINE pushbutton twice to deactivate and reactivate the AA mode.
- 4) Using the REF LEVEL control, set the lower amplitude signal to the same graticule line established in step 2.
- 5) The REF LEVEL readout displays the amplitude level difference in dB.

MIN NOISE/MIN DISTORTION

This pushbutton selects one of two algorithms that control attenuator and IF gain settings. MIN NOISE minimizes noise level while MIN DISTORTION minimizes input mixer overload. To observe any change when MIN NOISE is activated, the RF ATTEN crt readout must be 10 dB higher than that set by the MIN RF ATTEN selector.

CAUTION

With MIN NOISE activated and 60 dB of MIN RF ATTEN, the REF LEVEL can be set to +40 dBm. The front end of the 492/492P is specified at +30 dBm maximum. Do not increase input signal level to full screen with a REF LEVEL of +40 dBm because this will exceed the attenuator rating. DC input is limited to zero (0) volt.

Digital Storage (Option 02)

Digital storage provides a smooth (flicker free) display. Two complete events can be stored. One of these can be saved and then compared to subsequent updated information. A MAX HOLD feature updates the stored data in memory when the new input is of higher amplitude thus allowing monitoring and graphic plotting of display changes with time. Vertical information can be divided by a cursor, or horizontal line, that is positioned with the PEAK/AVERAGE control. Above the cursor, video information is peak detected and displayed; below the cursor, signal averaging occurs. The average (number of samples) is a function of sweep speed. The slower the sweep, the greater the number of samples averaged. This feature suppresses noise in that portion below the cursor and allows full peak detection of vertical data above the cursor. An intensified spot on the cursor indicates the horizontal position at which memory is being updated.

When digital storage is used, an additional quantization error of 0.5% of full screen must be added to the amplitude performance characteristics (i.e., frequency response, sensitivity, etc.).

Digital storage memory is functionally divided into two sections—A and B. Data can be stored in A or B or in both. There are 512 horizontal locations in A and 512 horizontal location in B. When both are displayed, the origin of B is shifted such that the A and B coordinates are interlaced to provide 1024 display increments. Data in memory is continually updated with each sweep so the display, when viewing A or B, is always current.

When SAVE A function is activated, data in A memory is held in storage and only B memory is updated. This inhibition takes place whether A is displayed or not. This mode

captures an event or waveform for comparison with a subsequent event displayed by VIEW B mode. In this mode all of A memory is displayed, then all of B, each by a separate sweep.

When B—SAVE A is activated, the contents of data in B memory minus the contents saved in A are displayed. This provides the comparison of the two events by presenting the algebraic difference of the two displays. This convenient mode can be used to align filters or other devices when tuning for a null. The reference waveform is stored in A and the unknown in B. If the device under test is active, the B waveform may be larger than the reference which results in a shift in the zero reference line. The position of the zero reference can be selected with an 8-bit digital switch. The reference level is normally set mid-screen so positive and negative quantities can be observed. Qualified service personnel can position the reference anywhere within the graticule window.

MAX HOLD causes the digital memory to be updated only if the new input is of higher magnitude than the former (B memory only if SAVE A is active). This allows monitoring of signals that may change with time and provides a graphic record of amplitude/frequency excursions.

Signal averaging is useful for suppressing noise. The number of samples averaged per digitized slot (increment) is a function of the spectrum analyzer sweep rate. The slower the sweep speed, the more samples averaged per resolution bandwidth. Resolution bandwidth also affects the amplitude difference between peak detected and average levels of cw signals. When the resolution bandwidth is less than 1/30th the span/division (e.g., 100 kHz or less with 5 MHz span/div) there will be significant difference between peak and average amplitude levels of cw signals. The peak value will be the true value, the average value will be in error, especially if only A or B is displayed. It is best to run digital storage with both A and B interlaced when using narrow resolution bandwidth with wide frequency spans.

To analyze signal amplitude level, set the cursor at least 1/4 division below the signal peak. To average noise, set the cursor at least 1/4 division above the noise level.

WAVEGUIDE MIXERS AND EXTERNAL DIPLEXER

Introduction

Two types of waveguide mixers are available: lower cost, general purpose mixers that cover the microwave bands, and TEKTRONIX High Performance Waveguide Mixers that cover both microwave and millimeter-wave frequency

bands. The 18 to 26.5 GHz and 26.5 to 40 GHz frequency ranges are considered microwave bands; above 40 GHz are the millimeter-wave bands. Improved frequency response and sensitivity characteristics for the High Performance Waveguide Mixers (see Specification Section 1) makes them a better choice for critical measurements in the microwave bands, whereas the General Purpose Waveguide Mixers can be used for initial measurements or as backup units for the high performance mixer.

Typical broadband frequency response for the High Performance Waveguide Mixers is ± 3 dB to 60 GHz. The mixers are optimized for flatness over each waveguide band.

Both the High Performance and General Purpose microwave mixers have field replaceable diodes. The millimeter-wave mixers are not field repairable and must be returned to Tektronix, Inc. for repair.

Waveguide mixers are optional accessories. The external diplexer is part of the standard accessories (see Section 1). Each mixer is supplied with a data sheet; mixer sets (i.e., Option 20, 21, or 22) include an instruction manual that contains a detailed description and operational procedures.

Reference Level Readout for Waveguide Mixers

The initial turn-on Reference Level CRT readout, for 492/492P instruments with firmware versions 1.0 through 1.4 plus 8.2 and 8.7, is -30 dBm for the upper three (60 to 220 GHz) waveguide bands. Conversion loss of Tektronix Mixers for the 60 to 90 GHz and 90 to 140 GHz bands is approximately 20 dB more than the coaxial and lower band mixers. Typical loss, for mixers in the 140 to 220 GHz band, is about 30 dB. This means the Reference Level readout is 20 dB and 30 dB low for these bands; however, the display measurement dynamic range is not affected.

Firmware for later instruments has been changed so the turn on Reference Level readout indicates -10 dBm for the 60 to 90 GHz and 90 to 140 GHz bands, and 0 dBm for the 140 to 220 GHz band. A conversion kit is available to update your instrument if desired. Contact your local Tektronix representative or Service Center for information.



To prevent damage to the waveguide mixers, read the following instructions fully and carefully before installing or using the mixers.

Handling

Handle the waveguide mixers with care. The mixer diode is sensitive to static discharges and excessive rf energy. The maximum input level to all waveguide mixers is +10 dBm or 10 mW cw rf (see Specifications for pulse characteristics). Bias polarity for Tektronix waveguide mixers is negative-going. Check bias requirements of non-Tektronix mixers before connecting them to the 492/492P Spectrum Analyzer.

If your mixer requires positive-going bias, the 492/492P bias polarity can be reversed, contact your service personnel or Tektronix Field Representative.

Ensure that the shorting cap is installed when the mixer is not in use and install the flange cover on the mixer before returning it to the storage box. The mixer diode can also be destroyed by mechanical vibration or shock.

Do not use an ohmmeter to test or check the mixer diode. The voltage across the test leads of many ohmmeters is capable of destroying the diode.

Use care to avoid scratching the flange surface; these can degrade the performance.

Installation

The waveguide mixer is connected in the rf system of the analyzer as shown in Fig. 3-13. Physically the mixer is

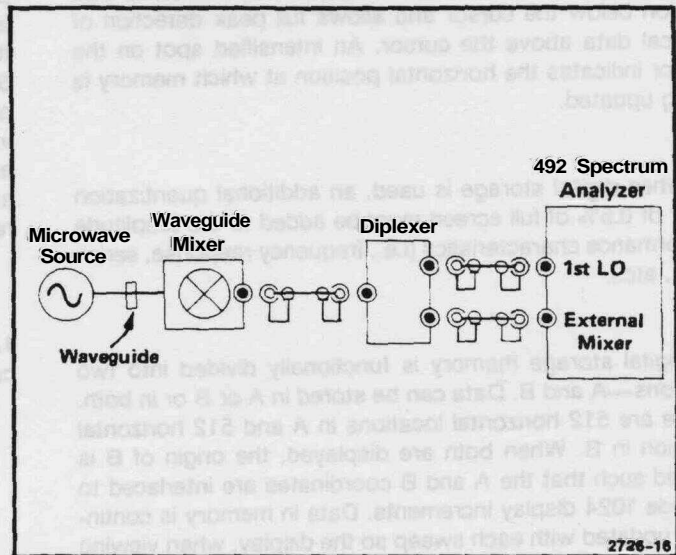

Fig. 3-13. External (Waveguide) mixer installation.

bolted to a waveguide flange at or near the rf signal source. A flexible cable is used to connect the mixer to the external Diplexer. Since the capacitance of the cable is capable of storing enough energy to destroy the mixer diode, connect the cable first to the EXT MIXER port of the Diplexer to discharge it before connecting to the mixer. For best performance use the recommended cable; do not extend its length. The Diplexer assembly includes a sma-to-tnc adapter and a shaped semi-rigid coaxial cable. Cable length is not critical; therefore, the semi-rigid cable can be replaced with different length cable.

When installing the mixer, make sure the flange surfaces are clean and free of scratches. Be sure to install and tighten all flange screws. This care will minimize input vswr and provide optimum frequency response.

Never apply more than +10 dBm of continuous rf energy to the input of the waveguide mixer port (see Specifications). The waveguide mixers saturate at -20 dBm (typical); therefore, little is gained with inputs above this level. If the input level is unknown, use the general purpose mixer or appropriate waveguide attenuator and RF power meter to test the input level.

The mixers require +7 dBm (min) to +15 dBm (max), typically +10 dBm, of LO signal with a variable bias from -2.0 V to +1.0 V through a current limiting resistor, to meet sensitivity and frequency response characteristics.

CAUTION

If your mixer requires positive-going bias, the 492/492P polarity can be reversed. Contact your service personnel or Tektronix field representative.

Activate the EXT MIXER pushbutton and adjust PEAKING for maximum response amplitude. The PEAKING control adjustment will produce more than one maximum through its range. Adjust for the maximum peak.

CAUTION

When EXT MIXER is activated or the FREQUENCY RANGE is in the waveguide bands (18 GHz and above), the internal RF attenuator is bypassed. The MIN RFATTEN control is inactive and the REF LEVEL cannot be set to a value less than -30 dBm.

Operation:

When using the waveguide mixers, many spurious responses will be displayed. A typical MAX SPAN display, generated by a -30 dBm signal at 40 GHz, is shown in Fig. 3-14. The true response must be identified before any analyses can be made.

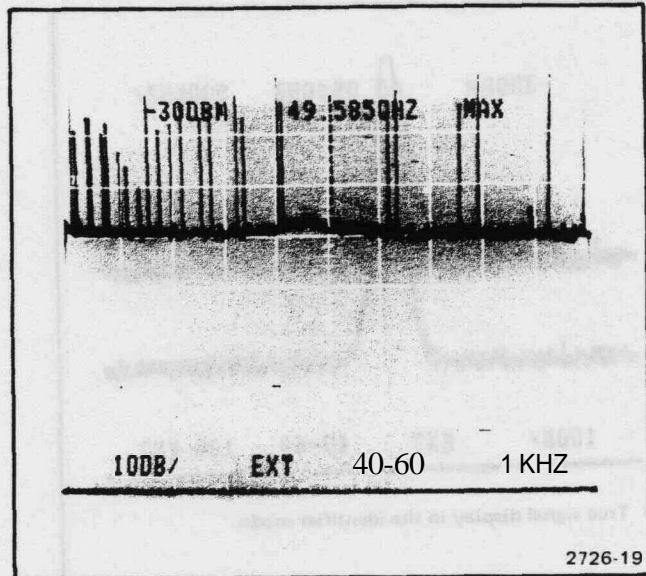

Fig. 3-14. Typical display generated by a signal into the waveguide mixer.

If the approximate frequency of the signal is known, select the FREQUENCY RANGE (band) and adjust FREQUENCY for the correct readout; then open the display with the SPAN/DIV selector and adjust FREQUENCY so the desired signal is at center screen. Adjust PEAKING over its range for maximum response; then reduce SPAN/DIV to 500 kHz so the IDENTIFIER feature can be used to verify that the signal is a true response.

When the IDENTIFIER mode is active, the display will alternately sweep between two levels (approximately two divisions as shown in Fig. 3-15). If the displayed signal is a true response, there will be no horizontal offset between the two displays. If the signal is a spurious response, there will be significant horizontal offset between the two displays (off screen in some cases). As the harmonic conversion number "n" increases, for the higher bands, the offset may be small. The accuracy of the center frequency readout is also a function of this conversion number; therefore, a cavity (resonant) wavemeter is recommended to aid in determining frequency. This is especially apparent in the millimeter-wave bands where the conversion number (n) is 10 or higher.

When the frequency of the input signal is unknown, the use of a cavity wavemeter is highly recommended;

Operation—492/492P Operators

otherwise, each signal must be analyzed with the IDENTIFIER until the true response is found. The wavemeter dip, when it is tuned to the input frequency, can be easily seen on a power meter connected into the signal path; otherwise, use the 2 dB/DIV display mode and adjust the wavemeter for a dip indication of the responses.

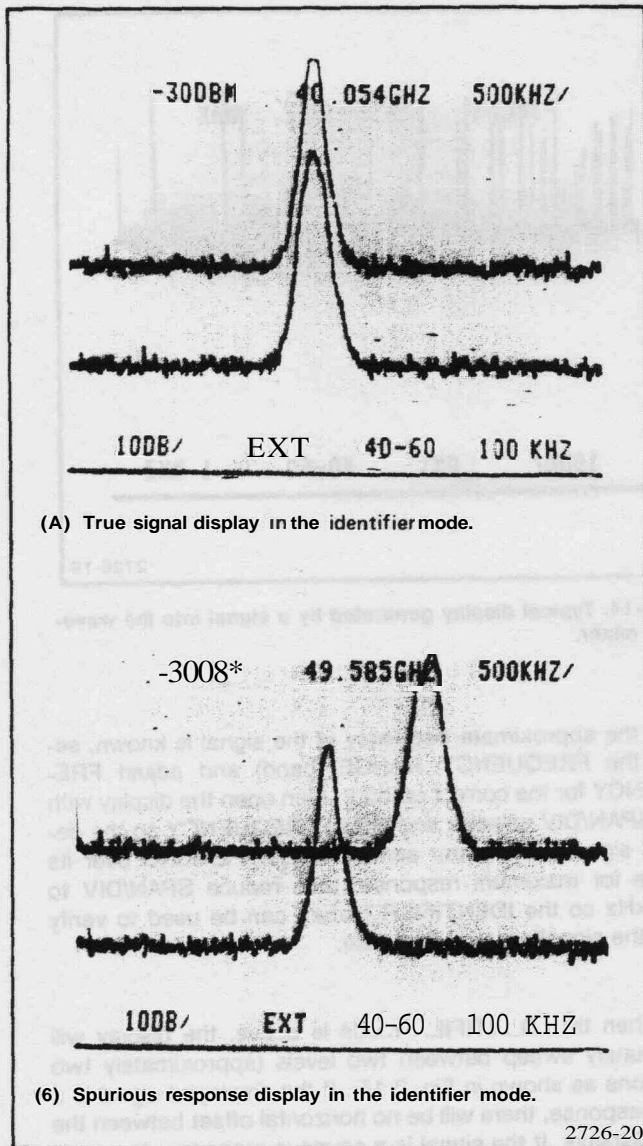

Fig. 3-15. Identifier mode displays.

The PEAKING control serves to adjust the tracking of the preselector (Option 01 instruments) for the coax bands and to adjust external mixer bias for the External Mixers in the waveguide bands. Adjust the PEAKING for maximum response through its range. (There are usually several peaks over the range of adjustment.) After any change in input signal frequency, readjust PEAKING to maintain sensitivity and frequency response characteristics.

Analyzing Signals

The following are operational precautions to observe when analyzing displays.

1. If the analyzer has digital storage, ensure that the cursor is at the bottom of the display or screen for peak detection. Digital storage averaging can obscure signals in the noise on wide spans.

2. Use AUTO RESOLUTION with care when measuring absolute amplitude level. Always use a bandwidth wider than the incidental FM level of the signal source.

3. The reference level is calibrated to compensate for the nominal conversion loss of the waveguide mixers in each waveguide band. Slight variations between mixers result in an amplitude accuracy of about ± 6 dB, including the ± 3 dB frequency response of each mixer. The absolute power level accuracy of each waveguide mixer/spectrum analyzer system can be calibrated to within 3 dB by adjusting the front panel AMPL CAL so the display amplitude of a known level external input signal to the mixer is correct.

492P GPIB CONTROLS, INDICATORS, and CONNECTORS

The 492P adds remote control to the features of the 492. Remote control is accomplished by a controller connected to the 492P through the General Purpose Interface Bus (GPIB—IEEE Std 488). The following is a description of the controls, indicators, and connectors that are unique to the 492P. See Figs. 3-16 and 3-18.

For a description of programming techniques for the 492P refer to the Programmer's manual.

RESET TO LOCAL (REMOTE)

This button is lighted when the GPIB controller takes remote control of the analyzer. While the 492P is under remote control, its other front-panel controls are not active, but indicators still reflect the current state of front-panel functions.

This button is not lighted when the operator has local control. While the analyzer is under local control, it does not execute GPIB messages that would conflict with front-panel controls or change the waveforms in digital storage.

Pressing this button restores local control unless the controller prevents this with the local lockout message.

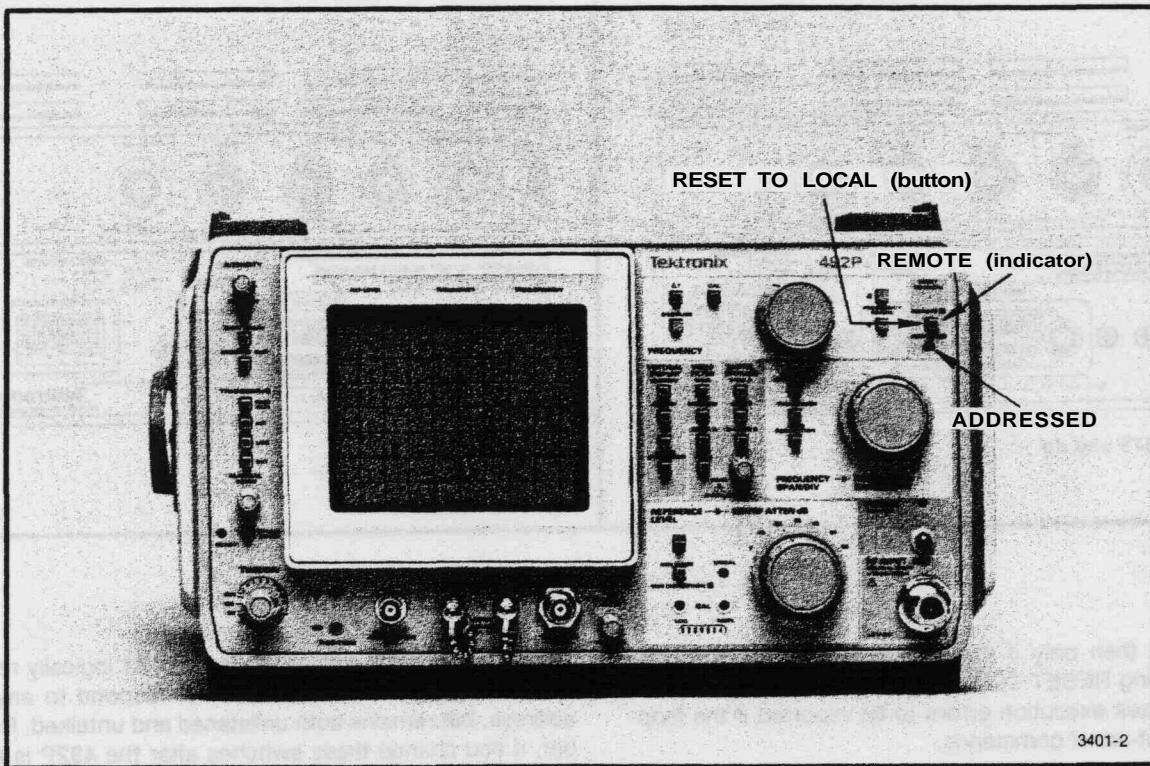

Fig. 3-16. GPIB control and indicators on the front panel.

Programmable functions do not change when switching from remote to local control except as necessary to match the settings of the front panel controls for TIME/DIV, MIN RF ATTEN, PEAKING, and PEAK/AVERAGE.

The internal 492P microcomputer flashes the firmware version number and GPIB address on the crt when the button is pressed. This also causes the microcomputer to up-

date the GPIB primary address if the GPIB ADDRESS switches have been changed.

This button has another function in talk-only mode. See Talk/Listen Only Operation that follows.

When the 492P is executing a message that includes the REPEAT command the REPEAT loop can only be aborted

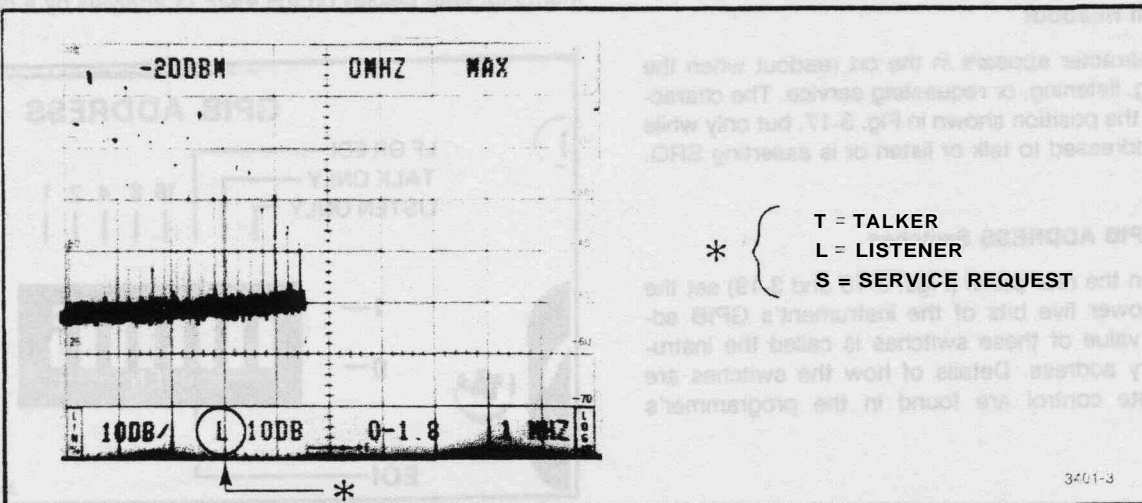

Fig. 3-17. Status of GPIB functions indicated when active.

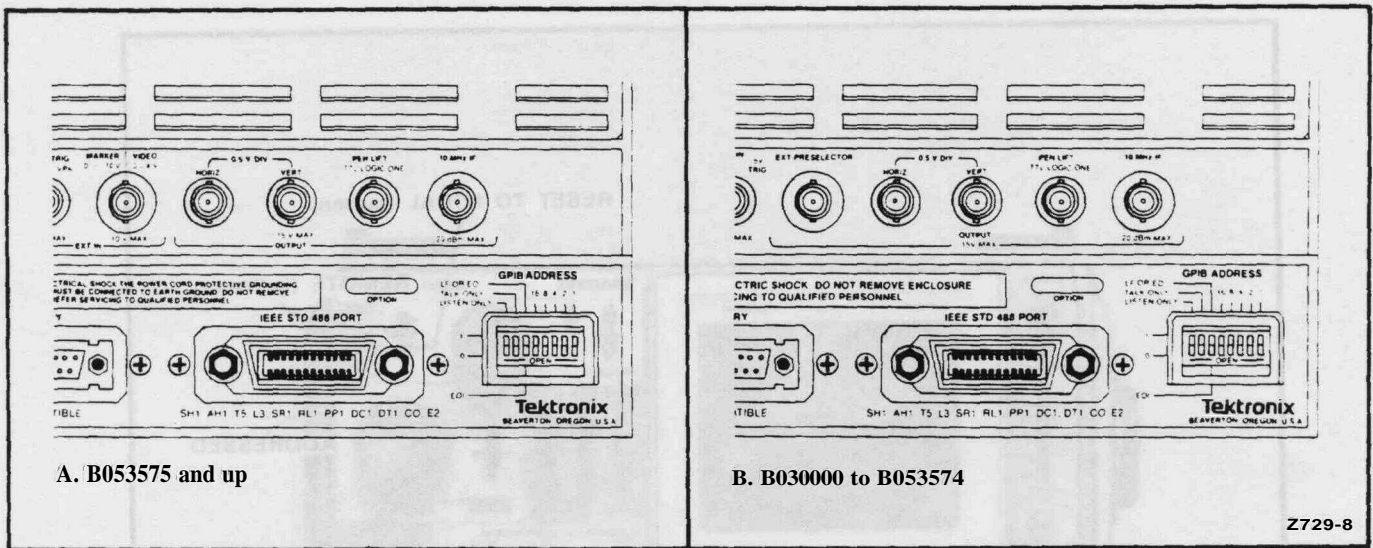

Fig. 3-18. The 492P GPIB Port and Switches.

by DCL and then only if the loop contains a WAIT command. Pressing RESET TO LOCAL does not abort the loop but only causes execution errors to be reported if the loop contains front-panel commands.

Beginning with version 1.2 firmware, pressing RESET TO LOCAL while a message including the REPEAT command is executing, limits message execution to 256 times if the message contains a WAIT. A SIGSWP command preceding WAIT in the message is ignored after the RESET TO LOCAL button is pressed so the REPEAT loop completes quickly.

ADDRESSED

Lights when analyzer is addressed to listen or talk.

GPIB Function Readout

A single character appears in the crt readout when the 492P is talking, listening, or requesting service. The character appears in the position shown in Fig. 3-17, but only while the 492P is addressed to talk or listen or is asserting SRQ.

Setting the GPIB ADDRESS Switches

Switches on the rear panel (Figs. 3-18 and 3-19) set the value of the lower five bits of the instrument's GPIB addresses. The value of these switches is called the instrument's primary address. Details of how the switches are used in remote control are found in the programmer's manual.

Set the switches as desired, but don't use 0 with 4050-Series controllers—they reserve this address for them-

selves. Selecting a primary address of 31 logically removes the 492P from the bus; it does not respond to any GPIB address, but remains both unlistened and untalked. Remember, if you change these switches after the 492P is already powered-up, you must press RESET TO LOCAL to cause the microcomputer to update the primary address.

492P TALK/LISTEN-ONLY OPERATION

The 492P can be operated as a talker only or a listener only on the GPIB under local control. A simple system requires only the 492P and a talker or listener. Such a system using the 4924 Digital Cartridge Tape drive is shown in Fig. 3-20.

This system can be used to save spectrum measurements for later display on the 492P or analysis by a control-

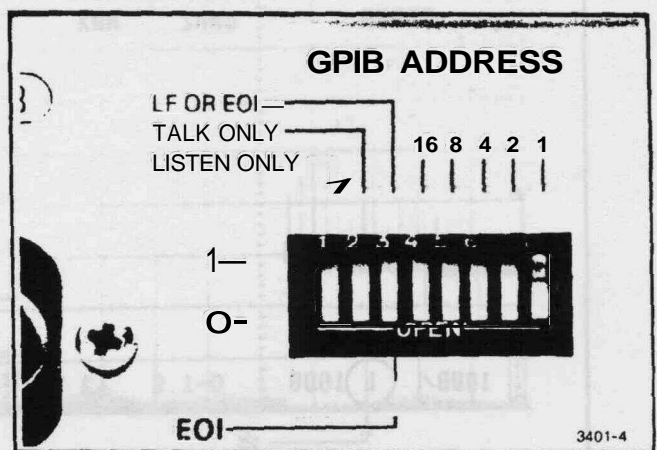

Fig. 3-19. GPIB Address switches on the rear panel.

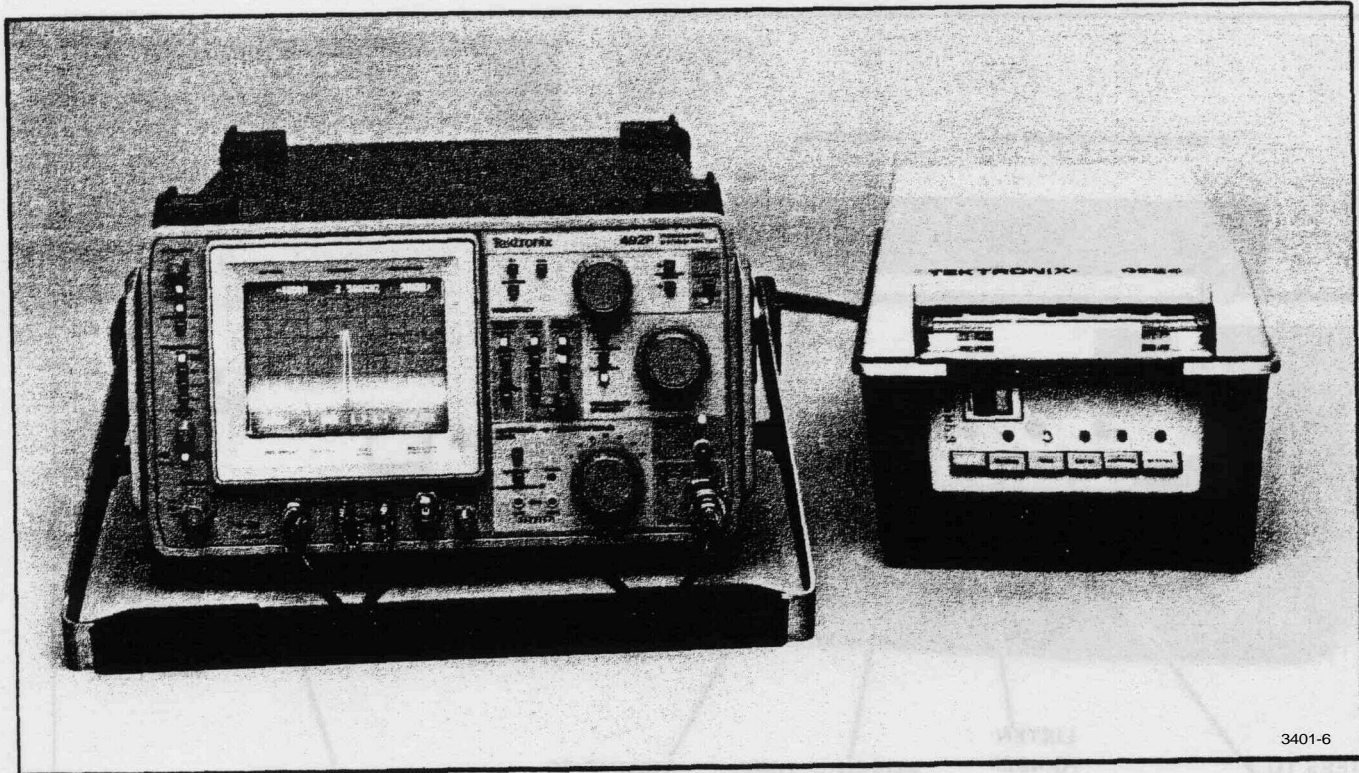

Fig. 3-20. The TEKTRONIX 4924 Digital Cartridge Tape Drive in a talk/listen-only system.

ler. This system can also be used to save and restore analyzer control settings.

TALK ONLY, LISTEN ONLY Switches

The 492P switches for talk-only and listen-only operation are part of the GPIB ADDRESS switch bank (Figs. 3-18 and 3-19). Set either or both switches—an extension of the IEEE 488 standard allows you to enable both talk-only and listen-only operation. If the 492P power is already on, press RESET TO LOCAL to cause a change in these switches to take effect.

Set the LF OR EOI switch to EOI for use with Tektronix equipment. The switches marked 1, 2, 4, 8, and 16 may be set to any combination except all ones (decimal 31), which logically disconnects the 492P from the bus.

The MODE CONTROL switches on the 4924 rear panel must be set as a pair to operate with the 492P. Set SW1 to ON and SW2 to OFF (same as for operating with the 4051) or set both switches to the same position (both SW1 and SW2 ON or OFF).

Data Logging

With the TALK ONLY switch set, you can write spectrum data on a tape in the 4924 using the controls shown in Fig. 3-21.

1. Insert a marked tape into the 4924. The tape must be previously marked for the size and number of files you expect to record (see the programmer's manual for tape marking).

2. Connect the 4924 and 492P with a GPIB cable after both are powered up.

3. Set the 4924 ON LINE switch out (off line).

4. Rewind the tape.

5. Press FORWRD to advance to file 1. Press FORWARD again, as desired, to reach a file further into the tape.

6. To save the current control settings and waveform in digital storage, press LISTEN on the 4924 and RESET TO LOCAL on the 492P.

Pressing the RESET TO LOCAL button causes the analyzer to transmit instrument settings and a waveform. The message is formatted so that when it is played back to the analyzer, it restores the settings and display. The message is a combination of the responses to the SET and CURVE queries.

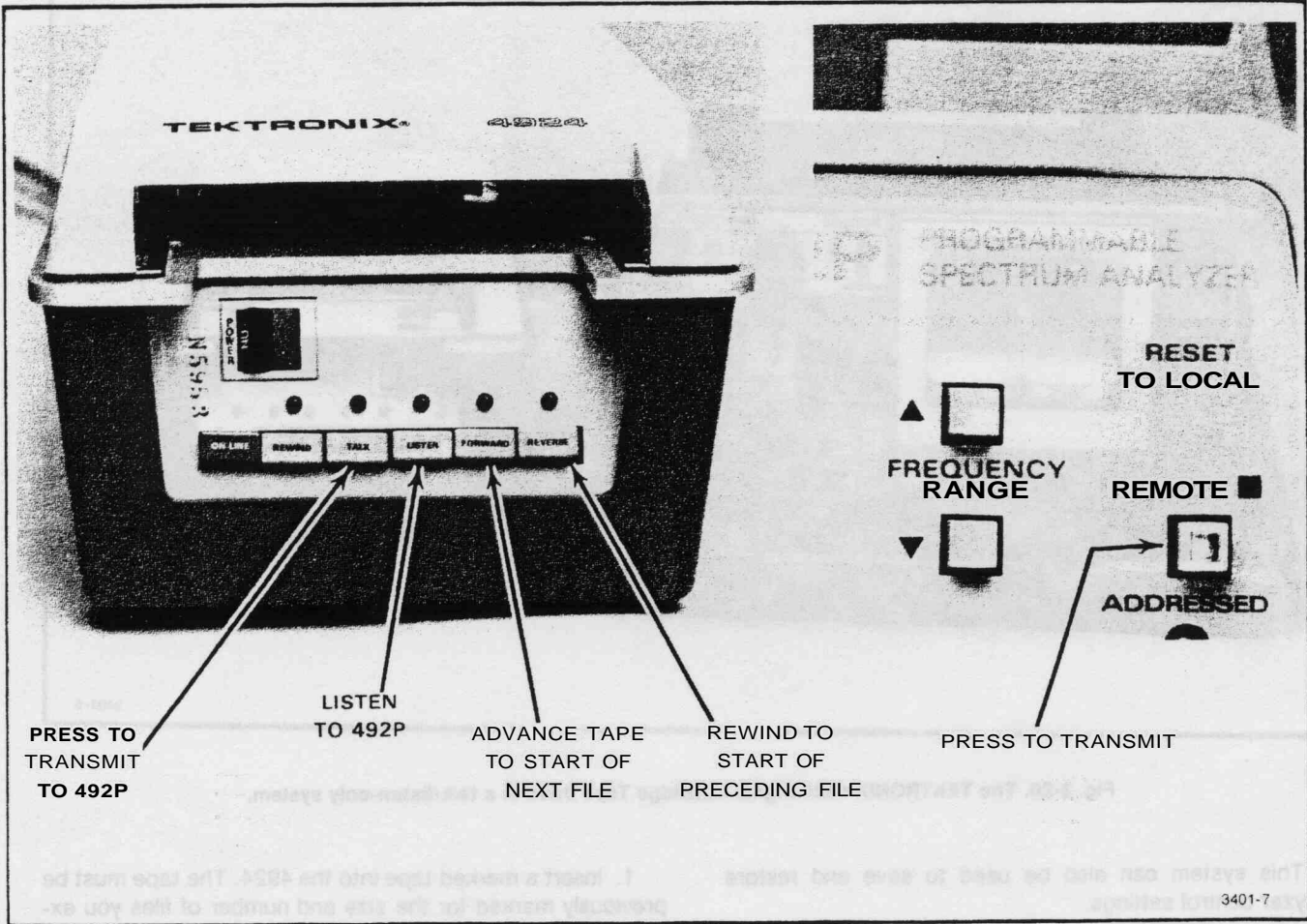
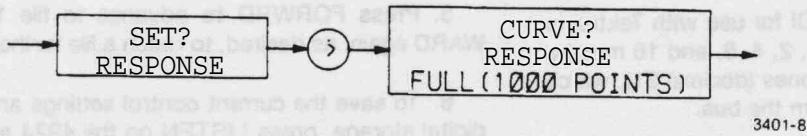
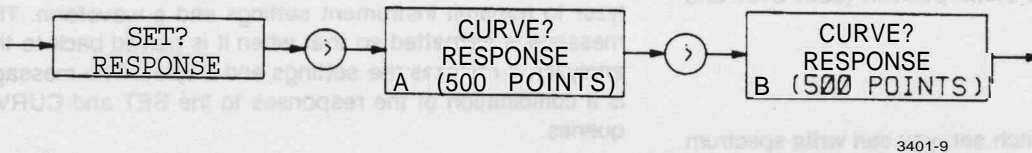

Fig. 3-21. Controls on the 4924 and 492P used for talk/listen-only data transfers.

If SAVE A is OFF, A and B are transmitted as a full waveform (A and B memories merged for 1000 points):



If SAVE A is ON, A and B are transmitted as separate waveforms (500 points each):



The analyzer transmits waveform data as ASCII-coded decimal numbers unless changed by the ENCDG argument in a WMPRE command. You'll find the full CURVE? response syntax diagram in Section 5 of the Programmer's manual. See Section 7 of the Programmer's manual for the full SET? response syntax diagram.

NOTE

If an internal switch is changed, the analyzer reports only control settings when RESET TO LOCAL is pressed. Refer questions about setting this internal switch to qualified service personnel.

The 4924 keeps listening (or talking if TALK is pressed) until the message transfer ends—there is no reset switch except for POWER. The 492P, once it starts talking, keeps talking until finished. It also cannot be interrupted except by turning off the power. (This is true only if the 492P begins transmitting—if there is no listener, it flashes a message to the operator and returns to local control.)

7. To move to the next file, press FORWARD. To move to the previous file, press REVERSE. To move to the beginning of the same file, press REVERSE, then FORWARD.

Restoring Control Settings and the Display

With the LISTEN ONLY switch set, the 492P buffers and executes device-dependent messages (except for interrupt control commands EOS and RQS). Since the remote-local state diagram in the IEEE 488 standard does not cover the listen-only mode, we have chosen to implement this mode so the 492P goes to remote state after buffering a message. This makes listen-only mode consistent with the nonlisten-only mode, which requires that the 492P be under remote control to execute commands that change front-panel settings or waveform data in digital storage.

To restore control settings and a display previously recorded:

1. Find the file on the tape using FORWARD or REVERSE on the 4924.
2. Press TALK. The 492P goes to remote to execute the message and then returns to local control.

Listen-only mode can be used for a comparison test. Settings and a waveform previously recorded with SAVE A on, can be played back to the analyzer. The analyzer automatically sets up to make the same measurement (turning on SAVE A), and saves the comparison waveform in A

memory. If B—SAVE A is selected, the operator can compare the current spectrum data being acquired in B memory to the saved waveform in A memory.

CONNECTING TO A SYSTEM

The 492P can be connected directly to a GPIB system with the cable supplied with the instrument. The GPIB port is shown in Fig. 3-18. To avoid interference on the bus, connect the 492P after turning on power or while the controller on the bus is turned off.

OPERATIONAL PRECAUTIONS

1. Measurements Outside the Specified Frequency and Tuning Range versus Span of the Display. Signal level or frequency measurements of signals outside the specified frequency range of the band are not reliable.

The total span of the display for some bands exceeds the frequency range; for example, the display extends below the 1.7 GHz lower limit of Band 2 and below the 15 GHz limit of Band 5 (15—21 GHz). The center frequency tuning range and the frequency indicating dot correspond to the specified frequency range of the band. Because of this difference, it can be confusing when the frequency dot fails to tune across a full MAX span display, or a displayed signal outside the frequency range of the band will not tune to center screen. This occurs in Bands 1 and 2 of Option 01 instruments and in Band 5 (15—21 GHz) of all instruments.

The frequency range for external mixer bands is commensurate with the frequency range of the Waveguide Mixers. The span of the displays, however, for these external mixer bands, is much wider. Band 6 (18—26.5 GHz) for example, displays at least a 15—39 GHz span.

2. Signal FM. Check to see if the PHASE LOCK switch is activated before deciding that the displayed signal is FM'ing or the spectrum analyzer is malfunctioning.

3. Correct Trigger Mode. The triggering mode is usually in FREE RUN. In pulsed RF applications, a triggered display is required to measure between pulse repetition lines for determining the pulse repetition rate.

Since INTERNAL triggering requires one or more division of signal amplitude, tune the center frequency so a reasonable sized signal is located at the sweep start before changing the trigger source from FREE RUN to INT.

4. Level of Pulsed Signals. The spectrum for a pulsed signal is spread out. Consequently, the height of the crt response is less for a pulsed signal than for a cw signal of the same peak amplitude. This loss in display height means in effect a loss in sensitivity. The amount of loss can be computed from:

$$\text{Voltage loss} = (t_0 B)^{-1} \text{ where}$$

t_0 = pulse duty cycle
 B = resolution bandwidth

The spectrum analyzer self-generated noise power increase is proportional to bandwidth. Pulsed RF voltage level is also proportional. Since power is proportional to voltage squared, a wider bandwidth gives better sensitivity and greater dynamic range for pulsed RF inputs.

When in doubt about signal level overdrive problems, reduce the signal level by inserting RF attenuation, then repeat the measurement. If the two agree, the measurement is correct; if not, the input mixer stage is probably overdriven.

An important consideration for pulsed RF measurements is the peak signal level at the mixer; it is greater by $(t_0 B)^{-1}$ than the peak level displayed on the crt. Taking the sensitivity loss into account is the only sure way of ascertaining that the mixer peak power input for linear operation is not exceeded.

5. Level of Continuous Wave Signals. Similar problems can occur when analyzing cw signals at relatively narrow span widths. The large cw signal may not appear on screen because its frequency is outside the set span width. The mixer nevertheless is saturated and will compress signals.

6. Excessive Input Signal Level. Too much input power will destroy the front end mixer or attenuator. Replacement mixers and attenuators are costly. When working with high power signals, use couplers or other devices to reduce the signal down to acceptable levels. Once the signal is down below the rating of the RF attenuator, prevent possible mixer damage by starting with the MIN RF ATTEN fully in, then reduce attenuation if needed.

7. No Crt Trace. The BASELINE CLIP is used to reduce the intensity of the baseline. If Triggering, Intensity, Vertical Position, etc., all seem to be in order and there is no crt trace, check the BASELINE CLIP state.

8. Digital Storage Effects on Signal Analyses. When operating with digital storage, the frequency base is divided

into storage slots. For peak displays (above the PEAK/AVERAGE cursor) the display point in each slot corresponds to the maximum sampled value of the signal. Samples are taken at about 9 μ s intervals. When sweeping at one second per division this is about 1000 samples per slot. For average displays (below the cursor) the values of all samples per slot are summed and divided by the number of samples to compute the display point for each slot. Each display point is interconnected to create a smooth display. When A or B are displayed independently, only half of the slots are interconnected. The following are a few pitfalls that can occur.

For wide spans and relatively narrow resolution bandwidth (50 or more resolutions per division), the resolution bandwidth equals a digital storage slot. If that slot is in A memory and only B memory is displayed, that point of the signal will not be displayed and an erroneous level would result. SAVE A will display the correct value because an algorithm chooses the larger of adjacent display points to store in A memory.

If the PEAK/AVERAGE cursor is set above the signal level, the average value for each digital slot will be displayed. With narrow resolution bandwidths compared to the slot width, the average value of the resolution response shape will be displayed, which has nothing to do with signal amplitude.

To avoid the above pitfalls, it is best to run digital storage with A and B interlaced. Do not set the PEAK/AVERAGE cursor to average a cw signal. It is best to set the cursor about 1/4 division above the signal to be averaged and about 1/2 division below the signal to be analyzed.

None of these restrictions apply when the resolution bandwidth is wide compared to a digital storage slot (e.g., 50 MHz/div with 1 MHz resolution).

9. Stored Display Averaged in Wide Spans. When operating in wide spans, with digital storage, low level signals will be averaged with the noise and lost if the PEAK/AVERAGE cursor is above the display. Turn the control fully counterclockwise for peak detection when operating with wide spans.

10. Cold Storage or Power-Interrupt Initialization. After storage below the operating temperature range (see Environmental Characteristics under Specification), the microcomputer may not power up correctly. If so, allow the instrument to warm up for at least 15 minutes and reinitialize the microcomputer; turn power off for five seconds, then turn it back on. Repeat, if necessary. It may also be necessary to reinitialize the microcomputer after a power interruption.

Service Manual

The 492/492P Service Instruction manuals are separate publications that include circuit description, troubleshooting information, calibration procedures, schematic diagrams, and other maintenance information. Service manuals are intended for use by QUALIFIED SERVICE PERSONNEL ONLY. To avoid electrical shock, DO NOT perform any servicing unless qualified to do so.

Product Service

To assure adequate product service and maintenance for our instruments, Tektronix, Inc. has established Field Offices and Service Centers at strategic points throughout the United States and outside the United States in all countries where our products are sold. Contact your local Service Center, representative or sales engineer for details regarding: Warranty, Calibration, Emergency Repair, Repair Parts, Scheduled Maintenance, Maintenance Agreements, Pickup

and Delivery, On-Site Service for fixed installations, and other services available through these centers.

Emergency Repair. This service provides immediate attention to instrument malfunction if you are in an emergency situation such as a field trip. Again, contact any Tektronix Service center for assistance to get you on your way within a minimum of time.

Maintenance Agreements. Several types of maintenance or repair agreements are available. For example: for a fixed fee, a maintenance agreement program provides maintenance and recalibration on a regular basis. Tektronix, Inc. will remind you when a product is due for recalibration and perform the service within a specified time-frame. Any Service Center can furnish complete information on costs and types of maintenance programs.

OPTION INFORMATION

Information on or about options for the 492/492P is integrated into the appropriate sections of the manual and clearly identified. At this bind, the following options are available and information is provided in the text:

Option 01: Adds preselector ahead of the 1st mixer, see Section 1.

Option 02: Adds digital storage, see Section 1.

Option 03: Adds 1st LO phase lock, see Section 1.

Option 08: Removes External Mixer capability, see Section 1.

Option 20: Includes General Purpose Waveguide Mixers, 12.4—40.0 GHz, see Section 1.

Option 21: Includes High Performance Waveguide Mixers, 18—40 GHz, see Section 1.

Option 22: Includes High Performance Waveguide Mixers, 18—60 GHz, see Section 1.

Option 30: Rackmount version of 492/492P, see Section 1.

Option 31: Rackmount version with access to the front panel connectors at the back panel of the cabinet, see Section 1.

Option 32: Benchtop version of 492/492P, see Section 1.

GLOSSARY

The following glossary is presented as an aid to better understand the terms as they are used in this document.

General Terms

Baseline Clipper (Intensifier). Increases the brightness of the signal relative to the baseline portion of the display.

Center Frequency. That frequency which corresponds to the center of a frequency span, expressed in hertz.

Effective Frequency Range. That range of frequency over which the instrument performance is specified. The lower and upper limits are expressed in hertz.

Envelope Display. The display produced on a spectrum analyzer when the resolution bandwidth is greater than the spacing of the individual frequency components.

Frequency Band. A part of effective frequency range over which the frequency can be adjusted, expressed in hertz.

Full Span (Maximum Span). A mode of operation in which the spectrum analyzer scans an entire frequency band.

Intermodulation Spurious Response (Intermodulation Distortion). An unwanted spectrum analyzer response resulting from the mixing of the n th order frequencies. This is due to non-linear elements of the spectrum analyzer, resulting in an unwanted spurious response being displayed.

Line Display. The display produced on a spectrum analyzer when the resolution bandwidth is less than the spacing of the signal amplitudes of the individual frequency components.

Line Spectrum. A spectrum composed of signal amplitudes of the discrete frequency components.

Maximum Safe Input Power

WITHOUT DAMAGE. The maximum power applied at the input which will not cause degradation of the instrument characteristics.

WITH DAMAGE. The minimum power applied at the input which will damage the instrument.

Pulse Stretcher. A pulse shaper that produces an output pulse, whose duration is greater than that of the input pulse, and whose amplitude is proportional to that of the peak amplitude of the input pulse.

Scanning Velocity. Frequency span divided by sweep time and expressed in hertz per second.

Signal Identifier. A means to identify the spectrum of the input signal when spurious responses are possible.

Spectrum Analyzer. An apparatus which is generally used to display the power distribution of an incoming signal as a function of frequency.

NOTE

It is useful in analyzing the characteristics of repetitive electrical waveforms in general, since repetitively sweeping through the frequency range of interest will display all components of the signal.

Video Filter. A post detection low-pass filter.

Zero Span. A mode of operation in which the frequency span is reduced to zero.

Terms Related to Frequency

Display Frequency. The input frequency as indicated by the spectrum analyzer and expressed in hertz.

Frequency Drift. Gradual shift or change in displayed frequency over the specified time due to internal changes in the spectrum analyzer, and expressed in hertz per second, where other conditions remain constant.

Frequency Linearity Error. The error of the relationship between the frequency of the input signal and the frequency displayed (expressed as a ratio).

Frequency Span (Dispersion). The magnitude of the frequency band displayed, expressed in hertz or hertz per division.

Impulse Bandwidth. The displayed spectral level of an applied pulse divided by its spectral voltage density level assumed to be flat within the pass-band.

Residual FM (Incidental FM). Short term displayed frequency instability or jitter due to instability in the spectrum analyzer local oscillators, given in terms of peak-to-peak frequency deviation and expressed in hertz or percent of the displayed frequency.

Shape Factor (Skirt Selectivity). The ratio of the frequency separation of the two (60 dB/6 dB) down points on the response curve to the static resolution bandwidth.

Static (Amplifier) Resolution Bandwidth. The specified bandwidth of the spectrum analyzer's response to a cw signal, if sweep time is kept substantially long.

NOTE

This bandwidth is the frequency separation of two down points, usually 6 dB, on the response curve, if it is measured either by manual scan (true static method) or by using a very low sweep speed (quasi-static method).

Zero Pip (Response). An output indication which corresponds to zero input frequency.

Terms Related to Amplitude

Deflection Coefficient. The ratio of the input signal magnitude to the resultant output indication.

NOTE

The ratio may be expressed in terms of volts (rms) per division, decibels per division, watts per division, or any other specified factor.

Display Dynamic Range. The maximum ratio of the levels of two non-harmonically related sinusoidal signals each of which can be simultaneously measured on the screen to a specified accuracy.

Display Flatness. The unwanted variation of the displayed amplitude over a specified frequency span, expressed in decibels.

Display Law. The mathematical law that defines the input-output function of the instrument.

NOTE

The following cases apply:

1. **Linear**—A display in which the scale divisions are a linear function of the input signal voltage.
2. **Square law (power)**—A display in which the scale divisions are a linear function of the input signal power.
3. **Logarithmic**—A display in which the scale divisions are a logarithmic function of the input signal voltage.

Display Reference Level. A designated vertical position representing a specified input level.

NOTE

The level may be expressed in decibels (e.g., 1 mW), volts, or any other units.

Dynamic Range. The maximum ratio of the levels of two signals simultaneously present at the input which can be measured to a specified accuracy.

Equivalent Input Noise Sensitivity. The average level of a spectrum analyzer's internally generated noise referenced to the input.

Frequency Response. The unwanted variation of the displayed amplitude over a specified center frequency range, measured at the center frequency, expressed in decibels.

Gain Compression. Maximum input level where the scale linearity error is below that specified.

Hum Sidebands. Undesired responses created within the spectrum analyzer, appearing on the display, that are separated from the desired response by the fundamental or harmonic of the power line frequency.

Input Impedance. The impedance at the desired input terminal.

NOTE

Usually expressed in terms of VSWR, return loss, or other related terms for low impedance devices and resistance-capacitance parameters for high impedance devices.

Noise Sidebands. Undesired response caused by noise internal to the spectrum analyzer that appears on the display around a desired response.

Relative Display Flatness. The display flatness measured relative to the display amplitude at a fixed frequency within the frequency span, expressed in decibels.

NOTE

Display flatness is closely related to frequency response. The main difference is that the spectrum display is not recentered.

Residual Response. A spurious response in the absence of an input signal. (Noise and zero pick are excluded.)

Sensitivity. Measure of a spectrum analyzer's ability to display minimum level signals, at a given IF bandwidth, display mode, and any other influencing factors, and expressed in decibels (e.g., 1 mW).

Spurious Response. A response of a spectrum analyzer wherein the displayed frequency does not conform to the input frequency.

Terms Related to Digital Storage for Spectrum Analyzers

Clear (Erase). Presets memory to a prescribed state, usually that denoting zero.

Digitally Averaged Display. A display of the average value of digitized data computed by combining serial samples in a defined manner.

Digitally Stored Display. A display method whereby the displayed function is held in a digital memory. The display is generated by reading the data out of memory.

Max Hold (Peak Mode). Digitally stored display mode which, at each frequency address, compares the incoming signal level to the stored level and retains the greater. In this mode, the display indicates the peak level at each frequency after several successive sweeps.

Multiple Display Memory. A digitally stored display having multiple memory sections which can be displayed separately or simultaneously.

Save. A function that inhibits storage update, saving existing data in a section of a multiple memory (e.g., Save A).

Scan Address. A number representing each horizontal data position increment on a directed beam type display. An address in a memory is associated with each scan address.

View (Display). Enables viewing of contents of the chosen memory section (e.g., "View A" displays contents of memory A; "View B" displays the contents of memory B).