



**INSTRUCTION MANUAL** **511A**  
CATHODE RAY OSCILLOSCOPE TYPE





# TEKTRONIX

## TYPE 511A TYPE 511AD

### CATHODE-RAY OSCILLOSCOPE

# INSTRUCTION MANUAL

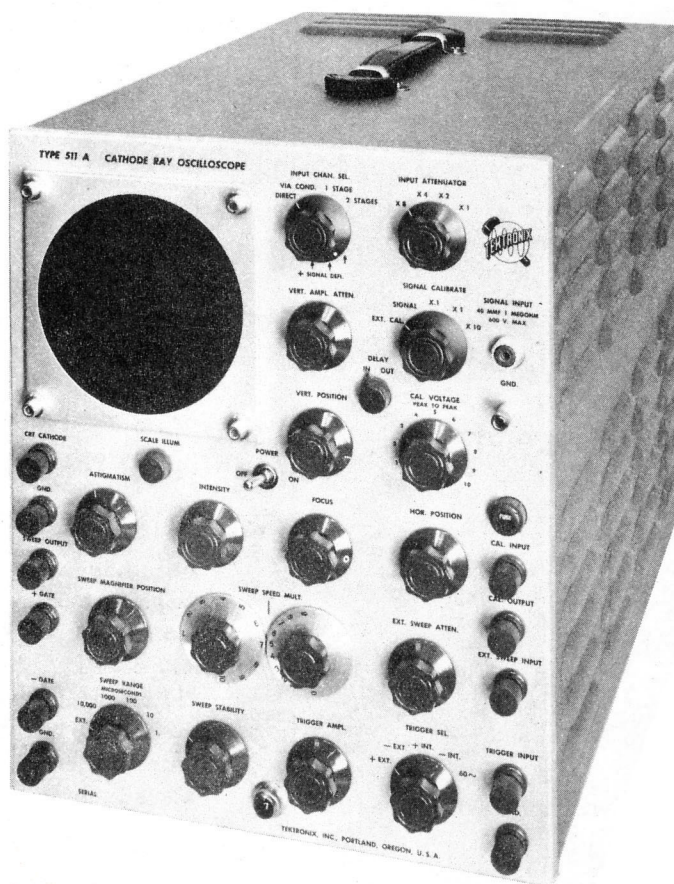

Manufacturers of Cathode-Ray and Video Test Instruments

712 S. E. Hawthorne Blvd. Portland 14, Oregon - EAst 6197 - Cables: Tektronix

## TABLE OF CONTENTS

### SECTION I.

General Description.  
Characteristics.  
Functions of Controls and Binding Posts.

### SECTION II. OPERATING INSTRUCTIONS.

#### Sweep Circuit Adjustments.

Adjustment of sweep stability.  
Function of trigger selector.  
Adjustment of trigger amplitude.  
Adjustment of sweep speed.  
Recurrent sweep.  
Single sweep.  
Ext. sweep input.

#### Vertical Deflection System.

Sweep magnifier.  
Video amplifier.  
Direct connection to deflection plates.

#### Calibration.

Signal calibrate switch.  
Measurement of signal amplitudes.

#### Intensity Modulation (Z axis).

#### Sweep Output.

#### Gate Outputs.

### SECTION III. CIRCUIT DESCRIPTION.

#### Cathode Ray Tube Circuit.

#### Sweep Chassis.

Trigger phase splitter.  
Trigger amplifier.  
Trigger coupling diode.  
Multivibrator.  
Unblanking circuit.  
Gate output generator.  
Sweep generator.  
Sweep output cathode follower.  
Sweep magnifier.  
Sweep amplifier.

#### Vertical Deflection System.

Probe.  
Input attenuator.  
Video amplifier.  
Calibrating circuits.

#### Power Supply.

### SECTION IV. MAINTENANCE AND ADJUSTMENT.

#### MAINTENANCE.

##### Removal of Case.

##### Cleaning.

##### Inspection.

##### Trouble Analyzing and Repair.

General.  
Absence of power.  
Absence of spot on cathode ray tube.  
Power supply.  
Sweep circuits.  
Trigger circuits.  
Video amplifier.

##### Voltage and Continuity Tables.

Average tube socket voltages.  
Point to point socket continuity.  
Transformer continuity.

#### WAVEFORM PHOTOGRAPHS.

##### Deflection Polarity Selector Waveforms.

##### Power Supply Waveforms.

##### Sweep and Trigger Circuit Waveforms.

##### Video Amplifier Waveforms.

#### ADJUSTMENT.

##### Operation on 210-250 Volt Line.

##### Adjustment of 225 Volt Regulated Supply.

##### Adjustment of Sweep Speed Calibration.

##### Adjustment of Input Attenuator.

##### Adjustment of Video Amplifier H.F. Response.

##### Adjustment of Video Amplifier L.F. Response.

#### INTERIOR PHOTOGRAPHS.

### SECTION V. PARTS LIST.

#### Abbreviations.

#### Capacitors.

#### Inductors.

#### Resistors.

#### Tube Complement.

#### Switches.

#### Transformers.

#### Miscellaneous.

#### Warranty.

### SECTION VI. DIAGRAMS.

#### Block Diagram.

#### Sweep and Trigger Circuits.

#### Video Amplifier and CRT Circuits.

#### Power Supply Circuits.

### SECTION VII. VIDEO DELAY NETWORK.



## SWEEP SPEED MULTIPLIER MODIFICATION

The dual 2 megohm potentiometer Sweep Speed Mult. control formerly employed in the Type 511A-AD oscilloscope has been replaced with a combination consisting of a ten position step control and a separate variable control. The step control resistance may be varied from 0 to 1.8 megohms and the variable control provides fill-in between steps, thus permitting continuously variable adjustment of sweep speed between positions of the Sweep Range switch. Since 100 dial divisions are provided for each 10:1 sweep speed range, very accurate indication is obtained.

The sum of the Sweep Speed Mult. control readings multiplied by the Sweep Range switch setting indicates the sweep time in microseconds for a 10 centimeter deflection.

### SWEEP CIRCUIT CHANGES

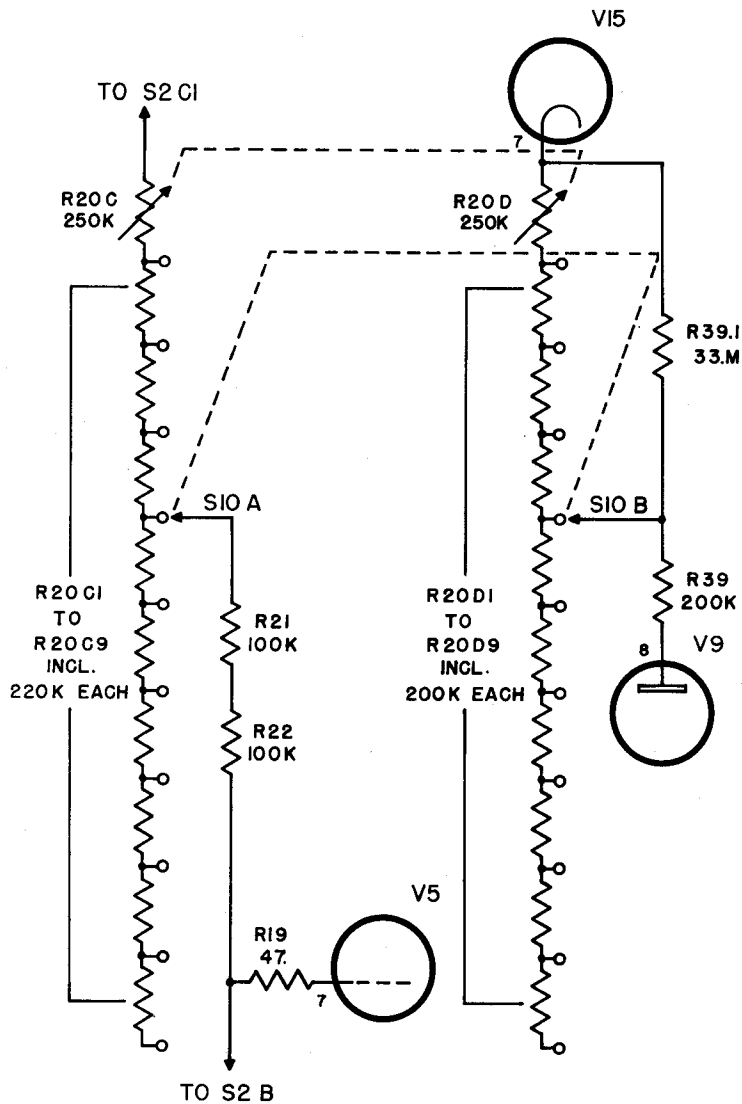





## SECTION I

### GENERAL DESCRIPTION

The Tektronix Type 511-A Cathode Ray Oscilloscope is a wide range, portable instrument, making possible the observation of a wide variety of electrical waveshapes. It is primarily intended for laboratory and shop use, in the development and testing of all types of electronic equipment.

The Type 511-AD Oscilloscope is identical to the Type 511-A except that it includes a factory installed Type 1-AD-25 Delay Network, which is described in Section VII of this manual.

### CHARACTERISTICS

#### Signal observable

1. Sine waves from 10 cycles to 10 mc.
2. Pulses of .1 microsecond to 1/50 sec.

#### Sweep Circuit

Hard tube type, either triggered or recurrent as desired.

#### Sweep Speeds

Continuously variable from .01 sec. per cm to .1 microsecond per cm.

#### Trigger Requirements

.5 to 50 V (Peak) sine wave or pulse of either polarity. Pulse as short as .05 microsecond will trigger satisfactorily. A key connected between TRIGGER INPUT and GND. is suitable for triggering single sweeps.

#### Sweep Lag

CRT is unblanked and sweep is operating linearly in less than .1 microsecond after receipt of an infinitely sharp trigger pulse.

#### Sweep Magnification

Any desired 20% of the sweep can be spread over the entire trace except for sweep speeds faster than .5 microsecond per cm.

#### External Sweep Input

DC coupled via 100 K potentiometer and sweep amplifier.

Maximum deflection sensitivity 1.5 V per cm DC or peak to peak AC. Band width, DC to 800 kc (3 db down at 800 kc).

#### Vertical Deflection Circuit

Switch permits signal input connector on panel to be connected to deflection plates directly, via capacitor (RC=.1 sec), via 1 amplifier stage, or via 2 amplifier stages.

#### Input Attenuator

Frequency compensated RC type with attenuation ratios of 2, 4, and 8.

#### Vertical Deflection Sensitivity

Without amplifier 27 V per cm maximum, 200 V per cm minimum, DC or peak to peak AC.

1 Stage, 2.7 V per cm maximum, 40 V per cm minimum.

2 Stages, .27 V per cm maximum, 4 V per cm minimum.

(Sensitivity is reduced by a factor of 10 when probe is used.)

**In no case should the combined AC and DC input voltages exceed 600 V peak.**

#### Input Impedance

1 meg shunted by 40 mmfd ( $\pm 5\%$ ) for any setting of the input selector and input attenuator.

With probe, 10 megohms shunted by 14 mmfd.

#### Vertical Amplifier Bandwidth

1 stage, down 3 db (Max) (from 1 mc response) at 5 cps and 10 mc.

2 stages, down 3 db (Max) (from 1 mc response) at 5 cps and 8 mc.

#### Vertical Amplifier Transient Response

Rise time, 1 stage .04 microsecond (10% to 90%)

2 stages .05 microsecond (10% to 90%)

#### Calibrating Voltage

Sine wave of power line frequency. Three ranges 0-1, 0-10, 0-100 v. peak to peak. Accuracy for line voltage of 117 v. is  $\pm 5\%$  of full scale. May be measured with external meter when greater accuracy is required. A position on the SIGNAL CALIBRATE switch allows the use of an external calibrating source when desired.

#### Waveforms available externally.

Sweep sawtooth, 20 volts peak.

Positive and negative gate, 40 V. peak, same duration as sweep.

#### Connection to CRT Cathode

via .1 mfd capacitor. RC=.012 sec.

#### Accelerating voltage on cathode ray tube, 3 KV.

Power Requirements. 105-125 volts, or 210-250 volts, 50-60 cycles, 230 watts. (See Section IV.)

#### Weight. 50 pounds.

Dimensions. 15½" high, 12½" wide, 21½" deep.

Finish. Panel, photo etched aluminum with black letters. Cabinet, gray wrinkle.

### FUNCTIONS OF CONTROLS AND BINDING POSTS

A brief explanation of the function of each control and binding post is given below. For a more detailed explanation consult Section III, Circuit Description.

PANEL MARKINGS	EXPLANATION		
INPUT CHAN. SEL.	Gang switch permitting the SIGNAL INPUT binding post to be connected to the vertical deflection plates either directly, via a .1 mfd capacitor, 1 stage amplifier, or 2 stage amplifier.	INTENSITY	Potentiometer controlling the average grid voltage of the CRT and thereby the brightness of the image.
INPUT ATTENUATOR	Four position RC compensated attenuator located between the SIGNAL INPUT binding post and INPUT CHAN. SEL. for reducing the voltage of signals which would otherwise produce excessive deflection or overload the amplifiers.	POWER	On-off switch in the AC line voltage supply to the oscilloscope.
VERT. AMPL. ATTEN.	500 ohm potentiometer in cathode of cathode follower permits adjusting gain of signal amplifier.	FOCUS	Potentiometer controlling the voltage applied to the focus anode of the CRT and thereby the sharpness of the image.
SIGNAL CALIBRATE	Switch which connects arm of INPUT CHAN. SEL. to EXT. CAL. binding post, SIGNAL INPUT binding post, or line frequency calibrating voltage.	HOR. POSITION	Potentiometer controlling the bias applied to grid of one sweep amplifier tube and thereby the position of the image.
SIGNAL INPUT	Coaxial connector permits connection of the low capacity probe or binding post adapter.	SWEEP OUTPUT	Binding post connected to sweep generator via cathode follower.
DELAY (511-AD only)	Two position switch which permits the Type 1AD25 Delay Network to be switched in or out of the video amplifier.	SWEEP MAGNIFIER POSITION	Potentiometer controlling voltage applied to grid of sweep magnifier (V11) and thereby determining portion of sweep to be magnified. When turned to OUT sweep magnifier is disconnected from the circuit.
VERT. POSITION	Twin potentiometers controlling average potentials of vertical deflection plates and therefore the image position.	SWEEP SPEED MULT.	Twin variable resistors controlling time constant of sweep generator and period of multivibrator, thereby determining sweep speed and duration within range set by SWEEP RANGE.
CAL. VOLTAGE	Potentiometer for adjusting the line frequency calibrating voltage on scales determined by the setting of the SIGNAL CALIBRATE switch.	EXT. SWEEP ATTEN.	Potentiometer controlling the fraction of the voltage applied to EXT. SWEEP INPUT binding post which will reach the grid of the sweep amplifiers when the SWEEP RANGE switch is set in the EXT. position.
CRT CATHODE	Binding post permitting connection of external modulating signals to the cathode of the cathode ray tube via a .1 mfd capacitor. RC=.012 sec.	EXT. SWEEP INPUT	Binding post connecting to sweep amplifier via EXT. SWEEP ATTEN. when SWEEP RANGE switch is in EXT. position. (100 K input impedance).
GND.	Connection to frame of oscilloscope.	CAL. INPUT	Binding post connecting to EXT. CAL. position of SIGNAL CALIBRATE switch permitting an external calibrating signal source to be permanently connected to the oscilloscope. May be used as auxiliary signal input
ASTIGMATISM	Potentiometer varying potential on Anode No. 2 with respect to the deflection plates. Correct adjustment of this control makes possible a sharp focus of the image in both directions simultaneously.	CAL. OUTPUT	Binding post connected to arm of CAL. VOLTAGE potentiometer permits measurement of calibrating voltage by an external voltmeter. Useful as calibrated test signal.
SCALE ILLUM.	Variable resistor controlling brightness of the lamp which illuminates the plastic graticule over the face of the cathode ray tube.	+ GATE	Binding post for connection to the cathode of the gate phase splitter (V8). This furnishes a 40 V peak positive pulse of the same duration as the sweep.



- GATE Binding post for connection via .1 capacitor to the plate of (V8). This furnishes a 40 V negative pulse of the same duration as the sweep.
- SWEEP RANGE Gang switch selecting appropriate coupling capacitors determining multivibrator length and sweep speed. When set to EXT. the sweep amplifier is connected to EXT. SWEEP INPUT post in place of the oscilloscope's linear sweep.
- SWEEP STABILITY Variable resistor controlling bias on grid of V4 in the multivibrator circuit. This bias determines whether the sweep will operate recurrently or must be triggered.
- TRIGGER SEL. Switch determining source and polarity of trigger voltage.
- TRIGGER AMPL. Potentiometer controlling the bias applied to the trigger amplifier tube (V2) and thereby determining the amplitude of trigger signals applied to the multivibrator.
- TRIGGER INPUT Binding post connecting external trigger sources to +EXT. and -EXT. position of TRIGGER SEL. switch.
- DEFLECTION POLARITY Three position lever switch mounted at the rear, which permits the operating bias of V19 to be varied, thus providing greater undistorted deflection when observing pulses.

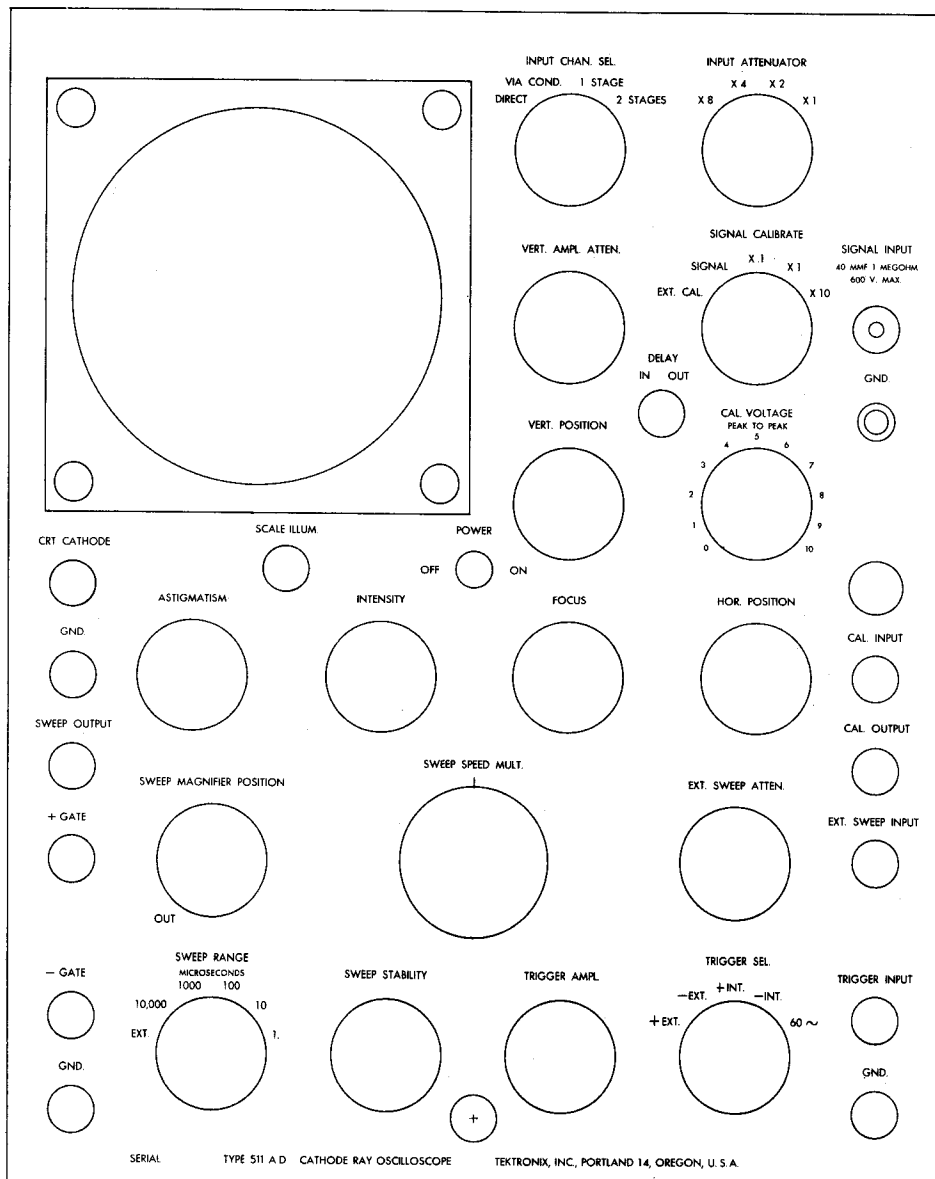





## SECTION II

### OPERATING INSTRUCTIONS

The Type 511-A may be operated in any normal indoor location, or in the open if protected from moisture. If the instrument has been exposed to dampness, it should be left in a warm room until thoroughly dry, before being placed in operation.

To prevent excessive interior temperatures, it is important to allow adequate ventilation for the oscilloscope. Several inches clearance should be provided at the sides, back and top of the case.

If the Type 511-A is used continuously for the same application, and only one setting of the controls is required, it is advisable to periodically check the instrument at all control settings to be sure it is in normal operating condition. For example, if only direct connection to the vertical deflection plates of the CRT is used, a defect in the video amplifier might not become evident. Operation of the controls also helps to prevent accumulation of dirt and tarnish on their contacts.

Although the components are well supported and the adjustments very stable in setting to allow for portable operation, the Type 511-A should not be subjected to excessive vibration or rough handling.

To place the Type 511-A in operation for the first time the following procedure is suggested.

1. Connect to a source of 50-60 cycle, 105-125 V power.
2. Set controls as indicated below.

INPUT CHAN. SEL.....	1 STAGE
INPUT ATTENUATOR .....	X1
VERT. AMPL. ATTN.....	Clockwise
SIGNAL CALIBRATE .....	X1
VERT. POSITION.....	Index vertical
CAL. VOLTAGE.....	0
ASTIGMATISM.....	Index vertical
INTENSITY .....	Counterclockwise
FOCUS.....	Index vertical
HOR. POSITION.....	Clockwise
SWEEP MAGNIFIER POSITION.....	OUT
SWEEP SPEED MULT.....	5
SWEEP RANGE.....	10,000
SWEEP STABILITY.....	Counterclockwise
TRIGGER AMPL.....	Counterclockwise
TRIGGER SEL.....	+INT.

3. Turn POWER switch to ON and wait about 30 seconds.

4. Advance INTENSITY control until a spot is seen.

5. Adjust VERT. POSITION, HOR. POSITION, ASTIGMATISM and FOCUS until a sharply focussed spot is obtained at the left center of the screen.

**CAUTION**—DO NOT ALLOW THIS SPOT TO BE EXCESSIVELY BRIGHT OR REMAIN FOR LONG IN ONE POSITION.

6. Advance the SWEEP STABILITY control until a sweep appears, then turn it back just under this point.

7. Set the CAL. VOLTAGE control to 10. A vertical line about 1½ inches high should appear.

8. Advance the TRIGGER AMPL. control until a stable image of a sine wave appears.

The oscilloscope is now observing the 50-60 cycle power line waveshape. To observe other waveshapes connect them to the SIGNAL INPUT binding post, turn the SIGNAL CALIBRATE switch to SIGNAL, select the appropriate sweep speed, etc.

### SWEEP CIRCUIT ADJUSTMENTS

The sweep circuit of the Type 511A is different from the gas tube type usually employed in portable oscilloscopes. It is much more flexible and capable of synchronizing with much higher frequencies than conventional sweep circuits. Fundamental frequencies of 10 mc and higher can be easily observed. By one simple adjustment the sweep will run recurrently or triggered as desired.

In a recurrent or sawtooth sweep as generated by a gas tube or similar device the synchronization takes place at the end of the sweep. The sync impulse causes the beam to return to the left side of the tube where it immediately starts another sweep. Thus the sweep time must be a multiple of the signal period, or expressed another way, the sweep frequency an integral fraction of the signal frequency.

In a triggered sweep circuit each sweep is started independently of the preceding sweep by a trigger or synchronizing impulse. When no trigger is being received, the beam remains at the left side of the trace. When the trigger arrives, the beam goes linearly to the right for a time in this case determined by the multivibrator pulse length. At the end of its sweep it returns to the left side again to await another trigger. It is this variable waiting period which makes the synchronization so easy since the sweep time is now independent of the signal period. The triggered sweep makes it possible to view pulses such as used in radar and television where the length of the pulse is very short compared to the space between pulses. This requires a fast sweep with a long waiting period. Waiting periods of 2000 times the sweep length are frequently used.

### ADJUSTMENT OF SWEEP STABILITY

The SWEEP STABILITY control varies the multivibrator bias and therefore determines whether the sweep will oscillate recurrently or wait for a trigger impulse. Correct functioning for triggered operation is therefore obtained when it is set just under the point where oscillation takes place. The procedure is to remove the trigger source, turn the TRIGGER AMPL. control counterclockwise, and advance the SWEEP STABILITY knob until a sweep appears and then decrease it until it just disappears.

NOTE—When using the internal trigger impulses to view fundamental frequencies above about 2mc it will be necessary to progressively advance the SWEEP STABILITY control somewhat above the normal operating point to secure a stable pattern.

### FUNCTION OF TRIGGER SEL.

This control selects the trigger impulse to be used from three sources, the line frequency, (60 cycles), the video amplifier (+INT and —INT), or the TRIGGER INPUT binding post. Two positions are available for both the INT. and EXT. sources. When using those marked +, the sweep starts at the rising portion of the trigger impulse. The — positions start the sweep on the falling portion. When the INPUT CHAN. SEL. switch is in the 2 STAGES position the +INT and —INT positions are reversed in polarity since the trigger impulses are shifted 180° by the pre-amplifier stage. For satisfactory operation in the EXT. positions a trigger of from 1 V to 50 V peaks should be provided. Larger triggers should be reduced by an external attenuator.

### ADJUSTMENT OF TRIGGER AMPL.

The TRIGGER AMPL. control adjusts the bias in the trigger amplifier and therefore the amplitude of the impulse which reaches the multivibrator. After the SWEEP STABILITY is set as described previously, and the TRIGGER SEL. switch set to the correct position, advance the TRIGGER AMPL. control until a stable image is obtained. When the trigger source is a slowly changing wave such as a sine wave or sawtooth, adjustment of the TRIGGER AMPL. setting will change the phase of the signal relative to the start of the sweep.

In general, it is desirable to use the minimum TRIGGER AMPL. setting required to insure a stable image.

If poor synchronizing is experienced when the Type 511-A is used to observe repetitive signals containing erratic peak voltages, such as produced by vibrating contacts, it may be possible to form a stabilized trigger signal by the use of auxiliary limiting and differentiating circuits. The TRIGGER SEL. switch should then be set to the proper EXT. polarity, and connection made to the TRIGGER INPUT.

### ADJUSTMENT OF SWEEP SPEED

The combination of SWEEP RANGE and SWEEP SPEED MULT. controls allows the operator to vary the sweep speed so that the marked portion of the graticule (10 cm) is covered in any time from .1 sec. to 1 microsecond. The approximate number of microseconds for the sweep to cross the scale can be determined easily by multiplying the SWEEP RANGE setting by the reading of the SWEEP SPEED MULT. dial. This should be correct to within 10% or better. Provision has been made to compensate for variations caused by different tubes, etc., by a screwdriver adjustment inside the case. Procedure for adjustment of this control will be found in Section IV.

### RECURRENT SWEEP

In case it is desirable to have a sweep without using any sort of trigger, merely advance the SWEEP STABILITY control until a stable sweep is obtained. This sweep is the conventional sawtooth variety as used in most oscilloscopes.

### SINGLE SWEEP

The triggered sweep circuit used in the Type 511 inherently provides for single sweep operation. The beam is blanked out until the trigger simultaneously turns it on and starts the sweep. For single sweep operation a mechanical contact or hand key can be connected between the TRIGGER INPUT binding post and ground. If repeated sweeps occur due to intermittent or bouncing contact, a capacitor of .1 mf. to 1 mf. should be connected across the contact. This capacitor is charged through 22 megohms and the long time constant prevents an immediate recurrence of the sweep.

### SWEEP MAGNIFIER

Frequently it is desirable to examine in some detail a portion of the waveshape under observation, for instance the rate of fall of the end of a fairly long pulse. In the Type 511-A the sweep magnifier circuit makes it possible to expand any desired 20% of the sweep to cover the entire tube face. When the SWEEP MAGNIFIER POSITION control is moved from the OUT position, the sweep is delayed for a variable time and then goes at about 5 times its normal rate. The operating procedure is to turn the SWEEP MAGNIFIER POSITION to OUT. Adjust the sweep speed controls so that the portion of the wave to be magnified is at the right side of the tube. Now turn the SWEEP MAGNIFIER POSITION knob clockwise until the desired signal moves in from the right to the center of the tube face. The magnified sweep is not linear over its entire trace so that it is desirable to use only the center two inches if possible. If higher magnification than five is wanted it is only necessary to change R47 to a larger value. A value of 10 K will give a magnification of about 10. The somewhat lower value chosen appears to be a more usable value in most cases.

NOTE—A sweep of 10 cm per microsecond is about the limit of the sweep amplifiers, so that care must be taken that the magnified sweep does not exceed this value.

### EXT. SWEEP INPUT

Provision has been made for the connection of external sweep generators to the Type 511A. This might be a sine wave oscillator for frequency comparison, the sweep obtained from a "Frequency sweep" signal generator, etc., or an auxiliary slow sweep generator. The EXT. SWEEP INPUT binding post is connected to the horizontal deflection plates via the EXT. SWEEP ATTEN. and a one stage push pull amplifier. The entire system is DC coupled, permitting the use of very slow sweeps.



With the EXT. SWEEP ATTEN. fully clockwise the deflection sensitivity is approximately 1.5 volts per cm DC or peak to peak AC.

## VERTICAL DEFLECTION SYSTEM

The Type 511A is equipped with a very flexible vertical deflection system capable of amplifying or attenuating as necessary a wide range of waveshapes. Since the best amplifiers and attenuators have faults, it appeared undesirable to first attenuate large signals and then amplify them back to something like their original size. It was therefore decided that the Type 511A should have a switching system so that only as much amplification as needed to get a reasonably sized image would be employed. This switch called the INPUT CHAN. SEL. has four positions, DC, VIA COND, 1 STAGE and 2 STAGES. In the DC position the SIGNAL INPUT connector is connected via the INPUT ATTENUATOR to the upper deflection plate without a coupling capacitor. The lower plate is connected to the VERT. POSITION control and bypassed for signals. The VIA COND. position is similar to the DC except a .1 mfd capacitor is in series with the deflection plate. On these two positions the deflection sensitivity is approximately 27 V per cm DC or peak to peak AC, with the attenuator in the X1 position.

Normally, connection to the SIGNAL INPUT is accomplished by attaching the Binding Post Adapter, which is supplied, and a single lead. When reduced loading on the circuit under test is desired, the Input Probe should be used.

**CAUTION**—THE PEAK POTENTIAL APPLIED TO THE PROBE SHOULD NOT EXCEED 600 VOLTS.

Since the probe introduces an attenuation of 10X, it will be advantageous to employ a common shielded lead (no attenuation) to prevent pickup of stray fields when dealing with very low signals, if the additional circuit loading is permissible. A ground lead to the equipment under observation should be provided, and often an earth ground is desirable.

## VIDEO AMPLIFIER

With the INPUT CHAN. SEL. switch in the 1 STAGE position the SIGNAL INPUT connector is connected to the deflection plate via the INPUT ATTENUATOR, a cathode follower, the VERT. AMPL. ATTEN., and a one stage push pull amplifier. The VERT. AMPL. ATTEN. is a 500 ohm potentiometer in the cathode of the cathode follower, allowing the gain of the amplifier to be continuously adjusted over a range of two to one, thus filling in the INPUT ATTENUATOR steps. Both low and high frequency compensation is employed to produce a wide band of uniform amplification. Careful attention has been paid to the transient response so that square wave pulses, etc. will be faithfully reproduced. The amplifiers are adjusted at the factory for optimum transient response rather than flat frequency response. A much flatter response is obtainable if desired by in-

creasing L6, and readjusting L7, L8, L9, and L10, but overshoot will occur on steep wave fronts. With optimum transient response, the rise time (10% to 90% of full amplitude) is .04 microseconds or better. At the low frequency end of the band, the top of a 10,000 microsecond square pulse will not depart by more than 5% from flatness. The deflection sensitivity is approximately 2.7 V per cm peak to peak maximum.

**CAUTION**—CARE MUST BE TAKEN TO AVOID OVERLOADING THE AMPLIFIERS. THIS WILL BE AVOIDED IF THE IMAGE IS NOT ALLOWED TO EXCEED THE RULED SECTION OF THE GRATICULE, WITH THE VERT. POSITION CONTROL SET SO THAT WITH NO SIGNAL APPLIED THE SWEEP LINE IS CENTERED.

In the 2 STAGES position a wide band pre-amplifier stage is inserted between the INPUT ATTENUATOR and cathode follower. Since the bandwidth and transient response of the two stage amplifier are inferior to a single stage amplifier, this position should not be used unless it is necessary, in order to obtain a sufficiently large image. Rise time is .05 microseconds. The gain of the two stage amplifier is about 100, making the maximum deflection sensitivity approximately .27 V per cm peak to peak.

The deflection polarity is inverted when the 2 STAGES position is used, resulting in downward deflection on the CRT for positive input polarity.

A three position lever type switch mounted at the rear of the Type 511-A permits the operating bias on grid No. 1 of V19 to be varied. With the switch set at the center (normal) position, the bias applied to V19 is equal to the bias of V18, resulting in balanced operation and equal upward and downward undistorted deflection of the trace. For normal operation, the DEFLECTION POLARITY switch should be in this position.

If it is desired to observe pulses, the switch should be set in either the upward or downward position, corresponding to the deflection of the image on the cathode ray tube. In the upward position, the bias of V19 is decreased, resulting in increased output of V19 and decreased output of V18, thus permitting greater undistorted upward deflection. These conditions are reversed when the deflection polarity switch is in the downward position.

## DIRECT CONNECTION TO DEFLECTION PLATES

To allow direct connection to the deflection plates with the lowest capacity, banana jacks are provided on a panel accessible through an opening in the left side of the case. By removing the jumpers the internal circuits may be disconnected. The terminal marked Y1 is the top plate and the one marked X2 is the right plate. Deflection sensitivity is approximately 27 V DC per cm on the vertical plates and 32 V per cm on the horizontal.

If positioning control is desired, the jumpers should be replaced with 1 megohm resistors and a series coupling capacitor employed. Unless balanced input is desired, the unused deflection plate should be bypassed to ground.

## CALIBRATION

While the cathode ray oscilloscope is usually employed only as a qualitative rather than a quantitative device, it is the only instrument capable of making many types of measurements on non sinusoidal wave shapes. To aid in this work, the Type 511A has a SIGNAL CALIBRATE switch so that either the three built-in line frequency calibration voltages or an external source may be substituted for the signal to be measured.

### SIGNAL CALIBRATE SWITCH

This switch permits the vertical deflection system of the oscilloscope to be conveniently changed from the SIGNAL INPUT connector to four different sources of calibrating voltages. In the EXT. CAL. position it is connected to the binding post marked CAL. INPUT, which in turn may be connected to a suitable source of known voltage. In the X.1 position it is connected to the arm of the CAL. VOLTAGE potentiometer, furnishing from 0-1 V, peak to peak. The scale on the CAL. VOLTAGE control is accurate to  $\pm 5\%$  of full scale with normal line voltage (117 V). When a more accurate knowledge of the calibrating voltage is needed, a voltmeter may be connected to the binding post marked CAL. OUTPUT. The CAL. VOLTAGE control is a 5 K potentiometer, so that a reasonably high resistance voltmeter should be used. In any case however, the reading on the meter is the voltage actually applied. The other two switch positions, X1 and X10, furnish ranges of 0-10 and 0-100 volts respectively.

The CAL. INPUT binding post may be used as an auxiliary signal input. This connection is not recommended for observing high speed transients, due to the slightly greater capacity and lack of a parasitic suppressor.

### MEASUREMENT OF SIGNAL AMPLITUDES

To measure the amplitude of any signal under observation, adjust the size of the image to correspond to a convenient pair of horizontal lines on the graticule. Move the SIGNAL CALIBRATE switch to the appropriate source of calibration voltage and adjust its output until the image matches the same graticule lines to which the signal had been previously set. The calibration voltage is now equal to the signal amplitude.

**CAUTION**—IF THE INPUT PROBE (ATTEN. 10X) IS USED, THE SIGNAL AMPLITUDE IS EQUAL TO TEN TIMES THE CALIBRATION VOLTAGE.

The scale on the CAL. VOLTAGE potentiometer is calibrated in peak to peak volts. If a sine wave is being measured, this may be converted to R.M.S. by dividing

by 2.828. If a voltmeter is used to measure the CAL. OUTPUT, remember to multiply its R.M.S. by 2.828 to obtain a peak to peak reading.

**CAUTION**—DO NOT OVERLOAD THE AMPLIFIERS WHEN MAKING AMPLITUDE MEASUREMENTS.

Another method which is less accurate but more rapid is to calibrate the oscilloscope itself. Select a suitable convenient voltage in the range needed, for example 10 volts, and adjust the VERT. AMPL. ATTEN. until a convenient deflection, say 5 scale divisions, is obtained. The sensitivity is now 2 volts per division and amplitudes may be read directly. The range may be extended if desired by the INPUT ATTENUATOR and probe which has an attenuation of 10X.

**CAUTION**—THE DEFLECTION POLARITY SWITCH MUST BE IN THE NORMAL (CENTER) POSITION DURING CALIBRATION TO PREVENT ERROR IN THE INDICATED AMPLITUDE.

### INTENSITY MODULATION (Z AXIS)

If desired, signals may be impressed on the cathode of the cathode ray tube thus modulating its brightness. The CRT CATHODE binding post is connected to the cathode via a .1 mfd capacitor. The cathode resistor is 120 K. Since the time constant is only .012 sec. long, square pulses cannot be transmitted without some loss of shape. Its primary purpose, however, is to transmit short pulses such as timemarkers, etc.

### SWEEP OUTPUT

The SWEEP OUTPUT binding post makes available the waveshape appearing on the plate of the sweep generator tube. V10 is used as a cathode follower to isolate the sweep generator from whatever is connected to the SWEEP OUTPUT post. The amplitude is approximately 20 V peak to peak.

### GATE OUTPUTS

V8 is used as a phase splitter to provide positive and negative square waves of the same duration as the sweep. The +GATE is taken from the cathode and DC coupled, thus providing an accurately square topped pulse even at the longest sweep times. The -GATE is taken from the plate via a .05 mfd capacitor to remove the DC component.

## SECTION III

### CIRCUIT DESCRIPTION

#### CATHODE RAY TUBE CIRCUIT

The Type 511A uses a type 5CP1A cathode ray tube. This tube has a five inch screen and utilizes electrostatic focus and deflection. A post-accelerating electrode (intensifier) is used to provide increased brightness. The total accelerating potential is about 3000 V, giving a sharp bright image visible in normal room light.

The various negative voltages necessary to operate the tube are obtained from a voltage divider network across the -1500 V supply. R142 provides the bias voltage which controls the beam current and thereby image brightness. This control is labeled INTENSITY. C60 serves to bypass the cathode to ground via the filter capacitor C 77 in the power supply. In order to bring the electron beam to a sharp focus at the screen, the potential of the second anode is adjusted by the FOCUS potentiometer R140. The ASTIGMATISM control is the potentiometer R135 connected between the +225 V and -140 V supplies. This control adjusts the potential of the second anode so that good focus is obtained on both horizontal and vertical lines simultaneously. In order to transmit unblanking pulses to the grid of the cathode ray tube, the .1 mfd 2000 V capacitor C58 is used. A similar capacitor C59 is used to transmit external impulses such as timing markers from the CRT CATHODE binding post.

The twin potentiometers R131A and R131B provide a means of varying the average potentials of the vertical deflection plates and therefore vary the position of the image. These potentiometers are connected between the +225 V and -140 V supplies so that as one plate is made more negative the other is made an equal amount positive. By this means the average potential of the vertical plates is not changed by adjustment of the VERT. POSITION control. This is essential in order to maintain good focus over a wide area of the screen. When the DIRECT position of the INPUT CHAN. SEL. switch is used, the VERT. POSITION control adjusts the potential of the lower plate only. In this case it may be found necessary to adjust the ASTIGMATISM control to obtain the best focus.

#### SWEEP CHASSIS

The sweep chassis provides the circuits necessary to deflect the electron beam horizontally across the screen at a uniform rate, starting each sweep in synchronism with the trigger impulses. Circuits are provided which cut off the beam between sweeps. Provision is made to feed various sweep circuit waveforms to binding posts for external use.

#### TRIGGER PHASE SPLITTER

The TRIGGER SEL. switch, operating in conjunction with V1, the trigger phase splitter, selects the source of trigger signal and reverses its phase if necessary. The

trigger amplifier V2 requires a positive impulse on its grid to provide the correct trigger to the multivibrator. When the TRIGGER SEL. switch is in the +INT. or +EXT. positions, signals are taken off the cathode of V1 and do not change in polarity. Therefore a positive impulse must be supplied by the external source or video amplifier as the case may be. With the TRIGGER SEL. in the -INT. or -EXT. positions, signals are taken off the plate and reversed in polarity, thus providing the required positive output from negative trigger sources.

#### TRIGGER AMPLIFIER

The 6AG7 tube V2 serves as a variable gain amplifier for the positive trigger impulses received from V1. The TRIGGER AMPL. potentiometer R6 varies the bias and thus determines the gain of V2. R12 serves to protect the tube in event of the failure of the -140 V supply.

#### TRIGGER COUPLING DIODE

The negative trigger impulses from the plate of V2 are impressed on the plate of V4 by means of the coupling diode V3. The diode is used in preference to a coupling capacitor because it disconnects the trigger amplifier from the multivibrator once the multivibrator is triggered. When the multivibrator is triggered the plate of V4 falls, making the diode plate negative with respect to its cathode and therefore non-conducting. This condition is maintained until the multivibrator completes its cycle and is ready to be triggered again.

#### MULTIVIBRATOR

To convert the various shapes of trigger impulses into square waves of controllable duration, suitable for operating the sweep generator and unblanking the cathode ray tube, a multivibrator is provided. This consists of two tubes V4 and V5. During the waiting period V5 is fully conducting since its grid is at cathode potential and therefore its plate is held at a low value due to the voltage drop in R23. With V5 in this condition and the SWEEP STABILITY correctly adjusted, the grid of V4 is held well below the cut-off by the voltage divider R17 and R18. The circuit remains in this condition until a trigger impulse is received. The plate of V4 is driven down by the trigger pulse and also the grid of V5, because of the coupling capacitor C7. The plate of V5 therefore rises carrying with it the grid of V4 causing it to conduct. This action continues until V4 is conducting and V5 cut off. This condition is maintained until the capacitor C7 discharges, raising the grid voltage of V5 to such a point that it starts to conduct. This makes the plate of V5 fall, carrying with it the grid of V4 and starting a regenerative cycle which ends with V5 conducting and V4 cut off, the condition which existed before the trigger impulse occurred. Thus the plate of V4 produces a square negative pulse and simultaneously the plate of V5 produces a positive pulse. The negative pulse is used to control the operation of the sweep generator and the positive pulse to unblank the cathode ray tube. The duration of the portion when V5 is cut off is determined by the time constant R20A, R21, R22, C7 and the voltage applied to R20A, and is substantially independent of the characteristics of the trigger impulse.

To cover a range of sweep time from .1 sec to 1 microsecond, C7 has five values as selected by the SWEEP RANGE switch. In the three slowest positions R20A is returned to ground, but for the two fastest it is returned to +225 V. This makes possible the use of a larger value of C7 than would otherwise be possible, thus reducing the capacity voltage divider action of the stray shunt capacities to ground of the grid circuit of V4. Variation of R20A in conjunction with the five values of C7 gives a continuously variable adjustment of the multivibrator pulse length.

### UNBLANKING CIRCUIT

During the waiting period the bias on the cathode ray tube is such that it is completely cut off. As soon as a trigger appears and the sweep starts, it is necessary to provide a positive pulse on the grid of the cathode ray tube and thus turn on the electron beam. This pulse should have an extremely fast rise and a very flat top so that the brightness of the image is uniform. To secure a pulse of this nature, the positive pulse from the multivibrator is clipped before it reaches its normal amplitude by the diode V6A. The cathode of V6A is held at approximately +55 V and thus the plate cannot rise more than a few volts above this value. In order that the capacity to ground of the cathode ray tube grid and its associated components and wiring should not reduce the rate of rise appreciably, the cathode follower V7 is used. This circuit is capable of unblanking the tube within .1 microsecond after a sharp trigger impulse reaches the TRIGGER INPUT binding post.

### GATE OUTPUT GENERATOR

V8 serves to isolate the gate output binding posts from the multivibrator. It receives a positive pulse on its grid of the same duration as the sweep from the plate of V5 via the voltage divider R32 and R33. C10 maintains the steep sides of the pulse. Since the plate and cathode load resistors are equal, pulses of equal size but opposite polarity appear at the plate and cathode. The +gate from the cathode has no blocking capacitor and therefore preserves the square pulse for the longest sweeps. It was not felt desirable to have the -Gate binding post carry the +225 V potential of the plate; therefore a blocking capacitor is used.

### SWEEP GENERATOR

The sweep generator circuit produces the basic wave necessary to sweep the beam linearly across the tube and return it to its starting point. During the waiting period the 6AG7 tube V9 is held fully conducting since it has no bias and therefore its plate is about at ground potential. When a trigger occurs the negative pulse from the multivibrator cuts the grid of V9 off very rapidly. The plate therefore rises in exponential fashion at a rate depending on R20B, R39, and C15. When the multivibrator pulse ends V9 conducts again, thus discharging C15. Since C15 is charged to only about 5% of the supply voltage, the rate of rise is very nearly linear. Five values of C15 as determined by the SWEEP RANGE switch in combination with the variable resistor R20B

provide a continuous variation in sweep speed of from less than .1 sec to 1 microsecond for 10 cm sweep. In order to maintain the correct multivibrator pulse length as the sweep speed is raised, the SWEEP RANGE switch changes C7 in the multivibrator and C15 simultaneously. Likewise the SWEEP SPEED MULT. is a twin control changing R20A and R20B simultaneously. To maintain the calibration of the SWEEP SPEED MULT dial when tubes are changed etc., the voltage applied to R20B may be varied by R42 which sets the grid potential of the cathode follower V15. The use of the cathode follower in place of a potentiometer maintains a constant charging potential as R20B is varied. Details of this adjustment will be found in Section IV.

### SWEEP OUTPUT CATHODE FOLLOWER

To provide the necessary isolation between capacities fastened to the SWEEP OUTPUT binding post and the sweep generator, the cathode follower V10 is provided. The grid of V10 is connected to the plate of the sweep generator. The SWEEP OUTPUT binding post is connected to the cathode of V10 without a blocking capacitor.

### SWEEP MAGNIFIER

The function of this circuit is to delay the start of the sweep for a variable time, and then cause it to go at five times its normal speed. This is accomplished by the biased cathode coupled amplifier V11. In this type of amplifier a positive change in the grid potential of V11A raises both cathodes and therefore corresponds to a negative change on the grid of V11B. Thus the plate of V11 gives an amplified version of the signal on the grid of V11A, without change of polarity. The SWEEP MAGNIFIER POSITION potentiometer raises the potential on the grid of V11B above ground and thus the cathode potential of V11A. No sweep appears on the plate of V11B until the plate of the sweep generator overcomes this bias, then the amplified sweep appears. Sufficient bias is available on the SWEEP MAGNIFIER POSITION to make it possible to start the magnified sweep at any point on the normal sweep. V6B is employed as a DC restorer to insure that the magnified sweep will start at the same potential each time, thus preventing jitter or instability of the trace. When the magnified sweep is not desired, the SWEEP MAGNIFIER POSITION knob is turned to the OUT position which operates a SPDT switch connecting the sweep amplifier directly to the plate of the sweep generator.

### SWEEP AMPLIFIER

The sweep voltage at the plate of V9 is only about 20 V amplitude. To sweep the spot across the screen, about 350 V is necessary. The sweep amplifier provides the necessary amplification and in addition converts the single sided voltage from the sweep generator into a balanced voltage suitable for deflecting the beam. This balanced voltage is necessary to maintain the average potential of the deflection plates constant over the entire sweep, and thus prevent defocussing. The am-

plifier which does this uses a cathode coupled circuit\* consisting of the triode connected 6AU6 tubes V13 and V14. The action of this circuit is the same as described for the sweep magnifier except that load resistors are present in both plates. The HOR. POSITION control varies the bias on V14 and thus determines the position from which the sweep starts. To insure that the sweep will always start at the same point on the screen each time (at a given setting of the HOR. POSITION control), the 6AL5 restorer diode V12 is connected between the grid of V13 and ground. This diode removes any charge which C20 may have gained during the sweep.

High frequency compensation provides sufficient band width to amplify the 1 microsecond sweep with good linearity.

This is accomplished by the bypassing effect of C22, which at high frequencies reduces the degeneration introduced in the cathode circuit by R65 and R66. Additional compensation is provided by the inductance of R69 and R63.

When the SWEEP RANGE switch is on the EXT. position, the input to the sweep amplifier is shifted from the sweep generator to the arm of the EXT. SWEEP ATTEN. potentiometer.

To obtain good focus on a cathode ray tube, it is necessary that the final anode and both pairs of deflection plates have approximately the same average potential. Since it is necessary to have the vertical plates at ground potential so that a direct connection can be made, the average potential of the horizontal plates must also be near ground. The mean potential of the sweep amplifier plates is about +250 V. This is moved down to ground by means of the group of neon glow lamps. A steady current of about 200 microamperes keeps them ionized so that any changes in the plate potentials of the sweep amplifiers appear on the deflection plates unchanged in amplitudes, but moved down 250 V. The biasing current is obtained from the -1500 V cathode ray power supply via the voltage dropping resistors R153 and R154. Since the impedance of the neon glow lamps is rather high at frequencies involved in the fastest sweeps, C24 and C25 are shunted across them to transmit these frequencies.

## VERTICAL DEFLECTION SYSTEM

The vertical deflection system provides the means of attenuating or amplifying input signal amplitudes so that they may present a convenient image on the cathode ray tube. Signals may be attenuated as much as 8 times or amplified as much as 100 times without appreciable change in shape.

## PROBE

A frequency compensated signal input probe is supplied to provide reduced loading on the circuit under observation. It consists of a 9 megohm series resistor paralleled with a compensating capacitor, and provides an input impedance of 10 megohms shunted by 14 mmfd.

\* For a discussion of cathode coupled amplifiers see Puckle "Time Bases," pp. 119-125.

**CAUTION**—ALTHOUGH THE PROBE INTRODUCES A SIGNAL ATTENUATION OF 10 TIMES, IT SHOULD NOT BE CONNECTED TO CIRCUITS WITH PEAK VOLTAGES EXCEEDING 600 VOLTS.

## INPUT ATTENUATOR

All signals and calibrating voltages pass through a four position, RC compensated attenuator having attenuation ratios of 1, 2, 4 and 8. If a conventional resistance voltage divider is shunted by capacitors whose values bear the inverse ratio to the resistor values, the attenuation is independent of frequency. The attenuator is designed to have an input resistance of 1 meg shunted by 40 mmfd for all positions. Since the input circuits to the amplifiers and deflection plate are arranged to present 1 meg shunted by 40 mmfd, the values chosen for the attenuator are such that correct operation is obtained when these values are in parallel with the shunt arm. The capacitors C32, C35, and C38 shunted across the attenuators have no effect on the attenuation ratio but are adjusted so as to keep the input capacity at 40 mmfd.

## VIDEO AMPLIFIER

The Type 511A contains a wide range two stage video amplifier with a switching arrangement so that only one stage may be used if desired. The first stage which is used only in the 2 STAGES position of the INPUT CHAN. SEL. switch uses a 6AG7 tube V16.

The output stage is a cathode coupled, push-pull 6AG7 stage, providing approximately 110 V of undistorted output. The operation of this stage is the same as that of the sweep amplifier stage. The use of a push pull stage is required to give sufficient output and maintain the average potential of the deflection plates constant so as to prevent defocussing the beam. Low frequency compensation is provided to correct for the effect of the coupling capacitors. The resistors R110 and R125 along with the capacitors C51A and C51B provide a rising low frequency characteristic together with a phase correction. To take up variations in the component values, the grid resistor R116 is made adjustable. The procedure for this adjustment is given in Section IV. The inductances, L7, L8, L9 and L10 provide the high frequency compensation. A four terminal coupling network is used to give the greatest possible bandwidth. Every precaution has been taken to obtain the smallest stray capacities consistent with good mechanical construction.

To increase the undistorted deflection when observing pulses of a particular polarity, provision is made to move the operating point of the push-pull output amplifier from its normal position to one which allows almost the entire output swing to be utilized in either one direction or the other.

The DEFLECTION POLARITY switch, S9, permits the operating bias on grid No. 1 of V19 to be varied. With the switch set at the center (normal) position, the bias applied to V19 is equal to the bias of V18, resulting in balanced operation and equal upward and downward undistorted deflection of the trace.



In the upward position, the bias of V19 is decreased, resulting in increased output of V19 and decreased output of V18, thus permitting greater undistorted upward deflection. These conditions are reversed when the deflection polarity switch is in the downward position.

The 6AG7 cathode follower V17 serves primarily as an impedance transformer so that a low resistance potentiometer can be used as a gain control. It is necessary that the potentiometer have a low value so that stray capacities do not appreciably vary the frequency response as the control is varied. To prevent overloading the cathode follower, the VERT. AMPL. ATTEN. has a stop limiting its attenuation to a maximum of 2. This is sufficient to cover the steps of the INPUT ATTENUATOR. The coupling capacitor C49 serves to remove the DC component from the VERT. AMPL. ATTEN. so that the image does not jump around if the control is moved suddenly. Another function of the cathode follower is to permit the insertion of a delay network in the video amplifier. The chassis of the Type 511A is drilled to permit the insertion of a Tektronix Type 1AD25 Delay Network. This delays the signals .25 microseconds without appreciable distortion. A panel switch permits the removal of the delay when desired. When the delay network is factory installed, the oscilloscope is designated as Type 511AD.

When the INPUT CHAN. SEL. switch is in the 2 STAGES position, the 6AG7 pre-amplifier V16 is in the circuit. This stage employs the same compensation system as the output amplifier. Variable resistor R99 controls the low frequency response, and L4 and L5 the high frequency response. The negative bias from the voltage divider R90 and R91 places the tube on the correct portion of its operating curve. So that the screen dissipation will not be excessive, the screen voltage is supplied through R95. C45A keeps the potential relatively constant when signals are applied to the control grid.

## CALIBRATING CIRCUITS

When the SIGNAL-CALIBRATE switch is put in the EXT. CAL. position, the INPUT ATTENUATOR is disconnected from the SIGNAL INPUT binding post and connected to the EXT. CAL. post. The positions marked X.1, X1, and X10 connect the INPUT ATTENUATOR to the arm of the 5K wire wound potentiometer R76. In the X10 position the high side of R76 is connected via S3A to a 100 V (peak to peak) winding in the power transformer. The X1 and X.1 voltages are obtained by means of dropping resistors R74 and R75 from the 6.3 V winding. The arm of R76 is connected to the CAL. OUTPUT binding post so that the calibrating voltage may be measured when increased accuracy is required.

**CAUTION—THE SCALES OF THE CAL. VOLTAGE CONTROL INDICATE PEAK TO PEAK VOLTS, NOT RMS. MULTIPLY RMS BY 2.828 TO CONVERT TO PEAK TO PEAK.**

## POWER SUPPLY

In order to make the operation of the Type 511A independent of line voltage variations over the range of 105 to 125 volts, all DC power supplies are electronically regulated. The accelerating potential for the CRT

is obtained from an oscillator operating from the regulated +225 v. supply. A single transformer supplies all of the 60 cycle power.

The principal power supply provides +225 v. at approximately 250 ma. Two 5V4G tubes are used as rectifiers. The comparatively low voltage drop of these tubes reduces the no load voltage to which the input capacitors may be subjected. A large input capacitor, 80 mfd., reduces the ripple to about 12 volts. The electronic regulator reduces this to less than .1 volts. This circuit consists of V27, V28, V29 and their associated components. To see how this circuit works, consider what happens when the output voltage at the cathode of V27 increases for any reason. The cathode of V28 is held at a constant potential by the type 5651 voltage reference tube V29. An increase of voltage at the cathode of V27 increases the grid voltage of V28, thereby decreasing its plate voltage and consequently increasing the grid bias on V27. An increase in this bias increases the voltage drop across V27 and thus decreases the output voltage. If a decrease in line voltage and increase in load current tend to decrease the output of the regulator, the reverse action takes place. Thus an equilibrium is reached where the regulated output voltage is held constant within very narrow limits. To improve the action of the regulator for ripple or sudden changes of load, the capacitor C70 couples the grid of V28 directly to the output. The potentiometer R159 allows adjustment of the output voltage to 225 volts when the tubes are changed, etc.

A 6X4 rectifier V24 with its cathode connected to one side of the high voltage winding, supplies a negative voltage of approximately 300 volts. The plates of V24 are tied together since it is used as a half wave rectifier. C68 is used as the input capacitor. To provide regulation and additional filtering, the gas filled regulator V30 is used. The 470 ohm resistor in series with the output of V30 eliminates a tendency of V30 and C21 (on the sweep chassis) to form a relaxation oscillator.

The +450 volts necessary to operate the sweep amplifier is obtained from the full wave rectifier V21 whose output voltage is added to the output of the main rectifier. To obtain regulation and filtering, a regulator consisting of V25 and V26 is used. This regulator operates in the same manner as the +225 supply, using the regulated +225 as reference voltage. Thus, if the +225 is not set at its correct value, the +450 volt output will also be in error.

In order to provide the + and - 1500 volts necessary to operate the CRT, an oscillator type supply is used. Since the input power to the oscillator comes from the regulated +225 volts, its output is not affected by line voltage changes. The oscillator uses the 6AQ5 tube V31 in a conventional Hartley circuit. A high voltage secondary on the oscillator transformer supplies approximately 1250 V RMS to the two type 1B3GT/8016 rectifiers V32 and V33. Filament voltages for these tubes are obtained from windings on the oscillator transformer. Since the frequency of the oscillator is fairly high (2 KC), a single .05 capacitor provides adequate filtering for the +1500 volts. A filter consisting of a .05 mf. input capacitor, a 27K resistor, and a .5 mf. output capacitor is used on the -1500 volt supply because of the increased load and need for an adequate bypass on the CRT cathode.

## SECTION IV

### MAINTENANCE AND ADJUSTMENT

#### Maintenance

**CAUTION**—VOLTAGES HIGH ENOUGH TO BE DANGEROUS ARE PRESENT IN THIS INSTRUMENT. SINCE MUCH MAINTENANCE MUST OF NECESSITY BE WITH THE CASE REMOVED, GREAT CARE SHOULD BE TAKEN. USE ONLY INSULATED TOOLS, STAND ON A DRY FLOOR, AND IF POSSIBLE KEEP ONE HAND IN YOUR POCKET.

#### REMOVAL OF THE CASE

Set the oscilloscope face downward on a padded flat surface, remove the access panel jumper plugs and the two screws in the bottom, then lift off the case.

#### CLEANING

**CAUTION**—REMOVE POWER CORD AND GROUND HIGH VOLTAGE CIRCUITS BEFORE CLEANING IS UNDERTAKEN.

At regular intervals, depending on local conditions, the dust should be removed from the interior of the Type 511-A by means of dry compressed air. Avoid a high velocity air stream which might injure the instrument or disturb adjustments. Persistent dirt may be removed with a lint-free cloth, or if necessary, carbon tetrachloride. Special attention should be given to the high voltage circuits, including parts under the high voltage cover shields, as excessive dust and moisture may cause arcing.

Under normal conditions, the silver plated contacts of the rotary switches should not require special attention. In case they become tarnished, the contacts should be cleaned by rotating the switch several times.

#### INSPECTION

A visual inspection is desirable while the Type 511-A case is removed during cleaning.

1. Switches. Turn the rotary switches while observing the contacts, to check contact centering in each index position. Improperly centered contacts may be due to the switch becoming warped or twisted, or in the case of S2 (SWEEP RANGE), to a loose shaft coupling.

**CAUTION**—AVOID PRESSURE ON THE CONTACTS AS THEY ARE EASILY DAMAGED.

2. Capacitors and Resistors. Inspect the oil filled and electrolytic capacitors for leakage of oil or electrolyte, replacing if necessary. The wax coating of paper tubu-

lar capacitors may drip if the instrument has been overheated by operating in a restricted space. This condition usually does not indicate replacement. Composition resistors should be checked for serious discoloration, which would indicate excessive dissipation and therefore faulty operation. A moderate amount of discoloration is normal.

3. Connections. Loose screws or nuts should be tightened. This is especially important when the screw serves as an electrical connection. Corrosion of the chassis and electronic components is unlikely under normal conditions. It should be removed if evident, and the cause corrected. If the instrument must be operated in a corrosive atmosphere, it may be desirable to remove the tubes occasionally and clean the contact pins with crocus cloth. Remove and insert the tubes several times to clean socket contacts. It may be necessary to use a pipe cleaner moistened with carbon-tetrachloride.

4. Voltages. The power supply output voltages,  $-140$ ,  $+225$ ,  $+450$ ,  $-1500$  and  $+1500$  should be checked with an accurate voltmeter. To check the voltage regulator circuits, vary the line voltage by means of a variable transformer, and with a voltmeter observe the regulation limits of the  $-140$  v.,  $+225$  v., and  $+450$  v. supplies. Compared to their value at a 117 volt line, the output voltages should be within these limits:

supply	$-140 (+2-5\%)$	$+225 (\pm 2\%)$	$+450 (\pm 6\%)$
105 v. line	$-0.5\%$	$-1\%$	$-1\%$
125 v. line	$+0.5\%$	$+1\%$	$+1\%$

**CAUTION**—DO NOT EXCEED A LINE VOLTAGE OF 130.

#### TROUBLE ANALYZING AND REPAIR

##### General

It is important that the operation, circuit theory and physical location of components be thoroughly understood before repair of the Type 511-A is undertaken. If the circuit description, schematic diagram and interior photographs are carefully studied, most defects will be found relatively easy to locate.

**CAUTION**—BE SURE TO CHECK THE SETTING AND ADJUSTMENT OF THE CONTROLS BEFORE ATTEMPTING REPAIR, TO VERIFY THAT THE DIFFICULTY IS ACTUAL.

Although tables of average voltage and resistance values are included to facilitate servicing, they should be used for reference only, and are not meant to serve as a "check list" or sequence chart for circuit testing. This system might eventually lead to the trouble, but the isolation or signal tracing methods are generally much faster.

Many troubles can be localized by observing the waveforms at various points in the circuits with the instrument's own cathode ray tube. Another oscilloscope

may be used if available. This method is explained in detail under servicing instructions for each chassis.

Since a large percentage of troubles experienced will likely be caused by defective tubes, it is advisable to check the tubes in the suspected circuits before carrying out extensive tests of other components. Tube testing is best accomplished by the substitution of another one known to be good. A tube tester is useful, but it may not indicate some defects which cause malfunctioning in the oscilloscope. If the tube defect has been caused by an abnormal circuit condition, this should be corrected before replacement is made. Although specially matched or selected tubes are not required in the Type 511-A, some individual tubes which perform normally in less critical circuits may not function well in certain circuits of this instrument. Specific conditions are dealt with under the individual chassis headings. An accurate voltmeter having 20,000 ohms per volt or greater sensitivity, an accurate ohmmeter, spare tubes and simple tools should be available.

**CAUTION**—WHEN ANY PART WHICH AFFECTS THE ADJUSTMENTS OR CALIBRATION OF THE TYPE 511-A IS REPLACED, THE AFFECTED CIRCUITS SHOULD BE READJUSTED AS EXPLAINED IN THE ADJUSTMENT SECTION.

#### Absence of Power

When this condition is due to a blown fuse, check line voltage and if normal replace the fuse (3 amp. slow-blow), throw the power switch on and check for any abnormal condition which may have caused the fuse to blow. If a short circuit or overload exists, the length of time required to blow the fuse should provide an indication of the trouble. For example, a delay until the high voltage rectifiers begin to conduct would indicate trouble in the D.C. supplies or the circuits fed by them. This condition may be isolated by removing the high voltage rectifier tubes, V21, V22, V23 and V24; and replacing first V24, then V22 and V23, and finally V21, allowing several minutes operation between each replacement. After the faulty D.C. supply is located, disconnect it at the power supply terminal strip, then at the video amplifier terminal strip, to further isolate the defect. See the schematic diagrams for average currents.

A five second delay before the fuse blows might be caused by a short in the tube heater circuits, and should also be isolated by disconnecting at the terminal strips. A delay of one second or less would suggest a short circuit on a high voltage secondary of T1.

#### Absence of Spot on Cathode Ray Tube

To determine whether this is due to absence of the electron beam or to the beam being deflected off the fluorescent screen, connect together and ground all four CRT deflection plates at the access panel. If a centered spot now appears, abnormal deflection plate potentials are indicated. Remove the short circuiting connections. With the VERT. POSITION control centered, the HOR. POSITION control clockwise, the SWEEP STABILITY control counter-clockwise, and no vertical input signal,

measure the voltage between each CRT deflection plate and ground, which should be within  $\pm 60$  volts. The **average** potential of both horizontal (X) plates, or both vertical (Y) plates, should be within  $\pm 40$  volts of ground when measured under the above conditions. Abnormal potential on the horizontal plates indicates malfunctioning of the sweep amplifier or associated circuits; and on the vertical plates, a defective positioning circuit or shorted coupling capacitor.

If the deflection plate voltages are normal, check the CRT connections, and observe the CRT heater by viewing it through the small hole in the upper rear part of the CRT shield. Next, measure the power supply output voltages, the CRT bias (pin 2 to pin 3), the first anode (pin 5) and the second anode (pin 9) voltages. If these readings are normal, replacement of the CRT is indicated.

#### Power Supply

1.  $-140$ ,  $+225$  and  $+450$  supplies. If the output voltage of one of the regulated supplies is abnormally high or low, the load current for that section may be measured to determine whether the defect lies within the power supply or the external circuits. See the schematic diagram for values. If the power supply is at fault, the rectifier output voltage should be checked. Normal rectifier output would then indicate malfunctioning of the regulator circuit. See Section III for a description of the voltage regulator circuits. A regulator performance test is outlined in the Inspection instructions of this section. A check of the grid-cathode bias of the series regulator tube will serve to further isolate the trouble within the regulator circuit itself. Average bias potentials are:

Line Voltage	V27,6AS7G bias	V25,6AQ5 bias
105	-14 v.	- 8 v.
117	-36 v.	-16 v.
125	-56 v.	-22 v.

Figures 5 and 6 are oscillograms illustrating the amplitude and waveform of the normal rectifier output ripple. Any unbalance due to defective rectifier tubes or power transformer is easily observed with an oscilloscope at the cathodes of V21 and V22-V23.

2. High Voltage Supply. If normal  $-1500$  volt and  $+1500$  volt accelerating potentials are not restored by the replacement of V31, V32, and V33, the CRT heater pin plugs and the accelerating anode clip should be removed to ascertain whether the power supply itself is at fault. Next check the  $+225$  volt supply, since the high voltage output will vary proportionately. Low output with normal oscillator (V1) grid and cathode voltages, indicates an open circuit in the secondary windings of T2, or other portions of the rectifier circuits. Low voltages at the oscillator grid and cathode would suggest shorted turns or excessive load on T2, or defective components in the oscillator primary circuit. Figures 7 and 8 are oscillograms of the oscillator waveform.

3. Heater. Since relatively large currents are present in the heater circuits, it is important that connections be clean, tight, and joints well soldered.

## Sweep Circuits

Trouble in the sweep circuits is indicated when a spot on the CRT screen can be obtained, but advancing the SWEEP STABILITY control does not result in a normal sweep of at least 11 cm. deflection, and at a speed indicated by the SWEEP RANGE and SWEEP SPEED MULT. controls. An approximate location of the difficulty can usually be established by observing the amplitude and waveform of the GATE OUTPUTS, SWEEP OUTPUT, and the amplified sweep voltage at the CRT deflection plates, with another oscilloscope. Further isolation should be possible by observing the input and output waveform of each stage at the tube sockets. A comparison with figures 9 to 25, inclusive, will show whether or not operation is normal. If not, check the tubes, operating voltages and resistance values in the suspected circuit.

Instability, or jitter of the sweep, when not due to faulty triggering or to jitter in the signal being observed, is usually caused by the introduction of a 60 cycle signal due to a defective tube. This trouble may be located by tube substitution. Excessive power supply ripple may also cause jitter.

Abnormal sweep speeds (out of range of the adjustment controls R42 and C15A) may be caused by wrong time constants or charging voltage in the sweep generator, or a change in gain of the sweep amplifier.

Short sweep length (less than 11 cm. when the sweep speed is properly adjusted) is due to faulty operation of the multivibrator.

1. Sweep Amplifier. A defect in the sweep amplifier may be indicated by low gain, improper horizontal positioning, non linear sweep, or abnormal CRT deflection plate voltages. To measure the sweep amplifier gain, set the SWEEP RANGE switch at EXT. and connect the CAL. OUTPUT to the EXT. SWEEP INPUT. With the CAL. VOLTAGE adjusted to 10 volts, a deflection of approximately 6.5 cm. should be obtained. After trying replacement of V12, V13 and V14, circuit operating voltages and the drop across each group of neon lamps should be measured. The potential across five NE 2 neon lamps should be 280 volts  $\pm$  30 volts. If outside this value, make individual lamp measurements, and replace defective units. The operating potential of new neon lamps may be high, but should become normal after several hours operation. Occasionally a Type NE 2 lamp will exhibit a tendency to oscillate. This condition is evidenced by a "spot" on the horizontal trace, usually near the sweep starting point. When a sine wave such as the Calibrating Voltage is applied to the CRT vertical deflection plates, the "spot" will assume the form of a damped wave train. If this trouble is encountered, short circuit the neon lamps, one at a time, until the oscillation disappears, thus isolating the defective lamp.

**CAUTION—LEAKAGE AT THE SEAL MAY RESULT IF THE NEON LAMP LEADS ARE BENT TOO CLOSE TO THE GLASS.**

2. Sweep Generator. Faulty operation of the sweep generator is indicated when the multivibrator output is normal (fig. 12) and the sawtooth at the plate of V9 (fig. 21) is not. If the sawtooth amplitude is low (slow

sweep speed), V9 is known to be good, and circuit voltages appear normal, remove V9 and measure the voltage at terminal 4 of V9 socket, which should be between +5 and +30 volts. This measurement is made with the SWEEP STABILITY control fully counter clockwise.

Error in sweep speed on one range only may be due to a defective timing capacitor, C15A, B, C, D or E. The capacity of C15E is selected from  $-3\%$  to  $+3\%$  of its design center and this value is stamped on its case. C15B, C and D are also selected to  $\pm 3\%$ , and then so matched to C15E that their capacity deviates from design center by the same amount and in the same direction as that of C15E. If it is necessary to replace one or more units, observe the capacity of C15E and select a replacement having the same percent and polarity of deviation from design center. If the exact capacity is not available, this may be accomplished by employing a capacitor of slightly lower than the required value and padding it up to the proper capacity. To preserve linearity on the slowest sweeps, use only a mineral oil filled capacitor for C15E.

If the indicated sweep speed is accurate with the SWEEP SPEED MULT. dial set at 1, but inaccurate at other settings, suspect a change in resistance of R20B. When replacement is necessary, this control should be ordered from the factory and will be supplied complete with an individually calibrated dial.

**CAUTION—THE FRONT SECTION OF THIS CONTROL MUST BE CONNECTED AS R20B, AND THE DIAL SUPPLIED WITH THE CONTROL MUST BE USED, OR THERE WILL BE AN ERROR IN INDICATED SWEEP SPEED.**

3. Multivibrator. It is important that the multivibrator output be of normal amplitude and free from frequency modulation. Low amplitude of the negative square wave output will be evidenced by short sweep length, and is usually caused by a poor 6AC7, V4. This condition is more likely to appear when the Type 511-A is operated at low line voltages, and therefore reduced heater temperature of V4. Low positive output will result in improper limiting of the unblanking pulse, and therefore uneven trace intensity on the CRT. See figures 9, 10, 11, 12, 17, 18, and 19.

Frequency modulation of the multivibrator output at line frequency is sometimes introduced by a defective 6AG7, V5. This condition makes it difficult to synchronize high frequency signals. If poor synchronizing is encountered, several type 6AG7's should be tried as new tubes often have this defect.

Poor tracking of the A and B sections of the SWEEP SPEED MULT. control, R20, may also cause short sweep length. See the Sweep Generator section for replacement instructions.

## Trigger Circuits

Faulty triggering of the sweep may be caused by insufficient amplitude of the trigger impulse or the introduction of spurious signals to the multivibrator.

If triggering is erratic, it is desirable to first eliminate the possibility that instability of the signal being observed is the cause. Possible internal causes are: arcing in the high voltage supply, introduction of a 60 cycle jitter due to defective tubes V16, V17, V1, V2 or V3, excess power supply ripple, and insufficient trigger amplifier gain.

The Type 511-A should trigger on signals of .5 volt or less applied to the TRIGGER INPUT except on the 1 microsecond range, which may require a slightly larger trigger input. The trigger sensitivity may be quickly measured as follows:

Connect a **short** wire between the CAL. OUTPUT and TRIGGER INPUT binding posts, set the sweep speed at 10,000 microseconds, the SIGNAL CALIBRATE switch at X.1, the CAL. VOLTAGE at 0, the TRIGGER SEL. at +EXT., the TRIGGER AMPL. fully clockwise, and the SWEEP STABILITY at a point just below the setting required to make the sweep occur. Now advance the CAL. VOLTAGE control until a stable sweep is obtained. Repeat, using the -EXT. trigger setting. If the external trigger sensitivity is normal (.5 volt or less) but internal triggering is inadequate, V17 and associated components should be checked. See figures 26, 27, and 28 for typical trigger gain and waveform.

To provide smooth adjustment of the trigger impulse, a special tapered potentiometer, R6, is employed as the TRIGGER AMPL. control. It is recommended that this control be ordered from the factory if replacement is required; however a linear potentiometer may be substituted if necessary.

### Video Amplifier

Defects in the video amplifier may be isolated by introducing a test signal (such as the CAL. OUTPUT) through a series capacitor to various circuit points, and observing the result on the 511-A's cathode ray tube.

The following precautions should be observed if it becomes necessary to replace circuit components:

1. V16, 6AG7. The heaters of some type 6AG7's introduce a line frequency signal and may cause synchronizing difficulty, or vertical deflection of the trace at line frequency, when the INPUT CHAN. SEL. is in the 2 stages position. Since 6AG7's exhibit a marked variation of input capacity, it is desirable to check the adjustment of

C44, as explained in the "Adjust of Input Attenuator" section. If satisfactory waveshape cannot be obtained, try another 6AG7.

2. C39, C51. These electrolytic capacitors are employed in the low frequency compensating circuits, and should be replaced if the range of R99 and R116 becomes insufficient to properly compensate the amplifier. It is necessary that the actual capacity be within the limits specified in the "Parts List" section.

3. R111, R111.1, R112, R112.1, R126, R126.1, R127 and R127.1. These are V18 and V19 plate load resistors. If replacement is necessary, the values must be selected so that the total resistance of each series of four is between 1300 and 1360 ohms. After replacement, it is desirable to check the high frequency response of the amplifier, and if necessary, readjust as explained under "Adjustment of Video Amplifier H.F. Response."

4. R93 and R93.2. These are the V16 plate load resistors. Replacements should be selected for a total series value between 1175 and 1240 ohms, and the adjustment of L4 and L5 checked.

5. R107, VERT. AMPL. ATTEN. If this control must be replaced in the Type 511-AD, it may be necessary to install a different value Delay Network shunt resistor. See Section VII. This control has an additional rotation stop punched in the cover; therefore the cover should be removed and installed on the new control, unless a replacement is ordered from the factory.

6. R74, R75 and R76. These components provide the proper CAL. VOLTAGE output, R74 and R75 being selected to match R76. If one of these components must be replaced, it is suggested that a set of all three parts be ordered from the factory to obtain the best CAL. accuracy. However, reasonably good accuracy will be obtained if 3.9 K is used for R74, 78 K for R75 and 5 K for R76.

7. Wiring Dress. Since the Type 511-A is designed to observe high speed transients, it is important that the original low capacity construction in the video amplifier signal circuits be maintained. Therefore, when replacing any electronic components or wires, be sure that the original positions are maintained. The leads between the deflection plate access panel and the CRT socket should be dressed apart and away from other conductors.



## Voltage and Continuity Tables

**CAUTION**—THE POTENTIALS AND RESISTANCES LISTED IN THESE TABLES ARE AVERAGE VALUES. MANY OF THEM WILL EXHIBIT CONSIDERABLE NORMAL VARIATION WITH DIFFERENT INDIVIDUAL INSTRUMENTS, DUE TO MANUFACTURING TOLERANCES OF THE ELECTRONIC COMPONENTS AND TUBE CHARACTERISTICS.

Therefore, these tables should be used only in conjunction with careful study of the Circuit Description, Maintenance section and Schematic Diagrams.

Unless otherwise specified, the readings were obtained at these control settings:

INPUT CHAN. SEL.....	2 Stages
INPUT ATTENUATOR.....	X1
VERT. AMPL. ATTEN.....	Clockwise
SIGNAL CALIBRATE.....	Signal
VERT. POSITION.....	Centered
CAL. VOLTAGE.....	0
ASTIGMATISM.....	Centered
INTENSITY.....	Centered
POWER.....	ON
FOCUS.....	Centered
HOR. POSITION.....	Clockwise
SWEEP MAGNIFIER POSITION.....	Out
SWEEP SPEED MULT.....	1
EXT. SWEEP ATTEN.....	Clockwise
SWEEP RANGE.....	1000 microseconds
SWEEP STABILITY.....	Counter Clockwise
TRIGGER AMPL.....	Counter Clockwise
TRIGGER SEL.....	+ INT.
DEFLECTION POLARITY.....	Centered

### AVERAGE TUBE SOCKET VOLTAGES

Measured at 117 volt line.

DC voltmeter sensitivity 20,000 ohms per volt.

Tube	Pin	To	Voltage		
V1	1, 2	Gnd.	0		
	3, 5	Gnd.	+15.5		
	4	Gnd.	+7	..... 50 volt scale	
	6	Gnd.	+187		
	7	Gnd.	6.5AC		
	8	Gnd.	+177		
V2	1, 2	Gnd.	0		
	3, 5	Gnd.	+10	TRIGGER AMPL. clockwise	
	3, 5	Gnd.	0	TRIGGER AMPL. counter clockwise	
	4	Gnd.	0	TRIGGER AMPL. clockwise	
	4	Gnd.	-20	TRIGGER AMPL. counter clockwise ..... 50 volt scale	
	6	Gnd.	+225		
	7	Gnd.	6.5AC		
	8	Gnd.	+170	TRIGGER AMPL. clockwise	
	8	Gnd.	+225	TRIGGER AMPL. counter clockwise	
V3				SWEEP STABILITY counter clockwise	
				See V2 and V4 voltages	
V4	1, 3, 5, 7	Gnd.	0		
	2	Gnd.	6.5AC		
	4	Gnd.	+1.2	SWEEP STABILITY clockwise ..... 10 volt scale	
	4	Gnd.	-42	SWEEP STABILITY counter clockwise ... 50 volt scale	
	6	Gnd.	+36	SWEEP STABILITY clockwise	
	6	Gnd.	+67	SWEEP STABILITY counter clockwise	
	8	Gnd.	+110	SWEEP STABILITY clockwise	
	8	Gnd.	+210	SWEEP STABILITY counter clockwise	
	V5	1, 2, 3, 5	Gnd.	0	
		4	Gnd.	-15	SWEEP STABILITY clockwise
4		Gnd.	-4	SWEEP STABILITY counter clockwise ... 10 volt scale	
6		Gnd.	+36	SWEEP STABILITY clockwise	
6		Gnd.	+67	SWEEP STABILITY counter clockwise	
7		Gnd.	6.5AC		
8		Gnd.	+210	SWEEP STABILITY clockwise	
8		Gnd.	+142	SWEEP STABILITY counter clockwise	

Tube	Pin	To	Voltage	
V6	1	Gnd.	+5	
	2	Gnd.	+65	SWEEP STABILITY clockwise
	2	Gnd.	+27	SWEEP STABILITY counter clockwise
	3	Gnd.	6.5AC	
	4, 7	Gnd.	0	
V7	5	Gnd.	+65	
	3	Gnd.	0	
	4	Gnd.	6.5AC	
	5	Gnd.	+225	
	6	Gnd.	+65	SWEEP STABILITY clockwise
	6	Gnd.	+27	SWEEP STABILITY counter clockwise
	7	Gnd.	+70	SWEEP STABILITY clockwise
V8	7	Gnd.	+39	SWEEP STABILITY counter clockwise
	1	Gnd.	+185	SWEEP STABILITY clockwise
	1	Gnd.	+215	SWEEP STABILITY counter clockwise
	3	Gnd.	6.5AC	
	4	Gnd.	0	
	6	Gnd.	+27	SWEEP STABILITY clockwise
	6	Gnd.	0	SWEEP STABILITY counter clockwise ... 50 volt scale
V9	7	Gnd.	+40	SWEEP STABILITY clockwise
	7	Gnd.	+11	SWEEP STABILITY counter clockwise
	1, 2, 3, 5	Gnd.	0	
	4	Gnd.	-20	SWEEP STABILITY clockwise ... 50 volt scale
	4	Gnd.	+25	SWEEP STABILITY counter clockwise ... 2.5 volt scale
	6	Gnd.	+225	SWEEP STABILITY clockwise
	6	Gnd.	+32	SWEEP STABILITY counter clockwise
V10	7	Gnd.	6.5AC	
	8	Gnd.	+65	SWEEP STABILITY clockwise
	8	Gnd.	+3.2	SWEEP STABILITY counter clockwise
	3	Gnd.	0	
	4	Gnd.	6.5AC	
	5	Gnd.	+225	
	6	Gnd.	+65	SWEEP STABILITY clockwise
V11	6	Gnd.	+3.2	SWEEP STABILITY counter clockwise
	7	Gnd.	+70	SWEEP STABILITY clockwise
	7	Gnd.	+16	SWEEP STABILITY counter clockwise
	1	Gnd.	+156	MAGNIFIER POSITION out
	1	Gnd.	+145	MAGNIFIER POSITION clockwise
	2	Gnd.	+135	MAGNIFIER POSITION out
	2	Gnd.	+110	MAGNIFIER POSITION clockwise
V12	3	Gnd.	0	
	4	Gnd.	6.5AC	
	5	Gnd.	+2.5	MAGNIFIER POSITION out
	5	Gnd.	+28	MAGNIFIER POSITION clockwise
	6	Gnd.	+5	..... 10 volt scale
	7	Gnd.	+5	MAGNIFIER POSITION out
	7	Gnd.	+30	MAGNIFIER POSITION clockwise
V13	1, 5	Gnd.	+4	..... 10 volt scale
	2, 3, 7	Gnd.	0	..... 10 volt scale
	4	Gnd.	6.5AC	
V14	1	Gnd.	+4	..... 10 volt scale
	2, 7	Gnd.	+5	HOR. POSITION clockwise
	2, 7	Gnd.	+12	HOR. POSITION counter clockwise
	3	Gnd.	6.5AC	
	4	Gnd.	0	
	5, 6	Gnd.	+280	HOR. POSITION clockwise
	5, 6	Gnd.	+430	HOR. POSITION counter clockwise
V14	1	Gnd.	0	HOR. POSITION clockwise
	1	Gnd.	+16	HOR. POSITION counter clockwise
	2, 7	Gnd.	+5	HOR. POSITION clockwise
	2, 7	Gnd.	+16	HOR. POSITION counter clockwise
	3	Gnd.	6.5AC	
	4	Gnd.	0	
	5, 6	Gnd.	+290	HOR. POSITION clockwise
5, 6	Gnd.	+140	HOR. POSITION counter clockwise	

Tube	Pin	To	Voltage	
V15	1, 4, 5	Gnd.	+450	
	3	V15 pin 4	6.5AC	
	6	Gnd.	+230 to	
			+390	depending on setting of R42
	6	Gnd.	450 V	S2C <sub>2</sub> in 1 microsec. pos.
	7	Gnd.	+260 to	
			+400	depending on setting of R42
V16	7	Gnd.	440 V	S2C <sub>2</sub> in 1 microsec. pos.
	1, 3, 5, 7	Gnd.	0	
	2	Gnd.	6.5AC	
	4	Gnd.	-.6	.....10 volt scale
	6	Gnd.	+145	
V17	8	Gnd.	+150	
	1, 3, 5	Gnd.	+57	
	2	Gnd.	0	
	4	Gnd.	+45	.....250 volt scale
	6	Gnd.	+225	
V18	7	Gnd.	6.5AC	
	8	Gnd.	+190	
	1, 5	Gnd.	+32	DEFLECTION POLARITY up and center
	1, 5	Gnd.	+29	DEFLECTION POLARITY down
	2	Gnd.	6.5AC	
	3	Gnd.	0	
	4	Gnd.	+13 to +23	depending on setting of R-115.....50 volt scale
	6	Gnd.	+160	DEFLECTION POLARITY up
	6	Gnd.	+195	DEFLECTION POLARITY center
	6	Gnd.	+165	DEFLECTION POLARITY down
	7	Gnd.	0	
V19	8	Gnd.	+190	DEFLECTION POLARITY up*
	8	Gnd.	+150	DEFLECTION POLARITY center*
	8	Gnd.	+110	DEFLECTION POLARITY down*
	1, 5	Gnd.	+32	DEFLECTION POLARITY up and center
	1, 5	Gnd.	+29	DEFLECTION POLARITY down
	2	Gnd.	6.5AC	
	3	Gnd.	0	
	4	Gnd.	+23	DEFLECTION POLARITY up .....50 volt scale
	4	Gnd.	+20	DEFLECTION POLARITY center .....50 volt scale
	4	Gnd.	+17.5	DEFLECTION POLARITY down .....50 volt scale
	6	Gnd.	+160	DEFLECTION POLARITY up
6	Gnd.	+195	DEFLECTION POLARITY center	
6	Gnd.	+165	DEFLECTION POLARITY down	
7	Gnd.	0		
8	Gnd.	+110	DEFLECTION POLARITY up*	
8	Gnd.	+150	DEFLECTION POLARITY center*	
8	Gnd.	+200	DEFLECTION POLARITY down*	
V20	1	Pin 14	6.5AC	
	2	Pin 14	+160	INTENSITY clockwise
	2	Pin 14	+80	INTENSITY counter clockwise
	3	Pin 14	+83	INTENSITY clockwise
	3	Pin 14	0	INTENSITY counter clockwise
	5	Gnd.	-750	FOCUS clockwise
	5	Gnd.	-1100	FOCUS counter clockwise
	7	Gnd.	0 (±40v)	SWEEP STABILITY counter clockwise — spot centered
	8	Gnd.	0 (±40v)	
	9	Gnd.	-140	ASTIGMATISM clockwise
	9	Gnd.	+225	ASTIGMATISM counter clockwise
10	Gnd.	0 (±40v)	SWEEP STABILITY counter clockwise — spot centered	
11	Gnd.	0 (±40v)		
V21	1	T1, term. 8	260AC	
	2, 3, 7	Gnd.	+680	
	4	V21, pin 3	6.5AC	
	6	T1, term. 8	260AC	
V22	2	V22, pin 8	5.2AC	
	4, 6	Gnd.	280AC	
	8	Gnd.	+325	

Tube	Pin	To	Voltage
V23	2	V23, pin 8	5.2AC
	4, 6	Gnd.	280AC
	8	Gnd.	+325
V24	1, 6	Gnd.	-335
	3	V24, pin 4	6.5AC
	4, 7	Gnd.	280AC
V25	1	+450	-18
	2, 3	Gnd.	+450
	4	V25, term. 3	6.5AC
	5, 6	Gnd.	+680
V26	1	+225	-1.3
	2, 7	+225	0
	3	V26, pin 4	6.5AC
	5	+450	-18
	6	+225	+46
V27	1, 4	+225	-38
	2, 5	Gnd.	+325
	3, 6	Gnd.	+225
	7	Gnd.	6.5AC
	8	Gnd.	0
V28	1	Gnd.	+87
	2, 7	Gnd.	+89
	3	Gnd.	0
	4	Gnd.	6.5AC
	5	+225	-38
	6	Gnd.	+137
V29	1	Gnd.	+89
	4	Gnd.	0
V30	2	Gnd.	-150
	5	Gnd.	0
V31	1, 7	Gnd.	-17
	2	Gnd.	+2.4
	3	Gnd.	0
	4	Gnd.	6.5AC
	5	Gnd.	+225
	6	Gnd.	+140
V32	2	Pin 7	1.25AC
	7	Gnd.	+1600
V33	2	Pin 7	1.25AC
	Cap.	Gnd.	-1500

Measured with thermocouple meter

\*NOTE: Use a 100k composition resistor at the end of the voltmeter probe to prevent error in reading due to oscillation which might otherwise result when the meter is connected.

### POINT TO POINT TUBE SOCKET CONTINUITY

(Tubes in Sockets)

NOTE: Readings less than .1 ohm are listed 0.

Tube	Pin No.	To	Resistance
V1	1	Gnd.	0
	2	Gnd.	0
	3	Gnd.	1830
	4	Gnd.	470K
	5	Gnd.	1830
	6	+225	4.7K
	7	Gnd.	0
	8	+225	6.2K

Tube	Pin No.	To	Resistance	
V2	1	Gnd.	0	
	2	Gnd.	0	
	3	Gnd.	1000	
	4	Gnd.	470K	TRIGGER AMPL. clockwise
			780K	TRIGGER AMPL. counter clockwise
	5	Gnd.	1000	
	6	+225	0	
	7	Gnd.	0	
	8	+225	10K	
V3	1	V2 pin 8	0	
	2	+225	10K	
	3	Gnd.	0	
	4	Gnd.	0	
	5	V2 pin 8	0	
	6			
	7	+225	10K	
V4	1	Gnd.	0	
	2	Gnd.	0	
	3	Gnd.	0	
	4	Gnd.	75K	SWEEP STABILITY clockwise
	4	+225	75K	SWEEP STABILITY clockwise
	5	Gnd.	0	
	6	Gnd.	10K	
	6	+225	12K	
7	Gnd.	0		
	8	+225	9.5K	
V5	1	Gnd.	0	
	2	Gnd.	0	
	3	Gnd.	0	
	4	Gnd.	200K	SWEEP SPEED MULT. clockwise
	4	Gnd.	2.2M	SWEEP SPEED MULT. counter clockwise
	5	Gnd.	0	
	6	Gnd.	10K	
	6	+225	12K	
	7	Gnd.	0	
	8	+225	4.5K	
	8	V4 pin 4	80K	
V6	1	Gnd.	35M	
	1	V11 pin 6	470	
	2	-140	85K	
	2	V5 pin 8	78K	
	3	Gnd.	0	
	4	Gnd.	0	
	5	Gnd.	14K	
	5	+225	20K	
	6			
7	Gnd.	0		
V7	1			
	2			
	3	Gnd.	0	
	4	Gnd.	0	
	5	+225	0	
	6	V6 pin 2	0	
	7	Gnd.	10K	
V8	1	+225	10K	
	2			
	3	Gnd.	0	
	4	Gnd.	0	
	5			
	6	Gnd.	250K	
	7	Gnd.	10K	



Tube	Pin No.	To	Resistance	
V9	1	Gnd.	0	
	2	Gnd.	0	
	3	Gnd.	0	
	4	-140	65K	
	4	+225	70K	
	5	Gnd.	0	
	6	+225	20K	
	7	Gnd.	0	
	8	Gnd.	infinite	
V10	1			
	2			
	3	Gnd.	0	
	4	Gnd.	0	
	5	+225	0	
	6	V9 pin 8	0	
	7	Gnd.	10K	
V11	1	+225	10K	
	2	+225	14.7K	
	3	Gnd.	0	
	4	Gnd.	0	
	5	Gnd.	8.2K	SWEEP MAGNIFIER POSITION out
	6	Gnd.	35M	
V12	1, 5	Gnd.	35M	
	2, 3	Gnd.	0	
	4	Gnd.	0	
	6			
	7	Gnd.	0	
V13	1	V12 pin 5	180	
	2, 7	-140	11K	
	2, 7	V14 pin 2	900	
	3	Gnd.	0	
	4	Gnd.	0	
	5, 6	+450	25K	
V14	1	Gnd.	0	HOR. POSITION clockwise
	1	Gnd.	90K	HOR. POSITION counter clockwise
	2, 7	-140	11K	
	3	Gnd.	0	
	4	Gnd.	0	
	5, 6	+450	25K	
V15	1	+450	0	
	2			
	3	+450	.2	
	4	+450	0	
	5	+450	0	
	6	+450	240K to 480K depending on setting of R-42	
	6	+450	0	with SWEEP RANGE set at 1 microsec.
	7	V9 pin 8	200K	SWEEP SPEED MULT. clockwise
	7	V9 pin 8	2.2M	SWEEP SPEED MULT. counter clockwise
V16	1, 3			
	2	Gnd.	0	
	4	Gnd.	1M	
	5, 7	Gnd.	0	
	6	+225	10K	
	8	+225	3.2K	
V17	1, 3, 5	Gnd.	2K	
	2	Gnd.	0	
	4	Gnd.	1M	INPUT CHAN. SEL. set at 1 STAGE
	6	+225	0	
	7	Gnd.	0	
	8	+225	1.5K	

Tube	Pin No.	To	Resistance	
V18	1, 5	Gnd.	440	
	2	Gnd.	0	
	3, 7	Gnd.	0	
	4	Gnd.	290K	R-116 counter clockwise
	4	Gnd.	1.3M	R-116 clockwise
	6	+225	2.2K	S9 in center position
	6	+225	4.4K	S9 in up or down position
	8	+225	2.8K	
V19	1, 5	V18 pin 1	0	
	2	Gnd.	0	
	3, 7	Gnd.	0	
	4	Gnd.	470K	
	6	V18 pin 6	0	
	8	+225	2.8K	
V20	1	T1 term. 25	0	
	1	Gnd.	9M	
	2	V20 pin 1	500K	
	3	V20 pin 1	2M	INTENSITY control clockwise
	3	V20 pin 1	1.5M	INTENSITY control counter clockwise
	5	V20 pin 1	3.5M	FOCUS control clockwise
	5	V20 pin 1	1.9M	FOCUS control counter clockwise
	7	Y2 access panel	0	
	8	Y1 access panel	0	
	9	-140	0	ASTIGMATISM control clockwise
	9	+225	0	ASTIGMATISM control counter clockwise
	10	X2 access panel	0	
	11	X1 access panel	0	
	14	V20 pin 1	.2	
V21	1	T1, term. 7	0	
	2, 3, 7	T1, term. 11	0	
	4	T1, term. 10	0	
	6	T1, term. 9	0	
	8	+225	1K	
V22	2	T1, term. 13	0	
	4, 6	T1, term. 14	0	
V23	2	V22 pin 2	0	
	4, 6	T1, term. 16	0	
	8	V22 pin 8	0	
V24	1, 6	-140	4.5K	
	3	T1, term. 17	0	
	4, 7	T1, term. 16	0	
V25	1	V25 pin 5	470K	
	2, 3	T1, term. 6	0	
	4	+450	0	
	5, 6	V21 pin 7	0	
V26	1	Gnd.	550K	
	2, 7	+225	0	
	3	T1, term. 22	0	
	4	T1, term. 23	0	
	5	V25 pin 1	0	
	6	+225	43K	
	6	+450	130K	
	8	Gnd.	0	
V27	1, 4	V22 pin 8	470K	
	2, 5	+225	1K	
	3, 6	+225	0	
	7	Gnd.	0	
	8	Gnd.	0	
V28	1	Gnd.	630K with R-159 set at midpoint	
	2, 7	+225	74K	
	3	Gnd.	0	
	4	Gnd.	0	
	5	V27 pin 4	0	
	6	+225	47K	

Tube	Pin No.	To	Resistance
V29	1	V28 pin 2	0
	4	Gnd.	0
V30	1, 5	Gnd.	0
	2	-140	470
V31	1	Gnd.	100K
	2	Gnd.	100
	3	Gnd.	0
	4	Gnd.	0
	5	+225	160
	6	+225	15K
V32	1, 3, 4, 5, 6, 7, 8	Gnd.	50M
	2	V32 pin 1	.1
	Cap	V33 pin 3	0
V33	1, 3, 4, 5 6, 7, 8	Gnd.	1.3K
	2	V33 pin 1	.1
	Cap	Gnd.	9M

### TRANSFORMER CONTINUITY

T1 (Measured with leads disconnected)

T2 (Measured with V32 and V33 removed from sockets)

Terminals	Ohms Resistance (20°C)	From	To	Ohms Resistance (20°C)
1 to 3	1.7			
2 to 4	1.7			
5 to 6	.3			
7 to 8	147.			
8 to 9	150.			
10 to 11	.27			
12 to 13	.03			
14 to 15	10.8			
15 to 16	10.9			
16 to 17	.21			
18 to 19	.025			
20 to 21	6.1			
22 to 23	.42			
24 to 25	.25			
		V31 pin 5	+225	15.3
		junction C74, C75	+225	2.8
		V32 pin 2	V32 pin 7	.03
		V33 pin 2	V33 pin 7	.03
		V33 pin 7	Gnd.	1175.

## Waveform Photographs

The following photographs are provided to facilitate servicing of the Type 511-A and will prove especially useful if another oscilloscope is available to observe the waveforms of the circuits being tested. Amplitudes are measured peak to peak.

**CAUTION**—These waveforms and amplitudes represent average values, selected from a number of instruments.

Considerable normal variation in individual oscilloscopes may be expected, due to a variety of causes, such as:

1. Loading effect of the test oscilloscope.
2. Non-linearity of the test oscilloscope.
3. Insufficient bandwidth of the test oscilloscope.
4. Manufacturing tolerances of the components in the Type 511-A under test.
5. Variations in control settings of the 511-A under test.
6. Line voltage variations.

### DEFLECTION POLARITY SELECTOR WAVEFORMS

Normal operation of this circuit for observation of pulses is shown in the following photographs. The sawtooth pulse has a duration of 1 millisecond and a 60 cycle repetition rate.

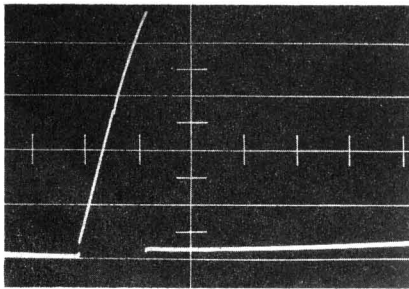

Fig. 1. Sawtooth pulse with DEFLECTION POLARITY switch in the "up" position, showing good linearity at 4 cm. deflection. A "step" has been introduced for comparison between the "up" and "center" positions.

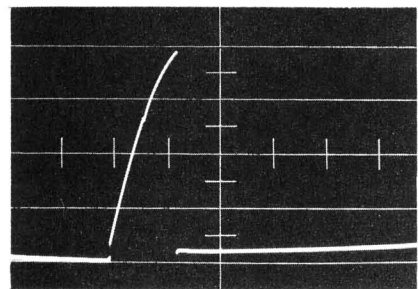

Fig. 2. Same pulse with DEFLECTION POLARITY switch in "center" position. Note that position of the step is unchanged, indicating good linearity for almost 3 cm. of deflection, but severe distortion between 3 and 4 cm.

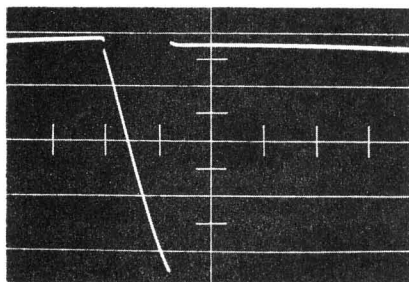

Fig. 3. Sawtooth pulse of opposite polarity with DEFLECTION POLARITY switch in the "down" position.

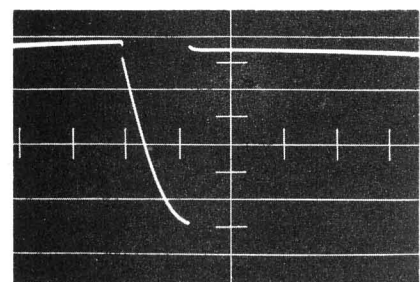

Fig. 4. Same pulse with DEFLECTION POLARITY switch in the "center" position.

## POWER SUPPLY WAVEFORMS

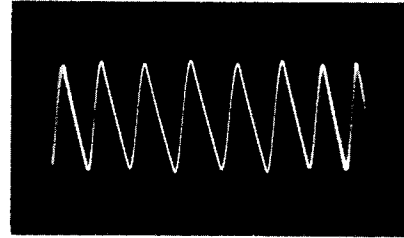
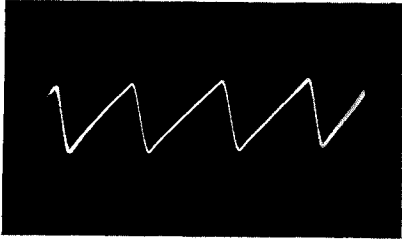

Fig. 5. 60 cycle ripple of -140 volt rectifier output at V24 plate. Amplitude 12 volts.

Fig. 6. 120 cycle ripple of +225 volt rectifier output at V22 cathode and +450 volt rectifier output at V21 cathode. Amplitude 15 volts.

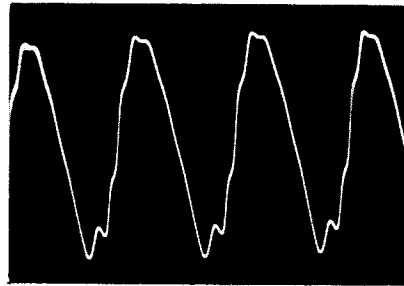
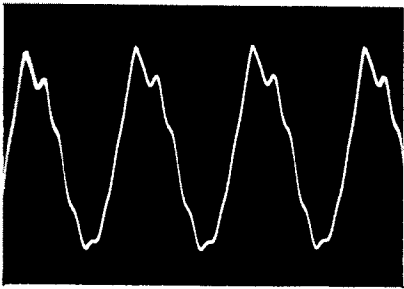

Fig. 7. High voltage supply oscillator waveform at V31 grid. Amplitude 75 volts.

Fig. 8. Waveform at V31 plate. Amplitude 350 volts.

## SWEEP AND TRIGGER CIRCUIT WAVEFORMS

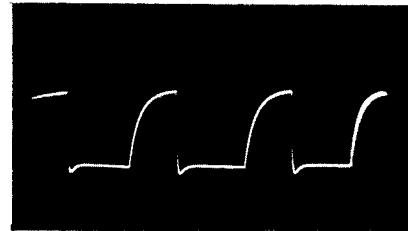
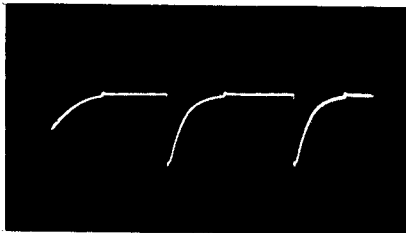

Fig. 9. Multivibrator waveform at V4 grid, with controls set for 10  $\mu$ sec. recurrent sweep. Amplitude 70 volts.

Fig. 10. Multivibrator waveform at V4 plate, controls set for 10  $\mu$ sec. recurrent sweep. Amplitude 120 volts.

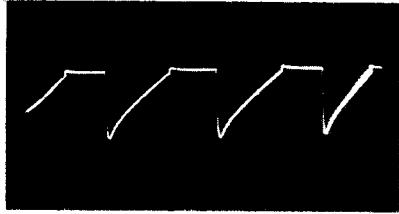

Fig. 11. Multivibrator waveform at V5 grid, controls set for 10  $\mu$ sec. recurrent sweep. Amplitude 85 volts.

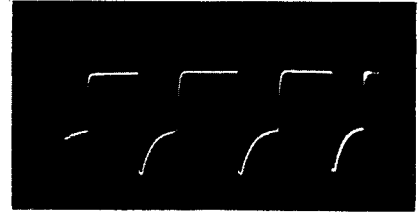

Fig. 12. Multivibrator waveform at V5 plate, controls set for 10  $\mu$ sec. recurrent sweep. Amplitude 160 volts.

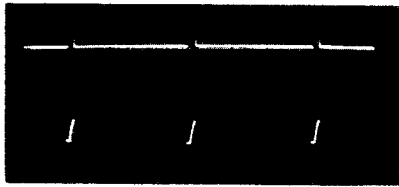

Fig. 13. Waveform at +GATE, controls set for 1000  $\mu$ sec. recurrent sweep. Amplitude 45 volts.

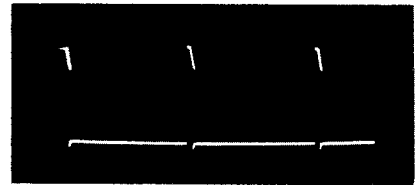

Fig. 14. Waveform at -GATE, controls set for 1000  $\mu$ sec. recurrent sweep. Amplitude 45 volts.

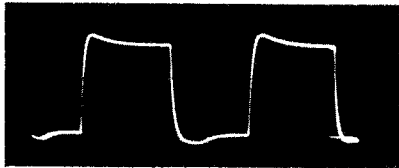

Fig. 15. +GATE, controls set for 10  $\mu$ sec. recurrent sweep. Amplitude 45 volts.

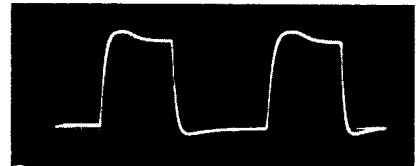

Fig. 16. -GATE, controls set for 10  $\mu$ sec. recurrent sweep. Amplitude 45 volts.

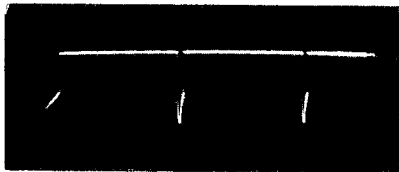

Fig. 17. Unblanking pulse at V7 cathode, 1000  $\mu$ sec. recurrent sweep. Amplitude 70 volts.

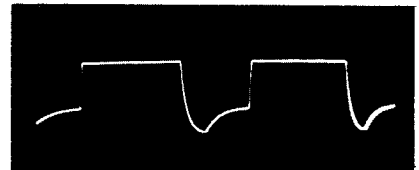

Fig. 18. Unblanking pulse at V7 cathode, 10  $\mu$ sec. recurrent sweep. Amplitude 65 volts.

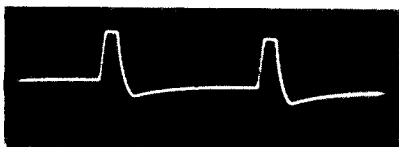

Fig. 19. Unblanking pulse at V7 cathode, 1  $\mu$ sec. recurrent sweep. Amplitude 65 volts.

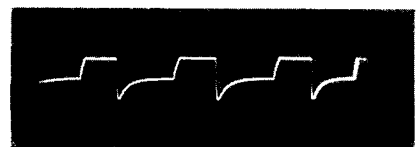

Fig. 20. Waveform at V9 grid, 10  $\mu$ sec. recurrent sweep. Amplitude 50 volts. Exposure made under same conditions as figures 8, 9, 10 and 11.



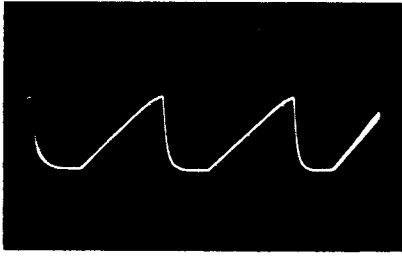

Fig. 21. Sweep sawtooth at V9 plate, 10  $\mu$ sec. recurrent sweep. Amplitude 35 volts. This waveform also appears at the SWEEP OUTPUT binding post at an amplitude of 25 volts.

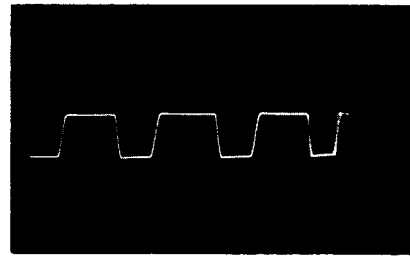

Fig. 22. Magnified sweep waveform at V11 plate, showing the 10  $\mu$ sec. recurrent sweep of Fig. 20 magnified 5X. Amplitude 25 volts.

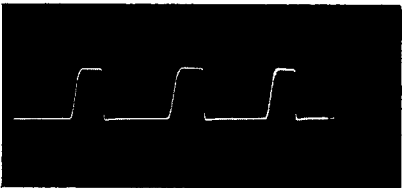

Fig. 23. Same as Fig. 21, except with a different setting of SWEEP MAGNIFIER POSITION control. Amplitude 30 volts.

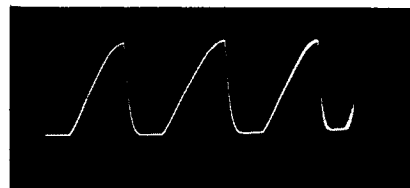

Fig. 24. Amplified sweep sawtooth at X1 deflection plate, 10  $\mu$ sec. recurrent sweep. Amplitude 200 volts.

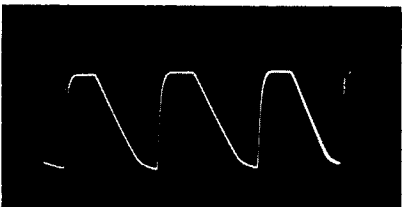

Fig. 25. Amplified sweep sawtooth at X2 deflection plate, 10  $\mu$ sec. recurrent sweep. Amplitude 200 volts.

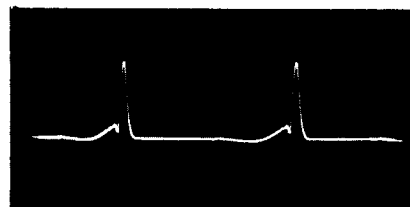

Fig. 26. 1  $\mu$ sec. negative pulse at V1 grid from either video amplifier or TRIGGER INPUT. Amplitude .5 volt.

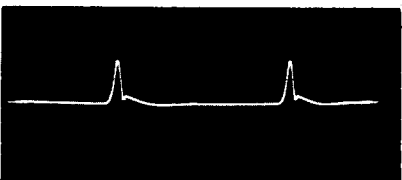

Fig. 27. The same pulse at V2 grid. Negative Trigger polarity. Amplitude .25 volt.



Fig. 28. The same pulse, amplified, at V2 plate. Amplitude 5 volts.

## VIDEO AMPLIFIER WAVEFORMS

These photographs should be used in conjunction with the Adjustment section of this manual during adjustment of the video amplifier.

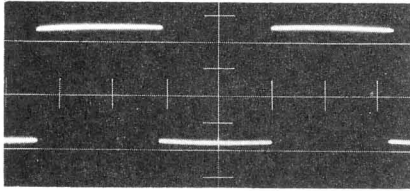

Fig. 29. Normal response to a 50 cycle square wave.

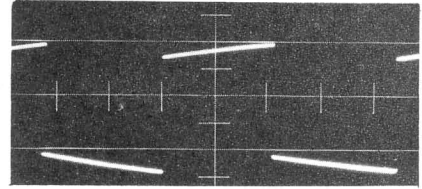

Fig. 30. Response to 50 cycle square wave when low frequency compensation is excessive, indicating need for adjustment of R99 and/or R116.

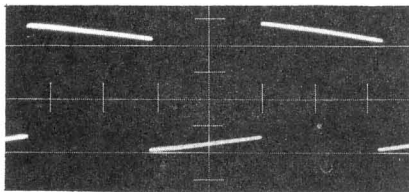

Fig. 31. Response to 50 cycle square wave when low frequency compensation is insufficient, also indicating need for L.F. adjustment.

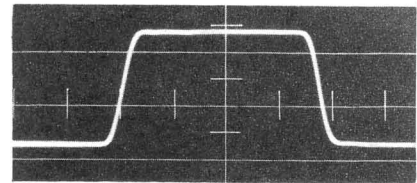

Fig. 32. Normal response to 1 megacycle square wave.

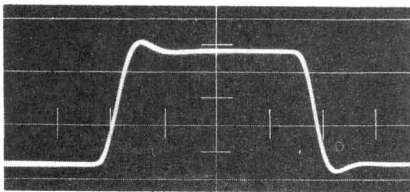

Fig. 33. Response to 1 megacycle square wave showing overshoot due to excessive high frequency compensation. Readjustment is indicated.

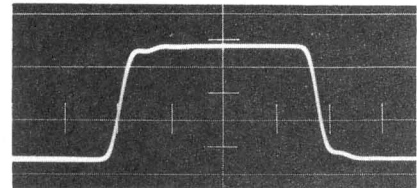

Fig. 34. Response to 1 megacycle square wave showing the effect of insufficient high frequency compensation.

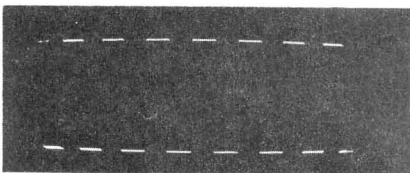

Fig. 35. Normal response to 1 kilocycle square wave.

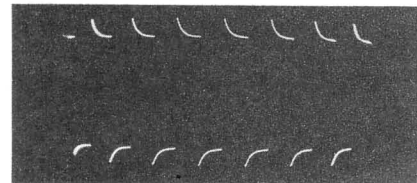

Fig. 36. Response to 1 kilocycle square wave with the input attenuator or probe over compensated.

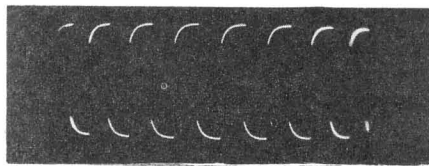

Fig. 37. Response to 1 kilocycle square wave with the input attenuator or probe under compensated



## Adjustment

### OPERATION ON 210-250 VOLT LINE

The power transformer of the Type 511A is wound with two 115 volt primaries. When the instrument leaves the factory the primaries are ordinarily connected in parallel for 105-125 volt operation. If operation from 210-250 volt lines is desired remove the jumpers connecting terminals 1 to 2 and 3 to 4. Now connect terminals 2 and 3 together. With the line still connected to terminals 1 and 4 the instrument is ready for 210-250 volt operation.

### ADJUSTMENT OF 225 VOLT REGULATED SUPPLY

In order for the instrument to perform properly it is necessary that the 225 volt supply be within plus or minus 5 volts of that value. This should be checked with an accurate voltmeter and corrected if necessary by adjustment of the potentiometer R-159 on the power supply chassis marked ADJ TO 225 V. This check should always be made if the 5651 tube V-29 is changed.

### ADJUSTMENT OF SWEEP SPEED CALIBRATION

If the Cathode Ray Tube is replaced, or if the Sweep Amplifier tubes V13 and V14 change their characteristics, the indicated sweep speeds may be in error. This may be corrected by adjustment of the potentiometer on the chassis marked SWEEP SPEED ADJ. (R42), for all ranges except the 1 to 10 microsecond range, which is corrected by varying C15A located on the rear section of the Sweep Range Switch.

These adjustments may be made with the aid of an accurately calibrated oscillator. A commonly available instrument suitable for this purpose is the Army Frequency Meter BC 221, or the Navy equivalent, Type LM. If this type instrument is used, set the frequency at 200 KC and connect it to the Type 511-A SIGNAL INPUT. With the SWEEP SPEED MULT. at 1 and the SWEEP RANGE at 10 microseconds, adjust R42 until 2 cycles coincide with the 10 cm. scale. Change the frequency meter setting to 2 mc., set the SWEEP SPEED MULT. at 2, the SWEEP RANGE at 1 microsecond and adjust C15A until 4 cycles occupy the 10 cm. scale.

**CAUTION**—USE NORMAL INTENSITY, AS THE CRT DEFLECTION SENSITIVITY INCREASES AT MAXIMUM INTENSITY. USE THE MINIMUM TRIGGER AMPL. SETTING CONSISTENT WITH A STABLE PATTERN.

### ADJUSTMENT OF INPUT ATTENUATOR

The RC compensated attenuator used in the Type 511A is really two attenuators in parallel, one a resistive divider and the other a capacity divider. The ratio of the resistive divider is maintained by the use of accurate resistors. Since the stray capacities are not negligible compared to the values used in the capacity

divider, each divider incorporates a variable ceramic trimmer capacitor in one arm. To make the input capacity of each amplifier and that of the attenuator equal, similar capacitors are shunted across these circuits also.

The easiest way to make these adjustments is to send a square wave through the attenuator and observe the resulting waveshape on the oscilloscope itself. When the capacity and resistive dividers have the same ratio the square wave is reproduced correctly. If the capacity divider has a lower attenuation ratio than the resistive divider a spike appears on the corners. If the capacity divider has a higher attenuation, the corners are rounded. To make these effects more pronounced the square wave frequency should be such that one cycle is from 4 to 20 times the time constant of the attenuator. In the case of the Type 511-A a frequency of 1000 cycles is satisfactory. The amplitude of the square wave test signal should be adjustable from 1 to 50 volts (peak to peak).

The Tektronix Type 104 and Type 105 Square Wave Generators are suitable for this purpose. If a Tektronix Type 512 Oscilloscope is available, its square wave calibrator may be used.

A procedure which has proven satisfactory is as follows:

1. Lay a metal sheet on top of the instrument to simulate the presence of the case.
2. Apply a 50 V square wave to the Signal Input connector, set the INPUT CHAN. SEL. to VIA COND., the INPUT ATTENUATOR to X2, and adjust C37 (left rear on attenuator).
3. Reduce the square wave amplitude to 10 V., move the INPUT CHAN. SEL. to 1 STAGE, and adjust C42 (left on Input Chan. Sel.).
4. Move INPUT ATTEN. to X4, increase square wave to 20V, and adjust C34 (center rear on attenuator).
5. Move INPUT ATTEN. to X8, increase square wave to 40 V, and adjust C31 (right rear on attenuator).
6. Reduce the square wave amplitude to 1 V, move the INPUT CHAN. SEL. to 2 STAGES, INPUT ATTEN. to X2, and adjust C44 (right on input chan. sel.).
7. Move square wave signal from SIGNAL INPUT to the probe, apply a 5 V signal, set INPUT ATTEN to X1, and adjust the probe compensating capacitor.
8. Move INPUT ATTEN. to X2 and adjust C38 (left front on attenuator), using a 10 V signal.
9. Move INPUT ATTEN. to X4 and adjust C35 (center front on attenuator), using a 25 V signal.
10. Move INPUT ATTEN. to X8 and adjust C32 (right front on attenuator), using a 50 V signal.

### ADJUSTMENT OF VIDEO AMPLIFIER H. F. RESPONSE

The video amplifier in the Type 511A employs a four terminal coupling network which is adjusted at the factory for optimum transient response, rather than flattest frequency response. This is done by observing

the response to a 1 mc square wave having a rise time of .03 microseconds or less. This test signal should have squarest possible corners and a minimum of overshoot so that the oscilloscope compensation adjustments are not inadvertently used to correct for these deficiencies.

The Tektronix Type 104 and Type 105 Square Wave Generators provide a suitable signal.

Since the image on the tube is the resultant deflection of both sides of the push-pull amplifiers V18 and V19, the adjustment of the compensating coils is somewhat interdependent. The factory procedure which gives the flattest frequency response consistent with satisfactory transient response is as follows:

1. Set all cores in the compensating coils for minimum inductance.
2. Place INPUT CHAN. SEL. in 1 STAGE position and set VERT. AMPL. ATTEN. for maximum gain.
3. Apply 1 mc square wave of such amplitude that about 2 to 3 cm deflection is obtained (INPUT ATTENUATOR may be in any position).
4. Increase the inductance of L8 until a slight overshoot appears.
5. Adjust L7 and L9 (readjust L8 slightly if necessary) so that the best compromise is obtained between squareness of the corners and flatness of the level portion is obtained.
6. If it is not possible to obtain a satisfactory wave shape, increase the inductance of L10 and repeat steps 4 and 5.

7. Move the INPUT CHAN. SEL. to 2 STAGES, and readjust the amplitude of the input signal for the same deflection as before.

8. Adjust L4 and L5 for best waveshape.

The bandwidth may now be measured if desired. For the 1 STAGE position the response should be flat to about 5 mc, sloping gradually to be 2.5 to 3 db down at 10 mc. For 2 STAGES the curve is similar except falling somewhat more steeply, being 2.5 to 3 db down at about 8.5 mc.

#### **ADJUSTMENT OF VIDEO AMPLIFIER L.F. RESPONSE**

Since the low frequency compensation circuit of the Type 511A necessarily involves the use of electrolytic condensers, it may be occasionally necessary to correct for a change in their capacity. This is easily done by observing the response to a low frequency square wave (30-60 cycles) and making the following adjustments:

1. With the INPUT CHAN. SEL. at 1 STAGE, adjust R116 (the rear LF ADJ) so that the best waveshape is obtained.
2. Move to the 2 STAGES position and adjust R99 (the front LF ADJ).

**BE SURE THE AMPLIFIER IS NOT OVERLOADED.**

For a standard of comparison, observe the square wave reproduction with the INPUT CHAN. SEL. in the DIRECT position. The Tektronix Type 104 and Type 105 Square Wave Generators provide a suitable signal source for this adjustment.

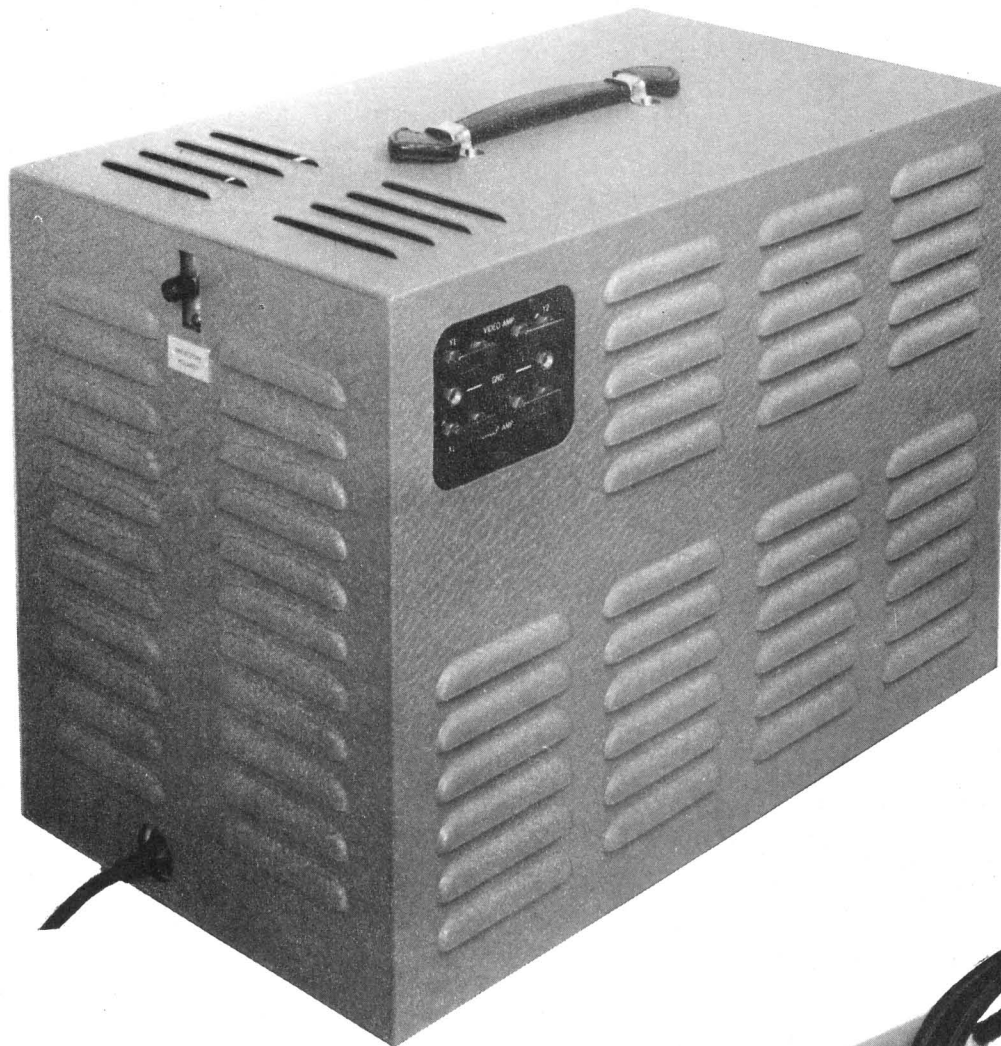

Fig. 38. Rear — left view.

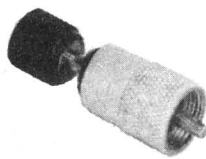

Fig. 39. Binding Post Adapter.



Fig. 40. Input Probe.

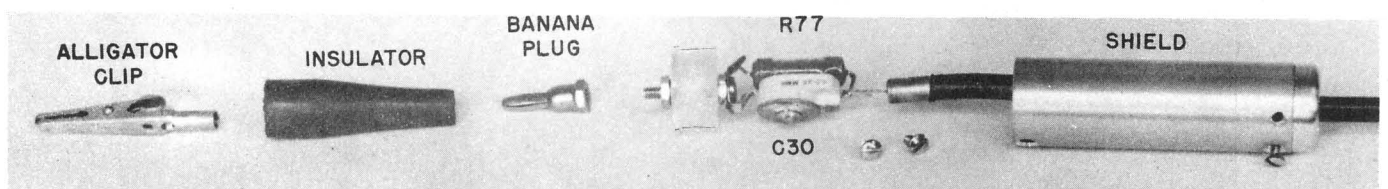

Fig. 41. Input Probe disassembled.

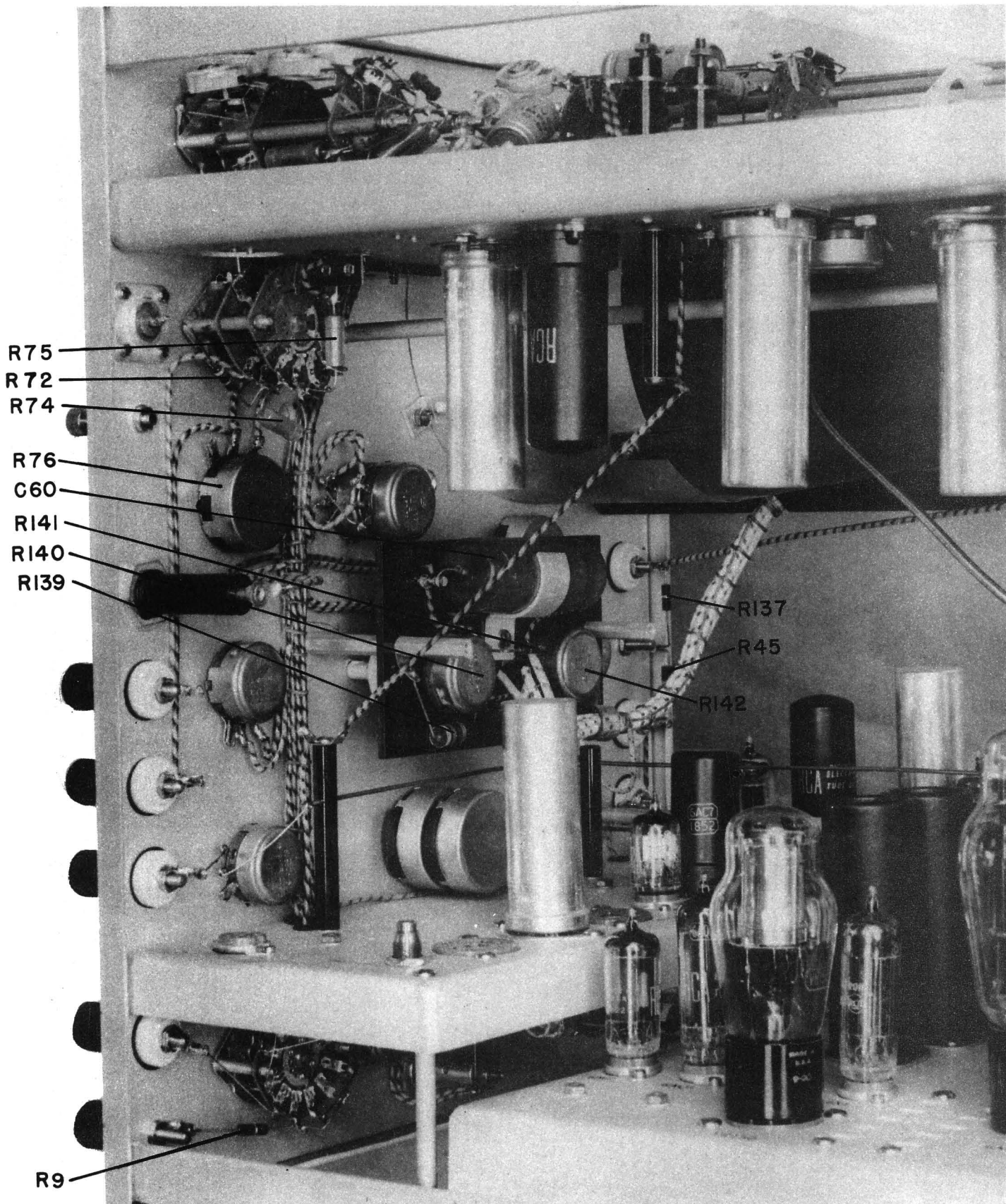
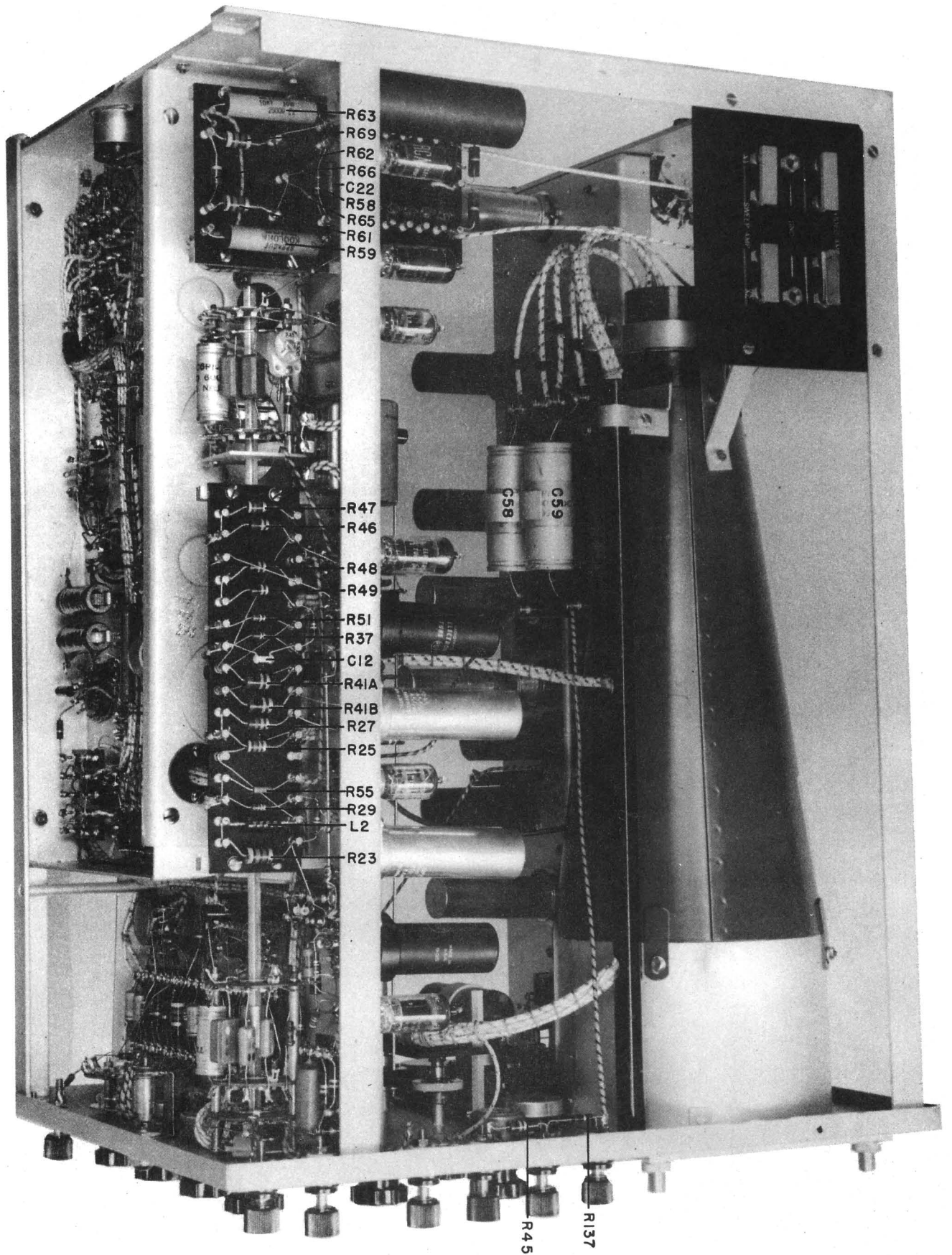

Fig. 42. Interior view, right front side.



Fig. 43. Interior view, left side.



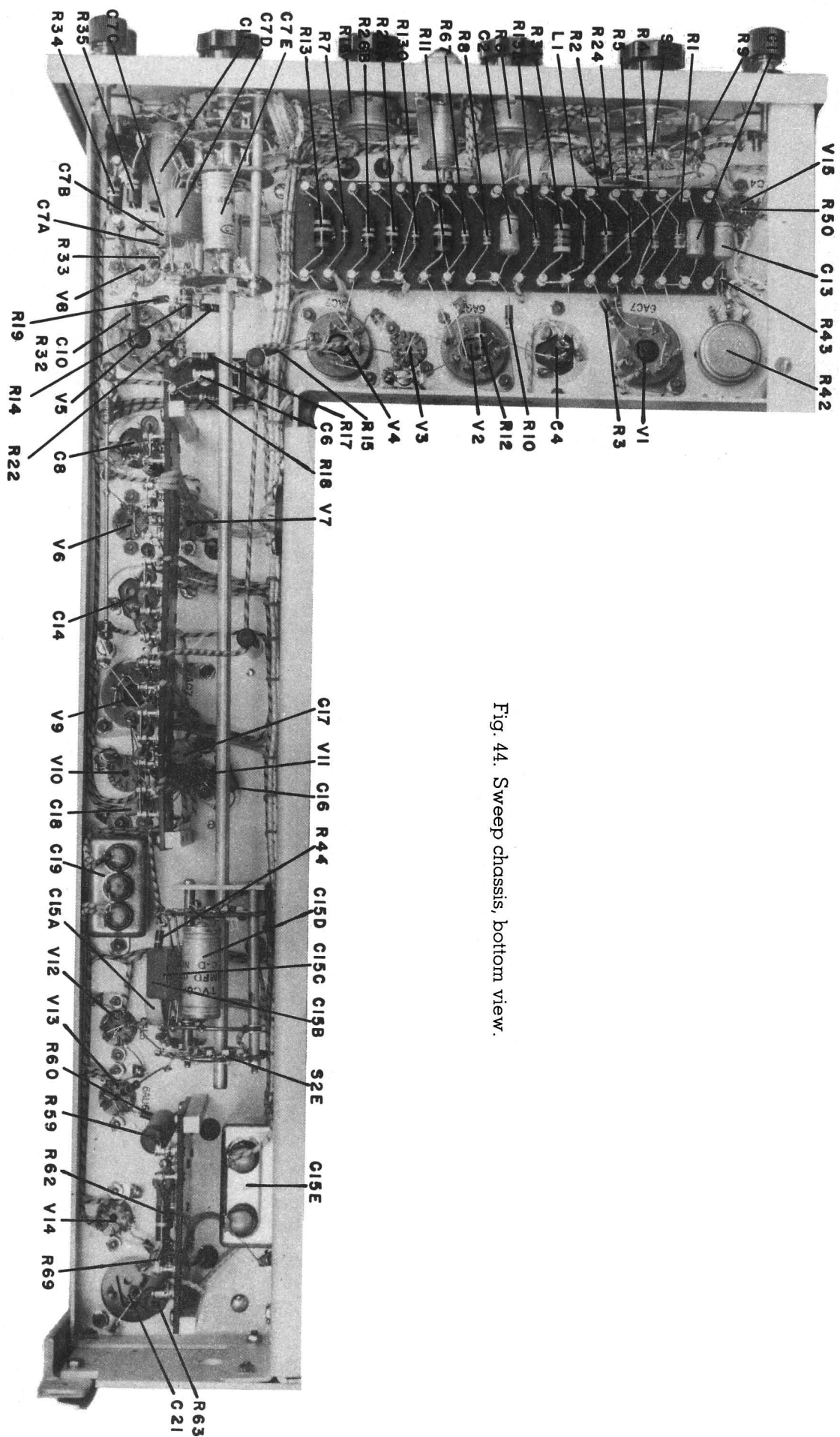

Fig. 44. Sweep chassis, bottom view.

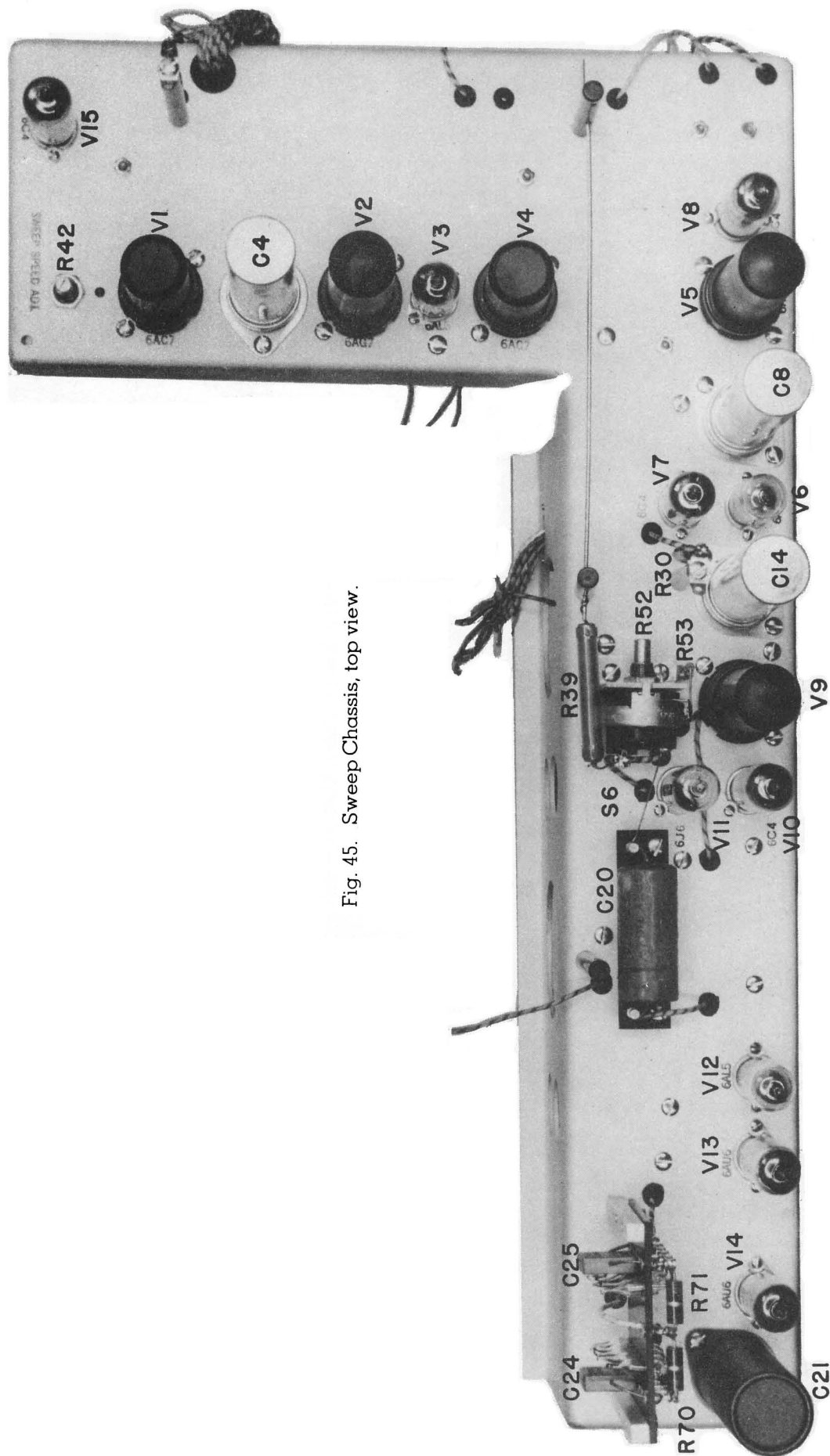

Fig. 45. Sweep Chassis, top view.

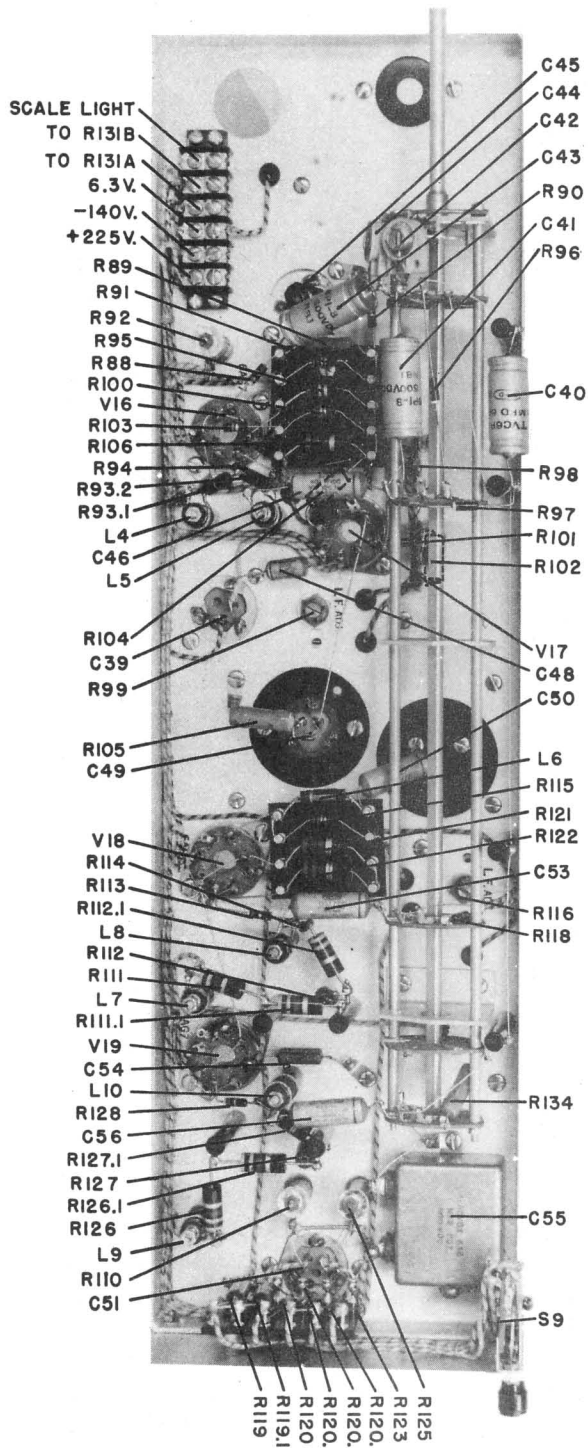

Fig. 46. Video Amplifier, top.

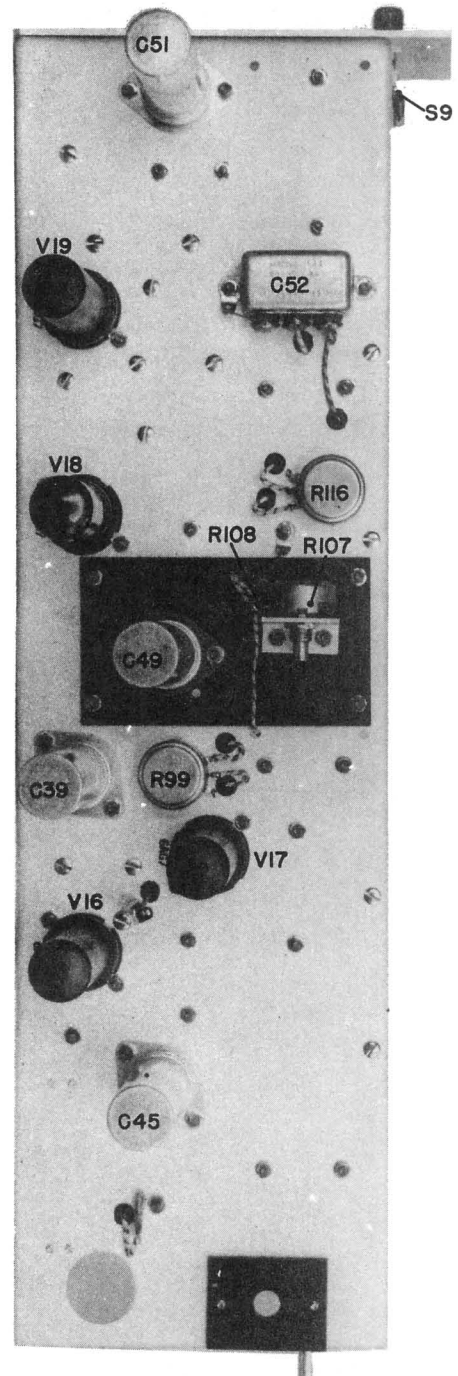

Fig. 47. Video Amplifier, bottom.



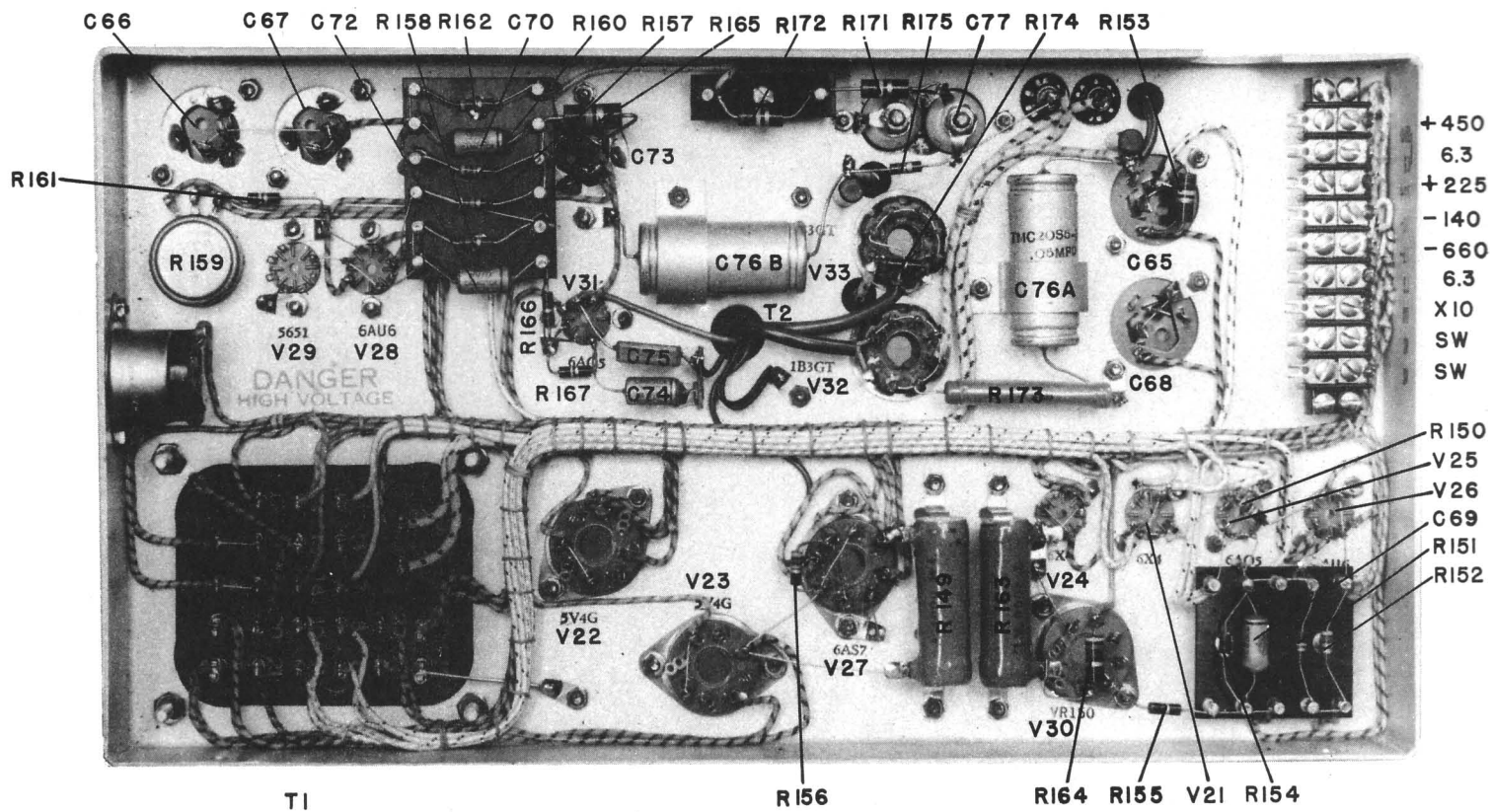

Fig. 48. Power Supply, bottom view

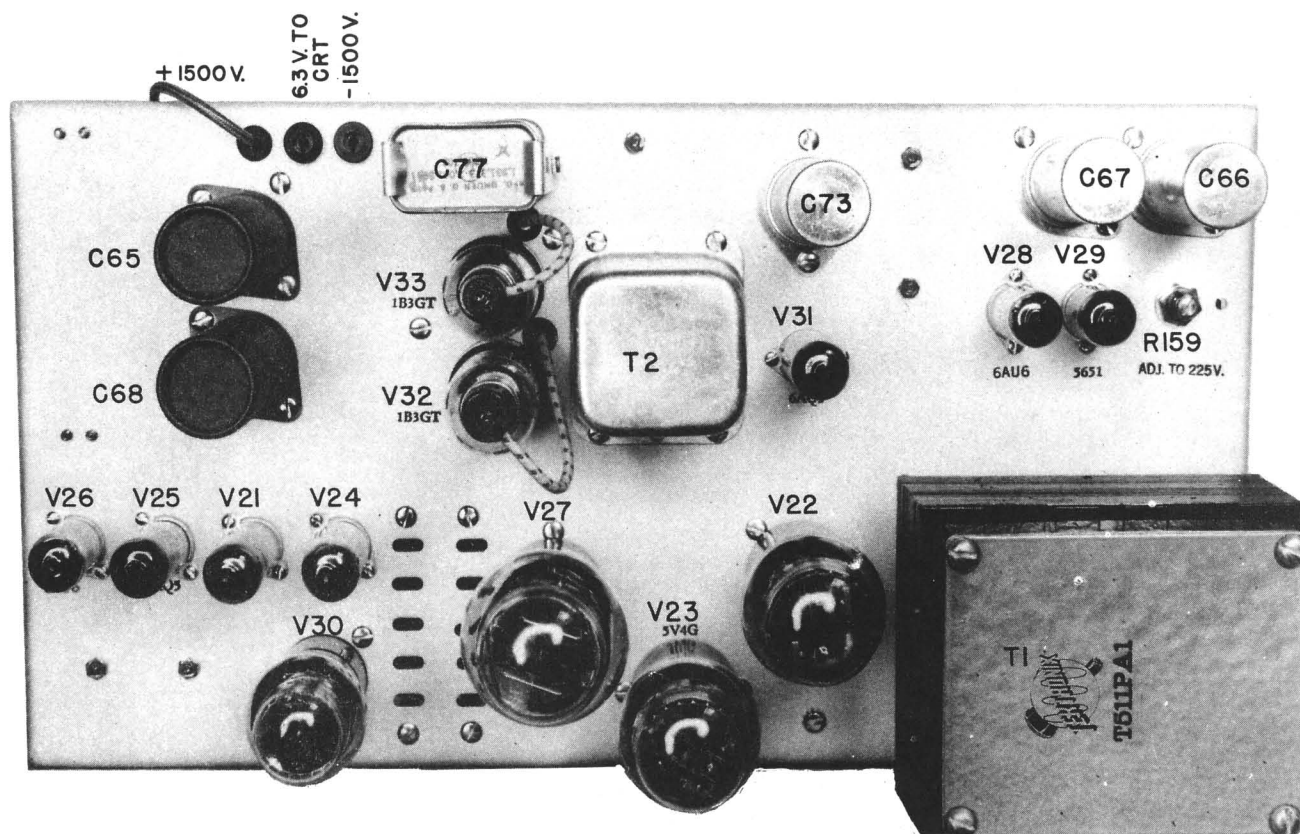

Fig. 49. Power Supply, top view.

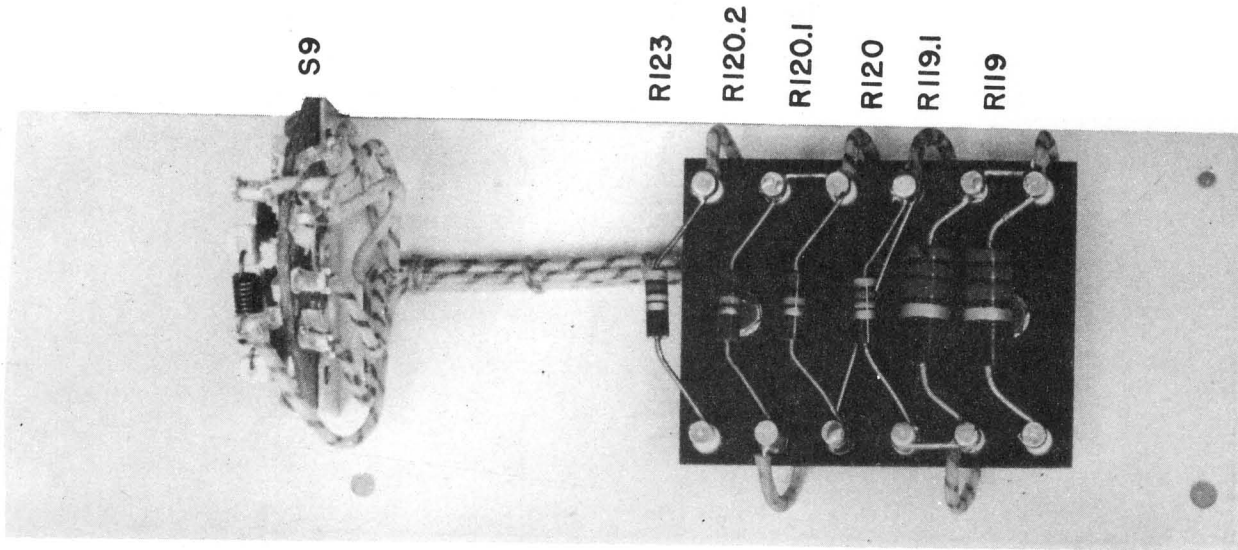

Fig. 52. Deflection Polarity Switch and Terminal Board

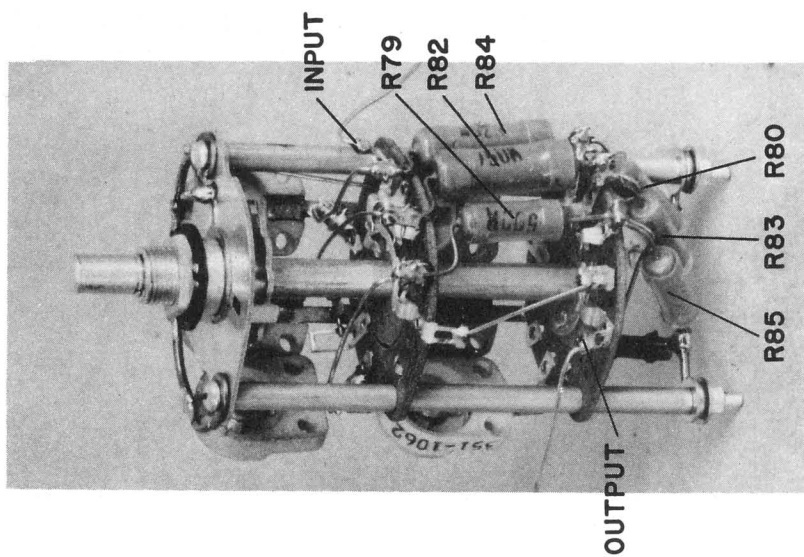

Fig. 51. Vertical Attenuator, bottom.

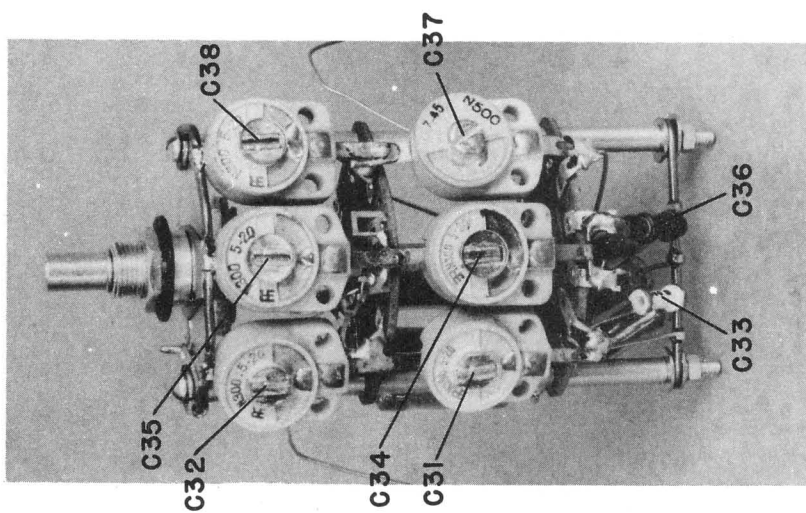
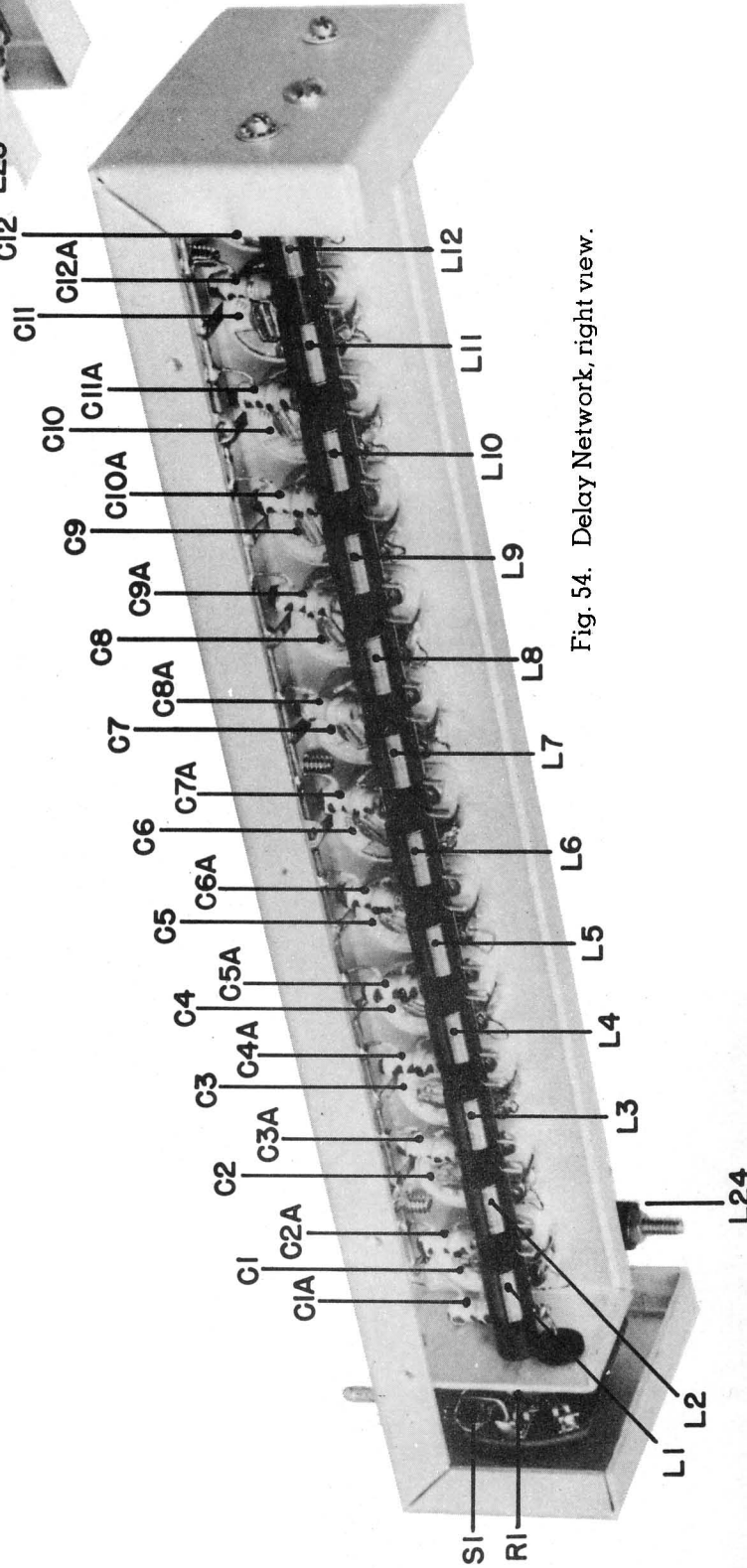
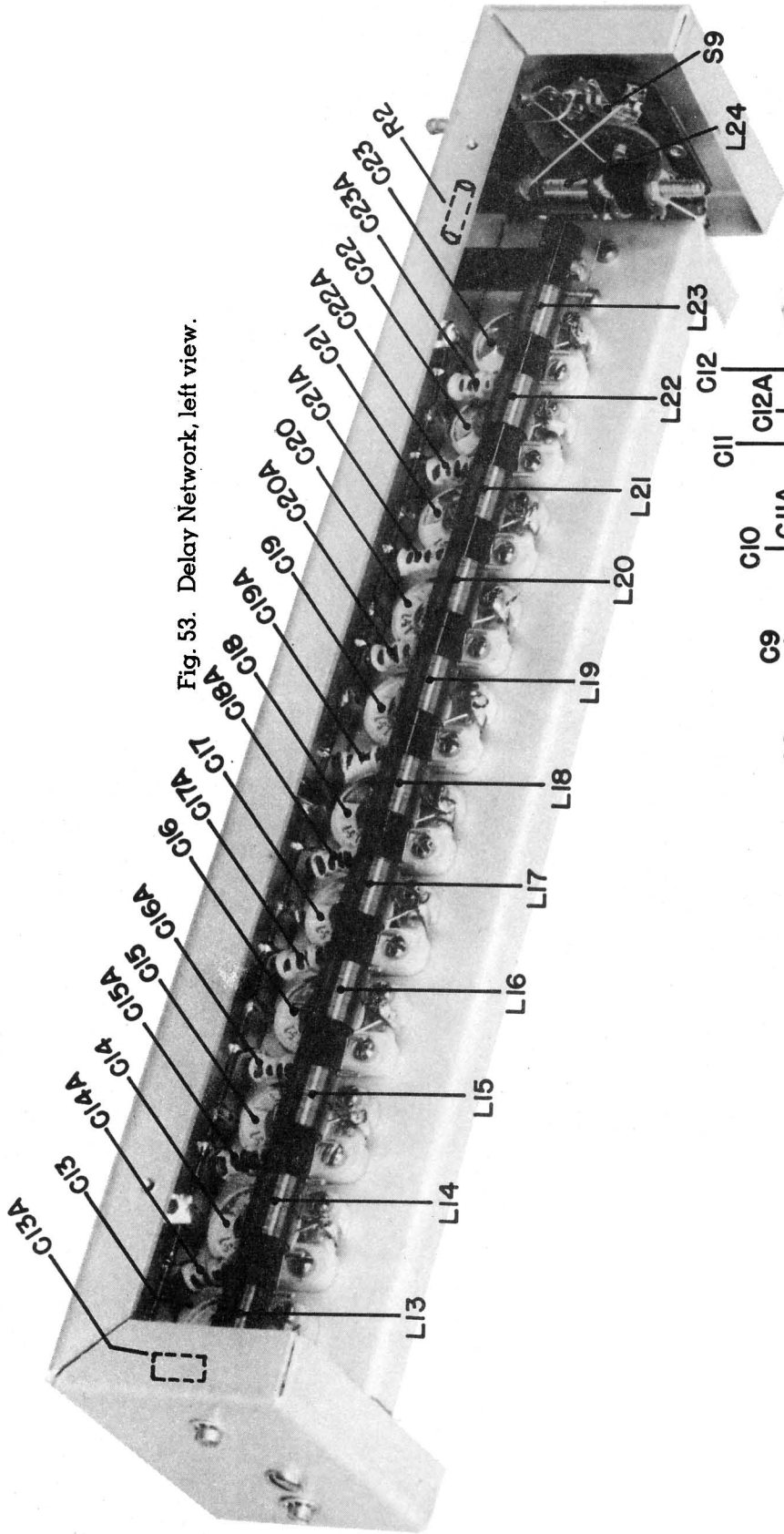

Fig. 50. Vertical Attenuator, top.







## SECTION V

### PARTS LIST

#### ABBREVIATIONS

Cer.—Ceramic	PMC—Paper, Metal Cased
Comp.—Composition	PT—Paper, Tubular
EBT—Electrolytic, Bathtub	Prec.—Precision
EMC—Electrolytic, Metal Cased	Var.—Variable
PBT—Paper, Bathtub	WW—Wire Wound
PM—Paper, Molded	Dep. Carb.—Deposited Carbon

#### CONDENSERS

C1	Fixed	PT	.01	$\mu$ f	20%	400 WVDC	
C2	Fixed	PT	.01	$\mu$ f	20%	400 WVDC	
C4A,B	Fixed	EMC	2x20	$\mu$ f	-20%+50%	450 WVDC	
C6	Fixed	Mica or Cer.	50	$\mu$ $\mu$ f	10%	400 WVDC	
C7A	Fixed	Mica or Cer.	22	$\mu$ $\mu$ f	-0+10%	400 WVDC	.15
C7B	Fixed	Mica	<del>220</del> 250	$\mu$ $\mu$ f	5%	400 WVDC	.15
C7D	Fixed	Mica	<del>2200</del> 2500	$\mu$ $\mu$ f	5%	400 WVDC	.27
C7E	Fixed	PT	.022	$\mu$ f	5%	400 WVDC	.63
C8A,B	Fixed	EMC	2x20	$\mu$ f	-20%+50%	450 WVDC	
C9	Fixed	Cer.	50	$\mu$ $\mu$ f	10%	400 WVDC	
C10	Fixed	Cer.	8	$\mu$ $\mu$ f	10%	400 WVDC	
C11	Fixed	PT	.05	$\mu$ f	20%	400 WVDC	
C12	Fixed	Mica or Cer.	50	$\mu$ $\mu$ f	10%	400 WVDC	
C13	Fixed	PT	.01	$\mu$ f	20%	600 WVDC	
C14A,B	Fixed	EMC	2x20	$\mu$ f	-20%+50%	450 WVDC	
C15AA	Fixed	Mica or Cer.	12	$\mu$ $\mu$ f	10%	400 WVDC	
C15A	Var.	Cer.	7-45	$\mu$ $\mu$ f		500 WVDC	
C15B	Fixed	PT	920	$\mu$ $\mu$ f	2% Selected	400 WVDC	.23
C15C	Fixed	PT	.01	$\mu$ f	2% Selected	400 WVDC	.23
C15D	Fixed	PT	.1	$\mu$ f	2% Selected	400 WVDC	.95
C15E	Fixed	PBT	1.	$\mu$ f	2% Selected	200 WVDC	2.55
C16	Fixed	Mica	100	$\mu$ $\mu$ f	10%	400 WVDC	
C17	Fixed	PT	.1	$\mu$ f	10%	400 WVDC	
C18	Fixed	Mica	100	$\mu$ $\mu$ f	10%	400 WVDC	
C19A,B	Fixed	PBT	3x.1	$\mu$ f	20%	400 WVDC	
C20	Fixed	PT	.5	$\mu$ f	20%	400 WVDC	
C21	Fixed	EMC	40	$\mu$ f (2x20)	-20%+50%	450 WVDC	
C22	Fixed	Mica	500	$\mu$ $\mu$ f	10%	500 WVDC	
C24	Fixed	PT	.001	$\mu$ f	20%	600 WVDC	
C25	Fixed	PT	.001	$\mu$ f	20%	600 WVDC	
C29	Fixed	Cer.	1000	$\mu$ $\mu$ f		500 WVDC	
C30	Var.	Cer.	5-20	$\mu$ $\mu$ f		500 WVDC	
C31	Var.	Cer.	5-20	$\mu$ $\mu$ f		500 WVDC	
C32	Var.	Cer.	5-20	$\mu$ $\mu$ f		500 WVDC	
C33	Fixed	Cer.	50	$\mu$ $\mu$ f	10%	400 WVDC	
C34	Var.	Cer.	5-20	$\mu$ $\mu$ f		500 WVDC	
C35	Var.	Cer.	5-20	$\mu$ $\mu$ f		500 WVDC	
C36	Fixed	Cer.	25	$\mu$ $\mu$ f	10%	400 WVDC	
C37	Var.	Cer.	7-45	$\mu$ $\mu$ f		500 WVDC	
C38	Var.	Cer.	5-20	$\mu$ $\mu$ f		500 WVDC	
C39A	Fixed	EMC	15	$\mu$ f	-0+50%	450 WVDC	1.38

C39B	Fixed	EMC	15	$\mu f$	-20% +50%	450 WVDC	1.38
C40	Fixed	PT	.1	$\mu f$	20%	600 WVDC	
C41	Fixed	PT	.1	$\mu f$	20%	600 WVDC	
C42	Var.	Cer.	5-20	$\mu\mu f$		500 WVDC	
C43	Fixed	PT	.1	$\mu f$	20%	600 WVDC	
C44	Var.	Cer.	1.5-7	$\mu\mu f$		500 WVDC	
C45A,B	Fixed	EMC	2x20	$\mu f$	-20% +50%	450 WVDC	
C46	Fixed	PT	.1	$\mu f$	20%	400 WVDC	
C47.1	Fixed	Cer.	1000	$\mu\mu f$		500 WVDC	
C47.2	Fixed	Cer.	1000	$\mu\mu f$		500 WVDC	
C49	Fixed	PT	.01	$\mu f$	10%	400 WVDC	
C48	Fixed	EMC	120	$\mu f$ (3x40)	-20% +50%	150 WVDC	
C50	Fixed	PT	.1	$\mu f$	20%	400 WVDC	
C51A,B	Fixed	EMC	2x20	$\mu f$	10%	450 WVDC	1.99
C52A,B	Fixed	PBT	2x.05	$\mu f$	20%	400 WVDC	
C53	Fixed	PT	.1	$\mu f$	20%	400 WVDC	
C54	Fixed	Mica or Cer.	500	$\mu\mu f$	20%	400 WVDC	
C55	Fixed	PBT	1.	$\mu f$	20%	400 WVDC	
C56	Fixed	PT	.1	$\mu f$	20%	400 WVDC	
C58	Fixed	PT	.1	$\mu f$	20%	2000 WVDC	1.02
C59	Fixed	PT	.1	$\mu f$	20%	2000 WVDC	1.02
C60	Fixed	PT	1.	$\mu f$	20%	400 WVDC	
C65	Fixed	EMC	40	$\mu f$ (2x20)	-20% +50%	450 WVDC	
C66	Fixed	EMC	40	$\mu f$ (2x20)	-20% +50%	450 WVDC	
C67	Fixed	EMC	40	$\mu f$ (2x20)	-20% +50%	450 WVDC	
C68	Fixed	EMC	40	$\mu f$ (2x20)	-20% +50%	450 WVDC	
C69	Fixed	PT	.01	$\mu f$	20%	400 WVDC	
C70	Fixed	PT	.01	$\mu f$	20%	400 WVDC	
C72	Fixed	PT	.01	$\mu f$	20%	400 WVDC	
C73A,B	Fixed	EMC	2x20	$\mu f$	-20% +50%	450 WVDC	
C74	Fixed	PT	.01	$\mu f$		400 WVDC	
C75	Fixed	Mica	.006	$\mu f$	10%	500 WVDC	
<del>C76A</del>	<del>Fixed</del>	<del>PT</del>	<del>.05</del>	<del><math>\mu f</math></del>	<del>20%</del>	<del>2000 WVDC</del>	<del>.87</del>
<del>C76B</del>	<del>Fixed</del>	<del>PT</del>	<del>.05</del>	<del><math>\mu f</math></del>	<del>20%</del>	<del>2000 WVDC</del>	<del>.87</del>
C77	Fixed	PMC	.5	$\mu f$	20%	2000 WVDC	4.05
C76C, D	"	"	2x.05	$\mu f$	20%	2000 "	

### INDUCTORS

L1	Fixed	35	microhenries	10%	.48	L7	Var.	7-12	microhenries	1.00
L2	Fixed	300	microhenries	10%	.80	L8	Var.	18-32	microhenries	1.00
L4	Var.	5-10	microhenries		1.00	L9	Var.	7-12	microhenries	1.00
L5	Var.	10-20	microhenries		1.00	L10	Var.	13-25	microhenries	1.00
L6	Fixed	2.0	microhenries	5%	.40					

### RESISTORS

R1	Fixed	Comp.	1/2 watt		470 K	10%	
R1.1	Fixed	Comp.	1/2 watt		47 ohm	10%	
R2	Fixed	Comp.	1 watt		1.5 K	10%	
R3	Fixed	Comp.	1/2 watt		47 ohm	10%	
R4	Fixed	Comp.	1/2 watt		330 ohm	10%	
R5	Fixed	Comp.	1 watt		1.5 K	10%	
R6	Var.	Comp.	1/4 watt		500 K	20%	Special taper
R7	Fixed	Comp.	1/2 watt		1.5 meg	10%	
R8	Fixed	Comp.	1/2 watt		470 K	10%	
R9	Fixed	Comp.	1/2 watt		1.0 meg	10%	
R10	Fixed	Comp.	1/2 watt		47 ohm	10%	
R11	Fixed	Comp.	2 watt		10K	10%	
R12	Fixed	Comp.	1 watt		1 K	10%	

R13	Fixed	Comp.	2 watt	10 K	10%
R14	Fixed	Comp.	1 watt	15 K	10%
R15	Fixed	Comp.	1/2 watt	47 ohm	10%
R16	Var.	Comp.	1/4 watt	100 K	20%
R17	Fixed	Comp.	1/2 watt	100 K	10%
R18	Fixed	Comp.	1/2 watt	220 K	10%
R19	Fixed	Comp.	1/2 watt	47 ohm	10%
R20C	Var.	Comp.	2 watt	250 K	20%
R20D	Var.	Comp.	2 watt	250 K	20%

R20C,D replacement furnished only with hand-calibrated sweep speed dial

7.50

R20C1 to 9	Fixed	Comp.	1/2 watt	220 K	10%
R20D1 to 9	Fixed	Prec.	1/2 watt	200 K	1%
R21	Fixed	Comp.	1 1/2 watt	220K 100K	5%
<del>R22</del>	<del>Fixed</del>	<del>Comp.</del>	<del>1/2 watt</del>	<del>100 K</del>	<del>5%</del>
R23	Fixed	Comp.	2 watt	4.7 K	10%
R24	Fixed	Comp.	1/2 watt	22 meg	10%
R25	Fixed	Comp.	1 watt	47 K	10%
R26A	Fixed	Comp.	1 watt	10 K	10%
R26B	Fixed	Comp.	1 watt	10 K	10%
R27	Fixed	Comp.	1 watt	18 K	10%
R28	Fixed	Comp.	1/2 watt	120 K	10%
R29	Fixed	Comp.	1/2 watt	180 K	10%
R30	Fixed	Comp.	1 watt	10 K	10%
R31	Fixed	Comp.	2 watt	4.7 K	10%
R32	Fixed	Comp.	1/2 watt	470 K	10%
R33	Fixed	Comp.	1/2 watt	470 K	10%
R34	Fixed	Comp.	1 watt	10 K	10%
R35	Fixed	Comp.	1 watt	10 K	10%
R36	Fixed	Comp.	1/2 watt	47 ohm	10%
R37	Fixed	Comp.	1/2 watt	120 K	10%
R38	Fixed	Comp.	1/2 watt	100 K	10%
R39	Fixed	Dep. Carb.	2 watt	200 K	2%
R39.1	Fixed	Comp.	1/2 watt	33 meg	10%
R40	Fixed	Comp.	1/2 watt	470 ohm	10%
R41A	Fixed	Comp.	2 watt	10 K	10%
R41B	Fixed	Comp.	2 watt	10 K	10%
R42	Var.	Comp.	1/4 watt	500 K	20%
R43	Fixed	Comp.	1/2 watt	1 meg	10%
R44	Fixed	Comp.	1/2 watt	4.7 K	10%
R45	Fixed	Comp.	1 watt	10 K	10%
R46	Fixed	Comp.	1 watt	10 K	10%
R47	Fixed	Comp.	1 watt	4.7 K	10%
R48	Fixed	Comp.	1 watt	10 K	10%
R49	Fixed	Comp.	1 watt	10 K	10%
R50	Fixed	Comp.	1/2 watt	270 K	10%
R51	Fixed	Comp.	1/2 watt	680 K	10%
R52	Var.	Comp.	1/4 watt	100 K	20%
R53	Fixed	Comp.	1/2 watt	8.2 K	10%
R54	Fixed	Comp.	1/2 watt	180 ohm	10%
R55	Fixed	Comp.	1/2 watt	35 meg	10%
R56	Fixed	Comp.	1/2 watt	35 meg	10%
R57	Var.	Comp.	1/4 watt	100 K	20%
R58	Fixed	Comp.	1/2 watt	4.7 K	10%
R59	Fixed	WW	10 watt	25 K	5%
R60	Fixed	Comp.	1/2 watt	180 ohm	10%
R61	Fixed	Comp.	2 watt	4.7 K	10%
R62	Fixed	Comp.	1 watt	1.2 K	10%
R63	Fixed	WW	10 watt	25 K	5%

each .33

R64	Fixed	Comp.	1/2 watt	180 ohm	10%	
R65	Fixed	Comp.	1/2 watt	560 ohm	10%	
R66	Fixed	Comp.	1/2 watt	560 ohm	10%	
R67	Fixed	Comp.	1/2 watt	820 K	10%	
R68	Var.	Comp.	1/4 watt	100 K	20%	
R68.1	Fixed	Comp.	1/2 watt	120 K	10%	
R69	Fixed	Comp.	2 watt	4.7 K	10%	
R70	Fixed	Comp.	1 watt	2.2 meg	10%	
R71	Fixed	Comp.	1 watt	2.2 meg	10%	
R72	Fixed	Comp.	1/2 watt	47 ohm	10%	
R73	Var.	WW	2 watt	50 ohm	20%	
R74	Fixed	Comp.	1/2 watt	3.7 K to 4 K as determined by calibration		
R75	Fixed	Comp.	1/2 watt	75 K to 82 K as above		
R76	Var.	WW	1 watt	5 K	10%	
R77	Fixed	Prec.	1 watt	9 meg	1%	.47
R79	Fixed	Prec.	1 watt	875 K	1%	.47
R80	Fixed	Prec.	1/2 watt	143 K	1%	.33
R82	Fixed	Prec.	1 watt	750 K	1%	.47
R83	Fixed	Prec.	1/2 watt	333 K	1%	.33
R84	Fixed	Prec.	1/2 watt	500 K	1%	.33
R85	Fixed	Prec.	1/2 watt	1 meg	1%	.33
R87	Fixed	Comp.	1/2 watt	10 K	10%	
R88	Fixed	Comp.	1/2 watt	47 ohm	10%	
R89	Fixed	Prec.	1/2 watt	1 meg	1%	.33
R90	Fixed	Comp.	1/2 watt	4.7 K	10%	
R91	Fixed	Comp.	1/2 watt	220 K	10%	
R92	Fixed	WW	5 watt	2 K	5%	
R93.1	Fixed	Comp.	1 watt	680 ohm	+0-5%	.26
R93.2	Fixed	Comp.	1 watt	560 ohm	+0-5%	
R94	Fixed	Comp.	1/2 watt	47 ohm	10%	
R95	Fixed	Comp.	1 watt	10 K	10%	
R96	Fixed	Comp.	1/2 watt	9.1 meg	5%	
R97	Fixed	Comp.	1/2 watt	9.1 meg	5%	
R98	Fixed	Comp.	1/2 watt	220 K	10%	
R99	Var.	Comp.	1/4 watt	500 K	20%	
R100	Fixed	Comp.	1/2 watt	220 K	10%	
R101	Fixed	Comp.	1/2 watt	100 ohm	10%	
R102	Fixed	Prec.	1/2 watt	1 meg	1%	.33
R103	Fixed	Comp.	1/2 watt	68 K	10%	
R104	Fixed	Comp.	2 watt	680 ohm	10%	
R105	Fixed	WW	5 watt	2 K	5%	
R106	Fixed	Comp.	2 watt	820 ohm	10%	
R107	Var.	Comp.	1/4 watt	500 ohm	10%	
R108	Fixed	Comp.	1/2 watt	150 ohm	10%	
R109	Fixed	Comp.	1/2 watt	1 meg	10%	
R110	Fixed	WW	5 watt	1.5 K	5%	
R111	Fixed	Comp.	2 watt	330 ohm	Selected*	.72
R111.1	Fixed	Comp.	2 watt	330 ohm	Selected*	
R112	Fixed	Comp.	2 watt	330 ohm	Selected*	
R112.1	Fixed	Comp.	2 watt	330 ohm	Selected*	
R113	Fixed	Comp.	1/2 watt	22 K	10%	
R114	Fixed	Comp.	1/2 watt	47 ohm	10%	
R115	Fixed	Comp.	1/2 watt	220 K	10%	
R116	Var.	Comp.	1/4 watt	1 meg	20%	
R117.1	Fixed	Comp.	1/2 watt	1 meg	10%	
R117.2	Fixed	Comp.	1/2 watt	1 meg	10%	
R118	Fixed	Comp.	1/2 watt	1 meg	10%	

R119	Fixed	Comp.	2 watt	2.2 K	10%	
R119.1	Fixed	Comp.	2 watt	2.2 K	10%	
R120	Fixed	Comp.	1/2 watt	470 K	10%	
R120.1	Fixed	Comp.	1/2 watt	10 K	10%	
R120.2	Fixed	Comp.	1/2 watt	10 K	10%	
R120.3	Fixed	Comp.	1/2 watt	56 K	0- +10%	
R121	Fixed	Comp.	2 watt	220 ohm	10%	
R122	Fixed	Comp.	2 watt	220 ohm	10%	
R123	Fixed	Comp.	1/2 watt	470 K	10%	
R123.1	Fixed	Comp.	1/2 watt	100 ohm	10%	
R125	Fixed	WW	5 watt	1.5 K	5%	
R126	Fixed	Comp.	2 watt	330 ohm	Selected*	} .72
R126.1	Fixed	Comp.	2 watt	330 ohm	Selected*	
R127	Fixed	Comp.	2 watt	330 ohm	Selected*	
R127.1	Fixed	Comp.	2 watt	330 ohm	Selected*	
R128	Fixed	Comp.	1/2 watt	47 ohm	10%	
R129	"	"	1/2 watt	10 K	10%	
R130	Fixed	Comp.	1/2 watt	100 K	10%	
R131A,B	Var.	Comp.	1/4 watt	250 K dual	20%	
R132	Fixed	Comp.	1/2 watt	33 K	10%	
R134	Fixed	Prec.	1/2 watt	1.11 meg	1%	.47
R135	Var.	Comp.	1/4 watt	500 K	20%	
R136	Fixed	Comp.	1/2 watt	1.5 meg	10%	
R137	Fixed	Comp.	1/2 watt	1.5 meg	10%	
R138	Fixed	Comp.	1/2 watt	120 K	10%	
R139	Fixed	Comp.	2 watt	4.7 meg	10%	
R140	Var.	Comp.	1/4 watt	2 meg	20%	
R141	Fixed	Comp.	1/2 watt	1.5 meg	10%	
R142	Var.	Comp.	1/4 watt	500 K	20%	
R149	Fixed	WW	25 watt	1 K	5%	
R150	Fixed	Comp.	1/2 watt	470 K	10%	
R151	Fixed	Comp.	1/2 watt	150 K	10%	
R152	Fixed	Comp.	1/2 watt	47 K	10%	
R153	Fixed	Comp.	1 watt	220 K	10%	
R154	Fixed	Comp.	1/2 watt	1 meg	5%	
R155	Fixed	Comp.	1/2 watt	1 meg	5%	
R156	Fixed	Comp.	1/2 watt	470 K	10%	
R157	Fixed	Comp.	1/2 watt	47 K	10%	
R158	Fixed	Comp.	1/2 watt	27 K	10%	
R159	Var.	Comp.	1/4 watt	100 K	20%	
R160	Fixed	Comp.	1/2 watt	470 K	10%	
R161	Fixed	Comp.	1/2 watt	270 K	10%	
R162	Fixed	Comp.	1/2 watt	470 K	10%	
R163	Fixed	WW	20 watt	3.5 K	5%	
R164	Fixed	Comp.	1 watt	470 ohms	10%	
R165	Fixed	Comp.	2 watt	15 K	10%	
R166	Fixed	Comp.	1/2 watt	100 ohm	10%	
R167	Fixed	Comp.	1/2 watt	100 K	10%	
R171	Fixed	Comp.	1 watt	820 K	10%	
R172	Fixed	Comp.	1 watt	820 K	10%	
R173	Fixed	Dep. Carb.	2 watt	50 meg	10%	1.00
<del>R174</del>	<del>Fixed</del>	<del>Comp.</del>	<del>1/2 watt</del>	<del>1 meg</del>	<del>10%</del>	
R175	Fixed	Comp.	1/2 watt	27 K	10%	

\*Selected in groups of four with total series resistance 1200 to 1300 ohms.

### TUBE COMPLEMENT

V1 Trigger Phase Splitter.....6AC7	V17 Video Cathode Follower.....6AG7
V2 Trigger Amplifier .....6AG7	V18 Output Video Amplifier.....6AG7
V3 Trigger Coupling Diode.....6AL5	V19 Output Video Amplifier.....6AG7
V4 Multivibrator .....6AC7	V20 Cathode Ray Tube.....5CP1A
V5 Multivibrator .....6AG7	V21 Sweep Supply Rectifier.....6X4
V6A Unblanking Limiter .....6AL5	V22 Low Voltage Rectifier.....5V4G
V6B Magnified Sweep DC Restorer.....6AL5	V23 Low Voltage Rectifier.....5V4G
V7 Unblanking Cathode Follower.....6C4	V24 Bias Rectifier .....6X4
V8 Gate Output Phase Splitter.....6C4	V25 Sweep Supply Series Regulator.....6AQ5
V9 Sweep Generator .....6AG7	V26 Sweep Supply Regulator Amplifier.....6AU6
V10 Sweep Output Cathode Follower.....6C4	V27 Low Voltage Series Regulator.....6AS7G
V11 Sweep Magnifier .....6J6	V28 Low Voltage Regulator Amplifier.....6AU6
V12 Sweep DC Restorer.....6AL5	V29 Low Voltage Reference.....5651
V13 Sweep Amplifier .....6AU6	V30 Bias Regulator .....OD3/VR150
V14 Sweep Amplifier .....6AU6	V31 High Voltage Oscillator.....6AQ5
V15 Sweep Charging Potential Cathode Follower .....6C4	V32 High Voltage Rectifier.....1B3GT/8016
V16 Input Video Amplifier.....6AG7	V33 High Voltage Rectifier.....1B3GT/8016

### SWITCHES

S1	Trigger Selector	Rotary	1 Section	1 Pole	5 Position	1.02
S2	Sweep Range	Rotary	5 Section	6 Pole	6 Position	
					Front Sections	2.50
					Rear Sections	1.25
S3	Signal Calibrate	Rotary	2 Section	2 Pole	5 Position	1.20
S4	Input Attenuator	Rotary	2 Section	2 Pole	4 Position	1.70
S4	Input Attenuator completely assembled and wired, including S4, C31, C32, C33, C34, C35, C36, C37, C38, R79, R80, R82, R83, R84 and R85					12.50
S5	Input Channel Selector	Rotary	5 Section	5 Pole	4 Position	3.70
S6	Sweep Magnifier	Rotary (on R52)	1 Section	1 Pole	2 Position	see R52
S7	Power	Toggle		1 Pole	Single throw	.42
S9	Vertical Deflection Polarity	Lever		2 Pole	3 Position	.75
S10	Sweep Speed Mult.	Rotary	2 Section	2 Pole	10 Position	1.40
S10	Sweep Speed Mult. completely assembled and wired, including R20C 1 to 9 and R20D 1 to 9					6.50

### TRANSFORMERS

T1	T2
Primary: 117 or 235 volt, 50/60 cycle	Primary: 170 V., tapped at 25 V., approx. 2 KC.
Second-aries: 280-0-280 V., 250 ma. 260-0-260 V., 30 ma. insulated for 700 VDC. 5 V., 4 A., insulated for 500 VDC. 6.3 V., .6 A., insulated for 500 VDC. 6.3 V., .6 A., insulated for 650 VDC. 6.3 V., .6 A., insulated for 350 V., R. M. S. 6.3 V., .3 A., insulated for 250 VDC. 6.3 V., .6 A., insulated for 1500 VDC. 6.3 V., 11 A., ground. 35.4 V., R. M. S., ground.	Second-aries: 1250 V., at 1 ma. 1.4 V., .2 A., connected to 1250 V. winding. 1.4 V., .2 A., insulated for 1500 VDC.
\$30.50	\$10.50



## MISCELLANEOUS

Binding Post Adapter.....	\$1.88
Binding Post, bakelite.....	.33
Binding Post, ground.....	.34
Filter, colored plastic.....	.90
Fuse, 4AG, 3 amp., slow blowing.....	.15
Graticule, clear plastic.....	1.50
Graticule, cover.....	.50
Knob, 5/8".....	.10
Knob, 1 1/2 skirted.....	.39
Nut graticule.....	.05
Power Cord.....	1.50
Probe Assembly.....	9.25
Side Access Panel Jumper banana plugs.....	.40
Sweep Speed Dial, Vernier, hand calibrated and furnished only with R-20C and R-20D.....	7.50
Sweep Speed Dial, for rotary switch S10.....	2.45

Replacement parts ordered after termination of warranty will be billed in accordance with the above net prices and shipped via air prepaid to any point within the continental United States or Canada.

All price revision and design modification privileges reserved.

Parts not priced are generally available through electronics parts distributors.



### WARRANTY

This instrument is guaranteed to the original user to be free from defects in material and workmanship for a period of one year from date of purchase. Our responsibility under this warranty is limited to the repair or replacement of the instrument, or any part thereof, failure of which is not due to abuse.

For service under this warranty, promptly advise the factory of all details pertinent to the failure. Replacement parts will be shipped, via air transportation upon request, prepaid to any point within the continental United States or Canada. Should it be more convenient to ship the entire instrument, transportation prepaid, to the factory, it will be serviced as required, at no charge and returned via surface transportation.

### IMPORTANT

When writing the factory regarding any Tektronix instrument, be sure to MENTION SERIAL NUMBER.

**SER. 1989**



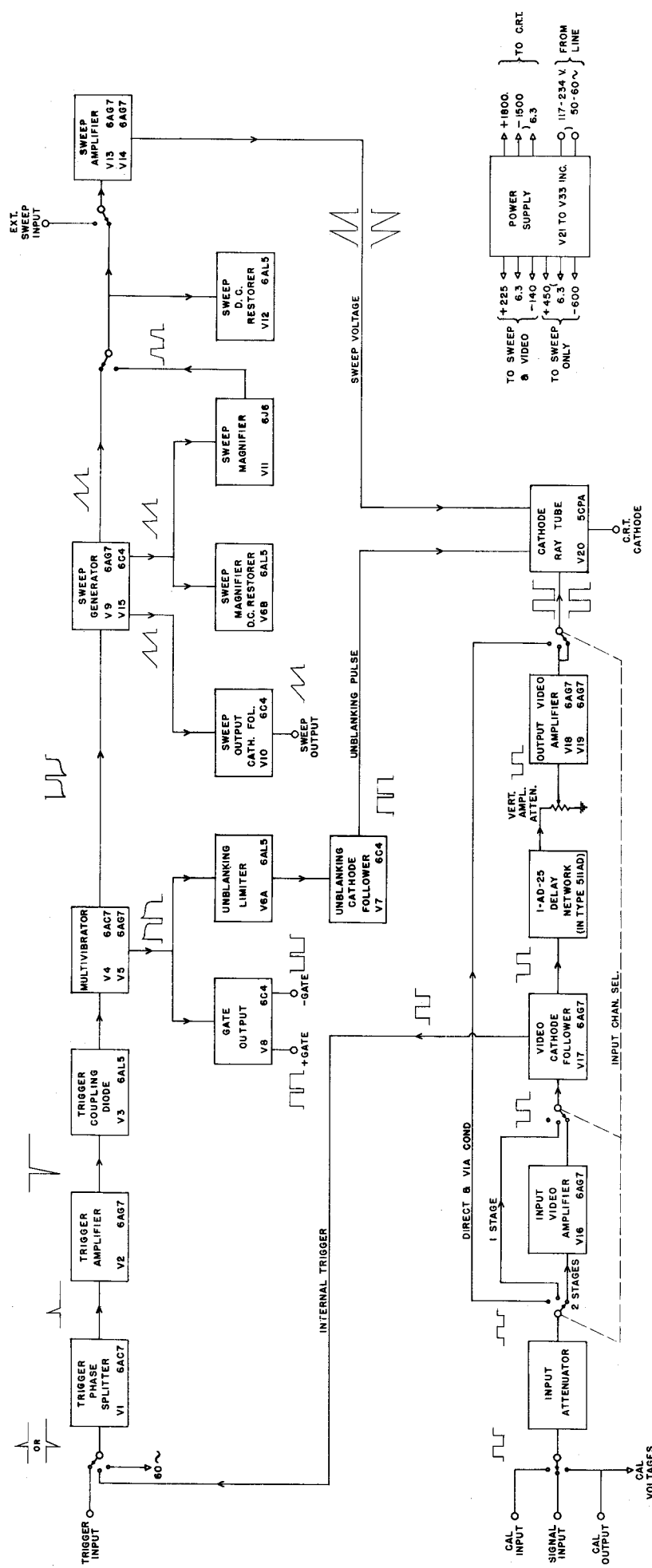

BLOCK DIAGRAM OF TYPE 511A CATHODE RAY OSCILLOSCOPE





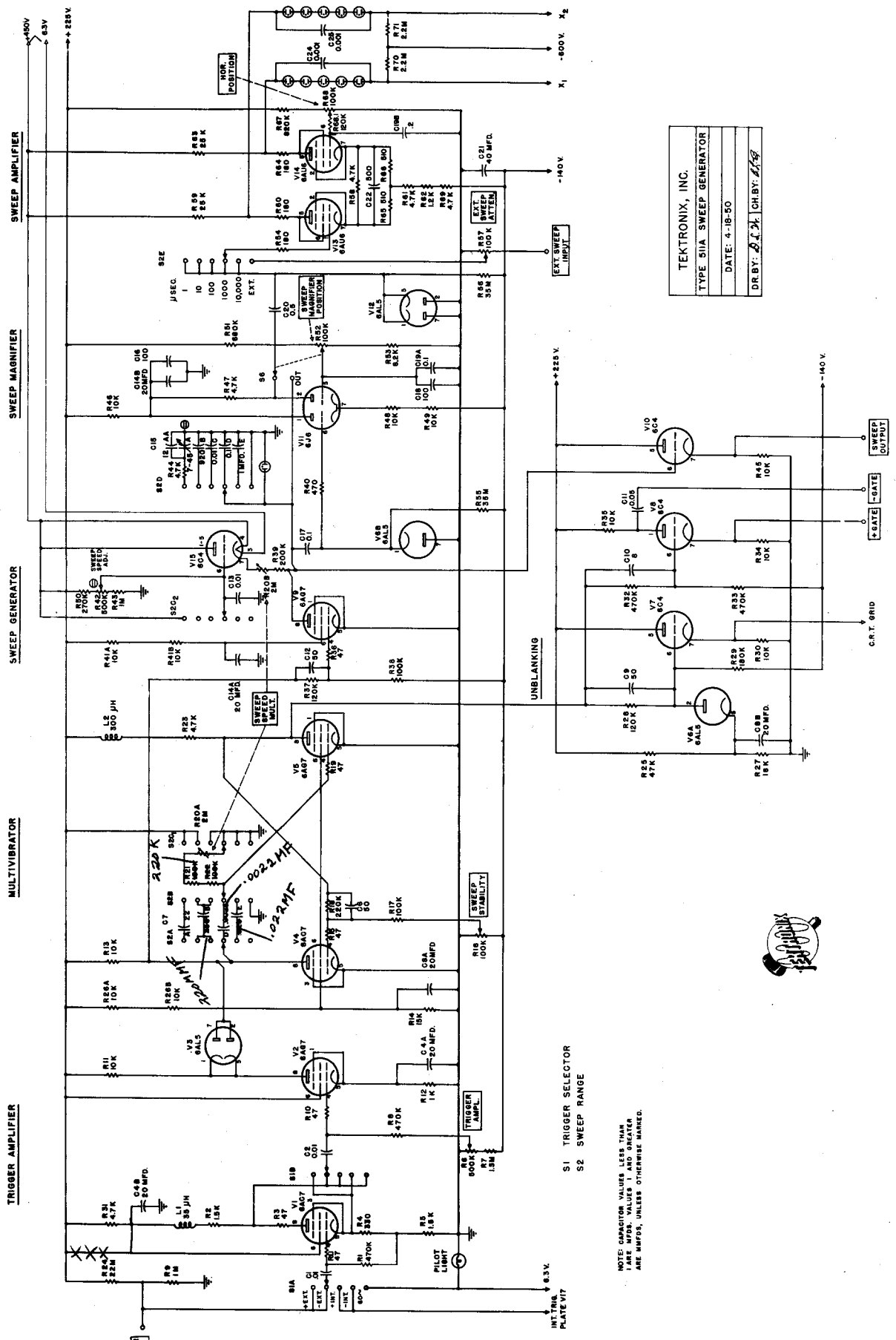

TEKTRONIX, INC.  
 TYPE 51A SWEEP GENERATOR  
 DATE: 4-18-50  
 DR BY: *D. J. K.* CH BY: *D. J. K.*



NOTE: CAPACITOR VALUES LESS THAN 1 ARE MICRO FARADS, 1 AND OVER ARE MMFD, UNLESS OTHERWISE MARKED.



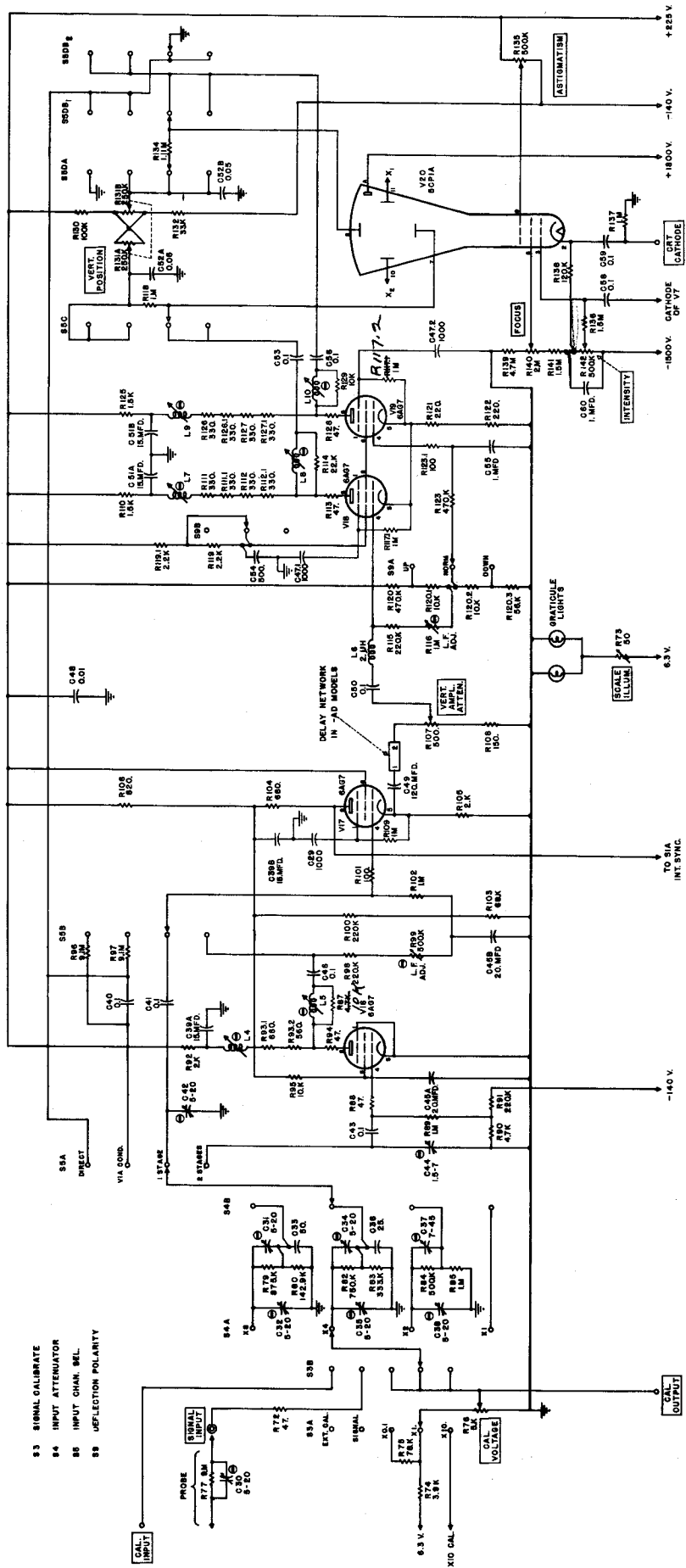

- 83 SIGNAL CALIBRATE
- 84 INPUT ATTENUATOR
- 85 INPUT CHAN. SEL.
- 86 DEFLECTION POLARITY

TEKTRONIX, INC.  
 TYPE 511A VERTICAL AMPLIFIER  
 AND CRT CIRCUITS  
 DATE: 4-18-70  
 DR BY: P.L.S. CH. BY: M.C.B.



AVERAGE SUPPLY CURRENT AT  
 CHASSIS TERMINAL BLOCK  
 -140 V. SUPPLY 0.35 MA.  
 +225 V. SUPPLY 128 MA.

CAPACITOR VALUES LESS THAN 1 ARE MFD.  
 VALUES 1 AND GREATER ARE MMFD, UNLESS  
 OTHERWISE MARKED.





AVERAGE CURRENT AT  
TERMINAL BLOCK:

+225 V. SUPPLY 190 MA.  
-140 V. SUPPLY 14 MA.

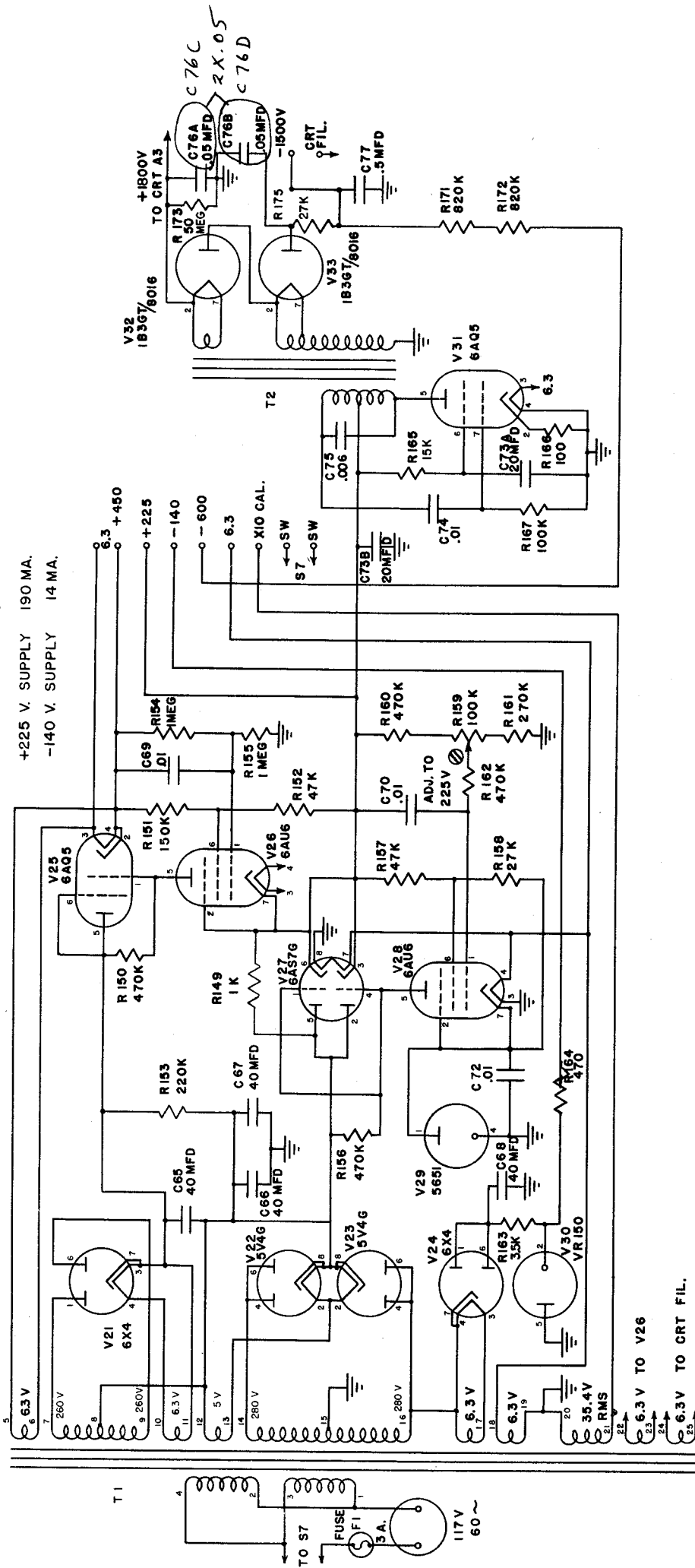

<b>TEKTRONIX, INC.</b>	
POWER SUPPLY - TYPE 511A	
CATHODE RAY OSCILLOSCOPE	
DATE: 4-18-50	
DR. BY:	CH. BY: <i>C.A. Z.</i>



## SECTION VII

### TEKTRONIX TYPE 1-AD-25 AND TYPE 1-D-25\* DELAY NETWORK

#### GENERAL DESCRIPTION

The Type 1-AD-25 Video Delay Network is designed for use in the video amplifier of the Tektronix Type 511-A Oscilloscope. It provides a signal delay of .25 microsecond, thus permitting the CRT to be unblanked and the sweep to be operating linearly, before the initiating signal reaches the vertical deflection plates. By this method, random pulses may be observed.

The Type 511-AD Oscilloscope includes a factory installed Type 1-AD-25 Delay Network.

The Type 1-AD-25 consists of 23 M-derived sections. By using  $M=1.27$ , very uniform time delay is obtained for frequencies well above the cut-off of the Type 511-A output amplifier. To obtain smooth impedance matching between sections of the network, trimming capacitors are provided. These are adjusted at the factory and should not require resetting in the field.

The output termination consists of the Vert. Ampl. Atten. potentiometer, shunted by R2 to match the characteristic impedance of the network. To make this termination less critical, the network is partially matched at the input by the 270 ohm resistor R1 in series with the internal impedance of the cathode follower V17. This

input matching produces an insertion loss of 3 db., but is necessary since the impedance of the output termination varies slightly with the setting of the Vert. Ampl. Atten. potentiometer.

When the delay network is not needed, it may be removed from the circuit by means of a rotary switch operated from the front panel.

#### ADJUSTMENT AND MAINTENANCE

If the Vert. Ampl. Atten. potentiometer R107 or the limiting resistor R108 are replaced, it may be necessary to change the delay network shunt resistance so that the correct termination is maintained. To check for proper termination, set the sweep speed at 3 to 10 microseconds and observe the response to a clean, sharp, square wave or pulse having a rise time of .03 microseconds or less. The Tektronix Type 104 Square Wave Generator operating at 100 kc. provides such a signal.

If the termination is incorrect, the first .5 microsecond of the pulse will be lower or higher in amplitude than the rest of the flat portion. If the first part is higher, shunt the high side of R107 to ground with a resistor of such value that a level top on the square wave or pulse is obtained.

In case the first portion is lower, it will be necessary to increase the value of the shunt resistor. Remove the delay network cover and install a ½ watt resistor of suitable value (1,000 to 10,000 ohms), in series with R2.

**CAUTION! Do not disturb the adjustment of the variable capacitors.**

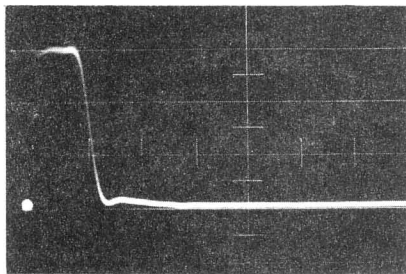

Fig. 55. 0.2 microsecond pulse with the delay network switched out. Note absence of leading edge.

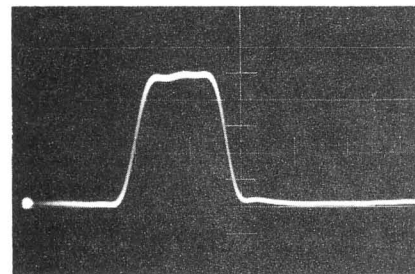

Fig. 56. The same 0.2 microsecond pulse with the Type 1-AD-25 delay network switched in, delaying the appearance of the pulse until the CRT is unblanked and the sweep operating linearly.

\*The Type 1-D-25 Video Delay Network designed for use in the Type 511 Oscilloscope is the same as the Type 1-AD-25 except that switch S1 is replaced by relay RL1.

## Tektronix Type 1-AD-25 Delay Network — Parts List

### CONDENSERS

C1 $\alpha$ to C23 $\alpha$	Fixed	Ceramic	12 mmf	$\pm 10\%$	500 WVDC
C1 to C4	Variable	Ceramic	3-12 mmf	$\pm 10\%$	500 WVDC
C5 to C23	Variable	Ceramic	1.5-7 mmf	$\pm 10\%$	500 WVDC

### INDUCTORS

L1 to L23	Fixed
L24	Variable

### RESISTORS

R1	Fixed	Composition	$\frac{1}{2}$ watt	270 ohm	$\pm 10\%$
R2	Fixed	Composition	$\frac{1}{2}$ watt	Selected	

### SWITCH

S1 (1-AD-25)	in-out	DPDT	Rotary
--------------	--------	------	--------

### RELAY

RL1 (1-D-25)	Type 227A	DPDT	32VDC	1000 ohm
--------------	-----------	------	-------	----------

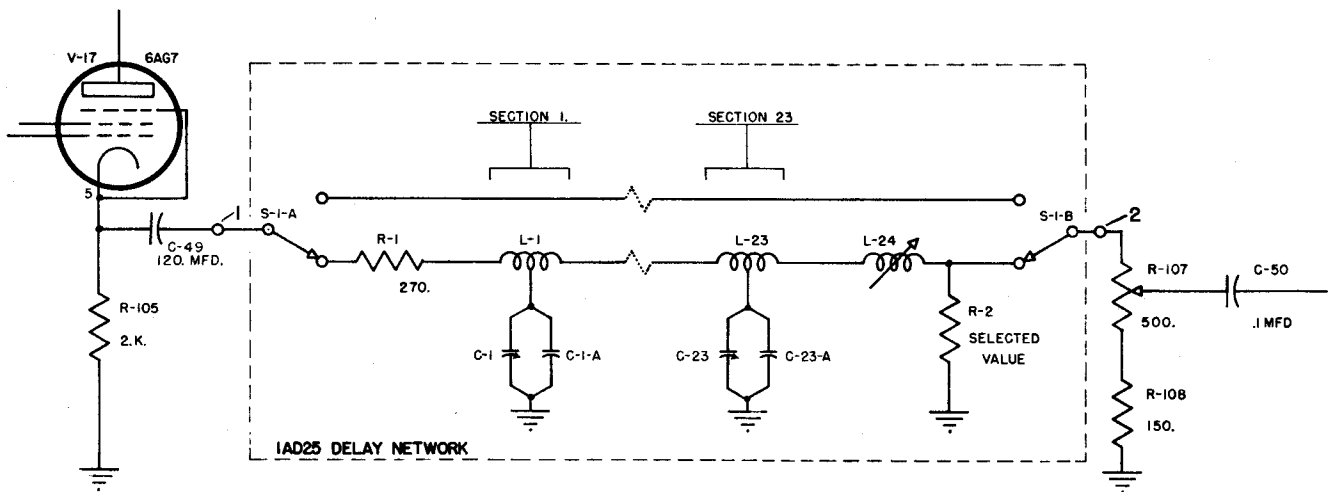

NOTE: L-1 TO L-12 INCLUSIVE ARE COAXIALLY WOUND ON THE SAME COIL FORM.  
 L-13 TO L-23 " " " " " " " " " " " " " " " "

# CALIBRATOR MODIFICATION

The three-range sine wave amplitude calibrator, formerly employed in the Type 511-A-AD oscilloscope, has been replaced with a six-range square wave calibrator. This improved circuit provides calibration accurate to within  $\pm 2\%$  of full scale.

The calibrator waveform is derived from the line frequency voltage of a T1 secondary winding. The positive peak is clipped or limited by means of the diode connected section of a 12AT7, V16.1. The point of limiting is determined by the setting of the CAL. ADJ. potentiometer R75.4. Since the voltage on R75.4 is obtained from the +225 volt regulated supply, the limiting point is not affected by line voltage variations over the operating range of 105 to 125 volts. This limited waveform is applied to the cathode follower section of V16.1, which clips the negative peak and provides a low impedance output.

The SIGNAL-CALIBRATE switch, S3, permits selection of the SIGNAL INPUT, CAL. INPUT (which may be used as an alternate signal input), or any of six calibrating ranges from .3V to 100V peak to peak. Continuously variable control for each range is provided by means of the CAL. VOLTAGE potentiometer, R76.1.

Refer to Section II, "Calibration", for operating instructions which still pertain, except that the calibration ranges now represent full scale readings of the CAL. VOLTAGE control.

Do not attempt to check the calibrator accuracy with an AC voltmeter. If inaccuracy is suspected, the output should be measured by the comparison method. With the INPUT CHAN. SEL. in the DIRECT position, connect a 90 volt B battery to the SIGNAL INPUT, and note the deflection of the CRT trace. Measure the battery voltage with an accurate 100V scale DC voltmeter. Now set the SIGNAL-CALIBRATE switch at 100V and the CAL. VOLTAGE at the voltmeter reading and again observe the trace deflection. If necessary, adjust R75.4 until equal deflection is obtained.

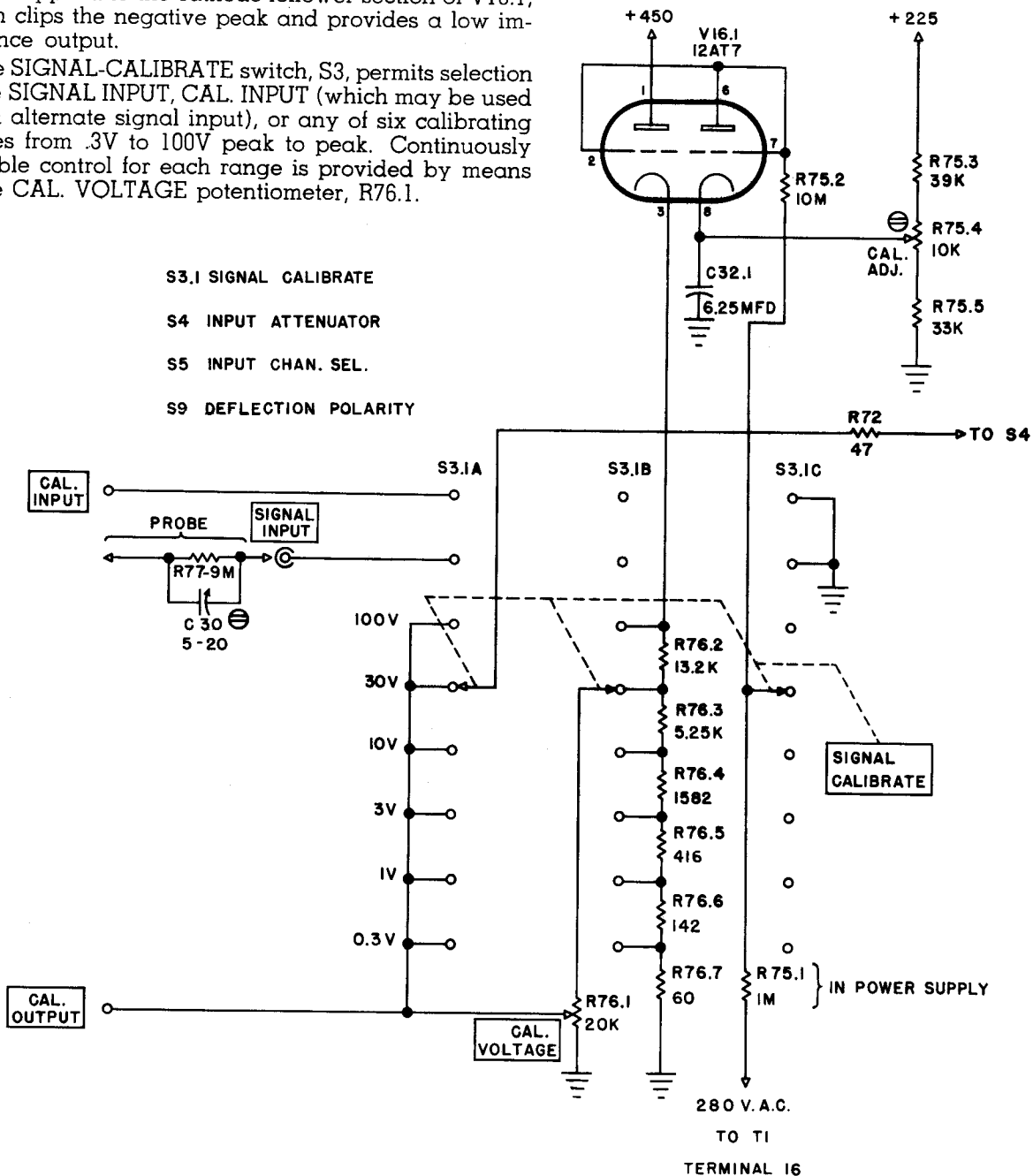

AVERAGE CURRENT AT  
TERMINAL BLOCK:

+225 V. SUPPLY 190 MA.  
-140 V. SUPPLY 14 MA.

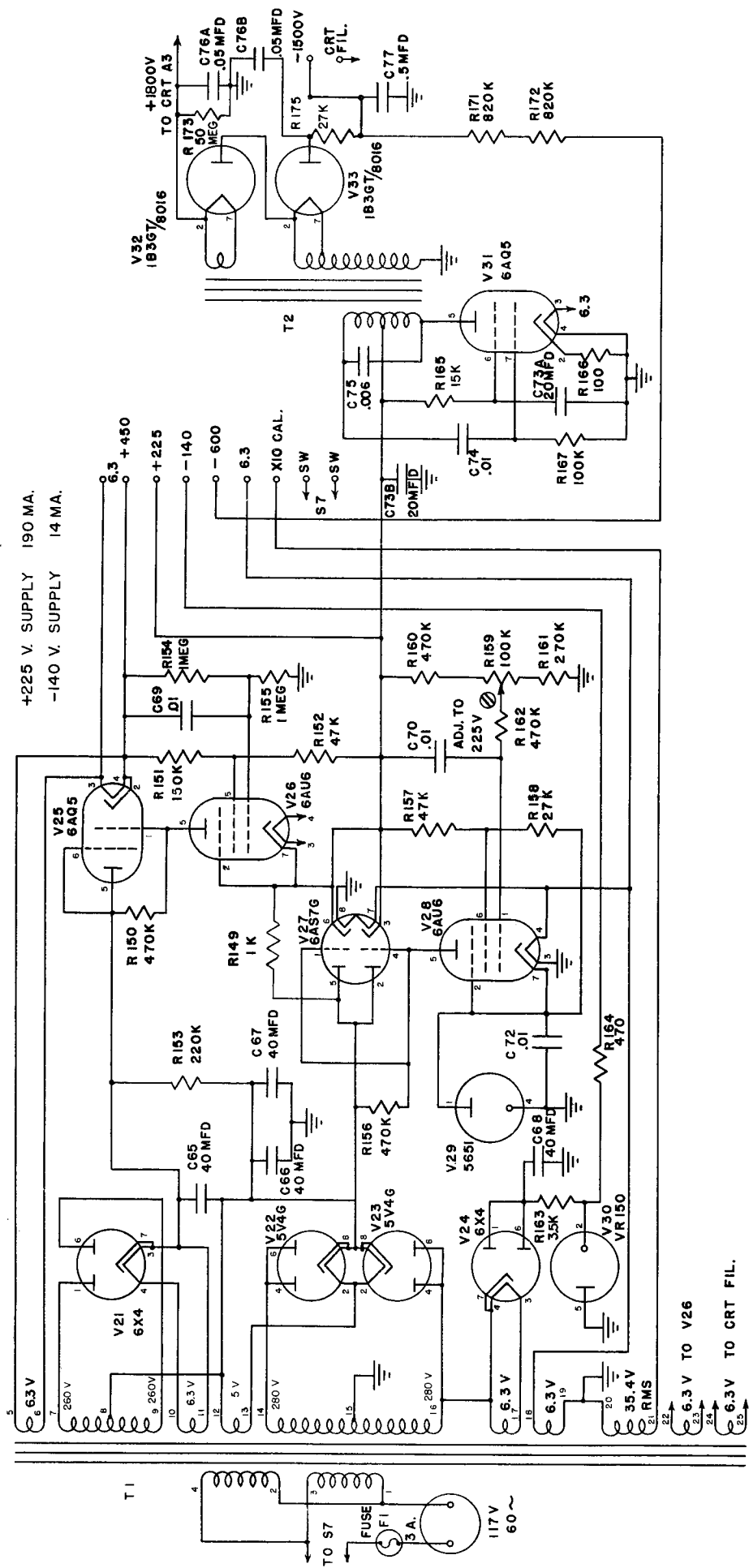

<b>TEKTRONIX, INC.</b>	
POWER SUPPLY --TYPE 511A	CATHODE RAY OSCILLOSCOPE
DATE: 4-18-50	DR. BY: <i>C.H.B.</i>











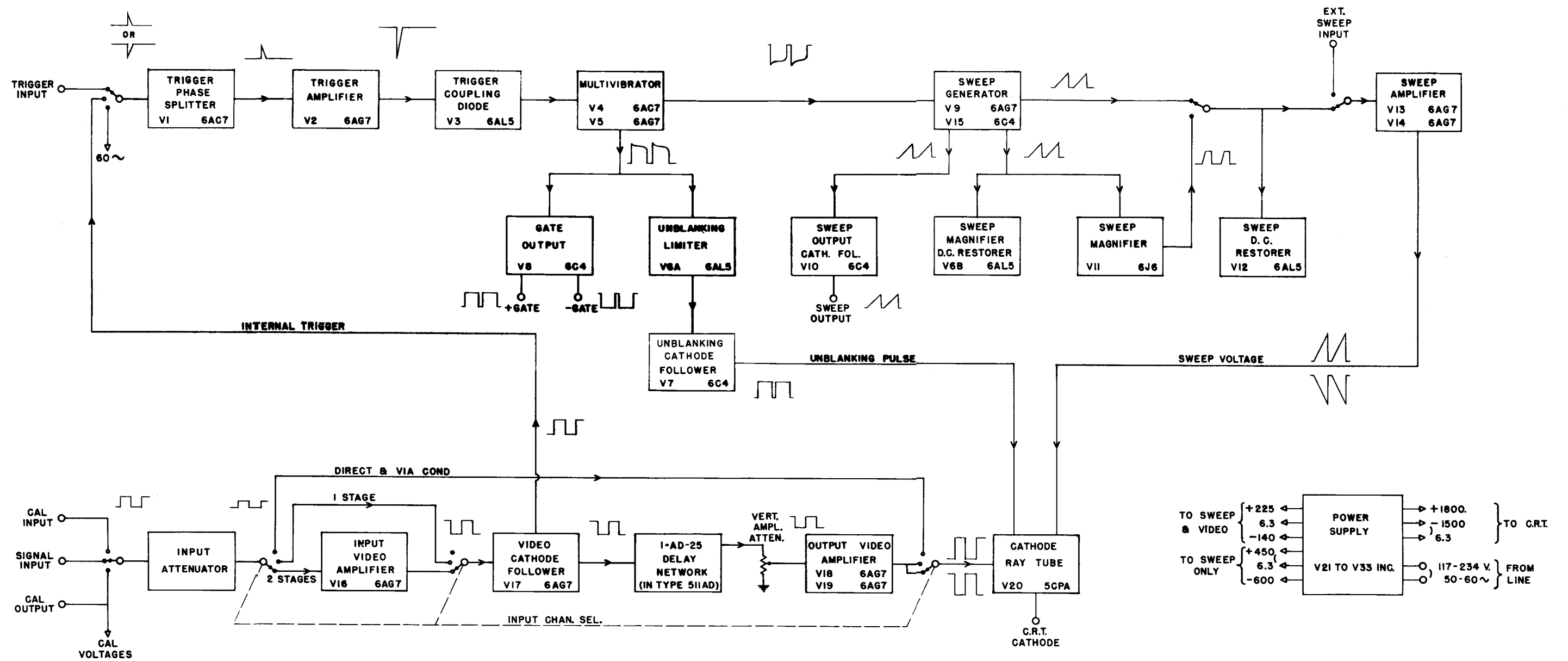

BLOCK DIAGRAM OF TYPE 511A CATHODE RAY OSCILLOSCOPE



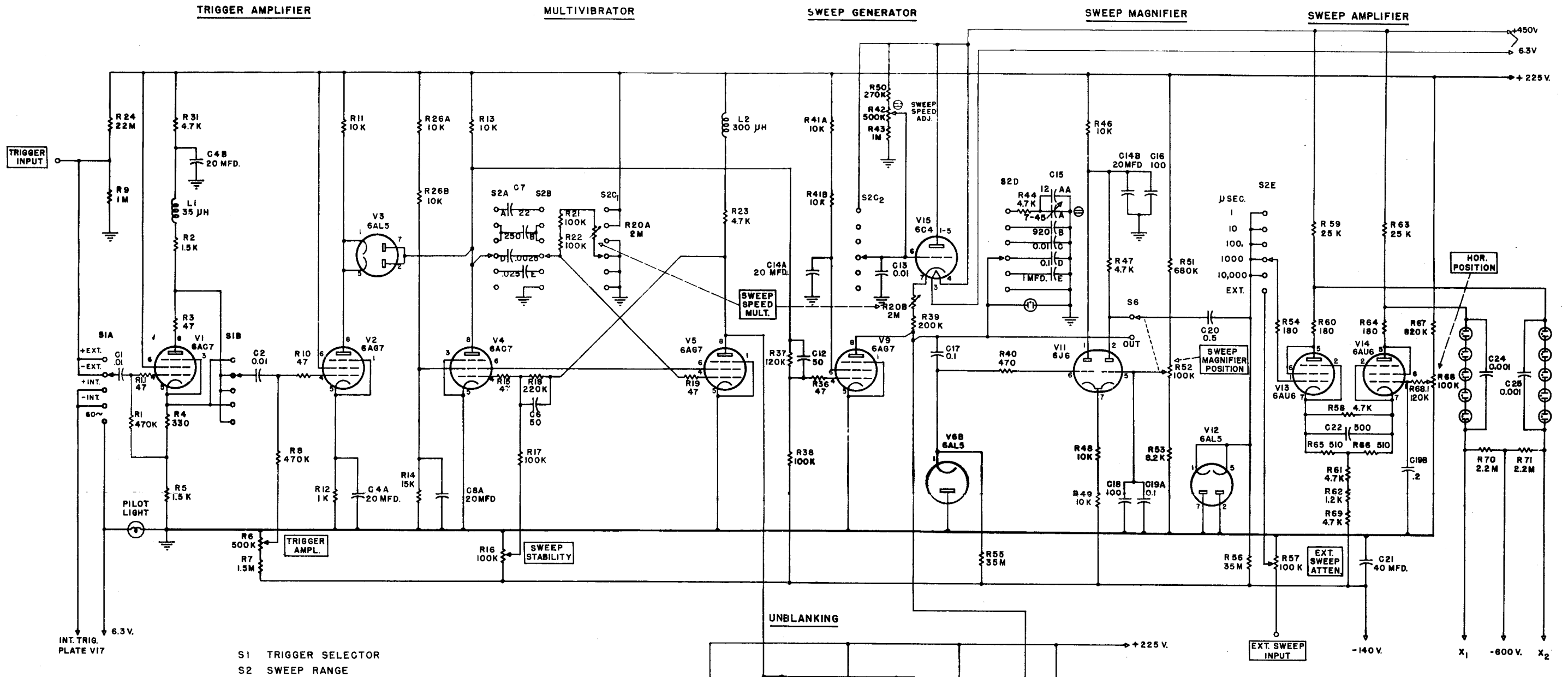

S1 TRIGGER SELECTOR  
S2 SWEEP RANGE

NOTE: CAPACITOR VALUES LESS THAN 1 ARE MFDS. VALUES 1 AND GREATER ARE MMFDS, UNLESS OTHERWISE MARKED.

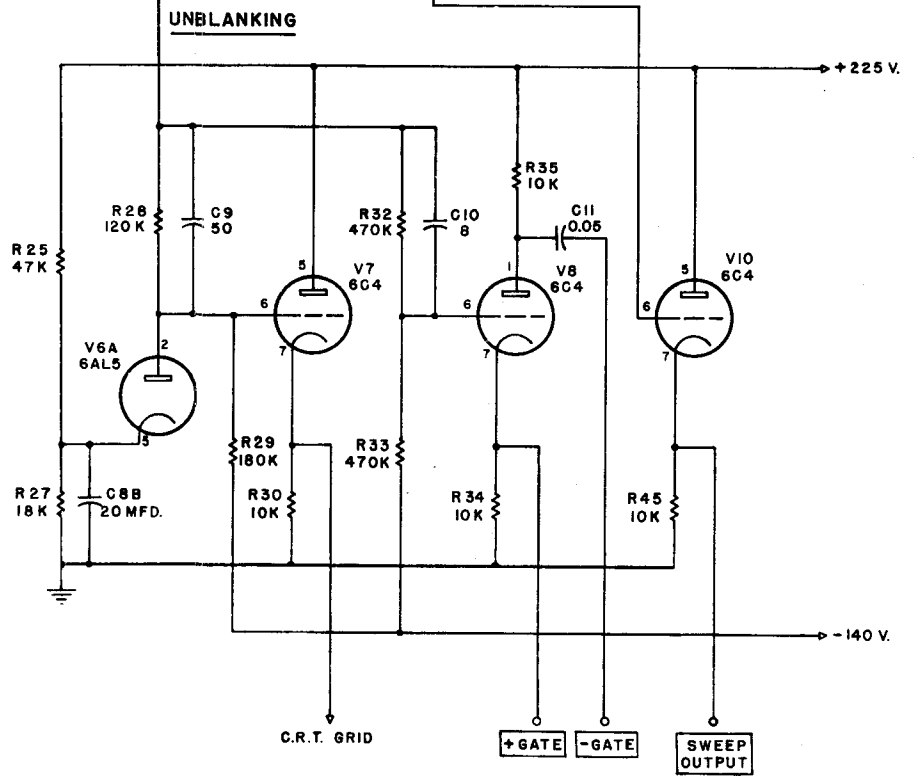

**TEKTRONIX, INC.**

TYPE 511A SWEEP GENERATOR

DATE: 4-18-50

DR. BY: *D.L.H.* CH. BY: *L.H.B.*

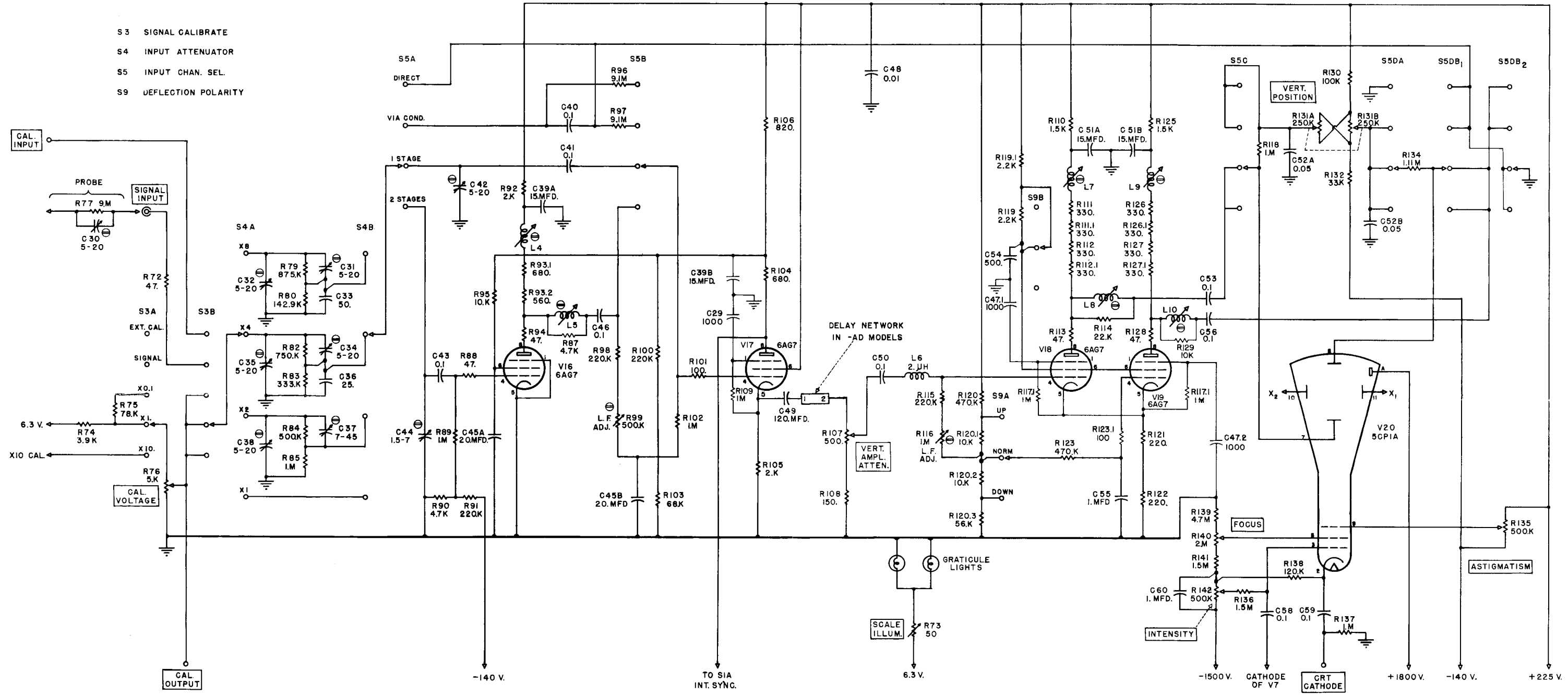

- S3 SIGNAL CALIBRATE
- S4 INPUT ATTENUATOR
- S5 INPUT CHAN. SEL.
- S9 DEFLECTION POLARITY

CAPACITOR VALUES LESS THAN 1 ARE MFDS.  
 VALUES 1 AND GREATER ARE MMFDS, UNLESS  
 OTHERWISE MARKED.

AVERAGE SUPPLY CURRENT AT  
 CHASSIS TERMINAL BLOCK.  
 -140 V. SUPPLY 0.3 MA.  
 +225 V. SUPPLY 128 MA.



<b>TEKTRONIX, INC.</b>	
TYPE 511A VERTICAL AMPLIFIER AND CRT CIRCUITS	
DATE: 4-18-50	
DR. BY: <i>D.L.H.</i>	CH. BY: <i>A.R.</i>