

Labor 25.2.70

INSTRUCTION MANUAL

Serial Number _____

7A11 AMPLIFIER

Tektronix, Inc.

S.W. Millikan Way • P. O. Box 500 • Beaverton, Oregon 97005 • Phone 644-0161 • Cables: Tektronix
070-0984-00

1269



WARRANTY

All Tektronix instruments are warranted against defective materials and workmanship for one year. Tektronix transformers, manufactured in our plant, are warranted for the life of the instrument.

Any questions with respect to the warranty mentioned above should be taken up with your Tektronix Field Engineer.

Tektronix repair and replacement-part service is geared directly to the field, therefore all requests for repairs and replacement parts should be directed to the Tektronix Field Office or representative in your area. This procedure will assure you the fastest possible service. Please include the instrument Type and Serial or Model Number with all requests for parts or service.

Specifications and price change privileges reserved.

Copyright © 1969 by Tektronix, Inc., Beaverton, Oregon. Printed in the United States of America. All rights reserved. Contents of this publication may not be reproduced in any form without permission of the copyright owner.

TABLE OF CONTENTS

SECTION 1	SPECIFICATION	
	Introduction	1-1
	Electrical	
	Deflection Factor	1-1
	Gain	1-1
	Frequency Response	1-1
	Maximum Input Voltage	1-2
	Input R and C	1-2
	Maximum Gate Current	1-2
	Noise	1-2
	DC Drift	1-2
	Drift With Ambient Temperature	1-2
	Trace IDENTIFY	1-2
	OFFSET Range	1-2
	OFFSET OUT	1-2
	50 Ω Termination/Adapter	1-3
	Environmental	
	Temperature	1-3
	Altitude	1-3
	Humidity	1-3
	Transportation	1-4
	Physical	
	Finish	1-4
	Dimension	1-4
	Weight	1-4
	Graphs	1-5
SECTION 2	OPERATING INSTRUCTIONS	
	General	2-1
	Plug-In Insertion/Removal	2-1
	Probe Removal/Storage	2-1
	External Controls and Connectors	2-1
	Accessories Information	2-5
	First Time Operation	
	STEP ATTEN BAL Adjustment	2-5
	IDENTIFY	2-6
	BANDWIDTH	2-6
	GAIN	2-6
	POLARITY	2-6
	OFFSET	2-6
	Probe Operation	2-7
	Arbitrary Deflection Factors	2-7
	Input Capacitance	2-8

TABLE OF CONTENTS (cont)

SECTION 3	CIRCUIT DESCRIPTION	
	Block Diagram Description	3-1
	Probe Circuit Description	3-2
	Input Amplifier	3-3
	Output Amplifier	3-4
	Offset Generator	3-5
	Volts/Div Switch and Readout	3-6
	Power Supplies and Output Connectors	3-7
SECTION 4	MAINTENANCE	
	Preventive Maintenance	
	General Information	4-1
	Cleaning	4-1
	Visual Inspection	4-1
	Lubrication	4-1
	Transistor and Integrated Circuit Checks	4-1
	Recalibration	4-1
	Troubleshooting	
	Test Equipment	4-1
	General Techniques	4-2
	Troubleshooting Basic Components	4-2
	Troubleshooting Chart	4-4
	Corrective Maintenance	
	Parts Procurement	4-5
	Screwdriver Requirements	4-8
	Soldering Equipment and Techniques	4-8
	Probe Data	4-9
	Plug-In Unit Data	4-10
	Circuit Board Illustrations	4-12
SECTION 5	PERFORMANCE CHECK/CALIBRATION	
	General	5-1
	Calibration Procedure Instructions	5-1
	Performance Check Instructions	5-1
	Calibration Index and Record Instructions	5-1
	Equipment Required	5-1
	Detailed Procedure	5-6
SECTION 6	ELECTRICAL PARTS LIST	
	Abbreviations and Symbols	
	Parts Ordering Information	

TABLE OF CONTENTS (cont)

SECTION 7	DIAGRAMS
	Electrical
	Mechanical Parts List Illustrations
	Accessories

SECTION 8	MECHANICAL PARTS LIST
	Mechanical Parts List Information

CHANGE INFORMATION

Abbreviations and symbols used in this manual are based on or taken directly from IEEE Standard 260 "Standard Symbols for Units", MIL-STD-12B and other standards of the electronics industry. Change information, if any, is located at the rear of this manual.

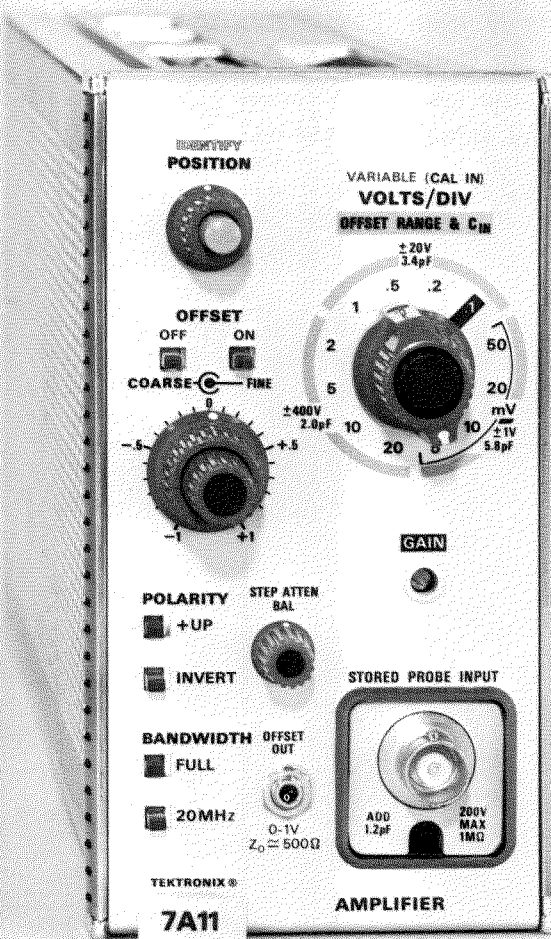
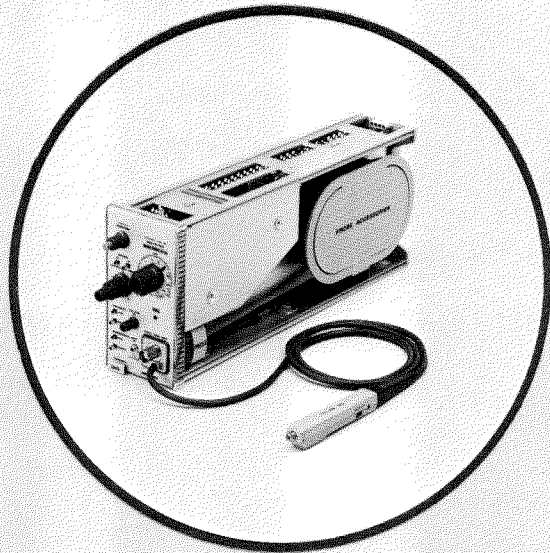

Fig. 1-1. 7A11 Amplifier.

SECTION 1

SPECIFICATION

Change information, if any, affecting this section will be found at the rear of the manual.

Introduction

The 7A11 Amplifier is a versatile plug-in amplifier unit which provides a DC to 150 MHz bandwidth with Tektronix 7700-Series Oscilloscopes. When desired, the upper frequency -3 dB point can be limited to 20 MHz by a front-panel switch.

Calibrated deflection factors of from 5 mV to 20 V per division are provided in 1-2-5 sequence. In addition, a variable gain control makes it possible to set the amplifier to any deflection factor between 5 mV and 50 V per division.

A permanently attached probe provides low-input capacitance (2.0 pF at 2 V/division, 5.8 pF at 5 mV/division) while maintaining high input resistance (1 M Ω). BNC-connectors can be attached to the probe through a probe-tip to BNC-female adapter. This adapter serves as the probe's input connector when the probe is stored, but can be attached to the probe tip whether or not the probe is stored in the plug-in unit.

A 50 Ω termination/adaptor (standard accessory) permits impedance matching for use of the probe in 50 Ω environments. When the termination/adaptor is used, a low standing wave ratio (VSWR) can be expected. The VSWR can be further reduced by inserting a 2X attenuator in the signal path ahead of the 50 Ω termination/adaptor. Approximate values of VSWR which can be expected under both conditions are shown in Fig. 1-4.

The performance specification of the 7A11 Amplifier is described in detail in Table 1-1. The specification is valid under the following conditions:

Calibration must have been performed at an ambient temperature between $+20^{\circ}\text{C}$ and $+30^{\circ}\text{C}$.

Operation must be within any specified environment, in a calibrated Oscilloscope, after twenty minutes of warmup.

TABLE 1-1
7A11 Amplifier Specification

Characteristic	Performance Requirement
ELECTRICAL	
Deflection Factor (VOLTS/DIV)	
Calibrated Range	5 mV/div to 20 V/div; 12 steps in 5, 10, 20 sequence
Gain Ratio Accuracy	Within 2% of GAIN adjusted at 0.1 V/div
Uncalibrated	Continuously variable; extends deflection factor to at least 50 V/div
GAIN	Permits adjustment of deflection factor at 0.1 V/div for all Oscilloscopes
Frequency Response (8 Division Reference)	
Bandwidth, Direct Coupled Input	
FULL Mode	DC to 150 MHz with 7700-Series Oscilloscope
	DC to 90 MHz with 7500-Series Oscilloscope
20 MHz Mode	DC to 20 MHz within 2 MHz
Capacitive Coupled Lower Frequency -3 dB Limit	15 Hz or less
Risetime	2.4 ns or less with 7700-Series Oscilloscope
	3.9 ns or less with 7500-Series Oscilloscope

TABLE 1-1 (cont)

Characteristic	Performance Requirement
Maximum Input Voltage With or Without AC Coupler Installed	
DC + Peak AC	200 V; AC component not to exceed amplitude specified under AC
AC, continuous wave	
5 mV thru 50 mV	200 V peak to 50 kHz; see Fig. 1-2 for amplitude derating due to frequencies above 50 kHz
0.1 V thru 1 V	200 V peak to 40 MHz; see Fig. 1-2 for amplitude derating due to frequencies above 40 MHz
2 V thru 20 V	200 V peak to 70 MHz; see Fig. 1-2 for amplitude derating due to frequencies above 70 MHz
DC, Capacitive Coupled (AC Coupler Installed)	200 V
Input R and C	
Resistance	1 MΩ within 1%
Capacitance	
5 mV/div thru 50 mV/div	5.8 pF within 0.6 pF
0.1 V/div thru 1 V/div	3.4 pF within 0.4 pF
2 V/div thru 20 V/div	2.0 pF within 0.2 pF
Maximum Gate Current	0.25 nA or less at 25°C, increasing to 1.2 nA or less at 50°C
Noise (Tangentially measured in FULL Mode)	0.1 division (maximum), measured in 7000-Series Oscilloscope

TABLE 1-1 (cont)

Characteristic	Performance Requirement
DC Drift	
Drift With Time (Ambient Temperature and Line Voltage Constant)	
Short Term	0.1 division or less during any 1 minute interval within 1 hour after 20 minutes from turn-on
Long Term	0.3 division or less during any hour after 20 minutes from turn-on
Drift With Ambient Temperature change (Line Voltage Constant)	
Plug-In Only	200 μV/°C or less
Probe Only	200 μV/°C or less
Trace IDENTIFY	0.2 to 0.3 division upward trace shift
OFFSET Range	
5 mV/div thru 50 mV/div	+1 V to -1 V
0.1 V/div thru 1 V/div	+20 V to -20 V
2 V/div thru 20 V/div	+400 V to -400 V
OFFSET OUT	
Range	+1 V to -1 V (nominal)
Ratio of Offset Range to OFFSET OUT	
5 mV/div thru 50 mV/div	1:1 within 1% plus 0.5 mV at OFFSET OUT jack
0.1 V/div thru 1 V/div	20:1 within 1.5% plus 0.5 mV at OFFSET OUT jack
2 V/div thru 20 V/div	400:1 within 2% plus 0.5 mV at OFFSET OUT jack
Source Resistance	500 Ω within 3%

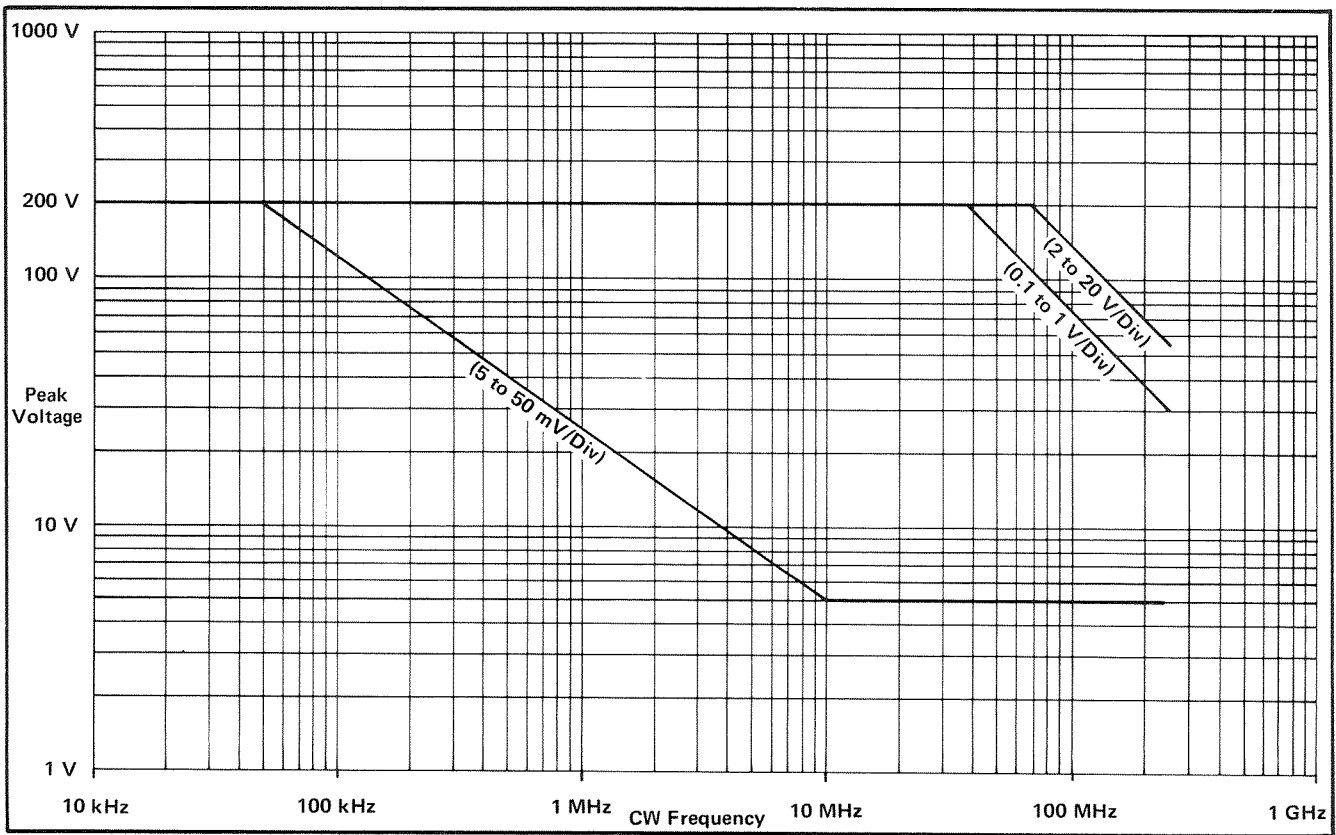

Fig. 1-2. Frequency versus maximum input amplitude derating graph.

TABLE 1-1 (cont)

Characteristic	Performance Requirement
50 Ω Termination/ Adapter	
Input Impedance	50 Ω within 1%
Power Rating	1 Watt
ENVIRONMENTAL	
Probe	
Temperature	
Non-operating	-55°C to +75°C
Operating	0°C to +65°C
Altitude	
Non-operating	To 50,000 feet
Operating	To 15,000 feet
Vibration	15 minutes along each axis at 0.025 inch P-P displacement (3.9 g's at 55 c/s) 10 to 55 to 10 c/s in

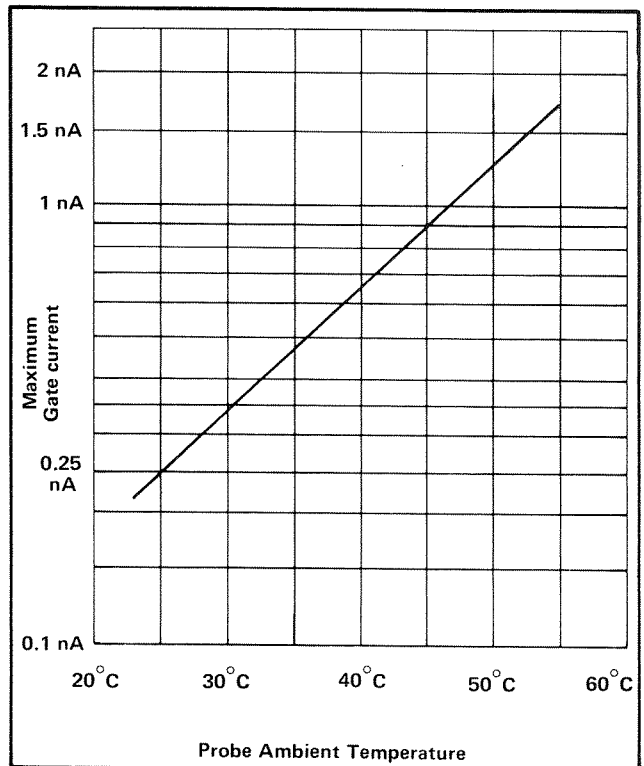

Fig. 1-3. 7A11 maximum gate current versus Probe ambient temperature in "non-stored" mode. To determine maximum gate current with Probe stored, add +11°C to Probe ambient temperature.

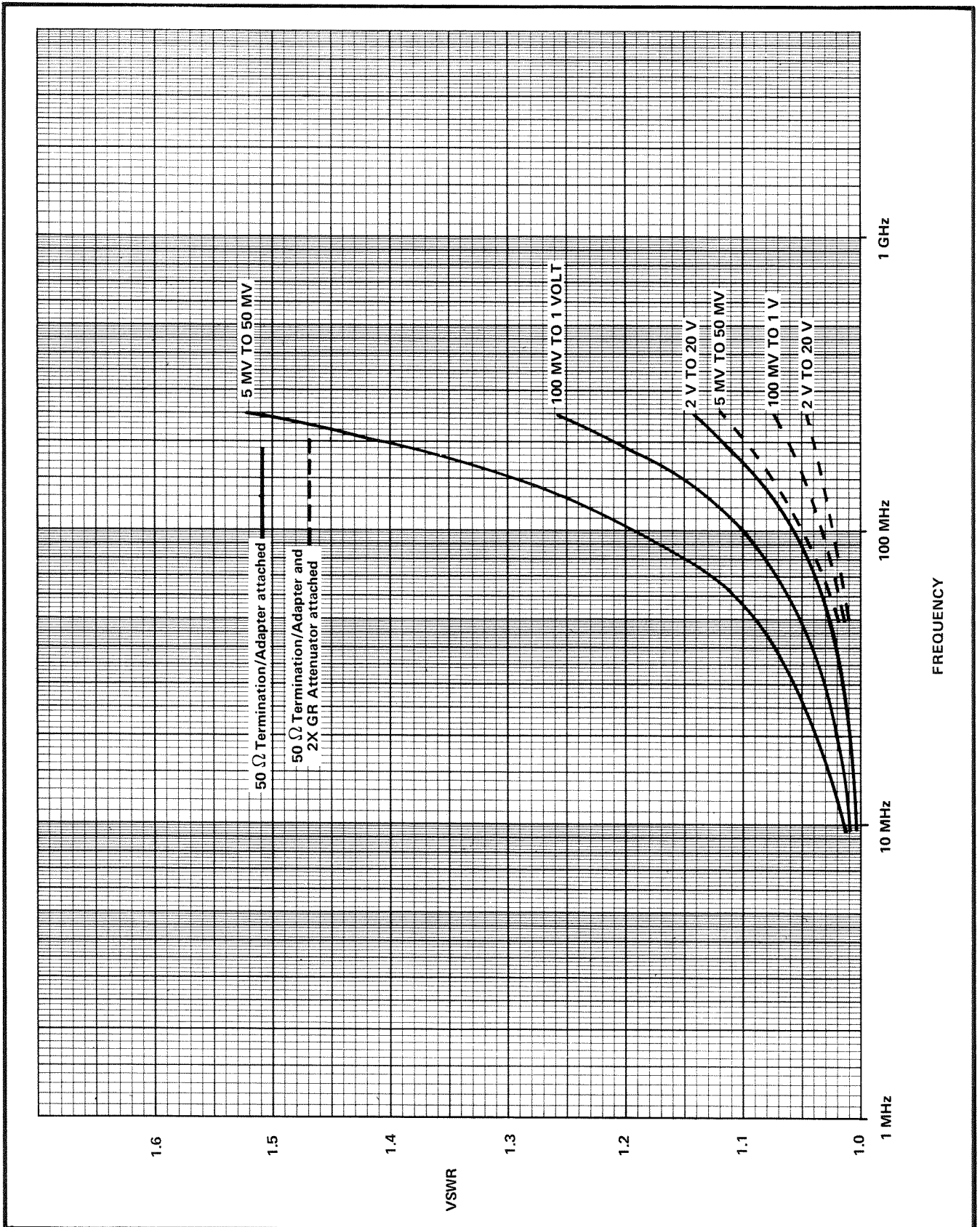

Fig. 1-4. Standing wave ratio graph showing approximate VSWR which can be expected when the 7A11 Probe is used with the 50 Ω Termination/Adapter attached.

TABLE 1-1 (cont)

Characteristic	Performance Requirement
	1-minute cycles. Three minutes at any resonant point or, if none, at 55 c/s
Shock	400 g's, 1/2 sine; 3 shocks along each axis at 1/2 ms, 1 ms and 2 ms duration (total of 27 shocks)
Plug-In ¹	
Altitude	
Non-operating	To 50,000 feet and -55°C
PHYSICAL	
Finish	
Plug-In	Anodized aluminum front panel

¹The Plug-In environment is dependent upon the oscilloscope. See the environmental specification in the applicable oscilloscope manual.

TABLE 1-1 (cont)

Characteristic	Performance Requirement
Probe Body	Grey plastic housing
Dimensions	
Plug-In	≈14.58 inches long, 2.75 inches wide, 4.98 inches high; overall
Probe Body	≈6.53 inches long, 0.63 inches wide, 0.66 inches high; overall
Probe Cable	≈8.83 feet long
Weight, Plug-In and Probe combined	
Net	≈2.75 pounds
Shipping	≈4.5 pounds

SECTION 2

OPERATING INSTRUCTIONS

Change information, if any, affecting this section will be found at the rear of the manual.

General

This section contains an explanation of external controls and connectors for the Plug-In Unit (Fig. 2-1) and its attached Probe (Fig. 2-2). It also contains an explanation of accessories, a first-time operating procedure and additional operating hints. It is recommended that this section be read in its entirety prior to normal usage of the 7A11 Plug-In Unit and Probe.

PLUG-IN INSERTION AND REMOVAL

The 7A11 is calibrated and ready for use as received. It can be installed in any compartment of 7000-Series oscilloscopes, but is intended for principal use in vertical plug-in compartments. To install, align the upper and lower rails of the 7A11 with the oscilloscope tracks and fully insert it. The front will be flush with the front of the oscilloscope when the 7A11 is fully inserted, and the latch at the bottom-left corner of the 7A11 will be in place against the front panel.

To remove the 7A11, pull on the latch (which is inscribed with the unit identification "7A11") and the 7A11 will unlatch. Continue pulling on the latch to slide the 7A11 out of the oscilloscope.

PROBE REMOVAL AND STORAGE

To remove the Probe: With the 7A11 Amplifier removed from the oscilloscope, locate the Probe and Stored Probe Input Adapter on the right side of the 7A11 (Fig. 2-2A). Move the Probe back, disconnecting it from the Adapter. Note the plastic latch (labeled PRESS) on the side of the Adapter housing. While holding this latch depressed, move the Adapter out through the front of the 7A11, as in Fig. 2-2(B).

Uncoil the desired number of turns of cable from the cable drum and remove the Probe through the Adapter access hole. When the Probe and cable have been removed far enough to take up the slack cable within the 7A11, clip the Adapter to the cable as shown in Fig. 2-2(C). Then insert the Stored Probe Input Adapter into its housing in the 7A11, as in Fig. 2-2(D). Reverse the procedure to re-install the Probe.

EXTERNAL CONTROLS AND CONNECTORS

Plug-In Unit

VOLTS/DIV

A 12-position switch graduated from 5 mV through 20 V in 5-10-20 sequence. In addition to selecting calibrated deflection factors, it indicates the input capacitance and offset voltage range applicable to each switch position.

VARIABLE (CAL IN)

Combination switch and potentiometer. When the control is in its inward position, deflection factors are as indicated by the VOLTS/DIV switch. Push and release knob to enable selection of uncalibrated deflection factors between the value indicated by the VOLTS/DIV switch and at least 2.5 times that value.

POSITION

Moves display vertically on CRT when Plug-In Unit is in vertical compartment of oscilloscope. Permits horizontal movement of display when Plug-In is in horizontal plug-in compartment of oscilloscope.

IDENTIFY

Located in center of POSITION knob. When pushed, causes approximately 1/4 division movement of display. Oscilloscopes equipped with readout simultaneously display the word "IDENTIFY" in the 7A11 readout area on the CRT.

OFFSET

ON-OFF

Permits or inhibits operation of the OFFSET control.

COARSE

Outer of two concentric knobs. Stop-to-stop rotation injects offset voltage equivalent to +1 through -1, +20 through -20, or +400 through -400 volts at the inputs, depending upon position of

Operating Instructions—7A11

COARSE (cont.) VOLTS/DIV switch. Counterclockwise position offsets the input with a negative voltage, clockwise position offsets the input with a positive voltage.

INVERT Selects downward deflection for positive-going input signal. If the 7A11 is being used in a horizontal plug-in compartment, selects left deflection for positive-going input signal. Upward (or right) deflection for positive going input signals is provided if both switches are in the outward position.

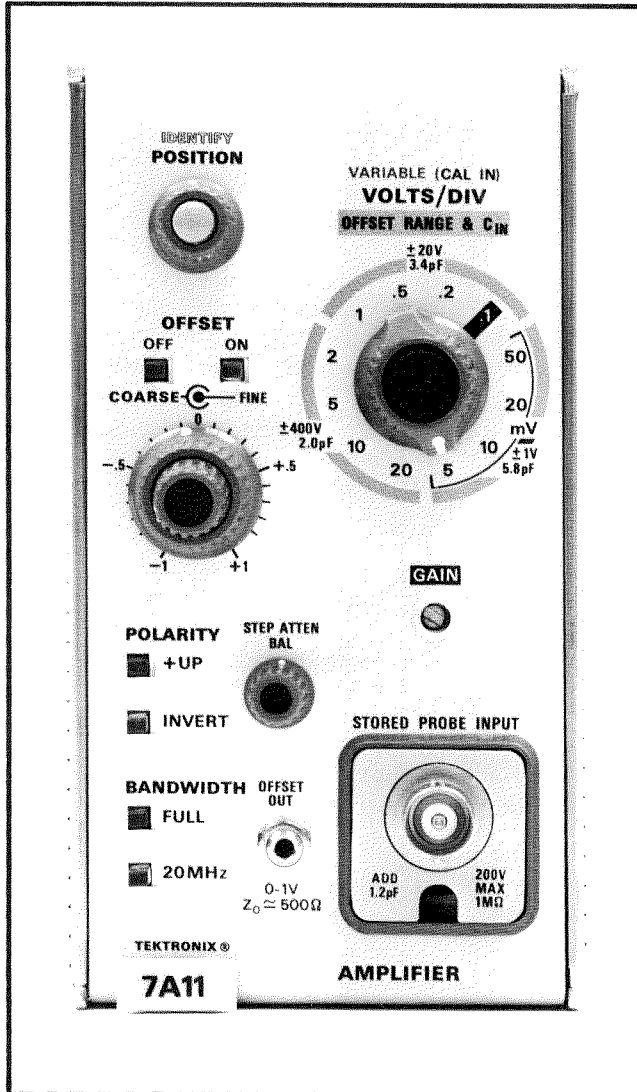

Fig. 2-1. 7A11 Front Panel.

FINE Inner of two concentric knobs. One revolution injects an equivalent of approximately 0.4, 4, or 40 volts offset voltage, dependent upon position of VOLTS/DIV switch.

POLARITY +UP Selects upward deflection for positive-going input signals. If the 7A11 is used in a horizontal plug-in compartment, selects right deflection for positive-going signal.

BANDWIDTH FULL Provides full bandwidth as specified for 7A11-oscilloscope combination.

20 MHz Reduces upper frequency -3 dB limit of 7A11-oscilloscope to 20 MHz. Full bandwidth is provided if both switches are in the outward position.

STEP ATTEN BAL Externally balances circuitry to avoid shifting of no-signal trace when VOLTS/DIV switch position is changed.

OFFSET OUT Miniature phone jack, making selected value of offset voltage available externally. No output provided when OFFSET switch is OFF.

GAIN Screwdriver adjustment permitting external calibration of VOLTS/DIV. Normally adjusted with VOLTS/DIV at .1 position as indicated by the shaded area surrounding the .1 at the VOLTS/DIV switch.

STORED PROBE INPUT BNC jack connected to Probe tip when Probe is stored within 7A11 Amplifier. Note that value of capacitance indicated at VOLTS/DIV switch must be increased by 1.2 pF when the STORED PROBE INPUT Adapter is used. When Probe is withdrawn from 7A11 Amplifier, STORED PROBE INPUT is usually disconnected from the circuit. Maximum allowable DC plus peak AC input voltage is 200 volts. Consult specification section for derating due to frequency.

Release Latch Latch inscribed with plug-in identification "7A11". Pull knob to release latch when removing 7A11 from oscilloscope.

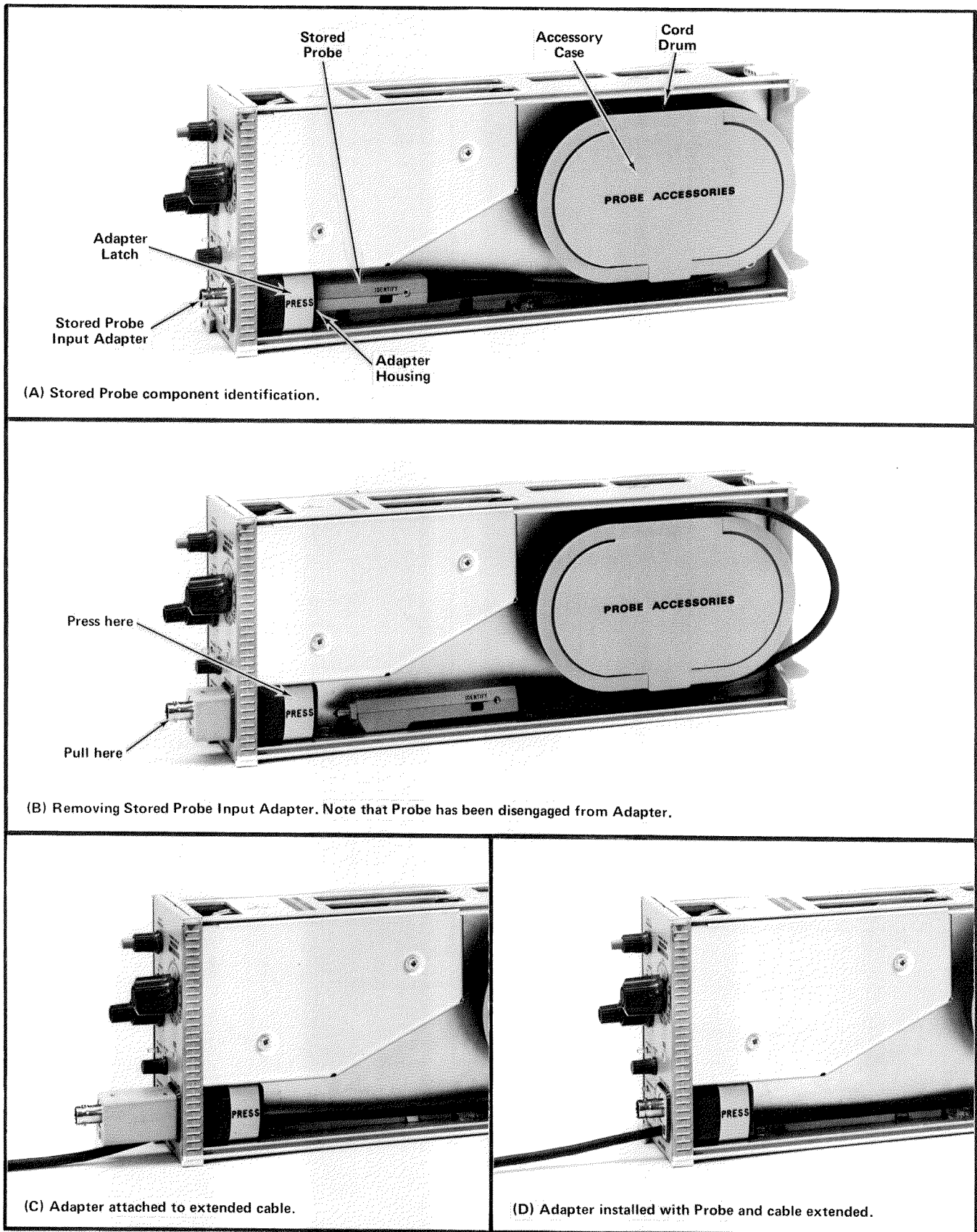

Fig. 2-2. Probe storage and removal.

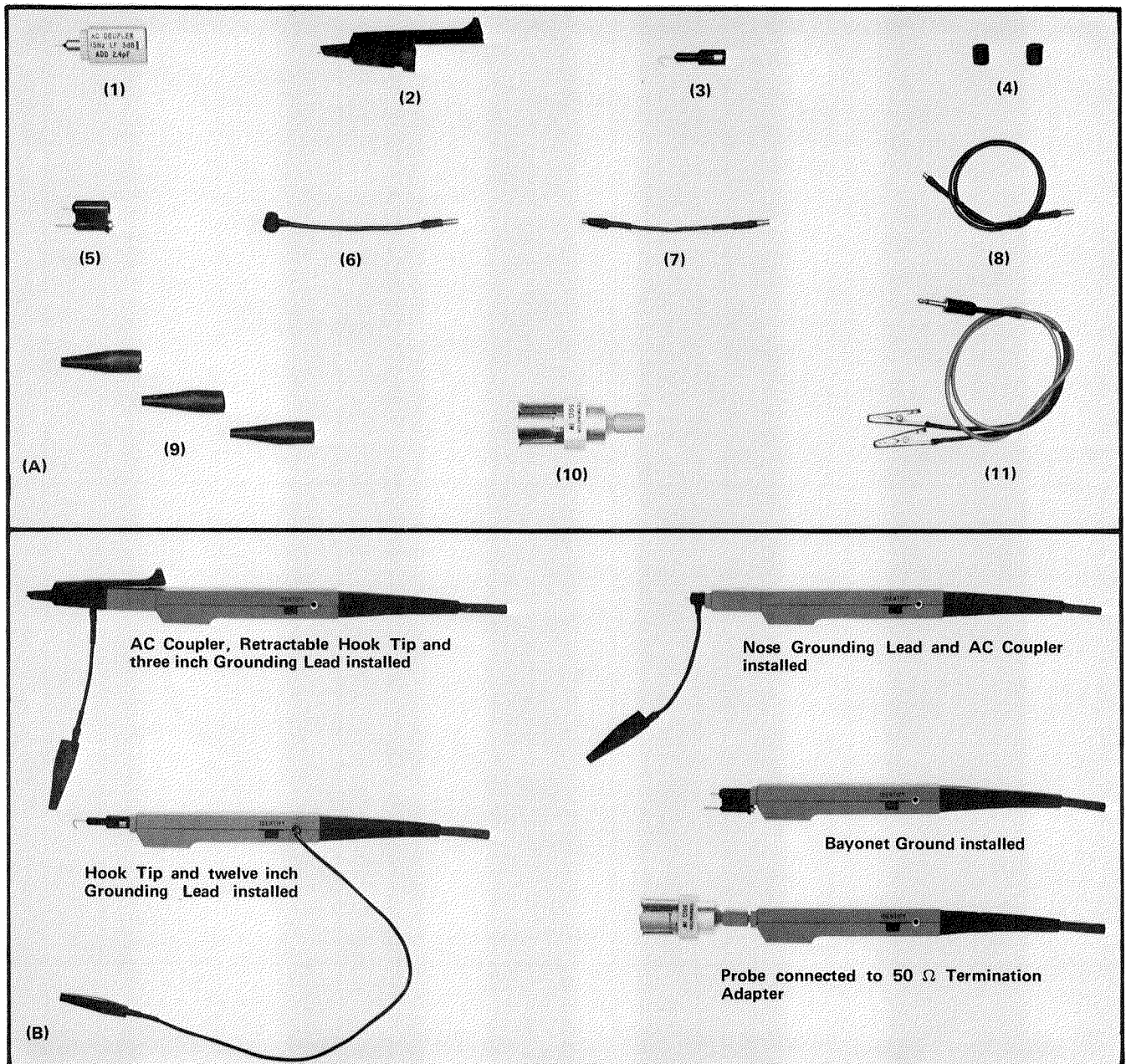

Fig. 2-3. (A) Accessories; (B) Accessories installed.

Probe

Tip

Miniature type, DC-coupled to internal circuitry. Can be equipped with DC blocking capacitor (see Accessory Information). Can also be equipped with pincher tip or hook tip for attaching Probe to circuitry. Maximum allowable DC + peak AC input is 200 volts. Consult specification section for derating due to frequency.

IDENTIFY pushbutton

Depressing it causes approximately 1/4 division trace shift. Also causes the word "IDENTIFY" to appear in 7A11 readout area on CRT if oscilloscope is equipped with read-out circuitry.

Ground Contact

Female-threaded contact for attaching grounding lead.

ACCESSORIES INFORMATION

Accessories are supplied with the Probe to extend its operating capabilities. These accessories are shown in Fig. 2-3 and are intended to be utilized as follows:

1. AC Coupler. Slip-on type containing a .015 μ F capacitor. Blocks DC from Probe. Has a 15 Hz low-frequency -3 dB point. Adds 2.4 pF to input capacitance indicated at VOLTS/DIV switch.
2. Retractable Hook Tip. Slip-on type for use with or without AC Coupler. Adds additional 1 pF input capacitance. Hook Tip body moves toward rear of Probe to expose hook. Contains female-threaded ground connection for use with either a 3 inch or 12 inch screw-in ground lead.
3. Hook Tip. Slip-on device for use with or without AC Coupler.
4. Insulating Tube. Slip-on device for insulating ground surface at Probe tip or AC Coupler tip.
5. Bayonet Ground. Slip-on device for use with or without AC Coupler. Spring loaded contact permits completing the Probe ground circuit immediately adjacent to Probe signal input tip.
6. Grounding Lead, Nose. Slip-on device which makes contact with ground surface at Probe or AC Coupler tip. Other end equipped with 6-32 male thread for attachment to alligator clip.
7. Grounding Lead, Screw-In, 3 inch. Primarily for use with Retractable Hook Tip. Threaded both ends. One end to be attached to Retractable Hook Tip, other end for use with alligator clip.
8. Grounding Lead, Screw-In, 12 inch. Threaded both ends. For use between threaded female grounding contact at Probe and alligator clip. Can also be attached between grounding female thread at Retractable Hook Tip and alligator clip.
9. Alligator Clips. For use with grounding leads.
10. 50 Ω Termination/Adapter, GR-to-probe tip. Can be used in any situation requiring 50 Ω probe input impedance.
11. Cable Assembly. Equipped with miniature telephone-jack plug, coaxial cable, and alligator clips. For use with OFFSET OUT jack.

FIRST TIME OPERATION

General

Operation of the 7A11 Amplifier and Probe in a vertical plug-in compartment of an oscilloscope is explained here. Operation of the unit with the Probe stored is explained first. This is followed by a description of operation with the Probe and its accessories.

Preliminary

Install the 7A11 Amplifier into a vertical compartment of a 7000-Series oscilloscope equipped with a time-base unit. Set the equipment controls as listed in Table 2-1.

TABLE 2-1
Preliminary Control Settings

7A11 Amplifier

VOLTS/DIV	.1
POSITION	Midrange
OFFSET	OFF
POLARITY	+UP
BANDWIDTH	FULL

Time Base

Triggering	
Mode	Auto
Coupling	AC
Source	Int
Magnifier	X1
Time/Div	1 mS
Variable	Calibrated

Oscilloscope

Intensity and Focus	Adjusted for Optimum Trace
Beam Finder	Normal
Calibrator	.4 V
Rate	1 kHz

STEP ATTEN BAL Adjustment

1. Using the 7A11 POSITION control, set the trace to vertical center of the graticule. Then depress the INVERT button and note the trace position.
2. Using the STEP ATTEN BAL control, move the trace to a point midway between its present position and the vertical center of the graticule.
3. Again using the POSITION control, set the trace to graticule center. Then depress the +UP button and again note the trace position. It should have remained at graticule center. If not, again adjust STEP ATTEN BAL to position the trace midway between its present position and graticule vertical center.

Operating Instructions—7A11

4. Repeat this procedure until no trace shift accompanies switching between +UP and INVERT.

5. Check STEP ATTEN BAL adjustment by rotating the VOLTS/DIV switch through all positions and noting that no trace shift occurs.

6. The STEP ATTEN BAL adjustment should be rechecked each time the 7A11 is used. Do not use the STEP ATTEN BAL adjustment as a position control.

IDENTIFY

1. Depress the 7A11 IDENTIFY button while observing the trace. Note that the trace shifts upward approximately 1/4 division when the button is pushed, and returns to its previous position when the button is released.

2. If the oscilloscope is equipped with readout circuitry, note that the word "IDENTIFY" appears in the 7A11 readout area of the CRT while the IDENTIFY button is pushed. The deflection factor in use should appear in the readout area when the IDENTIFY button is released.

BANDWIDTH

1. Adjust the oscilloscope Intensity and Focus controls to obtain optimum trace sharpness.

2. Depress the FULL Bandwidth switch and note that the trace becomes slightly less clearly defined. This occurs because a much wider frequency range is now being displayed, and the total noise increases accordingly.

A better indication of bandwidth operation can be obtained by connecting the output from a high-frequency generator to the STORED PROBE INPUT. With 20 MHz applied from the signal generator, and FULL selected at 7A11, adjust for 5 divisions of vertical display. Then select 20 MHz at the 7A11 and note that the vertical amplitude decreases to approximately 3.5 divisions.

GAIN

1. Connect a 50 Ω coaxial cable between the STORED PROBE INPUT and the Calibrator output jack at the oscilloscope.

2. Note that with 0.4 V and 1 kHz selected at the Calibrator and .1 VOLTS/DIV selected at the 7A11, a display of approximately 4 divisions appears on the CRT.

Adjusting the GAIN control with the oscilloscope Calibrator signal applied provides absolute accuracy to within 2% in the adjusted position at temperatures between 0°C and 50°C. Other deflection factors will then be accurate to within 4% absolute between 0°C and 50°C.

If greater gain accuracy is required, a more accurate amplitude calibrator must be used and all instruments must be restricted to a temperature range of 15°C to 35°C. The Tektronix Amplitude Calibrator and Comparator, Part No. 067-0502-01 is recommended for this purpose. An absolute accuracy approaching 2% may then be obtained over the range of deflection factors.

POLARITY

1. Disconnect the coaxial cable from the STORED PROBE INPUT Adapter. Then adjust the 7A11 POSITION control as necessary to place the trace at graticule vertical center.

2. Re-connect the coaxial cable to the STORED PROBE INPUT Adapter and note that the 1 kHz square wave is displayed in a positive or upward direction from the reference position established at graticule center.

3. At the 7A11, depress the INVERT button. Note that now the positive-going square wave is deflected in a downward direction on the CRT.

4. Depress the +UP button to regain upward deflection of the positive-going square wave.

OFFSET

1. Adjust the outer OFFSET knob as necessary to place its white marker at 0.

2. Depress the OFFSET ON button. The trace may shift upward or downward.

3. Move the OFFSET controls and note trace reaction. Clockwise movement causes upward deflection, while counterclockwise movement causes downward deflection. Also note that the FINE control knob causes considerably less reaction than the COARSE control knob. (The two knobs have a ratio of approximately 10:1.)

4. Depress the OFFSET OFF button. The square wave display should now appear in the upper half of the CRT.

5. Switch the oscilloscope Calibrator to 4 V and note that the upper excursions of the square wave are no longer visible. If it is desired to display the upper portions of the square wave, pull out on the oscilloscope BEAM FINDER knob, causing the entire display to appear on the CRT.

6. Depress the OFFSET ON button and adjust the OFFSET control as necessary to place the top of the square waves at graticule center.

7. Return the BEAM FINDER to normal by depressing and releasing the button. Note that the upper portion of the square wave now appears near graticule center. Refine the OFFSET adjustment (if necessary) to align the tops of the square waves with the graticule vertical center.

8. Calculate the OFFSET voltage being applied. It is equal to the OFFSET decimal value (indicated by the OFFSET knob) multiplied by the OFFSET RANGE (indicated by the VOLTS/DIV switch). In this case, the calculation is $-.2 \times 20 \text{ V} = -4 \text{ V}$. (-4 volts is needed to return a +4 V signal to graticule center.)

9. Using a DC voltmeter and the Cable Assembly, check the voltage available at the OFFSET OUT jack. It is equal to the value indicated by the OFFSET knob, and can never exceed approximately $\pm 1 \text{ V}$. Note that only 0.2 V is present there, even though the offset voltage being applied to offset the incoming signal is equivalent to 4 V.

10. Turn the OFFSET button OFF and disconnect the coaxial cable from the oscilloscope and the STORED PROBE INPUT Adapter.

Probe Operation

1. Pull out on the 7A11 Locking Latch and remove the 7A11 from the oscilloscope plug-in unit compartment.

2. Lay the 7A11 on its left side and remove the Probe as explained in the beginning of this section. Replace the 7A11 in the oscilloscope plug-in compartment. Allow approximately 1 minute to elapse before continuing with the procedure.

3. Depress the IDENTIFY button near the rear of the Probe body and note that the trace moves approximately 1/4 division just as it did when the front panel IDENTIFY button was depressed. If the oscilloscope is equipped with readout circuitry, also notice that the word "IDENTIFY" appears in the 7A11 readout area of the CRT.

4. Switch the oscilloscope Calibrator to 0.4 V. Now touch the Probe tip to the Calibrator output jack center terminal and note that approximately 4 divisions of square wave appears on the upper half of the CRT.

5. Disconnect the Probe from the jack. Attach the AC Coupler accessory to the Probe tip. Connect the Coupler tip to the Calibrator jack and note that the 4 division square-wave display now straddles the vertical center of the graticule, since the capacitor in the AC Coupler blocks the DC component.

6. It is suggested that the Probe's other accessories be experimented with at this time for familiarization purposes. Note that when the Retractable Hook Tip is installed on either the Probe or the AC Coupler tip, the hook can be exposed by pulling back on the retracting tab. Also note that either the 3-inch or 12-inch screw-in grounding lead can be used with the AC Coupler tip. An alligator clip should be attached to the opposite end of the grounding leads for attaching to convenient grounded surfaces.

7. Remove the 7A11 from the plug-in compartment. Depress the tab on the side of the STORED PROBE INPUT Adapter and remove the Adapter through the front of the 7A11. Retract the cable into the 7A11 and wind it on the cable spool as necessary to draw the Probe through the 7A11 front panel. Snap the STORED PROBE INPUT Adapter into place and insert the Probe into the back of the Adapter. The 7A11 is again ready for use in the stored probe mode.

Unscaled Deflection Factors

On occasion, it may be convenient to establish vertical deflection factors other than those which are provided by specific positions of the VOLTS/DIV switch. For example, assume that 0.8 volts/division deflection factor is desired. If a 4-volt square wave calibrator signal is applied to a vertical unit having 0.8 volts deflection factor, the displayed signal amplitude is equal to the applied signal (4 volts) divided by the deflection factor, (0.8 volts) which is equal to 5 divisions of display. With this in mind, set the VOLTS/DIV to the next lower deflection factor (in this case, .5 volts) and apply a 4-volt signal from the oscilloscope Calibrator to the 7A11 Probe input. Then depress and release the VARIABLE knob and adjust it as necessary to obtain 5 divisions of deflection. A 0.8 volt/division deflection factor now is in effect.

It should be noted that the same ratio of actual deflection factor to VOLTS/DIV switch value exists in all other switch positions. Thus if the VARIABLE control is in the position established in the preceding paragraph and the VOLTS/DIV switch is placed in the 2 VOLTS/DIV position, a 3.2 volts/division deflection factor will be in effect (0.8 is to 0.5 as 3.2 is to 2).

Input Capacitance

The input capacitance of the 7A11 Amplifier and Probe has been designed to be extremely low. For example, in the 5 through 50 mV positions, input capacitance is 5.8 pF. In the .1 through 1 V position it is 3.4 pF, and it is 2.0 pF in the 2 through 20 V positions. These figures pertain when the Probe is connected directly to a circuit and must be

modified whenever other coupling connectors are used. The AC Coupler device adds 2.4 pF. The Retractable Hook Tip adds 1 pF and the STORED PROBE INPUT Adapter adds 1.2 pF. Any additional devices such as connectors or cables between the signal source and the Probe or STORED PROBE INPUT connectors will further increase input capacitance.

SECTION 3

CIRCUIT DESCRIPTION

Change information, if any, affecting this section will be found at the rear of the manual.

General

The descriptions contained in this section are referenced to the schematics contained in the back of this manual. Additional diagrams appear with the text as necessary to facilitate explanations. The schematic diagrams are coded with numbers contained in diamond shaped outlines. These numbers are used extensively on the schematics for cross-referencing.

BLOCK DIAGRAM DESCRIPTION

Refer to Fig. 3-1. Major components of the 7A11 Amplifier are the Probe, the Input Amplifier, the Output Amplifier,

the Offset Generator and the Readout Control. When a signal is applied to the probe tip, a single-ended signal passes from the Probe to the Input Amplifier, where it is converted to a push-pull signal. It is then applied to the Output Amplifier, where it is amplified and sent through the interconnecting plug to the oscilloscope. The Output Amplifier also provides a push-pull trigger signal to the oscilloscope for time base triggering purposes.

An Offset Generator permits application of a DC offset voltage to the Input Amplifier, thus enabling the viewing of AC signal components in the presence of DC at a much higher sensitivity than would otherwise be possible. A

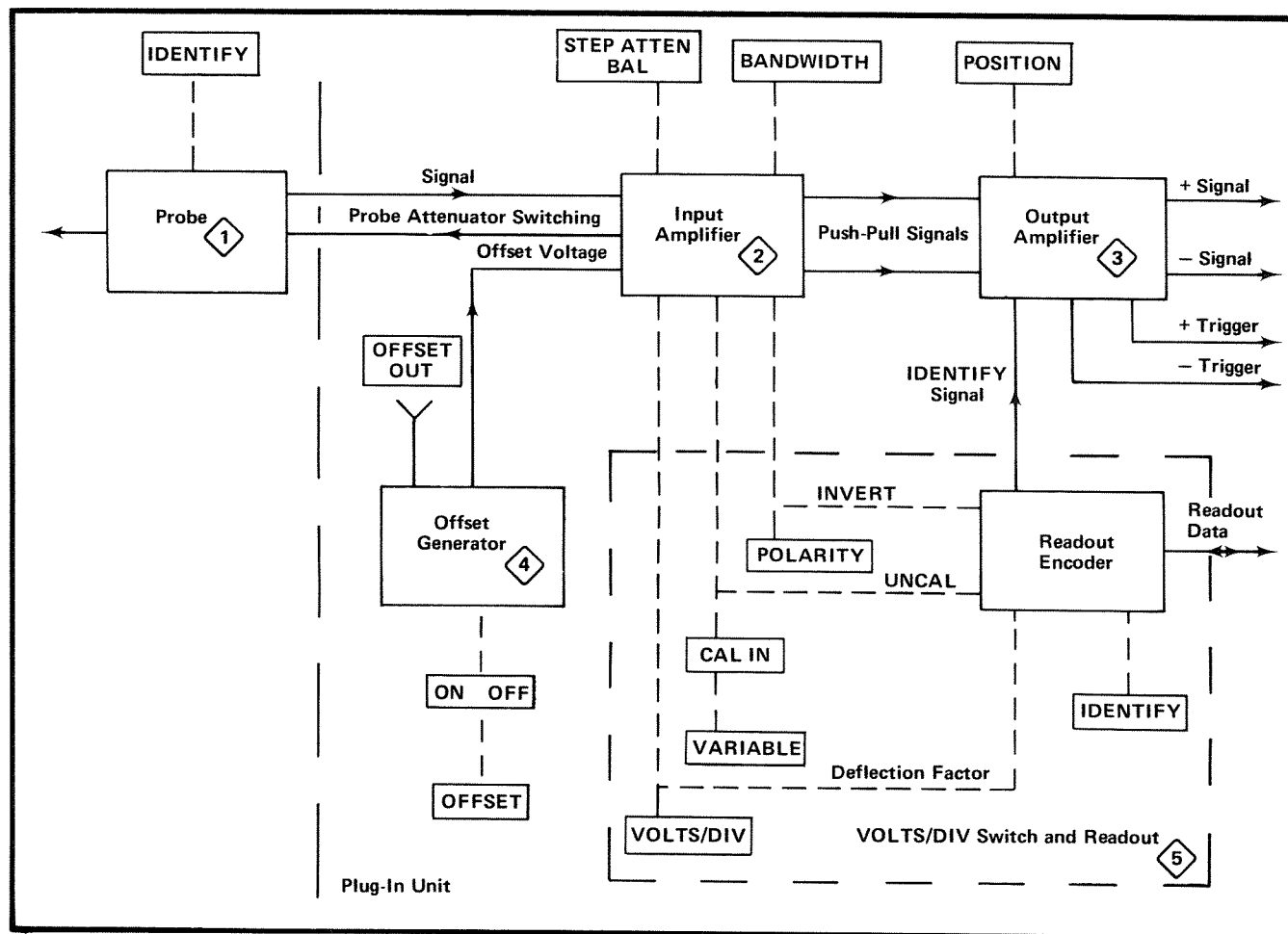

Fig. 3-1. 7A11 block diagram.

Circuit Description--7A11

separate miniature phone jack makes the selected offset voltage available at the front panel for monitoring or for external use. The offset is operative and the DC offset voltage is available at the OFFSET OUT jack only when the OFFSET ON button is depressed.

The sensitivity of the 7A11 Amplifier is determined by the VOLTS/DIV switch, which causes attenuation of the applied signal to occur in the Probe, in the Plug-In Unit, or in both. The deflection factor can be modified by use of the VARIABLE control. Whenever the CAL IN button is in the outward position, the VARIABLE control can change the deflection factor to as much as 2-1/2 times the value indicated by the VOLTS/DIV knob position.

The signal being sent to the oscilloscope can be inverted by use of the POLARITY switch. IDENTIFY buttons are present at both the Probe and the Amplifier to permit display identification. A BANDWIDTH control permits reduction of the 7A11 bandwidth, allowing the operator to greatly attenuate signals above 20 MHz when their appearance on the CRT display is not desired. The POSITION control permits the operator to move the 7A11 trace vertically on the CRT when the 7A11 is in a vertical compartment, or horizontally when the 7A11 is in a horizontal compartment. The VOLTS/DIV, CAL IN, POLARITY and IDENTIFY controls provide the Readout Encoder with information to be relayed to the Oscilloscope. The 7A11 status is thereby available for decoding and display. If equipped with readout circuitry, the oscilloscope decodes and displays the 7A11 status on the CRT.

PROBE CIRCUIT DESCRIPTION

Refer to the Probe diagram in the back of this manual. The probe circuitry consists of the Attenuators, the Input Field Effect Transistors (FETs), and two Emitter Followers. The Attenuator circuitry has three possible configurations. These are the straight through condition as shown on the schematic, the divide-by-twenty condition during which time the K59A contact is in the downward position, and the divide-by-400 condition during which time both the K55A and K59A contacts are in the downward position. In the straight-through position, suppressors C1, R1, C18, R18, and R19 aid in smoothing the transient response. Incoming signals are developed across R21 and applied through R22-C22 to the gate of Q23A. R22 provides protection to Q23A and C22 permits high-frequency signals to by-pass R22. Low-frequency signals are not affected by R22, since Q23A has very high input impedance at low frequencies.

When divide-by-20 relay K59 is de-energized, its contact drops to the lower position. This places R12 in series be-

tween the probe tip and R21. At the same time, it places the R13-C13-R15-C15-R16-C16 combination in parallel with R21. The net result is that a 1 M Ω input resistance is maintained although the signal being developed across R21 has been reduced to 1/20 of its previous value.

When K55 is also de-energized, R5, R4, C4, C5, C6 and R6 are inserted into the circuit in such a manner as to maintain the 1 M Ω input resistance, while reducing the signal developed across R21 to 1/400 of that applied at the probe tip.

When K55A and K59A are de-energized, the capacitance inherent in those switch contacts is automatically placed in parallel with R5 and R12. The capacitance inserted by the attenuators is therefore adjustable (C6 and C13) to provide the same attenuation ratio (due to capacitance) at high frequencies as is provided by the resistors at low frequencies.

The attenuator relay circuits are designed so that when no power is applied to the relays, they are de-energized and a 400-to-1 attenuation ratio exists between the probe tip and the Q23A gate. This situation safeguards against accidental damage to the input FETs when the equipment is de-energized.

When the equipment is energized and a straight-through attenuator condition is selected, 5 V is applied to the divide-by-20 and divide-by-400 relay lines. Current from the +5 V supply then flows up through both halves of K55 and through both halves of K59, energizing the two relays. When a divide-by-20 signal is initiated, the divide-by-20 line is grounded. Current now flows from the +2.5 V line through the two halves of K59 to ground. The net effect is that equal but opposite polarity fields are developed in K59 which cancel each other. K59 is thus permitted to de-energize, inserting the divide-by-20 attenuator components in the signal path. A similar effect occurs when the divide-by-400 signal is initiated. At this time both K55 and K59 fields are neutralized and both relays are de-energized. This method of controlling the relays maintains constant power consumption, regardless of relay status.

The input FET circuit current is determined by Q23B and R26, its self-biasing resistor. This current causes the drop across R24 to be identical to that across R26. Assuming identical biasing of Q23A and Q23B, the bottom of R24 is held at the same potential as the Q23A gate. Under no-signal conditions this value is zero volts. Under signal conditions, both points follow the voltage which exists at the top of R21. The high impedance offered by the drain of Q23B prevents changes in circuit current despite changes in

voltage at the drain. R28 provides a small amount of current (about 0.1 mA) to offset that required by the base circuit of Q33.

The signal is coupled through Emitter Followers Q33 and Q43 and then applied through the C44-R44-R45-R46-R47 network to a 93 Ω coaxial cable which applies the signal to the Input Amplifier. C44, R44, R45, R46 and R47 provide reverse termination for the 93 Ω cable.

The OFFSET control causes a current to flow through the R20, R45, R46, R47 reverse termination network without changing the operating voltage of Q43.

The 7-V supply which is used to power the probe circuitry is boot-strapped to ensure that the active devices do not change their characteristics as a result of DC signal components being applied to the probe tip. See the Power Supply explanation for details.

The IDENTIFY switch, when actuated, interrupts a ground path to an identifying signal injection circuit. Details regarding the circuit are contained in the VOLTS/DIV Switch and Readout description.

INPUT AMPLIFIER

General Description

Refer to the Input Amplifier schematic in the back of this manual. The principal parts of the Input Amplifier are the Paraphase Amplifier, the attenuation network, the variable gain control circuit, the bandwidth and polarity circuits. Signals received from the Probe are applied to the base of Q124A, where they cause equal and opposite signals to be developed in the collector circuits of Q124A and Q124B. Signal current passes through the bandwidth limiting filter, the X2 attenuators, the X2.5 attenuator and through the polarity switch circuits, after which they are applied to the Output Amplifier. When the CAL IN button is in the out position, the VARIABLE control can cause signal current to be shunted through field effect transistor Q198 to attenuate the signal being applied to the Output Amplifier.

A STEP ATTEN BAL circuit permits balancing the current in the two sides of the amplifier under no-signal conditions. This ensures that no trace shift will occur when attenuators are switched into or out of the circuit during no-signal conditions.

An offset voltage can be applied to the base of Q124A. In normal usage, the amount of offset voltage injected at this point is only sufficient to cancel a DC voltage level existing on the incoming signal.

An additional function occurring at the Q124A base is the sampling of the DC voltage component of the incoming signal for use in boot-strapping the Probe power supplies. A detailed description of this boot strapping feature is contained in the power supply circuit description.

Detailed Description

The base of Q124B is connected to ground in the Probe, thus providing a reference point for the paraphase amplifier. Under no-signal conditions, the base of Q124A is also at zero potential. This places equal voltages at the emitters of Q124A and Q124B. The current that is available through R148 and R149 is evenly divided between R127 and R147, and passes through transistors Q124A and Q124B.

The principal load for Q124A consists of R126 in parallel with R175, providing approximately 40 Ω impedance as seen from the top of R124. If any or all of the Input Amplifier attenuators are switched into the circuit, they appear in series-parallel combination with R175 in a manner which maintains a 40 Ω impedance as viewed from the top of R124. Changes in attenuators therefore do not affect the parameters associated with Paraphase Amplifier Q124A-Q124B.

The gain of the circuit is approximately equal to the sum of the load resistances of Q124A and Q124B divided by the resistance separating the two emitters. Thus, 40 Ω plus 40 Ω divided by the effective impedance between the two emitters (R127 plus R147 in parallel with R137, R139 and the effective resistance of R138) is equal to approximately one. Half of this gain of 1 can be detected at L126 and half at L146. As previously mentioned, this gain remains one regardless of the attenuators inserted into the circuit. However, the attenuators combine with R175 and R176 to reduce the signal available to the Output Amplifier to one-half, one-fifth or one-tenth of the signal available at L126 and L146. The relays are energized to provide the straight-through condition. The signal is reduced to one half by de-energizing K405 and K407. It is reduced to one fourth by de-energizing K411 and K413. All three pairs of relays are de-energized to reduce the signal to one tenth.

Gain and frequency compensation adjustments are provided between the emitters of Q124A and Q124B. R124 and R144 provide thermal compensation, with C124 and C144 providing high-frequency signal by-pass. VR124 is normally non-conducting. It limits the voltage which can be dropped across R124 to approximately 3 V, maintaining good circuit response under large signal conditions.

In FULL bandwidth mode, relays K401 and K403 are activated. When 20 MHz bandwidth is selected at the front panel, L152, L155, C153 and C154 cause a bandwidth

Circuit Description—7A11

reduction. Polarity relay K431 is de-energized during +UP operation. When INVERT operation is selected at the front panel, K431 is activated and exchanges the connections being made between the two halves of the Input Amplifier and the two halves of the Output Amplifier.

The VARIABLE circuit consists of Q198, Q184, Q194, U194, and associated components. Q198 is held non-conducting during calibrated gain operation. During variable gain operation, it acts as a resistor with its value determined by the position of the VARIABLE control. Since Q198 is in parallel with R126-R146 and R175-R176, decreasing its resistance decreases the Q124A-Q124B load impedance, thereby decreasing stage gain.

Q198 is controlled as follows: When the VARIABLE control is at CAL IN (S180A open), the 6.72 mA demanded by the Q184-R184 circuit causes about -7.23 V to be developed at the R182-R183 junction. Since S180A is open, no current flows through R180 and this same voltage appears at the R180 wiper and at the non-inverting input of U194. The R192-R193 voltage divider applies approximately -7.20 V to the inverting input of U194. With the non-inverting input more negative than the inverting input, the U194 output is held below -12 V and the R195-R196 voltage divider applies approximately -16 V to the gates of Q194 and Q198, holding them both cut off.

When VARIABLE control is desired, the knob is placed in the outward position, closing S180A. A voltage more positive than that at the R182-R183 junction can then be selected at the VARIABLE wiper and applied to the U194 non-inverting input. The output of U194 then changes in a positive direction, with the amplified change appearing at the gates of Q194 and Q198. When the output moves sufficiently positive, Q194 conducts, becoming a resistive shunt across R191 and R192. When the Q194 resistance becomes low enough, the R192-R193 junction voltage rises to the same value as the R180 wiper voltage and the U194 output voltage stabilizes at the established value.

Circuit design causes equal currents to flow through R191 and R192. With their common junction tied to -7.1 V, the Q194 source and drain connections swing equally above and below -7.1 V respectively, simulating the push-pull conditions associated with Q198.

Since the Q194 gate potential is also being applied to the Q198 gate, the Q198 resistance duplicates the Q194 resistance, creating a shunt across the Q124A-Q124B push-pull load. Either source-to-drain or drain-to-source current flow can occur in Q198, depending upon the instantaneous polarity of push-pull signals.

The STEP ATTEN BAL circuit is capable of applying a small voltage at the base of Q124A, thus affecting the current being conducted by that transistor. When properly adjusted, equal current will flow through Q124A and Q124B. Thus, under no-signal conditions, when the POLARITY control is switched between +UP and INVERT, no trace shift will occur. The STEP ATTEN BAL CENTERING adjustment permits initial adjustment of the circuitry so that a balanced condition is obtainable with the front panel STEP ATTEN BAL adjustment near midrange.

The offset connection at the Q124A base permits between 0 and $+ or - 1$ V to be applied to the base of Q124A when OFFSET ON is selected at the front panel. Normally, the offset voltage injected at this point is limited to an amount sufficient to cancel a DC or AC signal component, returning the desired portion of the display to the graticule center.

OUTPUT AMPLIFIER

General Description

The Output Amplifier is a balanced circuit consisting of four principal parts. They are: First Amplifier Q204A, Q224, Q204B, Q234; Second Amplifier Q244, Q248, Q254, Q258; Output Stage Q264, Q274; and Trigger Amplifier Q284, Q294. The Output Amplifier has a total voltage gain of about 12 which is distributed as follows: First Amplifier 2.8, Second Amplifier 3.7, Output Stage 1.25.

Detailed Description

The two sides of the First Amplifier stage share the current flowing in R213. Most of this current is obtained from R237. Under balanced no-signal conditions, the current is divided equally between R226 and R236, with the current in the upper half passing through load resistor R226, grounded base transistor Q224, thermal time constant circuit C204-R204, through Q204 and R202. Current flow in the lower side of this circuit passes through equivalent components. Under signal input conditions, an equal and opposite signal current change occurs in Q204A and Q204B. The resultant voltage changes across R226 and R236 are applied to the Second Amplifier stage. C203 and C234 provide frequency compensation for the First Amplifier stage. C211 and R211 provide frequency compensation for the probe.

Under balanced conditions, approximately $+2$ volts appears at the emitters of Q224 and Q234. When the POSITION control is electrically centered, it also has approximately $+2$ V at its wiper and no current flows in R206 and R216. When fully offset, the wiper senses -11 V or $+15$ V. R206 is thus able to either add or subtract approximately 0.65 mA to the upper side of the amplifier circuit, while R216 adds or subtracts an equal (and

opposite) amount to the bottom side of the circuit. This increase or decrease of current develops a positioning signal across R226 in the upper half and R236 in the lower half of the First Amplifier stage. The POSITION CENTERING adjustment (which is in parallel with R226 and R236) functions in a similar manner to the POSITION adjustment. It is an internal adjustment for centering the range of the POSITION control.

The Second Amplifier stage is essentially the same as the First Amplifier stage. A noticeable exception is that PNP transistors are used instead of NPN transistors.

The Output Stage consists of a conventional amplifier operating into a $25\ \Omega$ load. For Q264, this $25\ \Omega$ is provided by R266 and a $50\ \Omega$ load contained in the oscilloscope. In addition to being a load for Q264, these two resistances provide termination on both ends of the $50\ \Omega$ transmission line which carries the vertical signal from the Output Stage to the vertical amplifier circuit in the oscilloscope. C261 provides frequency compensation for the stage. R264, C264, R274 and C274 are thermal compensation components. VR264 and VR274 maintain good circuit response under large-signal conditions by limiting the voltage which can be developed across R264 and R274.

An IDENTIFY signal is inserted at the R264-R266 junction through R269. When the IDENTIFY button is pressed at either the Probe or the front panel, approximately 0.5 mA of current is injected at this point to develop a 12.5 mV signal across the two paralleled $50\ \Omega$ load resistors. This causes the trace to shift approximately 1/4 division, enabling it to be distinguished from other traces which may exist on the CRT.

The Trigger Amplifier is also a conventional push-pull amplifier circuit. C295 and R296 provide it with transient response compensation. L282 and R282 terminate the etched-circuit transmission line which conducts the signals from the display-signal circuit to the trigger signal circuit. The TRIGGER BALANCE adjustment permits a balanced voltage output to be delivered to the oscilloscope under no-signal conditions when the trace has been positioned to CRT center.

OFFSET GENERATOR

Basic Description

Refer to the Offset Generator schematic in the back of this manual. The Offset Generator consists of the Offset Emitter Followers and the Offset Inverter. When the OFFSET switch is ON, the selected offset voltage is processed by the Offset Emitter Followers and is applied through R317 to the base of Q124A in the Input Amplifier, where it is accepted as a positioning signal. A voltage equal but

opposite to that appearing at the R312-R314 junction is generated by the Offset Inverter and is applied to R49 in the Probe. The sum of R317, R44, R45, R46 and R47 is approximately equal to the R49 resistance. Since the offset voltage is equal to the inverted offset voltage, no offset current flows in the Q43 emitter.

Bootstrap Amplifier U345 is connected into the circuit in such a manner that it can offset the 7-V Probe power supplies in response to signals only. Signals at the Q124A base are reduced in amplitude by voltage divider R343-R344 and filtered by R345-C345. U345 amplifies the filtered signal. Any offset voltage appearing with the signal is cancelled by sensing the voltage at the OFFSET OUT jack through R340. If the signal voltage at the Q124A base goes positive by 1 volt, the Probe power supplies will also go positive by 1 volt. The +7 Volt supply will change to +8 volts with respect to ground and the -7 volt supply will change to -6 volts. At low frequencies, each of these two voltages will maintain its seven volt difference with respect to the signal voltage existing at the Q124A base.

With the OFFSET switch ON, OFFSET voltages are prevented from affecting the probe power supplies as follows: assume a +1 V DC signal is applied at the Probe tip. If the OFFSET switch is OFF, approximately 0.89 V DC appears at the base of Q124A. R344 and R343 reduce the signal amplitude to approximately 0.55 V at the non-inverting input of U345. U345 then amplifies the signal by a factor of $1 + R347 \div R340$, causing the U345 output to go to 1.18 V. This causes a +1 V change at the R511-R512 junction and at the R531-R532 junction, which connect the bootstrap signal from U345 to the probe power supplies. The +7 V supply is thus shifted to +8 V and the -7 V supply changes to -6 V.

If the OFFSET control is then used to return the trace to center screen, the voltage at the Q124 base is reduced to zero, even though a +1 V DC input signal is applied to the Probe input. However, U345 derives offset information from the R320-R321 junction, amplifies it (by the ratio of $R347 \div R340$) to approximately +1.18 V, which is the same as existed at the U345 output without the OFFSET voltage. Thus the +7 V supply is held at +8 V and the -7 V supply is held at -6 V, exactly as without the offset, maintaining correct bootstrapping.

Additional Description

R306, R307, R308, R309 and thermal compensation diodes CR306 and CR309 form a voltage divider in the base circuits of Q312 and Q314. The large value of resistances used in the divider cause a relatively constant current to flow from the -50 V to the +50 V supply. The center tap of this divider is connected through a $1\ \text{k}\Omega$ resistor to the wiper of the OFFSET control, which is capable of modify-

Circuit Description—7A11

ing the voltage at the divider center tap by approximately + or -12.2 V. This change in voltage appears simultaneously at the bases of Q312 and Q314, which act as complementary emitter followers. Circuit losses reduce the maximum possible offset voltage to approximately + or -12.0 volts at the R312-R314 junction. When the OFFSET switch is ON, this voltage is applied through R317 to the base of Q124A in the Input Amplifier circuit.

The offset voltage appearing at the C317-R317 junction is also applied through R322 to the inverting input of amplifier U324. The output of this amplifier is applied to a circuit which is identical with the circuit connected to the OFFSET potentiometer. The output of this circuit is applied to R49 in the Probe as previously explained. It should be noticed that R322, U324, Q332, Q334 and R335 make up an operational amplifier. Feedback resistor R335 is equal to input resistor R322, and U324 has extremely high gain. The overall gain of the amplifier circuit is therefore equal to approximately one. This makes the inverted output equal in amplitude to the non-inverted output which is applied to the left side of R317.

VOLTS/DIV SWITCH AND READOUT

General

Refer to the VOLTS/DIV Switch and Readout schematic in the back of this manual. The VOLTS/DIV switch is of the cam type. Raised portions on individual sections engage spring contacts to make switch connections. Dots on the switch matrix indicate which contacts are closed in any given switch position. For example, the switch is shown in the 5 mV position. Dots in the 5 mV row indicate that the switch contacts associated with cams 1, 3, 5, 6, 7, 9, and 10 are closed. All other cam operated switches are shown in the open position.

The VOLTS/DIV switch cams can be grouped under three functions. Cams 1 through 4 control attenuator switching in the Probe. Cams 5, 6 and 7 control attenuator switching in the Input Amplifier. Cams 8 through 12 control readout circuitry. The functions associated with cams 1 through 7 are explained in the Probe and Input Amplifier circuit descriptions. The functions associated with cams 8 through 12 are explained here.

Readout Circuitry

Oscilloscopes can be equipped with readout circuits which are capable of displaying readout data associated with the traces being displayed on the CRT. This data must be encoded by the plug-in units in use. In the 7A11, the data is dependent upon the position of the VOLTS/DIV switch, the POLARITY switch, the CAL IN switch, and the IDENTIFY switch.

Encoding information is provided by two currents which are referred to as "column" current and "row" current. Any one of eleven discrete current values can be present on each line at any one time, making 121 possible current combinations available. When the indicator unit has been set to display the 7A11 readout data, a voltage pulse is sequentially applied to encoding lines B29, B32, A32, A30, A33, and B33.

For example, assume that a 15 volt pulse is applied to the A32 line and that the A37 and B37 lines are at zero potential. With the VOLTS/DIV switch in the position shown, 400 μ A will flow through R451 and 200 μ A will flow through R453. The combined 600 μ A appears on the A37 line. Since no connection exists between A32 and B37, no current appears on the B37 line. The simultaneous occurrence of 600 μ A on A37 and zero current on B37 is decoded as the character 5 by the oscilloscope.

Assume now that the A32 line has been returned to zero potential and a 15 volt pulse is being applied to the A30 line. The contact associated with cam 9 is closed and 100 μ A flows through R447 and appears on the A37 line. Simultaneously, 300 μ A flows through R446 and appears on the B37 line. These two currents are decoded by the oscilloscope as the character m. A30 is then returned to zero potential and a voltage is applied to B29. The B29 current paths are not interrupted by switches, and therefore cause 200 μ A on the A37 line and 400 μ A on the B37 line whenever a 15 volt pulse is applied to B29. This causes the character V to be decoded by the oscilloscope. Thus, in the example just given, a deflection factor readout of 5 mV would be printed on oscilloscopes equipped with readout circuitry.

The other input lines function in a similar manner to provide information such as UNCAL, INVERTED, or to add a 0 or decimal point to the 1, 2 or 5 value coded by A32. Note that the CAL/UNCAL and POLARITY circuits are controlled by front-panel push switches rather than by the VOLTS/DIV switch. When UNCAL operation is selected, the symbol for "greater than" appears immediately preceding the deflection factor selected by the VOLTS/DIV switch.

Identify Circuit

The IDENTIFY circuit is normally connected to ground in the Probe. When either of the Probe or Plug-In IDENTIFY switches are depressed, this ground circuit becomes open and current through R421 causes Q424 to saturate. Its collector (which had previously been held at -15 volts by CR424 and R424) then goes to approximately ground potential, causing sufficient current through R269 to inject an approximately 1/4 division deflection signal into the output signal line at connector A11. The Q424 col-

lector voltage is also applied to the input base of Darlington circuit Q444, causing it to conduct approximately 1.2 mA on the A37 line. This current causes the word "IDENTIFY" to appear in the 7A11 readout data area of the CRT, negating all other 7A11 readout data.

Bandwidth Control

The BANDWIDTH control circuit also appears on the Volts/Div Switch and Readout schematic. Bandwidth control relays K401 and K403 are energized whenever FULL bandwidth is selected. When 20 MHz bandwidth is selected, these relays de-energize, placing frequency limiting components in the signal path. See the Input Amplifier schematic for details regarding the switch contacts and frequency limiting components.

POWER SUPPLIES AND OUTPUT CONNECTORS

Refer to the Power Supply and Output Connectors schematic diagram. The Power Supplies contained in the Type 7A11 are conventional series-regulating types. The

plus and minus 7-volt supplies may be considered as an exception to this, since they are referenced to a floating potential. The R512, R531 junction acts as a reference and is connected to the output of the U345 Bootstrap Amplifier which is contained on the Offset Generator schematic. Under no-signal conditions, the reference point is near zero volts, causing the absolute value of the plus and minus 7-V supplies to be equal. Whenever the reference point is caused to go either positive or negative by the average value of the input signal, the plus and minus 7-V values change in the same direction.

R500 adjusts the +8.7-V supply and R540 adjusts the -7.1 and -8.7-V supplies. The +2.5-V supply is not adjustable.

All of the connections made to the Oscilloscope by the 7A11 are shown on the Power Supply And Output Connector diagram.

SECTION 4

MAINTENANCE

Change information, if any, affecting this section will be found at the rear of the manual.

PREVENTIVE MAINTENANCE

General Information

The 7A11 Amplifier should be cleaned, lubricated, inspected, and recalibrated at regular intervals. A recommended schedule for average operating conditions is every 6 months or every 1000 hours of operation, whichever occurs first.

Cleaning

Keeping the equipment clean can help to maintain peak performance and lengthen its operating life. Dirt on components can result in short circuits or reduced frequency response. A dry, soft cloth and a soft-bristled brush are recommended for removing loose dirt from the outside of the instrument. Dirt on the inside should be loosened with a soft-bristled brush and removed by using a vacuum cleaner or a stream of low-pressure air. High-pressure air can damage the equipment and should not be used.

WARNING

Use an eye-shield when cleaning with pressurized air.

Hardened dirt should be removed by using a mild detergent and water solution on a cotton-tipped swab or a soft cloth. Disconnect the equipment from power sources before using the solution. Avoid excessive use of water. Do not allow water to penetrate any parts. Dry the instrument thoroughly before energizing it. Avoid the use of abrasives and chemical cleaning agents. Protect the equipment from dirt and damage by keeping it covered when not in use.

Visual Inspection

After cleaning, the equipment should be carefully inspected for defects such as poor connections, damaged parts and improperly seated transistors and integrated circuits. Damaged parts require that the cause of the damage be eliminated before operation is resumed.

Lubrication

The VOLTS/DIV cam switch detent and the VARIABLE slide switch tracks should be given a very light

application of lubricant when maintenance and calibration is being performed. Use Beacon no. 325 grease or equivalent, Tektronix Part No. 006-0147-00. Do not lubricate the OFFSET potentiometer bearings. Contact a Tektronix Field Representative if additional information regarding lubricants or lubrication is required.

Transistor and Integrated Circuit Checks

Checking transistors and integrated circuits as a preventive maintenance function is not recommended. Circuit performance is thoroughly checked during calibration; unacceptable devices will be detached at that time.

Recalibration

The calibration status of an instrument should be determined as a part of preventive maintenance for several reasons: (1) the performance of an instrument changes slightly with age, use and operating conditions; (2) performance may be affected by the cleaning process; and (3) checking the calibration status may reveal troubles which are not obvious during regular operation.

The calibration status can be determined rapidly by accomplishing the Performance Check contained in section five.

TROUBLESHOOTING

Test Equipment

The test equipment listed here should suffice for most troubleshooting jobs on the 7A11 Amplifier:

High Impedance Voltmeter; 10,000 Ω/V DC or greater.

Ohmmeter; 1-1/2 - V source supplying less than 2 mA of current on the X 1 k scale.

Test oscilloscope; 2 MHz bandwidth (sampling oscilloscope required for troubleshooting Vertical Amplifier high frequency problems).

Maintenance—7A11

Transistor Curve Tracer or Transistor Tester.

General Techniques

Proper troubleshooting logic is the most important tool in equipment repair. The following guide provides a logical sequence for analyzing equipment failures:

1. Check all external control settings.
2. Determine that the operating procedure is correct.
3. Determine all of the trouble symptoms. Analyze the trouble, keeping in mind the symptom inter-relationship.
4. Perform a visual inspection, concentrating on the area indicated by the trouble analysis.
5. Troubleshoot the circuitry; repair as necessary.
6. Check the calibration status; recalibrate as necessary.

Control Settings and Operating Procedure. Refer to the Operating Instructions section of this manual to verify external control settings and operating procedure.

Trouble Symptoms. After it is confirmed that trouble exists, the response to all exterior controls should be observed. The Troubleshooting Chart in this section can be used for this purpose. All trouble symptoms should be evaluated and compared against each other. Equipment trouble will often create a combination of symptoms that will pin-point the trouble. A good example of this is power supply trouble, which causes symptoms to occur in otherwise unrelated circuits.

Visual Inspection. In visually examining the equipment, take special note of the area localized by evaluation of symptoms. Look for loose or broken connections, improperly seated transistors or integrated circuits, and burned or otherwise damaged components. Repair all obviously defective parts. Investigate the cause of heat damage to components.

Detailed Troubleshooting. If the trouble has not been disclosed and corrected through the outlined procedure, a detailed troubleshooting analysis must be performed. The

Circuit Description section, the Schematic Diagrams, the Calibration Procedure, and the troubleshooting aids contained in this section are designed to expedite troubleshooting.

The Circuit Description section provides a fundamental understanding of circuit operation and is referenced to the Schematic Diagrams. The Schematic Diagrams contain voltage and resistance values and signal waveforms. All specified operating conditions should be duplicated before making voltage or waveform comparisons. In cases where the nominal voltage (black numbers) conflicts with the measured voltage (blue numbers), the measured voltage should be used.

NOTE

Voltages and waveforms may vary slightly between individual instruments and are also dependent upon the characteristics of the test equipment used to obtain them. Voltages and waveforms given on the schematics should be checked against each instrument while it is operating properly. Deviations should be noted on the schematics for later reference.

Calibration. Although the calibration procedure is intended primarily for instrument calibration, it can serve as an efficient troubleshooting aid. Since each step is based upon satisfactory performance of the preceding steps, the problem circuit will be encountered before circuits which are dependent upon it.

Troubleshooting Basic Components

General. The quantity of semiconductor devices in the 7A11 Amplifier requires that anyone working on it have a general knowledge of semiconductor operation. Some information is presented here to aid in this respect.

Once a trouble has been isolated to a specific circuit, the ease of replacing transistors and integrated circuits often makes substitution the fastest means of repair. Adhere to the following instructions if the replacement method is used:

Determine that the circuit is safe for the substitute component.

Substitute components which are known to be good.

Have only one transistor or integrated circuit out of the instrument at a time to avoid inserting them in the wrong sockets.

Insert components properly, using Fig. 4-9 as a guide for inserting transistors and integrated circuits.

Check operation after each component is replaced, and be sure to return good components to their original sockets.

Check calibration after a bad component has been replaced.

CAUTION

Voltage is present on the cases of some metal-cased transistors and integrated circuits. Avoid short-circuiting them.

Transistor Troubleshooting. Transistor defects usually take the form of the transistor developing an open circuit, short circuit, or excessive leakage. The best means of checking a transistor for these and other defects is by using a transistor curve display instrument such as a Tektronix Type 575 or 576. If a transistor checker is not readily available, a defective transistor can be found by signal tracing, by making in-circuit voltage checks, by measuring the transistor resistances, or by the substitution method previously described.

When troubleshooting with a voltmeter, measure the emitter-to-base and emitter-to-collector voltages to determine if the voltages are consistent with normal circuit voltage. Voltages across a transistor vary with the type of device and its circuit function. Some of these voltages are predictable. The base-emitter voltage of a conducting silicon transistor will normally be 0.6 to 0.8 V. The collector-emitter voltage of saturated transistors is approximately 0.2 V. Because these values are small, the best way to check them is by connecting the voltmeter across the junction and using a sensitive voltmeter setting, rather than by comparing two voltages taken with respect to ground. *Both leads of the voltmeter must be isolated from ground if this method is used.*

If values less than these are obtained, either the device is short-circuited or no current is flowing in the circuit. If values are in excess of the base-emitter values given, the junction is back-biased or the device is defective. Values in excess of those given for emitter-collector could indicate either a non-saturated device operating normally, or a defective (open-circuited) transistor. If the device is conducting, voltage will be developed across resistances in series with it; if it is open, no voltage will be developed across resistances in series with it unless current is being supplied by a parallel path.

An ohmmeter can be used to check a transistor if the ohmmeter voltage source and current are kept within safe limits. 1-1/2 volts and 2 mA are generally acceptable. Selecting the X 1 k scale on most ohmmeters will automati-

cally provide safe voltages and currents. If the voltage and maximum output current of a specific ohmmeter is in doubt, it should be checked before using it on transistors by connecting the test leads to another multimeter.

CAUTION

A transistor's specifications should be checked to determine maximum allowable ratings before subjecting it or associated circuits to voltage or current higher than that recommended here.

Table 4-1 contains the normal values of resistance to expect when making an ohmmeter check on an otherwise unconnected transistor. Fig. 4-9 illustrates transistors and sockets for pin location purposes.

TABLE 4-1

Transistor Resistance Checks

Ohmmeter Connections ¹	Resistance Reading That Can Be Expected When Using the R X 1 k Range (1.5 V ohmmeter operating voltage)
Emitter-Collector	High readings both ways (100 k Ω to 500 k Ω , approximately)
Emitter-Base	High reading one way (200 k Ω or more) Low reading the other way (400 Ω to 3.5 k Ω , approximately)
Base-Collector	High reading one way (200 k Ω or more) Low reading the other way (400 Ω to 3.5 k Ω , approximately)

¹Reverse the test lead connections to make the second reading. Reversal of the applied voltage polarity causes the junction to shift between being reverse and forward biased, as indicated by the difference in resistance.

Field Effect Transistor Checks. The voltage and resistance of field effect transistors can be checked in the same manner as transistors. However, it should be remembered that normal operation has the gate-to-source junction reverse biased, in a manner similar to control grid to cathode bias in vacuum tubes. 1.5 V and less than 2 mA should be used for ohmmeter checks. Resistance readings should be:

drain-to-source	Less than 500 Ω
gate-to-source and gate-to-drain	400 Ω to 10 k Ω (approximately) in one direction; more than 200 k Ω with leads reversed

Integrated Circuit Testing. Integrated circuits should be tested by checking for correct voltages at the terminals. If the input voltages are proper and the outputs are wrong, either the integrated circuit or its output load is defective. It is also possible that the integrated circuit may be misaligned with its socket.

Diode Troubleshooting. Checks on diodes (other than Zeners) can be performed in much the same manner as on transistor base-emitter junctions. Silicon diodes should have 0.6 to 0.8 V across the junction when conducting. Higher readings indicate that they are either back-biased or defective, depending on polarity. The ohmmeter precautions pertaining to transistors should also be observed when checking diodes.

Some diodes used in the equipment are color-coded to identify the diode type. A blue or pink first band indicates that the next three colors translate to the last three digits of its part number. Diode polarity can be determined by color code position. See Fig. 4-1.

NOTE

The positive side of an ohmmeter voltage source is often connected to the meter common test lead.

Resistors. The same ohmmeter voltage and current precautions observed in transistor troubleshooting also apply when making resistance checks in circuits which contain semiconductors. For best results, resistors should be isolated from the semiconductors before resistance checks are made.

The types of resistors found in this equipment vary in accordance with the circuit needs. Composition, metal film and wire-wound resistors are used. Replacement resistors should be of the same type and must be at least as accurate as those originally contained in the circuit to maintain the performance standards. The size, location and lead length are often critical because of frequency considerations. Resistor values are indicated by one of three methods in the equipment:

4 color bands (digit, digit, multiplier - tolerance)

5 color bands (digit, digit, digit, multiplier - tolerance)

Numbers printed on wire wound and metal film resistors

The first two methods translate to the IEEE color-code equivalent and are illustrated in Fig. 4-2.

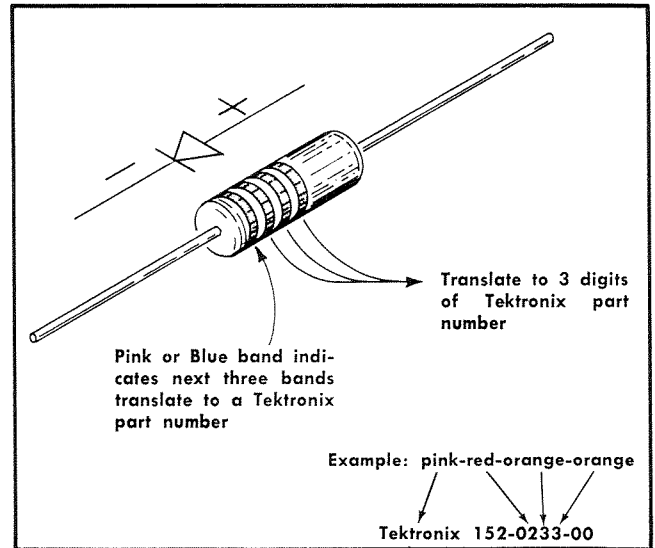

Fig. 4-1. Diode color code related to Tektronix part number and conducting polarity.

Wire Information. All insulated wires and cables used in the 7A11 Amplifier are color-coded to facilitate circuit tracing. Color coding for wires connected to the circuit boards is provided in Fig. 4-9 and 4-12. Color coding of wires connected to other components should be recorded prior to removal to facilitate replacement.

Capacitors. The capacitance value of a common disc capacitor or small electrolytic is marked in microfarads on the side of the component body. The white ceramic capacitors are color coded in picofarads using a modified IEEE code. See Fig. 4-2.

Test Points. Test point terminal locations are shown in Fig. 4-8. Transistor connections also serve as convenient test points. See Fig. 4-9.

Troubleshooting Chart

The Troubleshooting Chart contained in Fig. 4-3 can be used without disassembling the equipment. It will indicate the circuit or circuits most likely to contain the source of the trouble being investigated.

To use the chart, start at the top, working down and to the right. If a check provides a "yes" answer, proceed down along the solid line. If the answer to a check is "no", follow the broken line to the right. Exceptions to the direction of flow are indicated by arrows where they occur. Directions and questions are contained in rectangles. Probable trouble areas are indicated in triangles.

When checking the probable trouble area, associated leads, switches and other components should not be ignored. A transistor might be inoperative because of a defective resistor in series with it.

The chart is designed on the basis of single defects. Multiple problems may disrupt the logic, but it should still be effective in determining the problems, one at a time.

CORRECTIVE MAINTENANCE

General. Many electrical components are mounted in a particular way to reduce or control stray capacitance and inductance. Dressing of leads and orientation of parts should duplicate the original installation.

WARNING

Disconnect the 7A11 from the Oscilloscope before removing or replacing components.

A thorough cleaning should accompany any repairs, and a Performance Check or Calibration Procedure should be

satisfactorily performed after the repairs have been completed.

Parts Procurement

All parts used in this equipment can be purchased through Tektronix Field Offices or Representatives. However, replacements for standard electronic items can be readily obtained from local electronic parts stores.

When selecting replacement parts, it is important to remember that the physical size and shape of a component may affect its performance at high frequencies. All replacement parts should be direct replacements unless it is known that a different component will not adversely affect instrument performance. Before purchasing, consult the Electrical Parts List to determine the required specifications.

Special Parts. Some electrical parts are specially reworked, quality checked, or manufactured to fulfill a particular requirement. Most mechanical parts are common to the specific equipment. All electrical parts whose part numbers are preceded by an asterisk, and most mechanical parts, can therefore be obtained only through the Tektronix Field Office or Representative. Ordering information precedes the Electrical Parts List.

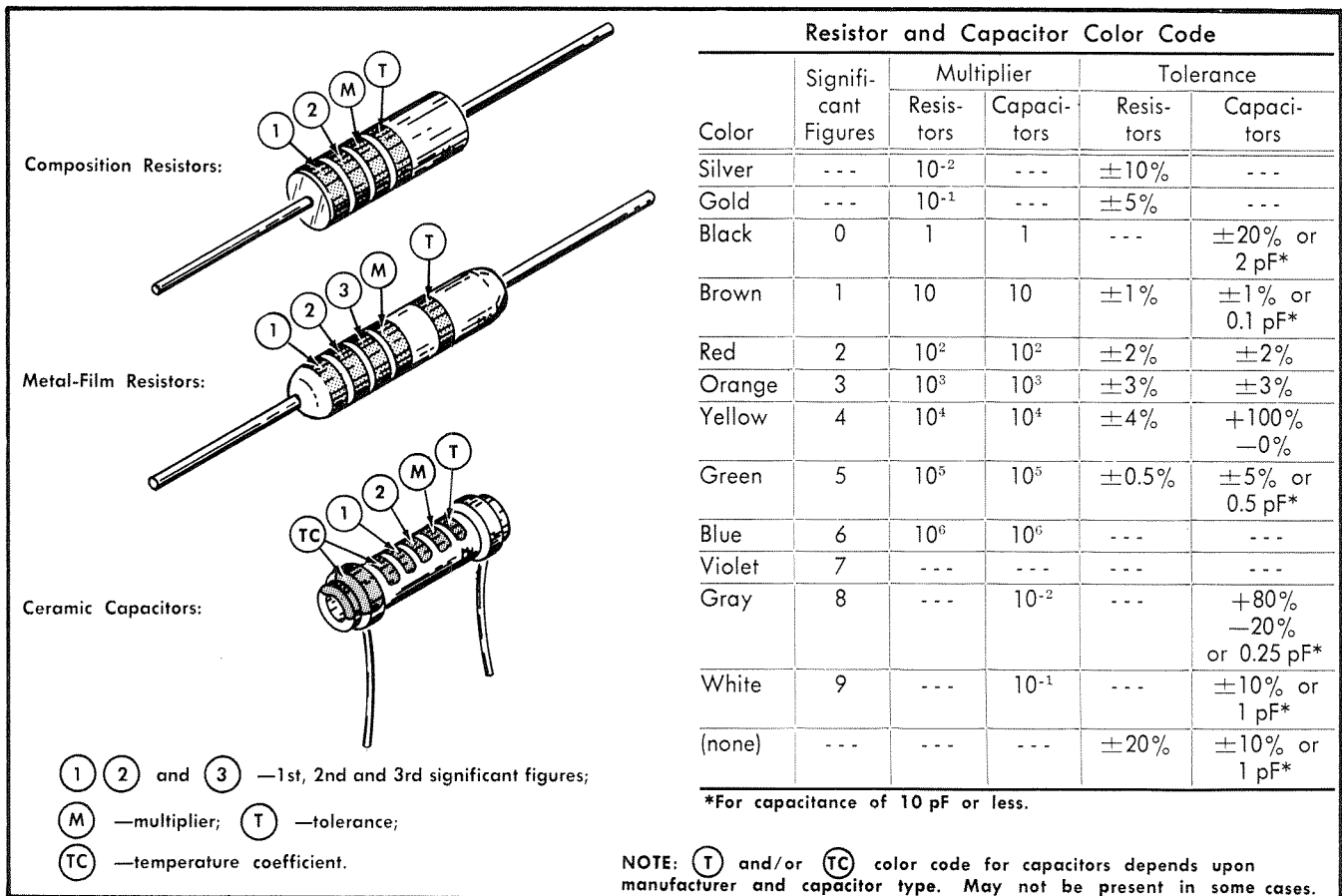

Fig. 4-2. Color code for resistors and ceramic capacitors.

TROUBLESHOOTING CHART

Equipment Setup: 7A11

POSITION
VOLTS/DIV
VARIABLE
OFFSET
POLARITY
BANDWIDTH
STEP ATTEN BAL

Centered
50 mV
CAL
OFF
+UP
FULL
Midrange
AUTO, AC, INT
1 ms

Time Base
Triggering
Time/Div

Oscilloscope
Intensity and Focus adjusted for sharp trace

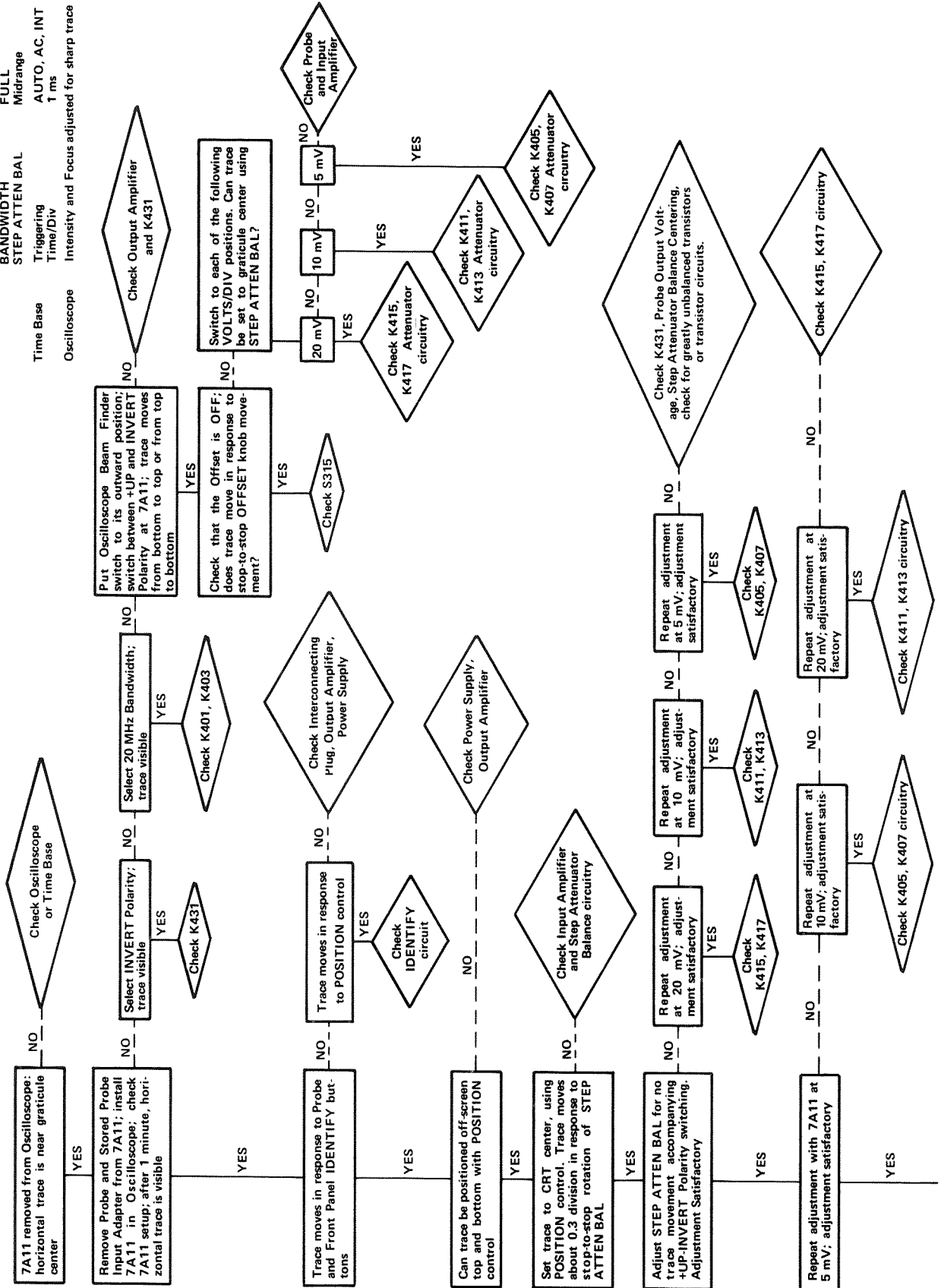

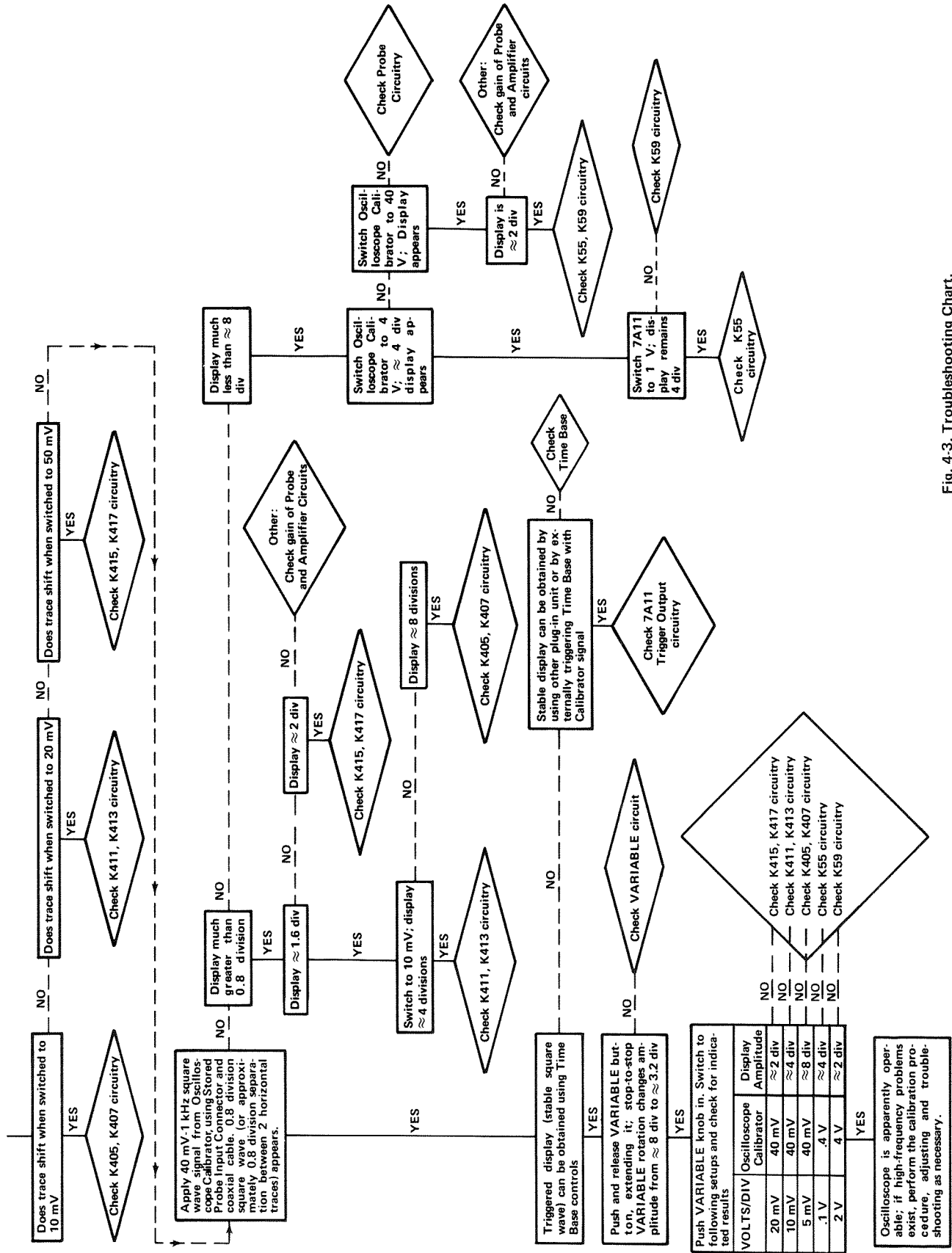

Fig. 4-3. Troubleshooting Chart.

Screwdriver Requirements

Some of the smaller screws in the Probe and Plug-In Unit require use of an extremely small-tipped phillips-head screwdriver. Snap-On® screwdriver #SSDEP 30 is recommended. In addition, a standard screwdriver with a 1/16 inch wide tip is required by one of the screws in the Probe.

Soldering Equipment and Techniques

Soldering Equipment. Ordinary electrical solder (rosin core) should be used for all circuit repairs. The soldering iron should be selected in accordance with the work being done, as follows:

Soldering on Plug-In Unit circuit board - 15 to 40 watt iron with a 1/16 to 1/8 inch tip.

Soldering to Probe circuit board - 15 watt iron with a 3/64 inch tip. Exception is that a 40 W iron with a 3/16 inch tip should be used on the cable tiedown strap.

Soldering to metal terminals such as on switches and potentiometers - 40 to 75 watt iron with 3/16 inch tip.

Component size and density demands the use of needle-nose pliers and needle-nose end nipper pliers when replacing components. Tweezers are also helpful. Heat sinks (such as small alligator clips) are invaluable for protecting components from heat damage, leaving both hands free for soldering. A hold-down aid can be made from a wooden dowel, 6 to 8 inches long and 1/4 to 3/8 inch in diameter. Shape one end like a pencil tip and the other end similar to a screwdriver tip. Note that the wood will absorb only a minimum of heat from the iron but will not guard against heat transfer to the parts being soldered. Flux remover solvent and cotton-tipped swabs are needed to remove flux from soldered connections on the plug-in unit circuit board. Use only water soluble detergents, ethyl, methyl or isopropyl alcohol on the Probe circuit board; other solvents may damage it.

A solder removing device such as an EDSYN SOLDA-PULLT®, Tektronix Part No. 003-0428-00, is extremely useful in removing solder from connections, expediting component removal and replacement.

Other soldering aids should be made or purchased to suit specific needs.

General Soldering Techniques. Keep the soldering iron well tinned and wiped clean. To avoid excessive heating of the general area around the connection, the iron should be

completely heated before being applied. When removing components, apply heat only long enough to allow the part to be removed easily. (Applying a small amount of solder between the tip and the joint will usually aid in heat transfer on difficult connections. This will decrease heating of the general area.) Use the extreme tip of needle-nosed pliers to avoid drawing off too much heat. When connecting components, heat the solder sufficiently to allow free flow. Apply the solder to the wire being joined, not to the soldering iron. Applying a small amount of solder between the iron and the wire will again aid in initial heat transfer. Once solder flows between the tip and the wire, the solder should be applied to the opposite side of the wire to complete the process. Do not use more solder than is necessary to make a neat and effective bond.

Use heat sinks between the bodies of components and the joint being soldered whenever small components and/or short leads are involved. After soldering has been completed, clip off excess wire, deflecting wire ends with a gloved finger or other device to avoid damage to fingers, eyes, or circuit components. Remove clipped leads from the chassis. Clean the newly soldered area with a cotton-tipped swab and ethyl, methyl, or isopropyl alcohol.

Circuit Board Soldering Techniques. Use a 15- to 40-watt iron with a 1/16 to 1/8 inch tip on the Plug-In Unit circuit board. Use a 15 watt iron with a 3/64 inch tip on the Probe circuit board, except for the cable tiedown strap, where a 40 watt iron with a 3/16 inch tip should be used. Keep the tip well tinned and clean. Do not overheat components or circuit board. Do not use excessive pressure.

To remove a component, grip a lead with the tip of a pair of needle-nosed pliers. Touch the tip of the soldering iron to the connection. When the solder melts, gently pull the lead from the board. If a clean hole is not left in the board, reheat it and remove the solder with a solder removing device; or bore it out gently with a tooth-pick or similar non-abrasive device.

Defective multiple-lead components that cannot be removed by the above process should first be removed by cutting the leads. Then remove the leads one at a time and clean the holes as necessary. If the leads are not accessible, remove the solder from each contact point with a solder removing device, then work the component out, applying heat alternately to the connections involved.

To replace components, first bend the leads to the proper shape. Cut the leads to proper size if the extra lead length interferes with installation or cannot be reached for cutting after installation. Insert the leads in holes and set the component to the position of the original part. Reheat

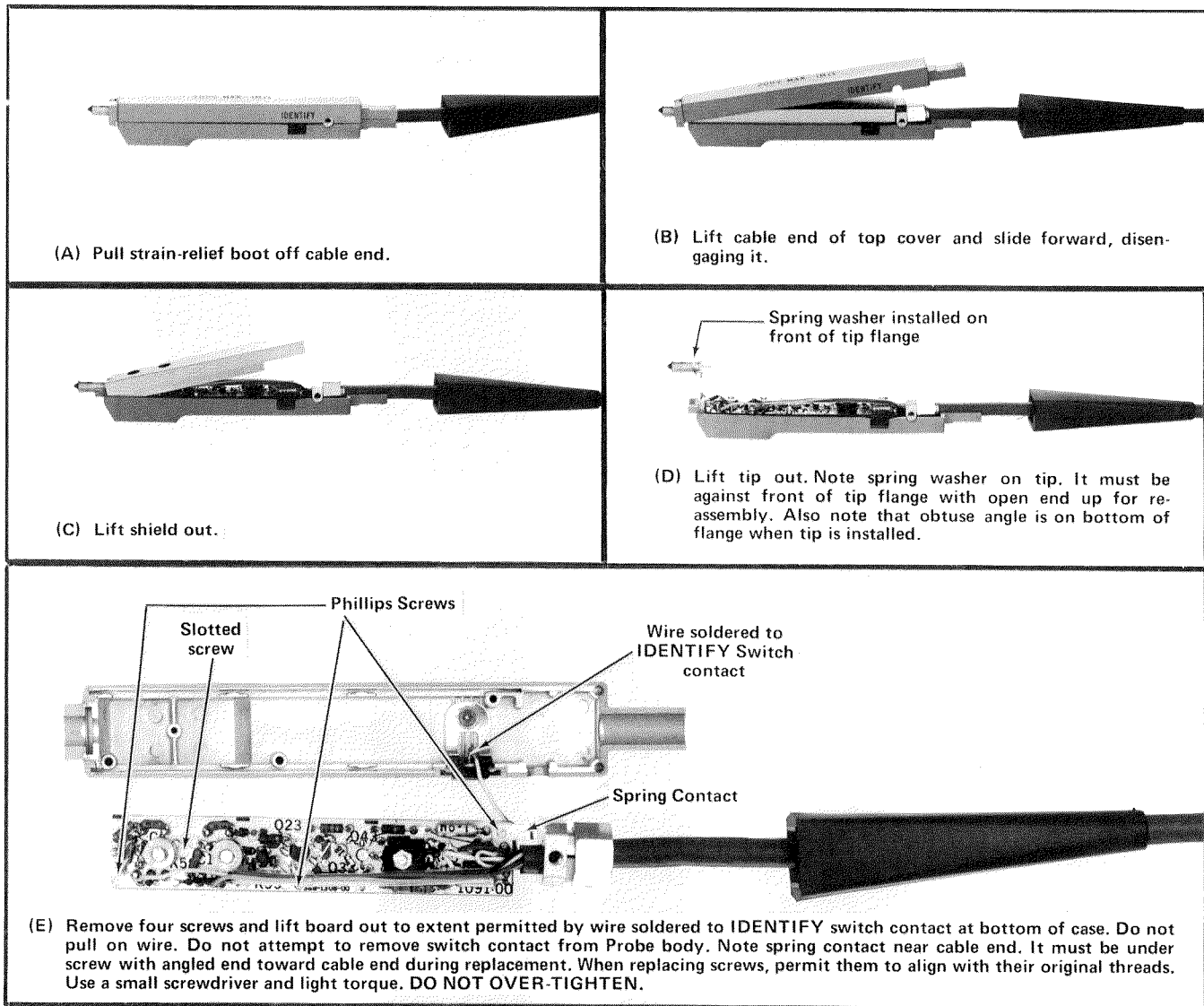

Fig. 4-4. Probe dis-assembly. Reverse the procedure for re-assembly.

holes if necessary for proper insertion of the part. Apply heat sinks to component leads as necessary. The tips of needle-nosed pliers serve as excellent heat sinks if only the component being installed needs protection. Apply the iron and a small amount of solder to the connection. Do not remove the iron until the solder flows freely. After removing the iron, hold the component steady until the solder is firm. Clip any excess wire. Clean the solder area with a cotton-tipped swab and flux remover.

Probe Data

Probe disassembly and assembly instructions are provided in Fig. 4-4. Component locations and wire connections appear in Fig. 4-5 and 4-7. Because of size, voltage re-

quirements and frequency requirements, it is recommended that Probe repairs be referred to a Tektronix Repair Center. When repairs are made, the following precautions must be observed regarding the Probe:

(1) Except for troubleshooting or calibrating, do not disassemble, assemble, or otherwise work on the Probe while the 7A11 has power applied to it.

(2) The relays are plug-in type and are installed in the bottom of the board. All other components are soldered in place. To remove a relay, insert the tip of a small-bladed screwdriver between the relay and the board and

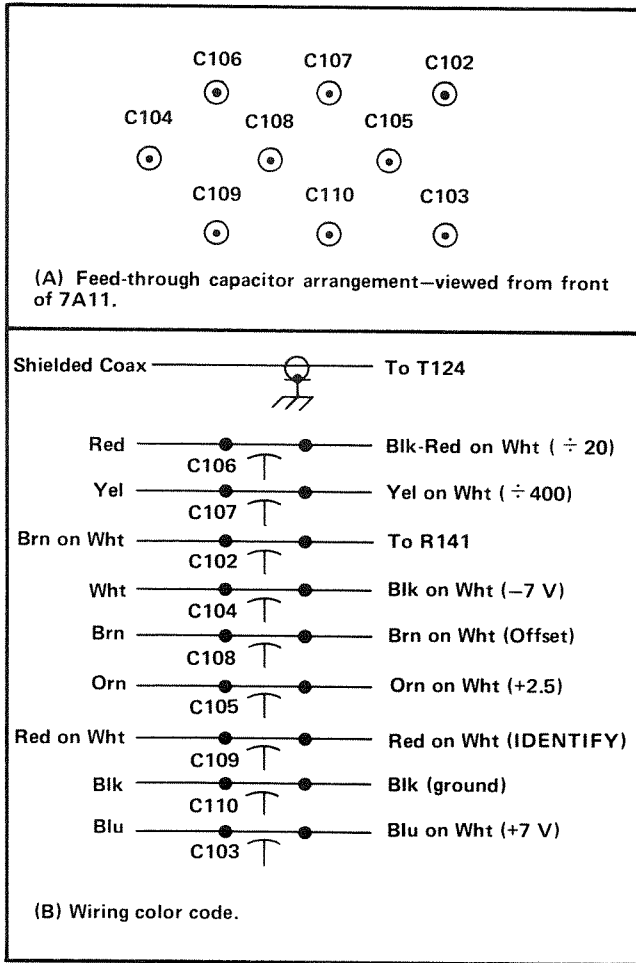

Fig. 4-5. Probe cable connections within Plug-In Unit.

twist the screwdriver to lift the relay slightly. Repeat on the other side of the relay. Continue the process until the relay is lifted evenly from the socket.

(3) Soldering on the board must be done quickly and neatly, using a 15 watt iron, a 3/64 inch nickel-plated tip, and common electrical solder. One exception to this is when soldering the Cable Tiedown Strap in place. Then a 40 watt iron with a 3/16 inch tip should be used. Heat the iron thoroughly; then solder quickly to avoid damage to either the board or the cable dielectric material. All solder connections should be checked under a magnifying glass, looking for poor connections, short circuits and damaged components.

(4) Water-soluble detergents, ethyl alcohol, methyl alcohol, or isopropyl alcohol are recommended for cleaning the board, if cleaning is necessary. **Other materials may damage the circuit board and should not be used.**

(5) During re-assembly, install the spring washer and spring contact in place properly, as noted in Fig. 4-4.

(6) When screws are re-installed, they should be threaded into the original female threads. Excessive tightening of the screws should be avoided. Use a screwdriver which has a small diameter handle, and use very light torque.

Plug-In Unit Data

Pin Connectors. Pin connectors should not be subjected to excessive pressure; repeated bending may cause them to break. Repair kits containing tools, instructions, and replacement pins are available through Tektronix Field Offices, under Part No. 050-0477-00.

Matching the triangles on the male and female sections of multiple-pin connectors provides proper connector alignment, as shown in Fig. 4-6.

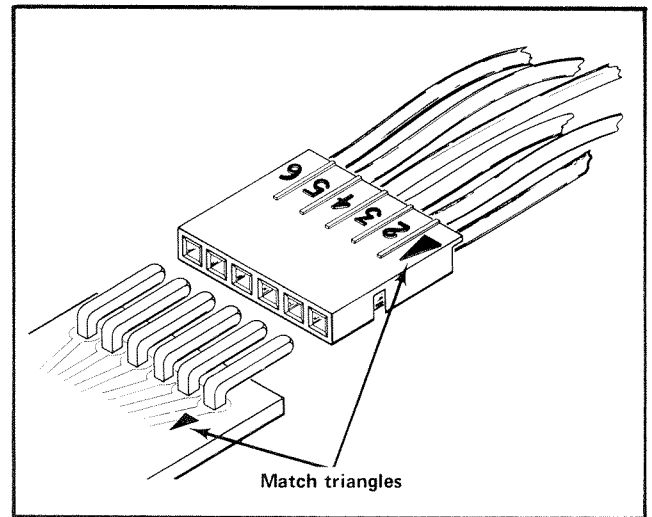

Fig. 4-6. Multiple pin connector alignment coding.

Left Side Cover Removal. The transistor-side of the circuit board is under the left side cover, which is of the press-fit type. To remove, grasp it at the back of the unit and gently but firmly lift it away from the chassis.

Cable Connector Cover. Located at front of right side of unit. Remove two screws and lift outward.

Front Panel Removal. Remove all front panel knobs, using an allen wrench on the POSITION, VOLTS/DIV, VARIABLE and Offset COARSE and FINE knobs. (The VOLTS/DIV and Offset COARSE knobs each have two screws.) The IDENTIFY and STEP ATTEN BAL knobs are press-on type. Remove the nut and washer from the OFF-SET OUT connector, using a Spintite® wrench. Spring the front panel free from the front casting by using a wide, thin blade at the top and the bottom.

Front Casting Removal. The front panel must be removed first. Then remove the screws from the four corners. Individual components must be unsoldered or disconnected for complete removal of the front casting.

Front Panel Controls. POSITION - Remove the set screw from knob and remove the hex nut from the front. Offset COARSE, FINE - Remove three set screws from the knobs and remove the hex nut from the front. STEP ATTEN BAL - Pull the knob off the front, remove set screw from the mounting sleeve behind the front casting, and remove the front panel. Then remove screws from the front casting, and move the casting to the front enough to remove the potentiometer.

VOLTS/DIV - The wafers on the cam are number-coded on the schematic diagrams. The number indicates the cam position in the switch assembly, counting from the front (mounting end). Access to the cam switch can be obtained by removing the Cable Connector Cover at the front of the right side of the Plug-In Unit. The switch cover can be removed after removing two screws from its top.

To thoroughly inspect the switch contacts, the cam assembly of the switch must be removed. Remove the VARIABLE knob and shaft after loosening the allen screw at the back of the cam switch housing. Remove the nut from the back of the front panel VOLTS/DIV switch bushing. Pull the cover from the left side of the 7A11 and remove the four screws which hold the cam assembly in place. Lift the cam assembly away from the circuit board and move it toward the back of the 7A11 to fully remove it. Use caution so that the board-mounted contacts are not damaged. It is recommended that the cam assembly cover be left in place when the assembly is removed from the board. The cover will hold the assembly together.

Replacement of the cam switch contacts requires special tools and careful attention to alignment and spacing. It is recommended that repairs be done by a Tektronix Repair Center. In repairing defective switches, a repair kit and a skilled technician are necessary ingredients. The repair kit (which includes tools, instructions, replacement contacts, and lubricant) can be obtained from Tektronix Field Offices under Part No. 006-1416-00.

VARIABLE - Potentiometer can be removed by removing the Cable Connector Cover, unscrewing the nut from the front of the potentiometer housing, unscrewing the .050 inch allen set screw at the front of the potentiometer shaft, and sliding the potentiometer out the back. To remove the VARIABLE switch control assembly, first remove the potentiometer, then loosen the set screw at the front of the switch assembly, pull the VARIABLE shaft forward and lift the control assembly out. The housing for the switch contact and slide is not removable, since it is heat-welded in place. To inspect the switch contacts, remove the VOLTS/DIV cam assembly and move the slide forward out of its housing; the VARIABLE potentiometer does not have to be removed.

Pushbutton Switches: Except for pin connector and lamp replacement, these switches are not repairable. To replace a lamp, remove the screw and metal cover from the rear of the switch housing. Unsolder and replace the lamp, installing the new one in an identical position. See the Pin Connector topic for pin connector repairs.

Pushbutton switches can be removed as follows: Remove the plug-on connector from the rear of the switch; remove the instrument front-panel according to instructions appearing elsewhere in this section; remove the one screw (from the front casting) which holds the switch in place.

Circuit Board. Component locations and wire color coding are shown in Fig. 4-8 through 4-12. Transistor terminals are identified in Fig. 4-9. Circuit board access is explained in the following topic.

Circuit Board Access. Access to the transistor-side can be obtained by pulling the left side cover off. For limited access to the reverse side, proceed as follows:

- (1) Remove the cable connector cover.
- (2) Open the Probe Accessories case, remove the two nuts which hold it in place, and lift it out.
- (3) Remove the nut and cable clamp in the back near the bottom.
- (4) Lift the rear of the outer shield, freeing it from the studs. Then remove it, manipulating it as necessary.

Total access to the back of the board can be obtained as follows:

- (1) Remove the outer shield as just described.

- (2) Remove the front panel and the two corner screws at the bottom of the front casting.
- (3) Remove the two corner screws at the bottom of the plastic connector-guide at the back of the unit.
- (4) Remove the seven screws which hold the bottom rail in place, and remove the bottom rail.
- (5) Remove the Stored Probe Input Adapter housing.
- (6) Remove the VARIABLE shaft after loosening the set screw at the rear of the VOLTS/DIV switch housing.
- (7) Remove the two nuts which hold the cable connector mounting bracket to the inner shield.
- (8) Unsolder the two resistors connected to the GAIN potentiometer.
- (9) Unsolder the toroid leads from the coaxial cable and from the leadless capacitor.
- (10) Remove the 5 screws from the inner shield.
- (11) Remove the two screws and nuts which hold the inner shield to the top rail.

(12) Slide the inner shield out the bottom, lifting the Probe cable connector mounting bracket away from the shield as necessary to obtain clearance for the Cable Connector Cover mounting post.

Board Removal. Proceed as follows:

- (1) Remove the left side cover plate and the right side inner and outer shields as previously described.
- (2) Remove the two screws which remain in the rear plastic connector guide.
- (3) Remove all pin connectors and cable clamps, pushing the cable clamps out from the back of the board.
- (4) Remove the four screws which hold the VOLTS/DIV cam assembly in place.
- (5) Remove the 3 screws which hold the top of the circuit board to the top rail.
- (6) Remove the circuit board. If desired, the plastic connector guide can be removed from the back of the board by springing out and back on each of the two ears.

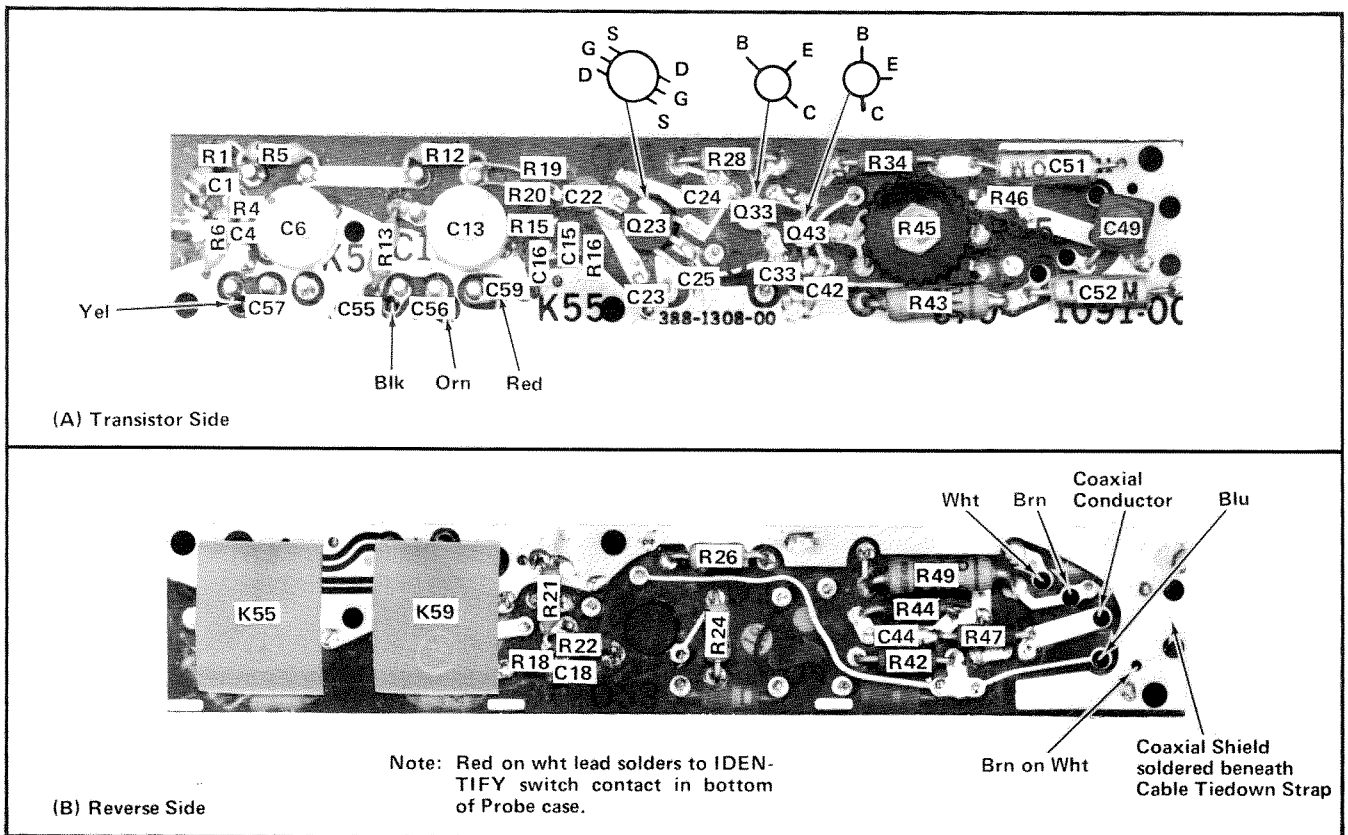

Fig. 4-7. Component locations and wire color-code; Probe circuit board.

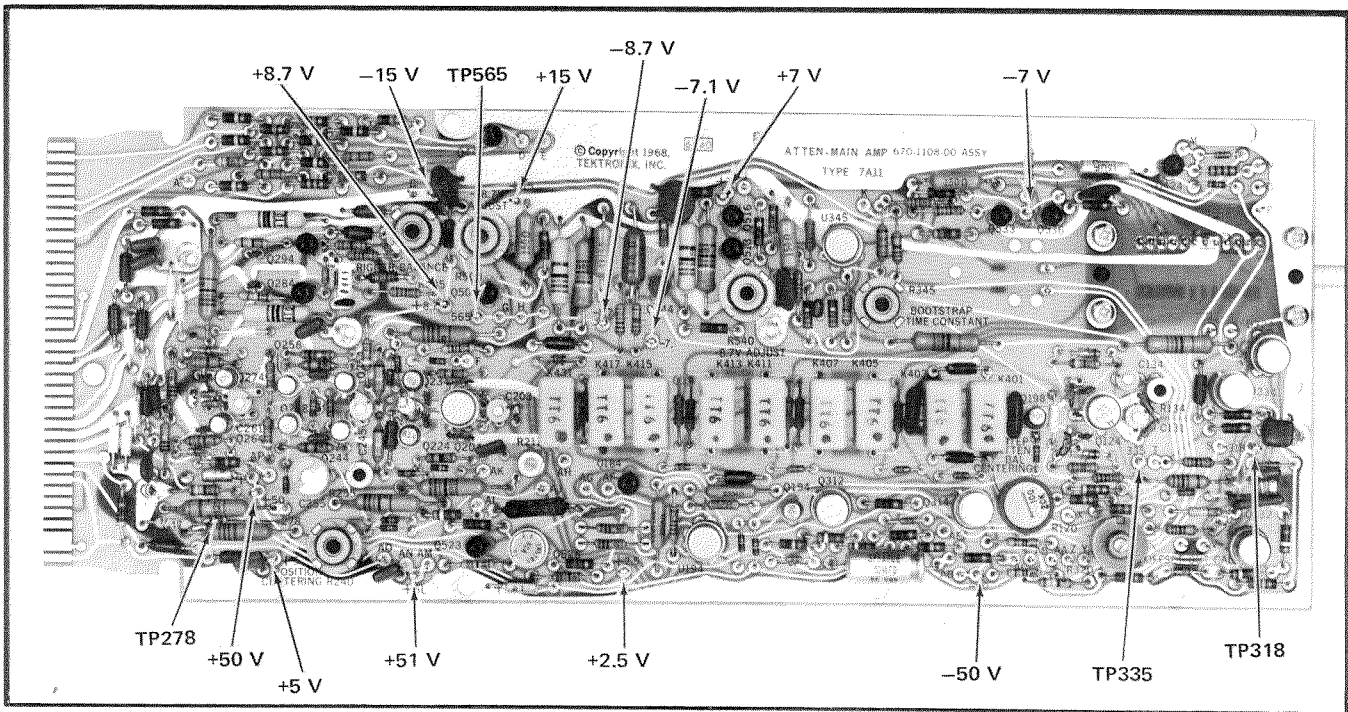

Fig. 4-8. Test Point locations within Plug-In Unit.

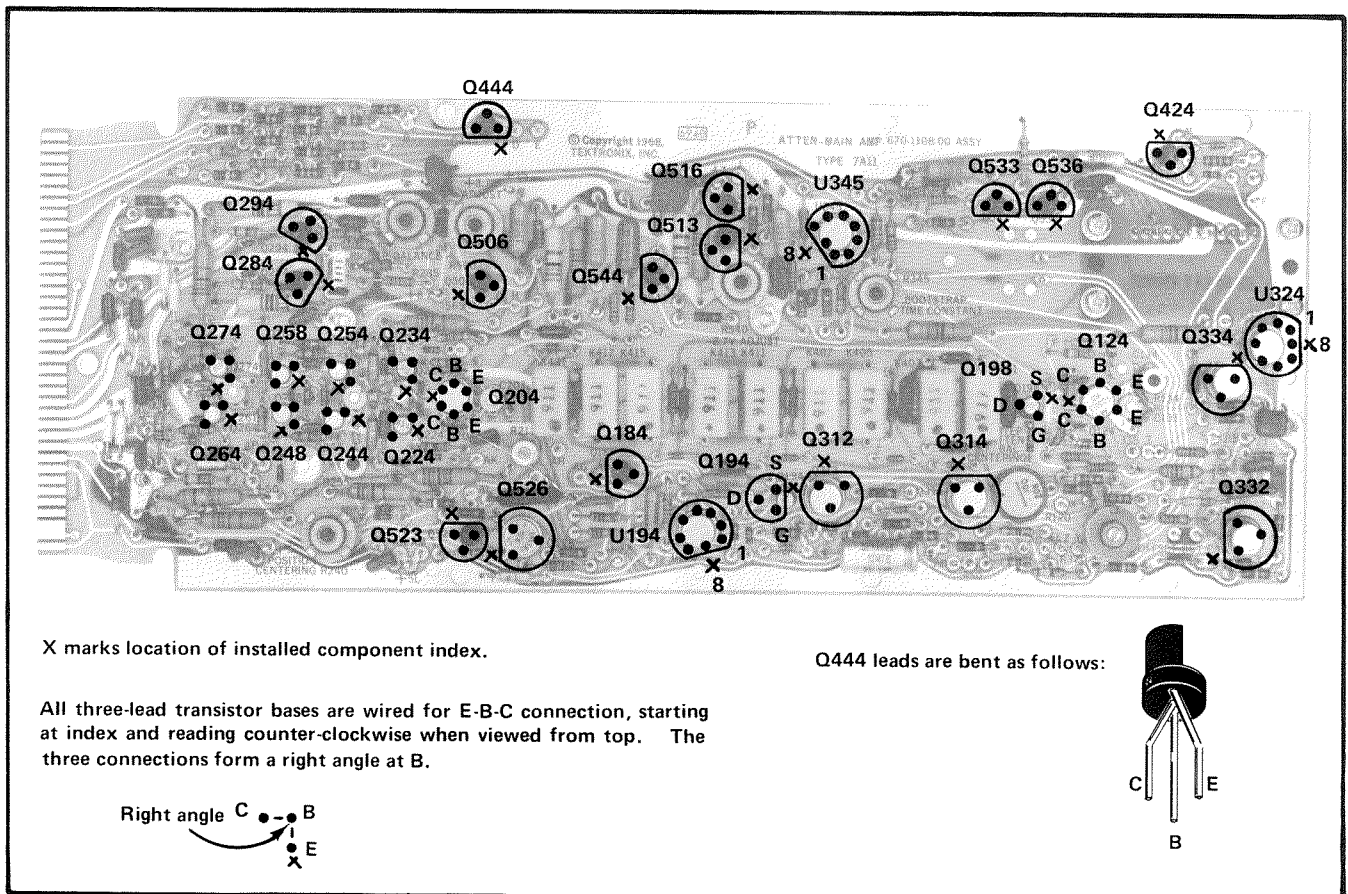

Fig. 4-9. Transistor and integrated-circuit placement within Plug-In Unit.

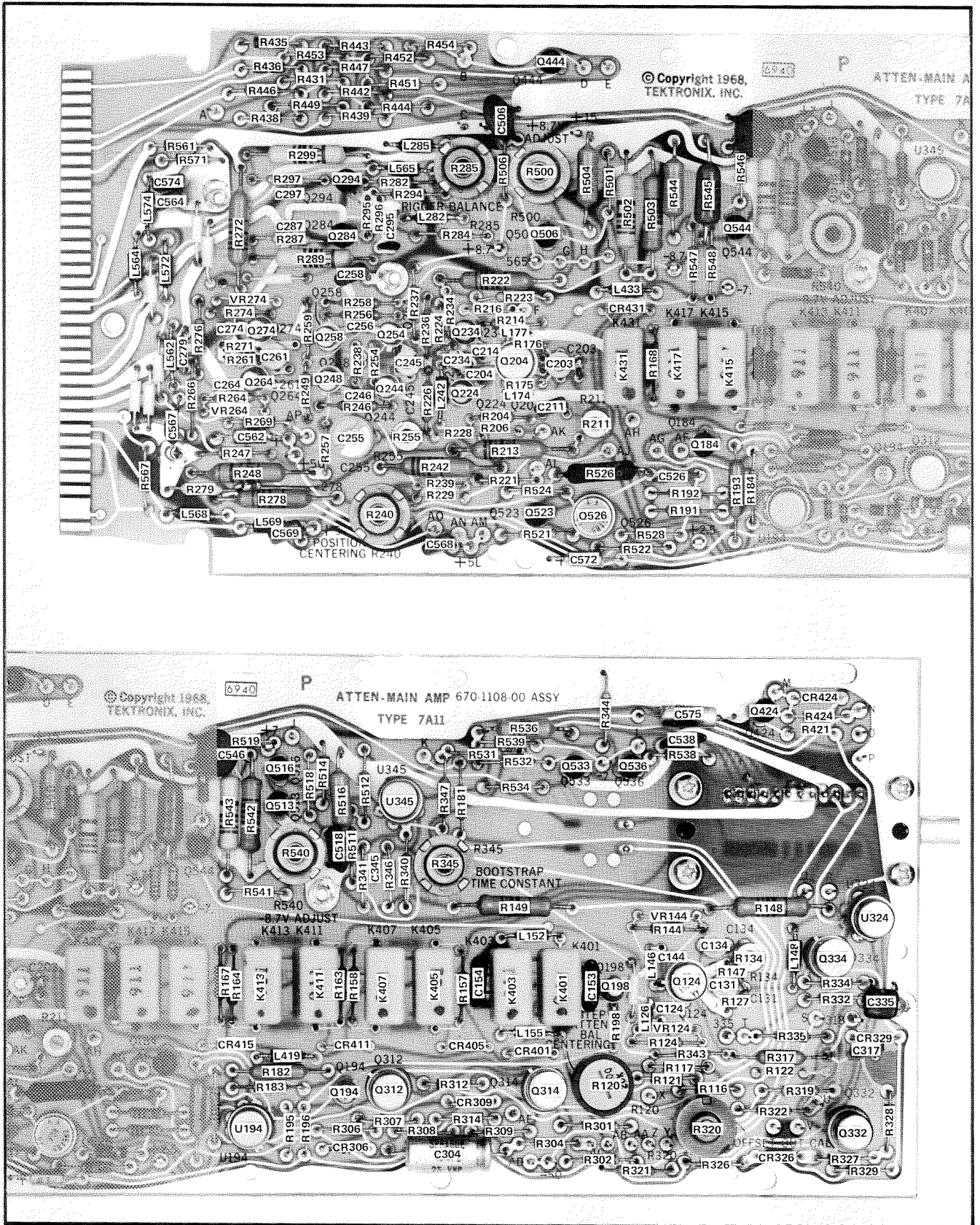

Fig. 4-10. Component locations on Plug-In Unit circuit board; transistor side.

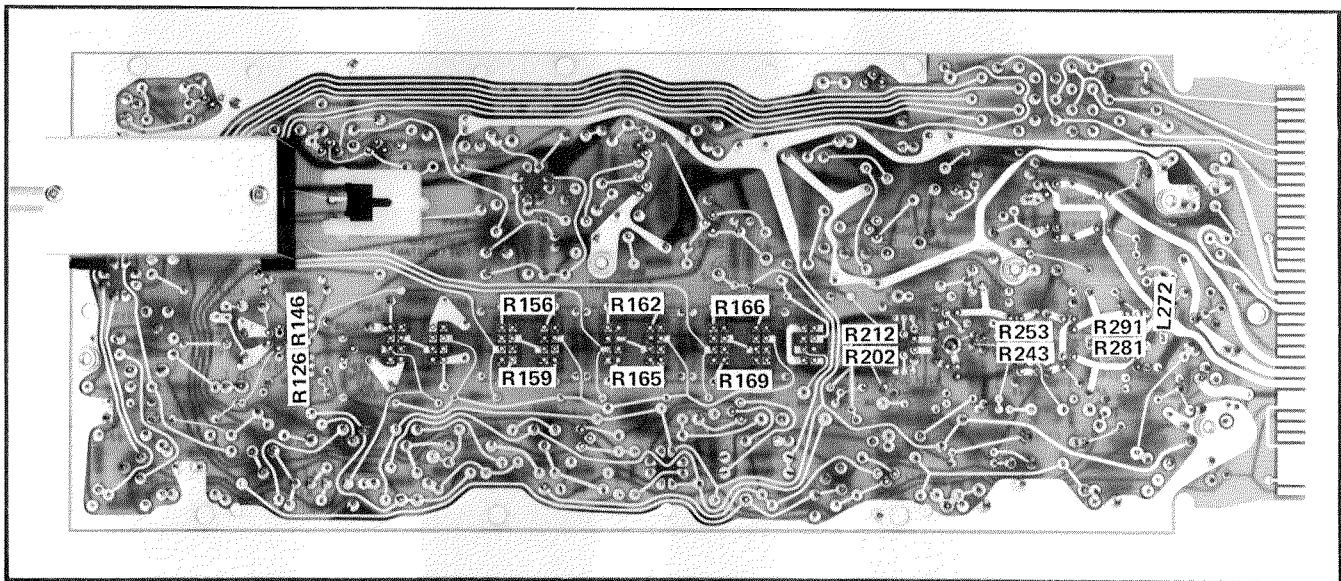

Fig. 4-11. Component locations on Plug-In Unit circuit board; reverse side.

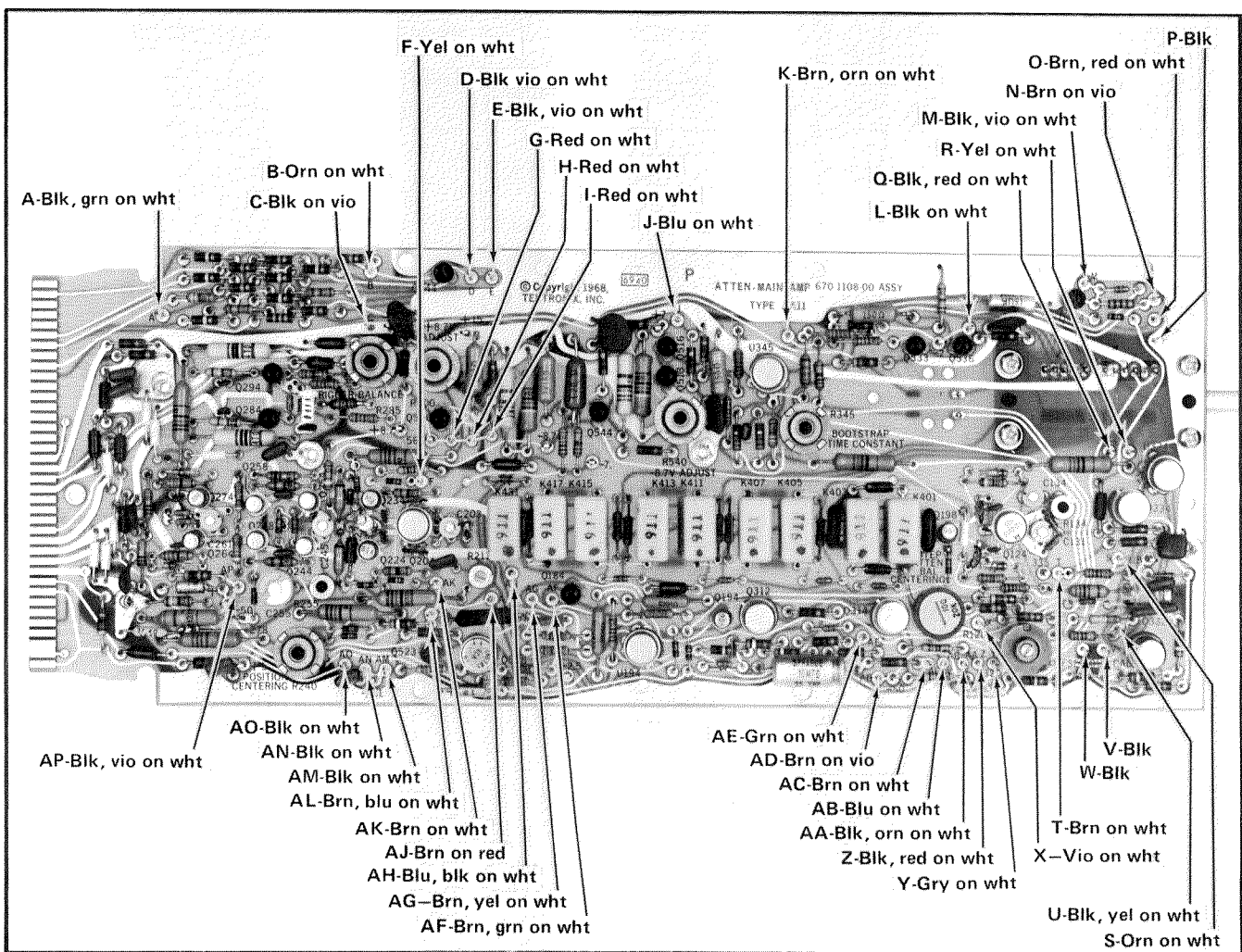

Fig. 4-12. Wire color codes for Plug-In Unit circuit board.

SECTION 5

PERFORMANCE CHECK/CALIBRATION

Change information, if any, affecting this section will be found at the rear of the manual.

General

It is recommended that the 7A11 Amplifier be checked for performance and/or Calibrated every six months or every 1000 operating hours, whichever occurs first. It should be cleaned and inspected at the same time in accordance with instructions contained in the Maintenance Section.

If a complete procedure is being performed, equipment need not be reset between steps except as specifically directed. If a partial procedure is being performed, it may be necessary to refer to a preceding step to obtain setup instructions.

Names of 7A11 controls and adjustments are written in capital letters. Names of controls associated with other equipment have only the first letter capitalized.

Calibration Procedure

Calibration must be performed with ambient temperature between +20° C and +30° C. If a calibration specification cannot be met, the setup should be rechecked. Then troubleshooting procedures should be used, keeping in mind that an error in a preceding step may be causing the trouble.

Performance Check

To check the performance of a 7A11, perform all steps within the procedure except for those which pertain specifically to "Calibration Procedure only". If a check is outside the allowable tolerance, refer to the Calibration procedure to correct the situation.

Calibration Index and Record

An index is contained at the beginning of the calibration procedure. It can be used as a check-off list for record purposes, in which case it should be duplicated to permit retaining an unmarked original copy.

The index also contains a brief statement about the setup and requirements for each step. It can be used as a short-

form calibration procedure by technicians familiar with calibrating the 7A11.

Equipment Required

Table 5-1 lists equipment required for the procedure. All equipment must be operating within its specified capability. It should be noted that some of the equipment is considered optional and is left to the discretion of the person calibrating the 7A11. Refer to the notes in Table 5-1 for further information regarding the optional items. The equipment is illustrated in Fig. 5-1 and 5-2.

TABLE 5-1

Equipment Required

Item No.	Equipment (See Fig. 5-1 and 5-2)
1	7000-Series Oscilloscope equipped with 7B-Series Time Base.
2	Sampling System; Tektronix 560-Series Oscilloscope, 3S1 Sampling Unit and 3T2 Sampling Sweep Unit recommended.
3	DC Voltmeter, 2 through 10 V; accurate to within 0.1%; John Fluke Model 825A appears in accompanying illustrations.
4	Square Wave Generator, 25 Hz through 250 kHz repetition rates, risetime less than 1 ns, Fast Rise amplitude at least 0.5 V into 50 Ω, High Amplitude output at least 12 V into 50 Ω; Tektronix Type 106 Square Wave Generator recommended.
5	¹ Amplitude Calibrator, 20 mV through 100 V square wave output in 2-5-10 sequence and 0.5 V DC output, accurate to within 0.25%; Amplitude Calibrator And Comparator, Tektronix Part No. 067-0502-01 recommended.
6	² Constant Amplitude Sine Wave Generator, 80 mV at 50 kHz reference frequency and at 20 MHz; Tektronix Type 191 Constant Amplitude Signal Generator recommended.

¹ Optional; not required if 2% gain and offset voltage accuracy is adequate.

² Used with optional step 22.

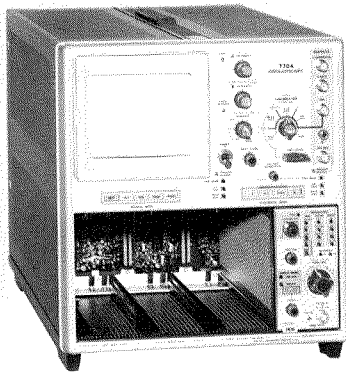

(1)

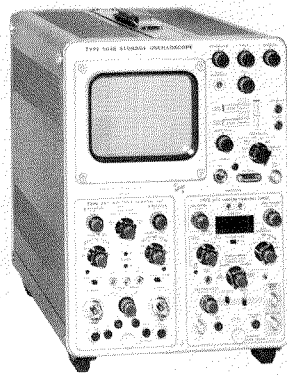

(2)

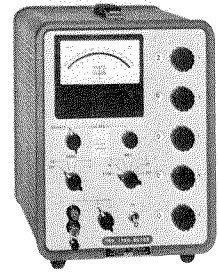

(3)

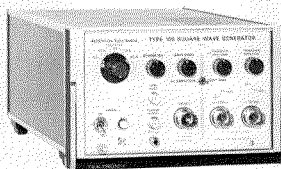

(4)



(5)



(6)

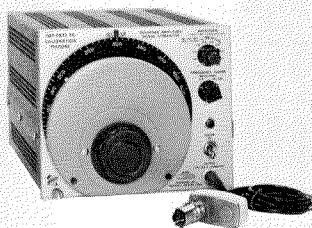

(7)



(8)

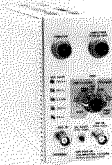

(9)



(10)

Fig. 5-1. Test equipment required. See Table 5-1.

TABLE 5-1 (cont)

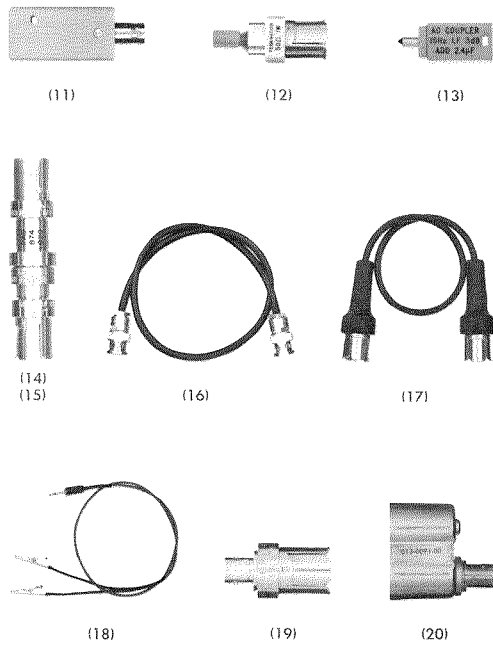

Item No.	Equipment (See Fig. 5-1 and 5-2)
8	Low Frequency Sine Wave Generator, at least 0.4 V at 15 Hz; General Radio Oscillator 1310A appears in accompanying illustrations. <i>SNA</i>
9	Calibration Fixture, Signal Standardizer; Tektronix Part No. 067-0587-00. ✓
10	Plug-in Extender, Tektronix Part No. 067-0589-00. ✓
11	Stored Probe Input Adapter (Removable component of 7A11 Amplifier).
12	Termination/Adapter, 50 Ω, GR to Probe Tip (7A11 Amplifier standard accessory).
13	AC Coupler (7A11 Amplifier standard accessory).
14	10X 50 Ω Attenuator equipped with GR connectors (2 required); Tektronix Part No. 017-0078-00.
15	5X 50 Ω Attenuator equipped with GR connectors; Tektronix Part No. 017-0079-00.
16	Coaxial Cable, 42 inch, 50 Ω; Tektronix Part No. 012-0076-00.
17	connectors (2 required); Tektronix Part No. 017-0505-00.
18	Cable Assembly, miniature phone plug one end, alligator clips other end; (7A11 Amplifier Standard Accessory).
19	GR to BNC-female adapter (two required); Tektronix Part No. 017-0063-00.
20	Banana Plug to BNC Adapter; Tektronix Part No. 013-0094-00.

Fig. 5-2. Accessories Required. See Table 5-1.

TABLE 5-1 (cont)

Item No.	Equipment (See Fig. 5-1 and 5-2)
7	³ Constant Amplitude Sine Wave Generator, 80 mV at 3 MHz reference frequency and at 167 MHz and 250 MHz; Constant Amplitude Signal Generator, Tektronix Part No. 067-0532-00 recommended.

³ Used with optional steps 21 and 22.

NOTES

CALIBRATION INDEX AND RECORD

7A11 Serial Number:

Calibrator:

Date Calibrated:

1. Check/Adjust Power Supply Voltages Page 5-7
 +8.7 V \pm 87 mV, (+8.7 V ADJUST R500); -8.7 V \pm 87 mV, (-8.7 V ADJUST R540); -7.1 V \pm 71 mV, -7 V \pm 0.35 V, +7 V \pm 0.35 V, +2.5 V \pm 0.25 V, (not adjustable).
2. Check/Adjust Step Attenuator Balance Page 5-7
 With front-panel STEP ATTEN BAL at midrange, adjust STEP ATTEN BAL CENTERING R120 for minimum trace shift accompanying POLARITY + UP/INVERT switching.
3. Check/Adjust Position Centering; Check POSITION Range Page 5-8
 With terminals F and AK disconnected, adjust POSITION CENTERING R240 to set trace to center of graticule. Using OFFSET, check for 8 ± 0.8 divisions upward and downward deflection range of POSITION control.
4. Check/Adjust Mid-Frequency Response Page 5-9
 At 10 mV and 1 ms/div, with 200 Hz fast rise square wave applied from Type 106, adjust R211 and BOOTSTRAP TIME CONSTANT R345 for optimum squareness at top left corner. Aberrations within $\pm 1\%$ peak to peak.
5. Check/Adjust 93 Ω Termination Page 5-9
 At 10 mV and 5 ns/division, with 100 kHz fast rise square wave applied from Type 106, adjust TERMINATION R45 (in Probe) for minimum step at approximately 25 ns after start of step function.
6. Check/Adjust Gain; Check Variable Gain Range Page 5-11
 Adjust GAIN (front panel) at 0.1 V/DIV. Check all positions for accuracy within 2% using Calibrator accurate to within 0.25%, or check for accuracy within 3% using Oscilloscope Calibrator.
7. Check/Adjust Offset Voltage Page 5-12
 OFFSET OUT voltage magnitude within 0.5 mV +1% of input voltage being offset. OFFSET RANGE of -1 V $\pm 10\%$ to +1 V $\pm 10\%$.
8. Check Input Gate Current Page 5-13
 At 5 mV, .05 division or less trace shift accompanying attaching or removing the 50 Ω Termination/Adapter.
9. Check Drift With Time Page 5-13
 Warmup time at least 20 minutes. Drift within 0.1 division during any 1 minute; within 0.3 divisions during any 1 hour.
10. Check IDENTIFY Operation Page 5-13
 Trace shift accompanying Probe or front-panel IDENTIFY button operation equals approximately 1/4 division.
11. Check AC-Coupled Low-Frequency Response Page 5-13
 3 dB or less attenuation at 15 Hz with AC Coupler in place.
12. Check/Adjust Transient Response Page 5-14
 Adjust C134, R255, C255, C203, C245, C261, C234 at 10 mV for transient response within $\pm 2\%$, using 5 division display of Fast Rise square wave from Type 106 Square Wave Generator, viewed through Extender on Sampling System. Check for .18 division or less deviation of 6 division square wave displayed on 7000-Series Oscilloscope CRT at 5, 10, 20 and 50 mV/DIV under setups listed in Table 5-9.
13. Check/Adjust Probe Input Compensation Page 5-19
 At 5 μ s/division with 6 division, 250 kHz Hi Amplitude square wave applied from Type 106, adjust C13 at .2 V/division and C6 at 2 V/division. Aberrations within ± 0.2 divisions.
14. Check Noise Page 5-20
 Tangentially measured noise should be within 0.1 division at 5 mV/division.
15. Check Fast Transient Response and Risetime Page 5-21
 8 division square wave applied to 7A11 from Type 106; displayed on Sampling System (through Extender); aberrations in first 80 ns should be within $\pm 3\%$ (6% peak to peak) of reference amplitude at 5, 10, 20 and 50 mV/division and within $\pm 4\%$ (8% peak to peak) at .1 V/division. Risetime computed from Fig. 5-18 should be 1.4 ns or less.

16. Check Positioning Effect Upon Aberrations Page 5-22

Using 8 division sampling system display of Type 106 Square Wave Generator Fast Rise signal (applied through 7A11 and Extender), check for 10% or less change in aberrations accompanying 8 division change in step-function position.

17. Check/Adjust Trigger Circuit Balance Page 5-24

Adjust TRIGGER BALANCE R285 for trigger circuit outputs within 50 mV of each other when display signal outputs are differentially balanced.

18. Check Trigger-Circuit Output Amplitude Page 5-24

Within 10% of display signal output amplitude.

19. Check Trigger Circuit Transient Response Page 5-25

At 50 mV with Type 106 Square Wave Generator Fast Rise signal applied, check for aberrations within $\pm 6\%$, 10% peak to peak.

20. Check Trigger Signal RisetTime Page 5-25

At 50 mV with Type 106 Square Wave Generator Fast Rise signal applied, check for 2.1 ns or less risetime, using Fig. 5-18.

21. Check Trigger Circuit Frequency Response (Optional) Page 5-25

AT 50 mV/DIV with signal applied from 067-0532-00 Constant Amplitude Signal Generator, check for 3 dB or less attenuation at 167 MHz.

22. Check Display Signal Circuit Frequency Response (Optional) Page 5-26

At 50 mV/DIV with signal applied from 067-0532-00 Constant Amplitude Signal Generator, check for 3 dB or less attenuation at 250 MHz in Full Mode, at 20 MHz ± 2 MHz in 20 MHz Mode.

NOTES

Horizontal lines for taking notes.

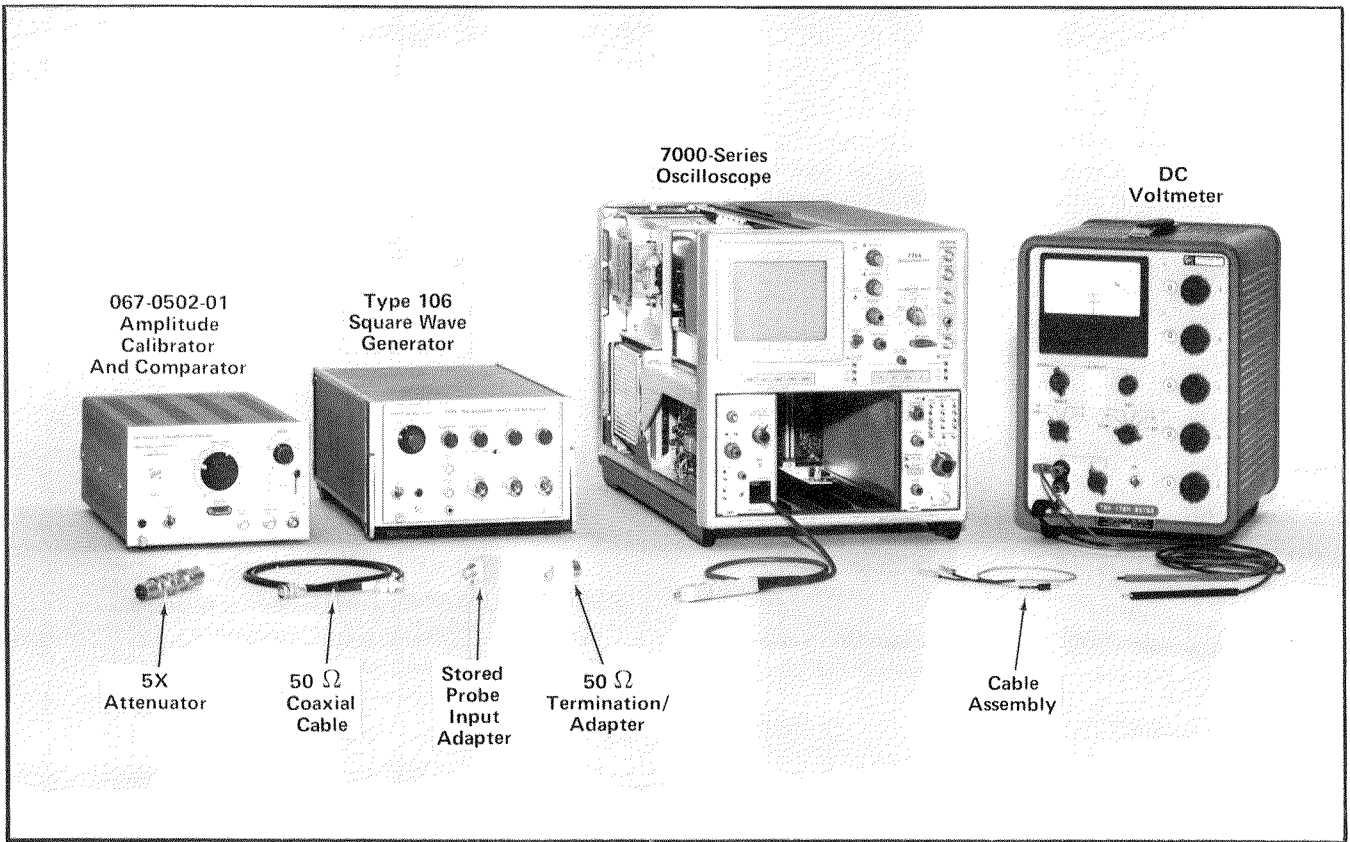

Fig. 5-3. Equipment for steps 1 through 8.

DETAILED PROCEDURE

Preliminary

- a. Energize all test equipment to permit adequate warm-up.
- b. (Calibration Procedure only.) Remove the left-side cover from the 7000-Series Oscilloscope and from the 7A11 Amplifier.
- c. Remove the Probe and Stored Probe Input Adapter from the 7A11.
- d. Install the 7A11 directly into the 7000-Series Oscilloscope.
- e. Energize the 7000-Series Oscilloscope.
- f. Set the equipment controls as listed in Table 5-2.

TABLE 5-2

Preliminary Control Settings

7A11	
POSITION	Midrange
OFFSET	OFF
POLARITY	+ UP
BANDWIDTH	20 MHz
VOLTS/DIV	10 mV
VARIABLE	CAL
7B-Series Time Base	
Triggering Mode	Auto
Coupling	AC
Source	Int
Position	Centered Display
Time/Div	1 ms
Magnifier	X1

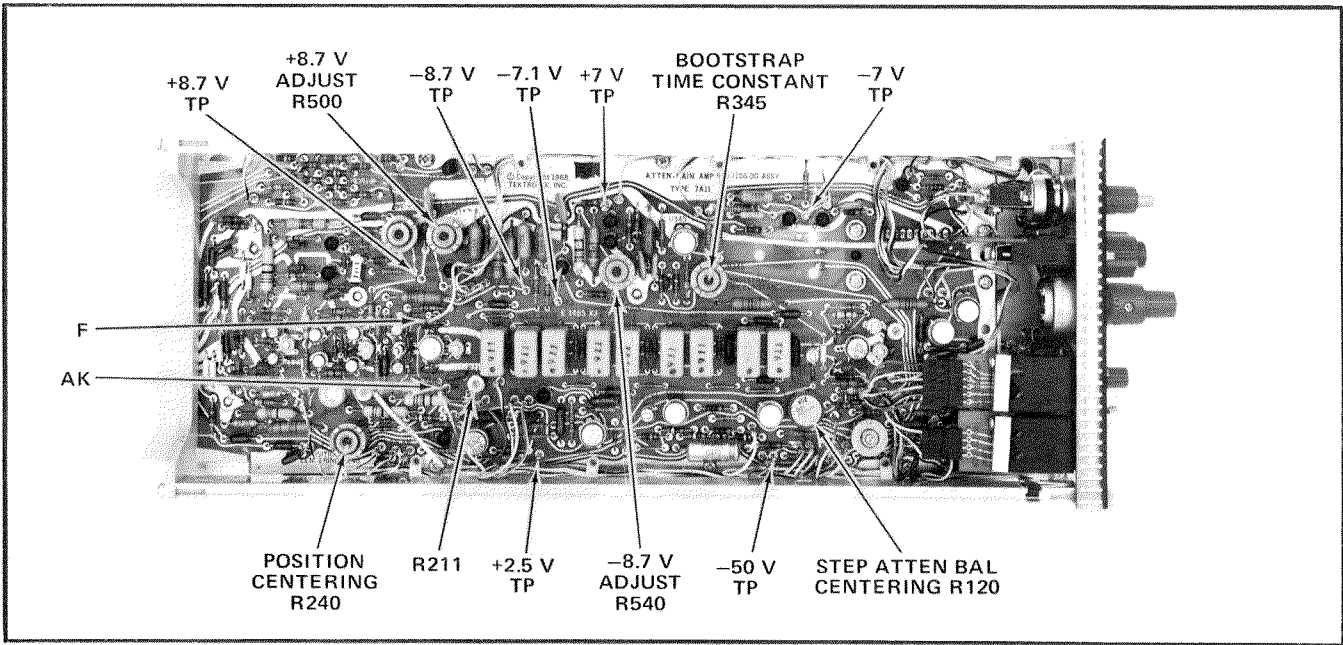

Fig. 5-4. Test point and adjustment locations for steps 1 through 4.

1. (Calibration Procedure Only) Check/Adjust Power Supply Voltages (+8.7 V ADJUST R500; -8.7 V ADJUST R540)

REQUIREMENT: +8.7 V $\pm 1\%$; -8.7 V $\pm 1\%$; -7.1 V (-7.07 V) $\pm 1\%$; +7 V $\pm 5\%$; +2.5 V $\pm 10\%$.

a. Equipment arrangement appears in Fig. 5-3; control settings are given in Table 5-2.

b. CHECK—Voltages. Using the DC Voltmeter (item 3), check the voltages listed in Table 5-3. Test points are shown in Fig. 5-4.

c. ADJUST—+8.7 V ADJUST, R500, and -8.7 V ADJUST, R540, (Fig. 5-4) as necessary to have the applicable power supplies within allowable values. Note that R540 also controls the -7.1 V supply. The +7 V, -7 V, and +2.5 V supplies are not adjustable.

2. Check/Adjust Step Attenuator Balance (STEP ATTEN BAL R115, STEP ATTEN BAL CENTERING R120)

REQUIREMENT: Front panel STEP ATTEN BAL adjustment should balance circuitry so that not more than 0.1 division of trace shift occurs as a result of changing the POLARITY selection at .1 VOLTS/DIV with no signal applied.

a. Control settings given in Table 5-2 apply.

TABLE 5-3

Power Supply Values and Adjustments

Supply	Tolerance	Adjustment
-50 V	± 50 mV	In Oscilloscope; Check Oscilloscope calibration if out of allowable tolerance
+8.7 V	± 87 mV	+8.7 V ADJUST R500
-8.7 V	± 87 mV	-8.7 V ADJUST R540
-7.1 V	-7.07 V ± 71 mV	None; affected by Step 2. If out of allowable tolerance, perform Step 2 and recheck.
-7 V	± 0.35 V	
+7 V	± 0.35 V	None
+2.5 V	± 0.25 V	

b. Switch the 7A11 VOLTS/DIV to .1 V.

c. Performance Check Only:

(1) Using the 7A11 POSITION control, set the trace to vertical center of the graticule.

(2) Select INVERT Polarity and note the trace position.

Performance Check/Calibration—7A11

(3) Using the 7A11 STEP ATTEN BAL control, move the trace half-way back to graticule center.

(4) Alternately select +UP and INVERT Polarity and adjust STEP ATTEN BAL as necessary to obtain minimum trace shift (less than 0.1 division).

d. Calibration Procedure Only:

(1) Set the STEP ATTEN BAL to midrange and pull out on the Oscilloscope Beam Finder knob.

(2) Set the 7A11 POSITION control to midrange. Note the trace position.

(3) Change the POLARITY selection and again note the trace position.

(4) ADJUST—STEP ATTEN BAL CENTERING, R120 (Fig. 5-4) as necessary to set the trace halfway between the two observed positions.

(5) Alternately select +UP and INVERT Polarity and adjust ATTEN BAL CENTERING R120 (Fig. 5-4) as necessary to obtain minimum trace shift.

(6) Using the 7A11 POSITION control, set the trace to graticule center.

(7) Return the Beam Finder switch to normal by pushing in and releasing it.

(8) Alternately select +UP and INVERT Polarity and adjust ATTEN BAL CENTERING R120 (Fig. 5-4) as necessary to obtain minimum trace shift.

(9) Select + UP Polarity at the 7A11.

3. Check/Adjust Position Centering (POSITION R220; POSITION CENTERING R240); Check POSITION range

REQUIREMENT: Trace should be within 0.5 division of graticule center with front-panel POSITION control at midrange. POSITION control should be capable of moving trace ± 8 divisions (± 0.8 division) from graticule center.

a. Control settings given in Table 5-2 apply.

b. Set the 7A11 POSITION control accurately to mid-range, and set the VOLTS/DIV control to 50 mV.

c. CHECK—Trace should be within ± 0.5 division of graticule center.

d. Calibration Procedure only:

(1) Disconnect the connectors from terminals "F" and "AK" (Fig. 5-4).

(2) ADJUST—POSITION CENTERING R240 (Fig. 5-4) to move trace to graticule center.

(3) Reconnect the wires to terminals F and AK.

(4) Using the front-panel POSITION control, set trace to graticule center.

(5) CHECK—knob index should be within approximately 10° of top-center.

(6) ADJUST—knob to top center (loosen set screw) with trace at graticule center.

(7) CHECK—knob should be approximately centered in its stop-to-stop travel range.

e. Using the front-panel POSITION control, set the trace to graticule center.

f. Depress the Offset ON button. Then adjust the FINE Offset control to place the trace at the bottom graticule line.

g. CHECK—POSITION upward range. Turn the POSITION control fully clockwise and check that the trace moves upward 8 (± 0.8) divisions.

h. Depress the Offset OFF button and again adjust the POSITION control to place the trace at graticule center.

i. Depress the Offset ON button and then adjust the Offset FINE knob to set the trace to the top graticule line.

j. CHECK—POSITION downward range. Move the POSITION control fully counterclockwise. The trace should be 8 (± 0.8) divisions below the top graticule line.

k. Depress the Offset OFF button and return the POSITION control to midrange.

4. (Calibration Procedure only.) Check/Adjust Mid Frequency Response (R211 and BOOTSTRAP TIME CONSTANT R345)

REQUIREMENT: Not specified. However, minimum rounding, overshoot or tilt (not exceeding 1% peak to peak) should exist within 2 ms after a step function is applied to the Probe.

a. Control settings given in Table 5-2 apply.

b. Connect the following components to the Fast Rise + Output of the Type 106 Square Wave Generator (item 4) in the sequence given: 5X GR Attenuator (item 15), 50 Ω Termination/Adapter (item 12), 7A11 Probe.

c. Set the 7A11 VOLTS/DIV to 10 mV.

d. Set the Square Wave Generator Repetition Rate Range to 100 Hz, the Multiplier to 2, the Hi Amplitude/Fast Rise switch to Fast Rise and adjust the + Transition Amplitude as necessary to obtain a six division display on the CRT. Using the 7A11 POSITION control, center the display.

e. Check that the Time Base sweep rate is at 1 ms/division and adjust the Time Base Triggering controls to obtain a triggered display as in Fig. 5-5(A).

f. CHECK—Mid-frequency response. The displayed top-left corners should be square with optimum flat top as in Fig. 5-5(A). Overshoot, rounding and tilt should not exceed .05 division peak to peak.

g. (Calibration Procedure only.) ADJUST—R211 and R345 (Fig. 5-4) for optimum square corner and flatness. Rounding, overshoot and tilt should not exceed .05 division peak to peak. Use Fig. 5-5 as a reference. (Observing the display at 5 ms/division may aid in performing the adjustment.)

5. (Calibration Procedure only.) Check/Adjust 93 Ω Termination (TERMINATION R45)

REQUIREMENT: Not specified; however, minimum discontinuity should exist approximately 25 ns after a fast-rise step function is applied to the Probe.

a. Control settings given in Table 5-2 apply. The 7A11 Probe is connected to the Type 106 Square Wave Generator through the 50 Ω Termination/Adapter and a 5X GR Attenuator.

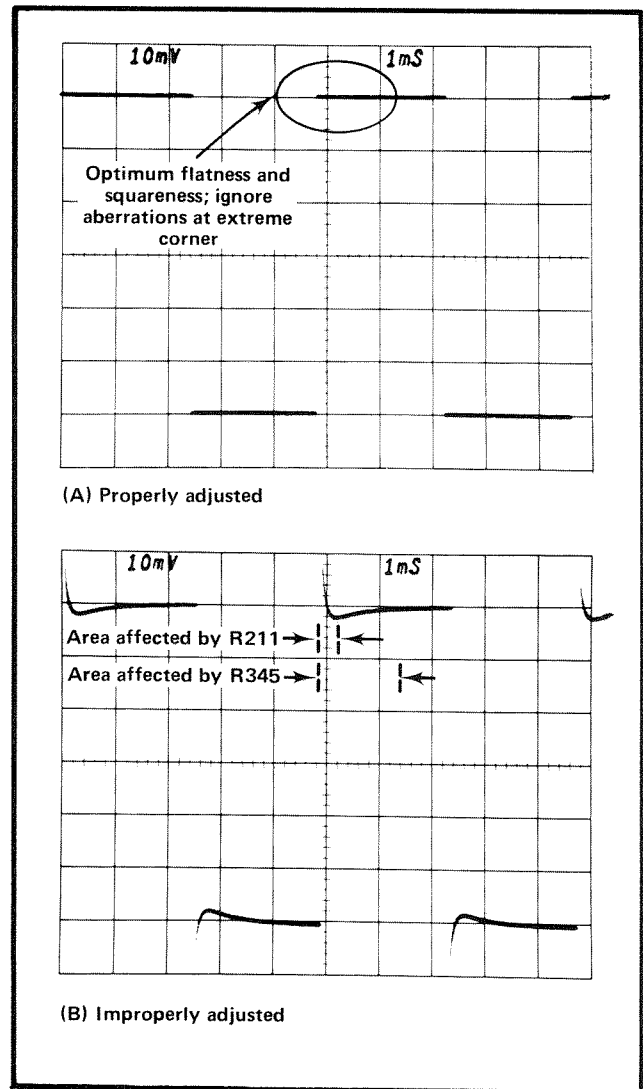

Fig. 5-5. Mid-frequency response waveforms, step 4.

b. Set the Square Wave Generator Repetition Rate Range to 100 kHz and its Multiplier to 1. Check that Fast Rise is selected, and six divisions vertical separation exists between the two traces.

c. Switch the 7A11 Bandwidth to FULL.

d. Switch the Time Base Time/Div to .05 μ s. Increase the Oscilloscope Intensity and adjust the Triggering and Position controls as necessary to obtain a display as in Fig. 5-6(A).

e. Switch the Time Base Magnifier to X10 and adjust the Position control to position the display as indicated in Fig. 5-6(B). The beginning of the step function should start at the first vertical graticule line at the left for convenient time measurement.

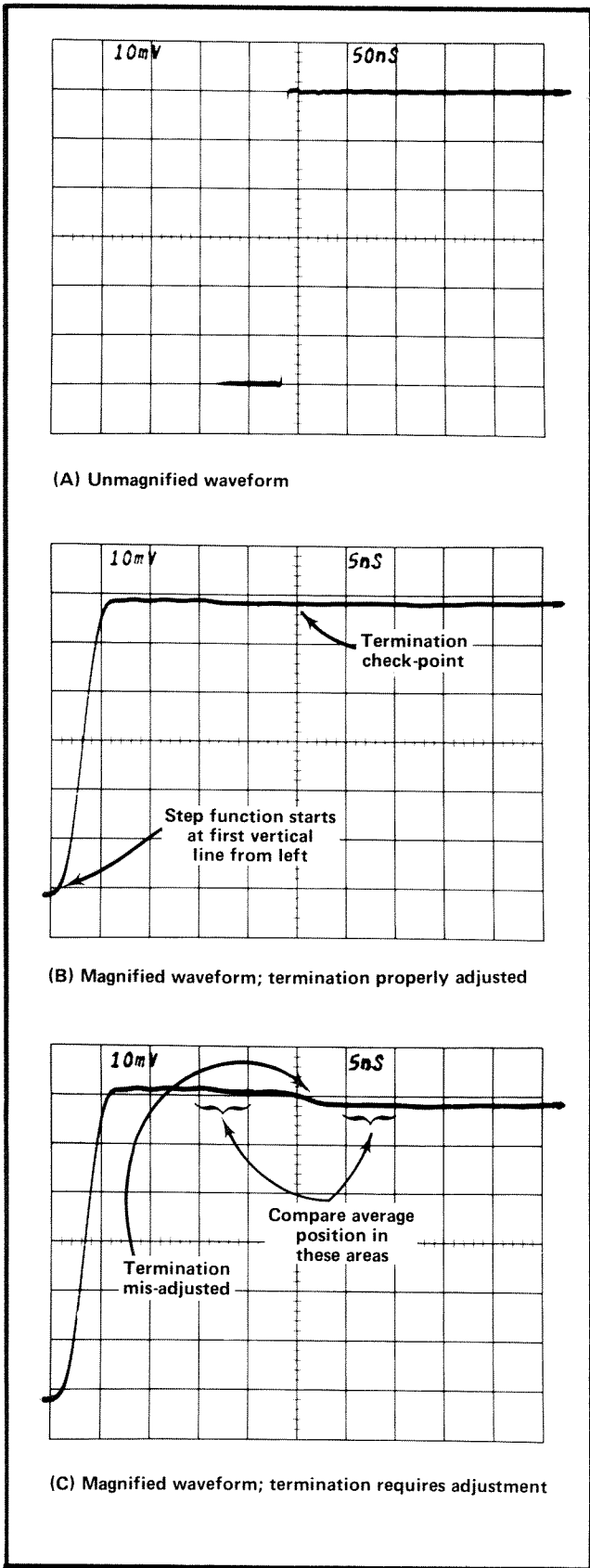

Fig. 5-6. Termination adjustment waveforms, step 5.

f. CHECK—93 Ω Termination. No obvious step should appear approximately 25 ns after start of the step function. The average trace position 15 to 20 ns after the start of the step function should be within ± 0.05 division of the average trace vertical position 35 to 40 ns after the start of the step function as shown in Fig. 5-6(B). Fig. 5-6(C) shows a waveform resulting from a misadjusted termination.

g. (Calibration Procedure only.) ADJUST—93 Ω Termination as follows:

(1) Disconnect the Probe from the 50 Ω Termination/Adapter.

(2) De-energize the 7A11 by pulling it free from the Oscilloscope connector.

(3) Remove the Probe upper cover and shield as explained in the Maintenance Section.

CAUTION

Do not remove or replace the shield with the 7A11 energized. An accidental short-circuit may occur. Be careful while working with the dis-assembled Probe to avoid damage to the unprotected tip assembly.

(4) Insert the 7A11 fully into the Oscilloscope.

(5) Connect the Probe to the 50 Ω Termination/Adapter, 5X Attenuator, and Square Wave Generator.

(6) Permit 5 minutes warmup time before continuing.

(7) Adjust TERMINATION R45 (Fig. 5-7) for minimum discontinuity occurring approximately 25 ns after start of the step function. Switch the 10X Magnifier Off and On as necessary to best observe the adjustment results.

(8) Disconnect the 7A11 from the Oscilloscope connector.

(9) Disconnect the Probe from the 50 Ω Termination/Adapter and re-install the shield and cover.

(10) Insert the 7A11 fully into the Oscilloscope. Select 20 MHz Bandwidth at the 7A11 and switch the Time Base Multiplier to X1.

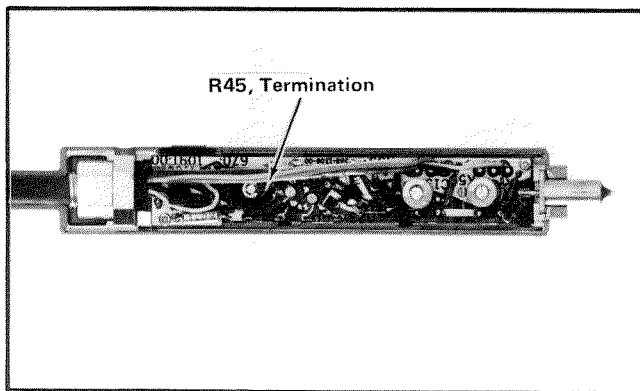

Fig. 5-7. Probe termination adjustment location, step 5.

(11) Alternately select +UP and INVERT Polarity and adjust STEP ATTEN BAL for minimum trace shift.

(12) Check STEP ATTEN BAL knob position. If the index is more than approximately $\pm 15^\circ$ from top-center, repeat step 2 before proceeding.

(13) Switch the 7A11 POLARITY to +UP.

6. Check/Adjust Gain (GAIN R138); Check Variable Gain Range (VARIABLE R180); Check VARIABLE Balance

REQUIREMENT: Gain observed at any position of the VOLTS/DIV switch should be accurate to within 2% of GAIN adjusted at the 0.1 position of the VOLTS/DIV switch. The VARIABLE control should be capable of increasing the selected VOLTS/DIV to at least 2.5 times the indicated value.

NOTE

The 7A11 gain can be calibrated with any reliable source. 7000-Series Oscilloscopes are equipped with calibrators which are accurate to within 1%. The Amplitude Calibrator And Comparator, Tektronix Part No. 067-0502-01, is accurate to within 0.25%. When calibrated in the .1 position of the VOLTS/DIV switch, other positions of the switch will be accurate to within 3% if a 7000-Series Oscilloscope Calibrator is used, and to within 2% if the Amplitude Calibrator And Comparator is used.

a. The control settings given in Table 5-2 apply.

b. If the Amplitude Calibrator And Comparator (item 5) is to be used, set it for a 0.5 volt square wave output. If the 7000-Series Oscilloscope Calibrator is to be used, set it for a .4 V - 1 kHz output.

c. Connect the 7A11 Probe to the Output connector of the Amplitude Calibrator and Comparator or the Oscilloscope Calibrator Output jack, using the 7A11 Stored Probe Input Adapter (item 11) and a 50 Ω Coaxial Cable (item 16).

d. Set the 7A11 VOLTS/DIV to .1 V.

e. Select 1 ms/Div sweep rate and adjust the Time Base for a triggered display.

f. CHECK—Gain accuracy as follows: with Amplitude Calibrator And Comparator - 5 divisions; with 7000-Series Oscilloscope Calibrator - 4 divisions. Measure from trace center to trace center.

g. ADJUST—GAIN (front panel) to obtain the appropriate display amplitude.

h. CHECK—Gain ratio accuracy under each setup given in Table 5-4.

TABLE 5-4

Gain Ratio Accuracy Check

7A11 VOLTS/ DIV	With Amplitude Calibrator And Comparator		With 7000-Series Oscilloscope Calibrator	
	Signal	Display (Divisions)	Signal	Display (Divisions)
20	100 Volts	5 \pm 0.1	40 V	2 \pm 0.06
10	50 Volts	5 \pm 0.1	40 V	4 \pm 0.12
5	20 Volts	4 \pm 0.08	40 V	8 \pm 0.24
2	10 Volts	5 \pm 0.1	4 V	2 \pm 0.06
1	5 Volts	5 \pm 0.1	4 V	4 \pm 0.12
.5	2 Volts	4 \pm 0.08	4 V	8 \pm 0.24
.2	1 Volts	5 \pm 0.1	.4 V	2 \pm 0.06
.1	.5 Volt	Adjusted for 5	.4 V	Adjusted for 4
50 mV	.2 Volt	4 \pm 0.08	.4 V	8 \pm 0.24
20 mV	.1 Volt	5 \pm 0.1	40 mV	2 \pm 0.06
10 mV	50 mVolts	5 \pm 0.1	40 mV	4 \pm 0.12
5 mV	20 mVolts	4 \pm 0.08	40 mV	8 \pm 0.24

i. Push in and release the 7A11 VARIABLE knob, placing it in its outward position.

j. CHECK—VARIABLE range. Rotate the VARIABLE control and check that the display amplitude can be varied as follows: with Amplitude Calibrator And Comparator - from 5 divisions to 2 divisions or less; with 7000-Series Oscilloscope Calibrator - from 8 divisions to 3.2 divisions or less.

Performance Check/Calibration—7A11

k. Disconnect the Probe from the Stored Probe Input Adapter. Set the 7A11 VOLTS/DIV to .1 V. Using the POSITION control, center the trace.

l. Adjust the STEP ATTEN BAL so that minimum trace shift accompanies switching between +UP and INVERT Polarity.

m. Select +UP Polarity.

n. CHECK—VARIABLE balance. Trace shift accompanying rotation of VARIABLE control should not exceed 0.2 divisions.

o. Switch the Time Base to Auto, AC, Internal Triggering.

p. Push in and release the VARIABLE knob, placing it in its calibrated position.

q. Set the 7A11 VOLTS/DIV to 5 mV.

7. Check/Adjust Offset Voltage (OFFSET OUT CAL - R320)

REQUIREMENT: Offset range from $-1\text{ V} (\pm 10\%)$ to $+1\text{ V} (\pm 10\%)$; OFFSET OUT voltage should be within 0.5 mV +1% of offset voltage applied internally to amplifier with VOLTS/DIV switch in any of the 5 mV through 50 mV positions.

NOTE

Either the Amplitude Calibrator And Comparator (accurate to within 0.25%) or the 7000-Series Oscilloscope Calibrator (accurate to within 1%) can be used in the following procedure. Accuracy will be approximately 1% less reliable if the latter is used.

a. Control settings given in Table 5-2 apply, except that the 7A11 VOLTS/DIV control is at 5 mV.

b. Using the 7A11 POSITION control, set the trace accurately to graticule center. Do not move the POSITION control for the rest of this step.

c. Select +DC at the Amplitude Calibrator And Comparator. Then set it for a .5 V output; or select DC at the Oscilloscope Calibrator and set it for a 0.4 V DC output.

d. Connect the Probe tip (via the Stored Probe Input Adapter and coaxial cable) to the Output connector of the Amplitude Calibrator And Comparator or the 7000-Series Oscilloscope Calibrator.

e. At the 7A11, select Offset ON. Then adjust the FINE Offset control as necessary to accurately set the trace to graticule center.

f. CHECK—OFFSET OUT accuracy. Using the Differential Voltmeter and the Cable Assembly (item 18), check the voltage at the OFFSET OUT jack. It should be equal to the following: $-500\text{ mV} \pm 5.5\text{ mV}$ with Amplitude Calibrator And Comparator; $-400\text{ mV} \pm 10.5\text{ mV}$ with Oscilloscope Calibrator.

g. (Calibration Procedure only.) ADJUST—OFFSET OUT CAL - R320 (Fig. 5-8) as necessary to obtain 500 mV OFFSET OUT voltage with Amplitude Calibrator And Comparator, or 400 mV with Oscilloscope Calibrator. Note that R320 interacts on the trace position and the front-panel OFFSET controls will have to be readjusted to keep the trace at graticule center.

h. CHECK—OFFSET OUT range. First rotate the OFFSET controls fully counterclockwise and check OFFSET OUT for $-1\text{ V} \pm 0.1\text{ V}$; then rotate the controls fully clockwise and check for $+1\text{ V} \pm 0.1\text{ V}$.

i. Disconnect the Voltmeter and Cable Assembly from the OFFSET OUT jack.

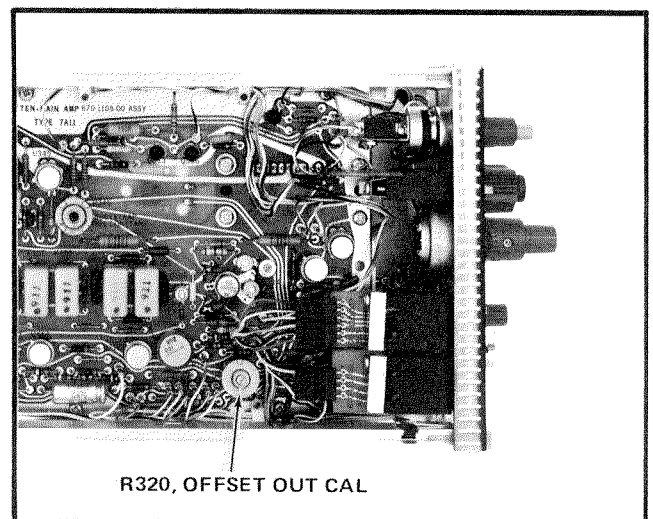

Fig. 5-8. Adjustment location, step 7.

j. Disconnect the Probe from the Stored Probe Input Adapter. Remove the coaxial cable from the Amplitude Calibrator And Comparator or from the Oscilloscope Calibrator.

k. Push the 7A11 Offset OFF button to its inward position.

8. Check Input Gate Current

REQUIREMENT: 0.25 nA or less at 25°C.

a. Control settings given in Table 5-2 apply, except that the VOLTS/DIV control is at 5 mV.

b. Set the trace accurately to graticule vertical center, using the 7A11 POSITION control.

c. CHECK—Gate current. Connect the 50 Ω Termination/Adapter to the Probe and note accompanying trace shift. Trace shift should be within 0.05 division, indicating 0.25 nA or less gate current. (Values apply when ambient temperature is approximately 25° C. See Specification Section for values applicable at other temperatures.)

d. Disconnect the 50 Ω Termination/Adapter from the Probe.

9. Check Drift With Time

REQUIREMENT: With ambient temperature and line voltage constant, drift with time should be within 0.1 division during any 1 minute interval within 1 hour after 20 minutes from turn-on, and should be within 0.3 division during any hour after 20 minutes from turn-on.

a. Control settings appear in Table 5-2, except that the VOLTS/DIV switch is at 5 mV. The 7A11 must have been operating continuously for at least 20 minutes since the last time it was energized.

b. CHECK—Short-term drift. Trace shift should be within 0.1 division over any 1-minute interval.

c. (Optional.) CHECK—Long-term drift. Trace position should remain within a 0.3 division area during the next hour.

10. Check IDENTIFY operation

REQUIREMENT: IDENTIFY controls should be capable of causing approximately 1/4 division of trace shift.

a. Control settings given in Table 5-2 apply.

b. CHECK—Probe IDENTIFY operation. Depress and release the IDENTIFY button on the Probe and observe that approximately 1/4 division trace shift accompanies the action.

c. CHECK—Front-panel IDENTIFY operation. Repeat the operation described in part b., using the front-panel IDENTIFY button.

11. Check AC-Coupled Low-Frequency Response

REQUIREMENT: Low-Frequency —3 dB point at 15 Hz with AC-Coupler attached to Probe.

a. Control settings given in Table 5-2 apply. Equipment required for step 11 is shown in Fig. 5-9.

b. Set the 7A11 VOLTS/DIV to 50 mV.

c. Set the Low-Frequency Sine Wave Generator (item 8) Amplitude to minimum.

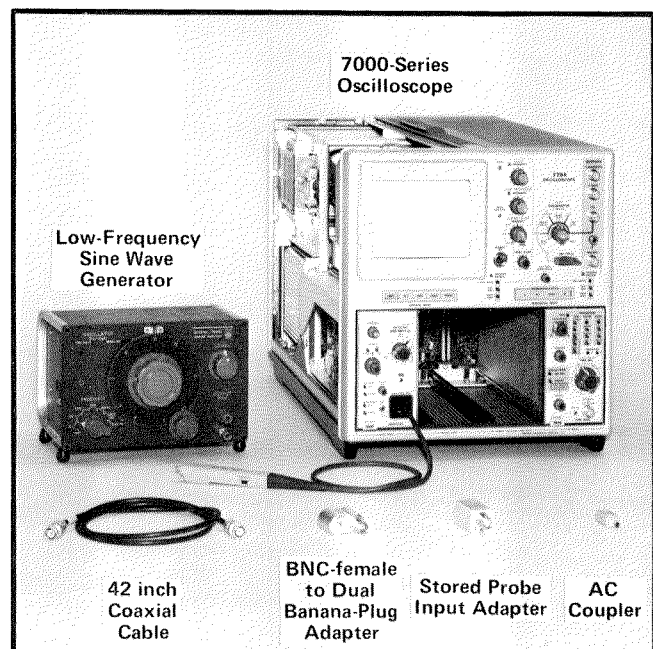

Fig. 5-9. Equipment for step 11.

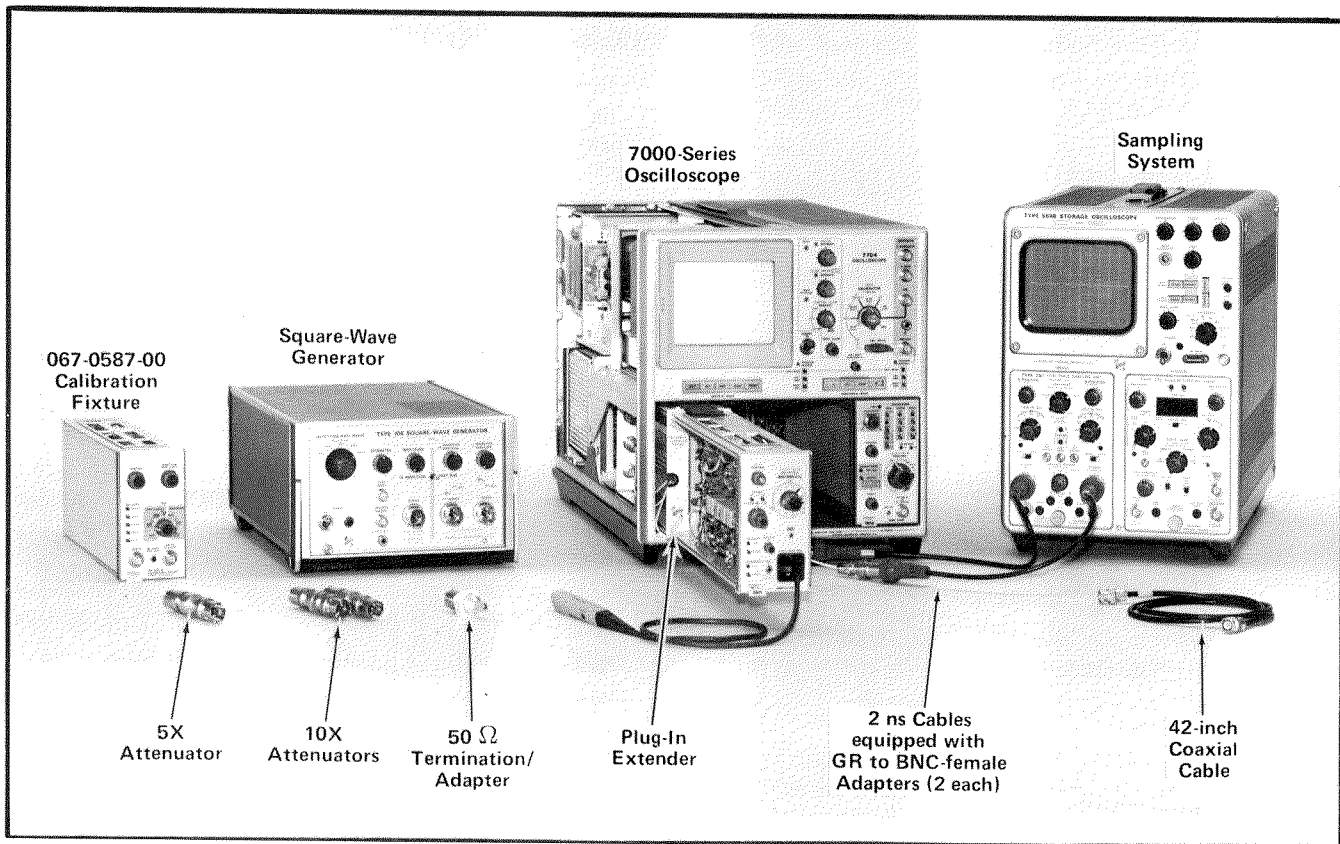

Fig. 5-10. Equipment for steps 12 through 20.

d. Connect the 7A11 Probe to the Generator Output connector, using the coaxial cable, Stored Probe Input Adapter, and BNC female to Banana-Plug adapter (item 20).

e. Adjust the Generator frequency to 15 Hz, comparing it against the Oscilloscope Time Base (3 cycles in ten divisions at a 20 ms/div sweep rate, Triggering Mode at Norm).

f. Adjust the Generator Amplitude for an 8 division peak-to-peak display.

g. Insert the AC Coupler (item 13) in the signal path between the Probe tip and the Stored Probe Input Adapter.

h. CHECK—AC-coupled low-frequency response. The display amplitude should have been reduced, with at least 5.66 divisions peak-to-peak amplitude remaining.

i. Disconnect the Probe from the AC Coupler.

j. Switch the 7A11 VOLTS/DIV to 10 mV.

k. Switch the Oscilloscope Time Base Triggering Mode to Auto and Time/Div to 1 ms.

12. Check/Adjust Transient Response (R134, C131, C134, R255, C255, C203, C245, C261, C234)

NOTE

Because of the wide bandwidth of the 7A11, a complete check of transient response is made, using a combination of methods (sampling and real time) in steps 12, 13 and 15. Step 12 is used to check and, if necessary, adjust the 7A11 transient response. Step 12-d and 12-j obtain information necessary for the performance of step 15. Step 13 contains the procedure for adjusting the two attenuators in the Probe. Step 15 completes the check of overall transient response, and checks for risetime.

a. Control settings are given in Table 5-2. The equipment required for steps 12 through 20 appears in Fig. 5-10.

b. Set the Sampling System controls as listed in Table 5-5.

TABLE 5-5

Sampling System Control Settings

3S1	
Channels A and B	
Position	Midrange
Offset	Midrange
mVolts/Div	200
Variable	Cal
Channel A Invert/Norm	Norm
Channel B Invert/Norm	Invert
Mode	A + B
Smooth/Normal	Normal
Internal Trigger	A
Horiz Plug-In	Sampling, 3T Series
3T2	
Time Position	Midrange
Horiz Position	Midrange
Samples/Div	Midrange
Range	1 μ s
Start Point	With Trigger
Display Mag	X1
Time Magnifier	X10
Variable	Cal
Display Mode	Normal
Trig Sensitivity	Fully Clockwise
Polarity	+
Source	Ext
Oscilloscope	
Astigmatism	Adjusted for well defined trace
Focus	
Intensity	

c. Set up the Sampling System for A–B operation. This can be accomplished as follows:

(1) Select Chan A mode.

(2) Set the Channel A mVolts/Div switch to 200 and center the Position control. Switch the mVolts/Div control progressively toward 2 mVolts/Div, adjusting the Offset control to keep the trace at its original position.

(3) Switch back to 200 mVolts. Then use the Position control to set the trace to graticule center and repeat step (2).

(4) Select Chan B mode and repeat steps 2 and 3.

(5) Select A+B mode and set both mVolts/Div controls to 50 mV.

d. Determine and record the Type 106-3S1 risetime, using a 5-division square wave and 50 mVolts/Div; determine the shape of the top-left corner of the pulse at 2% per division sensitivity. This can be done as follows:

(1) Connect a 42 inch coaxial cable from the Type 106 Trigger Output to the 3T2 1 M Ω Trigger Input Connector.

(2) Connect the + Output connector of the Type 106 Square Wave Generator to the Channel A Input connector of the 3S1, using a 2 ns cable (item 17).

(3) Set the Type 106 Square Wave Generator frequency to 250 kHz and adjust the + Transition Amplitude to obtain a 5 division display on the Sampling System CRT.

(4) Measure and record the display risetime as measured between the 10 and 90% amplitude points. See Fig. 5-11.

(5) Adjust the Channel A and Channel B Position controls equally to set the top of the display to graticule center. Then switch the Channel A and Channel B mVolts/Div to 5 mV.

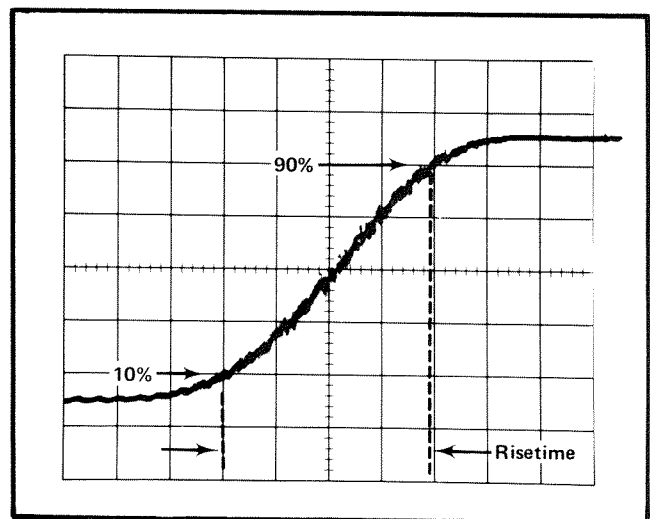

Fig. 5-11. Typical risetime waveform.

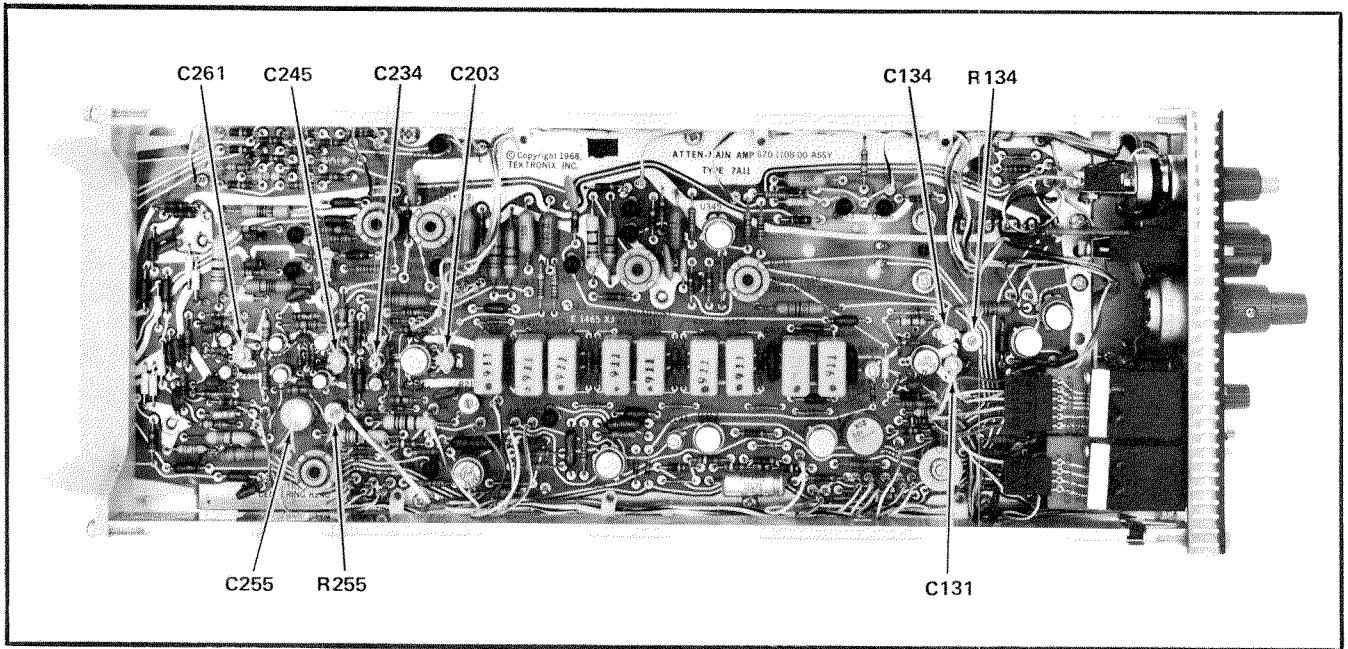

Fig. 5-12. Adjustment locations for step 12.

- (6) Select 10 ns/div sweep rate at the Time Base.
- (7) Record the appearance of the top of the display. This can be done by drawing it on the face of the CRT with a grease pencil.
- (8) Disconnect the 2 ns cable from the Type 106 Square Wave Generator.

e. Calibration Procedure only:

- (1) Within the Plug-In Extender (item 10), disconnect the bottom connector on the left and on the right side. Connect the left and right side male connector to the Channel A and B inputs of the 3S1, respectively, using 2 ns cables (item 17) and GR-to-BNC female adapters (item 19).
- (2) Connect the 7A11 to the Extender and install the Extender in the Oscilloscope vertical plug-in compartment.
- (3) Connect the 7A11 Probe through the 50 Ω Termination/Adapter and a 5X GR Attenuator to the + Output Connector of the Type 106 Square Wave Generator.
- (4) Select FULL Bandwidth at the 7A11.

- (5) Switch the 3S1 Channel A and Channel B mVolts/Div controls to 50 mV.

- (6) Adjust the Type 106 Square Wave Generator + Transition Amplitude as necessary to obtain a 5 division display on the Sampling System CRT. (7A11 at 10 mV/Div.) Use the 7A11 POSITION control to center the display.

- (7) Perform the adjustments listed in Table 5-6, obtaining an optimum square top-left corner and flat top on the waveform. Adjustment locations are shown in Fig. 5-12.

TABLE 5-6
Signal Transient Response Adjustments

Time/Div (ns)	Adjustment.	Area Affected (ns)	Adjust For
10	R134	20	Optimum squareness and minimum aberrations at top left corner; aberrations within ±0.24 divisions, 0.45 divisions peak to peak
10	C131	20	
10	C134	20	
10	R255	10	
50	C255	50	
10	C203	20	
10	C245	5	
10	C261	10	
2	C234	3	

(8) Set the top of the display to graticule center, using the 7A11 POSITION control. Then switch the 3S1 Channel A and Channel B mVolts/Div controls to 5 mV. Re-adjust the 7A11 POSITION control to keep the top of the display at graticule center.

(9) CHECK—Display should be similar to that observed in step 12-d (7). Deviation should be approximately within ± 1 division, which is equal to $\pm 2\%$.

(10) Repeat the transient response adjustments listed in Table 5-6, striving to duplicate the mean trace shape recorded in step 12-d (7).

(11) Remove the Extender (and attached 7A11) from the plug-in compartment.

(12) Install the 067-0587-00 Calibration Fixture (item 9) in the vertical plug-in compartment. Switch it to 250 kHz, + Step Response, and adjust the Amplitude to obtain a centered 6-division display. Switch the sweep rate to $.05 \mu\text{s}/\text{division}$ and set the step function to occur at the second line from the left of the graticule as in Fig. 5-13. Note the shape of the top-left corner of the pulse. It will be used as a reference.

NOTE

The existence of two vertical compartments in an Oscilloscope permits the Calibration Fixture to be left in the Oscilloscope for continual trace reference while checking/adjusting the 7A11. However, it must first be determined that the response of the two compartments is essentially identical.

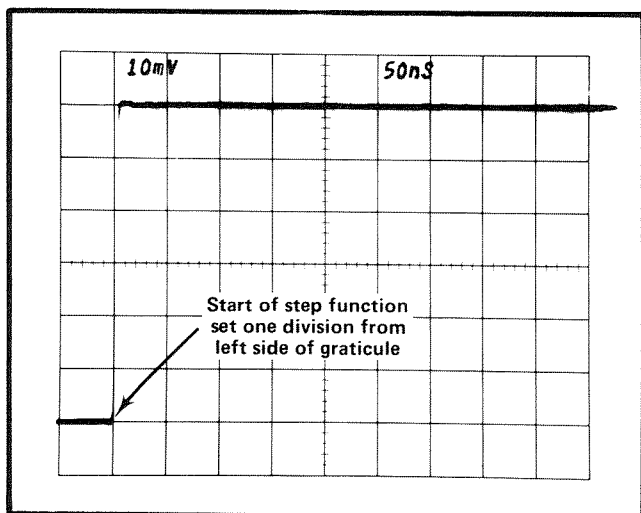

Fig. 5-13. Step function position for transient response adjustment, step 12.

(13) Install the 7A11 directly into the Oscilloscope vertical compartment.

(14) Adjust the Type 106 Square Wave Generator + Transition Amplitude to obtain a 6 division, 250 kHz display. Position the display as in Fig. 5-13. The step function should be essentially the same as that provided by the Calibration Fixture.

NOTE

The step function must appear in the same area of the CRT as the waveform against which it is being compared. If the 7A11 display is not essentially the same as the Calibration Fixture display, re-adjust C255 and R255 to make it the same. However, if re-adjustment is done, the waveform must again be compared against the Sampling System reference waveform, as in step 12-e (2), (5), (6), (8) and (9). When C245 and R245 are properly adjusted, the step function observed on the Sampling System CRT will duplicate the mean trace shape of the reference waveform drawn on the Sampling System CRT, and the step function observed on the 7000-Series Oscilloscope will duplicate the Calibration Fixture step function. Inability to meet this requirement indicates dissimilarity between the square waves provided by the Type 106 and the Calibration Fixture, a situation which should not exist in properly calibrated test equipment.

(15) RE-ADJUST—C255 and R255 (Fig. 5-12) as necessary to make the 7A11 display as nearly like the Calibration Fixture display as possible. Do not change any other transient response adjustment settings. (Re-check the step function through the Sampling System if re-adjustment is done.)

f. Switch the Time Base Triggering Source to Norm.

g. Check the response of the Calibration Fixture at each setting indicated in Table 5-7. These will be used as reference waveforms against which the 7A11 response will be checked. The area to be observed is indicated in Fig. 5-14. Note any aberrations or deviations from flatness.

h. Select 250 Hz at the Type 106 Square Wave Generator and 1 ms at the Time Base. Then adjust the Type 106 Square Wave Generator + Transition Amplitude for exactly 6 divisions display amplitude. (7A11 at 10 mV.) Adjust the 7A11 POSITION control to align the center of the top of the waveform accurately with the horizontal line 1 division below the top of the graticule, as in Fig. 5-14. This horizontal line will be referred to as the "horizontal reference line" for the remainder of this step.

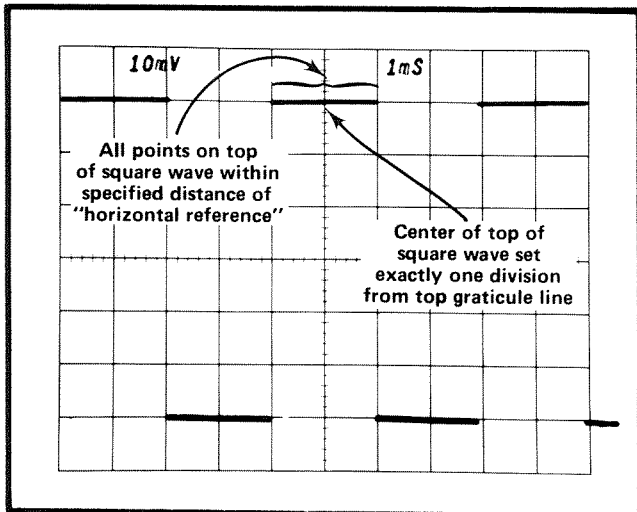

Fig. 5-14. Aberration check waveform; step 12.

TABLE 5-7
Reference Waveform Setups

Calibration Fixture Rep Rate	Time Base Sweep Rate	Aberrations or Deviations from Flatness
250 Hz	1 ms	
25 Hz	10 ms	
2.5 kHz	.1 ms	
25 kHz	10 μ s	
250 kHz	1 μ s	

i. CHECK—250 Hz response. All points on the top of the square wave should be within 0.18 divisions of the horizontal reference line as in Fig. 5-14. (If the Calibration Fixture's 250 Hz waveform contained aberrations or deviated from flatness, the Calibration Fixture's waveform must be used as reference.)

j. Switch the Type 106 Square Wave Generator and the Time Base to each setup given in Table 5-8 and check that all points on the top of the center square wave are within 0.18 divisions of the horizontal reference line. (If the Calibration Fixture waveform contained aberrations or deviated from flatness at any repetition rate, the Calibration Fixture waveform must be used as a reference at the corresponding repetition rate of the Type 106 Square Wave Generator.) Do not move the 7A11 POSITION control during this step after it has been set at the 250 Hz repetition rate.

TABLE 5-8

Aberration Check

Type 106 Repetition Rate	Time Base Sweep Rate	Mag-nifier	Comments	Allowable Deviation
250 Hz	1 ms	X1	Align center of waveform top with horizontal line 1 division from top of graticule. (Fig. 5-14)	0.18 div
25 Hz	10 ms	X1	Record the deviation (amount and polarity) occurring 4 divisions (80 ns) after step function occurs.	
2.5 kHz	.1 ms	X1		
25 kHz	10 μ s	X1		
250 kHz	1 μ s	X1		
		X10		
250 Hz	1 ms	X1	Re-check trace position. If vertical drift had occurred, repeat table 5-9 until no drift accompanies the check.	

k. Repeat steps h, i and j at 5 mV, 20 mV and 50 mV. Use a 10X Attenuator at 5 mV, 5X Attenuator at 20 mV, and no attenuator at 50 mV.

l. (Performance Check only.) Move the Probe and 50 Ω Termination/Adapter to the Hi Amplitude Output of the Type 106 Square Wave Generator. Switch the Hi Amplitude/Fast Rise switch to Hi Amplitude and repeat steps h, i and j at the .2 V and 2 V positions of the 7A11. Ignore the rolloff at the extreme left (first 20 ns) of the square wave, which occurs because of the relatively slow risetime of the Type 106 Hi Amplitude signal. Also ignore the transients at the extreme right corner.

m. Switch the Time Base Triggering Source to Auto.

NOTE

Steps i, j and k are dependent upon the Termination Adjustment (step 5), the Mid-Frequency Adjustments (step 4), and the Transient Response Adjustments (step 12-a through 12-e). Step l is dependent upon the Input Compensation Adjustment (step 13) in addition to the adjustments just listed.

13. (Calibration Procedure only) Check/Adjust Probe Input Compensation (C6, C13)

REQUIREMENT: Not specified; however, rounding or overshoot in the first $1.5 \mu\text{s}$ after a step function is applied to the Probe should not exceed approximately $\pm 3\%$ (6% peak to peak) in the .1 VOLTS/DIV through 20 VOLTS/DIV positions.

a. The control settings given in Table 5-2 apply, except that the 7A11 Bandwidth is at FULL.

b. Switch the 7000-Series Oscilloscope Time Base sweep rate to $1 \mu\text{s}$ and check that the Magnifier is at X1. Observe a 6 division, 250 kHz display (from the Calibration Fixture) on the 7000-Series Oscilloscope. It will be used as the reference for adjustments in this step.

c. Switch the Type 106 Square Wave Generator Hi Amplitude/Fast Rise switch to Hi Amplitude and set the Amplitude control fully counterclockwise. Set the Repetition Rate to 100 kHz and the Multiplier to 2.5.

d. Switch the 7A11 VOLTS/DIV to .2 and connect the Probe, 50Ω Termination/Adapter, and 5X GR Attenuator to the Hi Amplitude Output connector of the Square Wave Generator.

e. Adjust the Square Wave Generator Amplitude control as necessary to obtain a 6 division display.

f. Set the 7A11 POSITION control to center the display.

g. CHECK—Divide-by-20 input compensation. The top left corners of the square waves should be square, duplicating the Calibration Fixture's 250 kHz Step Response display. Overshoot, rounding and tilt at the top-left corner of the square waves should be within 0.2 divisions. See Fig. 5-15. Ignore the aberrations at the trailing edge of the top of the pulse.

h. If the divide-by-20 input compensation needs adjustment, disconnect the Probe from the 50Ω Termination/Adapter and remove the Probe's top cover as explained in the Maintenance Section. Leave the shield in place. Then reconnect the Probe to the 50Ω Termination/Adapter.

CAUTION

Be careful with the Probe tip while the cover is removed.

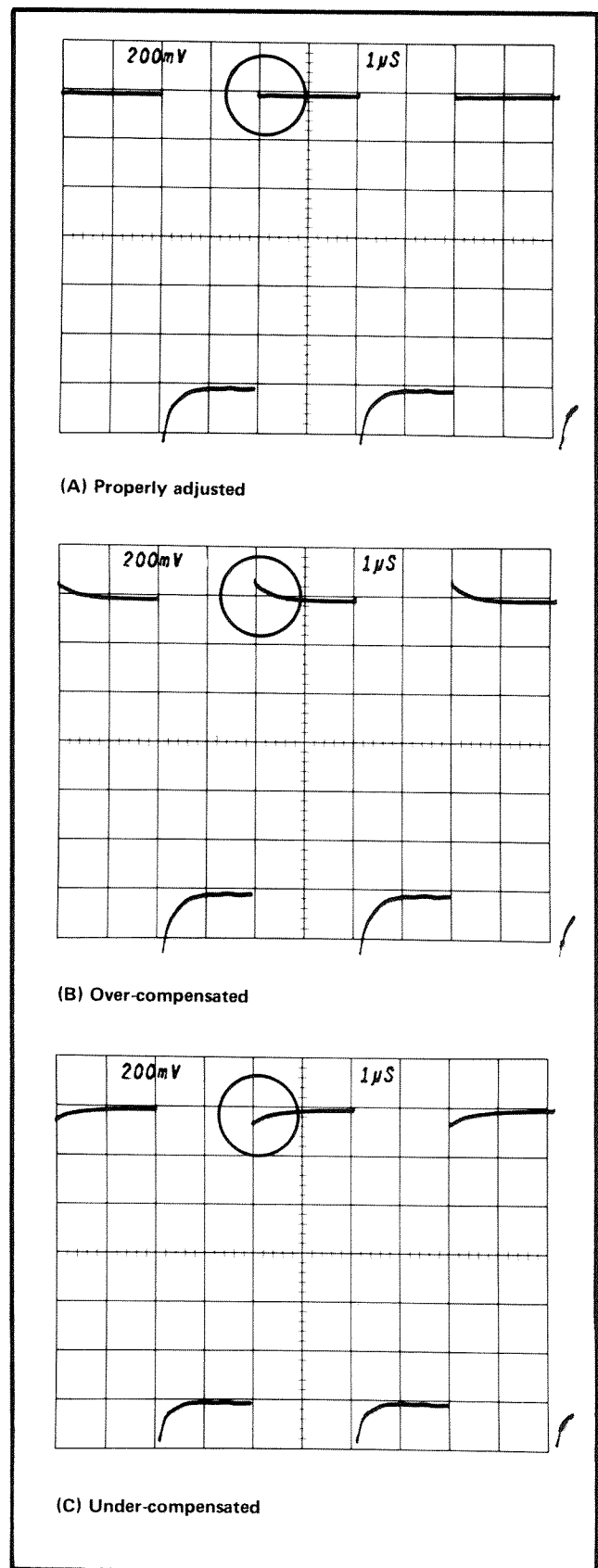

Fig. 5-15. Probe compensation waveforms, step 13.

Performance Check/Calibration—7A11

i. ADJUST—Divide-by-20 Input Compensation C13 (Fig. 5-16) as necessary to obtain optimum squareness at the top left corner of the square waves, duplicating the Calibration Fixture's 250 kHz display. Overshoot, rounding and tilt should be within 0.2 division. Ignore any aberrations that may exist at the upper right corner of the square waves.

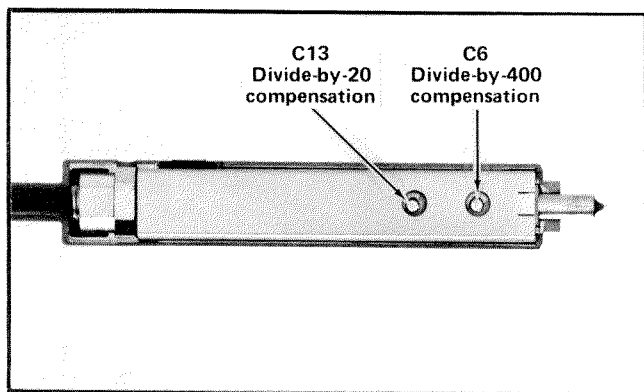

Fig. 5-16. Probe input compensation adjustment locations; step 13.

NOTE

The divide-by-20 adjustment also affects the divide-by-400 presentation checked in step 13-o.

j. Disconnect the Probe from the 50 Ω Termination/Adapter and replace the Probe cover.

k. Reconnect the Probe to the 50 Ω Termination/Adapter and recheck the squareness. Repeat steps h through k if necessary.

l. Remove the 5X Attenuator.

m. Switch the 7A11 VOLTS/DIV to 2.

n. Adjust the Square Wave Generator as necessary to obtain a 250 kHz, 6 division display.

o. CHECK—Divide-by-400 input compensation. Overshoot, rounding and tilt at the top left corners of the square waves should be within 0.2 divisions of duplicating the Calibration Fixture's 250 kHz Step Response display. Ignore aberrations that may exist at the right corner of the square waves.

p. If adjustment is required, disconnect the Probe from the 50 Ω Termination/Adapter and remove the cover. Then reconnect the Probe to the 50 Ω Termination/Adapter.

q. ADJUST—Divide-by-400 Input Compensation C6 (Fig. 5-16) to obtain optimum squareness at the top left corner of the square waves. Overshoot, rounding and tilt should be within 0.2 division of duplicating the Calibration Fixture's 250 kHz display. Ignore aberrations at the right corner.

r. Disconnect the Probe from the 50 Ω Termination/Adapter and re-install the Probe cover.

s. Re-connect the Probe to the 50 Ω Termination/Adapter and recheck the squareness. Repeat steps p through s if necessary.

t. Disconnect the Probe from the 50 Ω Termination/Adapter.

14. Check Noise

REQUIREMENT: Noise (tangentially measured into a 7000-Series Oscilloscope) should be within 0.1 division.

a. Control settings appear in Table 5-2, except that FULL Bandwidth is selected.

b. Set the Oscilloscope Time Base for a 2 ms/div trace and line triggering. Adjust the Oscilloscope Intensity and Focus for an optimum trace.

c. Switch the 7A11 VOLTS/DIV to 5 mV.

d. Connect the following components to the Type 106 Square Wave Generator Fast Rise + Output Connector in the sequence given: Two 10X GR Attenuators, one 5X GR Attenuator, 50 Ω Termination/Adapter, 7A11 Probe tip.

e. At the Type 106 Square Wave Generator, switch the Repetition Rate Range to 100 kHz. Set the Hi Amplitude/Fast Rise switch to Fast Rise and adjust the + Transition Amplitude to obtain two horizontal traces. See Fig. 5-17. Then adjust the + Transition Amplitude until the two traces merge and the dark line separating them disappears. Proper adjustment is obtained when doubt exists as to whether or not the line has been eliminated.

f. Remove one 10X Attenuator from the signal path.

g. CHECK—Noise. Trace separation should be within 1 division. This represents noise within 0.1 division under conditions observed in step e.

h. Disconnect the Probe and $50\ \Omega$ Termination/Adapter from the Square Wave Generator, leaving the $50\ \Omega$ Termination/Adapter attached to the Probe.

i. Observe trace width.

j. CHECK—Trace width at all other positions of the VOLTS/DIV switch. Width should not exceed that observed in step i. (It will be approximately the same at 5 mV, .1 V and 2 V.) If trace width at any position exceeds that in step i, the tangential measurement outlined in steps a through g should be performed at that position, using appropriate attenuators. If the VOLTS/DIV setting is so high as to prohibit use of a 10X Attenuator, switch to a ten times more sensitive position instead of removing the attenuator in step f.

15. Check Fast Transient Response and Risetime

REQUIREMENT: Transient response within $\pm 3\%$ (6% peak-to-peak) at 5 mV through 50 mV; within $\pm 4\%$ (8% peak-to-peak) at .1 V through 1 V; within $\pm 5\%$ (10% peak-to-peak) at 2 V through 20 V. Risetime 1.4 ns or less.

a. Control settings are given in Table 5-2.

b. The Plug-In Extender should still be connected to the Sampling System. If not, connect its lower left BNC male connector to Channel A and its lower right BNC male connector to Channel B of the 3S1. Check that the Sampling System controls remain set up as in Table 5-5, and check that a coaxial cable remains connected from the Type 106 Trigger Output to the 3T2 Trigger Input connector.

c. Connect the 7A11 to the Extender and install the Extender in the Oscilloscope vertical plug-in compartment.

d. Connect the 7A11 Probe through the $50\ \Omega$ Termination/Adapter and a 5X Attenuator to the Fast Rise + Output of the Type 106.

e. Set the 7A11 VOLTS/DIV to 10 mV and its BANDWIDTH to 20 MHz.

f. Switch the 3S1 Channel A and Channel B mVolts/Div controls to 50 mV.

g. Select 250 kHz at the Type 106 and adjust the Type 106 + Transition Amplitude as necessary to obtain a 5

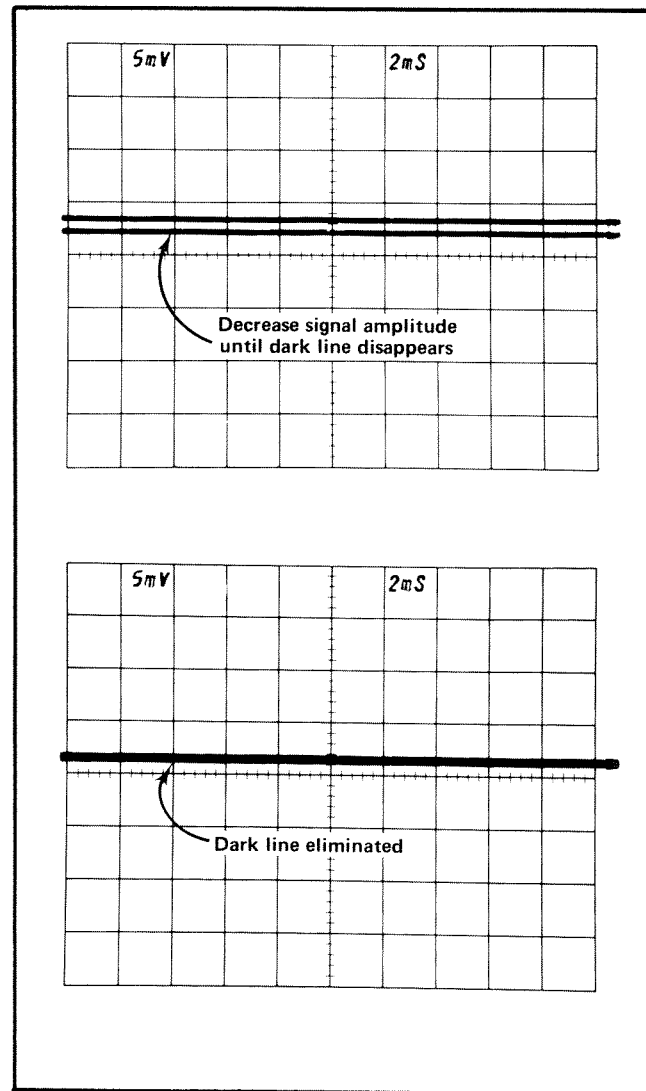

Fig. 5-17. Noise check waveforms, step 14.

division display on the Sampling System CRT. Center the display, using the 7A11 POSITION control.

h. Switch the Sampling System sweep rate to 5 ns/div and measure the step risetime between the 10% and 90% amplitude points as in Fig. 5-11.

i. CHECK—20 MHz risetime. It should be between 15.9 ns and 19.5 ns.

j. Switch the 7A11 BANDWIDTH to FULL.

k. Switch the Sampling System sweep rate to 500 ps/div and measure the step risetime between the 10% and 90% amplitude points of a 5 division display as in Fig. 5-11.

Performance Check/Calibration—7A11

l. CHECK—7A11 risetime. Apply the Type 106 - 7A11 - Sampling System risetime and the Type 106 - Sampling System risetime from step 12-d (4) to the graph in Fig. 5-18 and determine the 7A11 risetime. It should be 1.4 ns or less.

m. Switch the Channel A and Channel B mVolts/div controls to 5 mV and the Sampling System sweep rate to 10 ns/div. Using the 7A11 POSITION control, set the top of the display so that the start of the step function is aligned with the reference waveform drawn on the CRT, and the point 80 ns after the start of the step function is above or below the reference waveform (drawn on the graticule) by the amount of deviation present at the 80 ns point as determined in Table 5-8.

EXAMPLE: Assume that the 80 ns point is found to be .06 division low in Table 5-8. This represents 1% of the 6 division display. Since a 2% per division display is being viewed in step 15-m, the 80 ns point is placed 1/2 division (1%) below the reference waveform drawn on the face of the CRT. All other points on the waveform must then be within 1.5 divisions of the reference waveform drawn on the CRT in order for the display to be within specifications.

n. CHECK—Fast transient response. Deviation from the Type 106 - Sampling System reference waveform (drawn on the graticule) should not exceed ± 1.5 divisions (3 divisions peak-to-peak).

o. Repeat steps k through n under each condition listed in Table 5-9.

TABLE 5-9

Risetime and Aberration Check

7A11 VOLTS/DIV	Comments	Risetime	Aberrations
5 mV	Replace 5X Attenuator with 10X Attenuator	≤ 1.4 ns	$\leq \pm 1.5$ div (3%) ≤ 3 div peak to peak (6%)
20 mV	Replace 10X Attenuator with 5X Attenuator		
50 mV	Remove 5X Attenuator		
.1 V		≤ 1.4 ns	$\leq \pm 2$ div (4%) ≤ 4 div peak to peak (8%)

p. Switch the 7A11 VOLTS/DIV to 2 V, set the Sampling System Channel A and Channel B mVolts/Div controls to 2 mV and the Sampling System sweep rate to 500 ps. Adjust the Type 106 Square Wave Generator to obtain a 5 division display and measure the risetime between the 10% and 90% amplitude points. Determine the 7A11 risetime from Fig. 5-18.

NOTE

The Type 106 has insufficient drive to check the transient response and risetime at all of the attenuated positions of the 7A11. However, a complete check of these positions can be made by using the Tektronix Type 109 Pulse Generator and Tektronix Type 113 Delay Line instead of the Type 106. The procedure employed should be similar to that outlined in the preceding step, taking into consideration the Type 109 - Sampling System waveform and risetime. (If the Sampling System contains a storage CRT, the reference waveform can be "stored" for comparison.) It is desirable to maintain an output of at least 10 V from the Type 109 to ensure consistently flat tops on the pulses. Use GR Attenuators to obtain the desired pulse amplitudes.

16. Check Positioning Effect Upon Aberrations

REQUIREMENT: Change in aberrations due to positioning should be within 10% of display amplitude when viewed on a Sampling System.

a. The equipment setup is continued from step 15. The 7A11 signal output is connected to the Sampling System through the Plug-In Extender and 2 ns cables. The 7A11 is connected to the Type 106 Square Wave Generator + Output connector via the 50 Ω Termination/Adapter.

b. Switch the 7A11 VOLTS/DIV to 20 mV, the 3S1 Channel A and Channel B mVolts/Div controls to 50, and the Sampling System sweep rate to 10 ns/div.

c. At the Type 106 Square Wave Generator, check that 250 kHz is selected. Adjust the + Transition Amplitude to obtain an 8 division display on the Sampling System CRT. Adjust the 7A11 POSITION control to center the display.

d. Observe the top of the display, carefully noting aberrations.

e. Using the 7A11 POSITION control, move the top of the display to the center graticule line and then to the

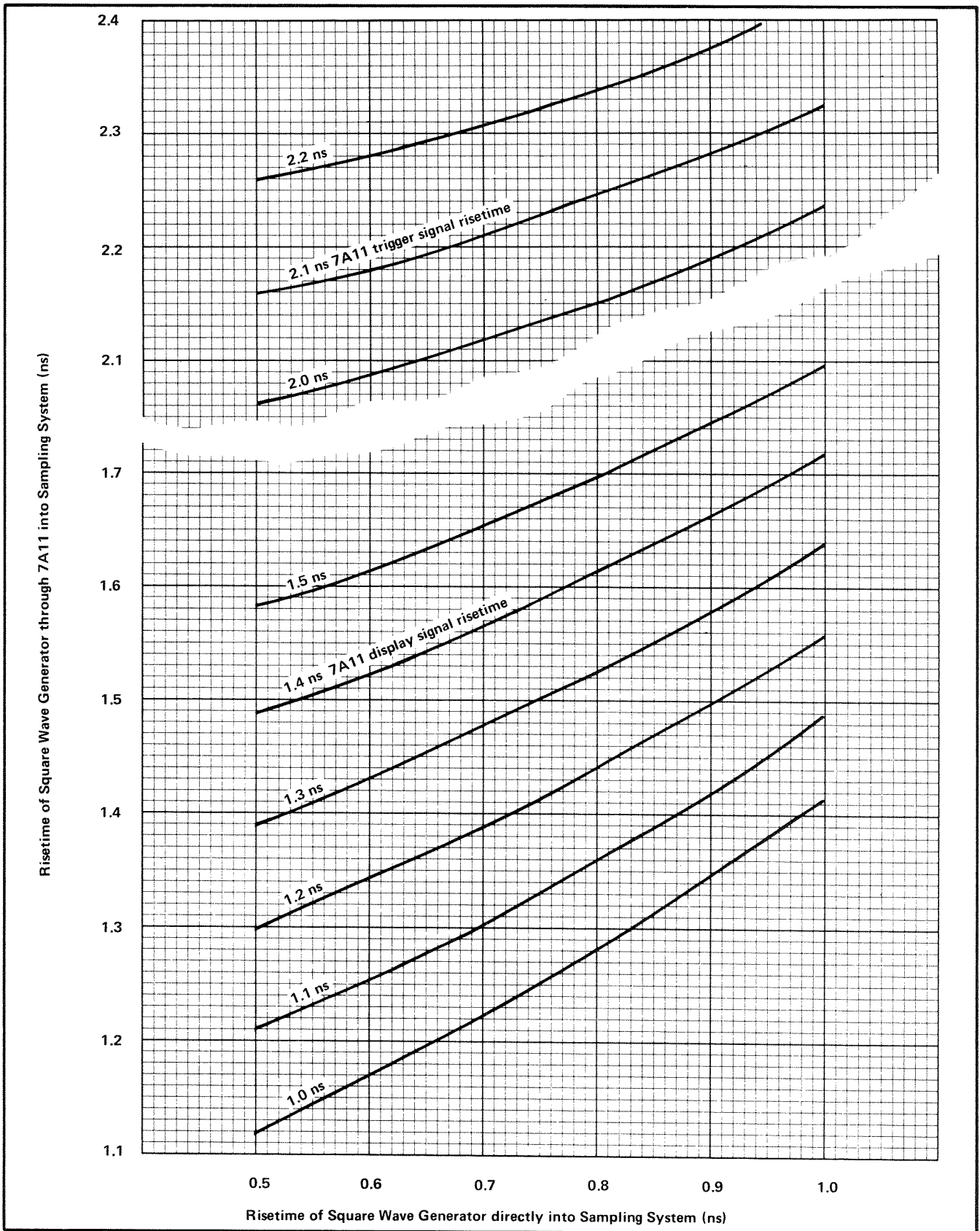

Fig. 5-18. 7A11 risetime computation chart.

Performance Check/Calibration—7A11

bottom graticule line on the Sampling System CRT, noting changes in aberrations.

f. CHECK—Change in aberrations between any two positions should be within 0.8 divisions.

g. Push the 7A11 INVERT button and again center the display, using the 7A11 POSITION control.

h. Observe the bottom of the display, carefully noting the aberrations.

i. Using the 7A11 POSITION control, move the bottom of the display to the middle graticule line and then to the top graticule line on the Sampling System CRT.

j. CHECK—Changes in aberrations between any of the positions should be within 0.8 divisions.

k. Switch the 7A11 Polarity to +UP, the Bandwidth to 20 MHz, and the VOLTS/DIV to 10 mV.

l. Disconnect the Probe from the 50 Ω Termination/Adapter.

m. Disconnect the Extender (and attached 7A11) from the 7000-Series Oscilloscope. Disconnect the Extender cables from the Sampling System and reconnect them within the Extender.

17. Check/Adjust Trigger Circuit Balance (TRIGGER BALANCE R285)

REQUIREMENT: Trigger circuit outputs should be within 50 mV of each other when display-circuit outputs are differentially balanced.

a. Control settings are given in Table 5-2. The Sampling System setup should be continued from steps 15 and 16, or set up according to steps 12-b and 12-c.

b. Set the Sampling System Time Base to obtain a free-running trace (Trig Sensitivity fully clockwise on the 3T2).

c. Set the Sampling System trace accurately to graticule center, adjusting the Channel A and B Position controls equally. Do not move the Sampling System Position controls for the remainder of this step.

d. With the 7A11 and Extender removed from the Plug-In Compartment, record the trace position on the 7000-Series Oscilloscope for later reference.

e. Within the Extender, disconnect the middle BNC connectors on each side and connect the A13 (left side) connector to the 3S1 Channel A Input, through the 2 ns cable; connect the B13 connector to the Channel B 2 ns cable.

f. Install the Extender (and attached 7A11) in the plug-in compartment.

g. After approximately five minutes warmup, adjust the 7A11 POSITION control to place the 7000-Series Oscilloscope trace to the position recorded in step 17-d.

h. CHECK—Trigger circuit balance. The Sampling System trace should be within 1 division (50 mV) of the centered position established in step 17-c.

i. (Calibration Procedure only.) ADJUST—TRIGGER BALANCE R285 (Fig. 5-19) as necessary to set the trace on the Sampling System CRT to graticule center.

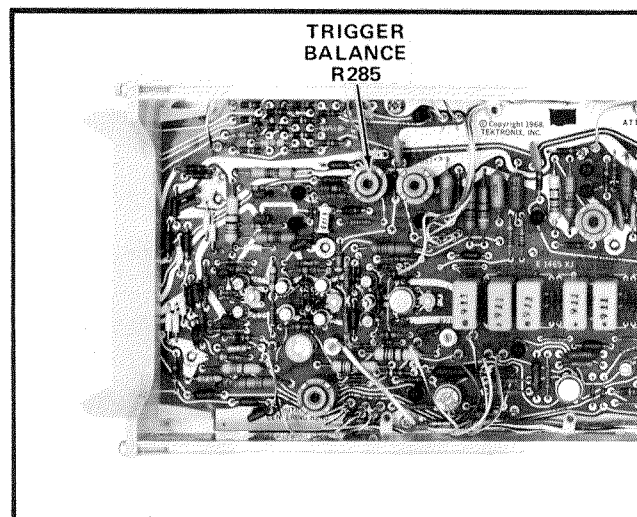

Fig. 5-19. TRIGGER BALANCE adjustment location, step 17.

18. Check Trigger-Circuit Output Amplitude

REQUIREMENT: Amplitude should be within 10% of the display-signal output amplitude.

a. The setup is continued from steps 15 through 18. A square wave (from the Type 106) is being displayed (through the 7A11 trigger-signal circuit and Extender) on the Sampling System CRT.

b. Connect the 7A11 Probe (through the 50 Ω Termination and the 10X Attenuator) to the Type 106 + Output connector.

c. Set the Type 106 Square Wave Generator frequency to 25 kHz and adjust the + Transition Amplitude to obtain 5 divisions separation between the two traces on the 7000-Series Oscilloscope CRT. Center the two-trace display on the 7000-Series Oscilloscope, using the 7A11 and Time Base Position controls.

d. Adjust the Sampling System as necessary to obtain a stable display. (Time Base at 10 μ s/div, both channels of the 3S1 at 50 mV/division.)

e. CHECK—Trigger circuit output amplitude. The display amplitude on the Sampling System CRT should be 5 (± 0.5) divisions.

19. Check Trigger Circuit Transient Response (C295)

REQUIREMENT: Aberrations within $\pm 6\%$, (10% peak-to-peak).

a. The setup is continued from steps 15 through 18. A square wave (from the Type 106) is being displayed (through the 7A11 trigger-signal circuit and Extender) on the Sampling System CRT.

b. Switch the 7A11 VOLTS/DIV to 50 mV and the Bandwidth to FULL.

c. Set the Sampling System sweep rate to 10 ns/div.

d. Remove the 10X Attenuator from the signal path.

e. Adjust the Type 106 Square Wave Generator + Transition Amplitude to obtain exactly 5 divisions display amplitude on the Sampling System. Then adjust the 7A11 POSITION control to center the display.

f. CHECK—Aberrations on the Sampling System display should be within ± 0.3 divisions, (0.6 divisions peak-to-peak).

20. Check Trigger Signal Risetime

REQUIREMENT: Risetime should be within 2.1 ns.

a. The setup is continued from steps 15 through 19. A centered 5 division display (from the Type 106) is being displayed (through the 7A11 trigger-circuit and Extender) on the Sampling System CRT.

b. Center the display on the Sampling System CRT, using the 7A11 POSITION control.

c. Select 500 ps sweep rate at the Sampling System Time Base and center the display, similar to that in Fig. 5-11.

d. Measure the trigger signal risetime between the 10% and 90% amplitude levels as in Fig. 5-11.

e. Determine the point at which the risetime intercepts the Type 106-3S1 risetime on the graph in Fig. 5-18.

f. CHECK—Trigger signal risetime should not exceed 2.1 ns.

g. Disconnect the Probe, Termination and 10X Attenuator from the Type 106 Square Wave Generator.

21. Check Trigger Circuit Frequency Response (Optional step - see NOTE)

REQUIREMENT: At least 167 MHz at the -3 dB point.

NOTE

Risetime and frequency response (bandwidth) are related as follows:

$$t_r \approx \frac{0.35}{bw}$$

The 2.1 ns risetime verified in step 20 indicates a frequency response of at least 167 MHz.

a. Control settings given in Table 5-2 apply except that the 7A11 VOLTS/DIV switch is at 50 mV. The 7A11 trigger circuit is connected (through the Plug-In Extender) to the Channel A and B inputs of the 3S1.

b. Connect the 7A11 Probe, 50 Ω Termination, and a 10X GR Attenuator to the Output connector on the 067-0532-00 Constant Amplitude Signal Generator (item 7).

c. Set the Signal Generator Frequency Range to 3 MHz and adjust its Amplitude controls to obtain an 8 division display on the Sampling System CRT.

Performance Check/Calibration—7A11

d. Change the Signal Generator frequency to 167 MHz.

e. CHECK—Bandwidth. At least 5.66 divisions display amplitude should remain on the CRT, indicating that the 7A11 Trigger Circuit -3 dB frequency response is at least 167 MHz.

NOTE

The Trigger Circuit Bandwidth is principally dependent upon the Display-Signal Circuit. Bandwidth in that circuit should be checked before troubleshooting the Trigger Circuit in event of insufficient bandwidth. See step 22.

f. Remove the Extender (and attached 7A11) from the plug-in compartment.

g. Disconnect the BNC connectors from the 3S1 2 ns cables and re-connect them within the Extender.

22. Check Display-Signal Circuit Frequency Response (Optional step - See NOTE)

REQUIREMENT: FULL Bandwidth of at least 250 MHz; 20 MHz Mode upper limit of 20 MHz \pm 2 MHz.

NOTE

As explained in the NOTE in step 21, the FULL risetime (1.4 ns) and 20 MHz risetime (15.9 to 19.5 ns) checks performed in Step 15 indicate FULL mode bandwidth of at least 250 MHz and 20 MHz mode bandwidth of 20 \pm 2 MHz. This step is therefore optional.

a. Control settings appear in Table 5-2 except that the VOLTS/DIV switch is at 50 mV. The 7A11 Probe and 50 Ω Termination/Adapter are connected through a 10X Attenuator to the Output of the 067-0532-00 Constant Amplitude Signal Generator. The Sampling System setup remains from step 21. (If not, it should be set up according to step 12-b and 12-c.)

b. Within the Plug-In Extender, disconnect the bottom BNC connectors on both sides.

c. Attach the left side connector (A11) to Channel A of the 3S1, using the 2 ns cable. Attach the right side connector (B11) to Channel B. Then install the Extender (and attached 7A11) in the plug-in compartment.

d. Set the 067-0532-00 Signal Generator frequency to 3 MHz and adjust its amplitude to obtain an 8 division display on the Sampling System CRT.

e. Switch the Generator Frequency Range to 65-500 MHz and adjust for a 250 MHz output.

f. CHECK—FULL bandwidth. The Sampling System CRT display should be at least 5.66 divisions, indicating 3 dB or less attenuation at 250 MHz. Then gradually decrease the Generator frequency to its lower limit while observing the display. It should remain in excess of 5.66 divisions.

g. Disconnect the Probe and Termination from the Generator. Then connect the Probe and Termination to the Output connector of the Type 191 Constant Amplitude Signal Generator (item 6).

h. Set the Type 191 Generator frequency to 50 kHz Only and adjust its amplitude to obtain an 8 division display on the Sampling System CRT.

i. At the 7A11, select 20 MHz Bandwidth.

j. Set the Type 191 frequency to 18 MHz. Then observe the display and increase the frequency until a display amplitude of 5.66 divisions is obtained.

k. CHECK—20 MHz bandwidth. The Generator frequency should be between 18 and 22 MHz.

l. At the 7A11, select FULL Bandwidth.

m. Disconnect the Probe and Termination from the Type 191 Constant Amplitude Signal Generator.

PARTS LIST ABBREVIATIONS

BHB	binding head brass	int	internal
BHS	binding head steel	lg	length or long
cap.	capacitor	met.	metal
cer	ceramic	mtg hdw	mounting hardware
comp	composition	OD	outside diameter
conn	connector	OHB	oval head brass
CRT	cathode-ray tube	OHS	oval head steel
csk	countersunk	PHB	pan head brass
DE	double end	PHS	pan head steel
dia	diameter	plstc	plastic
div	division	PMC	paper, metal cased
elect.	electrolytic	poly	polystyrene
EMC	electrolytic, metal cased	prec	precision
EMT	electrolytic, metal tubular	PT	paper, tubular
ext	external	PTM	paper or plastic, tubular, molded
F & I	focus and intensity	RHB	round head brass
FHB	flat head brass	RHS	round head steel
FHS	flat head steel	SE	single end
Fil HB	fillister head brass	SN or S/N	serial number
Fil HS	fillister head steel	SW	switch
h	height or high	TC	temperature compensated
hex.	hexagonal	THB	truss head brass
HHB	hex head brass	thk	thick
HHS	hex head steel	THS	truss head steel
HSB	hex socket brass	tub.	tubular
HSS	hex socket steel	var	variable
ID	inside diameter	w	wide or width
incd	incandescent	WW	wire-wound



PARTS ORDERING INFORMATION

Replacement parts are available from or through your local Tektronix, Inc. Field Office or representative.

Changes to Tektronix instruments are sometimes made to accommodate improved components as they become available, and to give you the benefit of the latest circuit improvements developed in our engineering department. It is therefore important, when ordering parts, to include the following information in your order: Part number, instrument type or number, serial or model number, and modification number if applicable.

If a part you have ordered has been replaced with a new or improved part, your local Tektronix, Inc. Field Office or representative will contact you concerning any change in part number.

SPECIAL NOTES AND SYMBOLS

- | | |
|---|---|
| ×000 | Part first added at this serial number |
| 00× | Part removed after this serial number |
| *000-0000-00 | Asterisk preceding Tektronix Part Number indicates manufactured by or for Tektronix, Inc., or reworked or checked components. |
| Use 000-0000-00 | Part number indicated is direct replacement. |
|  | Screwdriver adjustment. |
|  | Control, adjustment or connector. |

INDEX OF ELECTRICAL PARTS LIST

Title	Page No.
7A11 PROBE	6-1
CHASSIS	6-2
ATTEN-MAIN AMP Circuit Board Assembly	6-3
OFFSET Circuit Board Assembly	6-11
POLARITY Circuit Board Assembly	6-11
BANDWIDTH Circuit Board Assembly	6-11

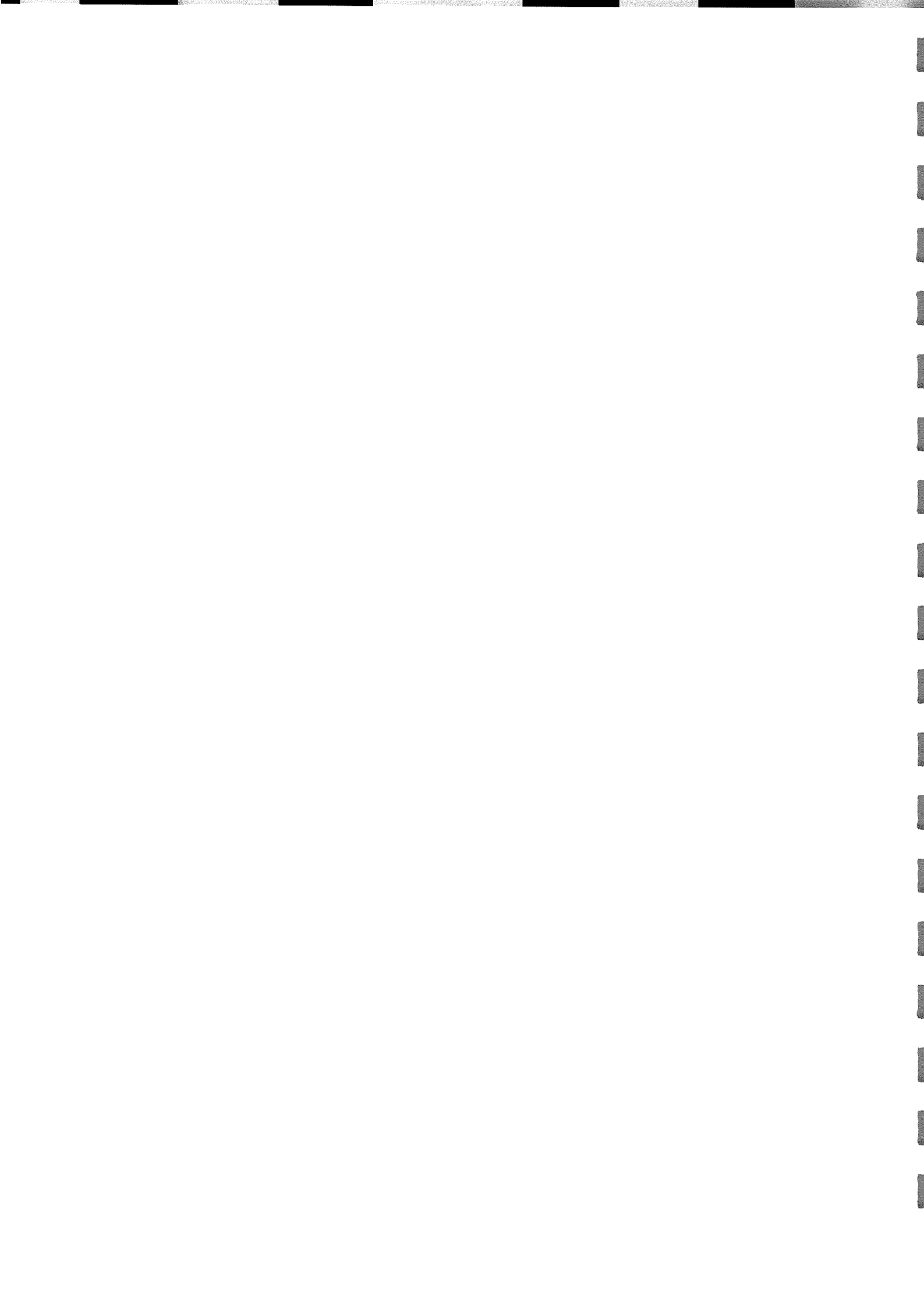

SECTION 6

ELECTRICAL PARTS LIST

Values are fixed unless marked Variable.

Ckt. No.	Tektronix Part No.	Serial/Model No. Eff	Disc	Description
----------	-----------------------	-------------------------	------	-------------

7A11 PROBE (*010-0251-00)

*670-1019-00

Complete Board

Capacitors

Tolerance $\pm 20\%$ unless otherwise indicated.

C1	283-0200-00		10 pF	Cer	50 V	10%
C4	281-0704-00		4.7 pF	Cer	100 V	10%
C5	283-0222-00		120 pF	Cer	50 V	
C6	281-0151-00		1-3 pF, Var	Cer		
C13	281-0151-00		1-3 pF, Var	Cer		
C15	283-0160-00		1.5 pF	Cer	50 V	10%
C16	283-0202-00		22 pF	Cer	50 V	10%
C18	281-0704-00		4.7 pF	Cer	100 V	10%
C22	283-0141-00		200 pF	Cer	600 V	10%
C23	283-0184-00		270 pF	Cer	50 V	
C24	283-0184-00		270 pF	Cer	50 V	
C25	283-0184-00		270 pF	Cer	50 V	
C33	283-0184-00		270 pF	Cer	50 V	
C42	283-0184-00		270 pF	Cer	50 V	
C44	283-0202-00		22 pF	Cer	50 V	10%
C49	283-0156-00		1000 pF	Cer	200 V	+100%—0%
C51	290-0308-00		1 μ F	Elect.	35 V	
C52	290-0308-00		1 μ F	Elect.	35 V	
C55	283-0184-00		270 pF	Cer	50 V	
C56	283-0184-00		270 pF	Cer	50 V	
C57	283-0184-00		270 pF	Cer	50 V	
C59	283-0184-00		270 pF	Cer	50 V	

Relays

K55	*148-0058-00	4 V DC, 130 Ω coil
K59	*148-0058-00	4 V DC, 130 Ω coil

Transistors

Q23	151-1034-00	Silicon	FET, dual
Q33	151-0294-00	Silicon	MMT4261
Q43	151-0293-00	Silicon	MMT3960A

Electrical Parts List—7A11

7A11 PROBE (cont)

Ckt. No.	Tektronix Part No.	Serial/Model No. Eff	Disc	Description
Resistors				
Resistors are fixed, composition, $\pm 10\%$ unless otherwise indicated.				
R1	317-0360-00		36 Ω	$\frac{1}{8}$ W 5%
R4	317-0219-00		200 Ω	10%
R5 } R6 }	325-0050-00		950 k Ω 52.63 k Ω	Selected (matched pair)
R12 } R13 }	325-0050-00		950 k Ω 52.63 k Ω	
R15	307-0118-00		500 Ω	$\frac{1}{10}$ W 10%
R16	307-0117-00		2 k Ω	$\frac{1}{10}$ W 10%
R18	307-0228-00		50 Ω	10%
R19	307-0252-00		270 Ω	5%
R20	307-0244-00		1 k Ω	Thermal
R21	325-0049-00		1 M Ω	$\frac{1}{20}$ W Prec 1%
R22	317-0105-00		1 M Ω	$\frac{1}{8}$ W 5%
R24	325-0048-00		21 Ω	$\frac{1}{20}$ W Prec 1%
R26	325-0048-00		21 Ω	$\frac{1}{20}$ W Prec 1%
R28	317-0683-00		68 k Ω	$\frac{1}{8}$ W 5%
R34	317-0122-00		1.2 k Ω	$\frac{1}{8}$ W 5%
R42	317-0101-00		100 Ω	$\frac{1}{8}$ W 5%
R43	321-0161-00		464 Ω	$\frac{1}{8}$ W Prec 1%
R44	317-0200-00		20 Ω	$\frac{1}{8}$ W 5%
R45	311-0987-00		200 Ω , Var	
R46	307-0227-00		150 Ω	5%
R47	317-0101-00		100 Ω	$\frac{1}{8}$ W 5%
R49	321-0201-00		1.21 k	$\frac{1}{8}$ W Prec 1%

CHASSIS

Capacitors

Tolerance $\pm 20\%$ unless otherwise indicated.

C102	281-0649-00		1000 pF	Cer	500 V	+80%—20%
C103	281-0649-00		1000 pF	Cer	500 V	+80%—20%
C104	281-0649-00		1000 pF	Cer	500 V	+80%—20%
C105	281-0649-00		1000 pF	Cer	500 V	+80%—20%
C106	281-0649-00		1000 pF	Cer	500 V	+80%—20%
C107	281-0649-00		1000 pF	Cer	500 V	+80%—20%
C108	281-0649-00		1000 pF	Cer	500 V	+80%—20%
C109	281-0649-00		1000 pF	Cer	500 V	+80%—20%
C110	281-0649-00		1000 pF	Cer	500 V	+80%—20%
C142	283-0209-00		1 μ F	Cer	50 V	

CHASSIS (cont)

Ckt. No.	Tektronix Part No.	Serial/Model No. Eff	Disc	Description
----------	--------------------	----------------------	------	-------------

Connector

J339	131-0407-00			Jack
------	-------------	--	--	------

Resistors

Resistors are fixed, composition, $\pm 10\%$ unless otherwise indicated.

R115	311-0345-00		20 k Ω , Var		
R138	311-0993-00		1 k Ω , Var		
R141	317-0047-00		4.7 Ω	$\frac{1}{8}$ W	5%
R142	317-0560-00		56 Ω	$\frac{1}{8}$ W	5%
R180 ¹	311-0095-00		500 Ω , Var		
R220 ²	311-0652-00		2 x 5 k Ω , Var		
R300	311-0955-00		2 k Ω , Var		

Switches

Wired or Unwired

S180A, B³
S420⁴

ATTEN-MAIN AMP Circuit Board Assembly

*670-1108-00

Complete Board

Capacitors

Tolerance $\pm 20\%$ unless otherwise indicated.

C124	283-0195-00		680 pF	Cer	50 V	10%
C131	281-0122-00		2.5-9 pF, Var	Cer		
C134	281-0122-00		2.5-9 pF, Var	Cer		
C144	283-0197-00		470 pF	Cer	50 V	10%
C153	283-0630-00		110 pF	Mica	100 V	1%
C154	283-0663-00		16.8 pF	Mica	500 V	± 0.5 pF
C203	281-0122-00		2.5-9 pF, Var	Cer		
C204	283-0197-00		470 pF	Cer	50 V	10%
C211	283-0221-00		0.47 μ F	Cer	50 V	
C214	283-0197-00		470 pF	Cer	50 V	10%

¹Furnished as a unit with S180A,B.²Furnished as a unit with S420.³Furnished as a unit with R180.⁴Furnished as a unit with R220.

ATTEN-MAIN AMP Circuit Board Assembly (cont)

Kct. No.	Tektronix Part No.	Serial/Model No. Eff	Disc	Description		
Capacitors (cont)						
C234	281-0064-00		0.25-1.5 pF, Var	Tub.		
C245	281-0122-00		2.5-9 pF, Var	Cer		
C246	283-0213-00		300 pF	Cer	100 V	5%
C255	281-0092-00		9-35 pF, Var	Cer		
C256	283-0213-00		300 pF	Cer	100 V	5%
C258	283-0177-00		1 μ F	Cer	25 V	+80%—20%
C261	281-0122-00		2.5-9 pF, Var	Cer		
C264	283-0195-00		680 pF	Cer	50 V	10%
C274	283-0195-00		680 pF	Cer	50 V	10%
C279	283-0067-00		0.001 μ F	Cer	200 V	10%
C287	283-0195-00		680 pF	Cer	50 V	10%
C295	281-0576-00		11 pF	Cer	500 V	5%
C297	283-0195-00		680 pF	Cer	50 V	10%
C304	290-0290-00		10 μ F	Elect.	25 V	
C317	283-0177-00		1 μ F	Cer	25 V	+80%—20%
C335	283-0177-00		1 μ F	Cer	25 V	+80%—20%
C345	283-0220-00		0.01 μ F	Cer	50 V	
C506	283-0001-00		0.005 μ F	Cer	500 V	
C518	283-0001-00		0.005 μ F	Cer	500 V	
C526	283-0003-00		0.01 μ F	Cer	150 V	
C538	283-0001-00		0.005 μ F	Cer	500 V	
C546	283-0001-00		0.005 μ F	Cer	500 V	
C562	290-0177-00		1 μ F	Elect.	50 V	
C564	283-0177-00		1 μ F	Cer	25 V	+80%—20%
C567	283-0000-00		0.001 μ F	Cer	500 V	
C568	283-0177-00		1 μ F	Cer	25 V	+80%—20%
C569	283-0177-00		1 μ F	Cer	25 V	+80%—20%
C572	290-0177-00		1 μ F	Elect.	50 V	
C574	283-0177-00		1 μ F	Cer	25 V	+80%—20%
C575	290-0135-00		15 μ F	Elect.	20 V	

Relays

K401	*148-0034-00		Armature, dpdt, 15 V DC
K403	*148-0034-00		Armature, dpdt, 15 V DC
K405	*148-0034-00		Armature, dpdt, 15 V DC
K407	*148-0034-00		Armature, dpdt, 15 V DC
K411	*148-0034-00		Armature, dpdt, 15 V DC
K413	*148-0034-00		Armature, dpdt, 15 V DC
K415	*148-0034-00		Armature, dpdt, 15 V DC
K417	*148-0034-00		Armature, dpdt, 15 V DC
K431	*148-0034-00		Armature, dpdt, 15 V DC

ATTEN-MAIN AMP Circuit Board Assembly (cont)

Ckt. No.	Tektronix Part No.	Serial/Model No. Eff	Disc	Description
Semiconductor Device, Diodes				
VR124	152-0278-00		Zener	1N4372A 400 mW, 3 V, 5%
VR144	152-0195-00		Zener	1N751A 400 mW, 5.1 V, 5%
VR264	152-0226-00		Zener	1N751A 400 mW, 5.1 V, 5%
VR274	152-0226-00		Zener	1N751A 400 mW, 5.1 V, 5%
CR306	*152-0185-00		Silicon	Replaceable by 1N4152
CR309	*152-0185-00		Silicon	Replaceable by 1N4152
CR326	*152-0185-00		Silicon	Replaceable by 1N4152
CR329	*152-0185-00		Silicon	Replaceable by 1N4152
CR401	*152-0185-00		Silicon	Replaceable by 1N4152
CR405	*152-0185-00		Silicon	Replaceable by 1N4152
CR411	*152-0185-00		Silicon	Replaceable by 1N4152
CR415	*152-0185-00		Silicon	Replaceable by 1N4152
CR424	*152-0185-00		Silicon	Replaceable by 1N4152
CR431	*152-0185-00		Silicon	Replaceable by 1N4152
Inductors				
L126	*108-0569-00		55 nH	
L146	*108-0569-00		55 nH	
L148	108-0245-00		3.9 μ H	
L152	*108-0262-01		0.6 μ H	
L155	*108-0262-01		0.6 μ H	
L174	*108-0570-00		62 nH	
L177	*108-0570-00		62 nH	
L242	108-0245-00		3.9 μ H	
L272	108-0245-00		3.9 μ H	
L282	*108-0373-00		56 nH	
L285	108-0245-00		3.9 μ H	
L419	108-0245-00		3.9 μ H	
L433	108-0245-00		3.9 μ H	
L562	108-0538-00		2.7 μ H	
L564	108-0538-00		2.7 μ H	
L565	108-0538-00		2.7 μ H	
L568	108-0538-00		2.7 μ H	
L569	108-0538-00		2.7 μ H	
L572	108-0538-00		2.7 μ H	
L574	108-0538-00		2.7 μ H	
Transistors				
Q124A, B	*151-0272-00		Silicon	Dual, Tek Spec
Q184	151-0220-00		Silicon	2N4122
Q194)	*153-0582-00		Silicon	Matched pair
Q198)				
Q204A, B	*151-0268-00		Silicon	Dual, Tek Spec

ATTEN-MAIN AMP Circuit Board Assembly (cont)

Ckt. No.	Tektronix Part No.	Serial/Model No. Eff	Disc	Description
Transistors (cont)				
Q224	*151-0212-00		Silicon	Tek Spec
Q234	*151-0212-00		Silicon	Tek Spec
Q244	151-0296-00		Silicon	Selected from MM4049
Q248	151-0202-00		Silicon	2N4261
Q254	151-0296-00		Silicon	Selected from MM4049
Q258	151-0202-00		Silicon	2N4261
Q264	*151-0212-00		Silicon	Tek Spec
Q274	*151-0212-00		Silicon	Tek Spec
Q284	151-0269-00		Silicon	High frequency
Q294	151-0269-00		Silicon	High frequency
Q312	*151-0183-00		Silicon	Selected from 2N2192
Q314	*151-0134-00		Silicon	Replaceable by 2N2905
Q332	*151-0183-00		Silicon	Selected from 2N2192
Q334	*151-0134-00		Silicon	Replaceable by 2N2905
Q424	151-0220-00		Silicon	2N4122
Q444	151-0254-00		Silicon	D16P4
Q506	151-0223-00		Silicon	2N4275
Q513	151-0220-00		Silicon	2N4122
Q516	151-0223-00		Silicon	2N4275
Q523	151-0220-00		Silicon	2N4122
Q526	151-0260-00		Silicon	2N5189
Q533	151-0224-00		Silicon	2N3692
Q536	151-0220-00		Silicon	2N4122
Q544	151-0220-00		Silicon	2N4122

Resistors

Resistors are fixed, composition, $\pm 10\%$ unless otherwise indicated.

R116	315-0563-00	56 k Ω	$\frac{1}{4}$ W	5%
R117	315-0473-00	47 k Ω	$\frac{1}{4}$ W	5%
R120	311-1004-00	20 k Ω , Var		
R121	315-0103-00	10 k Ω	$\frac{1}{4}$ W	5%
R122	317-0183-00	18 k Ω	$\frac{1}{8}$ W	5%
R124	321-0104-00	118 Ω	$\frac{1}{8}$ W	Prec 1%
R126	325-0052-00	80 Ω	$\frac{1}{20}$ W	Prec $\frac{1}{2}\%$
R127	325-0045-00	46.4 Ω	$\frac{1}{20}$ W	Prec $\frac{1}{2}\%$
R134	311-0605-00	200 Ω , Var		
R137	317-0101-00	100 Ω	$\frac{1}{8}$ W	5%
R139	317-0101-00	100 Ω	$\frac{1}{8}$ W	5%
R144	321-0125-00	196 Ω	$\frac{1}{8}$ W	Prec 1%
R146	325-0052-00	80 Ω	$\frac{1}{20}$ W	Prec $\frac{1}{2}\%$
R147	325-0045-00	46.4 Ω	$\frac{1}{20}$ W	Prec $\frac{1}{2}\%$
R148	323-0117-00	162 Ω	$\frac{1}{2}$ W	Prec 1%

ATTEN-MAIN AMP Circuit Board Assembly (cont)

Ckt. No.	Tektronix Part No.	Serial/Model No. Eff	Disc	Description		
Resistors (cont)						
R149	323-0117-00		162 Ω	$\frac{1}{2}$ W	Prec	1%
R156	321-0657-07		60 Ω	$\frac{1}{8}$ W	Prec	1/10%
R157	321-0609-07		480 Ω	$\frac{1}{8}$ W	Prec	1/10%
R158	321-0609-07		480 Ω	$\frac{1}{8}$ W	Prec	1/10%
R159	321-0657-07		60 Ω	$\frac{1}{8}$ W	Prec	1/10%
R162	321-0657-07		60 Ω	$\frac{1}{8}$ W	Prec	1/10%
R163	321-0609-07		480 Ω	$\frac{1}{8}$ W	Prec	1/10%
R164	321-0609-07		480 Ω	$\frac{1}{8}$ W	Prec	1/10%
R165	321-0657-07		60 Ω	$\frac{1}{8}$ W	Prec	1/10%
R166	321-0819-07		84 Ω	$\frac{1}{8}$ W	Prec	1/10%
R167	321-0318-07		373.3 Ω	$\frac{1}{8}$ W	Prec	1/10%
R168	321-0818-07		373.3 Ω	$\frac{1}{8}$ W	Prec	1/10%
R169	321-0819-07		84 Ω	$\frac{1}{8}$ W	Prec	1/10%
R175	325-0052-00		80 Ω	$\frac{1}{20}$ W	Prec	$\frac{1}{2}$ %
R176	325-0052-00		80 Ω	$\frac{1}{20}$ W	Prec	$\frac{1}{2}$ %
R181	321-0140-00		280 Ω	$\frac{1}{8}$ W	Prec	1%
R182	322-0633-00		2.304 k Ω	$\frac{1}{8}$ W	Prec	$\frac{1}{4}$ %
R183	321-0890-06		88.8 Ω	$\frac{1}{8}$ W	Prec	$\frac{1}{4}$ %
R184	321-0821-00		2.12 k Ω	$\frac{1}{8}$ W	Prec	1%
R191	321-0782-03		40 Ω	$\frac{1}{8}$ W	Prec	$\frac{1}{4}$ %
R192	321-0782-03		40 Ω	$\frac{1}{8}$ W	Prec	$\frac{1}{4}$ %
R193	322-0633-00		2.304 k Ω	$\frac{1}{8}$ W	Prec	$\frac{1}{4}$ %
R195	317-0103-00		10 k Ω	$\frac{1}{8}$ W		5%
R196	317-0104-00		100 k Ω	$\frac{1}{8}$ W		5%
R198	317-0203-00		20 k Ω	$\frac{1}{8}$ W		5%
R202	325-0048-00		21 Ω	$\frac{1}{20}$ W	Prec	1%
R204	321-0146-00		324 Ω	$\frac{1}{8}$ W	Prec	1%
R206	317-0203-00		20 k Ω	$\frac{1}{8}$ W		5%
R211	311-0635-00		1 k Ω , Var			
R212	325-0048-00		21 Ω	$\frac{1}{20}$ W	Prec	1%
R213	323-0131-00		226 Ω	$\frac{1}{2}$ W	Prec	1%
R214	321-0146-00		324 Ω	$\frac{1}{8}$ W	Prec	1%
R216	317-0203-00		20 k Ω	$\frac{1}{8}$ W		5%
R221	315-0391-00		390 Ω	$\frac{1}{4}$ W		5%
R222	323-0201-00		1.21 k Ω	$\frac{1}{2}$ W	Prec	1%
R223	321-0143-00		301 Ω	$\frac{1}{8}$ W	Prec	1%
R224	317-0201-00		200 Ω	$\frac{1}{8}$ W		5%
R226	321-0086-00		76.8 Ω	$\frac{1}{8}$ W	Prec	1%
R228	317-0103-00		10 k Ω	$\frac{1}{8}$ W		5%
R229	317-0103-00		10 k Ω	$\frac{1}{8}$ W		5%
R234	317-0201-00		200 Ω	$\frac{1}{8}$ W		5%
R236	321-0086-00		76.8 Ω	$\frac{1}{8}$ W	Prec	1%
R237	321-0028-00		19.1 Ω	$\frac{1}{8}$ W	Prec	1%
R238	317-0103-00		10 k Ω	$\frac{1}{8}$ W		5%
R239	317-0103-00		10 k Ω	$\frac{1}{8}$ W		5%

ATTEN-MAIN AMP Circuit Board Assembly (cont)

Ckt. No.	Tektronix Part No.	Serial/Model No. Eff	Disc	Description		
Resistors (cont)						
R240	311-0541-00			20 k Ω , Var		
R242	323-0131-00			226 Ω	1/2 W	Prec 1%
R243	325-0051-00			18.2 Ω	1/20 W	Prec 1%
R246	321-0145-00			324 Ω	1/8 W	Prec 1%
R247	321-0142-00			294 Ω	1/8 W	Prec 1%
R248	323-0201-00			1.21 k Ω	1/2 W	Prec 1%
R249	321-0094-00			93.1 Ω	1/8 W	Prec 1%
R253	325-0051-00			18.2 Ω	1/20 W	Prec 1%
R254	317-0101-00			100 Ω	1/8 W	5%
R255	311-0534-00			500 Ω , Var		
R256	321-0145-00			324 Ω	1/8 W	Prec 1%
R257	317-0101-00			100 Ω	1/8 W	5%
R258	321-0004-00			10.7 Ω	1/8 W	Prec 1%
R259	321-0094-00			93.1 Ω	1/8 W	Prec 1%
R261	325-0048-00			21 Ω	1/20 W	Prec 1%
R264	321-0133-00			237 Ω	1/8 W	Prec 1%
R266	321-0771-03			50 Ω	1/8 W	Prec 1/4%
R269	315-0303-00			30 k Ω	1/4 W	5%
R271	325-0048-00			21 Ω	1/20 W	Prec 1%
R272	323-0131-00			226 Ω	1/2 W	Prec 1%
R274	321-0133-00			237 Ω	1/8 W	Prec 1%
R276	321-0771-03			50 Ω	1/8 W	Prec 1/4%
R278	323-0090-00			84.5 Ω	1/2 W	Prec 1%
R279	321-0056-00			37.4 Ω	1/8 W	Prec 1%
R281	317-0470-00			47 Ω	1/8 W	5%
R282	321-0102-00			113 Ω	1/8 W	Prec 1%
R284	321-0150-00			357 Ω	1/8 W	Prec 1%
R285	311-0433-00			100 Ω , Var		
R287	321-0135-00			249 Ω	1/8 W	Prec 1%
R289	323-0193-00			1 k Ω	1/2 W	Prec 1%
R291	317-0470-00			47 Ω	1/8 W	5%
R294	321-0150-00			357 Ω	1/8 W	Prec 1%
R295	325-0055-00			30.1 Ω	1/20 W	Prec 1%
R296	317-0471-00			470 Ω	1/8 W	5%
R297	321-0135-00			249 Ω	1/8 W	Prec 1%
R299	323-0193-00			1 k Ω	1/2 W	Prec 1%
R301	321-0122-00			182 Ω	1/8 W	Prec 1%
R302	321-0122-00			182 Ω	1/8 W	Prec 1%
R304	315-0102-00			1 k Ω	1/4 W	5%
R306	315-0104-00			100 k Ω	1/4 W	5%
R307	315-0391-00			390 Ω	1/4 W	5%
R308	315-0391-00			390 Ω	1/4 W	5%
R309	315-0104-00			100 k Ω	1/4 W	5%
R312	315-0200-00			20 Ω	1/4 W	5%
R314	315-0200-00			20 Ω	1/4 W	5%

ATTEN-MAIN AMP Circuit Board Assembly (cont)

Ckt. No.	Tektronix Part No.	Serial/Model No. Eff	Disc	Description			
Resistors (cont)							
R317	322-0197-00		1.1 k Ω	1/8 W	Prec		1%
R319	321-0260-00		4.99 k Ω	1/8 W	Prec		1%
R320	311-0496-00		2.5 k Ω , Var				
R321	321-0168-00		549 Ω	1/8 W	Prec		1%
R322	321-0684-00		15 k Ω	1/8 W	Prec		1/2%
R326	315-0104-00		100 k Ω	1/4 W			5%
R327	315-0391-00		390 Ω	1/4 W			5%
R328	315-0391-00		390 Ω	1/4 W			5%
R329	315-0104-00		100 k Ω	1/4 W			5%
R332	315-0200-00		20 Ω	1/4 W			5%
R334	315-0200-00		20 Ω	1/4 W			5%
R335	321-0584-00		15 k Ω	1/8 W	Prec		1/2%
R340	321-0355-00		49.9 k Ω	1/8 W	Prec		1%
R341	316-0336-00		33 M Ω	1/4 W			
R343	321-0318-00		20 k Ω	1/8 W	Prec		1%
R344	321-0338-00		32.4 k Ω	1/8 W	Prec		1%
R345	311-0497-00		50 k Ω , Var				
R346	316-0336-00		33 M Ω	1/4 W			
R347	321-0362-00		57.6 k Ω	1/8 W	Prec		1%
R421	317-0303-00		30 k Ω	1/8 W			5%
R424	315-0333-00		33 k Ω	1/4 W			5%
R431	315-0753-00		75 k Ω	1/4 W			5%
R435	315-0154-00		150 k Ω	1/4 W			5%
R436	315-0154-00		150 k Ω	1/4 W			5%
R438	315-0154-00		150 k Ω	1/4 W			5%
R439	315-0133-00		13 k Ω	1/4 W			5%
R442	315-0154-00		150 k Ω	1/4 W			5%
R443	315-0123-00		12 k Ω	1/4 W			5%
R444	315-0753-00		75 k Ω	1/4 W			5%
R446	321-0356-00		49.9 k Ω	1/8 W	Prec		1%
R447	315-0154-00		150 k Ω	1/4 W			5%
R449	321-0344-00		37.4 k Ω	1/8 W	Prec		1%
R451	321-0344-00		37.4 k Ω	1/8 W	Prec		1%
R452	315-0154-00		150 k Ω	1/4 W			5%
R453	315-0753-00		75 k Ω	1/4 W			5%
R454	315-0753-00		75 k Ω	1/4 W			5%
R500	311-0510-00		10 k Ω , Var				
R501	315-0822-00		8.2 k Ω	1/4 W			5%
R502	323-0166-00		523 Ω	1/2 W	Prec		1%
R503	323-0192-00		976 Ω	1/2 W	Prec		1%
R504	308-0218-00		150 Ω	3 W	WW		5%
R506	315-0100-00		10 Ω	1/4 W			5%
R511	321-0321-00		21.5 k Ω	1/8 W	Prec		1%
R512	321-0246-00		3.57 k Ω	1/8 W	Prec		1%
R514	315-0362-00		3.6 k Ω	1/4 W			5%

Electrical Parts List—7A11

ATTEN-MAIN AMP Circuit Board Assembly (cont)

Ckt. No.	Tektronix Part No.	Serial/Model No. Eff	No. Disc	Description		
Resistors (cont)						
R516	308-0218-00		150 Ω	3 W	WW	5%
R518	315-0100-00		10 Ω	1/4 W		5%
R519	315-0102-00		1 k Ω	1/4 W		5%
R521	321-0162-00		475 Ω	1/8 W	Prec	1%
R522	321-0166-00		523 Ω	1/8 W	Prec	1%
R524	315-0181-00		180 Ω	1/4 W		5%
R526	308-0503-00		6.8 Ω	2.5 W	WW	5%
R528	315-0271-00		270 Ω	1/4 W		5%
R531	321-0246-00		3.57 k Ω	1/8 W	Prec	1%
R532	321-0321-00		21.5 k Ω	1/8 W	Prec	1%
R534	315-0362-00		3.6 k Ω	1/4 W		5%
R536	308-0218-00		150 Ω	3 W	WW	5%
R538	315-0100-00		10 Ω	1/4 W		5%
R539	315-0102-00		1 k Ω	1/4 W		5%
R540	311-0510-00		10 k Ω , Var			
R541	315-0822-00		8.2 k Ω	1/4 W		5%
R542	323-0192-00		976 Ω	1/2 W	Prec	1%
R543	323-0166-00		523 Ω	1/2 W	Prec	1%
R544	308-0218-00		150 Ω	3 W	WW	5%
R545	308-0431-00		120 Ω	3 W	WW	5%
R546	315-0100-00		10 Ω	1/4 W		5%
R547	321-0193-00		1 k Ω	1/8 W	Prec	1%
R548	321-0136-00		255 Ω	1/8 W	Prec	1%
R561	315-0510-00		51 Ω	1/4 W		5%
R567	315-0470-00		47 Ω	1/4 W		5%
R571	315-0510-00		51 Ω	1/4 W		5%

Switch

Wired or Unwired

S440 [†]	*670-1108-00	Cam	VOLTS/DIV
-------------------	--------------	-----	-----------

Transformer

T124	*120-0644-00	5 turns, twisted bifilar
------	--------------	--------------------------

Integrated Circuits

U194	156-0049-00	Oper. ampl. TO-99	Replaceable by Fairchild μ A741C
U324	156-0049-00	Oper. ampl. TO-99	Replaceable by Fairchild μ A741C
U345	156-0049-00	Oper. ampl. TO-99	Replaceable by Fairchild μ A741C

[†]See Mechanical Parts List for replacement parts.

OFFSET Circuit Board Assembly

Ckt. No.	Part No. Tektronix	Serial/Model No. Eff	No. Disc	Description
	*670-1109-00			Complete Board
				Bulb
DS315	*150-0057-01			Incandescent 7153AS15, selected
				Switch
S315A, B ^a	*670-1109-00			Pushbutton OFFSET

POLARITY Circuit Board Assembly

	*670-1110-00			Complete Board
				Bulb
S430	*150-0057-01			Incandescent 7153AS15, selected
				Switch
	Wired or Unwired			
S430 ^a	*670-1110-00			Pushbutton POLARITY

BANDWIDTH Circuit Board Assembly

	*670-1111-00			Complete Board
				Bulb
DS400	*150-0057-01			Incandescent 7153AS15, selected
				Switch
	Wired or Unwired			
S400 ^a	*670-1111-00			Pushbutton BANDWIDTH

^aSee Mechanical Parts List for replacement parts.

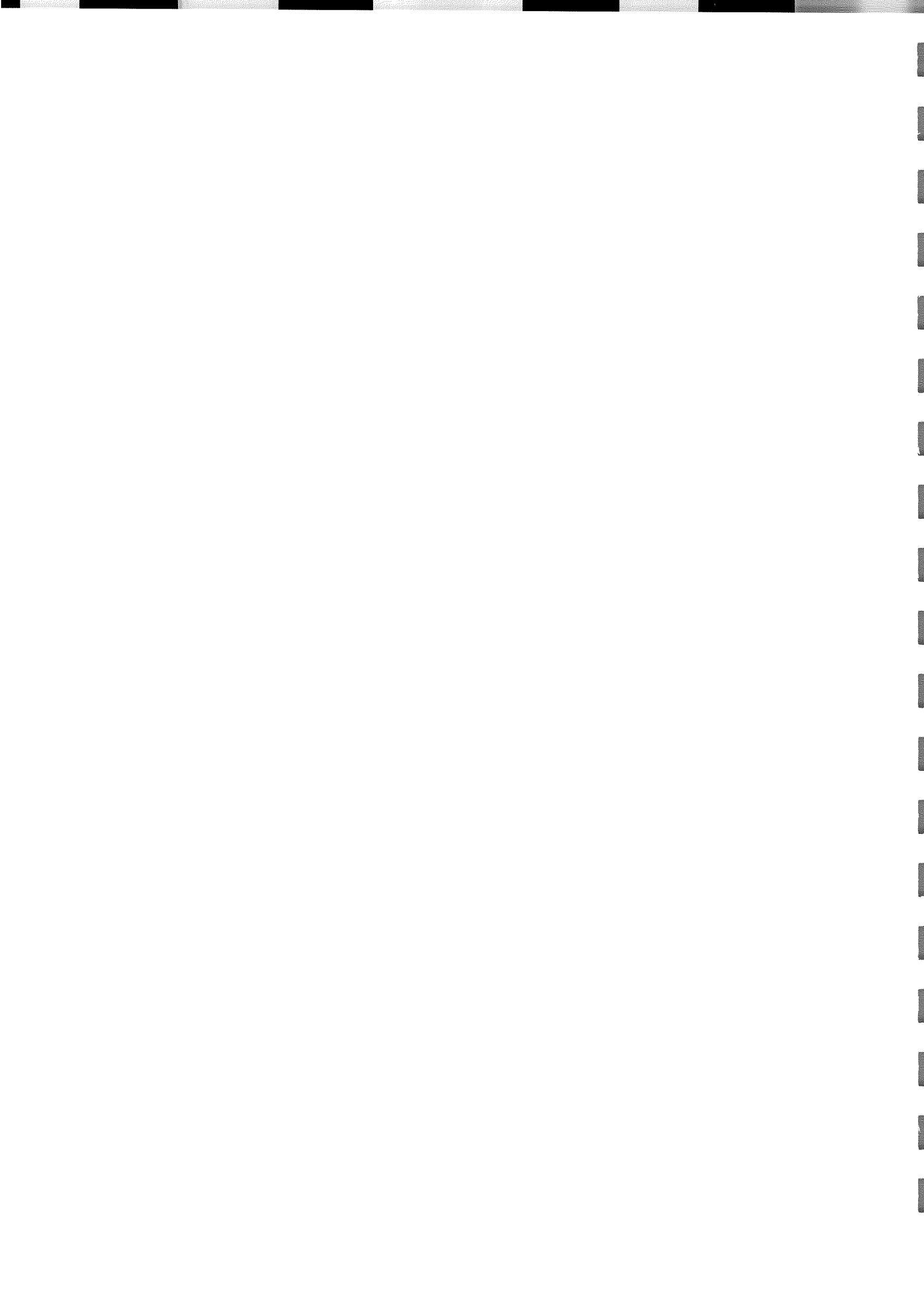

SECTION 7 DIAGRAMS and MECHANICAL PARTS ILLUSTRATIONS

The following special symbols are used on the diagrams:

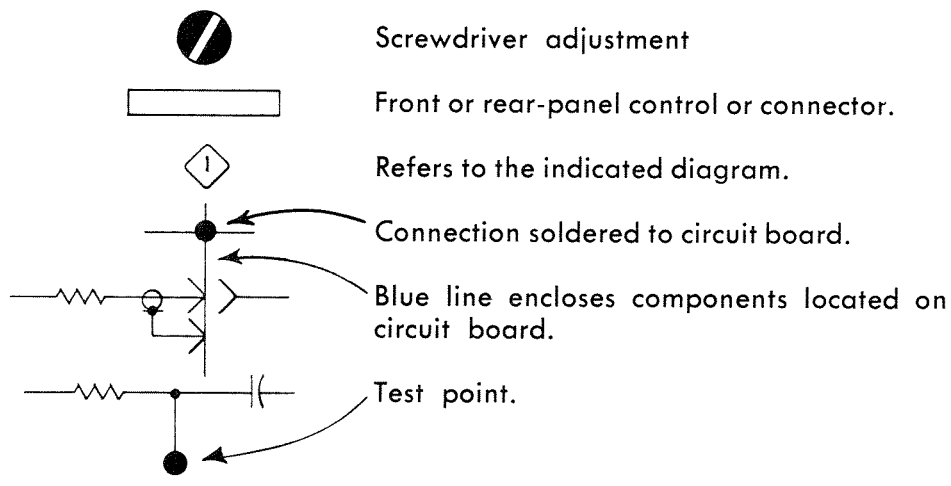

VOLTAGE AND WAVEFORM INFORMATION

General. Typical voltages and waveforms appear in blue on the schematics. A plug-in extender was used to permit access to all points indicated. Some slight deviations of voltages and waveforms can be expected between individual instruments. Variations may also occur because of the type of test equipment involved in making observations. The 7A11 was set up as follows:

POSITION	Display centered
OFFSET	OFF, except where noted otherwise
POLARITY	+UP
BANDWIDTH	20 MHz
STEP ATTEN BAL	Adjusted for no trace shift accompanying switching between + UP and INVERT
VOLTS/DIV	10 mV for voltages; 50 mV for waveforms
VARIABLE	CAL

Voltages. Voltages were taken with a high impedance voltmeter. No signal was applied to the 7A11 Probe.

Waveforms. Waveforms are reproductions of photographs obtained with a Tektronix C12 Oscilloscope Camera system. The Camera system was mounted on a Tektronix 7000-Series Oscilloscope which was equipped with a 7B50 Time Base, a 7A16 Amplifier unit, and a X10 probe. A 0.4 V 1 kHz square wave signal from the Oscilloscope's Calibrator was applied to the 7A11 Probe tip and was also applied to the Test Oscilloscope External Trigger input jack to externally trigger the trace, providing time-related waveforms. The Test Oscilloscope deflection factor was 0.1 V/division (including the X10 probe), the sweep rate was 0.5 ms/division, and AC-coupling was used for all waveforms.

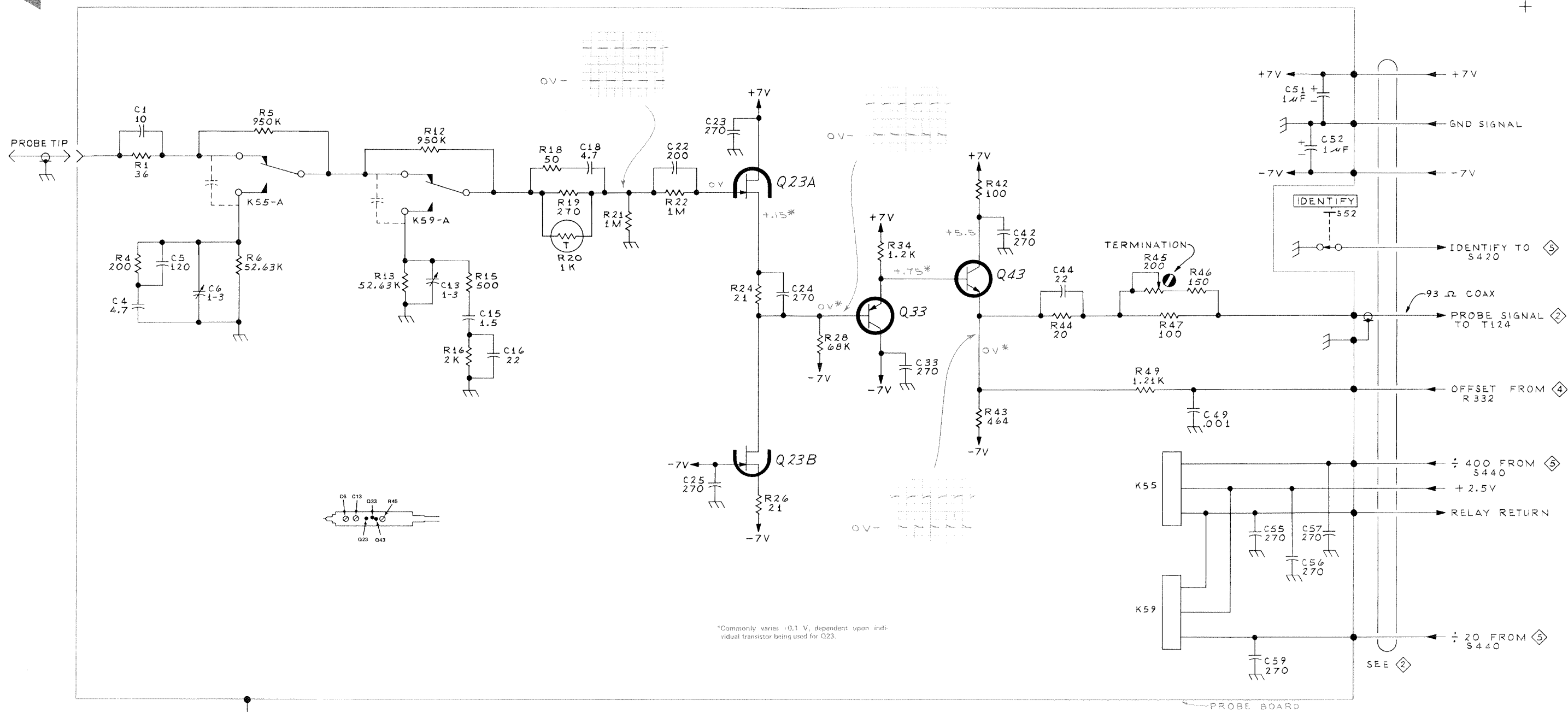

BOARD GROUND
CONNECTED TO
CASE GROUND THRU
MOUNTING SCREW
CONTACTS.

NOTE:
1 SEE PARTS LIST FOR
SEMICONDUCTOR TYPES.

- REFERENCE DIAGRAMS
- ② INPUT AMPLIFIER
 - ④ OFFSET GENERATOR
 - ⑤ VOLTS-DIV. SWITCH
& READOUT

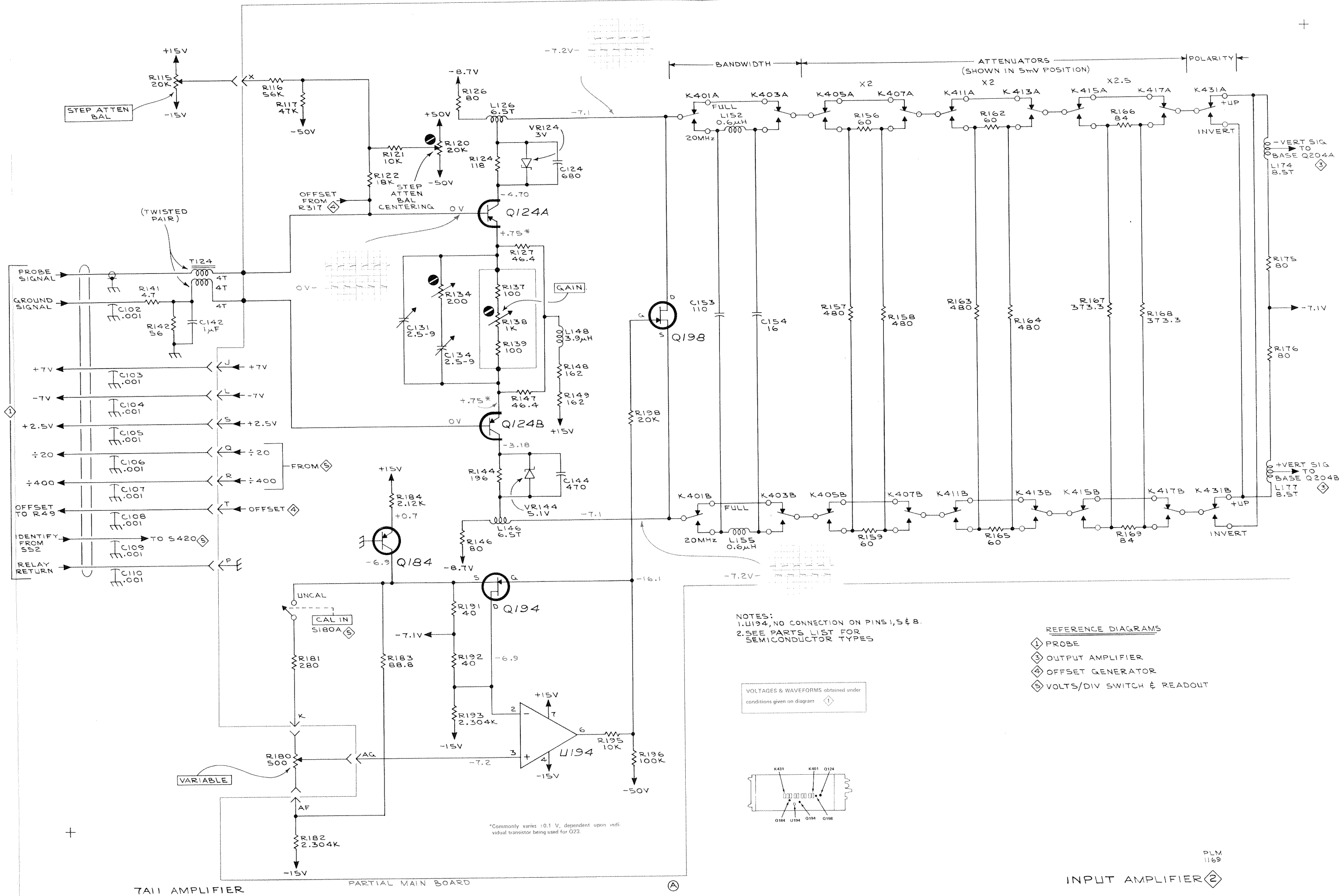

INPUT AMPLIFIER 2

NOTES:
 1. U194, NO CONNECTION ON PINS 1, 5 & 8.
 2. SEE PARTS LIST FOR SEMICONDUCTOR TYPES

VOLTAGES & WAVEFORMS obtained under conditions given on diagram ①

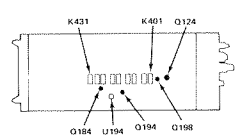

- REFERENCE DIAGRAMS
- ① PROBE
 - ② OUTPUT AMPLIFIER
 - ③ OFFSET GENERATOR
 - ④ VOLTS/DIV SWITCH & READOUT

*Commonly varies ± 0.1 V, dependent upon individual transistor being used for Q23.

PLM 1169

INPUT AMPLIFIER ②

TAIL AMPLIFIER

PARTIAL MAIN BOARD

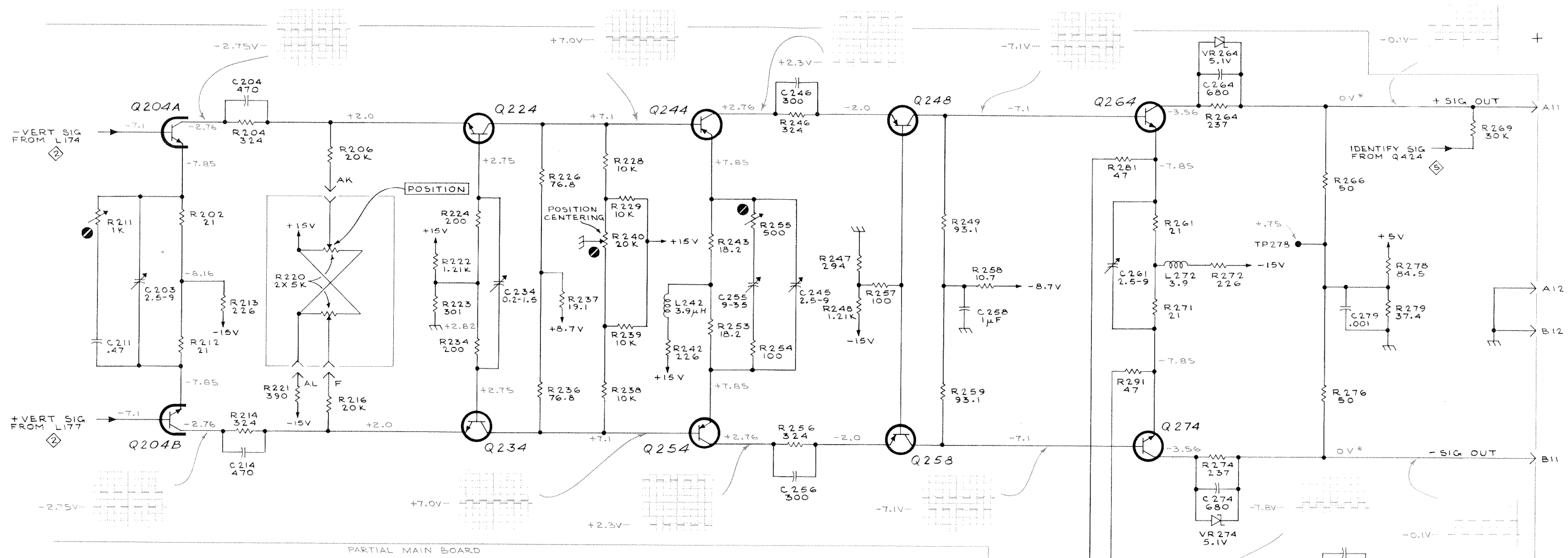

PARTIAL MAIN BOARD

REFERENCE DIAGRAMS:

- ② INPUT AMPLIFIER
- ⑤ VOLTS/DIV SWITCH & READOUT

SEE PARTS LIST FOR SEMICONDUCTOR TYPES

VOLTAGES & WAVEFORMS obtained under conditions given on diagram

*Commonly varies +0.1 V, dependent upon unit virtual transistor being used for Q23

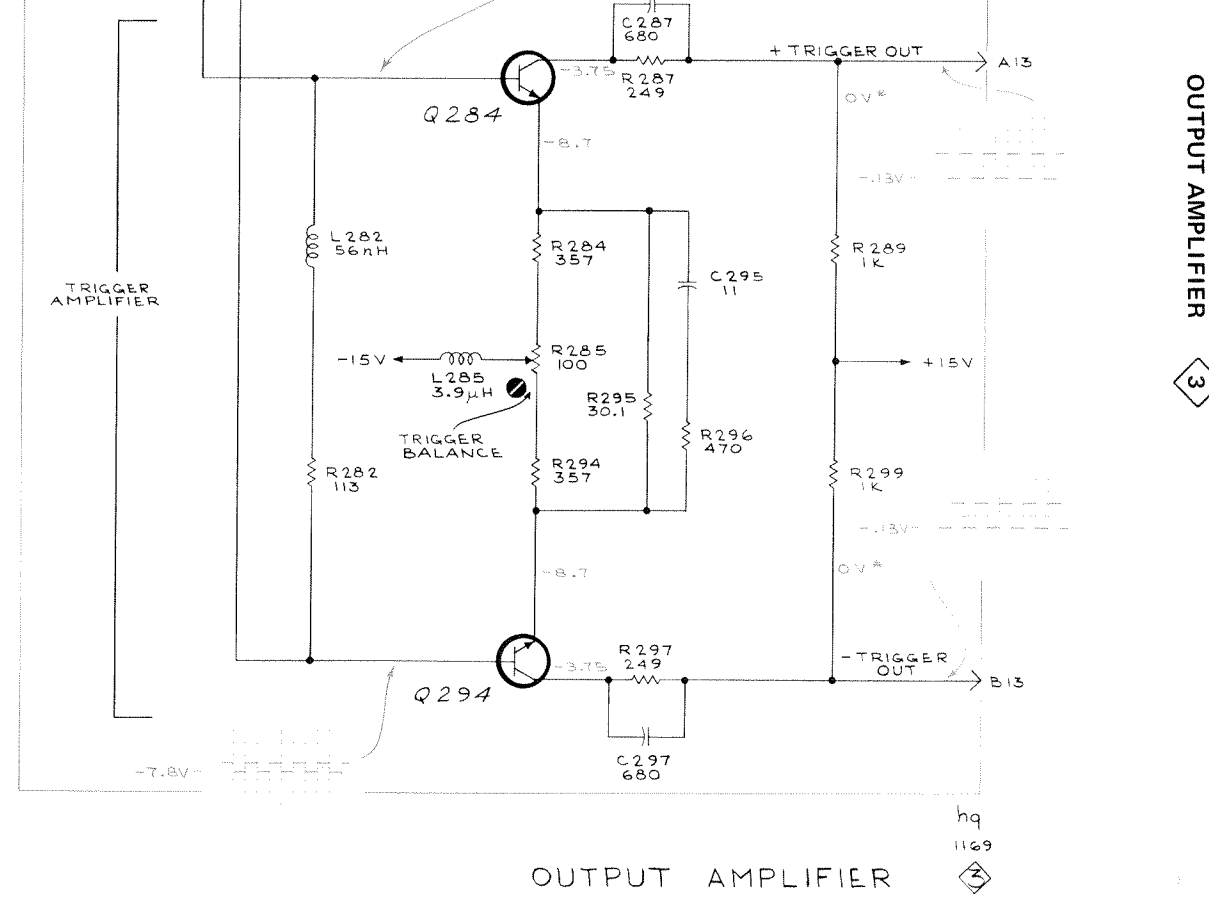
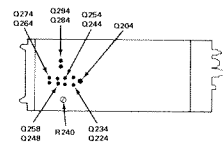

OUTPUT AMPLIFIER ③

7AII AMPLIFIER

OUTPUT AMPLIFIER ③

hq
1169

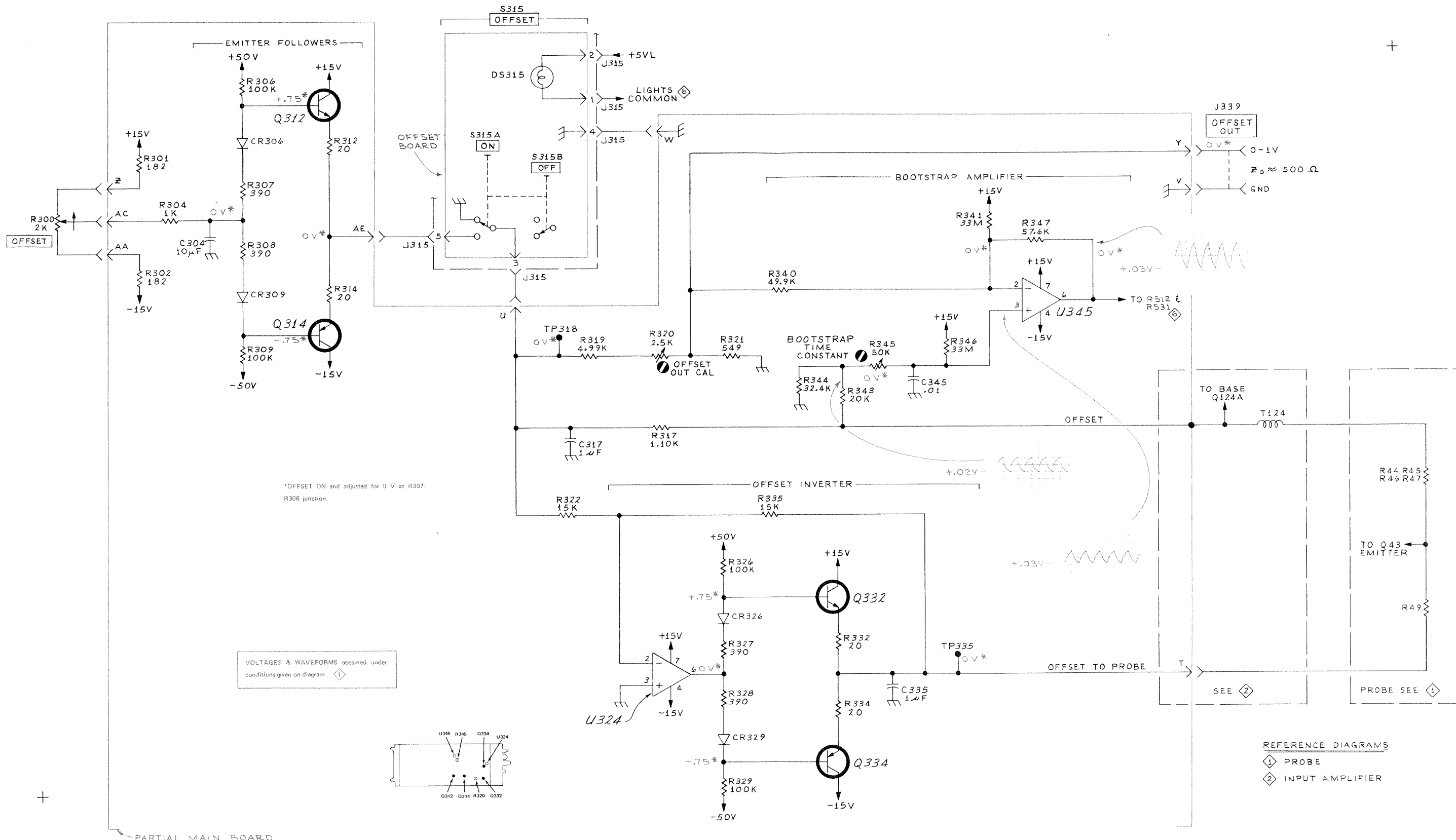

*OFFSET ON and adjusted for 0 V at R307.
R308 junction.

VOLTAGES & WAVEFORMS obtained under conditions given on diagram

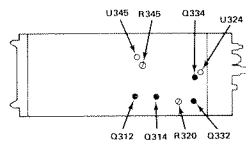

- NOTES:
- SEE PARTS LIST FOR I.C. & SEMICONDUCTOR TYPES.
 - U324 & U345; PINS 1, 5, & 8 NOT CONNECTED.

7AII AMPLIFIER

OFFSET GENERATOR 4 WLB 1169

OFFSET GENERATOR

4

+

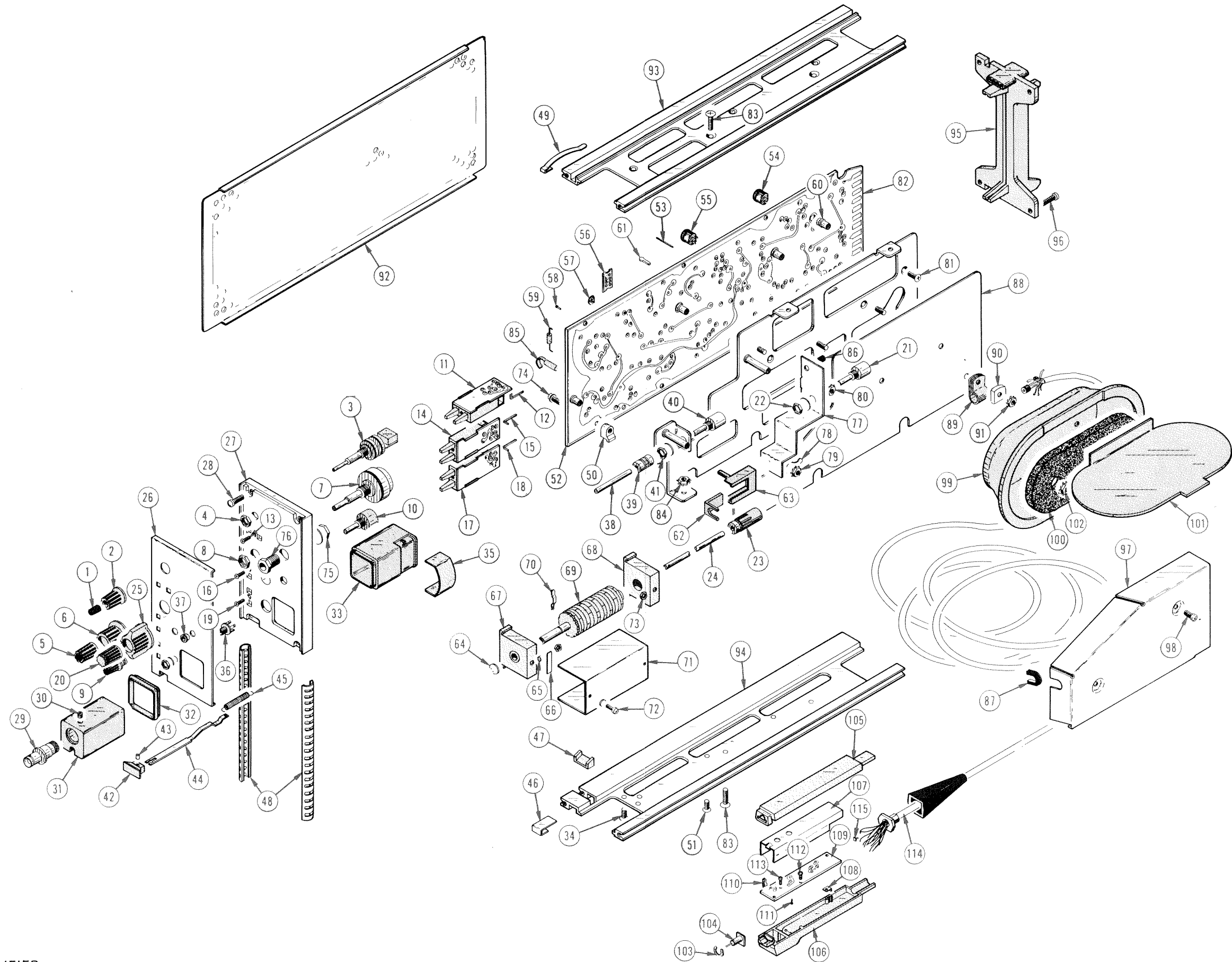
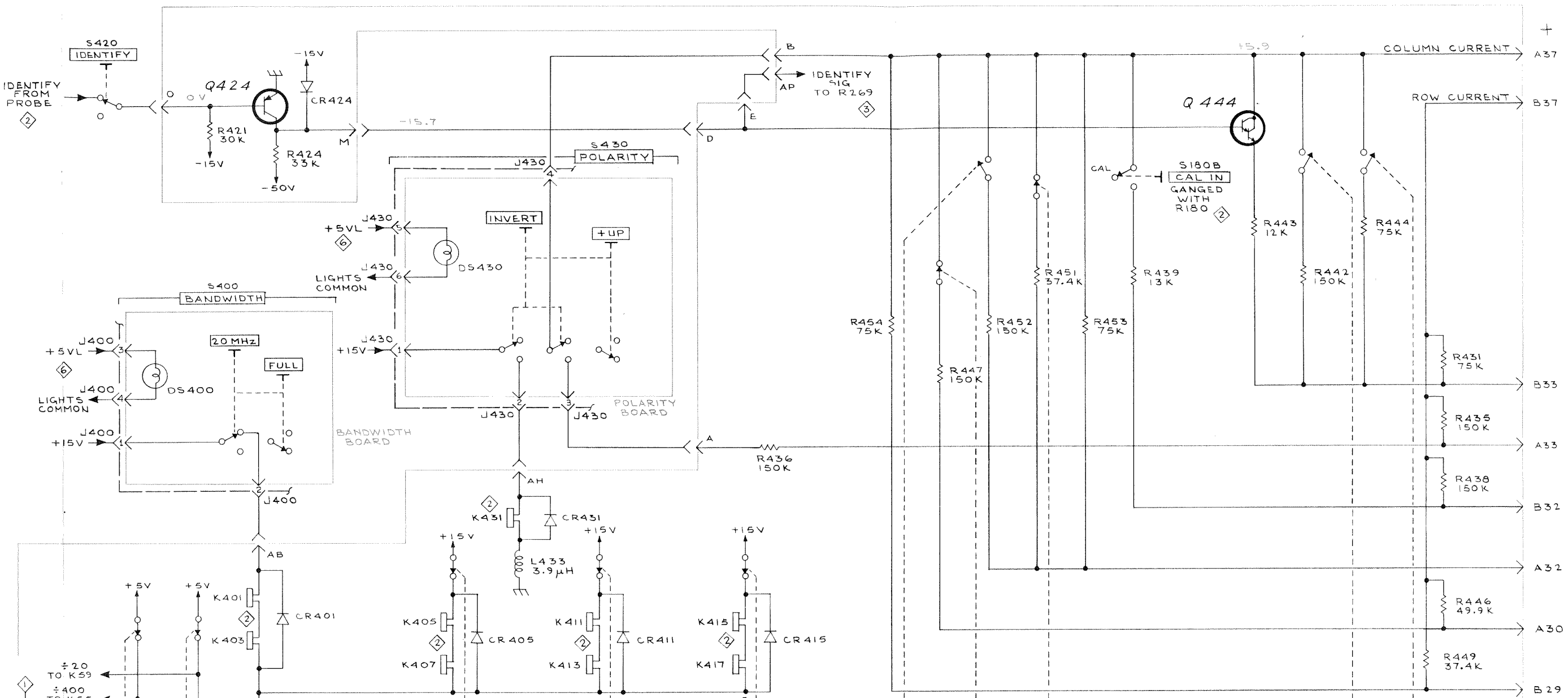

FIG. 1 EXPLODED

7A11 AMPLIFIER

+



- REFERENCE DIAGRAMS**
- ① PROBE
 - ② INPUT AMPLIFIER
 - ③ OUTPUT AMPLIFIER
 - ④ POWER SUPPLY & OUTPUT CONNECTORS

NOTE:
SWITCH SHOWN
IN 5mV POSITION

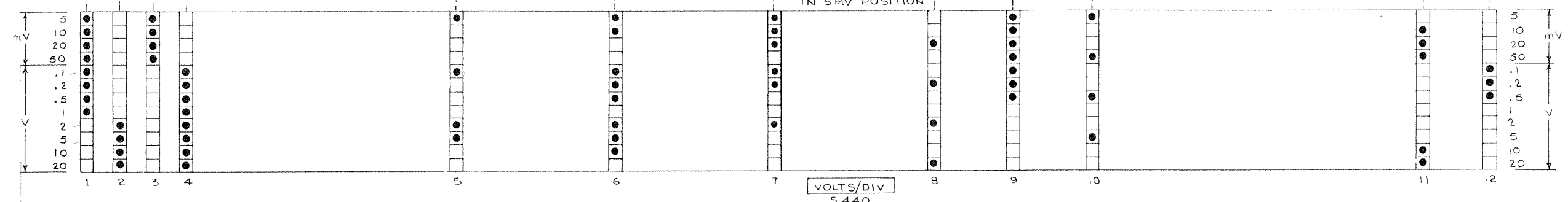

VOLTAGES obtained under conditions given
on diagram ①

SEE PARTS LIST FOR
SEMICONDUCTOR TYPES

7A11 AMPLIFIER

Ⓐ

VOLTS/DIV SWITCH & READOUT ⑤

hq
1169

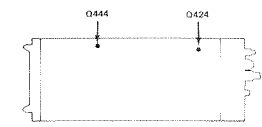

+

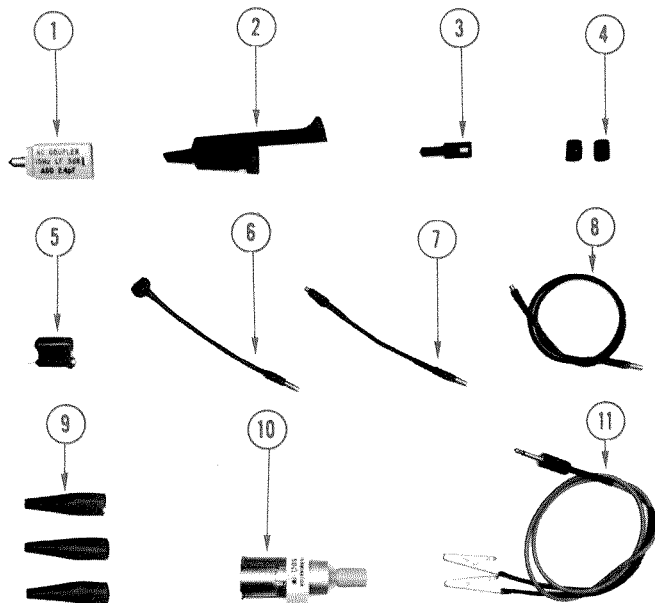

Ⓐ +

Fig. & Index No.	Tektronix Part No.	Serial/Model No.		Q t y	Description
		Eff	Disc		
2-1	011-0110-00			1	COUPLER HEAD, capacitor
-2	013-0106-00			1	TIP, retractable hook
-3	206-0114-00			1	TIP, hook
-4	166-0404-01			2	TUBE, insulating, plastic
-5	013-0085-00			1	ADAPTER, bayonet, ground
-6	175-0849-00			1	LEAD, ground, 3 inches long
-7	175-0848-00			1	LEAD, ground, 3 inches long, threaded
-8	175-0848-02			1	LEAD, ground 12 inches long
-9	344-0046-00			3	CLIP, alligator
-10	017-0088-00			1	TERMINATION, probe, 50 Ω
-11	175-1092-00			1	CABLE, special purpose, electrical, 18 inches long
	070-0984-00			2	MANUAL, instruction (not shown)

Ⓐ

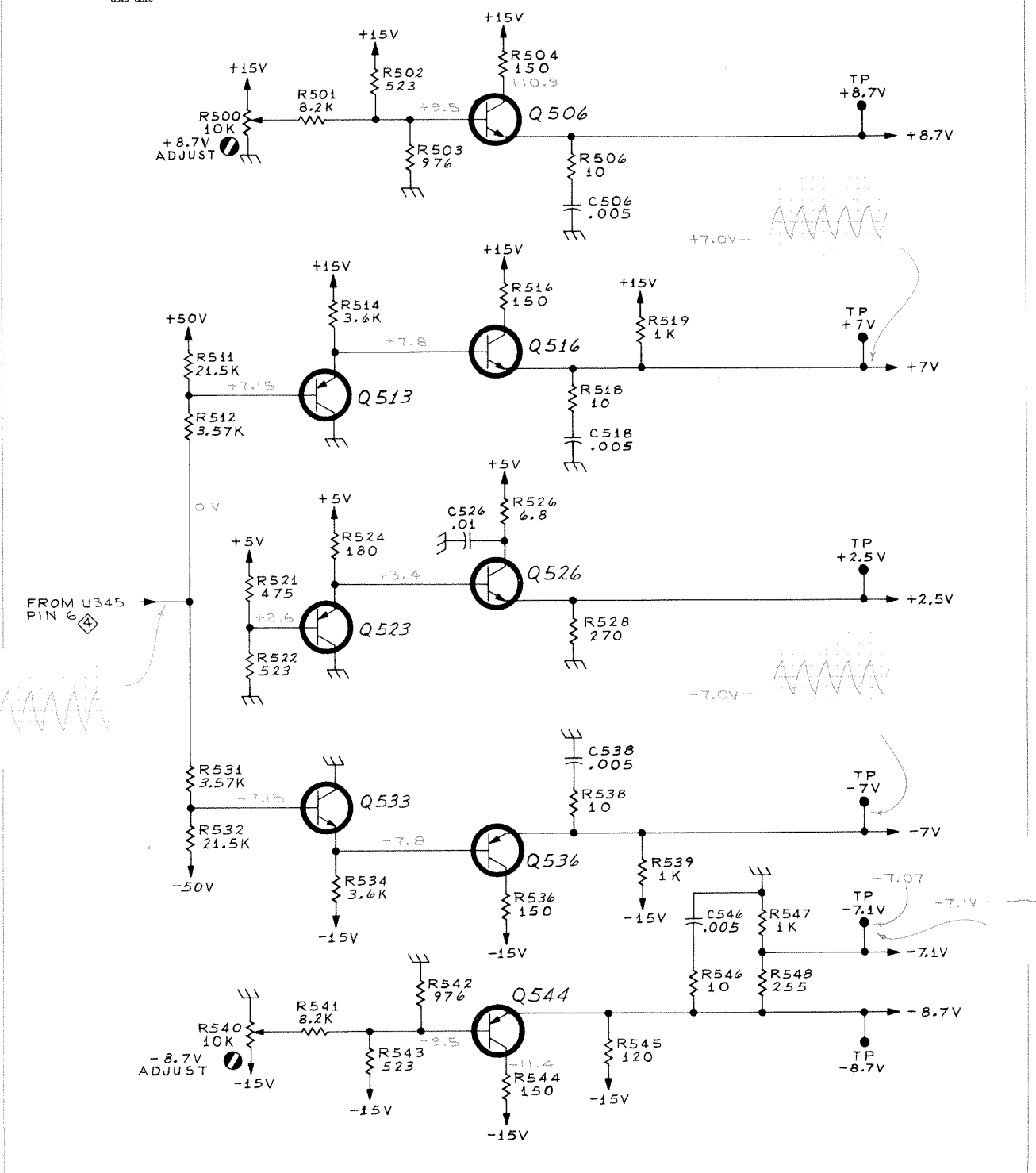
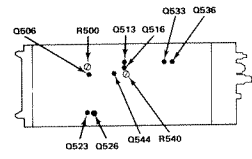

PARTIAL MAIN BOARD

VOLTAGES & WAVEFORMS obtained under conditions given on diagram

NOTE:
1. SEE PARTS LIST FOR SEMICONDUCTOR TYPES.

REFERENCE DIAGRAMS

- ④ OUTPUT AMPLIFIER
- ④ OFFSET GENERATOR
- ⑤ VOLTS/DIV SWITCH & READOUT

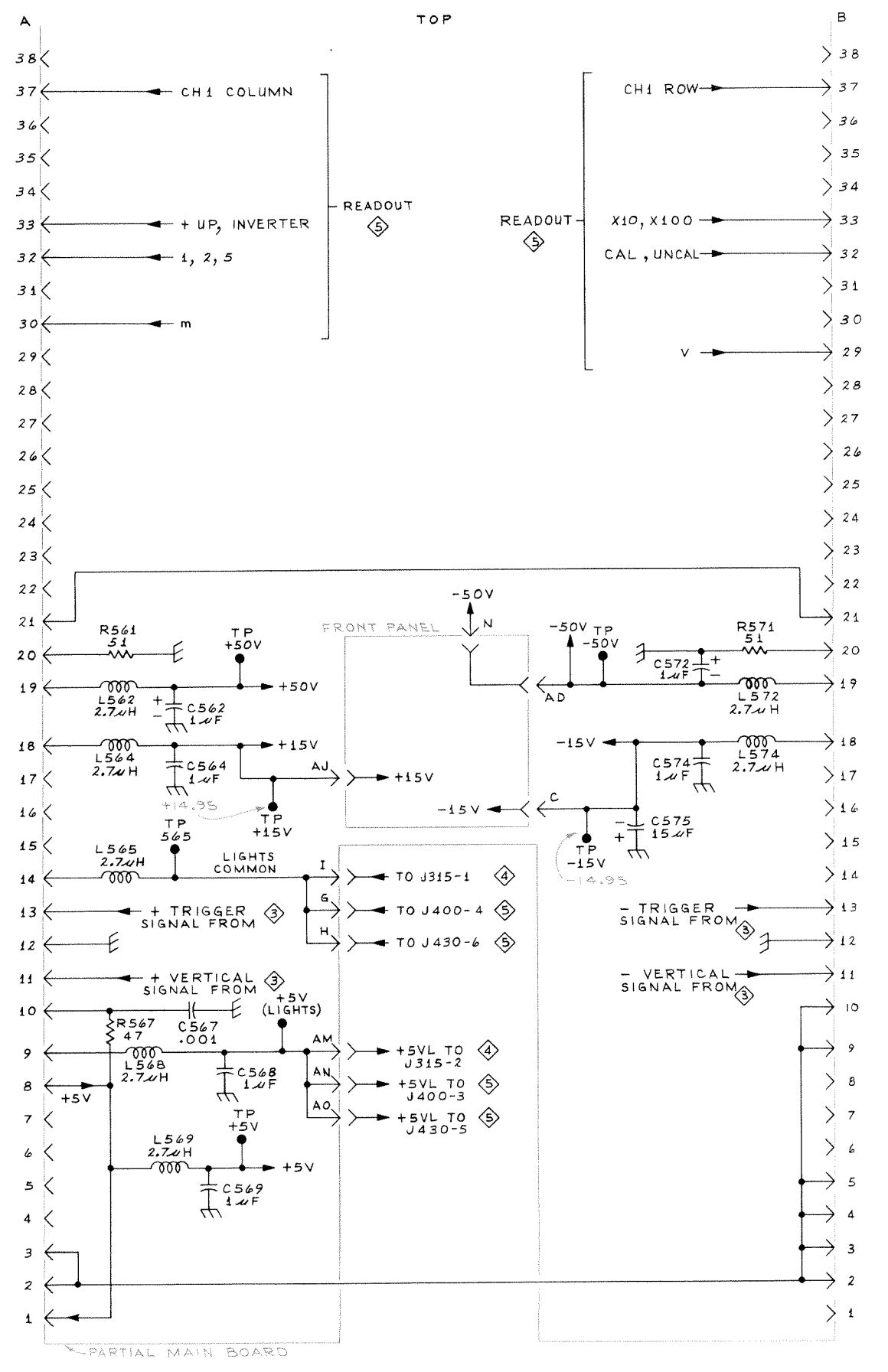

PARTIAL MAIN BOARD

POWER SUPPLY & OUTPUT CONNECTORS ⑥ WLB 1169

+

CARTON ASSEMBLY
(Part No. 065-0125-00)

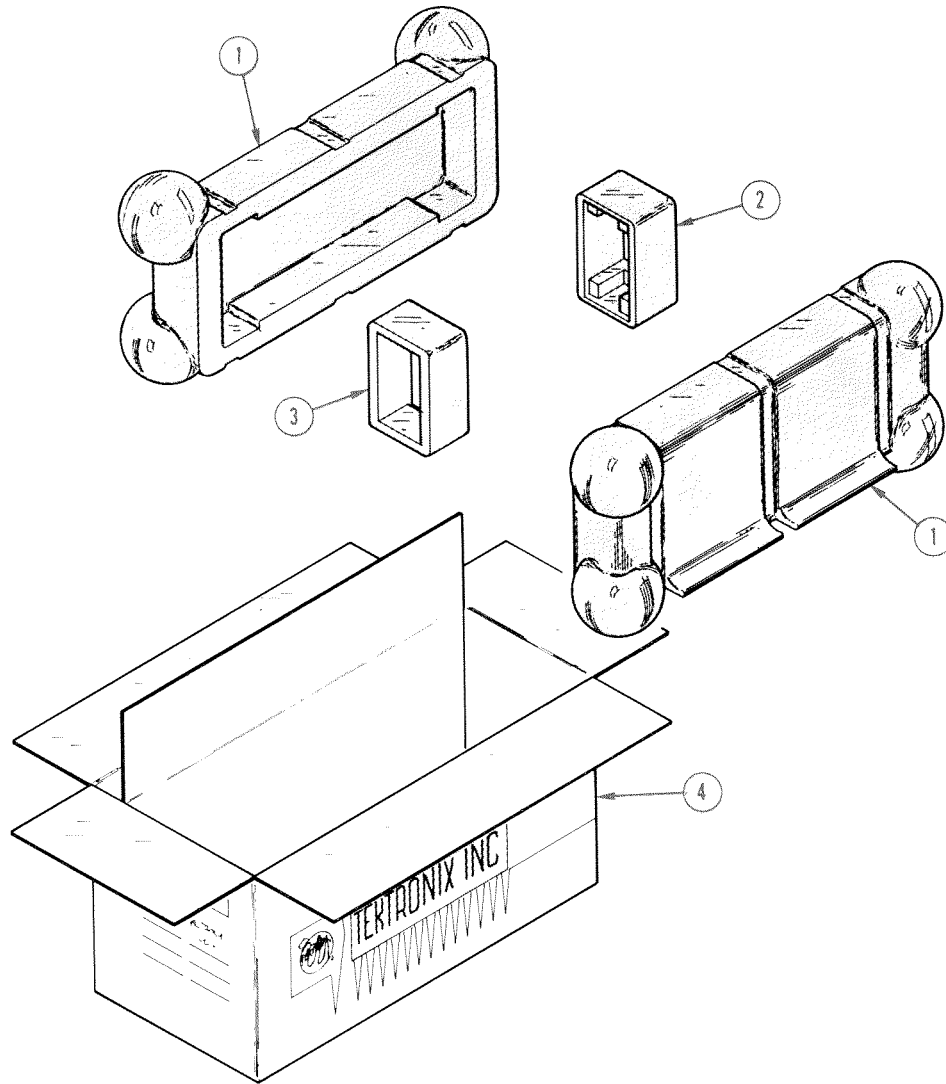

Ⓐ

Fig. & Index No.	Tektronix Part No.	Serial/Model No. Eff	No. Disc	Q					Description	
				t	1	2	3	4		5
3-	065-0125-00			1						ASSEMBLY, carton
-1	004-0241-00			-						assembly includes:
-2	004-0242-00			1						CASE HALF
-3	004-0243-00			1						END CAP, rear
-4	004-0748-00			1						END CAP, front
				1						CARTON

Ⓐ

FIG. 3 REPACKAGING

FIGURE AND INDEX NUMBERS

Items in this section are referenced by figure and index numbers to the illustrations which appear either on the back of the diagrams or on pullout pages immediately following the diagrams of the instruction manual.

INDENTATION SYSTEM

This mechanical parts list is indented to indicate item relationships. Following is an example of the indentation system used in the Description column.

Assembly and/or Component
Detail Part of Assembly and/or Component
mounting hardware for Detail Part
Parts of Detail Part
mounting hardware for Parts of Detail Part
mounting hardware for Assembly and/or Component

Mounting hardware always appears in the same indentation as the item it mounts, while the detail parts are indented to the right. Indented items are part of, and included with, the next higher indentation.

Mounting hardware must be purchased separately, unless otherwise specified.

PARTS ORDERING INFORMATION

Replacement parts are available from or through your local Tektronix, Inc. Field Office or representative.

Changes to Tektronix instruments are sometimes made to accommodate improved components as they become available, and to give you the benefit of the latest circuit improvements developed in our engineering department. It is therefore important, when ordering parts, to include the following information in your order: Part number, instrument type or number, serial or model number, and modification number if applicable.

If a part you have ordered has been replaced with a new or improved part, your local Tektronix, Inc. Field Office or representative will contact you concerning any change in part number.

Change information, if any, is located at the rear of this manual.

ABBREVIATIONS AND SYMBOLS

For an explanation of the abbreviations and symbols used in this section, please refer to the page immediately preceding the Electrical Parts List in this instruction manual.

INDEX OF MECHANICAL PARTS ILLUSTRATIONS

Title	Location (reverse side of)
Figure 1 Exploded	Offset Generator Diagram
Figure 2 Accessories	Volts/DIV Switch & Readout Diagram
Figure 3 Repackaging	Power Supply & Output Connectors Diagram

SECTION 8

MECHANICAL PARTS LIST

FIG. 1 EXPLODED

Fig. & Index No.	Tektronix Part No.	Serial/Model No.		Q	Description
		Eff	Disc		
				†	
				y	1 2 3 4 5
1-1	366-1059-00			1	PUSHBUTTON, gray—IDENTIFY
-2	366-1077-00			1	KNOB, gray—POSITION
	- - - - -			-	knob includes:
	213-0153-00			1	SETSCREW, 5-40 x 0.125 inch, HSS
-3	- - - - -			1	RESISTOR, variable
	- - - - -			-	mounting hardware: (not included w/resistor)
-4	210-0583-00			1	NUT, hex., 1/4-32 x 1/16 inch
-5	366-1023-00			1	KNOB, gray—FINE
	- - - - -			-	knob includes:
	213-0153-00			1	SETSCREW, 5-40 x 0.125 inch, HSS
-6	366-1025-01			1	KNOB, gray—COARSE
	- - - - -			-	knob includes:
	213-0153-00			2	SETSCREW, 5-40 x 0.125 inch, HSS
-7	- - - - -			1	RESISTOR, variable
	- - - - -			-	mounting hardware: (not included w/resistor)
-8	210-0590-00			1	NUT, hex., 3/8-32 x 7/16 inch
-9	366-0392-02			1	KNOB, gray—STEP ATTEN BAL
-10	- - - - -			1	RESISTOR, variable
	- - - - -			-	mounting hardware: (not included w/resistor)
	213-0020-00			1	SETSCREW, 6-32 x 0.125 inch
-11	670-1109-00			1	ASSEMBLY, circuit board—OFFSET
	- - - - -			-	assembly includes:
	380-0153-00			1	HOUSING, light
	- - - - -			-	mounting hardware: (not included w/housing)
	213-0181-00			1	SCREW, thread forming, #2 x 0.375 inch, PHS
-12	131-0589-00			5	TERMINAL, pin
	- - - - -			-	mounting hardware: (not included w/assembly)
-13	211-0156-00			1	SCREW, 1-72 x 0.250 inch, 82° csk, FHS
-14	670-1110-00			1	ASSEMBLY, circuit board—POLARITY
	- - - - -			-	assembly includes:
	380-0153-00			1	HOUSING, light
	- - - - -			-	mounting hardware: (not included w/housing)
	213-0181-00			1	SCREW, thread forming, #2 x 0.375 inch, PHS
-15	131-0589-00			6	TERMINAL, pin
	- - - - -			-	mounting hardware: (not included w/assembly)
-16	211-0156-00			1	SCREW, 1-72 x 0.250 inch, 82° csk, FHS

FIGURE 1 EXPLODED (cont)

Fig. & Index No.	Tektronix Part No.	Serial/Model Eff	No. Disc	Q † y	1	2	3	4	5	Description
1-17	670-0111-00			1						ASSEMBLY, circuit board—BANDWIDTH
	380-0153-00			-						assembly includes:
	213-0181-00			1						HOUSING, light
				-						mounting hardware: (not included w/housing)
				1						SCREW, thread forming, #2 x 0.375 inch, PHS
-18	131-0589-00			4						TERMINAL, pin
				-						mounting hardware: (not included w/assembly)
-19	211-0156-00			1						SCREW, 1-72 x 0.250, 82° csk, FHS
-20	366-1166-00			1						KNOB, red—VARIABLE (CAL IN)
	213-0153-00			-						knob includes:
				1						SETSCREW, 5-40 x 0.125 inch, HSS
-21				1						RESISTOR, variable
	210-0046-00			-						mounting hardware: (not included w/resistor)
-22	210-0583-00			1						WASHER, lock, internal, 0.261 ID x 0.400 inch OD
				1						NUT, hex., 1/4-32 x 5/16 inch
-23	214-1190-00			1						EXTENDER-RETRACTOR, knob
	213-0075-00			-						extender-retractor includes:
	213-0140-00			1						SETSCREW, 4-40 x 0.094 inch, HSS
-24	384-0496-00			1						SETSCREW, 2-56 x 0.094 inch, HSS
-25	366-1057-00			1						SHAFT, extension, 4.85 inches long
	213-0153-00			-						knob includes:
				2						SETSCREW, 5-40 x 0.125 inch, HSS
-26	333-1206-00			1						PANEL, front
-27	386-1447-17			1						SUBPANEL, front
				-						mounting hardware: (not included w/subpanel)
-28	213-0192-00			4						SCREW, thread forming, 6-32 x 0.50 inch, Fil HS
-29	103-0096-00			1						ADAPTER, BNC to probe
	213-0005-00			-						adapter includes:
-30	386-1572-00			1						SETSCREW, 8-32 x 1/8 inch, HSS
-31	200-1076-00			1						SUPPORT, probe
-32	380-0169-00			1						BEZEL, probe holder
				1						HOUSING, probe
				-						mounting hardware: (not included w/housing)
-34	211-0105-00			1						SCREW, 4-40 x 0.188 inch, 100° csk, FHS
-35	105-0139-00			1						RELEASE, probe, plastic
-36	131-0407-00			1						JACK, telephone, spring leaf, w/hardware
-37	358-0301-02			1						BUSHING, sleeve, plastic
-38	384-0485-00			1						SHAFT, extension, 1.5 inches long
-39	376-0051-00			1						ASSEMBLY, coupling, flexible
	354-0251-00			-						assembly includes:
	376-0049-00			1						RING, coupling
	213-0022-00			1						COUPLING, plastic
-40				2						SETSCREW, 4-40 x 3/16 inch, HSS
				1						RESISTOR, variable
	210-0046-00			-						mounting hardware: (not included w/resistor)
-41	210-0583-00			1						WASHER, lock, internal, 0.261 ID x 0.400 inch OD
				1						NUT, hex., 1/4-32 x 5/16 inch

FIGURE 1 EXPLODED (cont)

Fig. & Index No.	Tektronix Part No.	Serial/Model Eff	No. Disc	Q					Description	
				†	1	2	3	4		5
1-42	366-1058-04			1						KNOB, latch
	- - - - -			-						mounting hardware: (not included w/knob)
-43	214-1095-00			1						PIN, spring, split
-44	105-0076-00			1						RELEASE BAR, latch
-45	214-1280-00			1						SPRING, helical compression
-46	214-1054-00			1						SPRING, flat, latch detent
-47	105-0075-00			1						BOLT, latch, plastic
-48	348-0235-00			2						SHIELDING GASKET
-49	214-1061-00			1						SPRING, flat, sliding ground
-50	220-0547-01			6						NUT BLOCK
	- - - - -			-						mounting hardware for each: (not included w/nut block)
-51	211-0105-00			6						SCREW, 4-40 x 0.188 inch, 100° csk, FHS
-52	670-1108-00			1						ASSEMBLY, circuit board—ATTEN-MAIN AMP
	- - - - -			-						assembly includes:
	388-0342-00			1						BOARD, circuit
-53	131-0589-00			41						TERMINAL, pin
-54	136-0183-00			5						SOCKET, transistor, 3 pin
-55	136-0237-00			3						SOCKET, semiconductor, 8 contact
-56	136-0337-00			9						SOCKET, relay, 8 pin
-57	136-0350-00			13						SOCKET, transistor, 3 pin, gray plastic
-58	136-0252-00			39						SOCKET, pin connector
-59	131-0566-00			9						LINK, terminal connecting
-60	129-0124-00			5						POST, spline mounted
-61	214-0579-00			16						PIN, test point
-62	214-1136-00			1						ACTUATOR, slide
-63	351-0180-00			1						GUIDE, actuator
-64	354-0219-00			1						RING, retaining
-65	214-1127-00			1						ROLLER, detent
-66	214-1139-00 ¹			-						SPRING, flat, gold
	214-1139-02 ¹			-						SPRING, flat, green
	214-1139-03 ¹			-						SPRING, flat, red
-67	401-0057-00			1						BEARING, front
	- - - - -			-						mounting hardware: (not included w/bearing)
	211-0116-00			2						SCREW, sems, 4-40 x 0.312 inch, PHB
	210-0591-00			2						NUT, hex., 4-40 x 1/16 inch
-68	401-0056-00			1						BEARING, rear
	- - - - -			-						mounting hardware: (not included w/bearing)
	211-0116-00			2						SCREW, sems 4-40 x 0.312 inch, PHB
	210-0591-00			2						NUT, hex., 4-40 x 1/16 inch
-69	105-0126-00			1						DRUM, cam switch
-70	131-0604-00			14						CONTACT-POST ASSEMBLY
-71	200-1010-00			1						COVER, cam switch
	- - - - -			-						mounting hardware: (not included w/cover)
-72	211-0079-00			2						SCREW, 2-56 x 0.188 inch, PHS
	210-0001-00			2						WASHER, lock, internal, #2
-73	210-0405-00			2						NUT, hex., 2-56 x 3/16 inch
	- - - - -			-						mounting hardware: (not included w/assembly)
-74	211-0116-00			6						SCREW, 4-40 x 0.312 inch, PHB
-75	210-0413-00			1						NUT, hex., 3/8-32 x 1/2 inch
	210-0012-00			1						WASHER, lock, internal, 3/8 ID x 1/2 inch OD
-76	358-0029-00			1						BUSHING

¹Replace only with part bearing the same color as the original part in your instrument.

FIGURE 1 EXPLODED (cont)

Fig. & Index No.	Tektronix Part No.	Serial/Model Eff	No. Disc	Q † y						Description
					1	2	3	4	5	
1-77	407-0689-00			1						BRACKET, component mounting
	- - - - -			-						mounting hardware: (not included w/bracket)
-78	210-0201-00			1						LUG, solder, SE #4
-79	210-0551-00			1						NUT, hex., 4-40 x 1/4 inch
-80	210-0586-00			1						NUT, keps, 4-40 x 1/4 inch
-81	211-0101-00			5						SCREW, 4-40 x 0.250 inch, 100° csk, FHS
-82	407-0621-00			1						BRACKET, probe reel
	- - - - -			-						mounting hardware: (not included w/bracket)
-83	211-0541-00			5						SCREW, 6-32 x 0.250 inch, 100° csk, FHS
-84	210-0457-00			5						NUT, keps, 6-32 x 5/16 inch
-85	343-0088-00			6						CLAMP, cable, plastic, small
-86	348-0031-00			1						GROMMET, plastic, 3/32 inch diameter
-87	348-0239-00			1						GROMMET, U-shape
-88	386-1678-00			1						PLATE, access
-89	343-0002-00			1						CLAMP, cable, plastic, 3/16 inch
	- - - - -			-						mounting hardware: (not included w/clamp)
-90	210-0863-00			1						WASHER, D shape, 0.191 ID x 33/64 x 33/64 inch long
-91	210-0457-00			1						NUT, keps, 6-32 x 5/16 inch
-92	337-1064-00			1						SHIELD, electrical
-93	426-0505-05			1						FRAME SECTION, top
-94	426-0499-05			1						FRAME SECTION, bottom
-95	386-1402-00			1						PANEL, rear
	- - - - -			-						mounting hardware: (not included w/panel)
-96	213-0192-00			4						SCREW, thread forming, 6-32 x 0.50 inch, Fil HS
-97	337-1205-00			1						SHIELD, electrical
	- - - - -			-						mounting hardware: (not included w/shield)
-98	211-0007-00			2						SCREW, 4-40 x 0.188 inch, PHS
	214-1206-01			1						ASSEMBLY, spool, probe cable
	- - - - -			-						assembly includes:
-99	214-1206-00			1						SPOOL, probe, cable
-100	436-0093-00			1						TRAY, plastic
-101	200-1068-00			1						LID, spool
	- - - - -			-						mounting hardware: (not included w/assembly)
-102	210-0457-00			2						NUT, keps, 6-32 x 5/16 inch
	010-0251-00			1						ASSEMBLY, probe, 7A11
	- - - - -			-						assembly includes:
-103	210-1087-00			1						WASHER, spring tension
-104	206-0180-00			1						TIP, probe
-105	204-0383-00			1						BODY HALF, top
-106	204-0393-00			1						BODY HALF, bottom
-107	337-1173-00			1						SHIELD, electrical
-108	131-0776-00			1						CONTACT, electrical, ground

FIGURE 1 EXPLODED (cont)

Fig. & Index No.	Tektronix Part No.	Serial/Model Eff	No. Disc	Q					Description	
				t	y	1	2	3		4
1-	670-1019-00			1						ASSEMBLY, circuit, board
	- - - - -			-						assembly includes:
-109	388-1380-00			1						BOARD, circuit
-110	344-0190-00			1						CLIP, electrical
-111	136-0252-00			12						CONNECTOR, pin
	- - - - -			-						mounting hardware: (not included w/assembly)
-112	211-0161-00			1						SCREW, 0-90 x 3/16 inch, Fil HS
-113	211-0160-00			3						SCREW, 0-80 x 3/16 inch, Fil HS
-114	175-1140-00			1						CABLE ASSEMBLY
	- - - - -			-						cable assembly includes:
-115	210-0718-00			1						RIVET, tubular, 0.09 inch long
	200-0372-00			1						CAP, protector, plastic (not shown)

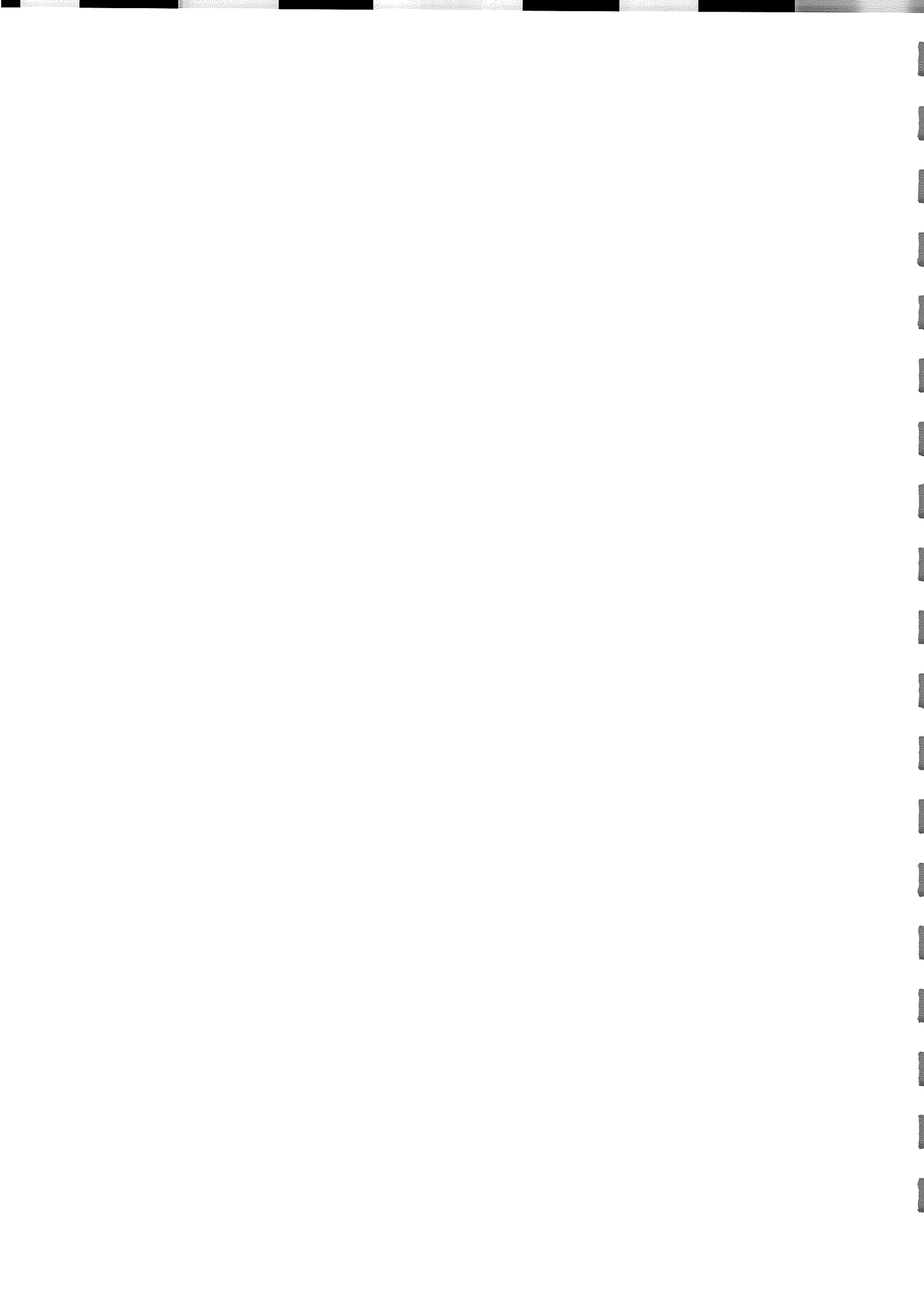

MANUAL CHANGE INFORMATION

At Tektronix, we continually strive to keep up with latest electronic developments by adding circuit and component improvements to our instruments as soon as they are developed and tested.

Sometimes, due to printing and shipping requirements, we can't get these changes immediately into printed manuals. Hence, your manual may contain new change information on following pages.

A single change may affect several sections. Sections of the manual are often printed at different times, so some of the information on the change pages may already be in your manual. Since the change information sheets are carried in the manual until ALL changes are permanently entered, some duplication may occur. If no such change pages appear in this section, your manual is correct as printed.

