

INSTRUCTION MANUAL

7B52

**DUAL
TIME BASE**

TABLE OF CONTENTS

SECTION 1	SPECIFICATION	Page		Preventive Maintenance	4-1
	Introduction	1-1		General	4-1
	Electrical Characteristics	1-1		Cleaning	4-1
	Main Sweep (Table 1-1)	1-1		Transistor FET, and Integrated	
	Dly'd Sweep (Table 1-2)	1-1		Circuit Checks	4-1
	Triggering (Table 1-3)	1-2		Recalibration	4-1
	Mixed Sweep, Variable Time Delay			Troubleshooting	4-2
	(Table 1-4)	1-2		Introduction	4-2
	Amplifier (Table 1-5)	1-3		Troubleshooting Aids	4-2
	Environmental Characteristics			Troubleshooting Equipment	4-3
	(Table 1-6)	1-3		Troubleshooting Techniques	4-3
				Corrective Maintenance	4-4
				Obtaining Replacement Parts	4-4
				Soldering Techniques	4-5
				Component Replacement	4-5
SECTION 2	OPERATING INSTRUCTIONS				
	General	2-1		SECTION 5	PERFORMANCE CHECK/CALIBRATION
	Installation	2-1		Introduction	5-1
	Front Panel Controls and Connectors	2-2		Test Equipment Required	5-1
	Test Set-up Chart	2-9		Short Form Procedure	5-2
	First-Time Operating Instructions	2-9		General	5-5
	Sweep Calibration Check	2-9		Procedure	5-5
	Simplified First-Time Operation	2-9			
SECTION 3	CIRCUIT DESCRIPTION			SECTION 6	ELECTRICAL PARTS LIST
	Introduction	3-1		Abbreviations and Symbols	
	Simplified Block Diagram	3-1		Parts Ordering Information	
	Main Sweep Mode	3-1		Index of Electrical Parts List	
	Delayed Sweep Mode	3-1			
	Mixed Sweep Mode	3-3		SECTION 7	DIAGRAMS AND MECHANICAL PARTS
	External Horiz Input	3-3		ILLUSTRATIONS	
	Circuit Description	3-4		Diagrams	
	Introduction	3-4		Mechanical Parts Illustrations (on	
	Main Trigger Generator	3-5		reverse side of Diagrams)	
	Main Sweep Generator	3-7			
	Delayed Trigger Preamp	3-10		SECTION 8	MECHANICAL PARTS LIST
	Delayed Trigger Generator	3-11		Mechanical Parts List Information	
	Delayed Sweep Generator	3-11		Index of Mechanical Parts Illustrations	
	Horizontal Preamp	3-13		Mechanical Parts List	
	Time/Div Readout Switching	3-14		Accessories	
SECTION 4	MAINTENANCE				
	Introduction	4-1			

Abbreviations and symbols used in this manual are based on or taken directly from IEEE Standard 260 "Standard Symbols for Units", MIL STD-12B and other standards of the electronics industry. Change information, if any, is located at the rear of this manual.

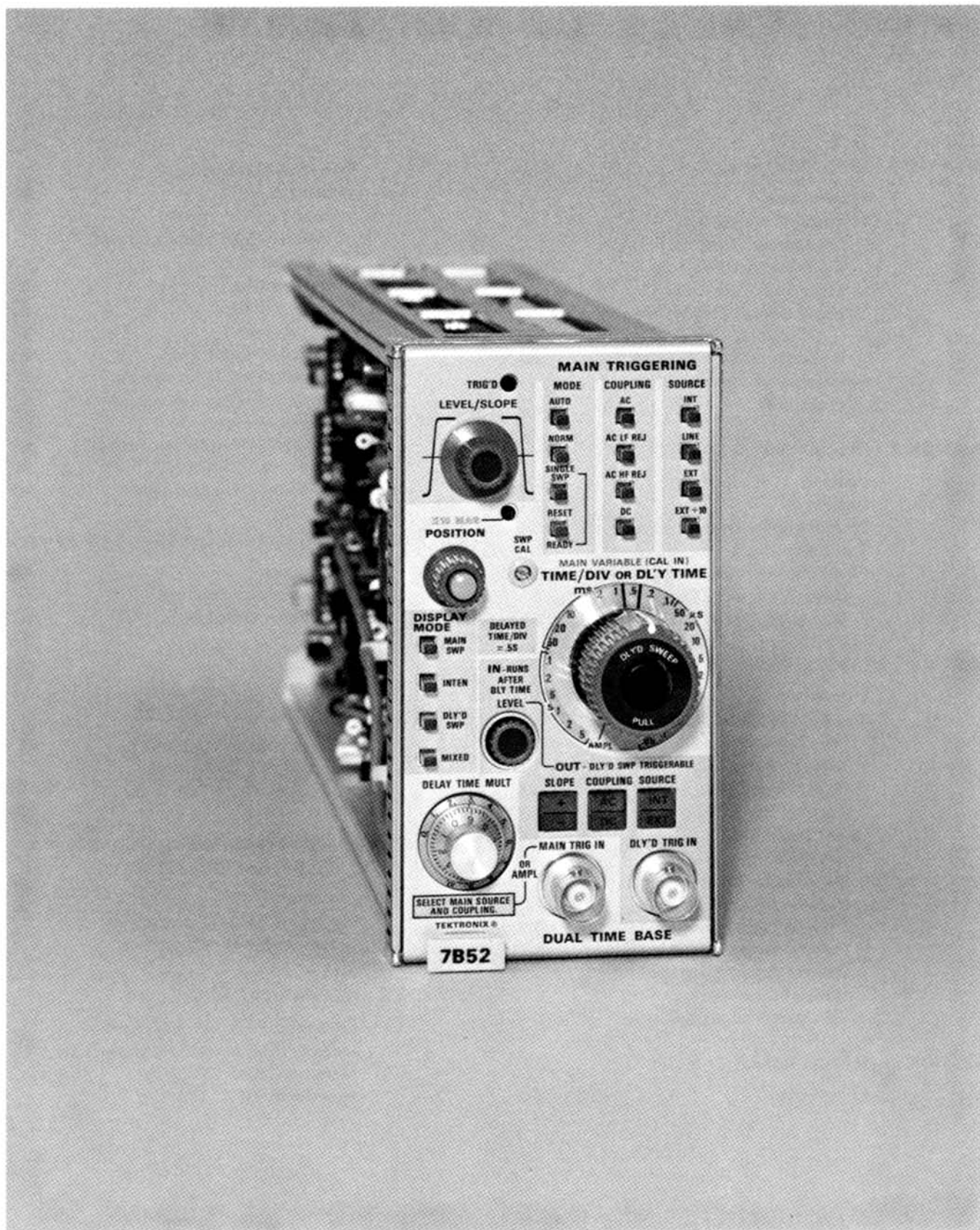

Fig. 1-1. 7B52 Dual Time Base.

SECTION 1

SPECIFICATION

Change information, if any, affecting this section will be found at the rear of this manual.

Introduction

The 7B52 Dual Time Base is designed specifically for use with the 7503 Indicator Oscilloscope; however, it is compatible with all 7000-Series Indicator Oscilloscopes. The 7B52 features calibrated sweeps from 5 s/div to 50 ns/div (0.5 s/div to 5 ns/div with X10 Magnification), triggering to 100 MHz, and four display modes. Other features include lighted pushbutton switches, 0 to 10 times continuous sweep delay, bright base line in AUTO mode in absence of adequate triggering signals, and an AMPL position for X-Y operation.

Display modes include MAIN SWEEP, INTENSIFIED SWEEP, DELAYED SWEEP, and MIXED SWEEP. In the MIXED mode, the Main Sweep is displayed to a point selected by the DELAY TIME MULT, after which the sweep rate is determined by DLY'D SWEEP setting. This mode permits sweep magnification of any point on the normal (Main) sweep selected by the DELAY TIME MULT control.

ELECTRICAL CHARACTERISTICS

The Performance Check procedure given in Section 5 provides a convenient method of checking performance of this instrument. The following electrical characteristics apply over a calibration interval of 1000 hours or six months (whichever occurs first) at an ambient temperature of 0°C to +50°C, unless otherwise noted. Warmup time for given accuracy is 20 minutes. The instrument must be operating in a calibrated indicator oscilloscope for given accuracy.

TABLE 1-1
MAIN SWP Electrical Characteristics

Characteristic	Performance Requirement			
Differential Sweep Accuracy ¹	Measured in 7500-Series Oscilloscope			
Time Interval	+15°C to +35°C		0°C to +50°C	
	Unmag	Mag ²	Unmag	Mag ²
Center 8 Divisions				
50 ms/Div to .5 μs/Div	2%	2.5%	3%	4%

¹The term "Differential Sweep" refers to Sweep display measured over the center 8 divisions of the graticule.

²Measure Mag accuracies between first and ninth segment of un-magnified sweep.

TABLE 1-1 (cont)

Characteristic	Performance Requirement			
	3%	3.5%	4%	5%
5 s/Div to .1 s/Div and .2 μs/Div to .05 μs/Div				
Any two Divisions within Center 8 Divisions	5% of measurement		7% of measurement	
Sweep Rate MAIN VARIABLE Range	Continuously variable between calibrated sweep rates. Extends sweep rate to at least 12.5 s/Div.			
Sweep Length	10.4 Divisions within 0.3 Division at 1 ms/Div. (Adjusted at this rate.)			
	10.0 to 13.0 Divisions at all other sweep rates.			
Sweep Holdoff Time	1 times the TIME/DIV switch setting or less.			
	5 s/Div to 10 μs/Div	2.5 μs or less		
5 μs/Div to .05 μs/Div				
Normal/Mag Registration	Within 0.5 Division.			

TABLE 1-2

DLY'D SWP Electrical Characteristics

Characteristic	Performance Requirement			
Differential Sweep Accuracy ¹	Measured in 7500-Series Oscilloscope			
Time Interval	+15°C to +35°C		0°C to +50°C	
	Unmag	Mag ²	Unmag	Mag ²
Center 8 Divisions				
50 ms/Div to .5 μs/Div	3%	3.5%	4%	5%

TABLE 1-2 (cont)

Characteristic	Performance Requirement			
	4%	4.5%	5%	6%
.5 s/Div to .1 s/Div and .2 μs/Div to .05 μs/Div				
Any two Divisions within Center 8 Divisions	6% of measurement		8% of measurement	
Sweep Length	10.4 Divisions within 0.3 Division at 1 ms/Div.			
	10.0 to 13 Divisions at all other sweep rates.			
Sweep Holdoff Time	Determined by MAIN SWP TIME/DIV switch setting.			

TABLE 1-3

Triggering Electrical Characteristics

Characteristic	Performance Requirement		
Trigger Sensitivity	Triggering Frequency Range	Minimum Signal Required	
		INT	EXT
Coupling ³	AC	30 Hz-10 MHz	0.3 Div 150 mV
		10 MHz-100 MHz	1.5 Div 750 mV
AC LF REJ ⁴ (Main Only)	30 kHz-10 MHz	0.3 Div	-----
	150 kHz-10 MHz	-----	150 mV
	10 MHz-100 MHz	1.5 Div	750 mV
AC HF REJ (Main Only)	30 Hz-50 kHz	0.3 Div	150 mV
DC	DC - 10 MHz	0.3 Div	150 mV
	10 MHz-100 MHz	1.5 Div	750 mV
Single Sweep (Main Only)	Triggering requirements same as Main Sweep. When triggered, sweep generator produces 1 sweep.		
Internal Trigger Jitter	1 ns or less at 75 MHz.		

³ On Internal Triggering Only, the specified upper -3 dB frequency of the Vertical System replaces any frequencies in the above table when the number in the table is greater than the upper -3 dB frequency of the indicator oscilloscope Vertical Amplifier.

⁴ Will not trigger on sine waves of 3 Divisions or less internal, or 1.5 volts external, below 120 Hz.

TABLE 1-3 (cont)

Characteristic	Performance Requirement
External Trigger Input	
Maximum Input Voltage	500 volts (DC plus peak AC). 500 volts (peak-to-peak AC to 1 kHz or less).
Input Resistance	1 megohm within 2%.
Input Capacitance	20 picofarad within 2 picofarad.
Level Range	
EXT	At least +3.5 volts to -3.5 volts.
EXT ÷ 10 (Main Only)	At least +35 volts to -35 volts.
Auto Bright Base Line (Main Only)	Sweep free-runs in absence of triggering signal in AUTO.

TABLE 1-4

Mixed Sweep, Variable Time Delay Electrical Characteristics

Characteristic	Performance Requirement
Mixed Sweep	
Sweep Accuracy	2% plus measured MAIN SWP error. Exclude following portions of Mixed Sweep; first 0.5 Divisions of Main Sweep and 0.2 Division or 0.1 μs, whichever is greater, after transition of Main Sweep to Dly'd Sweep.
Variable Time Delay	
Differential Delay Accuracy	
Center 8 Divisions	
5 s/Div to 1 s/Div	Within 2%
.5 s/Div to 1 μs/Div	Within 1%
Multiplier Linearity	Within 0.2% of full scale (1 minor division).
Jitter	1 part or less in 20,000 of 10 times the TIME/DIV switch setting.

TABLE 1-5
Amplifier Electrical Characteristics

Characteristic	Performance Requirement	
Deflection Factor		
EXT, X10 MAG	10 millivolts/division within 10%.	
EXT	100 millivolts/division within 10%.	
EXT ÷ 10	1 volt/division within 10%.	
Frequency Response	System -3 dB points in 75-Series Oscilloscope	
	Lower -3 dB	Upper -3 dB
	AC	40 Hz 2 MHz
	AC LF REJ	16 kHz 2 MHz
	AC HF REJ	40 Hz 100 kHz
DC	DC	2 MHz

TABLE 1-6
ENVIRONMENTAL CHARACTERISTICS

This instrument will meet the electrical characteristics given over the following environmental limits.

Characteristic	Performance Requirement
Altitude	
Non-Operating	To 50,000 feet and -55°C.
Transportation	Qualified under National Safe Transit Committee test procedure 1A, category II.

SECTION 2

OPERATING INSTRUCTIONS

Change information, if any, affecting this section will be found at the rear of this manual.

General

The 7B52 Dual Time Base Unit is designed specifically for use with Tektronix 7500-Series Indicator Oscilloscopes having one horizontal plug-in compartment; however, it is compatible with all Tektronix 7000-Series Indicator Oscilloscopes. To effectively use the 7B52, its operation and capabilities should be known. This section describes the operation of the front-panel controls, gives first-time and general operating information, lists some basic applications and tells how to make the instrument compatible with all 7000-Series oscilloscopes.

Installation

The 7B52 is designed to operate in the horizontal plug-in compartment of the oscilloscope. The 7B52 can also be installed in a vertical plug-in compartment to provide a sweep that runs vertically on the CRT. However, when used in this manner, there is no retrace blanking or internal triggering provisions, and the unit may not meet the specifications given in Section 1. The instructions in this manual are written for use of the 7B52 in the horizontal plug-in compartment.

Before proceeding with installation, it is necessary to set two internal 7B52 switches which provide proper triggering

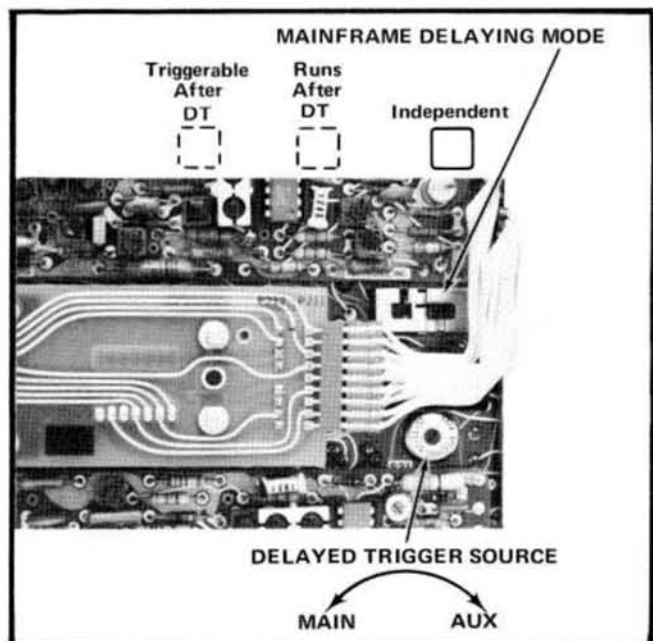

Fig. 2-1. Location of DELAYED TRIGGER SOURCE and MAIN-FRAME DELAYING MODE switches.

signals from within or to the indicator oscilloscope main-frame. The DELAYED TRIGGER SOURCE and MAIN-FRAME DELAYING MODE switches perform these functions; see Fig. 2-1. Table 2-1 lists the SOURCE and MODE switch positions for using the 7B52 in any 7000-Series Indicator Oscilloscope.

TABLE 2-1

Switch Position	Indicator Oscilloscope and Horizontal Plug-In Compartment Used		
	7503	7504-7704 A HORIZ	7504-7704 B HORIZ
DELAYED TRIGGER SOURCE			
MAIN	Horizontal Trig Selector	A Horizontal Trig Selector	B Horizontal Trig Selector
AUX	Left Vertical Signal	B Horizontal Trig Selector	A Horizontal Trig Selector
MAIN-FRAME DELAYING MODE			
Independent (Rear) ¹	Normal	Normal	Normal
Runs After (Center) ²	-----	Delaying Swp (B Horizontal Runs After Delay Interval)	-----
Triggerable After (Front) ²	-----	Delaying Swp (B Horizontal Triggerable After Delay Interval)	-----

¹ Switch must be in this position to obtain intensified sweep.

² Functional only when 7B52 is placed in A HORIZ compartment of 7504 or 7704.

Operating Instructions—7B52

To install the 7B52 into a plug-in compartment, push it in until it fits firmly into the compartment. To remove, pull the release latch (see Fig. 2-2) to disengage the unit from the indicator oscilloscope and pull it out of the plug-in compartment. Even though the horizontal gain of the indicator oscilloscope is standardized to minimize adjustment when inserting plug-ins, the sweep calibration of the 7B52 should be checked. The procedure for checking the unit is given under Sweep Calibration Check in the First-Time Operating Instructions of this section.

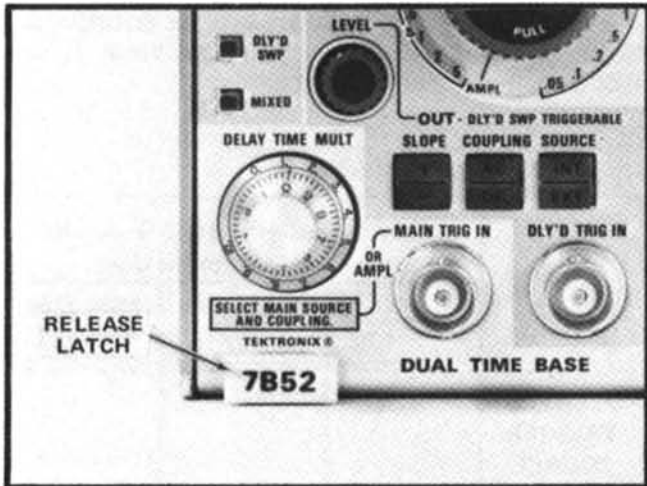

Fig. 2-2. Location of release latch.

FRONT-PANEL CONTROLS and CONNECTORS

General

All controls required for the operation of the 7B52 are located on the front panel of the unit (see Fig. 2-3) with the exception of the internal DELAYED TRIGGER SOURCE and MAIN-FRAME DELAYING MODE switches. To make full use of the capabilities of this instrument, the operator should be familiar with the function and use of each of these controls. A detailed description of the front-panel controls and connectors is given here.

Main Triggering Controls

LEVEL/SLOPE

The LEVEL/SLOPE control determines whether the trigger circuit responds on the positive-going or negative-going portion of the trigger signal. When the indicator line on the outer ring of the LEVEL/SLOPE control is to the left of center, the display starts on the positive-going portion of the waveform (notice positive-going waveform symbol to left of control). To the right of center, the display starts on the negative-going portion

of the waveform (notice negative-going waveform symbol). When several cycles of a signal appear in the display, the selection of the trigger slope is often unimportant. However, if only a certain portion of a cycle is to be displayed, correct setting of the LEVEL/SLOPE control is important to provide a display which starts on the desired slope of the input signal.

The LEVEL/SLOPE control determines the voltage level on the trigger signal at which the display is triggered, as well as selecting the trigger slope. The center knob of the LEVEL/SLOPE control provides about a 3:1 reduction in relation to the outer indicator ring, to allow precise level selection. This control can also be turned throughout the complete 360° rotation to allow continuous triggering over the selected slope. When the LEVEL/SLOPE control is set to the line on either the positive-going or negative-going waveform symbol the sweep is triggered near the zero-volt level of the trigger signal (AC coupled only). As the LEVEL/SLOPE control is rotated away from the zero line, the displayed waveform starts at a point corresponding to the position of the indicator line on the associated slope waveform symbol. For example, if the LEVEL/SLOPE control is turned clockwise from the zero line on the positive-going slope symbol, the displayed waveform starts at a more positive level.

Before setting the triggering level, select the TRIGGERING MODE, COUPLING and SOURCE. Then adjust the LEVEL/SLOPE control so the displayed waveform starts at the desired point. The triggering slope can be changed at any time by rotating the LEVEL/SLOPE control to the corresponding point on the other slope waveform symbol.

TRIG'D LAMP

The TRIG'D lamp provides a convenient indication of the condition of the trigger circuits. If the MAIN

TRIGGERING MODE, COUPLING, and SOURCE switches are correctly set and a suitable trigger signal is applied, the TRIG'D lamp is on. Under certain conditions, the TRIG'D lamp may be off, indicating that the sweep is not triggered. The cause might be a misadjustment of the LEVEL/SLOPE control, incorrectly set COUPLING or SOURCE switches, low trigger

signal amplitude, or a trigger signal repetition rate outside the acceptable frequency range. This feature can be used as a general indication of correct triggering. It is particularly useful when setting up the trigger circuits when a trigger signal is available without a display on the CRT. It also indicates that this unit is correctly triggered when operating as a DLY'D SWEEP.

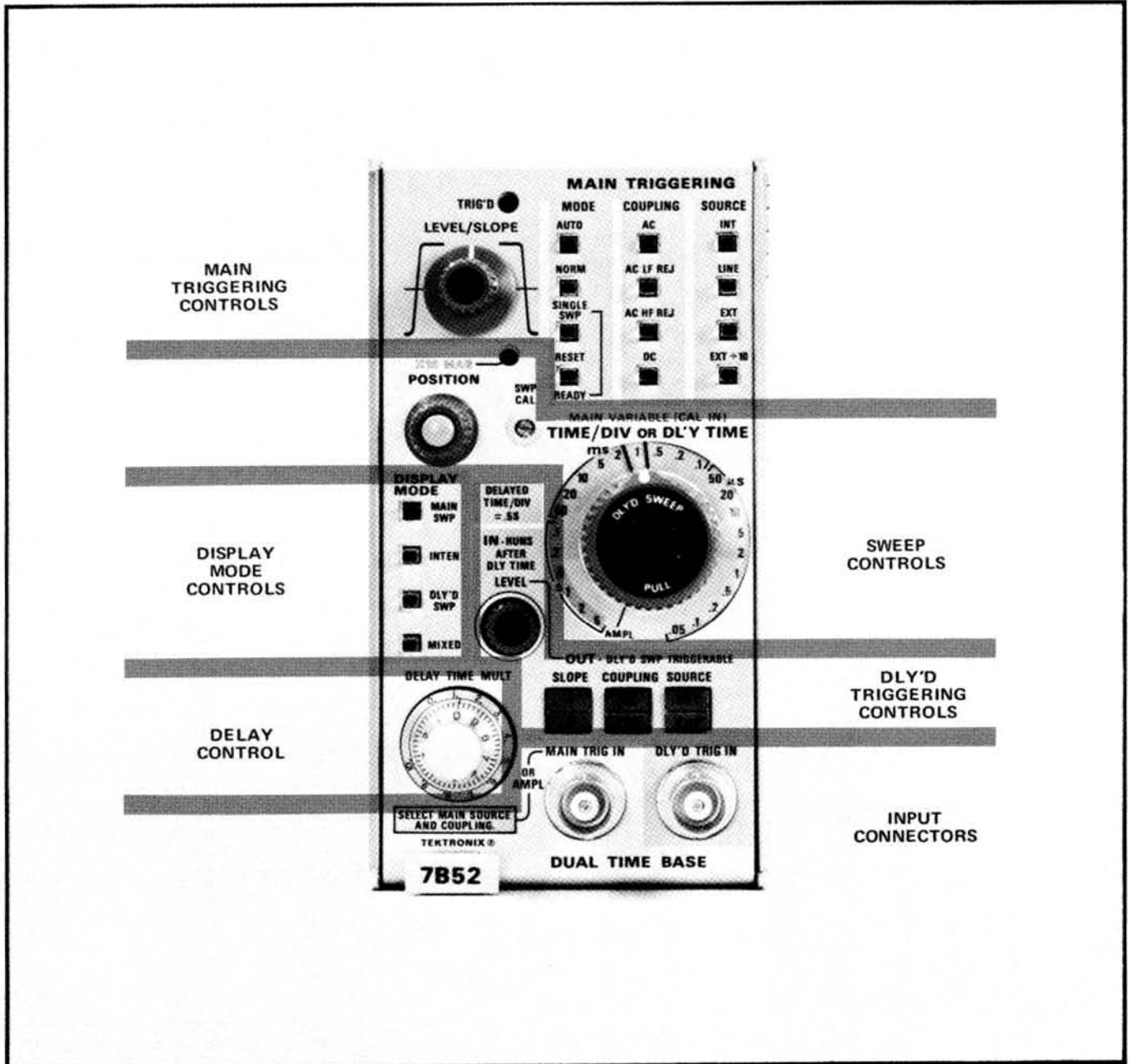

Fig. 2-3. Front-Panel controls and connectors.

Operating Instructions—7B52

MODE

The pushbuttons located under the MODE title select the mode in which the sweep is triggered. The selected mode in which the sweep is triggered. The selected mode is indicated by a lighted pushbutton.

AUTO

When the AUTO pushbutton is illuminated, a triggered display is presented with the correct setting of the LEVEL/SLOPE control whenever an adequate trigger signal is applied. The range of the LEVEL/SLOPE control in this mode is ± 8 vertical divisions. The TRIG'D light indicates when the display is triggered.

When the trigger repetition rate is below about 30 hertz (or outside the frequency range selected by the COUPLING switch) or when the trigger signal is inadequate, the sweep free-runs at the sweep rate indicated by the TIME/DIV or DL'Y TIME switch to produce a reference trace (TRIG'D light off). When an adequate trigger signal is again applied, the free-running condition ends and a triggered display is presented. When the LEVEL/SLOPE control is at a setting outside the amplitude range of the trigger signal, the sweep also free-runs at the sweep rate indicated by the TIME/DIV or DL'Y TIME switch. This type of free-running display can be useful to measure only the maximum peak-to-peak amplitude of a signal without observing the waveshape (such as in bandwidth measurements).

NORM

When the NORM pushbutton is pressed, a triggered display is presented with the correct setting of the LEVEL/SLOPE control whenever an adequate trigger signal is applied. The range of the LEVEL/SLOPE control in this mode is ± 8 vertical divisions. The TRIG'D light indicates when the display is triggered.

The NORM trigger mode must be used to produce triggered displays with trigger repetition rates below

30 hertz. When the LEVEL/SLOPE control is at a setting outside the amplitude range of the trigger signal, when the trigger repetition rate is outside the frequency range selected by the COUPLING switch, or when the trigger signal is inadequate, there is no trace (TRIG'D light is off).

SINGLE SWP

Non-repetitive, random signals can be displayed in the single-sweep mode by first obtaining the best possible display in the NORM MODE with a signal which is about the same amplitude and frequency as the random signal. Then without changing the other TRIGGERING controls, press the SINGLE SWP pushbutton. When ready for the random signal, press the RESET-READY pushbutton. The RESET-READY pushbutton remains lighted to indicate that the unit has been reset and is ready to produce a sweep. The light goes out after the random signal triggers the unit. To prepare the unit for another single-sweep display, press the RESET-READY pushbutton again.

When using the single-sweep mode to photograph waveforms, the graticule must be photographed separately in the normal manner to prevent over-exposing the film. Be sure the camera system is well protected against stray light, or operate the system in a darkened room. For repetitive waveforms, press the RESET-READY pushbutton only once for each waveform unless the signal is completely symmetrical. Otherwise, multiple waveforms may appear on the film. For random signals, the camera lens can be left open until the random signal triggers the unit (RESET-READY pushbutton lighted). Further information on photographic techniques is given in the camera instruction manual.

When the signal to be displayed is not repetitive or varies in amplitude, waveshape or repetition rate, a conventional repetitive type display may produce an unstable pre-

sentation. A stable display can often be obtained under these circumstances by using the single-sweep feature of this unit. The SINGLE SWP MODE is also useful to photograph non-repetitive or unstable displays.

To obtain a single-sweep display of a repetitive signal, first obtain the best possible display in the NORM MODE. Then without changing the other TRIGGERING controls, press the SINGLE SWP pushbutton. When ready to view the single-sweep display press the RESET-READY pushbutton. A single trace is presented each time the RESET-READY pushbutton is pressed (as long as the repetitive signal remains connected to the system and TRIGGERING controls are correctly set) and further sweeps cannot be presented until the RESET-READY pushbutton is pressed again. If the displayed signal is a complex waveform composed of pulses of varying amplitude, successive single-sweep dis-

plays may not start at the same point of the waveform. To avoid confusion due to the CRT persistence, allow the display to decay before pressing the RESET-READY pushbutton again. At fast sweep rates, it may be difficult to view the single-sweep display. The apparent trace intensity can be increased by reducing the ambient light level or using a viewing hood as recommended in the indicator instruction manual.

COUPLING

The pushbuttons located below the COUPLING title selects the method in which the trigger signal is connected to the trigger circuits. The selected coupling is indicated by a lighted pushbutton. Each position permits selection or rejection of the frequency components of the trigger signal which trigger the sweep. Fig. 2-4 graphically illustrates the band of frequencies covered by each position of the COUPLING switch.

AC

In the AC position of the COUPLING switch, the DC component

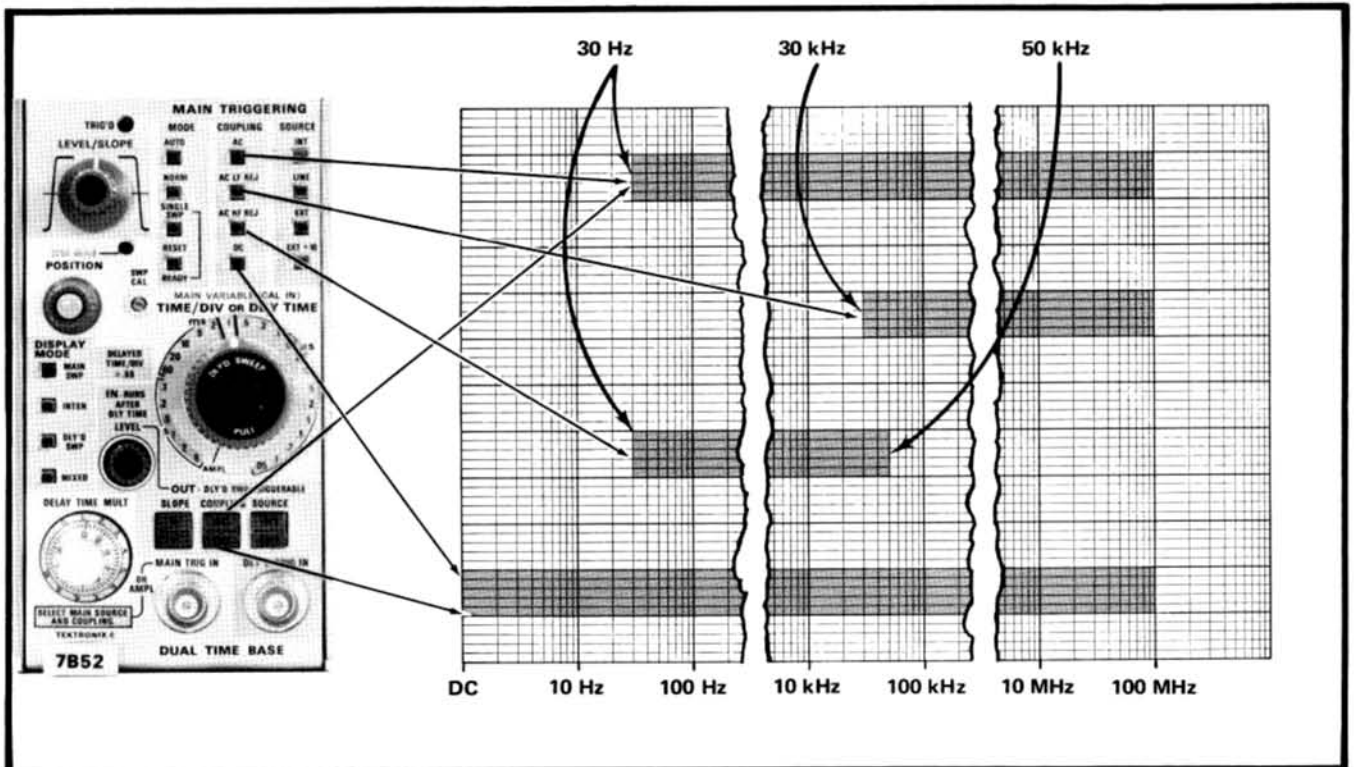

Fig. 2-4. Frequency range of each COUPLING switch position.

of the trigger signal is blocked. Signals with low-frequency components below about 30 hertz are attenuated. In general, AC COUPLING can be used for most applications. However, if the signal contains unwanted frequency components or if the sweep is to be triggered at a low repetition rate or DC level, one of the remaining COUPLING switch positions will provide a better display.

The triggering point in the AC position depends upon the average voltage level of the trigger signal. If the trigger signal occurs randomly, the average voltage level will vary, causing the triggering point to vary also. This shift of the triggering point may be enough so it is impossible to maintain a stable display. In such cases, use DC coupling.

AC LF REJ

In the AC LF REJ position, DC is rejected and low-frequency trigger signals below about 30 kilohertz are attenuated. Therefore, the sweep is triggered only by the higher-frequency components of the trigger signal. This position is particularly useful for providing stable triggering if the trigger signal contains line-frequency components. Also, the AC LF REJ position provides the best alternate mode vertical displays at fast sweep rates when comparing two or more unrelated signals (with dual-trace vertical or slaved triggering operation for dual-vertical unit operation).

AC HF REJ

The AC HF REJ position passes all low-frequency signals between about 30 hertz and 50 kilohertz. DC is rejected and signals outside the above range are attenuated. When triggering from complex waveforms, this position is useful for providing a stable display of the low-frequency components.

DC

DC COUPLING can be used to provide stable triggering with low-frequency signals which would be

attenuated in the other modes, or with low-repetition rate signals. It can also be used to trigger the sweep when the trigger signal reaches a DC level selected by the setting of the LEVEL/SLOPE control. When using internal triggering, the setting of the vertical unit position control affects the DC triggering point.

SOURCE

The pushbuttons located below the SOURCE title select the source of the trigger signal which is connected to the trigger circuits. The selected source is indicated by a lighted pushbutton.

INT

In the INT position of the SOURCE switch, the trigger signal is derived from the associated vertical unit. Further selection of the internal trigger signal may be provided by the associated vertical unit or indicator oscilloscope; see the instruction manuals for these instruments for information. For most applications, the INT-SOURCE position can be used. However, some applications require special triggering which cannot be obtained in the INT-SOURCE position. In such cases LINE- or EXT-SOURCE must be used.

LINE

The LINE position of the SOURCE switch connects a sample of the power-line voltage, to which the indicator oscilloscope is connected, to the trigger circuit. Line triggering is useful when the input signal is time-related (multiple or sub-multiple) to the line frequency. It is also useful for providing a stable display of a line-frequency component in a complex waveform.

EXT

An external signal connected to the MAIN TRIG IN connector can be used to trigger the sweep in the EXT-SOURCE position. The external signal must be time-related to the displayed waveform for a stable display. An external trigger signal can be used to provide a triggered display when the internal signal is

too low in amplitude for correct triggering or contains signal components on which it is not desired to trigger. It is also useful when signal tracing in amplifiers, phase-shift networks, wave-shaping circuits, etc. The signal from a single point in the circuit under test can be connected to the MAIN TRIG IN connector through a probe or cable. The sweep is then triggered by the same signal at all times and allows amplitude, time relationship or waveshape changes of signals at various points in the circuit to be examined without resetting the TRIGGERING controls.

EXT ÷ 10

Operation in the EXT ÷ 10 position is the same as described for EXT except that the external signal is attenuated 10 times. Attenuation of high-amplitude external trigger signals is desirable to broaden the range of the LEVEL/SLOPE control.

Sweep Controls

TIME/DIV or DL'Y TIME

The TIME/DIV or DL'Y TIME switch provides 25 calibrated sweep rates ranging from .05 μ s/div to five seconds/div. The MAIN VARIABLE control must be in the CAL position (locked in) and the X10 MAG switch must be off (locked in) for the indicated sweep rate.

DLY'D SWEEP

The DLY'D SWEEP switch provides 22 calibrated sweep rates ranging from .05 μ s to .5 second.

With DISPLAY MODE switch at INTEN or DLY'D SWP, pull out on the DLY'D SWEEP switch and rotate clockwise.

MAIN VARIABLE

The MAIN VARIABLE control incorporates a two-position switch to determine whether the sweep rate is calibrated or uncalibrated. When the knob is in the inward position, the MAIN VARIABLE is inoperative and the sweep rate is calibrated. When pressed and released, the MAIN VARIABLE knob

moves outward to activate the MAIN VARIABLE control for uncalibrated rates. A calibrated rate may be obtained at any position of the MAIN VARIABLE control by pressing in and locking. This feature is useful when a specific uncalibrated sweep rate has been obtained and it is desired to switch between this uncalibrated sweep rate and a calibrated sweep rate.

The MAIN VARIABLE control allows the sweep rate in each TIME/DIV switch position to be reduced to at least the sweep rate of the next adjacent switch position. This provides an overall uncalibrated variable sweep range from 50 ns/div to about 12.5 seconds/division.

POSITION

The POSITION control provides horizontal positioning of the CRT display.

SWP CAL

The SWP CAL control is a screw-driver adjustment to set the amplitude of the output sawtooth waveform.

X10 MAG

The X10 MAG switch expands the sweep ten times. The center division of the unmagnified display is the portion visible on the CRT in magnified form. Equivalent length of the magnified sweep is 100 divisions.

Display Mode Controls

MAIN SWP

The MAIN SWP selects sweep rates as determined by the TIME/DIV switch.

INTEN

This is one of the delayed sweep functions. In INTEN mode, a portion of the main sweep is intensified during the time that delayed sweep is in operation as determined by DLY'D SWEEP. (MAIN FRAME DELAYING MODE switch must be in Independent position.)

Operating Instructions—7B52

DLY'D SWP One of the delayed sweep functions. In DLY'D SWP, the delayed sweep is displayed at the end of each delay period as determined by the DLY TIME and DELAY TIME MULT control settings.

MIXED SWP Main and delayed sweep function. In MIXED SWP position, the main sweep is displayed on the CRT to the point determined by the DELAY TIME MULT control, followed by the delayed sweep.

Delay Control

DELAY TIME MULT The DELAY TIME MULT (DTM) provides variable delay of 0 to 10 times the basic delay time selected by the DLY TIME switch.

Dly'd Triggering Controls

DLY'D LEVEL Two position switch actuated by the LEVEL control. At the 'IN' position, the LEVEL, SLOPE, COUPLING, and SOURCE switches are inoperative. However, the DLY'D Sweep will run after Dly'y time as determined by the DLY TIME switch and setting of the DELAY TIME MULT control. In the 'OUT' position, the LEVEL, SLOPE, COUPLING, and SOURCE switches are operative. In this condition, the Dly'd Sweep is triggerable.

SLOPE Pushbutton switch to select either positive or negative slope of delayed trigger.

COUPLING Pushbutton switch to select either AC (in) or DC (out) coupling.

AC: Rejects DC and attenuates AC signals below about 20 Hz. Accepts signals between 30 Hz and 100 MHz.

DC: Accepts all triggers between DC and 100 MHz.

SOURCE Pushbutton switch to select trigger source.

INT (in): Trigger signal obtained from vertical unit.

EXT (out): Trigger signal obtained from DLY'D TRIG IN connector.

Input Connectors

MAIN TRIG IN BNC input connector for external triggering signal.

AMPL IN BNC input connector for external signal. TIME/DIV or DLY TIME switch must be in AMPL and the MAIN TRIGGERING SOURCE switch must be set for EXT or EXT \div 10.

DLY'D TRIG IN BNC input connector for external dly'd triggering signal. DLY'D LEVEL control must be out and the DLY'D SOURCE switch must be set for EXT.

Amplifier

In some applications, it is desirable to display one signal vs. another (X-Y) rather than against time. The AMPL position of the TIME/DIV or DLY TIME switch, in conjunction with a signal applied to the AMPL IN connector, provides a means of applying this signal to the horizontal amplifier. The correct MAIN TRIGGERING COUPLING and SOURCE switches must be selected to correspond to the signal applied to the AMPL IN connector.

Two modes of external horizontal operation are provided. When the MAIN TRIGGERING SOURCE switch is set to EXT or EXT \div 10 positions, external horizontal deflection is provided by the signal applied to the AMPL IN connector. The signal coupling provided by the COUPLING switch can be used to select or reject components of the external horizontal signal.

The external horizontal deflection factor is approximately 100 mV/div in EXT and 1 V/div in EXT ÷ 10 positions of the SOURCE switch.

TEST SETUP CHART

General

Fig. 2-5 shows the front panel of the 7B52. This chart can be reproduced and used as a test setup record for special measurements, applications, or produces; or it may be used as a training aid for familiarization with this instrument.

FIRST-TIME OPERATING INSTRUCTIONS

Sweep Calibration Check

Whenever the 7B52 is inserted into a plug-in compartment of an indicator oscilloscope other than the one in which it was originally calibrated, the sweep calibration must be checked and readjusted if necessary. Set the two internal switches (see Installation this section), install the 7B52 into the plug-in compartment of an indicator oscilloscope, and allow at least 20 minutes warmup before proceeding with the following:

1. Connect a 1 kHz calibrator signal from the indicator oscilloscope Cal Out connector via a 50 ohm BNC coaxial cable to the Input connector on the Vertical plug-in unit.
2. Set the 7B52 TIME/DIV or DL'Y TIME switch to 1 ms, press the DISPLAY MODE MAIN SWP switch and press the MAIN TRIGGERING AUTO, AC, and INT switches.
3. Set the Vertical plug-in unit for a CRT display amplitude of 2 to 4 divisions using DC coupling.
4. Rotate the LEVEL/SLOPE control for a triggered display.
5. Check the CRT display for one complete cycle of calibrator signal for each major division. (See Fig. 5-2 of PERFORMANCE CHECK/CALIBRATION procedure.)
6. Adjust SWP CAL (a front-panel screwdriver adjustment) for exactly 1 complete cycle of calibrator signal for each major division on the CRT. Use only the center 8 graticule divisions.

First-Time Operation

Use the following first time operating procedure to become acquainted with the 7B52. For a complete descrip-

tion of each control and connector, refer to CONTROLS and CONNECTORS in this section.

1. Complete parts 1 through 6 of the Sweep Calibration Check.
2. Rotate the LEVEL/SLOPE control and note that the CRT display is triggered on the positive slope of the display with LEVEL/SLOPE on +, free-runs with LEVEL/SLOPE control at top and bottom, and triggers on the negative slope of the display with LEVEL/SLOPE on -. Also, check that the TRIG'D lamp is on with triggered display.
3. Press the MAIN TRIGGERING NORM switch and repeat part 2. Note that the CRT display is the same, except when the LEVEL/SLOPE control is at the top and at the bottom. At these two positions, there should be no CRT display.
4. Press the MAIN TRIGGERING SINGLE SWP switch and rotate the LEVEL/SLOPE control 360°. Note that there is no CRT display. Return the LEVEL/SLOPE control to 0/+.
5. Observing the CRT, press the MAIN TRIGGERING READY switch. Note that there is one sweep each time the READY switch is pressed.
6. Disconnect the Calibrator signal from the Vertical unit Input connector and press the MAIN TRIGGERING READY switch. Note that no sweep occurs, but the READY switch light is on.
7. Observing the CRT, connect the Calibrator signal to the Vertical unit Input connector. Note that one sweep occurs and at the end of the sweep the READY light is out.
8. Press the MAIN TRIGGERING AUTO switch and rotate the LEVEL/SLOPE control for a triggered display. Rotate the POSITION control throughout its range. Note that the display moves left and right across the CRT. Position the start of the CRT display to the fifth vertical graticule line (see Fig. 5-2 in PERFORMANCE CHECK/CALIBRATION procedure).
9. Press in the X10 MAG switch and release. Note that the display still starts near the fifth vertical line on the CRT. Rotate the POSITION control to start the display on the zero vertical line. Note that the display now consists of one cycle of the Calibrator signal rather than 10 cycles. The rate of the displayed signal is the resultant of dividing the TIME/DIV switch setting by 10.

7B52 TEST SET-UP CHART

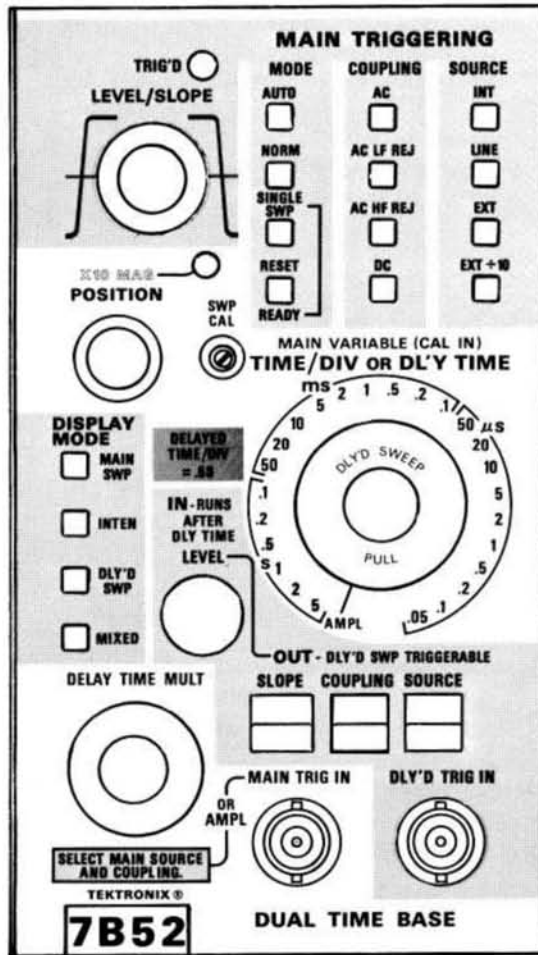

Fig. 2-5. 7B52 Test Setup Chart.

10. Lock the X10 MAG switch in (off).

11. Pull out on the DLY'D SWEEP switch and rotate clockwise to .1 ms. Press the DISPLAY MODE INTEN switch. Note that a normal sweep (Main Sweep) with an intensified portion (Dly'd Sweep) is displayed on the CRT. Rotate the DELAY TIME MULT (DTM) control and note that the intensified portion of the display is controlled by the DTM.

12. Release the DLY'D LEVEL control and rotate it from one end of rotation to the other (it is assumed that the DLY'D SLOPE, COUPLING, and SOURCE switches are locked in: +, AC, and INT). Note that rotation of the DLY'D LEVEL control controls the triggering of the intensified portion. Rotate the DTM, and observe that one complete revolution is required to move the intensified sweep one division on the CRT as compared with rotating the DTM in part 11. Lock in the DLY'D LEVEL control and set the DTM to 5-00.

13. Note the starting position of the intensified portion. It should start at the fifth vertical line on the CRT. Note the length of the intensified portion. It should be one division, or one complete cycle of Calibrator signal. The starting position of the intensified sweep is determined by the resultant of multiplying the DL'Y TIME switch setting (same as TIME/DIV) and the DTM dial setting. The length of the intensified portion is determined by the setting of the DLY'D SWEEP switch setting.

14. Press the DISPLAY MODE DLY'D SWP switch. Note that the CRT display now consists of one cycle of Calibrator signal. This is also the intensified portion observed in part 13, and gives the same result as obtained in part 9. The advantage of this mode over the one used in part 9 is that any cycle of the Calibrator signal may be viewed in a magnified form by merely rotating the DTM control. (Rotate the DTM to verify.) Return the DTM to 5-00.

15. Press the DISPLAY MODE MIXED switch. Note that the CRT display now consists of 5 complete cycles of normal sweep (Main Sweep) and 1/2 cycle of Dly'd sweep. Note also that the 1/2 cycle starts at the fifth vertical line. Under the above conditions, the first 5 cycles of Calibrator signal are presented at a rate of 1 ms (setting of TIME/DIV switch), the Dly'd sweep starts 5 ms after the Main sweep (DTM dial setting times the DL'Y TIME switch setting), and the Dly'd sweep is running at a rate of .1 ms (setting of DLY'D SWEEP switch).

NOTE

See the Specification section for any deviation in the settings listed above.

16. Rotate the DTM and note that, again, any portion of the Calibrator signal may be viewed.

17. Disconnect the Calibrator signal from the Vertical Unit Input connector and reconnect it to the AMPL (MAIN TRIG IN) connector. Set the TIME/DIV or DL'Y TIME and DLY'D SWEEP switches to AMPL and press the MAIN TRIGGERING EXT switch. Note that the CRT display now consists of two dots separately by approximately 4 major divisions.

18. Press the MAIN TRIGGERING EXT \div 10 switch. Note that the CRT display now consists of two horizontal dots separately by approximately .4 divisions.

This completes the First-Time Operation. It should be remembered different signal inputs require different 7B52 control settings, but the procedure for viewing these signals is essentially the same as given in this procedure.

SECTION 3

CIRCUIT DESCRIPTION

Change information, if any, affecting this section will be found at the rear of this manual.

Introduction

This section of the manual contains a description of the circuitry used in the 7B52 Dual Time Base. The description begins with a discussion of the major circuit functions using a simplified block diagram.

SIMPLIFIED BLOCK DIAGRAM

The Simplified Block Diagram, Fig. 3-1, shows interconnection of the basic circuit blocks in the 7B52. In some cases, such as the Main Sweep Trigger, the block includes a number of separate circuits. The individual circuits are discussed in detail later in this section.

Main Sweep Mode

When the DISPLAY MODE switch is set to select MAIN SWP, operation is as follows:

Main Sweep Trigger. This block includes circuitry for selecting the trigger source, type of coupling, triggering mode, and point on the trigger signal where triggering occurs. Also, regardless of the trigger signal shape or amplitude (within specification), this circuitry provides a fast-rise, uniform-amplitude pulse to the Main Sweep Start Multi. Termination of the pulse (or gate) occurs at the rise of Main Sweep Holdoff.

Main Sweep Start Multi. This circuit is activated by the positive gate from the Main Sweep Trigger block. The output signal coupled to the Main Sawtooth Generator is a positive gate with the same duration as the sweep. This gate is also coupled to the Sweep Gate Out block. A negative-going gate (coincident with the positive gate) is coupled to the Delayed Sweep Lockout Multi and the Delayed Sweep Start Control blocks.

Main Sawtooth Generator. The main sweep signal is developed by the Main Sawtooth Generator. When a positive gate from the Main Sweep Start Multi is applied, a sawtooth waveform is generated. The sawtooth duration is determined by the positive gate duration. Rate of change of the sawtooth is set by Ct and Rt, selected by the TIME/DIV switch.

Sweep Stop Comparator. One side of this comparator is driven by the main sweep sawtooth signal, and the other side is set by the Main Swp Stop adjustment. When the sawtooth waveform passes through the setting of the Main Swp Stop adjustment, the output of the Sweep Stop Comparator switches to a positive level. This positive step is applied to the Main Sweep Holdoff and via a small capacitance to the Main Sweep Start Multi. This resets the Main Sweep Start Multi so that it is ready to receive another trigger signal.

Main Sweep Holdoff. This circuit develops a gate which is used to prevent generation of a trigger signal until the sweep circuits have stabilized after a sweep. The positive step from the Sweep Stop Comparator initiates the positive holdoff gate. The duration of the holdoff gate is variable, depending on the setting of the TIME/DIV switch. Holdoff timing capacitors are separate from sweep timing capacitors. Holdoff is longer for slower sweep rates.

Output from the Main Sweep Holdoff is coupled to the Main Sweep Trigger and the Delayed Sweep Trigger blocks. A trigger signal cannot be generated during the holdoff interval. The holdoff serves to reset the trigger circuits so that they are ready to receive an input trigger signal after holdoff.

Horiz Output. The Horiz Output block includes the Ext Horiz Amp, Position Amp, Horiz Display Selector, and Horiz Out Amp circuits.

With the DISPLAY MODE switch set to MAIN SWP, this block selects the signal from the Main Sawtooth Generator, amplifies the signal, and converts the single-ended input to a push-pull output signal. A DC positioning level is also applied to this block.

Delayed Sweep Mode

To generate the delayed sweep, the Main Sawtooth Generator must first be gated on (see Main Sweep Mode).

Delay Pickoff. This circuit supplies a positive gate which starts when the main sawtooth signal passes through the level selected by the DELAY TIME MULT control. The gate ends with the main sawtooth signal. The output signal is coupled to the Delay Gate Amp.

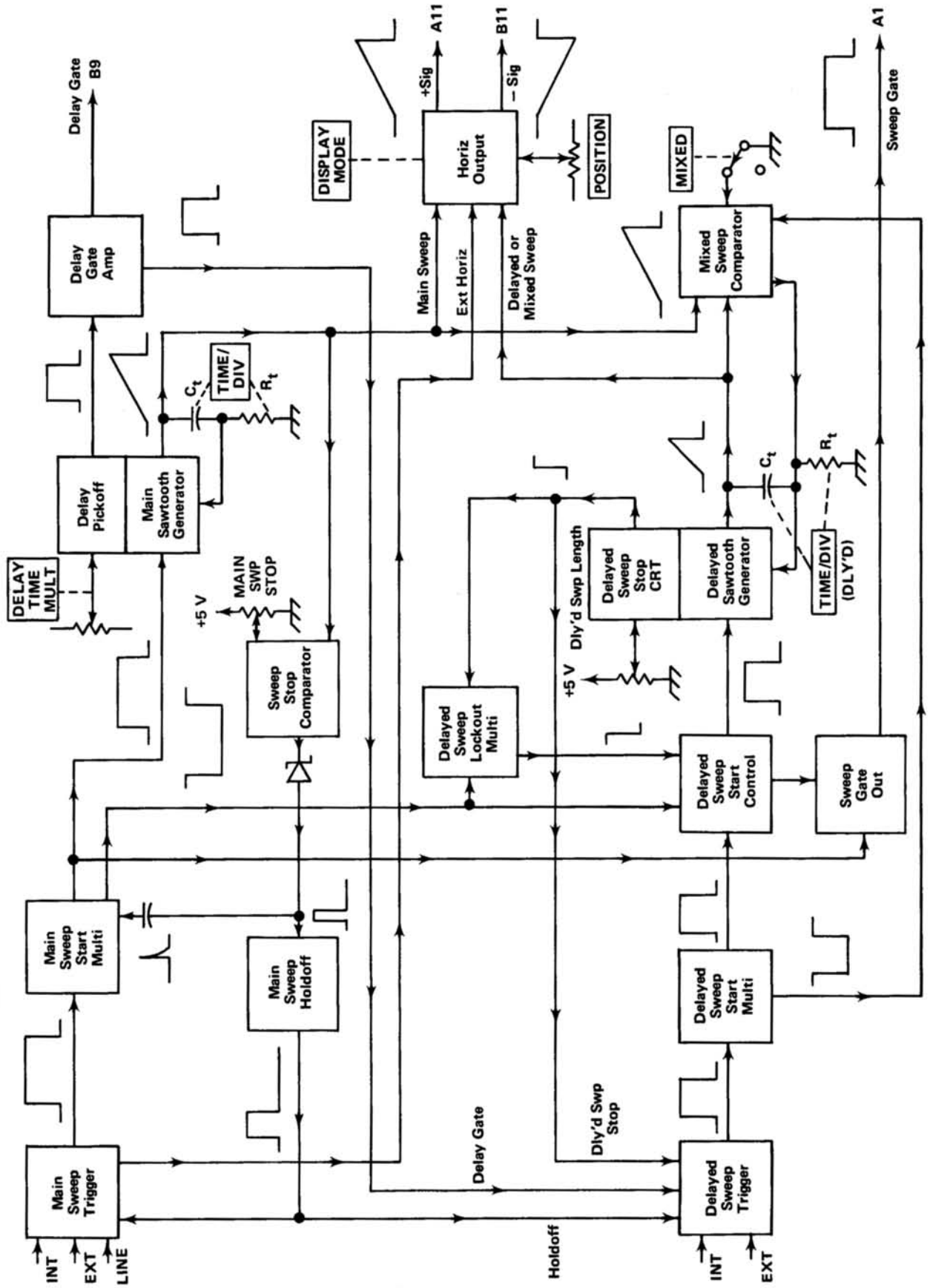

Fig. 3-1. 7B52 Simplified Block Diagram.

Delay Gate Amp. The positive gate from the Delay Pick-off circuit is coupled through the Delay Gate Amp to the Delayed Sweep Trigger block. Also, a negative-going Delay Gate signal is coupled to connector B9 when the internal Mainframe Delaying Mode switch (S59) is set to any position other than "Independent" and the DISPLAY MODE switch is in any selection other than MAIN SWP.

Delayed Sweep Trigger. When the Delayed Trigger LEVEL is pushed in, the output trigger is generated as soon as the Delay Gate signal is applied. If the LEVEL control is out, the output trigger is initiated by the next input trigger after the Delay Gate is applied.

The Delayed Sweep Trigger output is a positive gate which is terminated by the Holdoff signal and/or the positive step from the Delayed Sweep Stop circuit. The positive output gate is coupled to the Delayed Sweep Start Multi.

Delayed Sweep Start Multi. The signal from the Delayed Sweep Trigger causes the Delayed Sweep Start Multi to flip so that a positive gate is coupled to the Delayed Sweep Start Control, and a negative gate is applied to the Mixed Sweep Comparator. The output gates are the same in duration as the positive gate from the Delayed Sweep Trigger.

Delayed Sweep Start Control. For DLY'D SWP mode of operation the Delayed Sweep Start Control serves to couple the positive gate from the Delayed Sweep Start Multi to the Delayed Sawtooth Generator and the Sweep Gate Out.

Input signals from the Main Sweep Start Multi and the Delayed Sweep Lockout Multi are not effective in this mode.

Delayed Sawtooth Generator. The delayed sweep signal is developed by the Delayed Sawtooth Generator. The sawtooth is generated during the time that a positive gate is applied from the Delayed Sweep Start Control. Rate of change of the sawtooth is set by Ct and Rt, selected by the TIME/DIV (Dly'd) switch.

The sawtooth output signal is coupled to the Mixed Sweep Comparator and the Horiz Output circuits.

Delayed Sweep Stop Circuit. A positive step occurs at the output of the Delayed Sweep Stop circuit when the delayed sawtooth passes through the level selected by the Dly'd Swp Length adjustment. This step is coupled to the Delayed Sweep Trigger and the Delayed Sweep Lockout Multi.

Mixed Sweep Mode

In this mode of operation, the sweep is first running at the MAIN SWP rate and then, after the selected delay interval, runs at the DLY'D SWP rate. The main sweep and delayed sweep are initiated as previously described. Operation of other circuit blocks follows.

Mixed Sweep Comparator. This circuit determines which sweep signal is coupled to the Horiz Output stage. First, the main sweep sawtooth is coupled through the Mixed Sweep Comparator and the Delayed Sawtooth Generator to the Horiz Output stage. These stages perform as an operational amplifier during the time that the main sweep is being displayed.

When a positive gate from the Delayed Sweep Trigger is applied to the Delayed Sweep Start Multi, a negative gate is generated and coupled to the Mixed Sweep Comparator. This opens the Mixed Sweep Comparator circuit, preventing the main sweep sawtooth from being coupled to the Horiz Output circuit.

Simultaneously, the positive gate from the Delayed Sweep Start Multi is coupled through the Delayed Sweep Start Control to the Delayed Sawtooth Generator. The delayed sweep sawtooth is generated and coupled to the Horiz Output stage.

Delayed Sweep Lockout Multi. The positive step from the Delayed Sweep Stop Ckt is inverted by the Delayed Sweep Lockout Multi and coupled to the Delayed Sweep Start Control, thus turning off the Delayed Sawtooth Generator.

Sweep Gate Out. Depending on the selection of the DISPLAY MODE switch, this stage couples the positive gate from either the Main Sweep Start Multi or the Delayed Sweep Start Control to connector A1. The Sweep Gate signal serves to unblank the CRT in the Indicator Oscilloscope during the sweep.

External Horiz Input

When the TIME/DIV switch is set to AMPL, part of the Main Sweep Trigger circuitry becomes the Horiz Input Amp. An external signal connected to the MAIN TRIG IN or AMPL input is amplified and then coupled to the Horiz Output stage. The main and delayed sawtooth generators are disabled to prevent intensity modulation of the CRT trace by the unblanking waveforms.

CIRCUIT OPERATION

Introduction

The following circuit analysis of the 7B52 describes the operation of the various circuits in detail. The main headings (followed by a number enclosed in a diamond) refer to diagrams with the same name and number. The sub-headings indicate the individual circuit being described.

On the circuit diagrams, each individual circuit is outlined by a shaded border and the designation of each circuit is indicated within each outline.

The main block diagram in the last section of the manual shows interconnection between circuits.

MAIN TRIGGER PREAMP

The Main Trigger Preamp serves to select trigger source and coupling for the Main Trigger Generator. Also, when the TIME/DIV OR DL'Y TIME control is set to AMPL, the External Trigger Preamp becomes an amplifier for horizontal input signals.

The circuit may be considered as consisting of four elements as follows: (a) Trigger Source Switching, which includes U330, Q342 and Q344; (b) External Trigger Preamp or External Input Amplifier, consisting of Q308, Q312 and Q316; (c) Balanced-to-Single-Ended Converter, consisting of Q352, Q354 and Q358; and (d) Trigger Coupling, which includes Q362, Q364 and Q366.

Trigger Source Switching

U330 receives trigger inputs from pins 2 and 15 for internal triggering and from pin 7 for external trigger signals. Pin 4 of U330 determines which input signal is selected by means of a digital signal (voltage level). A "low" on pin 4 activates pins 2 and 15 for internal triggering, while a "high" on pin 4 switches U330 to activate pins 7 and 10 for external triggering.

To further examine U330, let us assume that pin 4 is low, activating pins 2 and 15 (internal triggering). This input is a relatively high impedance differential configuration. Pin 15 receives the positive-going trigger signal and pin 2 is the negative-going input. The inputs are biased at the center of their dynamic range, and signal-limiting in the trigger pickoff circuitry (in the indicator oscilloscope) assures that the inputs will not be driven into cutoff nor saturation. R336 and R337 terminate the internal trigger signal from the indicator oscilloscope. The analog current source for internal triggering is Q342, via pins 1 and 16.

The switch output current appears at pins 12 and 13. A positive-going signal at pin 15 will cause an increase in current into pin 13 and out through pin 16, R341, Q342 and R343. Simultaneously, the negative-going signal at pin 2 causes a decrease in current into pin 12 and out through pin 1, R342, Q342 and R343. The net result is that the total current through pins 12 and 13 and through Q342 and R343 remains constant.

External Trigger Preamp or Horizontal Input Amplifier

This circuit includes Q308, Q312 and Q316. The SOURCE switch (S7) at the input selects internal, external or line signals for triggering. The external trigger (or horizontal input) signal may be attenuated to one-tenth amplitude by selecting EXT ÷ 10. R13 and R14 (paralleled by R302) form a 10:1 attenuator.

The input impedance for the trigger (or amplifier) input is 1 megohm, consisting primarily of R5 and R302. This resistor pair also causes a 2X attenuation of the input signal as seen at the gate of Q308.

C301 serves to compensate the input stage and C10 compensates the 10X attenuator.

CR303 and CR305 protect Q308 from excessive input signal by clamping the gate if the signal at the input connector exceeds approximately + or -2.5 volts. The signal at the source of Q308 is coupled through emitter-follower Q312 to the base of Q316. Q316 is another emitter-follower which drives U330. The signal at pin 7 of U330 is terminated in approximately 50 ohms by R319 to preserve the high-frequency characteristics.

R330 sets the DC level at pin 10 of U330, which is the negative side of the external trigger differential input. This serves to match the DC balance of the external trigger input of U330 to that of the internal trigger input.

Balanced-to-Single-Ended Converter

Q352, Q354 and Q358 convert the balanced (push-pull) output of U330 to a single-ended signal at the emitter of Q358.

The trigger signal through U330 causes a decrease in current into pin 12 from R350 and R354 and an increase in current into pin 13 from R351. This would normally cause the voltage at pin 12 to swing in a positive direction, while pin 13 goes in a negative direction. However, the current through R350 and R354 actually increases due to the feedback via R355 and Q354, causing the voltage at pin 12 to

swing negative along with pin 13. Q354 is connected as a diode and is enclosed in the same heat-sink with Q352, providing good DC stability.

Trigger Coupling

When DC coupling is selected by the front-panel COUPLING switch, Q362 is turned on by the +15 V supply through R18, S6 and R361 to the base. The triggering signal is then coupled through R359 and Q362 to the base of Q402 (on Main Trigger Generator diagram).

Q364 is turned on when AC coupling is selected. The triggering signal then passes through Q364 and C364 to the base of Q402. For AC LF REJ coupling, Q364 is off and the triggering signal is coupled through C362 and C364, attenuating low-frequency signals.

For AC HF REJ coupling, both Q364 and Q366 are turned on. The high-frequency components are coupled through C367 and Q366 to ground, while the desired triggering component is coupled through Q364 and C364 (as in AC coupling).

MAIN TRIGGER GENERATOR

The Main Trigger Generator diagram includes the Slope Selector and Level Comparator, Trigger TD and Driver, Auto Multi, Auto Drive, TRIG'D Lamp Driver and Main Trigger Generator circuits. Operation of the individual circuits follows.

Slope Selector and Level Comparator

Q402, Q404, Q408, Q416, Q418 and Q428 comprise the Slope Selector and Level Comparator circuit.

Q402 and Q404 are connected as a differential comparator. The reference voltage for the comparator is selected by the setting of the LEVEL control, R2. The Main Trig. Level Center adjustment, R410, sets the level at the base of Q404 so that the sweep is triggered at the 0 volt point of the incoming trigger when the LEVEL control is set to the center of the positive or negative slope region. The LEVEL control varies the voltage on the base of Q404 to select the point on the trigger signal where triggering occurs.

Q408 and R408 establish the emitter current for Q402 and Q404. Prior to the arrival of a trigger signal, with the LEVEL control set to the center of the positive or negative slope, Q402 and Q404 are passing equal currents.

Let us assume that a positive-going signal is applied to the MAIN TRIG IN connector and that the LEVEL/SLOPE control is set to center on the positive slope.

The signal at the MAIN TRIG IN connector is inverted by the Main Trigger Preamp, appearing at the base of Q402 as a negative going signal. This will cause a decrease in current through Q402, and because of the common emitter source (Q408 and R408), the current through Q404 will increase.

The decreased collector current of Q402 biases Q418 in a reverse direction, while Q416 becomes more forward biased due to the increased current through Q404.

With the SLOPE switch (S2) in the + position, the cathode of CR424 is grounded, forward biasing CR424, which reverse biases CR423. At the same time, the base of Q428 is at ground and Q428 is off. This causes CR421 to be reverse biased and CR422 is forward biased through Q416. An increased current is applied through Q416 and CR422 to the Trigger TD and Driver circuit. (See Fig. 3-2.)

When the SLOPE switch is set to the - position, Q428 and CR421 are forward biased and CR422 is reverse biased. CR424 is reverse biased and CR423 is forward biased so that current flows through Q418 and CR423 to the Trigger TD and Driver circuit.

Trigger TD and Driver

The Trigger TD stage shapes the output of the comparator to provide a trigger pulse with a fast leading edge.

Tunnel diode CR430 is quiescently biased so that it is in its low-voltage state. Increased trigger current from Q416 and CR422 or Q418 and CR423 through R432, L432 and CR430 causes CR430 to switch to the high-voltage state. The resulting fast-rise positive step is coupled through emitter-follower Q434 to C441, C451 and C461 in the Auto Multi and Main Trigger Generator circuits.

Auto Multi

The Auto Multi circuit includes Q442 and Q448. When no trigger signal is applied, this circuit causes a current path in the Auto Drive circuit which turns on the output tunnel diode in the Main Trigger Generator after each holdoff gate. This enables a recurrent sweep with a repetition rate which increases with selected sweep rate, providing a bright reference trace when the trigger signal is absent or of insufficient amplitude.

When no trigger is applied, Q442 is off and C443 is charged to a positive level (at the collector of Q442) determined by R442, R701 and R702. The base of Q702 is more positive than the base of Q704, so Q704 is conducting.

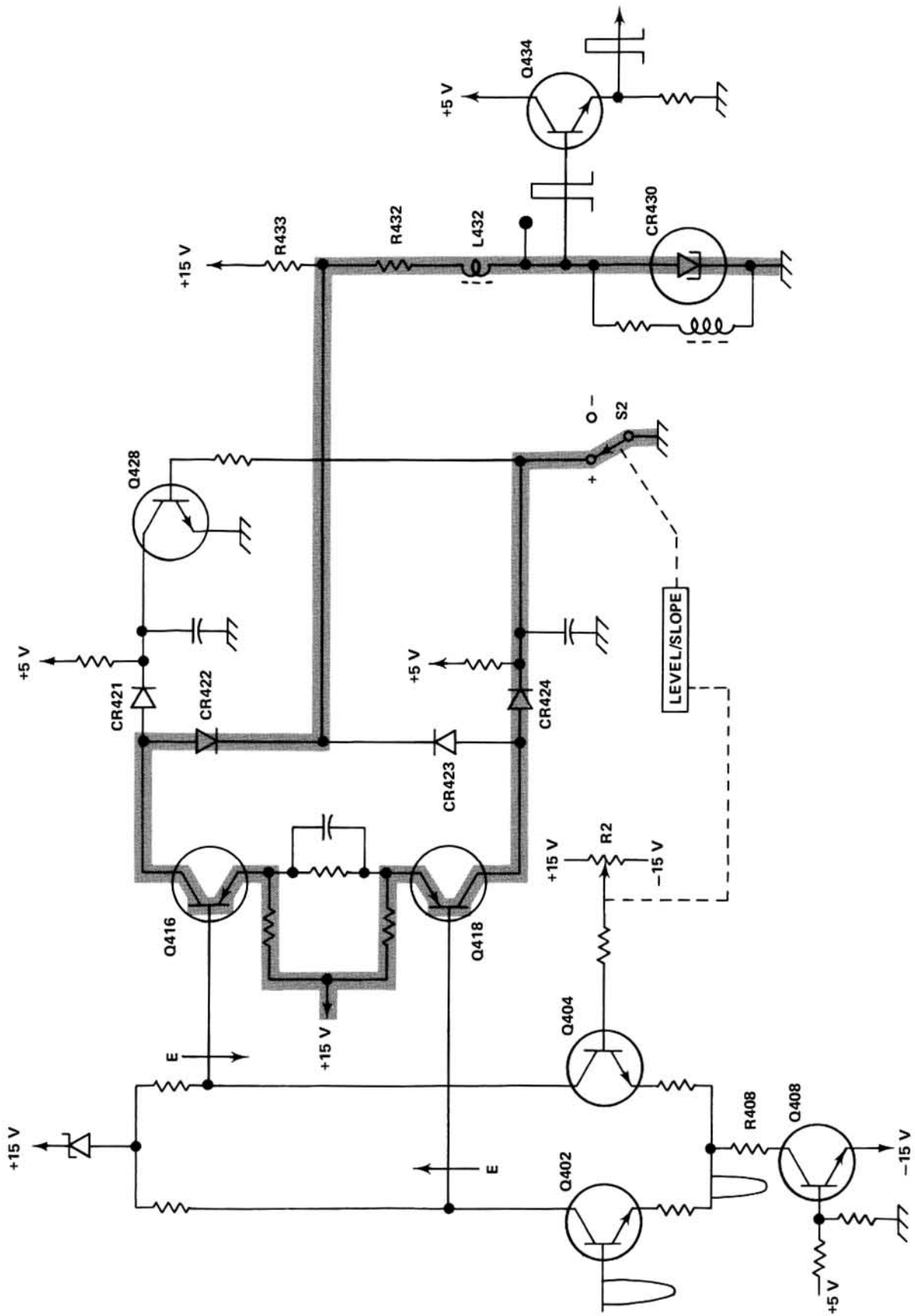

Fig. 3-2. Trigger current path for positive slope triggering.

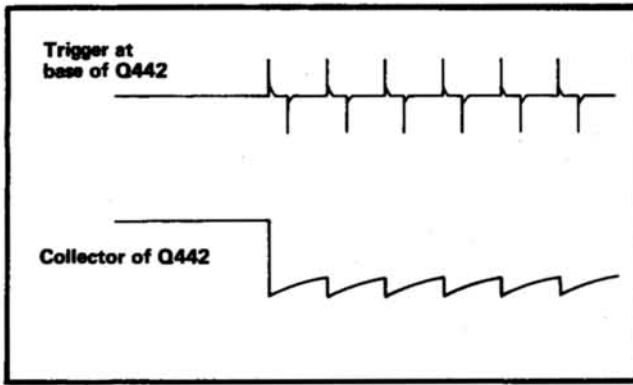

Fig. 3-3. Auto Multi input and output waveforms with trigger signal applied.

When a trigger is applied, Q442 and Q448 operate as an emitter-coupled monostable multi¹. Q442 is momentarily turned on by the positive transition coupled through C441.

The collector of Q442 drops and C443 discharges through R444, turning off Q448. This holds Q442 on for a period determined by the charging time-constant of C443. If the trigger signal has a repetition rate of 20 Hz or greater, Q442 stays on. (See Fig. 3-3.)

With Q442 on, Q702 is also conducting and Q704 is off.

TRIG'D Lamp Driver

During the time that Q442 is on, the increased drop across R442 forward biases Q702. This turns on Q710 which drives the TRIG'D lamp, DS2. The resulting discharge of C711 keeps DS2 illuminated between trigger pulses except at very low repetition rates.

Auto Drive

The Auto Drive circuit supplies additional current to the Main Trigger Generator to drive the output tunnel diode to its high-voltage state for automatically restarting the sweep after each holdoff interval if trigger signals are not available.

As described under Auto Multi, Q704 is conducting when AUTO mode is selected and no trigger signal is applied. CR41 and CR42 are off, so Q706 is also off. The current through Q704 flows through R706 and CR706, supplying the additional current to the output tunnel diode, CR475.

¹Millman and Taub, "Pulse and Digital Circuits", McGraw-Hill, New York, 1956, pp. 187-190.

When NORM or SINGLE SWEEP are selected by the MODE switch, S5, Q706 is forward biased via R707 and CR41 or CR42 respectively. This diverts any current from Q704, permitting normal triggering.

Main Trigger Generator

The Main Trigger Generator includes Q454, Q466, CR470 and CR475. The function of this circuit is to supply a fast-rise trigger signal to the Main Sweep Start Multi. For normal triggering, this signal is developed after receipt of a fast-rise transition from the Trigger TD and Driver stage, except during holdoff. In the AUTO mode of triggering with no trigger applied, CR475 is switched to the high state (forming a trigger) by current from the Auto Drive circuit. This is prevented from occurring during retrace by the hold-off signal.

For the following description of operation, assume that the MODE switch is set to NORM and that a trigger signal is applied to the MAIN TRIG IN connector.

The positive-going transition at the emitter of Q434 is coupled through C441, causing the TRIG'D lamp, DS2, to be energized as previously described.

CR470 and CR475 are both in their high states until the hold off signal switches them to low state. The holdoff signal is a positive pulse which forward biases both Q454 and Q466. When these transistors are forward biased, they divert current from CR475 and CR470 which causes the tunnel diodes to switch to low state.

The next trigger after holdoff appears as a positive transition at C451 and C461. The positive transition, coupled through R461 and R462 causes CR470 to switch to its high state. This higher level, through R472, brings CR475 up to near its switching current. The positive transition is also coupled through C451 and R451; and after 3.5 ns of delay, through R474 to CR475. The short delay assures that CR470 has had time to switch to its high state, arming CR475 before arrival of the switching signal at CR475. This prevents extraneous noise from prematurely activating CR475. CR475 then switches to its high state. The fast-rise positive trigger from CR475 is coupled to the Main Sweep Start Multi, Q722/Q726.

MAIN SWEEP GENERATOR 3

The Main Sweep Generator diagram includes 12 associated circuits as follows: (a) Main Sweep Start Multi, (b) Sawtooth Generator, (c) Delay Pickoff, (d) Sweep Stop Comparator, (e) Holdoff Circuit, (f) Delayed Mode Control, (g) Lockout Amp, (h) Reset Multi, (i) Sweep Lockout

Circuit Description—7B52

Multi, (j) Delay Gate Amp, (k) Ready Lamp Driver, and (l) Delay-Time Readout Drive.

For the following descriptions, unless stated otherwise, assume that a recurrent triggering signal is applied and that MAIN SWP is selected for DISPLAY MODE.

Main Sweep Start Multi

Q722, Q726 and Q730 comprise the Main Sweep Start Multi. Q722 and Q726 are connected as a bistable multivibrator. With no trigger signal applied, Q722 is off and Q726 is on.

When the Main Trigger Generator supplies a trigger, the positive transition is coupled to the base of Q722, causing Q722 to conduct. The current is diverted from Q726 to Q722. The collector of Q726 rises and the positive step is coupled through emitter-follower Q730. The positive step appears across divider R746/R747, causing pin 1 of U750 to go positive.

Sawtooth Generator

The lower half of the diagram symbol for U750 constitutes a Miller Integrator². When pin 1 is positive, a linear sawtooth (positive-going) is generated and appears at pin 8. The timing components, R_t and C_t connected to pins 8 and 9 determine the rate of change of the sawtooth waveform.

Sweep Stop Comparator

The Sweep Stop Comparator consists of U834A and U834B connected as a comparator. U834B is normally conducting, with its base level set by R835, the Main Sweep Stop adjustment. The resulting level at the common emitter connection reverse biases U834A.

The sawtooth signal from the Sawtooth Generator is coupled to the base of U834A. When the base of U834A rises above the level set at the base of U834B, the current through the common emitter resistor (R836) is diverted from U834B to U834A.

The collector of U834B rises. VR832 and C833 couple this positive step to the collector of Q722 (Main Sweep Start Multi) and through divider R725/R726 to the base of Q726. This forward biases Q726, which diverts current from Q722. The collector of Q726 drops to near zero volts and this level is coupled through Q730 to pin 1 of U750, terminating the sawtooth output signal.

²Millman & Taub, pp 540-548.

Since Q726 is conducting, Q722 becomes reverse biased and its collector rises. This rise reinforces the rise coupled through C833 and is coupled to the base of U834E.

Holdoff Circuit

The Holdoff Circuit consists of U834C, U834D and U834E plus R and C time constants selected by the TIME/DIV switch. The holdoff prevents retriggering the sweep generator until after the sweep timing capacitor(s) has discharged and sweep circuits are again ready to generate a sweep.

At the end of the sawtooth waveform, the resulting positive level at the output of the Sweep Stop Comparator is coupled to the base of U834E, as previously mentioned. This forward biases U834E and the collector current starts charging C843 and C841 or C842 (depending on setting of the TIME/DIV switch). U834C becomes reverse biased and the positive step at its collector is coupled through emitter-follower U834D. The positive step at the emitter of U834D is the holdoff gate signal. The holdoff gate is coupled to the Delayed Sweep Lockout Multi and through R785 and CR875 to the Main Trigger Generator, preventing generation of a trigger signal. This, in turn, prevents the Main Sweep Start Multi from initiating a sweep.

The positive impulse at the base of U834E is of short duration, having been coupled from the collector of Q722 through a small capacitance, C833. Therefore, when the RC time-constant in the collector of U834E has charged, U834C becomes forward biased. The drop at the collector of U834C is coupled through U834D, ending the holdoff gate. The Main Trigger Generator is released to generate a trigger signal.

Delay Pickoff

The upper half of the diagram symbol for U750 includes the Delay Pickoff circuitry. Inside U750, the main sweep sawtooth signal is applied to one side of a comparator circuit. Pin 6 is connected to the other side of the comparator. The setting of the DELAY TIME MULTIPLIER control, R19, determines the point on the main sweep sawtooth at which the comparator switches.

When the comparator switches (delay pickoff occurs), a positive gate appears at pin 4 of U750. This gate terminates at the end of the main sweep sawtooth.

Delay Gate Amp

The positive-going gate at pin 4 of U750 is coupled through emitter-follower Q762 to the Delayed Trigger Generator.

When S59 (see Display Mode Switching diagram) is set to either Runs After DT or Triggerable After DT and the DISPLAY MODE is set to any mode **except** MAIN SWP, approximately +5 volts is applied to the emitter of Q764. This enables Q764, and the positive gate at the emitter of Q762 is coupled through Q764, appearing as a negative-going gate at TP764. If S59 is set to Independent and/or the DISPLAY MODE is set to MAIN SWP, the emitter of Q764 is at ground level. Q764 is reverse biased and will not pass the delay gate signal.

Delay-Time Readout Drive

U736A, B, C, D and E are connected as a non-inverting amplifier. The voltage selected by the DELAY TIME MULTIPLIER control appears at the emitter of U736C, the output of this circuit.

This output is not used in present instruments, but is intended for use with future indicator oscilloscopes.

Reset Multi

The Reset Multi consists of U794C and U794D, connected as a monostable multivibrator. This stage is used to permit manual reset of the Sweep Lockout Multi when SINGLE SWP is selected by the MAIN TRIGGERING MODE switch.

With SINGLE SWP mode selected, +5 volts is applied to R826 (collector of U794D) and U794D is forward biased via R821, CR822 and CR823. When the front-panel RESET switch is pressed, the base of U794D momentarily goes to near zero volts. The collector of U794D rises, and the positive step is coupled through C827, forward biasing CR827. At the same time, the rise at the collector of U794D forward biases U794C. The drop at the collector of U794C causes C822 to start discharging, holding U794D in a reverse bias state until C822 has sufficiently discharged. Then, U794D again becomes forward biased and its collector drops, completing the cycle of operation.

Sweep Lockout Multi

U794A, U794B and Q798 comprise the Sweep Lockout Multi. This circuit permits external control of the initiation of a sweep by applying a positive level as holdoff to the Main Trigger Generator when no sweep is desired. The sweep can be held off under control of the single sweep reset, by means of an externally applied "sweep lockout"

signal, or as directed by an external Delayed Mode Control signal.

U794A and U794B are connected as a bistable multivibrator for normal operation. Q798 is forward biased by the positive level through R806 and CR807 to the emitter. This forward biases U794A, causing its collector to be near zero volts. The holdoff line is released, under control of the Holdoff Circuit.

In SINGLE SWEEP operation, the +5 volt supply is removed from the emitter circuit of Q798, reverse biasing U794A. The holdoff line goes positive, preventing generation of a sweep. When the RESET button is pressed, CR827 becomes forward biased for a short interval. This forward biases U794A, releasing the holdoff line. The Sweep Lockout Multi stays in this state until a sweep has been completed and the Holdoff Circuit generates the positive-level holdoff signal.

This positive level is coupled to the base of U794B via R787, C787 and CR789. The Sweep Lockout Multi reverts to its original state, with U794B on and U794A off, ready for the next RESET signal.

Lockout Amp

The Lockout Amp works in conjunction with the Delayed Mode Control circuit to allow the 7B52 to be controlled by another time base and perform as a delayed sweep unit. The Lockout Amp circuit includes Q42, Q44, Q818 and U794E.

Q42 and Q44 are connected as an operational amplifier. The input signal (Swp Lockout) at the base of Q42 is a positive gate during lockout. The positive gate is inverted by the operational amplifier, appearing as a negative gate at the base of Q818. The collector of Q818 rises and this positive level is coupled through CR817 to the holdoff line, preventing the initiation of a sweep. Q818 and U794E are connected as a comparator. When Q818 is biased off, U794E becomes forward biased.

Delayed Mode Control

The Delayed Mode Control circuit consists of Q804 and Q812. In response to the appropriate input signal, this circuit either biases the Swp Start TD (Main Trigger Generator) near the switching point so that a trigger can initiate a sweep, or biases the Swp Start TD at the high state so that a

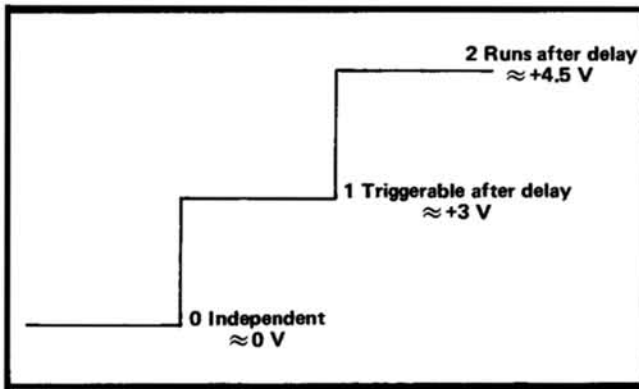

Fig. 3-4. Typical control levels into Delayed Mode Control circuit.

sweep is initiated immediately. Fig. 3-4 illustrates typical control signals coupled to the base of Q804.

When the input signal is at the 0 V level, Q804 is off and the 7B52 operates as an independent time base. If approximately +3 volts is applied to the base of Q804, Q812 conducts sufficient current to bias the Swp Start TD to just below the switching level so that a trigger signal applied to the TD will initiate a sweep. When the input level is approximately +4.5 volts, the current through Q812 biases the Swp Start TD at the high state, initiating a sweep immediately.

During the time that a Swp Lockout gate is applied to the Lockout Amp, the forward biasing of U794E causes Q812 to be reverse biased. This will prevent conduction of Q812 regardless of input signals to the Delayed Mode Control circuit.

Ready Lamp Driver

When the 7B52 is used in the SINGLE SWP mode, the READY lamp serves to indicate when the sweep is ready to accept a trigger signal. +5 volts is applied to the emitter of Q782, the Ready Lamp Driver, only when the MAIN TRIGGERING MODE switch is set to SINGLE SWP.

With no trigger signal applied, pressing the RESET button forward biases U794A (Sweep Lockout Multi). The collector of U794A is low, forward biasing Q782 which activates the READY lamp, DS5. The next trigger signal initiates a sweep, followed by a holdoff gate from the Hold-off Circuit. The positive-level holdoff is coupled through R782 and R783, reverse biasing Q782. The READY lamp is extinguished and remains in this state until the RESET button is pressed again.

DELAYED TRIGGER PREAMP 4

The Delayed Trigger Preamp is very similar to the Main Trigger Preamp (previously described), so only those portions that are different will be described in detail. The purpose of this circuitry is to select trigger source and coupling of the signal driving the Delayed Trigger Generator.

Dly'd Trigger Source Switching

U530 performs the function of selecting either the Dly'd Internal Trig Amp or the Dly'd External Trig Amp as the source of trigger. When pin 4 of U530 is positive, pins 7 and 10 are activated and an external trigger must be applied to the DLY'D TRIG IN connector. When pin 4 is low (near ground), pins 2 and 15 are active and an internal trigger source is selected.

Dly'd Internal Trig Amp

Q24, Q26, Q34 and Q36 are connected as a push-pull amplifier with approximately unity gain. Negative feedback is employed on each side to assure stability.

S21 (Internal Trigger Selector) selects either the normal internal trigger source, which is the same as that applied to the Main Trigger Preamp; or the auxiliary trigger source, which may supply a triggering signal from a different plug-in amplifier than that which is triggering the main time base. This switch is not a front-panel control, but is located internally.

Dly'd External Trig Amp

Q508, Q512 and Q516 comprise the Dly'd External Trig Amp. This circuit is identical with the Main External Trig Preamp. The amplifier provides a current gain and is terminated by R519 at pin 10 of U530.

Balance-to-Single-Ended Converter

This circuit includes Q552, Q554 and Q558. Except for minor differences in component values, the circuitry is identical with the Balanced-to-Single-Ended Converter in the Main Trigger Preamp. The output signal at the emitter of Q558 is inverted from the signal at the DLY'D TRIG IN connector.

Dly'd Trigger Coupling

When the COUPLING switch (S17) is set to DC, Q562 is forward biased via R56 and R561. The trigger signal is direct coupled between the emitter of Q558 and the base of Q602 (Slope Selector and Level Comparator). If the

COUPLING switch is set to AC, Q562 is reverse biased and the trigger signal is coupled through C562.

DELAYED TRIGGER GENERATOR 5

The Delayed Trigger Generator circuitry is essentially the same as the Main Trigger Generator, except there is no provision for automatic mode of triggering. Therefore, only the circuits that are different will be described in detail. For a detailed description of the rest of the circuitry, please refer to the Main Trigger Generator.

Slope Selector and Level Comparator

This circuit consists of Q602, Q604, Q616, Q618 and Q628. Operation is identical with the Slope Selector and Level Comparator on the Main Trigger Generator diagram.

When the input signal at the base of Q602 passes through the level set at the base of Q604, an increase in current occurs at the output.

Trigger TD

The Trigger TD is CR630. The increased current caused by applying a trigger to the Slope Selector and Level Comparator circuit is coupled through R632 and CR630, switching CR630 to its high state.

Delayed Trigger Generator

The Delayed Trigger Generator circuit includes Q654, Q666, Q862, CR670 and CR675. Operation of the tunnel diodes, CR670 and CR675 is identical to operation of the TD's in the Main Trigger Generator.

If the DLY'D LEVEL control is pushed in, S15 is in the "open" position and current through R871, CR655 and R674 to the Sweep Start TD (CR675) biases CR675 just below the switching level. When the Delay Gate is generated (at the Trigger Pickoff), the positive step at the junction of CR866 and CR869 forward biases Q862. This increases current through the Sweep Start TD, causing it to switch to the high state. This occurs immediately upon arrival of the Delay Gate, without need for a delayed trigger input.

When the DLY'D LEVEL control is in the "out" position (DLY'D SWP TRIGGERABLE), S15 is closed, forward biasing CR71. Q954 becomes forward biased and Q862 is reverse biased. The static current through CR675 is at a low level. Q862 becomes forward biased upon arrival of the Delay Gate signal at its emitter (via CR866). The resulting current biases the Sweep Start TD to just below the switching level. A trigger signal from the Trigger TD then causes the Sweep Start TD to switch to the high state.

The Dly'd Swp Holdoff coupled to the bases of Q654 and Q666 prevents the Sweep Start TD from switching until after the main sweep has occurred.

DELAYED SWEEP GENERATOR 6

The Delayed Sweep Generator diagram includes 11 associated circuits as follows: (a) Dly'd Swp Start Control, (b) Dly'd Swp Start Multi, (c) Dly'd Swp Stop Circuit, (d) Dly'd Swp Lockout Multi, (e) Dly'd Swp Holdoff, (f) Composite Swp Comparator, (g) Dly'd Sawtooth Generator, (h) Composite Swp Out, (i) Composite Swp Gate Out, (j) Aux Z Axis Control, and (k) Aux Z Axis Out.

For the following descriptions, unless stated otherwise, assume that the DISPLAY MODE is DLY'D SWP, the DLY'D LEVEL is pushed in (Runs After Delay) and the main sweep is running recurrently.

Dly'd Swp Start Multi

Q882 and Q886 comprise the Dly'd Swp Start Multi. This circuit is connected as a bistable multivibrator, with Q886 normally conducting and Q882 off.

When the Sweep Start TD switches to its high state, the positive step appears at the base of Q882. This causes the multi to flip, with Q882 on and Q886 off. The collector of Q886 goes positive. The Sweep Start TD is held in its high state for the duration of the Delay Gate. At the end of the Delay Gate, the Dly'd Sweep Start Multi reverts to its original state with Q882 off and Q886 on.

Dly'd Swp Start Control

The Dly'd Swp Start Control circuit includes Q902, Q904 and Q906. This circuit serves to couple a positive gate to pin 1 of U930 (Miller Integrator) to control the period during which a sawtooth is generated.

In all selections of the DISPLAY MODE switch except MIXED, Q902 and Q904 are inactive due to reverse bias current via CR901, S12 and the +5 volt supply. When the collector of Q886 (Dly'd Swp Start Multi) goes positive, Q906 couples the positive gate to pin 1 of U930, initiating the generation of a delayed sawtooth. At the end of the Delay Gate, the collector of Q886 drops. This ends the positive gate to pin 1 of U930, terminating the delayed sawtooth.

When the DISPLAY MODE switch is set to MIXED, CR901 anode circuit is open. The gate from the Main Swp Start Multi is negative-going at the base of Q904. The

Circuit Description—7B52

resulting current from Q904 forward biases Q906, and a positive gate is coupled to pin 1 of U930.

Mixed Swp Comparator

Q888, Q892, Q896 and Q898 comprise the Mixed Swp Comparator circuit. This circuit determines whether U930 is running up at the main sweep or delayed sweep rate.

With the DISPLAY MODE switch set to MIXED, Q892 is forward biased. The main sweep sawtooth at the emitter (and thus, the collector) of Q892 is a positive-going ramp. This causes a ramp of increasing current through Q896. During the time that a Delay Gate is not being generated, Q882 (Dly'd Swp Start Multi) is biased off and Q888 is on. In this condition, U930, Q888, Q896 and Q898 form an operational amplifier. The negative-going ramp at the collector of Q896 becomes a positive-going ramp at pin 8 of U930, running up at the main sweep rate.

When the Delay Gate is generated, the Delayed Trigger Generator forward biases Q882. The collector current through R888 reverse biases Q888, opening the operational amplifier loop. U930 is released to run up at the delayed sweep rate. Therefore, the sawtooth at pin 8 of U930 will first run up at the main sweep rate and then change to the delayed sweep rate when the Delay Gate is generated.

Dly'd Swp Stop Circuit

The upper half of the diagram symbol for U930 constitutes the Dly'd Swp Stop Circuit. The setting of the Dly'd Sweep Length adjust (R930) determines the point on the delayed sawtooth at which pin 4 of U930 will go positive.

Dly'd Swp Lockout Multi

Q942 and Q944 form the Dly'd Swp Lockout Multi. This circuit serves to terminate the delayed sweep as determined by the setting of the Dly'd Sweep Length adjust. When pin 4 of U930 goes positive, Q942 becomes forward biased. The negative-going step at the collector of Q942 forward biases Q902 (Dly'd Swp Start Control circuit). Q904 and Q906 become reverse biased, dropping the level at pin 1 of U930 and terminating the sweep.

Dly'd Swp Holdoff

The Dly'd Swp Holdoff circuit includes Q954. The hold-off gate at connector G is a composite of the positive gate from the Dly'd Swp Lockout Multi, the Main Swp Holdoff Gate via R952, and, when the DLY'D LEVEL control is set to DLY'D SWP TRIGGERABLE, the positive level set by Q954.

With the DLY'D LEVEL control set to DLY'D SWP TRIGGERABLE, Q954 is forward biased until the Delay Gate is generated. This pulls up the holdoff line to prevent the Sweep Start TD from switching to its high state with a trigger signal until after the Delay Gate is generated.

Composite Swp Out

Q962, Q966 and Q968 form the Composite Swp Out circuit. When the DISPLAY MODE switch is set to MAIN SWP or INTEN, Q966 is forward biased, coupling the main sweep sawtooth to the base of Q968. Q968 is an emitter-follower stage which couples the signal to output terminals A3 and B3.

If DLY'D SWP or MIXED is selected by the DISPLAY MODE switch, Q962 is forward biased and couples the delayed sweep or mixed sweep sawtooth to the base of Q968.

Q966 and Q968 or Q962 and Q968 (depending on DISPLAY MODE setting) are connected as an operational amplifier, providing a high degree of gain stability.

Aux Z Axis Control

The Aux Z Axis Control circuit includes Q984 and Q988. This circuit uses indicator oscilloscope mode and switching levels to determine when the sweep signal from the 7B52 is being displayed on the CRT. Information of this type is normally used only when operating the 7B52 in a four plug-in indicator oscilloscope.

Typical levels to cause the Aux Z Axis Control to intensify the CRT are +5 volts at terminal A16 and -0.6 volt at terminal B7. This forward biases Q988, resulting in a positive level at the emitter.

When the 7B52 is used in a three plug-in indicator oscilloscope and the DISPLAY MODE is set to INTEN, Q984 is off and Q988 is forward biased.

Aux Z Axis Out

Q992 is the Aux Z Axis Out stage. The output at connector DZ is connected to pin A17 on the interface connector and thence to the Z axis circuit in the indicator oscilloscope. A reduction in current through Q992 causes the CRT trace to brighten.

For this description, assume that the 7B52 is used in a three plug-in indicator oscilloscope.

As described under Aux Z Axis Control, when INTEN is selected by the DISPLAY MODE switch, Q988 is turned on. The positive level at the emitter of Q988 reverse biases CR991, which reduces conduction of Q992. The positive gate appearing at the emitter of Q906 (Dly'd Swp Start Control) during the delayed sweep further reduces current through Q992, causing the CRT trace to intensify beyond the normal level of unblanking.

In all other selections of the DISPLAY MODE switch, Q984 is forward biased through CR66. This turns off Q988, which diverts current through CR991. Q992 is in saturation and the CRT trace brightness is now set by the unblanking signal (Sweep Gate).

Composite Swp Gate Out

The Composite Sweep Gate Out circuit includes Q922, Q924 and Q928. The output at connector EM connects to interface connector pin A1 and is used to produce unblanking signals in the indicator oscilloscope. It is also used by the oscilloscope as the + gate output signal, and is selectable for producing the calibrator signal. A level of approximately +4 volts at connector A1 unblanks the CRT. In the AMPL position of the TIME/DIV (DL'Y) switch, connector A1 is set to approximately +4.3 volts (via CR100).

Q928 serves as the output stage. With the DISPLAY MODE switch set to either MAIN SWP or INTEN, Q922 couples the main sweep gate to the base of Q928. When either DLY'D SWP or MIXED is selected by the DISPLAY MODE switch, Q924 is on. The gate at the emitter of Q906 (Dly'd Swp Start Control) is coupled to the base of Q928.

HORIZONTAL PREAMP

The Horizontal Preamp diagram includes the Ext Horiz Amp, Horiz Display Selector, Position Amp, and Horiz Out Amp circuits.

Ext Horiz Amp

The Ext Horiz Amp consists of Q1004 and Q1006, connected as an operational amplifier³. The output signal, inverted from the input at connector A, is coupled through R1007.

Horiz Display Selector

Q1024 and U1020A, B, C, D and E comprise the Horiz Display Selector circuitry. Depending on the setting of the DISPLAY MODE switch or the TIME/DIV (DL'Y) switch, this circuit determines which signal is coupled to the Horiz Out Amp.

When the TIME/DIV (DL'Y) switch is set to AMPL, U1020C is forward biased and couples the signal from the Ext Horiz Amp to the Horiz Out Amp. Simultaneously, +5 volts is disconnected from the DISPLAY MODE switch, assuring that no internally generated sweep signal is coupled through at this time. In all other positions of the TIME/DIV (DL'Y) switch, +5 volts is connected to the DISPLAY MODE switch.

When MAIN SWP or INTEN is selected by the DISPLAY MODE switch, +5 volts is applied to the anode of CR111 or CR110 respectively. This forward biases U1020A, which couples the main sweep sawtooth to the Horiz Out Amp. Q1024 is also forward biased so that any signal developed by the Delayed Sweep Generator is bypassed to ground (via the -15 volt supply). Any output from the Ext Horiz Amp is coupled to ground through U1020D.

If the DISPLAY MODE switch is set to DLY'D SWP or MIXED, +5 volts is applied to the anode of CR108 or CR107 respectively. This forward biases U1020B, which couples the delayed sweep or the mixed sweep signal to the Horiz Out Amp. U1020E is also forward biased, coupling the main sweep signal to ground.

Position Amp

The POSITION control, R8, sets the bias on Q1014, thus setting the DC current coupled to the Horiz Out Amp.

Horiz Out Amp

The Horiz Out Amp includes Q1038, Q1046 and U1034A, B, C and D. U1034B and U1034C are connected as an operational amplifier, with R_f being R1052 and R_i the Swp Cal adjust, R60.

U1034C and U1034D form a paraphase amplifier. This stage converts the single-ended input signal from U1034B to a push-pull output signal which is necessary to drive the horizontal output stage in the indicator oscilloscope.

This stage also provides the X10 magnification and Mag Gain adjustment. When the X10 MAG switch is activated, R1045 and R1055 are connected in parallel with R1046 and R1056, decreasing the emitter degeneration of the stage. This increases gain of the stage 10 times. The Mag Gain adjust sets the degeneration to provide a calibrated

³Operational Amplifiers and Their Applications, Tektronix, Inc., Beaverton, Oregon 1965, Part No. 070-0526-00.

Circuit Description—7B52

gain when magnified. A contact of K1055 completes the circuit for the X10 MAG indicator lamp when the X10 MAG switch is activated.

Q1038 and U1034A set the operating bias for the output stage. Q1046 serves as a long-tailed (constant-current) source for U1034C and U1034D.

TIME/DIV READOUT SWITCHING



This diagram consists of switching resistors and a set of contacts operated by the TIME/DIV and X10 MAG switches. Also, when the DISPLAY MODE switch is set to DLY'D SWP or MIXED, a logic level is applied to connector B35 to enable simultaneous readout of the main and delayed sweep rates.

SECTION 4

MAINTENANCE

Change information, if any, affecting this section will be found at the rear of this manual.

Introduction

This section of the manual contains maintenance information for use in preventive maintenance, troubleshooting, and corrective maintenance of the 7B52.

PREVENTIVE MAINTENANCE

General

Preventive maintenance consists of cleaning, visual inspection, lubrication, etc. Preventive maintenance performed on a regular basis may prevent instrument breakdown and will improve the reliability of this instrument. The severity of the environment to which the 7B52 is subjected determines the frequency of maintenance. A convenient time to perform preventive maintenance is preceding recalibration of the instrument.

Cleaning

The 7B52 should be cleaned as often as operating conditions require. Accumulation of dirt in the instrument can cause overheating and component breakdown. Dirt on components acts as an insulating blanket and prevents efficient heat dissipation. It may also provide an electrical conduction path.

The covers of the indicator oscilloscope minimize the amount of dust which reaches the interior of the 7B52. Operation of the system without the indicator covers in place necessitates more frequent cleaning. When the 7B52 is not in use, it should be stored in a protected location such as a dust-tight cabinet.

CAUTION

Avoid the use of chemical agents which might damage the plastics used in this instrument. Avoid chemicals which contain benzene, toluene, xylene, acetone, or similar solvents.

Exterior. Loose dust accumulated on the outside of the 7B52 can be removed with a soft cloth or small paint brush. The paint brush is particularly useful for dislodging dirt on

and around the front-panel controls. Dirt which remains can be removed with a soft cloth dampened in a mild detergent and water solution. Abrasive cleaners can not be used.

Interior. Dust in the interior of the instrument should be removed occasionally due to its electrical conductivity under high-humidity conditions. The best way to clean the interior is to blow off the accumulated dust with dry, low-velocity air. Remove any dirt which remains with a soft paint brush or a cloth dampened with a mild detergent and water solution. A cotton-tipped applicator is useful for cleaning in narrow spaces.

Visual Inspection

The 7B52 should be inspected occasionally for such defects as broken connections, broken or damaged circuit boards, improperly seated transistors or relays, and heat-damaged parts.

The corrective procedure for most visible defects is obvious; however, particular care must be taken if heat-damaged components are found. Overheating usually indicates other trouble in the instrument; therefore, it is important that the cause of overheating be corrected to prevent a recurrence of the damage.

Transistor, FET, and Integrated Circuit Checks

Periodic checks of the transistors, FET's and IC's used in the 7B52 are not recommended. The best indication of performance is the actual operation of the device in the circuit. Performance of the circuits is thoroughly checked during recalibration; substandard transistors, FET's and IC's will usually be detected at that time.

Recalibration

To ensure accurate measurements, check the calibration of this instrument each 1000 hours of operation or every six months if used infrequently. In addition, replacement of components may necessitate recalibration of the affected circuits. Calibration instructions are given in Section 5.

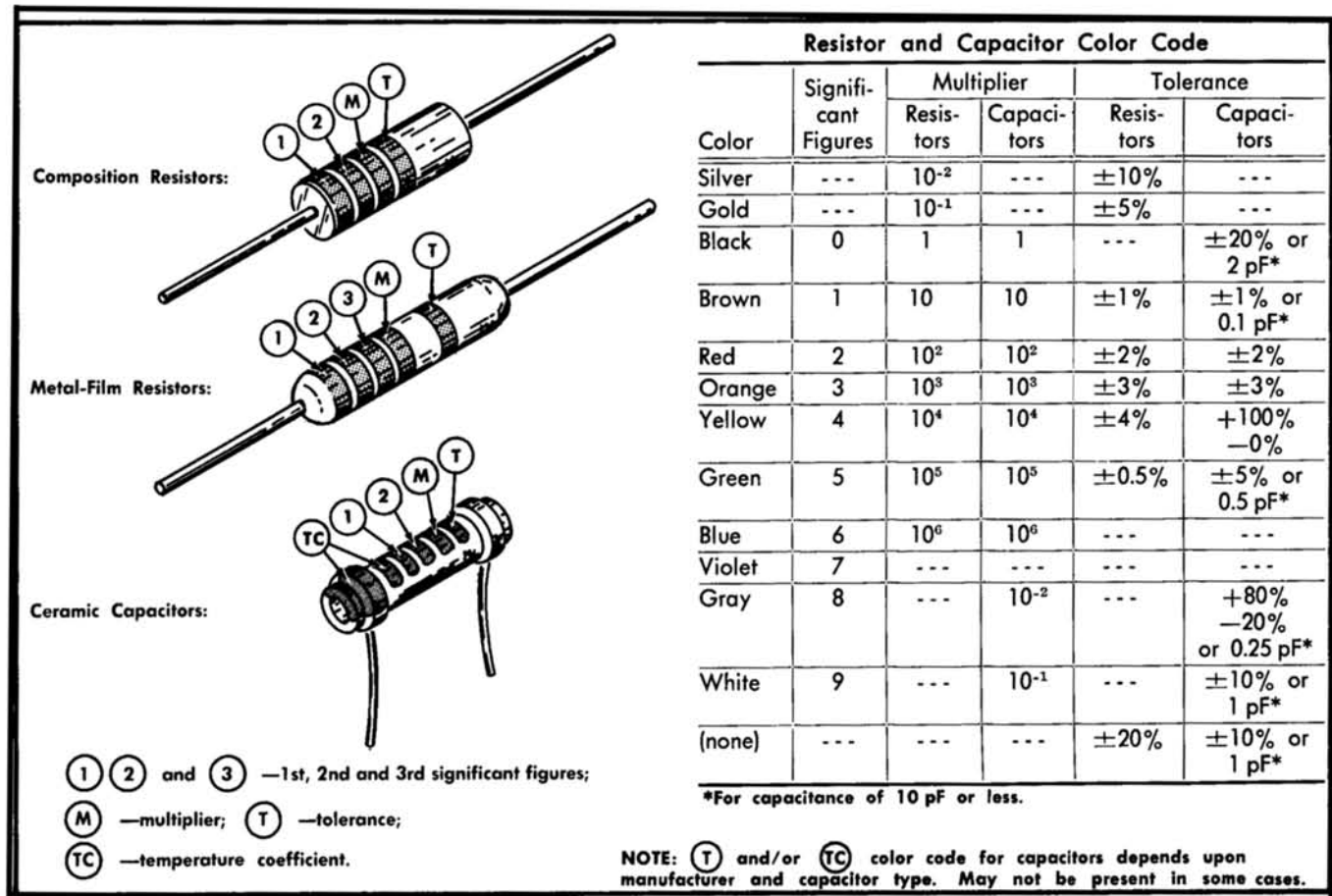

Fig. 4-1. Color-code for resistors and ceramic capacitors.

TROUBLESHOOTING

Introduction

The following information is provided to facilitate troubleshooting of the 7B52. Information contained in other sections of this manual should be used along with the following information to aid in locating the defective component. An understanding of the circuit operation is very helpful in locating troubles. See the Circuit Description section.

Troubleshooting Aids

Diagrams. Circuit diagrams are given on foldout pages in Section 7. The component number and electrical value of each component in this instrument are shown on the diagrams.

Circuit Boards. All circuit boards are shown in Fig. 4-3 through Fig. 4-7. All components are shown and should be used along with the diagrams in Section 7.

Switch Cam Identification. Switch cam numbers shown on the diagrams indicate the position of the cam in the complete switch assembly. The cams are numbered from the front, or mounting end of the switch, toward the rear.

Resistor Color Code. In addition to the brown composition resistors, some metal-film resistors and some wire-wound resistors are used in the 7B52. The resistance value of a wire-wound resistor is printed on the body of the component. The resistance values of composition resistors and metal-film resistors are color-coded on the components (some metal-film resistors may have the value printed on the body) with EIA color code. The color code is read starting with the stripe nearest the end of the resistor. Composition resistors have four stripes which consist of two significant figures, a multiplier, and a tolerance value; see Fig. 4-1. Metal-film resistors have five stripes consisting of three significant figures, a multiplier, and a tolerance value.

Capacitor Markings. The capacitance values of common disc capacitors and small electrolytics are marked in microfarads on the side of the component body. The white ceramic capacitors used in the 7B52 are color-coded in picofarads using a modified EIA code (see Fig. 4-1).

Diode Color Code. The cathode end of each glass-encased diode is identified by a stripe, a series of stripes, or a dot. For most silicon or germanium diodes with a series of stripes, the color code also indicates the type of diode or identifies the Tektronix Part Number using the resistor color-code system (e.g., a diode color-coded blue-or pink-brown-gray-green indicates Tektronix Part Number 152-0185-00). The cathode and anode ends of a metal encased diode can be identified by the diode symbol marked on the body.

Troubleshooting Equipment

The following equipment is useful for troubleshooting the 7B52.

1. Transistor Tester

Description: Tektronix Type 576 Transistor-Curve Tracer or equivalent.

Purpose: To test semiconductors used in this instrument.

2. Volt-ohmmeter

Description: 20,000 ohm/volt. 0-500 volts DC. Accurate within 3%.

Purpose: To measure voltages and resistance.

3. Test Oscilloscope

Description: DC to 100 MHz frequency response, 5 millivolts to 5 volts/ division. Use a 10X probe.

Purpose: To check waveforms in the instrument.

4. Plug-In Extender

Description: Rigid plug-in extender, Tektronix Part No. 067-0589-00.

Purpose: Permits operation of the 7B52 outside the plug-in compartment of the indicator oscilloscope for better accessibility during troubleshooting.

Troubleshooting Techniques

This troubleshooting procedure is arranged in an order which checks the simple trouble possibilities before proceeding with extensive troubleshooting. The first few checks ensure proper connection, operation, and calibration. If the trouble is not located by these checks, the remaining steps aid in locating the defective component. When the defective component is located, it should be replaced following the replacement procedures given under Corrective Maintenance.

1. Check Control Settings. Incorrect control settings can indicate a trouble that does not exist. If there is any question about the correct function or operation of any control, see the Operating Instructions section.

2. Check Associated Equipment. Before proceeding with troubleshooting of the 7B52, check that the equipment used with this instrument is operating correctly. Check that the signal is properly connected and that the probe (if used) is not defective. The indicator oscilloscope and vertical plug-in unit can be checked for proper operation by substituting another time-base unit which is known to be operating properly (preferably another 7B52 or similar unit). If the trouble persists after substitution, the indicator oscilloscope and/or vertical plug-in unit should be checked.

3. Check Instrument Calibration. Check the calibration of this instrument, or the affected circuit if the trouble exists in one circuit. The apparent trouble may only be a result of misadjustment and may be corrected by calibration. Complete calibration instructions are given in the Calibration section.

4. Visual Check. Visually check the portion of the instrument in which the trouble is located. Many troubles can be located by visual indications such as unsoldered connections, broken wires, damaged components, etc.

5. Isolate Trouble to a Circuit. To isolate a trouble to a circuit, note the trouble symptom. The symptom often indicates the circuit in which the trouble is located. For example, if normal triggering can be obtained in EXT mode but cannot be obtained in INT mode, the trigger preamp or the input coupling circuit is probably at fault. When the trouble symptoms appear, use the front-panel controls and the CRT display to try to isolate the trouble to one circuit. When the trouble appears in more than one circuit, check all affected circuits by taking voltage and waveform readings. Once the defective circuit has been located, proceed with steps 6 and 7 to locate the defective component(s).

6. Check Voltage and Waveforms. Often the defective components can be located by checking for the correct voltage or waveform in the circuit. Typical voltages and waveforms are given on the diagrams.



Do not clamp probe to pin connectors, as this may break or damage the connectors.

NOTE

Voltages and waveforms given on the diagrams are not absolute and may vary between instruments. To obtain operating conditions similar to those used for voltages and waveforms, see the first diagram page.

7. Check Individual Components. The following procedures describe methods of checking individual components in the 7B52. Components which are soldered in place are best checked by disconnecting one end. This isolates the measurement from the effects of surrounding circuitry.

a. **RELAY.** The eight pin relay used in the 7B52 is symmetrical and may be replaced in its socket facing either direction. This relay, which is plugged into the circuit board, may be removed and checked. Use an ohmmeter to check the 600 ohm resistance. The relay may also be actuated by placing +15 volts across the coil. The internal connections are printed on the body of the relay.

b. **TRANSISTORS.** The best check of transistor operation is actual performance under operating conditions. If a transistor is suspected of being defective, it can best be checked by substituting a new component or one which has been checked previously. However, be sure that circuit conditions are not such that a replacement transistor might also be damaged. If substitute transistors are not available, use a dynamic tester (such as a Tektronix Type 576).

c. **FET and IC's.** FET and IC's should not be replaced unless they are actually defective. The best method for checking these devices is by direct substitution. Refer to 7b above for circuit conditions.

d. **DIODES.** A diode can be checked for an open or shorted condition by measuring the resistance between terminals. With an ohmmeter scale having an internal source of between 800 millivolts and 3 volts, the resistance should be very high in one direction and very low when the leads are reversed.

CAUTION

Do not use an ohmmeter scale that has a high internal current. High currents may damage the diode.

e. **RESISTORS.** Resistors can be checked with an ohmmeter. Check the Electrical Parts List for the tolerance of the resistors used in this instrument. Resistors

normally do not need to be replaced unless the measured value varies widely from the specified value.

f. **INDUCTORS.** Check for open inductors by checking continuity with an ohmmeter. Shorted or partially shorted inductors can usually be found by checking the waveform response when high-frequency signals are passed through the circuit. Partial shorting often reduces high-frequency response.

g. **CAPACITORS.** A leaky or shorted capacitor can best be detected by checking the resistance with an ohmmeter on the highest scale. Do not exceed the voltage rating of the capacitor. The resistance should be high after initial charge of the capacitor. An open capacitor can best be detected with a capacitance meter or by checking whether the capacitor passes AC signals.

8. Repair and Readjust the Circuit. If any defective parts are located, follow the replacement procedures given in this section. Be sure to check the performance of any circuit that has been repaired, or that has had any electrical components replaced.

CORRECTIVE MAINTENANCE

General

Corrective maintenance consists of component replacement and instrument repair. Special techniques required to replace components in the instrument are given here.

Obtaining Replacement Parts

Standard Parts. All electrical and mechanical part replacements for the 7B52 can be obtained through your local Tektronix Field Office or representative. However, many of the standard electronic components can be obtained locally in less time than is required to order them from Tektronix, Inc. Before purchasing or ordering replacement parts, check the parts list for value, tolerance, rating, and description.

NOTE

When selecting replacement parts, it is important to remember that the physical size and shape of a component may affect the performance in the instrument, particularly at high frequencies. All replacement parts should be direct replacements unless it is known that a different component will not adversely affect instrument performance.

Special Parts. In addition to the standard electronic components, some special parts are used in the 7B52. These parts are manufactured or selected by Tektronix, Inc. to meet specific performance requirements, or are manufactured for Tektronix, Inc. in accordance with our specifications. These special parts are indicated in the parts list by an asterisk preceding the part number. Most of the mechanical parts used in this instrument have been manufactured by Tektronix, Inc. Order all special parts directly from your local Tektronix Field Office or representative.

Ordering Parts. When ordering replacement parts from Tektronix, Inc., include the following information.

1. Instrument Type.
2. Instrument Serial Number.
3. A description of the part (if electrical, include circuit number).
4. Tektronix Part Number.

Soldering Techniques

WARNING

Disconnect the instrument from the power source before soldering.

Circuit Boards. The components mounted on the circuit boards in the 7B52 can be replaced using normal circuit board soldering techniques. Keep the following points in mind when soldering on the circuit boards.

1. Use a pencil-type soldering iron with a power rating from 15 to 30 watts.
2. Apply heat from the soldering iron to the junction between component and circuit board.
3. Heat-shunt the lead of the component by means of a pair of long-nose pliers.
4. Avoid excessive heating of the junction with the circuit board, as this could separate the circuit board wiring from the laminate.

5. Use electronic grade 60-40 tin-lead solder.

6. Clip off any excess lead length extending beyond the circuit board, and clean off any residual flux with a flux-removing solvent. Be careful that the solvent does not remove any printing from the circuit board.

Metal Terminals. When soldering metal terminals (e.g., switch terminals, potentiometer, etc.), use 60-40 tin-lead solder and a 15 to 50 watt soldering iron. Observe the following precautions when soldering metal terminals:

1. Apply only enough heat to make the solder flow freely.
2. Apply only enough solder to form a solid connection. Excess solder may impair the function of the part.
3. If a wire extends beyond the solder joint, clip off the excess.
4. Clean the flux from the solder joint with a flux-removing solvent.

Component Replacement

WARNING

Disconnect the equipment from the power source before replacing components.

Relay Replacement. The relay in the 7B52 is manufactured by Tektronix, Inc. If the relay fails, a replacement may be ordered from your local Tektronix Field Office or representative. The eight-pin DPDT relay may be replaced in its socket either direction, as this relay is symmetrical.

Transistor, FET, and IC Replacement. Active devices used in this instrument should not be replaced unless actually defective. If removed from their sockets during routine maintenance, return them to their original sockets. Unnecessary replacement may affect the calibration of this instrument. When replaced, check the operation of that part of the instrument which may be affected.

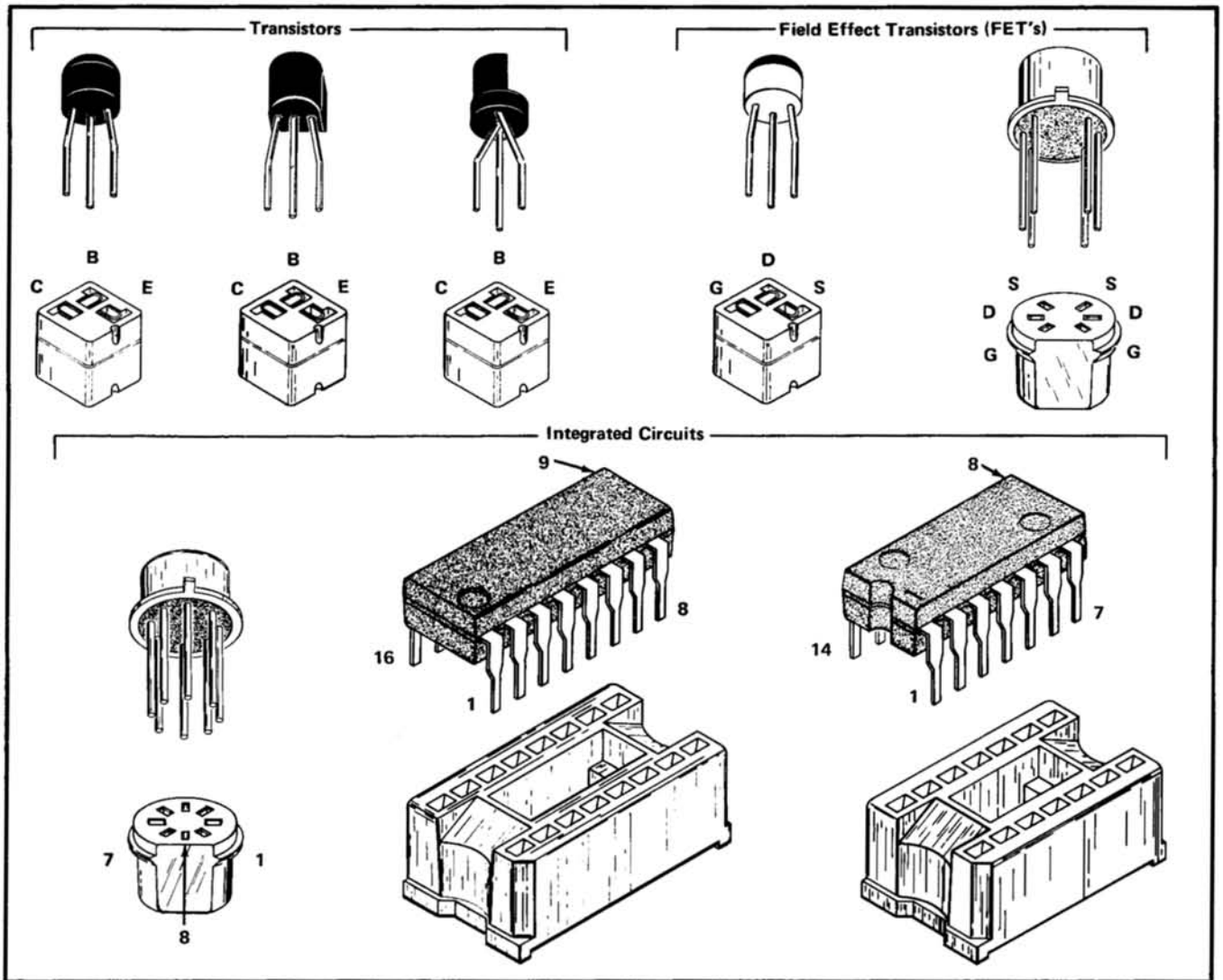

Fig. 4-2. Electrode configuration of transistors, FETs and integrated circuits used in this instrument.

Replacement devices should be of the original type or a direct replacement. Remount in the same manner as the original. Fig. 4-2 shows the lead configurations of the active devices used in this instrument. When replacing, check the manufacturer's basing diagram for correct basing.

Interconnecting Pins and Pin Socket Replacement. Two types of mating connectors are used for these interconnecting pins. If the mating connector is mounted on a plug-on circuit board, a special socket is soldered onto the board. If the mating connector is on the end of a lead, a pin connector is used to mate with the interconnecting pin. The following information provides the replacement procedure for the various types of pins and pin sockets.

a. **Circuit Board Pins.** To replace a pin which is mounted on a circuit board, first disconnect any pin connectors. Un-

solder the damaged pin and pull it out of the circuit board. Press the new pin into the hole in the circuit board so the ferrule on the pin is centered in the hole in the board. (Notice that the ferrule is not centered on the pin; be sure the replacement pin is positioned in the same manner as the original.) Solder the pin on both sides of the circuit board. If the pin was bent at an angle to mate with a connector, bend the new pin to match the associated pins. The inside radius of this bend should not be less than 0.025-inch.

b. **Circuit Board Pin Sockets.** The pin sockets on the circuit boards are soldered to the rear of the board. To replace the sockets, first unsolder the socket (use a vacuum-type desoldering tool to remove excess solder). Straighten the tabs on the socket to remove it from the hole in the circuit board. Place the new socket in the circuit board hole and press the tabs down against the board. Solder the socket tabs to the circuit board.

NOTE

The spring tension of the terminal sockets ensures a good connection between the circuit board and the pin. This spring tension can be destroyed by using the pin sockets as a connection point for spring-loaded probe tips, alligator clips, etc.

c. **End-Lead Pin Connectors.** The pin connectors used to connect the wires to the circuit board pins are clamped to the ends of the associated leads. To replace a damaged pin connector, first remove the old pin connector from the end of the lead. Clamp the new pin connector to the end of the lead. Some of the pin connectors are grouped together and mounted in a plastic holder. These connectors are removed and re-installed as a unit. To provide correct orientation of this multi-connector when it is replaced, an arrow is moulded into the plastic housing of the multi-pin connector and a matching arrow is stamped on the circuit board.

Switch Replacement. Two types of switches are used in the 7B52. The pushbutton switches and the cam-type switch should be replaced as a unit if damaged. The following special maintenance information is provided for the cam-type and pushbutton switches.

CAUTION

Repair of the cam switch should only be undertaken by skilled maintenance personnel. Switch alignment and contact spacing must be carefully maintained for proper operation of the switch. The cam switch repair kit (Tektronix Part No. 040-0541-00) contains special alignment tools for use in repairing or replacing the cam and contacts. For information or assistance on maintenance of the cam switch, contact your local Tektronix Field Office or representative.

a. **Cam-Type Switch.** The cam-type switch (TIME/DIV or DL'Y TIME and DLY'D SWEEP) consists of two rotating cams (front portion for TIME/DIV or DL'Y TIME and the rear portion for DLY'D SWEEP), which are turned by front-panel knobs, and contacts which are mounted on adjacent circuit boards (Readout and Interface). These contacts are actuated by lobes on the cam as it is turned. The switch can be disassembled for inspection, cleaning, repair, or replacement; it is recommended that the switch be removed from the instrument as a unit only. The following procedure should be followed.

NOTE

See Mechanical Parts exploded views for switch breakdown.

Removal and replacement of switch contacts on Readout board:

1. Remove J211 and J212 (brown and red wire connectors) located on the end of the Readout board.
2. Remove the 10 Phillips head screws holding the Readout board.
3. Lift the Readout board up and away from the top of the cam switch.

NOTE

With the readout board removed, the cam will be exposed from the top and may be cleaned, at this time by rotating the associated front-panel knobs.

4. Follow the procedure as given in the switch repair kit to remove, replace, etc., the contacts on the bottom side of the Readout board.
5. To replace the Readout board, reverse the above procedure, being sure to tighten the screws evenly.

Removal and replacement of switch contacts on Interface board:

1. Remove the front-panel knobs and ring associated with the switch. See the Mechanical exploded view, items 6, 7, and 8.
2. Remove J211 and J212 (brown and red wire connectors) located on the end of the Readout board.
3. Remove J114 (yellow wire connector) from the Interface board. (This connector is located directly below J211 and J212.)
4. Disconnect J755 (green wire connector) on the Sweep board.
5. Completely loosen the 6 screws holding the Sweep board.
6. Carefully lift the sweep board from the instrument; do not bend the pins from the interface board to the sweep board.

Maintenance—7B52

7. Remove the 10 Phillips head screws holding the cam switch to the Interface board. (Hold the cam switch while removing the screws.)

8. Remove the cam switch from the 7B52.

9. Follow the procedure as given in the switch repair kit to remove, replace, etc., the contacts on the Interface board.

10. To replace the cam switch, reverse the above procedure.

CAUTION

When replacing the 10 screws, tighten evenly. When replacing the Sweep board, do not apply much pressure until it is certain all pins from the Interface board have mated with the connectors on the Sweep board.

NOTE

When replacing the front-panel knobs and ring associated with the cam switch, slide the ring onto the shaft, but do not tighten. Then, install the large knob (it takes a little pressure) and tighten in place. Next, push the ring (from behind front-panel) until it seats properly with the large knob and lock in place. This will insure no backlash between the knob and ring as the cam is rotated.

b. Pushbutton Switches. For removal of pushbutton switches refer to the exploded views in the Mechanical Parts Diagram. The front panel and sub-panels must be removed.

Light Bulb Replacement. To replace the light bulbs, follow the above procedure to remove the switches (pushbutton). Remove the screw and cover from the back of the switch to expose the light bulb. Unsolder the two leads and remove the light bulb. Cut the leads of the replacement light bulb to the same length as the old bulb. Place insulating sleeves over the leads and replace the new bulb in the exact position of the old bulb.

Reassemble by reversing the procedure for removing the bulbs and switches.

Instrument Repackaging

If the 7B52 is to be shipped for long distances by commercial means of transportation, it is recommended that the instrument be repackaged in the original manner for maximum protection. The original shipping carton should be saved and used for this purpose. Repackaging information and/or new shipping cartons can be obtained from Tektronix, Inc. Contact your local Tektronix Field Office or representative.

NOTE

The plug-in should not be shipped installed in an indicator oscilloscope. The oscilloscope packaging material is not designed to protect plug-ins. See the Mechanical Diagrams for proper packaging of the 7B52.

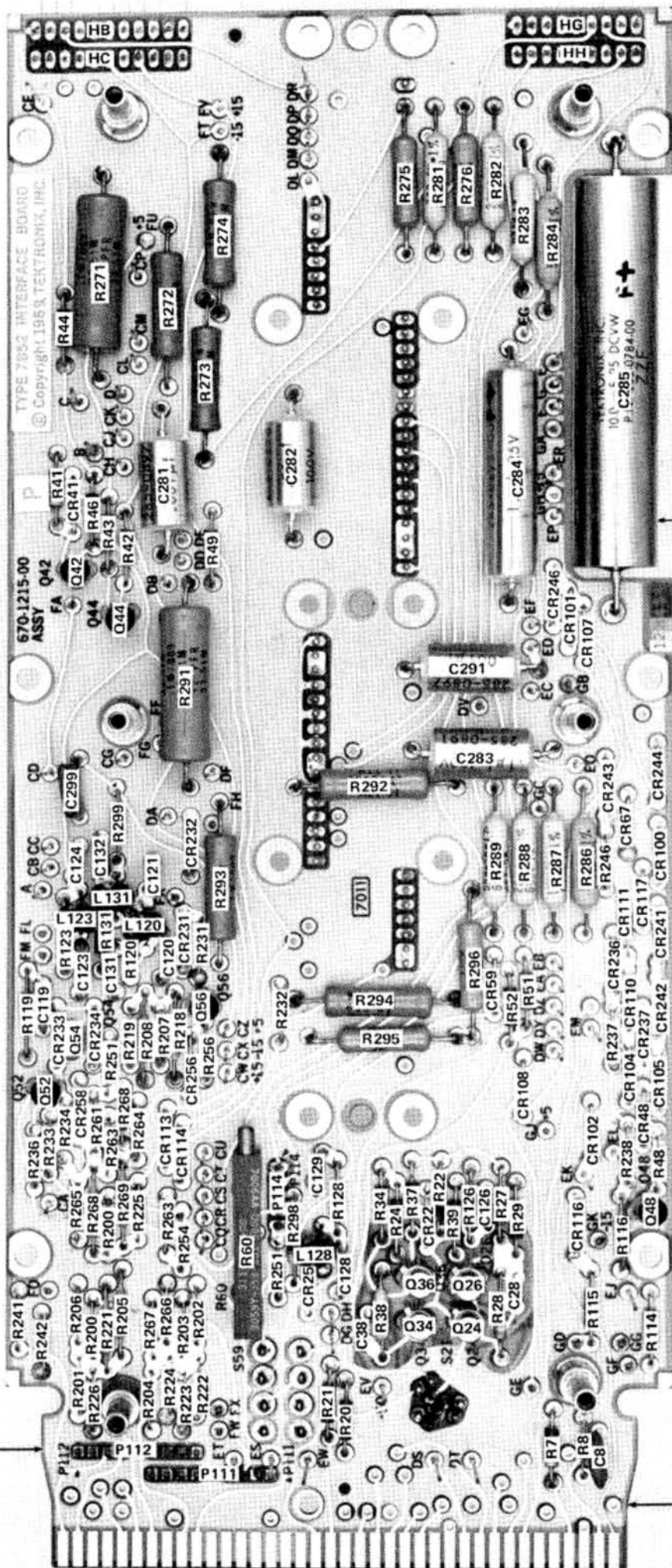

S59 (MAIN-FRAME DELAYING MODE, located on back side of board)

L16 (Located on back side of board on pin GA)

L29, L39 (Located on back side of board on pins GF and GG)

S21 (DELAYED TRIGGER SOURCE, located on back side of board)

Fig. 4-3. 7B52 INTERFACE BOARD showing component locations.

R823
(Located on
back side
of board)

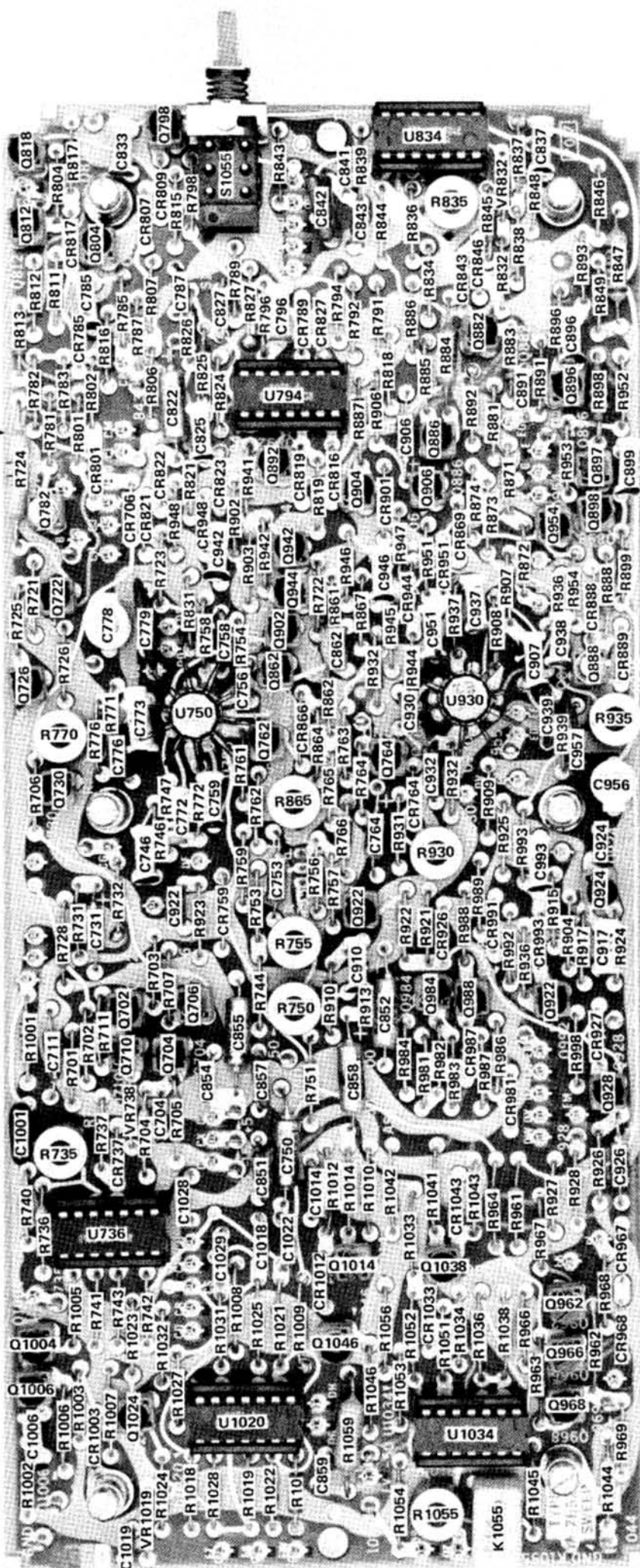
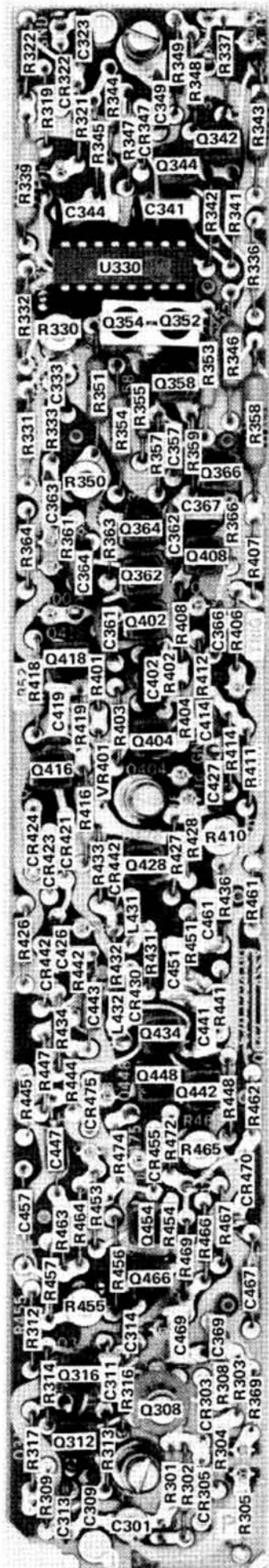
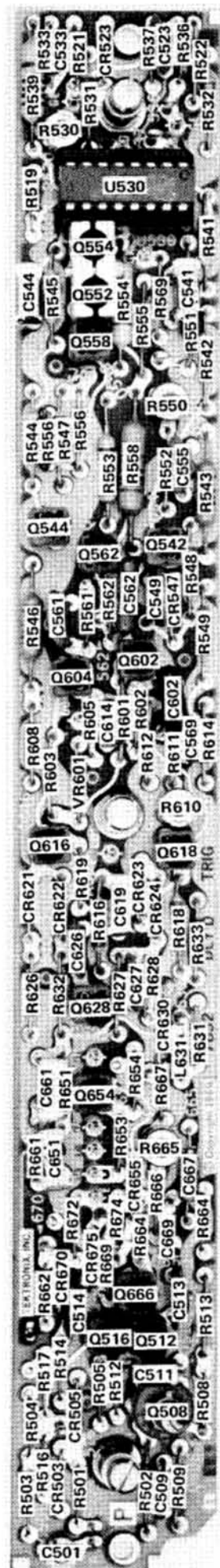

Fig. 4.4. 7B52 SWEEP BOARD showing component locations.



MAIN TRIG BOARD



DLY'D TRIG BOARD

(A)

Fig. 4-5. 7B52 MAIN TRIG BOARD (left) and DLY'D TRIG BOARD (right) showing component locations.

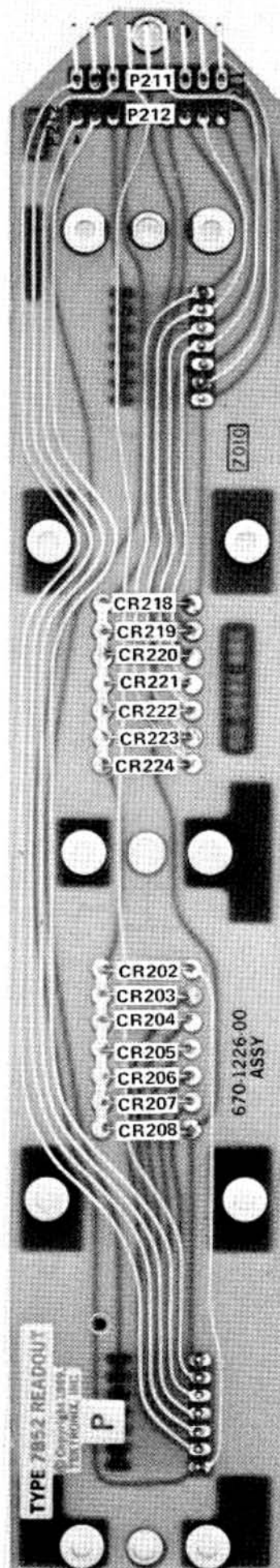

READOUT BOARD

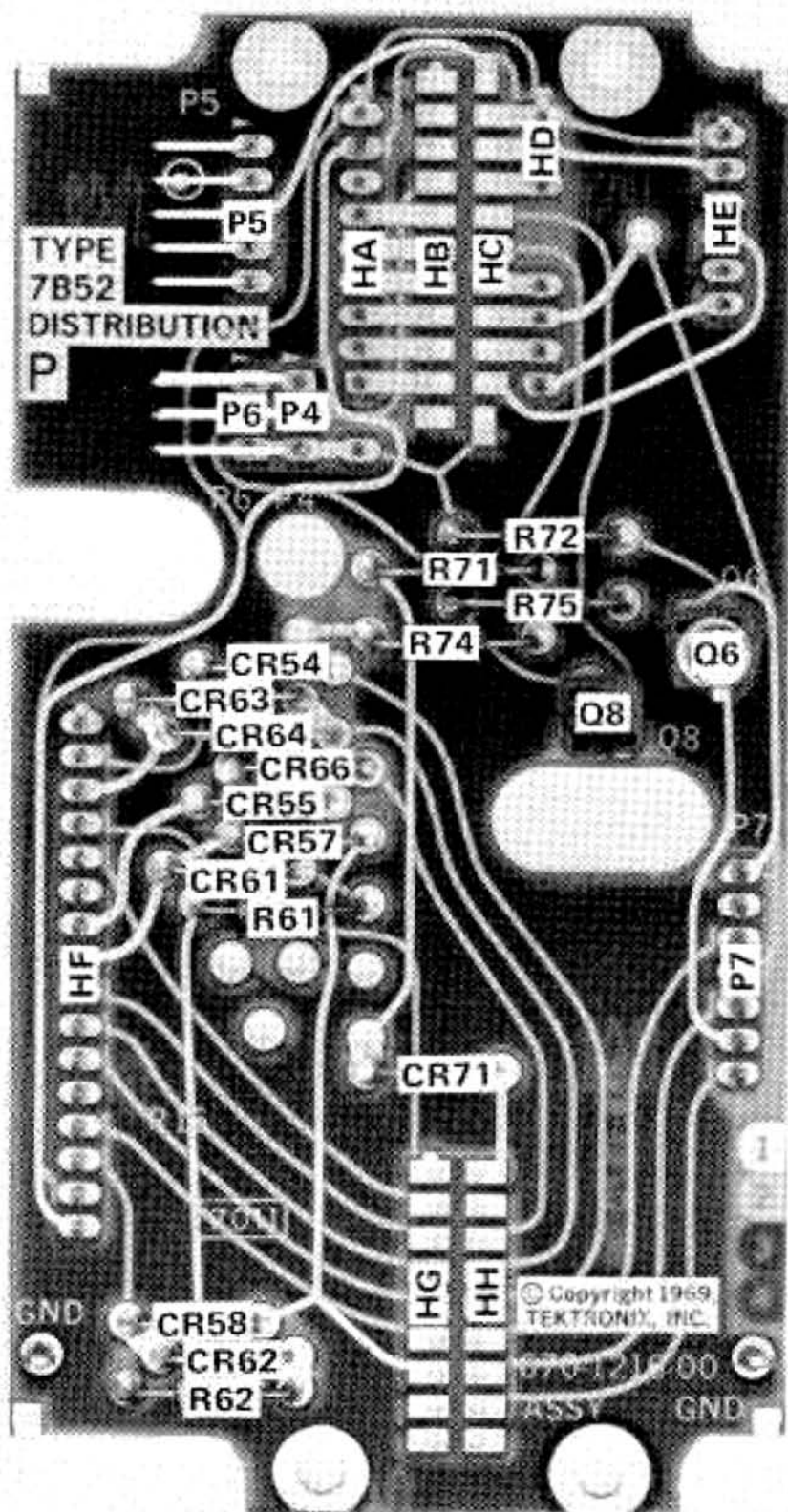

DISTRIBUTION BOARD

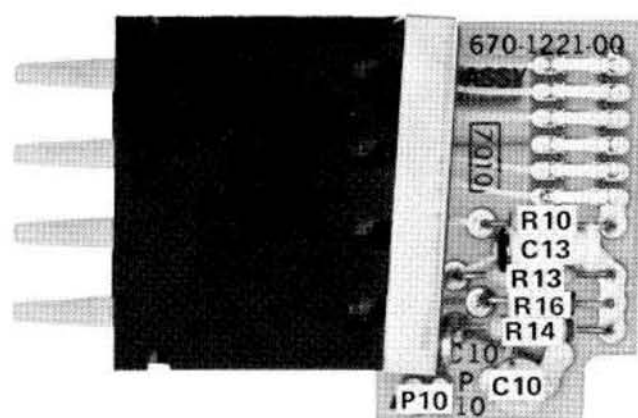

(A) SOURCE SWITCH

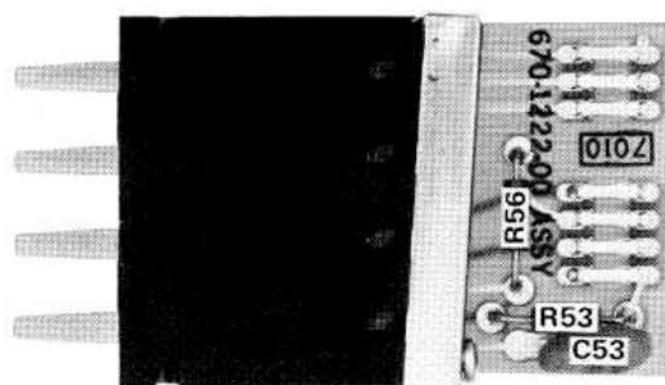

(B) COUPLING SWITCH

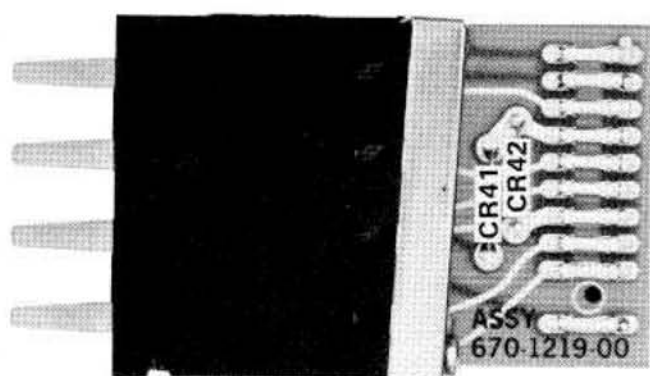

(C) TRIG MODE SWITCH

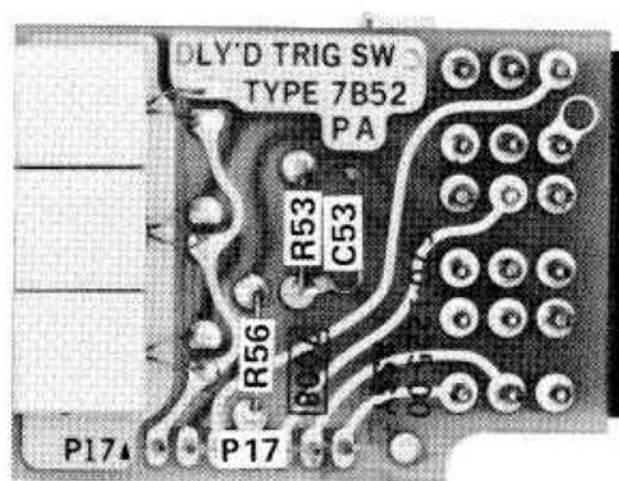

(D) DLY'D TRIG SWITCH

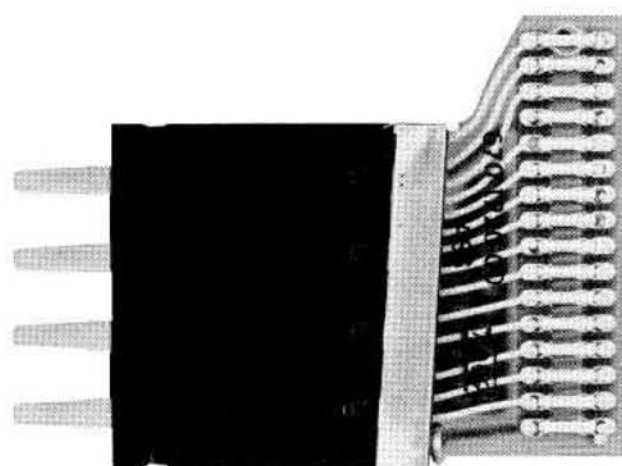

(E) DISPLAY MODE SWITCH

A

SECTION 5

PERFORMANCE CHECK / CALIBRATION

Change information, if any, affecting this section will be found at the rear of this manual.

Introduction

To assure instrument accuracy, check the calibration of the 7B52 every 1000 hours of operation, or every six months if used infrequently. Before complete calibration, thoroughly clean and inspect this instrument as outlined in the Maintenance section.

As an aid to the calibration of the instrument, a Short-Form Procedure is given prior to the complete procedure. To facilitate instrument calibration for the experienced calibrator, the Short-Form Procedure lists the calibration adjustments necessary for each step and the applicable tolerances. This procedure also includes the step number and title as listed in the complete Performance Check/Calibration Procedure, and the page number on which each step occurs. This procedure can be reproduced and used as a permanent record of instrument calibration.

The complete Performance Check/Calibration Procedure can be used to check instrument performance without removing the covers or making internal adjustments, by performing all except the ADJUST part of each step. Screwdriver adjustments which are accessible without removing the covers are adjusted as part of the Performance Check Procedure.

Completion of each step in the complete Performance Check/Calibration procedure insures that this instrument meets the electrical specifications given in Section 1. Where possible, instrument performance is checked before an adjustment is made. For best overall instrument performance when performing a complete calibration, make each adjustment to the exact setting, even if the CHECK is within the allowable tolerance.

NOTE

All waveforms shown in this procedure were taken with a Tektronix Oscilloscope Projected Graticule Camera System. Limits, tolerances and waveforms are given as calibration guides and should not be interpreted as instrument specifications unless actually given in the Specification section of this manual.

A partial calibration is often desirable after replacing components, or to touch up the adjustment of a particular circuit between major recalibrations. To prevent unneces-

sary recalibration of other parts of the instrument, readjust only if the result noted in the CHECK part of the step is not within listed tolerance. If readjustment is necessary, also check the calibration of any steps listed in the INTERACTION part of the step.

TEST EQUIPMENT REQUIRED

General

The following test equipment and accessories, or their equivalents, are required for complete calibration of the 7B52. Specifications given are those necessary for accurate calibration. Therefore, some of the recommended equipment may have specifications better than those given. All test equipment is assumed to be correctly calibrated and operating within the given specifications. If equipment is substituted, it must meet or exceed the specifications given here.

Special Tektronix calibration fixtures are used in this procedure only where they facilitate calibration. These special calibration fixtures are available from Tektronix, Inc. Order by part number through your local Tektronix Field Office or representative.

TEST EQUIPMENT

1. Oscilloscope Mainframe with readout. Tektronix 7503 (7504 or 7704)¹ Oscilloscope.
2. Amplifier. Bandwidth, 90 MHz; deflection factor, 5 volts to less than 50 millivolts. Tektronix 7A16.
3. ¹Time-Base. Compatible with Tektronix 7000-Series Oscilloscope. A 7B50 was used for this procedure.
4. Constant amplitude sine-wave generator. Reference frequency, 50 kHz; frequency range, 10 MHz to 100 MHz; output amplitude, variable from 150 millivolts to 5 volts. Tektronix Type 191 Constant-Amplitude Signal Generator.

¹ Required only if steps 26 and 27 are performed.

Performance Check/Calibration—7B52

5. Square-wave generator. Frequency, 1 kHz; risetime, 20 nanoseconds or less at 0.5 volts. Tektronix Type 106 Square-Wave Generator.

6. Time-mark generator. Marker outputs, five seconds to 100 nanoseconds; marker accuracy, within 0.1%. Tektronix 2901 or Type 184 Time-Mark Generators. (A Tektronix 2901 was used for this procedure.)

7. Low-frequency sine-wave generator. Frequency range, 20 hertz to greater than 50 kilohertz; output amplitude, 150 millivolts to 5 volts. For example, General Radio Model 1310-A Oscillator.

8. Plug-in extender. Tektronix Part No. 067-0589-00.

9. Input RC Normalizer. Time Constant, 1 megohm times 20 picofarads; connectors, BNC. Tektronix calibration fixture 067-0538-00.

10. 10X Voltage Probe. Attenuation, 10X within 3%; connector, BNC; input compensation, adjustable to allow compensation with amplifiers having input capacitance of 15 to 24 picofarads. Tektronix P6053 Voltage Probe.

11. Termination. Impedance, 50 ohm; type, feed-through; connectors, BNC; accuracy, $\pm 3\%$. Tektronix Part No. 011-0049-01. (Supplied with Tektronix 2901 Time-Mark Generator.)

12. Attenuator. Impedance, 50 ohm; attenuation, 10X; type, feedthrough; connectors, BNC; accuracy, $\pm 3\%$. Tektronix Part No. 011-0059-01.

13. Adapter. Connector, BNC-T. Tektronix Part No. 103-0030-00.

14. Adapter. Connectors, GR to BNC Female. Tektronix Part No. 017-0063-00.

15. Coaxial Cables (two required). Impedance, 50 ohm; length, 42 inches; connectors, BNC. Tektronix Part No. 012-0057-01. (Supplied with Tektronix 2901 Time-Mark Generator.)

16. Dual Input Cable. Connectors, BNC. Tektronix Calibration Fixture 067-0525-00.

17. Adjustment tools	Tektronix Part No.
a. Handle. Nylon for use with 003-0334-00 insert.	003-0307-00
b. Insert. Nylon, for use with 003-0307-00 handle.	003-0334-00
c. Screwdriver. 3/32-inch bit width, 3/32-inch diameter round shank, 5 inches long with a plastic handle.	003-0192-00

SHORT FORM PROCEDURE

7B52 Serial No. _____

Calibration Date _____

Calibration Technician _____

1. Check/Adjust MAIN TRIGGERING Page 5-6
(R350, R330, R410, R465, and R455)
See complete procedure.

Correct _____ Incorrect _____

2. Check/Adjust DLY'D TRIGGERING Page 5-8
(R550, R630, R618, R865, and R665)
See complete procedure.

Correct _____ Incorrect _____

3. Check Level Control Ranges Page 5-9

8 divisions of 50 kHz sine-wave applied to 7A16 Input.

Rotation of LEVEL/SLOPE control will select any level of display as sweep trigger point.

Correct _____ Incorrect _____

4. (Calibration Procedure Only) Adjust EXT Compensation (C501, C301, and C10) Page 5-9

5 divisions of 1 kHz square-wave signal applied to MAIN TRIG IN—DLY'D TRIG IN

DLY'D SWP—Adjust C501 for best square corner on leading edge of square wave at TP516.

MAIN SWP—Adjust C301 for best square corner on leading edge of square wave at TP316.

Adjust C10 for best square wave at TP316 with MAIN TRIGGERING SOURCE switch at EXT $\div 10$.

Correct _____ Incorrect _____

5. Check Trigger Bandwidth Page 5-10
See Complete Procedure
Correct _____ Incorrect _____
6. Check Trigger Jitter Page 5-10
1.5 divisions of 75 MHz sine-wave on CRT (750 mV to MAIN and DLY'D TRIG IN)
Check for no more than 1 ns of jitter.
Correct _____ Incorrect _____
7. Check Trigger Modes Page 5-11
4 divisions of 50 MHz sine-wave to 7A16 Input
Check for proper triggering in AUTO, NORM and SINGLE SWP.
Correct _____ Incorrect _____
8. Check/Adjust SWP CAL (R60) Page 5-12
1 ms markers applied to 7A16 Input
Adjust R60 for 1 ms marker each vertical line.
Check—timing accuracy is within 5% over any two divisions within the center eight divisions.
Correct _____ Incorrect _____
9. Check/Adjust Mag Sweep Gain (R1055) Page 5-13
.1 ms markers applied to 7A16 Input
Adjust R1055 for one .1 ms marker each vertical (X10 MAG switch on).
Check—timing accuracy is within 5% over any two divisions within the center eight divisions.
Correct _____ Incorrect _____
10. Check Mag Registration Page 5-13
.5 ms markers applied to 7A16 Input
Check for no more than 0.5 div of horizontal displacement of the .5 ms marker as the X10 MAG switch is switched off.
Correct _____ Incorrect _____
11. Check/Adjust Main and Dly'd Sweep Length (R835 and R930) Page 5-13
.1 and 1 ms markers applied to 7A16 Input
MAIN SWP—Adjust RR835 for a sweep length of 10.4 div at 1 ms.
Check for a sweep length of 10 to 13 divisions in all other positions.
DLY'D SWP—Adjust R930 for a sweep length of 10.4 div at .1 ms.
Check for a sweep length of 10 to 13 divisions in all other positions.
Correct _____ Incorrect _____
12. Check Position Range Page 5-14
1 ms markers applied to 7A16 Input
Check that rotation of POSITION control will position a 10.4 division display completely to the left and right of CRT center.
Correct _____ Incorrect _____
13. Check Variable Sweep Range Page 5-14
10 ms markers applied to 7A16 Input
Check for 2 major divisions or less between 10 ms markers as the MAIN VARIABLE control is rotated fully counterclockwise with TIME/DIV at 2 ms.
Correct _____ Incorrect _____
14. Check/Adjust HF Timing Page 5-14 (C778 and C956)
1 μ s markers applied to 7A16 Input
MAIN SWP—Adjust C778 for one 1 μ s marker each major division.
Check that timing accuracy is within 5% over any two divisions within the center eight divisions.
DLY'D SWP—Adjust C956 for one μ s marker each major division.
Check that timing accuracy is within 6% over any two divisions within the center eight divisions.
Check that timing accuracy is within 6% over any two divisions within the center eight divisions with the X10 MAG switch on.

Performance Check/Calibration—7B52

- MAIN SWP—Check that timing accuracy is within 5% over any two divisions within the center eight divisions with the X10 MAG switch on.
- Correct _____ Incorrect _____
15. Check Mag Swp Timing Accuracy Page 5-15
See Complete Procedure
Correct _____ Incorrect _____
16. Check Sweep Timing Accuracy Page 5-16
See Complete Procedure
Correct _____ Incorrect _____
17. Check/Adjust Sweep Offset (R730 and R935) Page 5-16
No signal applied. (X10 Probe to TP779 or TP995)
Main Swp and DLY'D SWP—Each sweep must start within 1 major division of the other.
MAIN SWP—Adjust R730 to start display at CRT center (10X probe to TP779)
DLY'D SWP—Adjust R935 to start display at CRT center (10X probe to TP995)
Correct _____ Incorrect _____
18. Check/Adjust Dly'd Start and Dly'd Stop (R755 and R750) Page 5-17
See Complete Procedure
Correct _____ Incorrect _____
19. Check Delay Time Mult Accuracy Page 5-17
1 ms markers applied to 7A16
Check that DELAY TIME MULT control is accurate to within 0.2% between 9-00 and 1-00.
Correct _____ Incorrect _____
20. Check Delay Time Accuracy Page 5-17
See Complete Procedure.
Correct _____ Incorrect _____
21. Check Delay Time Jitter Page 5-19
1 ms markers applied to 7A16
Check that jitter is less than 1 division with TIME/DIV switch at 1 ms and DLY'D SWEEP at .5 μ s.
Correct _____ Incorrect _____
22. Check Mixed Sweep Page 5-19
1 ms markers applied to 7A16 Input
Check—Mixed sweep timing accuracy is within 2% plus error of Main Sweep over the center eight divisions of the CRT. See the Specification section.
Correct _____ Incorrect _____
23. Check External Amplifier Gain Page 5-19
4 divisions of 100 kHz signal applied to MAIN TRIG IN.
Check for horizontal trace length of 8 div within 10% in EXT.
Check for horizontal trace length of 0.8 div within 10% in EXT \div 10.
Check for horizontal trace length of 8 div within 10% EXT \div 10 with X10 MAG switch on.
Correct _____ Incorrect _____
24. Check External Bandwidth Page 5-20
See Complete Procedure.
Correct _____ Incorrect _____
25. Check Line Triggering Page 5-20
AC (60 Hz) to 7A16 Input
Check that the LEVEL/SLOPE control will cause proper triggering of the display with the MAIN TRIGGERING SOURCE switch at LINE.
Correct _____ Incorrect _____
26. (Optional) Check Mainframe Delaying Mode Selector Switch Page 5-20
See Complete Procedure.

27. (Optional) Check Delayed Trigger Source Selector Switch Page 5-21

See Complete Procedure.

Readout	As desired
Graticule Illum	CCW
Beam Finder	Normal
Calibrator	Off
Rate	Any

General

The following procedure is arranged so the 7B52 can be calibrated with the least interaction of adjustments and re-connection of equipment. A photo of all test equipment, adapters, cables, etc., required for the complete Performance Check/Calibration is given to aid in identification of the necessary equipment used in the following steps; see Fig. 5-1. The control settings continue from the preceding step(s) unless noted otherwise.

The following procedure uses the equipment listed under Test Equipment Required. If other equipment is substituted, control settings or calibration setup may need to be altered to meet the requirements of the equipment used. Detailed operating instructions for the test equipment are not given in this procedure. Refer to the instruction manual for the test equipment used.

NOTE

This instrument should be calibrated to an ambient temperature of +25°C, ±5°C for best overall accuracy. If the temperature is outside the given range, see Section One for the applicable tolerances.

Procedure

1. Set all test equipment and the 7B52 controls as follows:

7A16 Control Settings

Position	Midrange
AC-GND-DC	GND
Polarity	+ Up
Bandwidth	Full
Volts/Div	.5 V
Variable (Volts/Div)	Locked In (off)

7503 Indicator Oscilloscope Settings

Vert Mode	
Vertical Mode	Left
Trigger Source	Left Vert
Focus	Midrange
Intensity	CCW
Control Illum	Low

7B52 Control Settings

LEVEL/SLOPE	Midrange (between 0/+ and 0/-)
MAIN TRIGGERING MODE	AUTO
COUPLING	AC
SOURCE	INT
POSITION	Midrange
X10 MAG	Locked in (off)
DISPLAY MODE	MAIN SWP
TIME/DIV or DL'Y TIME	20 μs
DLY'D SWEEP	10 μs
MAIN VARIABLE	Locked in (CAL)
DLY'D TRIGGERING LEVEL	OUT, mechanical midrange
SLOPE	In (+)
COUPLING	In (AC)
SOURCE	In (INT)
DELAY TIME MULT	1-00

2. (Performance Check Only) Install the 7B52 directly into the right compartment of the 7503 Indicator Oscilloscope.

3. (Calibration Procedure Only) Install the 067-0589-00 Plug-In Extender into the right compartment of the 7503 Indicator Oscilloscope.

4. (Calibration Procedure Only) Remove the side covers from the 7B52 and connect the 7B52 to the 067-0589-00 Plug-In Extender.

5. Turn on the 7503 Indicator Oscilloscope and allow at least 20 minutes warmup before proceeding with the Performance Check/Calibration procedure.

NOTE

During this procedure, whenever a particular 7B52 switch is pressed, that switch should light up. Also, the CRT readout should always indicate the correct setting of the TIME/DIV or DL'Y TIME, DLY'D SWEEP, and MAIN VARIABLE switches. No further reference will be made to these conditions, but they must be checked.

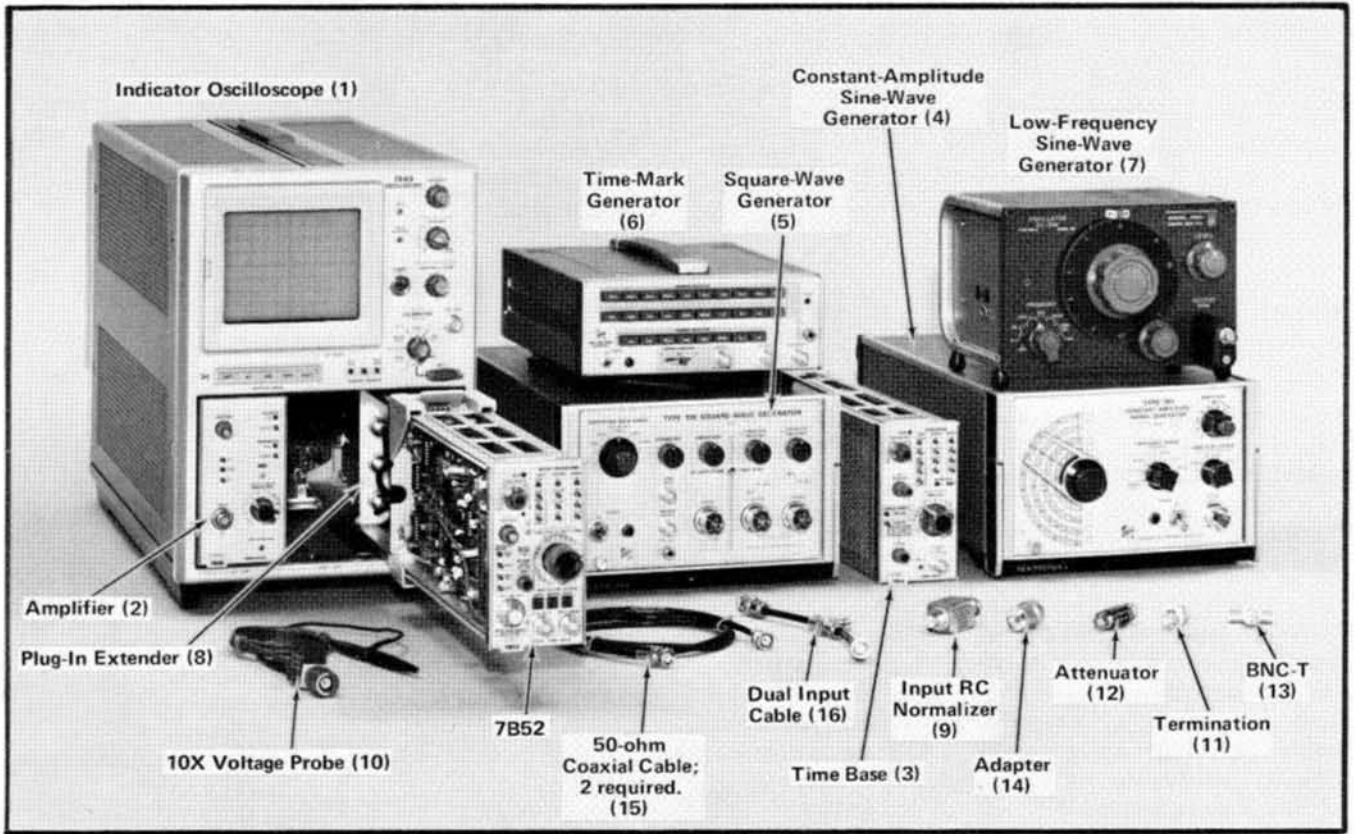

Fig. 5-1. Test equipment required for the Performance Check/Calibration Procedure.

1. Check/Adjust MAIN TRIGGERING (R350, R330, R410, R465, and R455) ⓘ

a. Adjust the 7503 Indicator Oscilloscope Intensity, Focus, and Graticule Illum controls for a well defined and focused display (trace) on the CRT (Indicator Oscilloscope Cathode Ray Tube).

b. From the Type 191 Constant Amplitude Signal Generator (set for 50 kHz), connect a GR to BNC Female adapter, BNC-T adapter and two BNC 50 ohm coaxial cables; connect one cable to the 7A16 Input connector and the other to the 7B52 MAIN TRIG IN connector.

NOTE

With equipment connected as above, all amplitude settings of the Type 191 Amplitude control must be measured on the CRT.

c. CHECK—Using the 7A16 Position control, position the trace to CRT center; sweep must free-run in AUTO mode (indicated by trace).

d. Press the 7A16 AC switch and the 7B52 MAIN TRIGGERING NORM switch.

e. CHECK—CRT for no display and TRIG'D lamp out.

NOTE

If part e is incorrect, set R465 and R455 to midrange. Complete all checks and adjustments listed in this step.

f. Rotate the 7B52 LEVEL/SLOPE control (towards 0/+) for a triggered display.

g. Set the Type 191 for an amplitude as measured on the CRT of 0.3 division, and rotate the 7A16 Position control to center this 0.3 division display about the graticule center horizontal line.

h. Note the position of the sweep trigger point (start of display) with respect to CRT center.

- i. Press the 7B52 MAIN TRIGGERING DC switch.
- j. CHECK—CRT for a triggered display with the position of the sweep trigger the same as noted in part h.
- k. ADJUST—R350, located on Main Trig board, for a triggered display with position of sweep trigger point the same as noted in part h.
- l. Repeat the above adjustment as necessary until the position of sweep trigger point remains the same in either AC or DC.
- m. Press the MAIN TRIGGERING DC switch. Repeat parts f, g, and h.
- n. Press the MAIN TRIGGERING EXT switch.
- o. CHECK—CRT for triggered display with position of sweep trigger the same as noted in part h.
- p. ADJUST—R330 for a triggered display with position of sweep trigger point the same as noted in part h.
- q. Repeat the above adjustment as necessary until the position of sweep trigger point remains the same in either INT or EXT.
- r. Press the 7B52 MAIN TRIGGERING AUTO, AC, and INT switches. Set the LEVEL/SLOPE control to 0/+.
- s. Repeat parts g and h.
- t. CHECK—CRT display should trigger (sweep starts) at CRT center.
- u. ADJUST—R410 to trigger the display at CRT center.
- v. Rotate the LEVEL/SLOPE control to 0/—.
- w. CHECK—CRT display should trigger (sweep starts) at CRT center.
- x. Repeat the adjustment in part u as necessary until sweep triggering occurs at CRT center with the LEVEL/SLOPE control set to 0/+ and/or 0/—.

NOTE

If sweep triggering cannot be set to CRT center at both 0/+ and 0/— settings of the LEVEL/SLOPE control, adjustment may be made so that triggering occurs at points equally above (0/+) and below (0/—) CRT center. In no case should sweep triggering occur more than one minor division above CRT center when in 0/+, nor more than one minor division below in 0/—.

y. Rotate the LEVEL/SLOPE control midrange between 0/+ and 0/—.

z. CHECK—CRT for free-running display.

aa. Press the MAIN TRIGGERING NORM switch.

ab. CHECK—CRT for no display.

ac. ADJUST—R455 to a point where the sweep free-runs in AUTO mode, and stops running in NORM. Rotate the control about 10° clockwise past this point.

ad. Press the MAIN TRIGGERING AUTO switch, set the frequency of the Type 191 to 100 MHz, and adjust the amplitude control for a display amplitude of 1.5 divisions on the CRT.

ae. Set the 7B52 TIME/DIV or DL'Y TIME to .1 μ s, DLY'D SWEEP to .05 μ s, and release the X10 MAG switch. Rotate the LEVEL/SLOPE control for a triggered display.

af. CHECK—CRT display should be triggered and TRIG'D lamp must be on. There must be no defocusing of the sine-wave peaks.

NOTE

Defocusing of sine-wave peaks indicates that a slight adjustment of R465 may be necessary. Defocusing of sine-wave slopes is the result of trigger jitter (if any) and should be disregarded at this time.

ag. Observing the CRT display, slowly rotate the frequency control of the Type 191 toward 42 MHz.

ah. CHECK—CRT display for no double triggering of the display or free-running of the display as the frequency of the Type 191 is decreased from 100 MHz towards 42 MHz.

Performance Check/Calibration—7B52

ai. (Calibration Procedure Only) Rotate the frequency control of the Type 191 to 100 MHz, then slowly towards 42 MHz until the first double triggering or free-running display occurs.

aj. ADJUST—R465 for a single triggered display with little or no defocusing of the sine-wave peaks.

NOTE

The adjustment of R465 may interact with the adjustment of R455 (see part ac). Press the MAIN TRIGGERING NORM switch, lock in the X10 MAG switch and repeat parts y through aj.

2. Adjust DLY'D TRIGGERING (R550, R630, R618, R865, and R665) ①

a. Set the 7A16 and 7B52 controls and switches as given preceding Step 1.

b. Disconnect the 50 ohm coaxial cable from the MAIN TRIG IN connector and reconnect it to the DLY'D TRIG IN connector.

c. Set the Type 191 to 50 kHz.

d. Press the 7A16 AC switch, adjust the Type 191 for 0.3 division CRT display; rotate the LEVEL/SLOPE control for a triggered display.

e. Press the 7B52 DISPLAY MODE INTEN switch.

f. CHECK—Observing the CRT display, rotate the DLY'D LEVEL control for an intensified sweep (Dly'd Sweep triggered).

NOTE

If part f is incorrect, adjust R865 for an intensified trace and set R665 to midrange. Complete all checks and adjustments listed in this step.

g. Note position of Dly'd Sweep trigger point (start of intensified display) with respect to CRT Vertical center.

NOTE

For better viewing of the intensified sweep, reduce the oscilloscope intensity control. Another method is to press the DISPLAY MODE DLY'D SWP switch and view only the Dly'd Sweep (intensified display).

h. Release the DLY'D COUPLING AC/DC (DC) switch.

i. CHECK—CRT intensified sweep should be triggered with position of sweep trigger point the same as noted in part g.

j. ADJUST—R550 for triggered display with position of trigger point as noted in part g.

k. Repeat the adjustment as necessary until the Dly'd Sweep trigger point as noted in part g is the same for either position of the DLY'D COUPLING AC or DC switch. Return the COUPLING switch to DC.

l. Release the DLY'D SOURCE INT/EXT (EXT) switch.

m. CHECK—CRT display; intensified sweep should be triggered with the position of the trigger point the same as noted in part g.

n. ADJUST—R630 for triggered display with the position of the trigger point the same as noted in part g.

o. Repeat the adjustment as necessary until the trigger point as noted in part g is the same for either position of the DLY'D SOURCE INT or EXT switch position. Return the SOURCE switch to INT.

p. Check or set the DLY'D TRIGGERING switches to +, AC, and INT.

q. Release the MAIN TRIGGERING INT switch (the CRT display will free run with no buttons depressed), adjust the Type 191 for 0.3 division on the CRT and rotate the 7A16 Position control to center the display above and below CRT center. Set the 7B52 DLY'D LEVEL control to midrange. Press the MAIN TRIGGERING INT switch.

r. CHECK—CRT for triggered display, and note position of sweep trigger point with respect to CRT center.

s. ADJUST—R618 for a triggered display with the sweep trigger point at or near CRT center.

t. Release the DLY'D SLOPE (–) switch.

u. CHECK—CRT for triggered display, with the position of the sweep trigger point at CRT center, below CRT center by the same amount the trigger point was above CRT center in part r.

v. Release the MAIN TRIGGERING INT switch (CRT display will free run with no buttons depressed), set the Type 191 to 100 MHz and adjust the amplitude for 1.5 divisions on the CRT. Set the TIME/DIV or DL'Y TIME switch to .1 μ s, DLY'D SWEEP switch to .05 μ s, and release the X10 MAG switch.

w. Press the MAIN TRIGGERING INT switch, the DISPLAY MODE MAIN SWP switch and rotate the LEVEL/SLOPE control for a triggered display.

x. Press the DISPLAY MODE INTEN switch and rotate the DLY'D LEVEL control for a triggered display.

y. CHECK—CRT display should be triggered. There should be no defocused peaks of the displayed sinewave.

NOTE

Defocus of sine-wave peaks indicates that slight adjustment of R865 may be necessary. Defocus of sine-wave slope(s) is the result of trigger jitter.

z. Observing the CRT display, slowly rotate the frequency control of the Type 191 towards 42 MHz.

aa. CHECK—CRT for no double triggering, or free running display as the frequency is decreased towards 42 MHz.

ab. (Calibration Procedure Only) Rotate the frequency control of the Type 191 to 100 MHz. Then, decrease it until the first double triggering or free running display occurs.

ac. ADJUST—R655 for triggered display.

ad. Rotate the DLY'D LEVEL control to either extreme of rotation.

ae. CHECK—CRT for no display.

af. ADJUST—R865 for no display with the LEVEL control at either extreme of rotation.

NOTE

The adjustments of R865 and R655 may interact. Repeat the above checks and adjustments as necessary until all requirements are met.

3. Check Level Control Ranges

a. Set the 7B52 TIME/DIV or DL'Y TIME to 20 μ s, DLY'D SWEEP to 10 μ s, X10 MAG switch in (off) and the DISPLAY MODE to DLY'D SWP.

b. Set the Type 191 to 50 kHz and adjust the output amplitude control for an 8 division display on the CRT.

c. CHECK—Rotate the DLY'D LEVEL control and check that all levels of the display may be selected as the sweep trigger point. Check for no display with the LEVEL control at either end of rotation.

d. Repeat part c with all possible combinations of the DLY'D SLOPE, COUPLING, and SOURCE switches.

e. Press the DISPLAY MODE MAIN SWP switch.

f. CHECK—Rotate the LEVEL/SLOPE control and check that all levels of the display may be selected as the sweep trigger point, and that the slope corresponds to the markings on the 7B52 front-panel.

g. Repeat part f with all possible combinations of the MAIN TRIGGERING COUPLING (AC or DC only) and SOURCE (INT or EXT only) switches.

h. Disconnect all test equipment and connections.

4. (Calibration Procedure Only) Adjust Ext Compensation (C501, C301, and C10)

a. Set the 7A16 and 7B52 controls and switches as given preceding Step 1 with the following exceptions:

7A16 AC-GND-DC switch to DC and Volts/Div switch to .1 V.

7B52 MAIN TRIGGERING COUPLING switch to DC; LEVEL/SLOPE control to 0/+; TIME/DIV or DL'Y TIME switch to 1 ms; DLY'D SWEEP switch .5 ms; DLY'D COUPLING switch to DC; and the DLY'D SOURCE switch to EXT.

b. Connect a 1 kHz square wave from the Type 106 Hi-Amplitude output via a GR to BNC Female adapter, 50 ohm coaxial cable, 10X attenuator, 50 ohm feed-thru-line termination and a 20 pF Normalizer to the 7A16 Input connector.

Performance Check/Calibration—7B52

c. Adjust the Type 106 amplitude control for a 5 div display of 1 kHz squarewave on the CRT.

d. Disconnect the 20 pF Normalizer from the 7A16 Input connector and reconnect it to the 7B52 DLY'D TRIG IN connector. Connect a properly compensated 10X probe from the 7A16 Input connector to TP516; set the 7A16 Volts/Div switch to 5 mV.

e. Press the DISPLAY MODE DLY'D SWP switch and rotate the DLY'D LEVEL control for a triggered display.

f. ADJUST—C501 for the best square corner on the leading edge of the square wave.

g. Disconnect the 10X probe from TP516 and connect it to TP316.

h. Press the MAIN TRIGGERING EXT switch, DISPLAY MODE MAIN SWP switch, and connect the 20 pF Normalizer to the MAIN TRIG IN connector.

i. ADJUST—C301 for the best square corner on the leading edge of the square wave.

j. Disconnect the 10X attenuator; press the MAIN TRIGGERING EXT ÷10 switch.

k. ADJUST—C10 for the best square corner on the leading edge of the square wave.

l. Disconnect the 20 pF Normalizer, 50 ohm termination, coaxial cable, GR to BNC Female adapter and the Type 106. Disconnect the 10X probe from TP316 and the 7A16 Input connector.

5. Check Trigger Bandwidth

a. (Calibration Procedure Only) Disconnect the 7B52 from the 067-0589-00 Plug-In Extender and the Extender from the Indicator Oscilloscope. Then, install the 7B52 into the right compartment of the oscilloscope. Change the 7A16 from the left compartment of the indicator oscilloscope and install it in the center compartment.

b. Set the 7A16 and 7B52 controls and switches as given preceding Step 1 with the following exceptions:

7A16 AC-GND-DC switch to AC.

7B52 TIME/DIV or DL'Y TIME switch to 10 ms and DLY'D SWEEP switch to 5 ms.

c. Connect a 30 Hz sine-wave from a low frequency generator via a 50 ohm coaxial cable and a Dual Input Cable to the 7A16 Input and 7B52 MAIN TRIG IN connectors. Set the amplitude control for a 0.3 division CRT display.

d. Rotate the LEVEL/SLOPE control for a triggered display.

e. CHECK—TRIG'D lamp is on.

f. Using Table 5-1 as a guide, check all conditions listed. Use the 7B52 TIME/DIV switch as necessary for optimum viewing of the display.

NOTE

When checking Dly'd Trigger bandwidth, change the input cable to the DLY'D TRIG IN connector and keep the DLY'D SWEEP switch one position faster than the TIME/DIV or DL'Y TIME switch setting. Use the DLY'D LEVEL control and DLY'D SWP.

g. Disconnect the low frequency sine-wave generator.

h. From the Type 191 Constant Amplitude Signal Generator, connect a GR to BNC Female adapter and the 50 ohm cable disconnected in part g.

i. Set the frequency of the Type 191 to 10 MHz and adjust the amplitude control for a 0.3 division CRT display.

j. CHECK—Using the control settings given in Table 5-2, check for stable triggering, and check that the TRIG'D lamp is on as listed. Note that the amplitude has been increased at 100 MHz.

6. Check Trigger Jitter

a. Set the Type 191 to 75 MHz and check that the CRT amplitude is 1.5 Div.

b. Press the 7B52 MAIN TRIGGERING AUTO, AC and EXT switches and check that DLY'D Triggering is in AC and EXT.

TABLE 5-1

7B52				Low Frequency Gen		Stable Triggering	TRIG'D Lamp on
Main Sweep		Dly'd Sweep		Frequency	Amplitude		
Coupling	Source	Coupling	Source				
AC	Int	AC	Int	30 Hz	0.3 Div	Yes	Yes
AC	Ext	AC	Ext	30 Hz	150 mV	Yes	Yes
AC LF REJ	Ext	---	---	30 Hz	150 mV	No	No
AC LF REJ	Int	---	---	30 Hz	0.3 Div	No	No
AC HF REJ	Int	---	---	30 Hz	0.3 Div	Yes	Yes
AC HF REJ	Ext	---	---	30 Hz	150 mV	Yes	Yes
DC	Ext	DC	Ext	30 Hz	150 mV	Yes	Yes
DC	Int	DC	Int	30 Hz	0.3 Div	Yes	Yes
AC LF REJ	Int	---	---	30 kHz	0.3 Div	Yes	Yes
AC HF REJ	Int	---	---	50 kHz	0.3 Div	Yes	Yes
AC HF REJ	Ext	---	---	50 kHz	150 mV	Yes	Yes
AC LF REJ	Ext	---	---	150 kHz	150 mV	Yes	Yes
AC LF REJ	Ext	---	---	120 Hz	(No Trigger with 1.5 V)		

TABLE 5-2

7B52				Type 191		Stable Triggering	TRIG'D Lamp on
Main Sweep		Dly'd Sweep		Frequency	Amplitude		
Coupling	Source	Coupling	Source				
DC	Ext	DC	Ext	10 MHz	150 mV	Yes	Yes
DC	Int	DC	Int	10 MHz	0.3 Div	Yes	Yes
AC LF REJ	Int	---	---	10 MHz	0.3 Div	Yes	Yes
AC LF REJ	Ext	---	---	10 MHz	150 mV	Yes	Yes
AC	Ext	AC	Ext	10 MHz	150 mV	Yes	Yes
AC	Int	AC	Int	10 MHz	0.3 Div	Yes	Yes
AC	Int	AC	Int	100 MHz	1.5 Div	Yes	Yes
AC	Ext	AC	Ext	100 MHz	750 mV	Yes	Yes
AC LF REJ	Ext	---	---	100 MHz	750 mV	Yes	Yes
AC LF REJ	Ext	---	---	100 MHz	1.5 Div	Yes	Yes
DC	Int	DC	Int	100 MHz	1.5 Div	Yes	Yes
DC	Ext	DC	Ext	100 MHz	750 mV	Yes	Yes

c. Set the 7B52 TIME/DIV or DL'Y TIME switch to .05 μ s and release the X10 MAG switch.

d. Rotate the LEVEL/SLOPE control or DLY'D LEVEL control (depending upon connection to EXT TRIG IN connectors, and which DISPLAY MODE switch is pressed) for a triggered display.

e. CHECK—CRT display for no more than 0.2 div (1 ns) of jitter. Disregard any slow drift.

f. Change the Dual Input Cable to the other EXT TRIG IN connector and press the corresponding DISPLAY MODE switch.

g. Repeat parts d and e.

7. Check Trigger Modes

a. Press the 7B52 MAIN TRIGGERING INT switch and the DISPLAY MODE MAIN SWP switch.

b. Set the Type 191 to 50 MHz and adjust the amplitude for a 4 div display on the CRT.

c. CHECK—For proper triggering with the LEVEL/SLOPE control at 0/+ and 0/-. Check for a free running display with the LEVEL/SLOPE control near the top and near the bottom.

Performance Check/Calibration—7B52

- d. Press the 7B52 MAIN TRIGGERING NORM switch.
- e. CHECK—For proper triggering with the LEVEL/SLOPE control at 0/+ and 0/-. Check for no trace with the LEVEL/SLOPE control near the top and near the bottom.
- f. Set the 7B52 TIME/DIV or DL'Y TIME switch to 10 μ s and lock the X10 MAG switch in. Set the Type 191 to 50 kHz and adjust the amplitude for a four division display. Adjust the 7B52 LEVEL/SLOPE control for a stable display.
- g. Press the 7B52 MAIN TRIGGERING SINGLE SWP switch.
- h. CHECK—CRT for no display.
- i. Press the 7B52 RESET switch.
- j. CHECK—CRT for one sweep as the RESET switch is pressed.
- k. Remove the signal from the 7A16 Input connector. Then, press the 7B52 RESET switch.
- l. CHECK—CRT for no display and READY light on.
- m. Reconnect the signal to the 7A16 Input connector.
- n. CHECK—CRT for one sweep as the signal is applied to the 7A16.
- o. CHECK—READY light is out after the completion of one sweep.
- p. Disconnect all test equipment and connections.

8. Check/Adjust SWP CAL (R60) ①

- a. (Calibration Procedure Only) Remove the 7B52 and the 7A16 from the Indicator Oscilloscope. Then, install the 7A16 into the left vertical compartment and the 067-0589-00 Plug-in Extender into the horizontal compartment. Connect the 7B52 to the Extender.
- b. Set the 7A16 and 7B52 controls and switches as given preceding Step 1 with the following exceptions:

7A16 AC-GND-DC switch to DC.

7B52 TIME/DIV or DL'Y TIME and DLY'D SWEEP switches to 1 ms, DLY'D LEVEL switch locked in, and the LEVEL/SLOPE control at 0/+.

c. Apply 1 ms markers from the 2901 Time-Mark Generator via a 50 ohm coaxial cable and a 50 ohm termination to the 7A16 Input connector.

d. CHECK—CRT display for one 1 ms marker each major division between the first and ninth divisions; see Fig. 5-2.

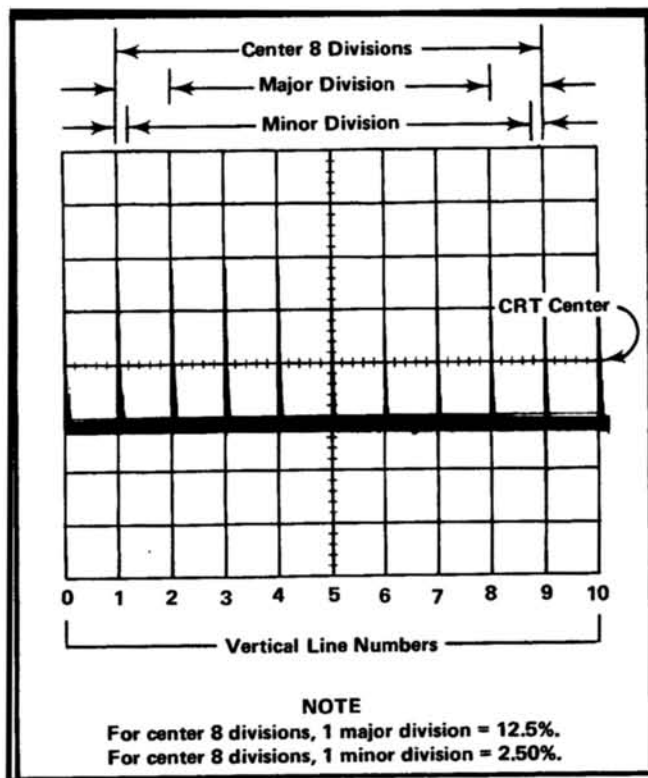

Fig. 5-2. Typical CRT display showing correct sweep calibration. Also, various terms used in this procedure with regard to the graticule.

NOTE

Unless otherwise noted, use the center eight divisions when checking or adjusting timing.

e. (Performance Check and Calibration procedure) ADJUST—SWP CAL control, R60 (located on the 7B52 front-panel), for one 1 ms marker each major division. Use the POSITION control as necessary to align the display with the vertical lines.

f. CHECK—Timing accuracy is within 5% (2 minor divisions) over any two major divisions within the center eight divisions.

9. Check/Adjust Mag Swp Gain (R1055) ①

- a. Set the 2901 for .1 ms markers.
- b. Release the 7B52 X10 MAG switch.
- c. CHECK—CRT display for one .1 ms marker for each major division between the first and ninth divisions.
- d. ADJUST—Mag Gain control, R1055, for one .1 ms marker for each division. Use the POSITION control as necessary to align the display.
- e. CHECK—Timing accuracy is within 5% (2 minor divisions) over any two major divisions within the center eight divisions.
- f. INTERACTION—Step 10 must be checked.

10. Check Mag Registration

- a. Set the 7B52 TIME/DIV or DL'Y TIME switch to .1 ms and the 2901 for .5 ms markers.
- b. Observing the CRT display, rotate the POSITION control to align the display as shown in Fig. 5-3a. (Center the second .5 ms marker on the fifth vertical line.)

NOTE

Do not move the POSITION control until the completion of part d.

- c. Without disturbing the setting of the POSITION control, lock the X10 MAG switch in.
- d. CHECK—Position of second .5 ms marker must be within 0.5 major division of the fifth vertical line; see Fig. 5-3b.

11. Check/Adjust Main and Dly'd Sweep Length (R835 and R930) ①

- a. Set the 7B52 TIME/DIV or DL'Y TIME switch to 1 ms.

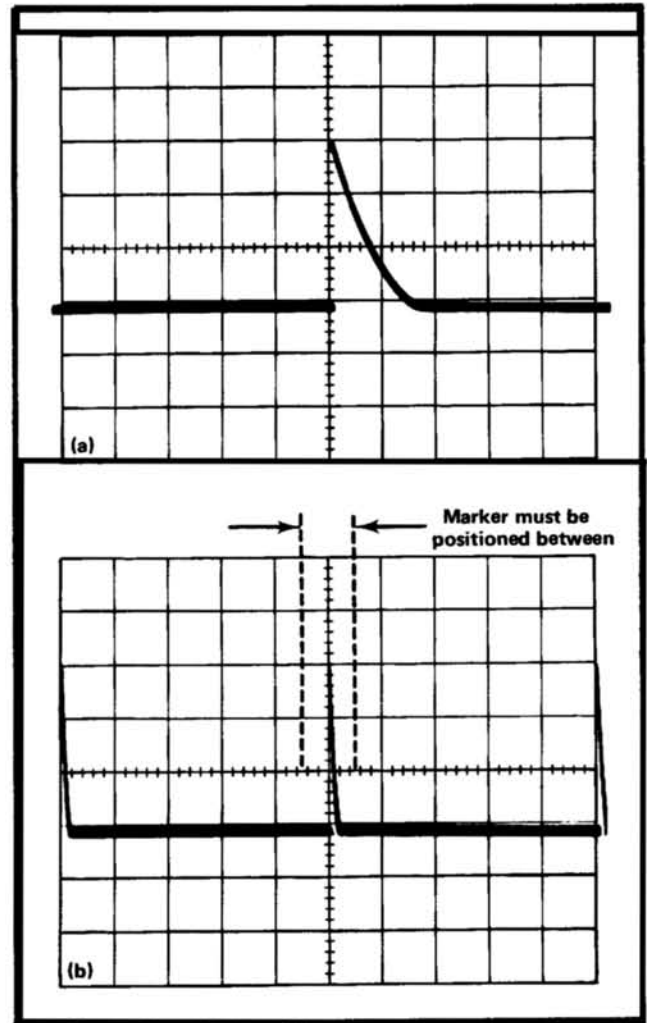

Fig. 5-3. Typical CRT display showing Mag Registration. (a) X10 MAG (b) Normal

- b. Set the 2901 for .1 and 1 ms markers.
- c. Rotate the LEVEL/SLOPE control for a triggered display. Then, rotate the POSITION control to position the eleventh 1 ms marker on the fifth vertical line.
- d. CHECK—CRT display sweep length for 10.4 divisions within 0.3 division; see Fig. 5-4. (There should be between one and seven .1 ms markers past the eleventh 1 ms marker.)
- e. ADJUST—Main Swp Length control, R835, for four .1 ms markers past the eleventh 1 ms marker.

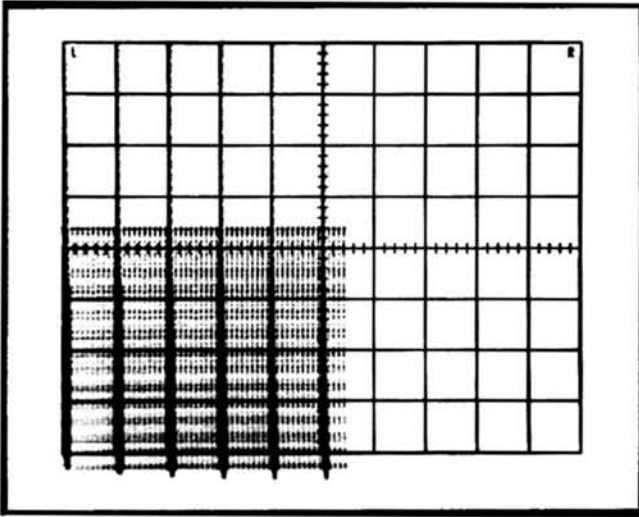

Fig. 5-4. Typical CRT display when checking sweep length.

- f. Rotate the TIME/DIV switch through all positions.
 - g. CHECK—CRT display for a sweep length of 10 to 13 divisions at each setting of the TIME/DIV switch. Return the TIME/DIV switch to 1 ms.
 - h. Set the 7B52 DLY'D SWEEP switch to .1 ms and press the DLY'D SWP switch.
 - i. Set the 2901 for .1 ms and 10 μ s markers.
 - j. Rotate the LEVEL/SLOPE control for a triggered display. Then, rotate the POSITION control to position the eleventh .1 ms marker on the fifth vertical line.
 - k. CHECK—CRT display sweep length for 10.4 divisions within 0.3 division. (There should be between one and seven 10 μ s markers past the eleventh .1 ms marker.)
 - l. ADJUST—Dly'd Swp Length control, R930, for four 10 μ s markers past the eleventh .1 ms marker.
 - m. Rotate the DLY'D SWEEP switch through all positions.
 - n. CHECK—CRT display for a sweep length of 10 to 13 divisions at each setting of the DLY'D SWEEP switch.
- 12. Check Position Range**
- a. Return the DLY'D SWEEP switch to 1 ms, press the MAIN SWP switch, set the 2901 for 1 ms markers and rotate the LEVEL/SLOPE control for a triggered display.
 - b. Rotate the POSITION control fully clockwise.
 - c. CHECK—CRT display must start to right of the fifth vertical line.
 - d. Rotate the POSITION control fully counterclockwise.
 - e. CHECK—CRT display must end to the left of the fifth vertical line.
- 13. Check Variable Sweep Range**
- a. Set the 2901 for 10 ms markers.
 - b. Set the 7B52 TIME/DIV switch to 2 ms. Then, rotate the LEVEL/SLOPE control for a triggered display and the POSITION control to center the display on the CRT.
 - c. Release the MAIN VARIABLE control and rotate it fully counterclockwise.
 - d. CHECK—CRT display for no more than 2 major divisions between the 10 ms markers. (This indicates adequate range of continuously variable sweep between calibrated steps.)
- 14. Check/Adjust Sweep HF Timing (C778 and C956)**
- a. Set the 2901 for 1 μ s markers.
 - b. Set the 7B52 TIME/DIV or DL'Y TIME and DLY'D SWEEP switches to 1 μ s. Lock the MAIN VARIABLE switch in and rotate the LEVEL/SLOPE control for a triggered display.
 - c. Observing the CRT display, rotate the POSITION control to align the second 1 μ s marker with the first vertical line and the tenth 1 μ s marker with the ninth vertical line.
 - d. CHECK—CRT display for one 1 μ s marker each major division within 2% (0.8 minor division).
 - e. ADJUST—Main Swp HF Timing control, C778, for one 1 μ s marker each vertical line. Use the POSITION control as necessary to align the display.
 - f. CHECK—Timing accuracy is within 5% (2 minor divisions) over any two major division interval within the center eight divisions.

g. Press the DLY'D SWP switch and reposition the display as in part c.

h. CHECK—CRT display for one 1 μ s marker each major division within 3% (1.2 minor divisions).

i. ADJUST—Dly'd Swp HF Timing control, C956, for one 1 μ s marker each major division. Use the POSITION control as necessary to align the display.

j. CHECK—Timing accuracy is within 6% (2.4 minor divisions) over any two major division interval within the center eight divisions.

k. Set the 2901 for .1 μ s markers.

l. Release the 7B52 X10 MAG switch.

m. CHECK—CRT display for one .1 μ s marker each major division within 3.5% (1.4 minor divisions).

n. CHECK—Timing accuracy is within 6% (2.4 minor divisions) over any two major division interval within the center eight divisions.

o. Press the MAIN SWP switch.

p. CHECK—CRT display for one .1 μ s marker each major division within 2.5% (1 minor division).

q. CHECK—Timing accuracy is within 5% (2 minor divisions) over any two major division interval within the center eight divisions.

15. Check Mag Swp Timing Accuracy

a. Using Table 5-3 as a guide, check that magnified timing accuracy over the center eight division is within the listed tolerance.

TABLE 5-3

7B52		2901 Markers	CRT Display Markers (or cycle)/Div	Tolerance (minor divisions)	
TIME/DIV or DL'Y TIME	DLY'D SWEEP			MAIN SWP	DLY'D SWP
5 s	----	.5 s	1	± 1.6	----
2 s	----	.1 s	2	± 1.6	----
1 s	----	.1 s	1	± 1.6	----
.5 s	.5 s	50 ms	1	± 1.0	± 1.8
.2 s	.2 s	10 ms	2	± 1.0	± 1.8
.1 s	.1 s	10 ms	1	± 1.0	± 1.8
50 ms	50 ms	5 ms	1	± 1.0	± 1.4
20 ms	20 ms	1 ms	2	± 1.0	± 1.4
10 ms	10 ms	1 ms	1	± 1.0	± 1.4
5 ms	5 ms	.5 ms	1	± 1.0	± 1.4
2 ms	2 ms	.1 ms	2	± 1.0	± 1.4
1 ms	1 ms	.1 ms	1	± 1.0	± 1.4
.5 ms	.5 ms	50 μ s	1	± 1.0	± 1.4
.2 ms	.2 ms	10 μ s	2	± 1.0	± 1.4
.1 ms	.1 ms	10 μ s	1	± 1.0	± 1.4
50 μ s	50 μ s	5 μ s	1	± 1.0	± 1.4
20 μ s	20 μ s	1 μ s	2	± 1.0	± 1.4
10 μ s	10 μ s	1 μ s	1	± 1.0	± 1.4
5 μ s	5 μ s	.5 μ s	1	± 1.0	± 1.4
2 μ s	2 μ s	.1 μ s	2	± 1.0	± 1.4
1 μ s	1 μ s	.1 μ s	1	± 1.0	± 1.4
.5 μ s	.5 μ s	50 ns	1 (cycle)	± 1.0	± 1.4
.2 μ s	.2 μ s	20 ns	1 (cycle)	± 1.6	± 1.8
.1 μ s	.1 μ s	10 ns	1 (cycle)	± 1.6	± 1.8
.05 μ s	.05 μ s	10 ns	1/2 (cycle)	± 1.6	± 1.8

Use the single sweep mode for 5, 2 and 1 second rates.

16. Check Sweep Timing Accuracy

- a. Lock in the 7B52 X10 MAG switch.
- b. Using Table 5-4 as a guide check that the sweep timing accuracy over the center eight divisions of the display are within the listed tolerance.
- c. Disconnect the 50 Ω termination and coaxial cable from the 7A16 Input.

7B52 TIME/DIV or DL'Y TIME, and DLY'D SWEEP switches to 1 ms; press the MAIN TRIGGERING AC switch and lock in the DLY'D LEVEL controls.

- b. Observing the CRT display, rotate the 7A16 Position control to position the display to CRT center (0 volts ground) and the 7B52 POSITION control to start the display on the fifth vertical line.

- c. Press the DLY'D SWP switch.

- d. CHECK—CRT trace must start at the fifth vertical line within one division. (Typically less except for highest sweep rates.)

NOTE

For Performance Check, proceed to step 18.

17. Check/Adjust Sweep Offset (R730 and R935)

- a. Set the 7A16 and 7B52 controls and switches as given preceding Step I with the following exceptions:

7A16 Volts/Div switch to 5 mV.

TABLE 5-4

7B52		2901 Markers	CRT Display Markers/Div	Tolerance (minor divisions)	
TIME/DIV or DL'Y TIME	DLY'D SWEEP			MAIN SWP	DLY'D SWP
.05 μs	.05 μs	.1 μs	1/2	±1.2	±1.6
.1 μs	.1 μs	.1 μs	1	±1.2	±1.6
.2 μs	.2 μs	.1 μs	2	±1.2	±1.6
.5 μs	.5 μs	.5 μs	1	±0.8	±1.2
1 μs	1 μs	1 μs	1	±0.8	±1.2
2 μs	2 μs	1 μs	2	±0.8	±1.2
5 μs	5 μs	5 μs	1	±0.8	±1.2
10 μs	10 μs	10 μs	1	±0.8	±1.2
20 μs	20 μs	10 μs	2	±0.8	±1.2
50 μs	50 μs	50 μs	1	±0.8	±1.2
.1 ms	.1 ms	.1 ms	1	±0.8	±1.2
.2 ms	.2 ms	.1 ms	2	±0.8	±1.2
.5 ms	.5 ms	.5 ms	1	±0.8	±1.2
1 ms	1 ms	1 ms	1	±0.8	±1.2
2 ms	2 ms	1 ms	2	±0.8	±1.2
5 ms	5 ms	5 ms	1	±0.8	±1.2
10 ms	10 ms	10 ms	1	±0.8	±1.2
20 ms	20 ms	10 ms	2	±0.8	±1.2
50 ms	50 ms	50 ms	1	±0.8	±1.2
.1 s	.1 s	.1 s	1	±0.8	±1.6
.2 s	.2 s	.1 s	2	±0.8	±1.6
.5 s	.5 s	.5 s	1	±0.8	±1.6
1 s	----	1 s	1	±1.2	----
2 s	----	1 s	2	±1.2	----
5 s	----	5 s	1	±1.2	----

Use the single sweep mode for 1, 2 and 5 second rates.

- e. Connect a 10X probe from the 7A16 Input to TP779.
- f. Press the MAIN SWP switch and the 7A16 DC coupling switch.
- g. ADJUST—Main Offset Zero control, R730, to start the display at CRT center (0 volts ground, reference established in part b).
- h. Disconnect the 10X probe from TP779 and reconnect it to TP995.
- i. Press the DLY'D SWP switch.
- j. ADJUST—Dly'd Offset Zero control, R935, to start the display at CRT center (0 volts ground, reference established in part b).
- k. Disconnect the 10X probe from TP995 and the 7A16 Input; press the MAIN SWP switch; press the 7A16 GND coupling switch.
- l. Repeat parts b, c, and d.

18. Check/Adjust Dly'd Start and Dly'd Stop (R755 and R750) ①

- a. Connect the 2901, set for 1 ms markers, to the 7A16 Input (DC coupled at .5 V/Div) via a 50 ohm coaxial cable and a 50 ohm termination.
- b. Press the 7B52 INTEN switch and rotate the LEVEL/SLOPE control for a triggered display.
- c. Observing the CRT display, rotate the DELAY TIME MULT control to 1-00.
- d. CHECK—CRT intensified sweep should start on the second 1 ms marker.
- e. ADJUST—Dly'd Start control, R755, to start the intensified sweep on the second 1 ms marker.
- f. Observing the CRT display, rotate the DELAY TIME MULT control to 9-00.
- g. CHECK—CRT intensified sweep should start on the tenth 1 ms marker.

- h. ADJUST—Dly'd Stop control, R750, to start the intensified sweep on the tenth 1 ms marker.
- i. Set the 2901 for .1 and 1 ms markers.
- j. Set the 7B52 DLY'D SWEEP switch to 10 μ s, the DELAY TIME MULT control to 1-00 and press the DLY'D SWP switch.
- k. CHECK—CRT display should be as shown in Fig. 5-5a within 1%. Use the POSITION control to position the display to the fifth vertical line.

NOTE

Fig. 5-5b and c show maximum error.

- l. ADJUST—Dly'd Start control, R755, for a display as shown in Fig. 5-5a.
- m. Press the INTENS switch and rotate the DELAY TIME MULT control to set the intensified trace on the tenth 1 ms marker.
- n. Press the DLY'D SWP switch.
- o. CHECK—CRT display should be as shown in Fig. 5-5a within 1%, except the DELAY TIME MULT control will be at 9-00.

- p. ADJUST—Dly'd Stop control, R750, for a display as shown in Fig. 5-5a.

19. Check Delay Time Multiplier Accuracy

- a. Set the 7B52 DELAY TIME MULT control near 8-00 so the ninth marker begins at the start of the delayed sweep. (Use INTEN mode to locate marker.)
- b. CHECK—The DELAY TIME MULT control deviation from 8-00 is within 0.2% (2 minor division of the inner DELAY TIME MULT dial).

- c. Repeat this check at each major dial division of the DELAY TIME MULT control between 1-00 and 9-00.

20. Check Delay Time Accuracy

- a. Set the 7B52 DELAY TIME MULT control near 1-00.

DELAY TIME MULT Control Setting

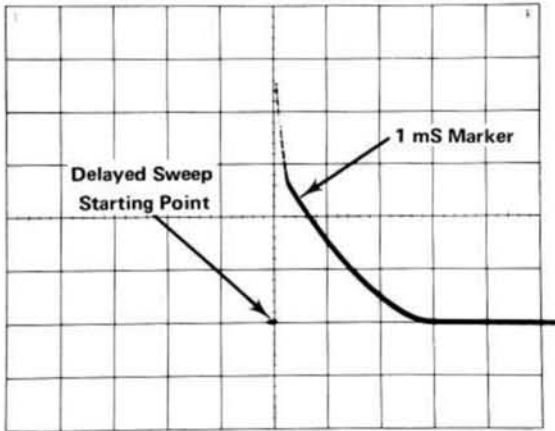

(a)

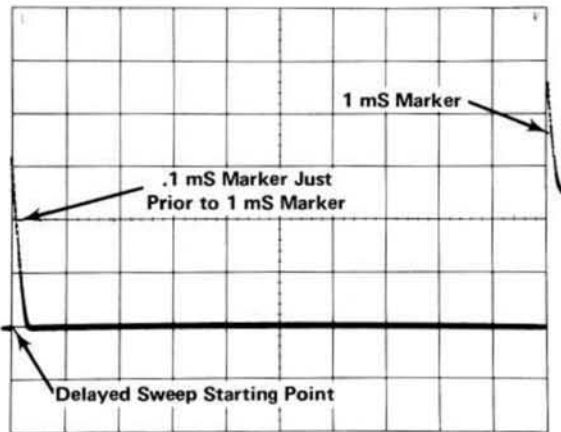
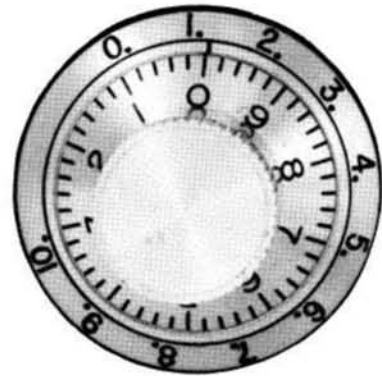

(b)

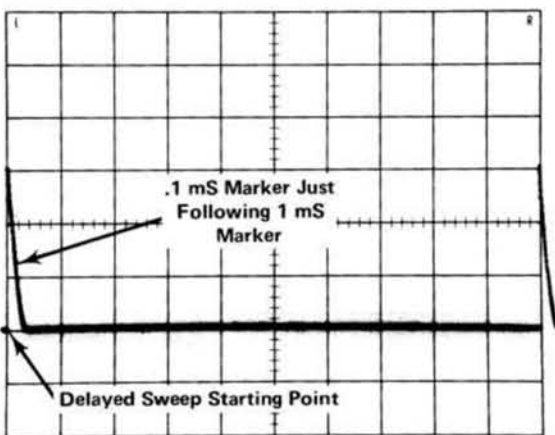
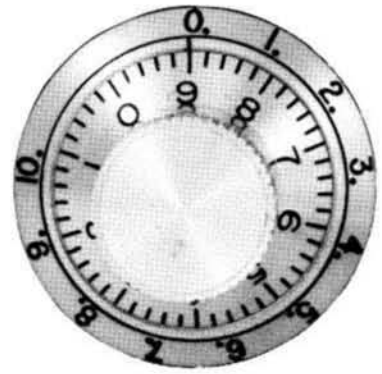

(c)

Inner Numbers Represent 1% each

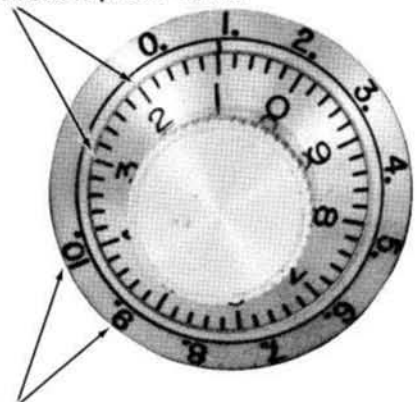

Outer Numbers Represent 10% each

Fig. 5-5. Typical CRT display obtained in DLY'D SWP (a) delayed sweep adjusted (b) delayed sweep 1% slow and (c) delayed sweep 1% fast.

TABLE 5-5

7B52		2901 Markers	Allowable Error
TIME/DIV or DL'Y TIME	DLY'D SWEEP		
1 μ s	.1 μ s	1 μ s	0.8 div
2 μ s	.1 μ s	1 μ s	0.8 div
5 μ s	.5 μ s	5 μ s	0.8 div
10 μ s	1 μ s	10 μ s	0.8 div
20 μ s	1 μ s	10 μ s	0.8 div
50 μ s	5 μ s	50 μ s	0.8 div
.1 ms	10 μ s	.1 ms	0.8 div
.2 ms	10 μ s	.1 ms	0.8 div
.5 ms	50 μ s	.5 ms	0.8 div
10 ms	1 ms	10 ms	0.8 div
20 ms	1 ms	10 ms	0.8 div
50 ms	5 ms	50 ms	0.8 div
.1 s	10 ms	.1 s	0.8 div
.2 s	10 ms	.1 s	0.8 div
.5 s	50 ms	.5 s	0.8 div
1 s	.1 s	1 s	1.6 div
2 s	.1 s	1 s	1.6 div
5 s	.5 s	5 s	1.6 div

b. CHECK—Using the settings given in Table 5-5, check that the delay time accuracy is within the given tolerance. First set the DELAY TIME MULT control near 1-00. Adjust the DELAY TIME MULT control until the second marker starts at the beginning of the delayed (B) sweep; note the deviation from 1-00. Next, set the DELAY TIME MULT control near 9-00 and adjust until the tenth marker starts at the beginning of the delayed sweep; note the deviation from 9-00. Subtract the first reading from the second reading. The difference must be no greater than eight divisions plus the allowable error given in Table 5-5.

21. Check Delay Time Jitter

a. Set the 7B52 TIME/DIV or DL'Y TIME switch to 1 ms, DLY'D SWEEP switch to .5 μ s and rotate the DELAY TIME MULT control to about 10-00.

b. Set the 2901 for 1 ms markers.

c. Position the eleventh 1 ms marker near the center of the CRT graticule with the DELAY TIME MULT control.

d. CHECK—Jitter on leading edge of the pulse does not exceed 1 major division (1 part in 20,000 of 10 times the TIME/DIV switch setting). Disregard any slow drift across the CRT.

22. Check Mixed Sweep

a. Press the 7B52 MAIN SWP switch, set the DELAY TIME MULT control to 10-00, DLY'D SWEEP to .5 ms and rotate the POSITION control to align the markers with the CRT vertical lines.

b. Note timing accuracy over the center eight divisions of the CRT.

c. Press the 7B52 DISPLAY MODE MIXED switch.

d. CHECK—Mixed sweep timing accuracy must be within 2% (0.8 division) plus the error noted in part b within the center eight divisions of the CRT.

e. Rotate the DELAY TIME MULT control to 5-00 and the POSITION control to align the second marker with the first vertical line.

f. CHECK—Deviation of seventh marker from the eighth vertical line must be within 2% plus the error noted in part b.

g. Disconnect all test equipment.

23. Check External Amplifier Gain

a. Set the 7A16 and 7B52 controls and switches as given preceding Step 1 with the following exceptions:

7A16 AC-GND-DC switch to DC and the Volts/Div switch to .2 V.

7B52 TIME/DIV or DL'Y TIME, and DLY'D SWEEP switches to 10 μ s, MAIN TRIGGERING SOURCE to EXT, and the DLY'D LEVEL control locked in.

b. Connect a low frequency sine-wave generator to the 7A16 Input connector; set the frequency to 100 kHz and adjust the amplitude for a 4 div display (800 mV) on the CRT.

c. Disconnect the sine-wave generator from the 7A16 Input and reconnect it to the AMPL IN connector (MAIN TRIG IN); set the TIME/DIV or DL'Y TIME, and DLY'D SWEEP switches to AMPL.

d. CHECK—CRT horizontal trace length; must be 8 div within 10% (.8 major division). Rotate the POSITION control to use the center eight divisions.

Performance Check/Calibration—7B52

- e. Press the MAIN TRIGGERING EXT $\div 10$ switch.
- f. CHECK—CRT horizontal trace length; must be .8 major division within 10% (0.4 minor division).
- g. Release the X10 MAG switch.
- h. CHECK—CRT horizontal trace length; must be 8 div within 10% (.8 major division). Rotate the POSITION control to use the center eight divisions.

24. Check External Bandwidth

- a. Press the 7B52 MAIN TRIGGERING EXT and AC switches; lock the X10 MAG switch in.
- b. Set the sine-wave generator to 10 kHz and adjust the amplitude for a horizontal trace length of 8 div.
- c. Increase the frequency of the sine-wave generator until the horizontal length decreases to 5.6 div.
- d. CHECK—Sine-wave generator frequency must be 2 MHz or greater (upper -3 dB point).
- e. Decrease the frequency of the sine-wave generator until the horizontal trace length is again 8 div. Then, decrease the frequency until the length is 5.6 div.
- f. CHECK—Sine-wave generator frequency must be 40 Hz or less (lower -3 dB point).
- g. Using the procedure in parts b through f, check the upper and lower bandwidths listed in Table 5-6.

TABLE 5-6

7B52 COUPLING Switch Setting	BANDWIDTH LIMITS	
	Lower -3 dB Point	Upper -3 dB Point
AC LF REJ	16 kHz	2 MHz
AC HF REJ	40 Hz	100 kHz
DC	DC	2 MHz

25. Check Line Triggering

- a. Set the 7A16 and 7B52 controls and switches as given preceding Step 1 with the following exceptions:

7A16 AC-GND-DC switch to AC and Volts/Div switch to .1 V.

7B52 TIME/DIV or DL'Y TIME, and DLY'D SWEEP switches to 5 ms; press the MAIN TRIGGERING LINE switch, and lock in the DLY'D LEVEL control.

- b. Connect a 10X probe from the 7A16 Input connector to interface connector A3 (plug-in compartment at the rear of the 7B52).

c. CHECK—For stable triggering of the proper polarity at 0/+ and 0/- of the LEVEL/SLOPE control.

- d. Disconnect all test equipment. Remove the plug-in extender (Calibration Procedure Only) and install the 7B52 directly into the right compartment of the 7503.

NOTE

If a Tektronix 7704 or 7504 indicator oscilloscope is available, proceed to step 26.

26. (Optional) Check Mainframe Delaying Mode Selector Switch (S59)

- a. Install a 7B50 Time-Base Unit into the B Horiz compartment of the 7705 or 7704 indicator oscilloscope and set the 7B50 front-panel controls and switches as follows: Press the Triggering Auto, AC, and Int switches, Display Mode Time Base switch and the Sweep Magnifier X1 switch; set the Level/Slope control to 0/+ and the Time/Div switch to 20 μ s.

- b. Install a Vertical Plug-In Unit into the Left or Right Vert compartment of the indicator oscilloscope. Set the Volts/Div switch to .5 V and press the DC coupling switch.

c. Set the indicator oscilloscope for proper Left or Right Vertical Mode Triggering, Horizontal Mode switch to Alt, and press the A and B Trigger Source Left or Right Vert switches (depending into which vertical compartment the Vertical Unit is installed).

- d. Press the 7B52 MAIN TRIGGERING AUTO, AC, and INT switches and the DISPLAY MODE MAIN SWP switch; set the LEVEL/SLOPE control to 0/+, the TIME/DIV or DL'Y TIME and DLY'D SWEEP switches to 2switch to INDEPENDENT (rear position; see Fig. 2-1) and the INTERNAL DELAYED TRIGGER SOURCE selector switch to MAIN. Then, install the 7B52 into the A Horiz compartment of the indicator oscilloscope.

e. Adjust the indicator oscilloscope viewing controls for well defined CRT displays. (There will be two traces.)

f. From the Type 191 output connector, connect a 50 kHz signal via a 50 ohm coaxial cable and 50 ohm termination to the Vertical Input connector. Adjust the output amplitude of the generator for a CRT display amplitude of 3 divisions each sweep. (Use the indicator oscilloscope Trace Separation control to separate the sweeps if necessary.)

g. Observing the CRT display, operate the 7B52 and 7B50 front-panel controls.

h. CHECK—Each time base should operate independently.

i. Remove the 7B52 from the indicator and set the internal MAINFRAME DELAYING MODE selector switch to RUNS AFTER DT (center position; see Fig. 2-1). Re-install the 7B52 into the indicator oscilloscope.

j. Press the 7B52 DISPLAY MODE INTEN switch and set the TIME/DIV or DL'Y TIME and DLY'D SWEEP switches to 2 μ s.

k. Observing the CRT displays, perform the following: rotate the 7B52 and 7B50 LEVEL/SLOPE controls; rotate the TIME/DIV switches (always keep the 7B50 Time/Div switch setting at least one switch setting faster than the TIME/DIV setting of the 7B52); rotate the DELAY TIME MULT control (DTM).

l. CHECK—Rotation of 7B52 LEVEL/SLOPE control will determine sweep triggering of both displays; setting of 7B52 TIME/DIV switch determines the rate of the normal sweep only, and setting of 7B50 Time/Div switch determines the length of intensified portion of normal sweep and the rate of the Delayed Sweep; rotation of 7B52 DTM control will permit any portion of the normal sweep to be intensified and delayed.

m. Remove the 7B52 from the indicator oscilloscope and set the internal MAINFRAME DELAYING MODE selector switch to TRIGGERABLE AFTER DT (front position; see Fig. 2-1). Re-install the 7B52 in the indicator oscilloscope.

n. Repeat part k.

o. CHECK—Rotation of 7B52 LEVEL/SLOPE control will determine sweep triggering of normal sweep only and rotation of 7B50 Level/Slope control will determine the

triggering point of the intensified portion of the normal sweep and the Delayed Sweep. Rotation of TIME/DIV switches affects CRT displays as in part l; one complete revolution of the DTM will permit only that portion of the intensified display of the normal sweep to be displayed which is controlled by the setting of the 7B50 Level/Slope control.

p. Remove the 7B52 from the indicator oscilloscope and set the internal MAINFRAME DELAYING MODE selector switch to INDEPENDENT.

27. (Optional) Check Internal Delayed Trigger Source Selector Switch (S21)

a. Remove the 7B50 from the indicator oscilloscope B Horiz Compartment. Press the Horizontal Mode A switch and the A and B Trigger Source Left or Right Vert switches. (A and B Trigger Source switch setting is determined by the compartment used for the Vertical Unit.)

b. Install the 067-0589-00 Plug-In Extender into the indicator oscilloscope A Horiz compartment, and the 7B52 on the extender.

c. Press the 7B52 MAIN TRIGGERING AUTO, AC, and INT switches and DISPLAY MODE INTEN switch. Release the DLY'D LEVEL control, set the TIME/DIV or DL'Y TIME switch to 20 μ s, set the DLY'D SWEEP switch to 5 μ s, and rotate the DELAY TIME MULT control to 5-00.

d. Observing the CRT display, rotate the LEVEL/SLOPE control to trigger the normal, and the DLY'D LEVEL control to trigger the intensified portion of the normal sweep.

e. CHECK—Triggering of intensified portion of the normal sweep is controlled by DLY'D LEVEL control, indicating that delayed trigger source is the indicator oscilloscope A Horiz Trig Selector.

f. Switch the INTERNAL DELAYED TRIGGER SOURCE selector switch to AUX (see Fig. 2-1).

g. Repeat part d.

h. Press the indicator oscilloscope B Trigger Source switch for the compartment opposite the one used for the Vertical Unit.

i. Observing the CRT display, rotate the DLY'D LEVEL control.

Performance Check/Calibration—7B52

j. CHECK—CRT for no intensified display, indicating that the delayed trigger source is the indicator oscilloscope B Horiz Trig Selector.

k. Remove the extender and 7B52 from the A Horiz compartment of the indicator oscilloscope and re-install them in the B Horiz compartment.

l. Press the indicator oscilloscope Horizontal Mode B switch and the A and B Trigger Source Left or Right Vert switches. (A and B Trigger source switch setting is determined by compartment used for the Vertical Unit.)

m. Repeat part d.

n. Press the indicator oscilloscope A Trigger Source switch for the compartment opposite the one used for the Vertical Unit.

o. Observing the CRT display, rotate the DLY'D LEVEL control.

p. CHECK—CRT for no intensified display, indicating that the delayed trigger source is the indicator oscilloscope A Horiz Trig Selector.

q. Switch the INTERNAL DELAYED TRIGGER SOURCE selector switch to MAIN (see Fig. 2-1).

r. Observing the CRT display, rotate the DLY'D LEVEL control.

s. CHECK—Triggering of intensified portion of the normal sweep is controlled by the DLY'D LEVEL control, indicating that delayed trigger source is the indicator oscilloscope B Horizontal Trig Selector.

PARTS LIST ABBREVIATIONS

BHB	binding head brass	int	internal
BHS	binding head steel	lg	length or long
cap.	capacitor	met.	metal
cer	ceramic	mtg hdw	mounting hardware
comp	composition	OD	outside diameter
conn	connector	OHB	oval head brass
CRT	cathode-ray tube	OHS	oval head steel
csk	countersunk	P/O	part of
DE	double end	PHB	pan head brass
dia	diameter	PHS	pan head steel
div	division	plstc	plastic
elect.	electrolytic	PMC	paper, metal cased
EMC	electrolytic, metal cased	poly	polystyrene
EMT	electrolytic, metal tubular	prec	precision
ext	external	PT	paper, tubular
F & I	focus and intensity	PTM	paper or plastic, tubular, molded
FHB	flat head brass	RHB	round head brass
FHS	flat head steel	RHS	round head steel
Fil HB	fillister head brass	SE	single end
Fil HS	fillister head steel	SN or S/N	serial number
h	height or high	S or SW	switch
hex.	hexagonal	TC	temperature compensated
HHB	hex head brass	THB	truss head brass
HHS	hex head steel	thk	thick
HSB	hex socket brass	THS	truss head steel
HSS	hex socket steel	tub.	tubular
ID	inside diameter	var	variable
inc	incandescent	w	wide or width
		WW	wire-wound

PARTS ORDERING INFORMATION

Replacement parts are available from or through your local Tektronix, Inc. Field Office or representative.

Changes to Tektronix instruments are sometimes made to accommodate improved components as they become available, and to give you the benefit of the latest circuit improvements developed in our engineering department. It is therefore important, when ordering parts, to include the following information in your order: Part number, instrument type or number, serial or model number, and modification number if applicable.

If a part you have ordered has been replaced with a new or improved part, your local Tektronix, Inc. Field Office or representative will contact you concerning any change in part number.

SPECIAL NOTES AND SYMBOLS

- | | |
|-----------------|---|
| ×000 | Part first added at this serial number |
| 00× | Part removed after this serial number |
| *000-0000-00 | Asterisk preceding Tektronix Part Number indicates manufactured by or for Tektronix, Inc., or reworked or checked components. |
| Use 000-0000-00 | Part number indicated is direct replacement. |

INDEX OF ELECTRICAL PARTS LIST

Title	Page No.
CHASSIS	6-1
INTERFACE Circuit Board Assembly	6-2
DISTRIBUTION Circuit Board Assembly	6-7
SWEEP Circuit Board Assembly	6-7
DELAYED TRIGGER Circuit Board Assembly	6-17
TRIGGER MODE SWITCH Circuit Board Assembly	6-21
DISPLAY MODE SWITCH Circuit Board Assembly	6-22
SOURCE SWITCH Circuit Board Assembly	6-22
COUPLING SWITCH Circuit Board Assembly	6-23
MAIN TRIGGER Circuit Board Assembly	6-23
DELAYED TRIGGER SWITCH Circuit Board Assembly	6-28
READOUT Circuit Board Assembly	6-28
INTERFACE READOUT Circuit Board Assembly	6-29

SECTION 6

ELECTRICAL PARTS LIST

Values are fixed unless marked Variable.

Ckt. No.	Tektronix Part No.	Serial/Model No. Eff	No. Disc	Description
----------	--------------------	----------------------	----------	-------------

CHASSIS

Bulbs

DS2	*150-0048-01			Incandescent #683, selected
DS8	*150-0048-01			Incandescent #683, selected

Capacitors

Tolerance $\pm 20\%$ unless otherwise indicated.

C4	283-0636-00		36 pF	Mica	500 V	± 0.5 pF
C51	283-0636-00		36 pF	Mica	500 V	± 0.5 pF

Connectors

J16	131-0955-00			Receptacle, electrical, BNC, female
J18	131-0955-00			Receptacle, electrical, BNC, female

Resistors

Resistors are fixed, composition, $\pm 10\%$ unless otherwise indicated.

R2 ¹	311-1063-00		5 k Ω , Var			
R4	317-0510-00		51 Ω	$\frac{1}{8}$ W		5%
R5	322-0610-00		500 k Ω	$\frac{1}{4}$ W	Prec	1%
R8	311-1059-00		10 k Ω , Var			
R15 ²	311-1068-00		5 k Ω , Var			
R19	311-0946-00		50 k Ω , Var			
R51	317-0510-00		51 Ω	$\frac{1}{8}$ W		5%
R52	322-0610-00		500 k Ω	$\frac{1}{4}$ W	Prec	1%

¹Furnished as a unit with S2.

²Ganged with S15.

INTERFACE Circuit Board Assembly (cont)

Ckt. No.	Tektronix Part No.	Serial/Model No. Eff	Disc	Description
Semiconductor Device, Diodes				
CR22	152-0141-02		Silicon	1N4152
CR41	*152-0185-00		Silicon	Replaceable by 1N4152
CR48	*152-0185-00		Silicon	Replaceable by 1N4152
CR59	*152-0185-00		Silicon	Replaceable by 1N4152
CR67	*152-0185-00		Silicon	Replaceable by 1N4152
CR100	*152-0185-00		Silicon	Replaceable by 1N4152
CR101	*152-0185-00		Silicon	Replaceable by 1N4152
CR102	*152-0185-00		Silicon	Replaceable by 1N4152
CR104	*152-0185-00		Silicon	Replaceable by 1N4152
CR105	*152-0185-00		Silicon	Replaceable by 1N4152
CR107	*152-0185-00		Silicon	Replaceable by 1N4152
CR108	*152-0185-00		Silicon	Replaceable by 1N4152
CR110	*152-0185-00		Silicon	Replaceable by 1N4152
CR111	*152-0185-00		Silicon	Replaceable by 1N4152
CR113	*152-0185-00		Silicon	Replaceable by 1N4152
CR114	*152-0185-00		Silicon	Replaceable by 1N4152
CR116	*152-0185-00		Silicon	Replaceable by 1N4152
CR117	*152-0185-00		Silicon	Replaceable by 1N4152
CR231	*152-0185-00		Silicon	Replaceable by 1N4152
CR232	*152-0185-00		Silicon	Replaceable by 1N4152
CR233	*152-0185-00		Silicon	Replaceable by 1N4152
CR234	*152-0185-00		Silicon	Replaceable by 1N4152
CR237	*152-0185-00		Silicon	Replaceable by 1N4152
CR241	*152-0185-00		Silicon	Replaceable by 1N4152
CR242	*152-0185-00		Silicon	Replaceable by 1N4152
CR243	*152-0185-00		Silicon	Replaceable by 1N4152
CR244	*152-0185-00		Silicon	Replaceable by 1N4152
CR246	*152-0185-00		Silicon	Replaceable by 1N4152
CR251	*152-0185-00		Silicon	Replaceable by 1N4152
CR256	*152-0185-00		Silicon	Replaceable by 1N4152
CR258	*152-0185-00		Silicon	Replaceable by 1N4152
Inductors				
L16	276-0507-00		Core, ferramic suppressor	
L29	276-0507-00		Core, ferramic suppressor	
L39	276-0507-00		Core, ferramic suppressor	
L120	*120-0382-00		Toroid, 14 turns, single	
L123	*120-0382-00		Toroid, 14 turns, single	
L128	*120-0382-00		Toroid, 14 turns, single	
L131	*120-0382-00		Toroid, 14 turns, single	

INTERFACE Circuit Board Assembly (cont)

Ckt. No.	Tektronix Part No.	Serial/Model No. Eff	Disc	Description
Transistors				
Q24 ⁵	*153-0584-00		Silicon	NPN TO-105 Selected from RCA 40235
Q26	*151-0230-00		Silicon	NPN TO-105 Selected from RCA 40235
Q34 ⁶	*153-0584-00		Silicon	NPN TO-105 Selected from RCA 40235
Q36	*151-0230-00		Silicon	NPN TO-105 Selected from RCA 40235
Q42	151-0220-00		Silicon	PNP TO-18 2N4122
Q44	151-0220-00		Silicon	PNP TO-18 2N4122
Q48	*151-0190-01		Silicon	NPN TO-106 Tek Spec
Q54	*151-0190-01		Silicon	NPN TO-106 Tek Spec
Q56	*151-0190-01		Silicon	NPN TO-106 Tek Spec

Resistors

Resistors are fixed, composition, $\pm 10\%$ unless otherwise indicated.

R6	317-0101-00	100 Ω	$\frac{1}{8}$ W	5%
R7	315-0472-00	4.7 k Ω	$\frac{1}{4}$ W	5%
R20	315-0511-00	510 Ω	$\frac{1}{4}$ W	5%
R21	315-0511-00	510 Ω	$\frac{1}{4}$ W	5%
R22	315-0102-00	1 k Ω	$\frac{1}{4}$ W	5%
R24	315-0751-00	750 Ω	$\frac{1}{4}$ W	5%
R27	315-0302-00	3 k Ω	$\frac{1}{4}$ W	5%
R28	321-0164-00	499 Ω	$\frac{1}{8}$ W	Prec 1%
R29	315-0270-00	27 Ω	$\frac{1}{4}$ W	5%
R34	315-0751-00	750 Ω	$\frac{1}{4}$ W	5%
R37	315-0302-00	3 k Ω	$\frac{1}{4}$ W	Prec 5%
R38	321-0164-00	499 Ω	$\frac{1}{8}$ W	Prec 1%
R39	315-0207-00	27 Ω	$\frac{1}{4}$ W	5%
R41	315-0431-00	430 Ω	$\frac{1}{4}$ W	5%
R42	315-0362-00	3.6 k Ω	$\frac{1}{4}$ W	5%
R43	315-0751-00	750 Ω	$\frac{1}{4}$ W	5%
R44	315-0751-00	750 Ω	$\frac{1}{4}$ W	5%
R46	315-0102-00	1 k Ω	$\frac{1}{4}$ W	5%
R48	317-0472-00	4.7 k Ω	$\frac{1}{8}$ W	5%
R49	315-0470-00	47 Ω	$\frac{1}{4}$ W	5%
R58	315-0101-00	100 Ω	$\frac{1}{4}$ W	5%
R59	315-0201-00	200 Ω	$\frac{1}{4}$ W	5%
R60	311-1060-00	500 Ω , Var		
R114	315-0102-00	1 k Ω	$\frac{1}{4}$ W	5%
R115	315-0332-00	3.3 k Ω	$\frac{1}{4}$ W	5%

⁵Furnished as a matched pair with Q34.

⁶Furnished as a matched pair with Q24.

INTERFACE Circuit Board Assembly (cont)

Ckt. No.	Tektronix Part No.	Serial/Model No. Eff	Disc	Description		
Resistors (cont)						
R116	315-0273-00		27 k Ω	1/4 W		5%
R119	321-0356-00		49.9 k Ω	1/8 W	Prec	1%
R120	315-0101-00		100 Ω	1/4 W		5%
R123	315-0101-00		100 Ω	1/4 W		5%
R126	315-0270-00		27 Ω	1/4 W		5%
R128	315-0101-00		100 Ω	1/4 W		5%
R131	315-0101-00		100 Ω	1/4 W		5%
R200	317-0154-00		150 k Ω	1/8 W		5%
R201	317-0753-00		75 k Ω	1/8 W		5%
R202	317-0513-00		51 k Ω	1/8 W		5%
R203	317-0154-00		150 k Ω	1/8 W		5%
R204	317-0753-00		75 k Ω	1/8 W		5%
R205	321-0344-00		37.4 k Ω	1/8 W	Prec	1%
R206	317-0154-00		150 k Ω	1/8 W		5%
R207	317-0154-00		150 k Ω	1/8 W		5%
R208	321-0371-00		71.5 k Ω	1/8 W	Prec	1%
R218	321-0371-00		71.5 k Ω	1/8 W	Prec	1%
R219	317-0154-00		150 k Ω	1/8 W		5%
R220	317-0154-00		150 k Ω	1/8 W		5%
R221	321-0344-00		37.4 k Ω	1/8 W	Prec	1%
R222	317-0154-00		150 k Ω	1/8 W		5%
R223	317-0753-00		75 k Ω	1/8 W		5%
R224	317-0513-00		51 k Ω	1/8 W		5%
R225	317-0154-00		150 k Ω	1/8 W		5%
R226	317-0753-00		75 k Ω	1/8 W		5%
R231	317-0332-00		3.3 k Ω	1/8 W		5%
R232	317-0332-00		3.3 k Ω	1/8 W		5%
R233	317-0154-00		150 k Ω	1/8 W		5%
R234	317-0113-00		11 k Ω	1/8 W		5%
R237	317-0104-00		100 k Ω	1/8 W		5%
R238	317-0203-00		20 k Ω	1/8 W		5%
R241	317-0272-00		2.7 k Ω	1/8 W		5%
R242	317-0272-00		2.7 k Ω	1/8 W		5%
R246	317-0512-00		5.1 k Ω	1/8 W		5%
R251	317-0133-00		13 k Ω	1/8 W		5%
R253	317-0154-00		150 k Ω	1/8 W		5%
R254	317-0154-00		150 k Ω	1/8 W		5%
R256	317-0154-00		150 k Ω	1/8 W		5%
R258	317-0133-00		13 k Ω	1/8 W		5%

INTERFACE Circuit Board Assembly (cont)

Ckt. No.	Tektronix Part No.	Serial/Model No. Eff	No. Disc	Description		
R261	317-0753-00		75 kΩ	1/8 W		5%
R262	317-0753-00		75 kΩ	1/8 W		5%
R263	317-0154-00		150 kΩ	1/8 W		5%
R264	317-0154-00		150 kΩ	1/8 W		5%
R265	317-0154-00		150 kΩ	1/8 W		5%
R266	317-0513-00		51 kΩ	1/8 W		5%
R267	317-0513-00		51 kΩ	1/8 W		5%
R268	321-0344-00		37.4 kΩ	1/8 W	Prec	1%
R269	321-0344-00		37.4 kΩ	1/8 W	Prec	1%
R271	325-0082-00		33.51 MΩ	1 W	Prec	1/10%
R272	325-0081-00		11.17 MΩ	1/2 W	Prec	1/10%
R273	325-0081-00		11.17 MΩ	1/2 W	Prec	1/10%
R274	325-0080-00		3.351 MΩ	1/2 W	Prec	1/10%
R275	323-0789-07		1.117 MΩ	1/2 W	Prec	1/10%
R276	323-0789-07		1.117 MΩ	1/2 W	Prec	1/10%
R281	323-0788-07		558.5 kΩ	1/2 W	Prec	1/10%
R282	323-0787-07		223.4 kΩ	1/2 W	Prec	1/10%
R283	323-0786-07		111.7 kΩ	1/2 W	Prec	1/10%
R284	323-0785-07		55.8 kΩ	1/2 W	Prec	1/10%
R286	323-0785-07		55.8 kΩ	1/2 W	Prec	1/10%
R287	322-0786-07		111.7 kΩ	1/2 W	Prec	1/10%
R288	323-0787-07		223.4 kΩ	1/2 W	Prec	1/10%
R289	323-0788-07		558.5 kΩ	1/2 W	Prec	1/10%
R291	325-0082-00		33.51 MΩ	1 W	Prec	1/10%
R292	325-0081-00		11.17 MΩ	1/2 W	Prec	1/10%
R293	325-0081-00		11.17 MΩ	1/2 W	Prec	1/10%
R294	325-0080-00		3.351 MΩ	1/2 W	Prec	1/10%
R295	323-0789-07		1.117 MΩ	1/2 W	Prec	1/10%
R296	323-0789-07		1.117 MΩ	1/2 W	Prec	1/10%
R298	321-0289-00		10 kΩ	1/8 W	Prec	1%
R299	315-0101-00		100 Ω	1/8 W		5%

Switches

Wired or Unwired

S21	260-1050-00	Rotary	INTERNAL TRIGGER SELECTOR
S59	260-0984-00	Slide	MAINFRAME DELAYING MODE

DISTRIBUTION Circuit Board Assembly

Ckt. No.	Tektronix Part No.	Serial/Model No. Eff	Disc	Description
----------	--------------------	----------------------	------	-------------

*670-1216-00

Complete Board

Semiconductor Device, Diodes

CR54	*152-0185-00		Silicon	Replaceable by 1N4152
CR55	*152-0185-00		Silicon	Replaceable by 1N4152
CR57	*152-0185-00		Silicon	Replaceable by 1N4152
CR58	*152-0185-00		Silicon	Replaceable by 1N4152
CR61	*152-0185-00		Silicon	Replaceable by 1N4152
CR62	*152-0185-00		Silicon	Replaceable by 1N4152
CR63	152-0079-00		Germanium	HD1841
CR64	152-0079-00		Germanium	HD1841
CR66	*152-0185-00		Silicon	Replaceable by 1N4152
CR71	*152-0185-00		Silicon	Replaceable by 1N4152

Transistors

Q6	151-0301-00		Silicon	PNP	TO-18	2N2907
Q8	151-0188-00		Silicon	PNP	TO-92	2N3906

Resistors

Resistors are fixed, composition, $\pm 10\%$ unless otherwise indicated.

R61	315-0332-00	3.3 k Ω	$\frac{1}{4}$ W	5%
R62	315-0431-00	430 Ω	$\frac{1}{4}$ W	5%
R71	315-0202-00	2 k Ω	$\frac{1}{4}$ W	5%
R72	315-0102-00	1 k Ω	$\frac{1}{4}$ W	5%
R74	315-0303-00	30 k Ω	$\frac{1}{4}$ W	5%
R75	315-0472-00	4.7 k Ω	$\frac{1}{4}$ W	5%

SWEEP Circuit Board Assembly

*670-1217-00

Complete Board

Capacitors

Tolerance $\pm 20\%$ unless otherwise indicated.

C704	283-0111-00	0.1 μ F	Cer	50 V	
C711	290-0136-00	2.2 μ F	Elect.	20 V	
C731	290-0136-00	2.2 μ F	Elect.	20 V	
C746	281-0504-00	10 pF	Cer	500 V	10%
C750	290-0305-01	3 μ F	Elect.	150 V	10%

SWEEP Circuit Board Assembly (cont)

Ckt. No.	Tektronix Part No.	Serial/Model No. Eff Disc	Description			
Capacitors (cont)						
C753	290-0267-00		1 μ F	Elect.	35 V	
C756	283-0204-00		0.01 μ F	Cer	50 V	
C758	283-0059-00		1 μ F	Cer	25 V	+80%—20%
C759	281-0593-00		3.9 pF	Cer	500 V	10%
C764	290-0136-00		2.2 μ F	Elect.	20 V	
C772	281-0523-00		100 pF	Cer	350 V	
C773	281-0629-00		33 pF	Cer	600 V	5%
C776	283-0059-00		1 μ F	Cer	25 V	+80%—20%
C778	281-0166-00		1.9-15.7 pF, Var	Air	250 V	
C779	283-0251-00		87 pF	Cer	500 V	5%
C785	281-0579-00		21 pF	Cer	500 V	5%
C787	283-0150-00		650 pF	Cer	200 V	5%
C796	281-0523-00		100 pF	Cer	350 V	
C822	290-0301-00		10 μ F	Elect.	20 V	10%
C825	281-0504-00		10 pF	Cer	500 V	10%
C827	283-0000-00		0.001 μ F	Cer	500 V	
C833	281-0562-00		39 pF	Cer	500 V	
C837	281-0504-00		10 pF	Cer	500 V	10%
C841	283-0249-00		0.068 μ F	Cer	50 V	10%
C842	283-0194-00		4.7 μ F	Cer	50 V	
C843	283-0195-00		680 pF	Cer	50 V	10%
C851	283-0059-00		1 μ F	Cer	25 V	+80%—20%
C852	290-0134-00		22 μ F	Elect.	15 V	
C854	283-0111-00		0.1 μ F	Cer	50 V	
C855	290-0297-00		39 μ F	Elect.	10 V	10%
C857	283-0059-00		1 μ F	Cer	25 V	+80%—20%
C858	290-0134-00		22 μ F	Elect.	15 V	
C859	283-0111-00		0.1 μ F	Cer	50 V	
C862	283-0080-00		0.022 μ F	Cer	25 V	+80%—20%
C891	283-0000-00		0.001 μ F	Cer	500 V	
C896	281-0544-00		5.6 pF	Cer	500 V	10%
C899	281-0504-00		10 pF	Cer	500 V	1%
C906	290-0136-00		2.2 μ F	Elect.	20 V	
C907	281-0504-00		10 pF	Cer	500 V	10%
C910	281-0504-00		10 pF	Cer	500 V	10%
C917	281-0518-00		47 pF	Cer	500 V	
C922	283-0111-00		0.1 μ F	Cer	50 V	
C924	283-0111-00		0.1 μ F	Cer	50 V	
C926	290-0136-00		2.2 μ F	Elect.	20 V	
C930	283-0111-00		0.1 μ F	Cer	50 V	

SWEEP Circuit Board Assembly (cont)

Ckt. No.	Tektronix Part No.	Serial/Model No. Eff	Disc	Description
Capacitors (cont)				
C932	283-0059-00		1 μ F	Cer 25 V +80%—20%
C937	281-0523-00		100 pF	Cer 350 V
C938	281-0518-00		47 pF	Cer 500 V
C939	283-0059-00		1 μ F	Cer 25 V +80%—20%
C942	281-0504-00		10 pF	Cer 500 V 10%
C946	281-0504-00		10 pF	Cer 500 V 10%
C951	281-0523-00		100 pF	Cer 350 V
C956	281-0166-00		1.9-15.7 pF, Var	Air 250 V
C957	283-0251-00		87 pF	Cer 500 V 5%
C993	281-0504-00		10 pF	Cer 500 V 10%
C1001	281-0512-00		27 pF	Cer 500 V 10%
C1006	281-0572-00		6.8 pF	Cer 500 V ± 0.5 pF
C1014	283-0059-00		1 μ F	Cer 25 V +80%—20%
C1018	283-0000-00		0.001 μ F	Cer 500 V
C1019	283-0111-00		0.1 μ F	Cer 50 V
C1022	283-0000-00		0.001 μ F	Cer 500 V
C1028	283-0000-00		0.001 μ F	Cer 500 V
C1029	283-0000-00		0.001 μ F	Cer 500 V

Semiconductor Device, Diodes

CR706	*152-0185-00		Silicon	Replaceable by 1N4152
CR737	*152-0185-00		Silicon	Replaceable by 1N4152
VR738	152-0278-00		Zener	1N4372A 400 mW, 3 V, 5%
CR759	*152-0075-00		Germanium	Tek Spec
CR764	*152-0185-00		Silicon	Replaceable by 1N4152
CR785	*152-0185-00		Silicon	Replaceable by 1N4152
CR789	*152-0185-00		Silicon	Replaceable by 1N4152
CR801	*152-0185-00		Silicon	Replaceable by 1N4152
CR807	*152-0185-00		Silicon	Replaceable by 1N4152
CR809	*152-0185-00		Silicon	Replaceable by 1N4152
CR816	*152-0185-00		Silicon	Replaceable by 1N4152
CR817	*152-0185-00		Silicon	Replaceable by 1N4152
CR819	*152-0185-00		Silicon	Replaceable by 1N4152
CR821	*152-0185-00		Silicon	Replaceable by 1N4152
CR822	*152-0185-00		Silicon	Replaceable by 1N4152
CR823	*152-0185-00		Silicon	Replaceable by 1N4152
CR827	*152-0185-00		Silicon	Replaceable by 1N4152
VR832	152-0127-00		Zener	1N755A 400 mW, 7.5 V, 5%
CR845	*152-0185-00		Silicon	Replaceable by 1N4152
CR846	*152-0185-00		Silicon	Replaceable by 1N4152

SWEEP Circuit Board Assembly (cont)

Ckt. No.	Tektronix Part No.	Serial/Model No. Eff Disc	Description	
Semiconductor Device, Diodes (cont)				
CR866	*152-0075-00		Germanium	Tek Spec
CR869	*152-0185-00		Silicon	Replaceable by 1N4152
CR888	*152-0075-00		Germanium	Tek Spec
CR889	*152-0185-00		Silicon	Replaceable by 1N4152
CR897	152-0307-00		Silicon	Dual signal
CR901	*152-0075-00		Germanium	Tek Spec
CR926	*152-0185-00		Silicon	Replaceable by 1N4152
CR927	*152-0185-00		Silicon	Replaceable by 1N4152
CR944	*152-0185-00		Silicon	Replaceable by 1N4152
CR948	*152-0185-00		Silicon	Replaceable by 1N4152
CR951	*152-0185-00		Silicon	Replaceable by 1N4152
CR967	*152-0185-00		Silicon	Replaceable by 1N4152
CR968	*152-0185-00		Silicon	Replaceable by 1N4152
CR981	*152-0185-00		Silicon	Replaceable by 1N4152
CR987	*152-0185-00		Silicon	Replaceable by 1N4152
CR991	*152-0185-00		Silicon	Replaceable by 1N4152
CR993	*152-0185-00		Silicon	Replaceable by 1N4152
CR1003	152-0141-02		Silicon	1N4152
CR1012	*152-0185-00		Silicon	Replaceable by 1N4152
CR1016	*152-0185-00		Silicon	Replaceable by 1N4152
VR1019	152-0227-00		Zener	1N753A 400 mW, 6.2 V, 5%
CR1033	*152-0185-00		Silicon	Replaceable by 1N4152
CR1043	*152-0185-00		Silicon	Replaceable by 1N4152
Relay				
K1055	*148-0034-00		Armature, dpdt, 15 V DC	
Transistors				
Q702	151-0221-00		Silicon	PNP TO-18 2N4258
Q704	151-0220-00		Silicon	PNP TO-18 2N4122
Q706	*151-0192-00		Silicon	NPN TO-92 Replaceable by MPS 6521
Q710	*151-0192-00		Silicon	NPN TO-92 Replaceable by MPS 6521
Q722	151-0223-00		Silicon	NPN TO-18 2N4275
Q726	151-0223-00		Silicon	NPN TO-18 2N4275
Q730	*151-0190-01		Silicon	NPN TO-106 Tek Spec
Q762	151-0221-00		Silicon	PNP TO-18 2N4258
Q764	151-0221-00		Silicon	PNP TO-18 2N4258
Q782	151-0301-00		Silicon	PNP TO-18 2N2907

SWEEP Circuit Board Assembly (cont)

Ckt. No.	Tektronix Part No.	Serial/Model No. Eff	Disc	Description	
Transistors (cont)					
Q798	151-0220-00		Silicon	PNP	TO-18 2N4122
Q804	*151-0190-01		Silicon	NPN	TO-106 Tek Spec
Q812	151-0220-00		Silicon	PNP	TO-18 2N4122
Q818	*151-0190-01		Silicon	NPN	TO-106 Tek Spec
Q862	151-0220-00		Silicon	PNP	TO-18 2N4122
Q882	151-0223-00		Silicon	NPN	TO-18 2N4275
Q886	151-0223-00		Silicon	NPN	TO-18 2N4275
Q888	*151-0289-00		Silicon	PNP	TO-18 Tek Spec
Q892	*151-0190-01		Silicon	NPN	TO-106 Tek Spec
Q896	*151-0259-00		Silicon	NPN	TO-106 Selected from 2N3563
Q898	*151-0259-00		Silicon	NPN	TO-106 Selected from 2N3563
Q902	151-0220-00		Silicon	PNP	TO-18 2N4122
Q904	151-0221-00		Silicon	PNP	TO-18 2N4258
Q906	*151-0190-01		Silicon	NPN	TO-106 Tek Spec
Q922	151-0223-00		Silicon	NPN	TO-18 2N4275
Q924	151-0223-00		Silicon	NPN	TO-18 2N4275
Q928	151-0221-00		Silicon	PNP	TO-18 2N4258
Q942	151-0223-00		Silicon	NPN	TO-18 2N4275
Q944	151-0223-00		Silicon	NPN	TO-18 2N4275
Q954	151-0220-00		Silicon	PNP	TO-18 2N4122
Q962	*151-0216-00		Silicon	PNP	TO-92 Replaceable by MOT MPS 6523
Q966	*151-0216-00		Silicon	PNP	TO-92 Replaceable by MOT MPS 6523
Q968	151-0220-00		Silicon	PNP	TO-18 2N4122
Q984	*151-0192-00		Silicon	NPN	TO-92 Replaceable by MPS 6521
Q988	*151-0190-01		Silicon	NPN	TO-106 Tek Spec
Q992	151-0221-00		Silicon	PNP	TO-18 2N4258
Q1004	*151-0219-00		Silicon	PNP	TO-18 Replaceable by 2N4250
Q1006	151-0224-00		Silicon	NPN	TO-18 2N3692
Q1014	*151-0192-00		Silicon	NPN	TO-92 Replaceable by MPS 6521
Q1024	*151-0190-01		Silicon	NPN	TO-106 Tek Spec
Q1038	151-0224-00		Silicon	NPN	TO-18 2N3692
Q1046	*151-0190-01		Silicon	NPN	TO-106 Tek Spec

ResistorsResistors are fixed, composition, $\pm 10\%$ unless otherwise indicated.

R701	315-0154-00	150 k Ω	$\frac{1}{4}$ W		5%
R702	315-0223-00	22 k Ω	$\frac{1}{4}$ W		5%
R703	315-0332-00	3.3 k Ω	$\frac{1}{4}$ W		5%
R704	321-0285-00	9.09 k Ω	$\frac{1}{8}$ W	Prec	1%
R705	321-0321-00	21.5 k Ω	$\frac{1}{8}$ W	Prec	1%

SWEEP Circuit Board Assembly (cont)

Ckt. No.	Tektronix Part No.	Serial/Model No. Eff Disc	Description
Resistors (cont)			
R706	315-0561-00	560 Ω	$\frac{1}{4}$ W 5%
R707	315-0472-00	4.7 k Ω	$\frac{1}{4}$ W 5%
R711	315-0200-00	20 Ω	$\frac{1}{4}$ W 5%
R721	315-0270-00	27 Ω	$\frac{1}{4}$ W 5%
R722	315-0620-00	62 Ω	$\frac{1}{4}$ W 5%
R723	315-0241-00	240 Ω	$\frac{1}{4}$ W 5%
R724	323-0192-00	976 Ω	$\frac{1}{2}$ W Prec 1%
R725	315-0241-00	240 Ω	$\frac{1}{4}$ W 5%
R726	315-0620-00	62 Ω	$\frac{1}{4}$ W 5%
R728	321-0146-00	324 Ω	$\frac{1}{8}$ W Prec 1%
R731	315-0331-00	330 Ω	$\frac{1}{4}$ W 5%
R732	315-0152-00	1.5 k Ω	$\frac{1}{4}$ W 5%
R735	311-0836-00	5 k Ω , Var	
R736	321-0335-00	30.1 k Ω	$\frac{1}{8}$ W Prec 1%
R737	315-0564-00	560 k Ω	$\frac{1}{4}$ W 5%
R740	315-0274-00	270 k Ω	$\frac{1}{4}$ W 5%
R741	315-0184-00	180 k Ω	$\frac{1}{4}$ W 5%
R742	315-0104-00	100 k Ω	$\frac{1}{4}$ W 5%
R743	315-0433-00	43 k Ω	$\frac{1}{4}$ W 5%
R744	315-0103-00	10 k Ω	$\frac{1}{4}$ W 5%
R746	315-0202-00	2 k Ω	$\frac{1}{4}$ W 5%
R747	315-0511-00	510 Ω	$\frac{1}{4}$ W 5%
R750	311-0813-00	25 k Ω , Var	
R751	321-0387-00	105 k Ω	$\frac{1}{8}$ W Prec 1%
R753	315-0103-00	10 k Ω	$\frac{1}{4}$ W 5%
R754	315-0304-00	300 k Ω	$\frac{1}{4}$ W 5%
R755	311-0840-00	20 k Ω , Var	
R756	315-0103-00	10 k Ω	$\frac{1}{4}$ W 5%
R757	315-0101-00	100 Ω	$\frac{1}{4}$ W 5%
R758	315-0101-00	100 Ω	$\frac{1}{4}$ W 5%
R759	315-0752-00	7.5 k Ω	$\frac{1}{4}$ W 5%
R761	315-0563-00	56 k Ω	$\frac{1}{4}$ W 5%
R762	315-0202-00	2 k Ω	$\frac{1}{4}$ W 5%
R763	315-0511-00	510 Ω	$\frac{1}{4}$ W 5%
R764	315-0751-00	750 Ω	$\frac{1}{4}$ W 5%
R765	315-0271-00	270 Ω	$\frac{1}{4}$ W 5%
R766	315-0682-00	6.8 k Ω	$\frac{1}{4}$ W 5%
R770	311-0831-00	100 k Ω , Var	
R771	315-0433-00	43 k Ω	$\frac{1}{4}$ W 5%
R772	315-0201-00	200 Ω	$\frac{1}{4}$ W 5%

SWEEP Circuit Board Assembly (cont)

Ckt. No.	Tektronix Part No.	Serial/Model No. Eff Disc	Description
Resistors (cont)			
R776	315-0621-00	620 Ω	$\frac{1}{4}$ W 5%
R781	315-0621-00	620 Ω	$\frac{1}{4}$ W 5%
R782	315-0132-00	1.3 k Ω	$\frac{1}{4}$ W 5%
R783	315-0621-00	620 Ω	$\frac{1}{4}$ W 5%
R785	315-0751-00	750 Ω	$\frac{1}{4}$ W 5%
R787	315-0102-00	1 k Ω	$\frac{1}{4}$ W 5%
R789	315-0472-00	4.7 k Ω	$\frac{1}{4}$ W 5%
R791	315-0471-00	470 Ω	$\frac{1}{4}$ W 5%
R792	315-0362-00	3.6 k Ω	$\frac{1}{4}$ W 5%
R794	315-0471-00	470 Ω	$\frac{1}{4}$ W 5%
R796	315-0362-00	3.6 k Ω	$\frac{1}{4}$ W 5%
R798	315-0102-00	1 k Ω	$\frac{1}{4}$ W 5%
R801	315-0472-00	4.7 k Ω	$\frac{1}{4}$ W 5%
R802	315-0512-00	5.1 k Ω	$\frac{1}{4}$ W 5%
R804	315-0102-00	1 k Ω	$\frac{1}{4}$ W 5%
R806	315-0102-00	1 k Ω	$\frac{1}{4}$ W 5%
R807	315-0102-00	1 k Ω	$\frac{1}{4}$ W 5%
R811	315-0162-00	1.6 k Ω	$\frac{1}{4}$ W 5%
R812	315-0332-00	3.3 k Ω	$\frac{1}{4}$ W 5%
R813	315-0751-00	750 Ω	$\frac{1}{4}$ W 5%
R815	315-0102-00	1 k Ω	$\frac{1}{4}$ W 5%
R816	315-0102-00	1 k Ω	$\frac{1}{4}$ W 5%
R817	315-0102-00	1 k Ω	$\frac{1}{4}$ W 5%
R818	315-0302-00	3 k Ω	$\frac{1}{4}$ W 5%
R819	315-0153-00	15 k Ω	$\frac{1}{4}$ W 5%
R821	315-0103-00	10 k Ω	$\frac{1}{4}$ W 5%
R823	315-0154-00	150 k Ω	$\frac{1}{4}$ W 5%
R824	315-0102-00	1 k Ω	$\frac{1}{4}$ W 5%
R825	315-0103-00	10 k Ω	$\frac{1}{4}$ W 5%
R826	315-0102-00	1 k Ω	$\frac{1}{4}$ W 5%
R827	315-0472-00	4.7 k Ω	$\frac{1}{4}$ W 5%
R831	315-0471-00	470 Ω	$\frac{1}{4}$ W 5%
R832	315-0272-00	2.7 k Ω	$\frac{1}{4}$ W 5%
R834	315-0432-00	4.3 k Ω	$\frac{1}{4}$ W 5%
R835	311-0704-00	500 Ω , Var	
R836	315-0132-00	1.3 k Ω	$\frac{1}{4}$ W 5%
R837	315-0752-00	7.5 k Ω	$\frac{1}{4}$ W 5%
R838	315-0152-00	1.5 k Ω	$\frac{1}{4}$ W 5%
R839	315-0511-00	510 Ω	$\frac{1}{4}$ W 5%
R843	315-0512-00	5.1 k Ω	$\frac{1}{4}$ W 5%
R844	315-0333-00	33 k Ω	$\frac{1}{4}$ W 5%

SWEEP Circuit Board Assembly (cont)

Ckt. No.	Tektronix Part No.	Serial/Model No. Eff Disc	Description
Resistors (cont)			
R845	315-0152-00	1.5 k Ω	$\frac{1}{4}$ W 5%
R846	315-0682-00	6.8 k Ω	$\frac{1}{4}$ W 5%
R847	322-0205-00	1.33 k Ω	$\frac{1}{4}$ W Prec 1%
R848	321-0164-00	499 Ω	$\frac{1}{8}$ W Prec 1%
R849	315-0152-00	1.5 k Ω	$\frac{1}{4}$ W 5%
R861	315-0302-00	3 k Ω	$\frac{1}{4}$ W 5%
R862	315-0202-00	2 k Ω	$\frac{1}{4}$ W 5%
R864	315-0101-00	100 Ω	$\frac{1}{4}$ W 5%
R865	311-0827-00	250 Ω , Var	
R867	315-0151-00	150 Ω	$\frac{1}{4}$ W 5%
R871	315-0102-00	1 k Ω	$\frac{1}{4}$ W 5%
R872	315-0302-00	3 k Ω	$\frac{1}{4}$ W 5%
R873	315-0752-00	7.5 k Ω	$\frac{1}{4}$ W 5%
R874	315-0162-00	1.6 k Ω	$\frac{1}{4}$ W 5%
R881	315-0270-00	27 Ω	$\frac{1}{4}$ W 5%
R883	315-0361-00	360 Ω	$\frac{1}{4}$ W 5%
R884	322-0210-00	1.5 k Ω	$\frac{1}{4}$ W Prec 1%
R885	315-0301-00	300 Ω	$\frac{1}{4}$ W 5%
R886	315-0620-00	62 Ω	$\frac{1}{4}$ W 5%
R887	321-0164-00	499 Ω	$\frac{1}{8}$ W Prec 1%
R888	321-0194-00	1.02 k Ω	$\frac{1}{8}$ W Prec 1%
R891	315-0103-00	10 k Ω	$\frac{1}{4}$ W 5%
R892	315-0623-00	62 k Ω	$\frac{1}{4}$ W 5%
R893	315-0303-00	30 k Ω	$\frac{1}{4}$ W 5%
R896	315-0102-00	1 k Ω	$\frac{1}{4}$ W 5%
R898	301-0133-00	13 k Ω	$\frac{1}{2}$ W 5%
R899	315-0102-00	1 k Ω	$\frac{1}{4}$ W 5%
R902	315-0102-00	1 k Ω	$\frac{1}{4}$ W 5%
R903	315-0302-00	3 k Ω	$\frac{1}{4}$ W 5%
R906	315-0270-00	27 Ω	$\frac{1}{4}$ W 5%
R907	315-0202-00	2 k Ω	$\frac{1}{4}$ W 5%
R908	315-0511-00	510 Ω	$\frac{1}{4}$ W 5%
R909	315-0752-00	7.5 k Ω	$\frac{1}{4}$ W 5%
R910	315-0102-00	1 k Ω	$\frac{1}{4}$ W 5%
R913	315-0202-00	2 k Ω	$\frac{1}{4}$ W 5%
R915	315-0102-00	1 k Ω	$\frac{1}{4}$ W 5%
R917	315-0202-00	2 k Ω	$\frac{1}{4}$ W 5%
R921	315-0202-00	2 k Ω	$\frac{1}{4}$ W 5%
R922	315-0271-00	270 Ω	$\frac{1}{4}$ W 5%
R923	315-0104-00	100 k Ω	$\frac{1}{4}$ W 5%

SWEEP Circuit Board Assembly (cont)

Ckt. No.	Tektronix Part No.	Serial/Model No. Eff Disc	Description	
Resistors (cont)				
R924	315-0271-00	270 Ω	$\frac{1}{4}$ W	5%
R925	315-0104-00	100 k Ω	$\frac{1}{4}$ W	5%
R926	315-0100-00	10 Ω	$\frac{1}{4}$ W	5%
R927	315-0241-00	240 Ω	$\frac{1}{4}$ W	5%
R928	315-0682-00	6.8 k Ω	$\frac{1}{4}$ W	5%
R930	311-0732-00	1 k Ω , Var		5%
R931	315-0752-00	7.5 k Ω	$\frac{1}{4}$ W	5%
R932	315-0101-00	100 Ω	$\frac{1}{4}$ W	5%
R933	315-0752-00	7.5 k Ω	$\frac{1}{4}$ W	5%
R935	311-0831-00	100 k Ω , Var		5%
R936	315-0433-00	43 k Ω	$\frac{1}{4}$ W	5%
R937	315-0201-00	200 Ω	$\frac{1}{4}$ W	5%
R939	315-0621-00	620 Ω	$\frac{1}{4}$ W	5%
R941	315-0471-00	470 Ω	$\frac{1}{4}$ W	
R942	315-0362-00	3.6 k Ω	$\frac{1}{4}$ W	
R944	315-0302-00	3 k Ω	$\frac{1}{4}$ W	5%
R945	315-0431-00	430 Ω	$\frac{1}{4}$ W	5%
R946	315-0362-00	3.6 k Ω	$\frac{1}{4}$ W	5%
R947	315-0511-00	510 Ω	$\frac{1}{4}$ W	5%
R948	315-0202-00	2 k Ω	$\frac{1}{4}$ W	5%
R951	315-0102-00	1 k Ω	$\frac{1}{4}$ W	5%
R952	315-0102-00	1 k Ω	$\frac{1}{4}$ W	5%
R953	315-0511-00	510 Ω	$\frac{1}{4}$ W	5%
R954	315-0391-00	390 Ω	$\frac{1}{4}$ W	5%
R961	321-0260-00	4.99 k Ω	$\frac{1}{8}$ W	Prec 1%
R962	321-0268-00	6.04 k Ω	$\frac{1}{8}$ W	Prec 1%
R963	321-0268-00	6.04 k Ω	$\frac{1}{8}$ W	Prec 1%
R964	321-0260-00	4.99 k Ω	$\frac{1}{8}$ W	Prec 1%
R966	315-0242-00	2.4 k Ω	$\frac{1}{4}$ W	5%
R967	315-0391-00	390 Ω	$\frac{1}{4}$ W	5%
R968	315-0391-00	390 Ω	$\frac{1}{4}$ W	5%
R969	315-0102-00	1 k Ω	$\frac{1}{4}$ W	5%
R981	315-0243-00	24 k Ω	$\frac{1}{4}$ W	5%
R982	315-0472-00	4.7 k Ω	$\frac{1}{4}$ W	5%
R983	315-0682-00	6.8 k Ω	$\frac{1}{4}$ W	5%
R984	315-0203-00	20 k Ω	$\frac{1}{4}$ W	5%
R986	315-0472-00	4.7 k Ω	$\frac{1}{4}$ W	5%
R987	315-0103-00	10 k Ω	$\frac{1}{4}$ W	5%
R988	315-0122-00	1.2 k Ω	$\frac{1}{4}$ W	5%
R989	315-0123-00	12 k Ω	$\frac{1}{4}$ W	5%

SWEEP Circuit Board Assembly (cont)

Ckt. No.	Tektronix Part No.	Serial/Model No. Eff	Disc	Description		
Resistors (cont)						
R992	315-0683-00		68 kΩ	1/4 W		5%
R993	315-0103-00		10 kΩ	1/4 W		5%
R994	315-0623-00		62 kΩ	1/4 W		5%
R996	315-0153-00		15 kΩ	1/4 W		5%
R998	315-0102-00		1 kΩ	1/4 W		5%
R1001	321-0298-00		12.4 kΩ	1/8 W	Prec	1%
R1002	315-0623-00		62 kΩ	1/4 W		5%
R1003	315-0751-00		750 Ω	1/4 W		5%
R1005	315-0392-00		3.9 kΩ	1/4 W		5%
R1006	321-0335-00		30.1 kΩ	1/8 W	Prec	1%
R1007	321-0193-00		1 kΩ	1/8 W	Prec	1%
R1008	321-0222-07		2 kΩ	1/8 W	Prec	1/10%
R1009	321-0222-07		2 kΩ	1/8 W	Prec	1/10%
R1010	321-0356-00		49.9 kΩ	1/8 W	Prec	1%
R1012	321-0268-00		6.04 kΩ	1/8 W	Prec	1%
R1014	321-0174-00		634 Ω	1/8 W	Prec	1%
R1016	315-0561-00		560 Ω	1/4 W		5%
R1018	315-0103-00		10 kΩ	1/4 W		5%
R1019	315-0104-00		100 kΩ	1/4 W		5%
R1021	321-0327-00		24.9 kΩ	1/8 W	Prec	1%
R1022	315-0104-00		100 kΩ	1/4 W		5%
R1023	315-0103-00		10 kΩ	1/4 W		5%
R1024	315-0104-00		100 kΩ	1/4 W		5%
R1025	321-0327-00		24.9 kΩ	1/8 W	Prec	1%
R1026	315-0104-00		100 kΩ	1/4 W		5%
R1027	315-0103-00		10 kΩ	1/4 W		5%
R1028	315-0104-00		100 kΩ	1/4 W		5%
R1031	315-0273-00		27 kΩ	1/4 W		5%
R1032	315-0104-00		100 kΩ	1/4 W		5%
R1033	321-0260-00		4.99 kΩ	1/8 W	Prec	1%
R1034	315-0621-00		620 Ω	1/4 W		5%
R1036	321-0186-00		845 Ω	1/8 W	Prec	1%
R1038	321-0207-00		1.4 kΩ	1/8 W	Prec	1%
R1041	321-0220-00		1.91 kΩ	1/8 W	Prec	1%
R1042	321-0236-00		2.8 kΩ	1/8 W	Prec	1%
R1043	315-0912-00		9.1 kΩ	1/4 W		5%
R1044	321-0164-00		499 Ω	1/8 W	Prec	1%
R1045	321-0057-00		38.3 Ω	1/8 W	Prec	1%
R1046	321-0148-00		340 Ω	1/8 W	Prec	1%
R1051	315-0432-00		4.3 kΩ	1/4 W		5%
R1052	321-0222-00		2 kΩ	1/8 W	Prec	1%

SWEEP Circuit Board Assembly (cont)

Ckt. No.	Tektronix Part No.	Serial/Model No. Eff	No. Disc	Description		
Resistors (cont)						
R1053	315-0302-00		3 k Ω	1/4 W		5%
R1054	321-0153-00		383 Ω	1/8 W	Prec	1%
R1055	311-0886-00		50 Ω , Var			
R1056	321-0148-00		340 Ω	1/8 W	Prec	1%
R1059	308-0300-00		1.75 k Ω	3 W	WW	1%

Switch

Wired or Unwired				
S1055	260-1132-00		Push-pull	10 X MAG

Integrated Circuits

U736	156-0048-00	Linear Replaceable by RCA CA3046
U750	*155-0042-00	Miller integrator
U794	156-0048-00	Linear Replaceable by RCA CA3046
U834	156-0048-00	Linear Replaceable by RCA CA3046
U930	*155-0042-00	Miller integrator
U1020	156-0048-00	Linear Replaceable by RCA CA3046
U1034	156-0048-00	Linear Replaceable by RCA CA3046

DELAYED TRIGGER Circuit Board Assembly

*670-1218-00

Complete Board

Capacitors

Tolerance $\pm 20\%$ unless otherwise indicated.

C501	281-0123-00	5-25 pF, Var	Cer	100 V	
C509	283-0000-00	0.001 μ F	Cer	500 V	
C511	281-0613-00	10 pF	Cer	200 V	10%
C513	283-0000-00	0.001 μ F	Cer	500 V	
C514	283-0000-00	0.001 μ F	Cer	500 V	
C523	283-0080-00	0.022 μ F	Cer	25 V	+80%—20%
C533	283-0178-00	0.1 μ F	Cer	100 V	+80%—20%
C541	281-0508-00	12 pF	Cer	500 V	± 0.6 pF
C544	281-0508-00	12 pF	Cer	500 V	± 0.6 pF
C549	283-0080-00	0.022 μ F	Cer	25 V	+80%—20%

DELAYED TRIGGER Circuit Board Assembly (cont)

Ckt. No.	Tektronix Part No.	Serial/Model No. Eff	No. Disc	Description		
Capacitors (cont)						
C552	283-0080-00		0.022 μ F	Cer	25 V	+80%—20%
C556	283-0000-00		0.001 μ F	Cer	500 V	
C561	283-0080-00		0.022 μ F	Cer	25 V	+80%—20%
C562	283-0194-00		4.7 μ F	Cer	50 V	
C569	283-0178-00		0.1 μ F	Cer	100 V	+80%—20%
C602	283-0633-00		77 pF	Mica	100 V	1%
C614	283-0212-00		2 μ F	Cer	50 V	
C619	281-0562-00		39 pF	Cer	500 V	
C626	283-0080-00		0.022 μ F	Cer	25 V	+80%—20%
C627	283-0080-00		0.022 μ F	Cer	25 V	+80%—20%
C651	281-0513-00		27 pF	Cer	500 V	
C661	281-0513-00		27 pF	Cer	500 V	
C667	290-0136-00		2.2 μ F	Elect.	20 V	
C669	281-0613-00		10 pF	Cer	200 V	10%

Semiconductor Device, Diodes

CR503	*152-0185-00		Silicon	Replaceable by 1N4152		
CR505	*152-0185-00		Silicon	Replaceable by 1N4152		
CR523	*152-0185-00		Silicon	Replaceable by 1N4152		
CR547	*152-0185-00		Silicon	Replaceable by 1N4152		
VR601	152-0226-00		Zener	1N751A 400 mW, 5.1 V, 5%		
CR621	*152-0185-00		Silicon	Replaceable by 1N4152		
CR622	*152-0185-00		Silicon	Replaceable by 1N4152		
CR623	*152-0185-00		Silicon	Replaceable by 1N4152		
CR624	*152-0185-00		Silicon	Replaceable by 1N4152		
CR630	152-0140-01		Tunnel	8 pF, 10 mA		
CR655	*152-0185-00		Silicon	Replaceable by 1N4152		
CR670	152-0140-01		Tunnel	8 pF, 10 mA		
CR675	152-0140-01		Tunnel	8 pF, 10 mA		

Inductor

L631	*108-0420-00		60 nH
------	--------------	--	-------

Transistors

Q508A,B	151-1011-00		Silicon	FET	N channel, junction type, dual	
Q512	151-0221-00		Silicon	PNP	TO-18 2N4258	
Q516	151-0223-00		Silicon	NPN	TO-18 2N4275	
Q542	*151-0192-00		Silicon	NPN	TO-92 Replaceable by MPS 6521	
Q544	*151-0192-00		Silicon	NPN	TO-92 Replaceable by MPS 6521	

DELAYED TRIGGER Circuit Board Assembly (cont)

Ckt. No.	Tektronix Part No.	Serial/Model No. Eff	Disc	Description
Transistors (cont)				
Q552	151-0221-00		Silicon	PNP TO-18 2N4258
Q554	151-0221-00		Silicon	PNP TO-18 2N4258
Q558	151-0223-00		Silicon	NPN TO-18 2N4275
Q562	151-0207-00		Silicon	NPN TO-98 2N3415
Q602	151-0223-00		Silicon	NPN TO-18 2N4275
Q604	151-0223-00		Silicon	NPN TO-18 2N4275
Q616	151-0221-00		Silicon	PNP TO-18 2N4258
Q618	151-0221-00		Silicon	PNP TO-18 2N4258
Q628	151-0207-00		Silicon	NPN TO-98 2N3415
Q654	151-0223-00		Silicon	NPN TO-18 2N4275
Q666	151-0223-00		Silicon	NPN TO-18 2N4275

Resistors

Resistors are fixed, composition, $\pm 10\%$ unless otherwise indicated.

R501	317-0221-00	220 Ω	$\frac{1}{8}$ W		5%
R502	321-0452-00	499 k Ω	$\frac{1}{8}$ W	Prec	1%
R503	317-0562-00	5.6 k Ω	$\frac{1}{8}$ W		5%
R504	317-0202-00	2 k Ω	$\frac{1}{8}$ W		5%
R505	317-0682-00	6.8 k Ω	$\frac{1}{8}$ W		5%
R508	317-0511-00	510 Ω	$\frac{1}{8}$ W		5%
R509	315-0101-00	100 Ω	$\frac{1}{4}$ W		5%
R512	317-0102-00	1 k Ω	$\frac{1}{8}$ W		5%
R513	315-0202-00	2 k Ω	$\frac{1}{4}$ W		5%
R514	317-0510-00	51 Ω	$\frac{1}{8}$ W		5%
R516	317-0751-00	750 Ω	$\frac{1}{8}$ W		5%
R517	317-0820-00	82 Ω	$\frac{1}{8}$ W		5%
R519	317-0510-00	51 Ω	$\frac{1}{8}$ W		5%
R521	317-0392-00	3.9 k Ω	$\frac{1}{8}$ W		5%
R522	315-0183-00	18 k Ω	$\frac{1}{4}$ W		5%
R530	311-0634-00	500 Ω , Var			
R531	321-0199-00	1.15 k Ω	$\frac{1}{8}$ W	Prec	1%
R532	321-0239-00	3.01 k Ω	$\frac{1}{8}$ W	Prec	1%
R533	317-0510-00	51 Ω	$\frac{1}{8}$ W		5%
R536	317-0511-00	510 Ω	$\frac{1}{8}$ W		5%
R537	317-0511-00	510 Ω	$\frac{1}{8}$ W		5%
R539	322-0212-00	1.58 k Ω	$\frac{1}{4}$ W	Prec	1%
R541	321-0113-00	147 Ω	$\frac{1}{8}$ W	Prec	1%
R542	321-0113-00	147 Ω	$\frac{1}{8}$ W	Prec	1%
R543	322-0195-00	1.05 k Ω	$\frac{1}{4}$ W	Prec	1%

DELAYED TRIGGER Circuit Board Assembly (cont)

Ckt. No.	Tektronix Part No.	Serial/Model No. Eff	No. Disc	Description		
Resistors (cont)						
R544	321-0113-00			147 Ω	$\frac{1}{8}$ W	Prec 1%
R545	321-0113-00			147 Ω	$\frac{1}{8}$ W	Prec 1%
R546	322-0195-00			1.05 k Ω	$\frac{1}{4}$ W	Prec 1%
R547	321-0314-00			18.2 k Ω	$\frac{1}{8}$ W	Prec 1%
R548	321-0199-00			1.15 k Ω	$\frac{1}{8}$ W	Prec 1%
R549	321-0228-00			2.32 k Ω	$\frac{1}{8}$ W	Prec 1%
R550	311-0622-00			100 Ω , Var		
R551	322-0173-00			619 Ω	$\frac{1}{4}$ W	Prec 1%
R552	315-0470-00			47 Ω	$\frac{1}{4}$ W	5%
R553	322-0239-00			3.01 k Ω	$\frac{1}{4}$ W	Prec 1%
R554	322-0170-00			576 Ω	$\frac{1}{4}$ W	Prec 1%
R555	321-0205-00			1.33 k Ω	$\frac{1}{8}$ W	Prec 1%
R556	315-0101-00			100 Ω	$\frac{1}{4}$ W	5%
R558	323-0197-00			1.1 k Ω	$\frac{1}{2}$ W	Prec 1%
R561	317-0303-00			30 k Ω	$\frac{1}{8}$ W	5%
R562	317-0222-00			2.2 k Ω	$\frac{1}{8}$ W	5%
R569	315-0270-00			27 Ω	$\frac{1}{4}$ W	5%
R601	315-0101-00			100 Ω	$\frac{1}{4}$ W	5%
R602	317-0150-00			15 Ω	$\frac{1}{8}$ W	5%
R603	315-0101-00			100 Ω	$\frac{1}{4}$ W	5%
R605	317-0150-00			15 Ω	$\frac{1}{8}$ W	5%
R608	315-0162-00			1.6 k Ω	$\frac{1}{4}$ W	5%
R610	311-0607-00			10 k Ω , Var		
R611	315-0203-00			20 k Ω	$\frac{1}{4}$ W	5%
R612	315-0123-00			12 k Ω	$\frac{1}{4}$ W	5%
R614	315-0222-00			2.2 k Ω	$\frac{1}{4}$ W	5%
R616	321-0193-00			1 k Ω	$\frac{1}{8}$ W	Prec 1%
R618	321-0193-00			1 k Ω	$\frac{1}{8}$ W	Prec 1%
R619	317-0300-00			30 Ω	$\frac{1}{8}$ W	5%
R626	315-0622-00			6.2 k Ω	$\frac{1}{4}$ W	5%
R627	315-0622-00			6.2 k Ω	$\frac{1}{4}$ W	5%
R628	317-0302-00			3 k Ω	$\frac{1}{8}$ W	5%
R631	317-0330-00			33 Ω	$\frac{1}{8}$ W	5%
R632	315-0101-00			100 Ω	$\frac{1}{4}$ W	5%
R633	315-0202-00			2 k Ω	$\frac{1}{4}$ W	5%
R651	317-0470-00			47 Ω	$\frac{1}{8}$ W	5%
R653	317-0471-00			470 Ω	$\frac{1}{8}$ W	5%
R654	317-0302-00			3 k Ω	$\frac{1}{8}$ W	5%
R661	317-0470-00			47 Ω	$\frac{1}{8}$ W	5%
R662	317-0470-00			47 Ω	$\frac{1}{8}$ W	5%

DELAYED TRIGGER Circuit Board Assembly (cont)

Ckt. No.	Tektronix Part No.	Serial/Model No. Eff	No. Disc	Description
Resistors (cont)				
R663	317-0471-00		470 Ω	$\frac{1}{8}$ W 5%
R664	317-0302-00		3 k Ω	$\frac{1}{8}$ W 5%
R665	311-0634-00		500 Ω , Var	
R666	317-0821-00		820 Ω	$\frac{1}{8}$ W 5%
R667	317-0201-00		200 Ω	$\frac{1}{8}$ W 5%
R669	317-0391-00		390 Ω	$\frac{1}{8}$ W 5%
R672	317-0201-00		200 Ω	$\frac{1}{8}$ W 5%
R674	317-0470-00		47 Ω	$\frac{1}{8}$ W 5%

Integrated Circuit

U530	*155-0022-00	Monolithic
------	--------------	------------

TRIGGER MODE SWITCH Circuit Board Assembly

*670-1219-00

Complete Board

Bulbs

DS4	*150-0057-01	Incandescent, 7153AS15,, selected
DS5	*150-0093-01	Incandescent, T $\frac{3}{4}$, 5 V, selected

Semiconductor Device, Diodes

CR5	*152-0185-00	Silicon	Replaceable by 1N4152
CR6	*152-0185-00	Silicon	Replaceable by 1N4152

Switch

	Wired or Unwired		
S5 [†]	*670-1219-00	Pushbutton	MODE

[†]See Mechanical Parts List for replacement parts.

DISPLAY MODE SWITCH Circuit Board Assembly

Ckt. No.	Tektronix Part No.	Serial/Model No. Eff	No. Disc	Description
	*670-1220-00			Complete Board
				Bulb
DS12	*150-0057-01			Incandescent, 7153AS15, selected
				Switch
S12 ^s	Wired or Unwired *670-1220-00			Pushbutton DISPLAY MODE

SOURCE SWITCH Circuit Board Assembly

	*670-1221-00			Complete Board
				Bulb
DS7	*150-0057-01			Incandescent, 7153AS15, selected
				Capacitors
Tolerance $\pm 20\%$ unless otherwise indicated.				
C10	281-0123-00		5-25 pF, Var	Cer 100 V
C13	281-0661-00		0.8 pF	Cer 500 V ± 0.1 pF
				Resistors
Tolerance $\pm 20\%$ unless otherwise indicated.				
R10	315-0470-00		47 Ω	$\frac{1}{4}$ W 5%
R13	321-0448-00		453 k Ω	$\frac{1}{8}$ W Prec 1%
R14	321-0361-00		56.2 k Ω	$\frac{1}{8}$ W Prec 1%
R16	315-0470-00		47 Ω	$\frac{1}{4}$ W 5%
				Switch
S7 ^s	Wired or Unwired *670-1221-00			Pushbutton SOURCE

*See Mechanical Parts List for replacement parts.

COUPLING SWITCH Circuit Board Assembly

Ckt. No.	Tektronix Part No.	Serial/Model No. Eff	No. Disc	Description
----------	--------------------	----------------------	----------	-------------

*670-1222-00

Complete Board

Bulb

DS6	*150-0057-01			Incandescent, 7153AS15, selected
-----	--------------	--	--	----------------------------------

CapacitorTolerance $\pm 20\%$ unless otherwise indicated.

C17	283-0068-00		0.01 μF	Cer	500 V
-----	-------------	--	--------------------	-----	-------

ResistorsResistors are fixed, composition, $\pm 10\%$ unless otherwise indicated.

R17	315-0101-00		100 Ω	$\frac{1}{4}$ W	5%
R18	315-0101-00		100 Ω	$\frac{1}{4}$ W	5%

Switch

S6 ⁹	Wired or Unwired *670-1222-00		Pushbutton	COUPLING
-----------------	----------------------------------	--	------------	----------

MAIN TRIGGER Circuit Board Assembly

*670-1224-00

Complete Board

CapacitorsTolerance $\pm 20\%$ unless otherwise indicated.

C301	281-0122-00		2.5-9 pF, Var	Cer	100 V
C309	283-0000-00		0.001 μF	Cer	500 V
C311	281-0613-00		10 pF	Cer	200 V
C313	283-0000-00		0.001 μF	Cer	500 V
C314	283-0000-00		0.001 μF	Cer	500 V

⁹See Mechanical Parts List for replacement parts.

MAIN TRIGGER Circuit Board Assembly (cont)

Ckt. No.	Tektronix Part No.	Serial/Model No. Eff	No. Disc	Description		
Capacitors (cont)						
C323	283-0080-00		0.022 μ F	Cer	25 V	+80%—20%
C333	283-0178-00		0.1 μ F	Cer	100 V	+80%—20%
C341	281-0511-00		22 pF	Cer	500 V	10%
C344	281-0511-00		22 pF	Cer	500 V	10%
C349	283-0080-00		0.022 μ F	Cer	25 V	+80%—20%
C357	283-0080-00		0.022 μ F	Cer	25 V	+80%—20%
C361	283-0080-00		0.022 μ F	Cer	25 V	+80%—20%
C362	283-0051-00		0.0033 μ F	Cer	100 V	5%
C363	283-0080-00		0.022 μ F	Cer	25 V	+80%—20%
C364	283-0194-00		4.7 μ F	Cer	50 V	
C366	283-0080-00		0.022 μ F	Cer	25 V	+80%—20%
C367	283-0169-00		0.022 μ F	Cer	200 V	10%
C369	283-0178-00		0.1 μ F	Cer	100 V	+80%—20%
C402	283-0633-00		77 pF	Mica	100 V	1%
C414	283-0212-00		2 μ F	Cer	50 V	
C419	281-0516-00		39 pF	Cer	500 V	10%
C426	283-0080-00		0.022 μ F	Cer	25 V	+80%—20%
C427	283-0080-00		0.022 μ F	Cer	25 V	+80%—20%
C441	281-0518-00		47 pF	Cer	500 V	
C443	290-0263-00		2.7 μ F	Elect.	15 V	
C447	290-0267-00		1 μ F	Elect.	35 V	
C451	281-0513-00		27 pF	Cer	500 V	
C457	290-0246-00		3.3 μ F	Elect.	15 V	10%
C461	281-0513-00		27 pF	Cer	500 V	
C467	290-0136-00		2.2 μ F	Elect.	20 V	
C469	281-0525-00		470 pF	Cer	500 V	

Semiconductor Device, Diodes

CR303	*152-0185-00	Silicon	Replaceable by 1N4152
CR305	*152-0185-00	Silicon	Replaceable by 1N4152
CR323	*152-0185-00	Silicon	Replaceable by 1N4152
CR347	*152-0185-00	Silicon	Replaceable by 1N4152
VR401	152-0226-00	Zener	1N751A 400 mW, 5.1 V, 5%
CR421	*152-0185-00	Silicon	Replaceable by 1N4152
CR422	*152-0185-00	Silicon	Replaceable by 1N4152
CR423	*152-0185-00	Silicon	Replaceable by 1N4152
CR424	*152-0185-00	Silicon	Replaceable by 1N4152
CR430	152-0140-01	Tunnel	8 pF, 10 mA
CR442	*152-0185-00	Silicon	Replaceable by 1N4152
CR455	*152-0185-00	Silicon	Replaceable by 1N4152
CR470	152-0140-00	Tunnel	8 pF, 10 mA
CR475	152-0140-00	Tunnel	8 pF, 10 mA

MAIN TRIGGER Circuit Board Assembly (cont)

Ckt. No.	Tektronix Part No.	Serial/Model No. Eff	No. Disc	Description		
Inductors						
L431	*108-0420-00			60 nH		
L432	276-0507-00			Core, ferramic suppressor		
Transistors						
Q308	151-1011-00			Silicon		FET, N channel, junction type, dual
Q312	151-0221-00			Silicon	PNP	TO-18 2N4258
Q316	151-0223-00			Silicon	NPN	TO-18 2N4275
Q342	*151-0192-00			Silicon		Replaceable by MPS 6521
Q344	*151-0192-00			Silicon		Replaceable by MPS 6521
Q352	151-0221-00			Silicon	PNP	TO-18 2N4258
Q354	151-0221-00			Silicon	PNP	TO-18 2N4258
Q358	151-0223-00			Silicon	NPN	TO-18 2N4275
Q362	151-0207-00			Silicon	NPN	TO-98 2N3415
Q354	151-0207-00			Silicon	NPN	TO-98 2N3415
Q366	151-0207-00			Silicon	NPN	TO-98 2N3415
Q402	151-0223-00			Silicon	NPN	TO-18 2N4275
Q404	151-0223-00			Silicon	NPN	TO-18 2N4275
Q408	151-0207-00			Silicon	NPN	TO-98 2N3415
Q416	151-0221-00			Silicon	PNP	TO-18 2N4258
Q418	151-0221-00			Silicon	PNP	TO-18 2N4258
Q428	151-0207-00			Silicon	NPN	TO-98 2N3415
Q434	*151-0259-00			Silicon	NPN	TO-106 Selected from 2N3563
Q442	151-0223-00			Silicon	NPN	TO-18 2N4275
Q448	151-0223-00			Silicon	NPN	TO-18 2N4275
Q454	151-0223-00			Silicon	NPN	TO-18 2N4275
Q466	151-0223-00			Silicon	NPN	TO-18 2N4275
Resistors						
Resistors are fixed, composition, $\pm 10\%$ unless otherwise indicated.						
R301	317-0221-00			220 Ω	$\frac{1}{8}$ W	5%
R302	321-0452-00			499 k Ω	$\frac{1}{8}$ W	1% Prec
R303	317-0562-00			5.6 k Ω	$\frac{1}{8}$ W	5%
R304	317-0202-00			2 k Ω	$\frac{1}{8}$ W	5%
R305	317-0682-00			6.8 k Ω	$\frac{1}{8}$ W	5%
R308	317-0511-00			510 Ω	$\frac{1}{8}$ W	5%
R309	317-0101-00			100 Ω	$\frac{1}{8}$ W	5%
R312	315-0102-00			1 k Ω	$\frac{1}{4}$ W	5%
R313	315-0202-00			2 k Ω	$\frac{1}{4}$ W	5%
R314	315-0510-00			51 Ω	$\frac{1}{4}$ W	5%

MAIN TRIGGER Circuit Board Assembly (cont)

Ckt. No.	Tektronix Part No.	Serial/Model No. Eff	No. Disc	Description		
Resistors (cont)						
R316	315-0751-00		750 Ω	$\frac{1}{4}$ W		5%
R317	315-0820-00		82 Ω	$\frac{1}{4}$ W		5%
R319	315-0510-00		51 Ω	$\frac{1}{4}$ W		5%
R321	315-0392-00		3.9 k Ω	$\frac{1}{4}$ W		5%
R323	315-0183-00		18 k Ω	$\frac{1}{4}$ W		5%
R330	311-0634-00		500 Ω , Var			
R331	321-0199-00		1.15 k Ω	$\frac{1}{8}$ W	Prec	1%
R332	321-0239-00		3.01 k Ω	$\frac{1}{8}$ W	Prec	1%
R333	315-0510-00		51 Ω	$\frac{1}{4}$ W		5%
R336	321-0072-00		54.9 Ω	$\frac{1}{8}$ W	Prec	1%
R337	321-0072-00		54.9 Ω	$\frac{1}{8}$ W	Prec	1%
R339	322-0212-00		1.58 k Ω	$\frac{1}{4}$ W	Prec	1%
R341	321-0113-00		147 Ω	$\frac{1}{8}$ W	Prec	1%
R342	321-0113-00		147 Ω	$\frac{1}{8}$ W	Prec	1%
R343	322-0195-00		1.05 k Ω	$\frac{1}{4}$ W	Prec	1%
R344	321-0113-00		147 Ω	$\frac{1}{8}$ W	Prec	1%
R345	321-0113-00		147 Ω	$\frac{1}{8}$ W	Prec	1%
R346	322-0195-00		1.05 k Ω	$\frac{1}{4}$ W	Prec	1%
R347	321-0314-00		18.2 k Ω	$\frac{1}{8}$ W	Prec	1%
R348	321-0199-00		1.15 k Ω	$\frac{1}{8}$ W	Prec	1%
R349	321-0228-00		2.32 k Ω	$\frac{1}{8}$ W	Prec	1%
R350	311-0622-00		100 Ω , Var			
R351	322-0175-00		649 Ω	$\frac{1}{4}$ W	Prec	1%
R353	322-0239-00		3.01 k Ω	$\frac{1}{4}$ W	Prec	1%
R354	322-0172-00		604 Ω	$\frac{1}{4}$ W	Prec	1%
R355	321-0211-00		1.54 k Ω	$\frac{1}{8}$ W	Prec	1%
R357	315-0101-00		100 Ω	$\frac{1}{4}$ W		5%
R358	323-0197-00		1.1 k Ω	$\frac{1}{2}$ W	Prec	1%
R359	315-0510-00		51 Ω	$\frac{1}{4}$ W		5%
R361	317-0303-00		30 k Ω	$\frac{1}{8}$ W		5%
R363	317-0303-00		30 k Ω	$\frac{1}{8}$ W		5%
R364	315-0222-00		2.2 k Ω	$\frac{1}{4}$ W		5%
R366	317-0103-00		10 k Ω	$\frac{1}{8}$ W		5%
R369	317-0270-00		27 Ω	$\frac{1}{8}$ W		5%
R401	315-0101-00		100 Ω	$\frac{1}{4}$ W		5%
R402	317-0150-00		15 Ω	$\frac{1}{8}$ W		5%
R403	315-0101-00		100 Ω	$\frac{1}{4}$ W		5%
R404	317-0150-00		15 Ω	$\frac{1}{8}$ W		5%
R406	315-0203-00		20 k Ω	$\frac{1}{4}$ W		5%
R407	315-0102-00		1 k Ω	$\frac{1}{4}$ W		5%

MAIN TRIGGER Circuit Board Assembly (cont)

Ckt. No.	Tektronix Part No.	Serial/Model No. Eff	No. Disc	Description		
Resistors (cont)						
R408	315-0162-00		1.6 k Ω	1/4 W		5%
R410	311-0607-00		10 k Ω , Var			
R411	315-0203-00		20 k Ω	1/4 W		5%
R412	315-0123-00		12 k Ω	1/4 W		5%
R414	315-0222-00		2.2 k Ω	1/4 W		5%
R416	321-0193-00		1 k Ω	1/8 W	Prec	1%
R418	321-0193-00		1 k Ω	1/8 W	Prec	1%
R419	317-0300-00		30 Ω	1/8 W		5%
R426	315-0622-00		6.2 k Ω	1/4 W		5%
R427	315-0622-00		6.2 k Ω	1/4 W		5%
R428	317-0302-00		3 k Ω	1/8 W		5%
R431	317-0360-00		36 Ω	1/8 W		5%
R432	315-0101-00		100 Ω	1/4 W		5%
R433	315-0202-00		2 k Ω	1/4 W		5%
R434	315-0331-00		330 Ω	1/4 W		5%
R436	315-0202-00		2 k Ω	1/4 W		5%
R41	317-0301-00		300 Ω	1/8 W		5%
R442	317-0303-00		30 k Ω	1/8 W		5%
R444	317-0183-00		18 k Ω	1/8 W		5%
R445	317-0131-00		130 Ω	1/8 W		5%
R447	315-0101-00		100 Ω	1/4 W		5%
R448	315-0152-00		1.5 k Ω	1/4 W		5%
R451	317-0470-00		47 Ω	1/8 W		5%
R453	315-0471-00		470 Ω	1/4 W		5%
R454	317-0202-00		2 k Ω	1/8 W		5%
R455	311-0634-00		500 Ω , Var			
R456	321-0204-00		1.3 k Ω	1/8 W	Prec	1%
R457	315-0101-00		100 Ω	1/4 W		5%
R461	317-0470-00		47 Ω	1/8 W		5%
R462	317-0470-00		47 Ω	1/8 W		5%
R463	317-0202-00		2 k Ω	1/8 W		5%
R464	315-0471-00		470 Ω	1/4 W		5%
R465	311-0634-00		500 Ω , Var			
R466	315-0821-00		820 Ω	1/4 W		5%
R467	315-0201-00		200 Ω	1/4 W		5%
R469	315-0391-00		390 Ω	1/4 W		5%
R472	317-0201-00		200 Ω	1/8 W		5%
R474	317-0470-00		47 Ω	1/8 W		5%

Integrated Circuit

U330	*155-0022-00	Monolithic
------	--------------	------------

DELAYED TRIGGER SWITCH Circuit Board Assembly

Ckt. No.	Tektronix Part No.	Serial/Model No. Eff	No. Disc	Description
----------	--------------------	----------------------	----------	-------------

*670-1225-00

Complete Board

Bulbs

DS16	*150-0048-01			Incandescent, #683, selected
DS17	*150-0048-01			Incandescent, #683, selected
DS18	*150-0048-01			Incandescent, #683, selected

Capacitor

Tolerance $\pm 20\%$ unless otherwise indicated.

C53	283-0068-00		0.01 μ F	Cer	500 V
-----	-------------	--	--------------	-----	-------

Resistors

Resistors are fixed, composition, $\pm 10\%$ unless otherwise indicated.

R53	317-0101-00		100 Ω	$\frac{1}{8}$ W	5%
R56	317-0101-00		100 Ω	$\frac{1}{8}$ W	5%

Switches

Wired or Unwired

S16 } S17 } S18 }	260-1133-00		Push-push	SLOPE COUPLING SOURCE
-------------------------	-------------	--	-----------	-----------------------------

READOUT Circuit Board Assembly

*670-1226-00

Complete Board

Semiconductor Device, Diodes

CR202	*152-0075-00		Germanium	Tek Spec
CR203	*152-0075-00		Germanium	Tek Spec
CR204	*152-0075-00		Germanium	Tek Spec
CR205	*152-0075-00		Germanium	Tek Spec
CR206	*152-0075-00		Germanium	Tek Spec

READOUT Circuit Board Assembly (cont)

Ckt. No.	Tektronix Part No.	Serial/Model No. Eff	Disc	Description
Semiconductor Device, Diodes (cont)				
CR207	*152-0075-00		Germanium	Tek Spec
CR208	*152-0075-00		Germanium	Tek Spec
CR218	*152-0075-00		Germanium	Tek Spec
CR219	*152-0075-00		Germanium	Tek Spec
CR220	*152-0075-00		Germanium	Tek Spec
CR221	*152-0075-00		Germanium	Tek Spec
CR222	*152-0075-00		Germanium	Tek Spec
CR223	*152-0075-00		Germanium	Tek Spec
CR224	*152-0075-00		Germanium	Tek Spec

INTERFACE READOUT Circuit Board Assembly

*672-0411-00

Complete Board

Resistor

Resistors are fixed, composition, $\pm 10\%$ unless otherwise indicated.

R11 ¹⁰	311-1017-01	20 k Ω , Var
-------------------	-------------	---------------------

Switches

	Wired or Unwired		
S10A ¹¹	*672-0411-00	Cam	TIME/DIV
S10B ¹¹	*672-0411-00	Cam	DL'Y TIME
S11 ¹²	311-1017-01	Main Variable	DELAYED SWEEP

¹⁰Furnished as a unit with S11.¹¹See Mechanical Parts List for replacement parts.¹²Furnished as a unit with R11.

SECTION 7

DIAGRAMS

MECHANICAL and REPACKAGING

PARTS ILLUSTRATIONS

The following special symbols are used in the Diagrams for this manual:

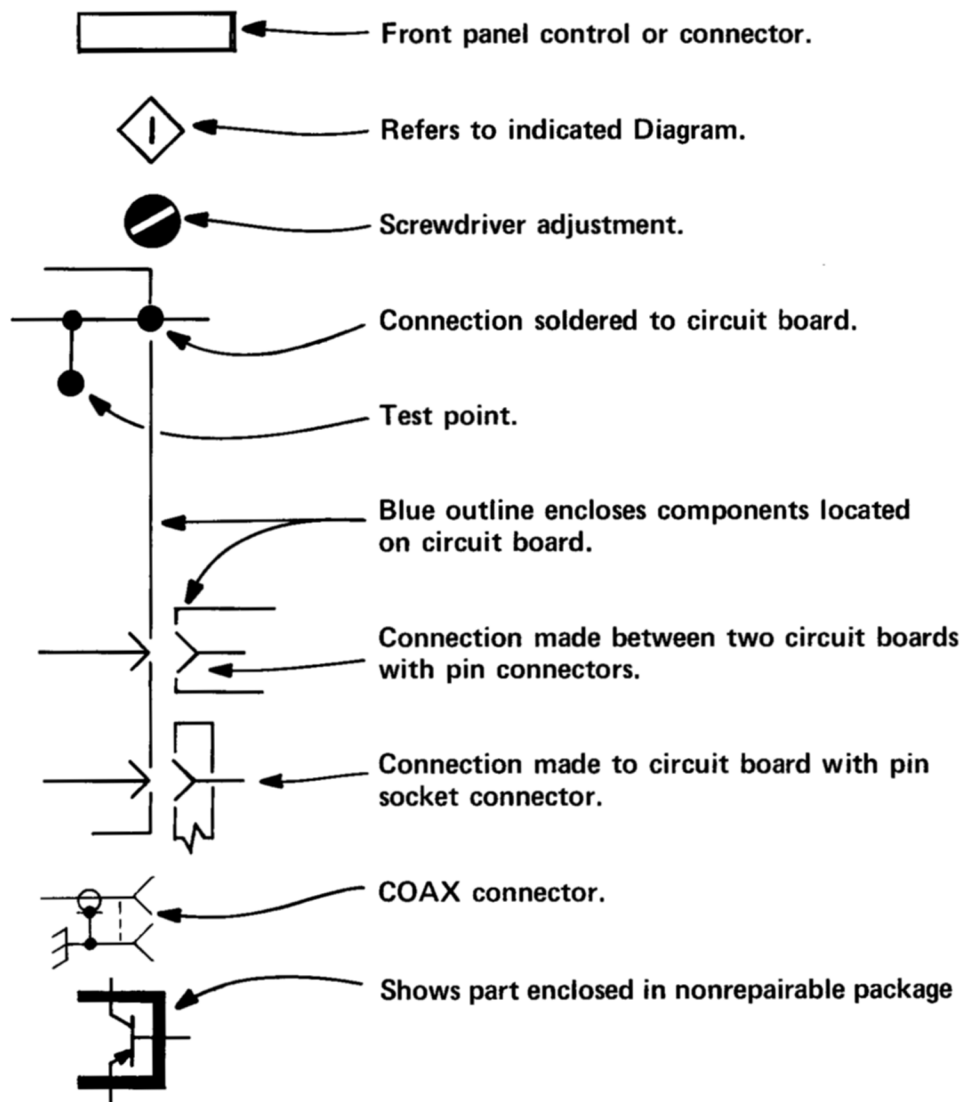

VOLTAGE AND WAVEFORM TEST CONDITIONS

Voltage measurements and waveform photographs were obtained under the following conditions unless otherwise noted on the individual diagrams.

A 7504 Oscilloscope and a Tektronix C-12 Oscilloscope camera were used to obtain the waveform photographs. The 7504 served to power the 7B52 while simultaneously supplying the waveform display (with time and amplitude readout) for photographs. (Readout on photographs has been enlarged to aid in reading.)

7504 Oscilloscope

FOCUS	Optimum
INTENSITY (both)	As desired
CALIBRATOR controls	As is
VERTICAL MODE	LEFT
HORIZONTAL MODE	A
A TRIGGER SOURCE	RIGHT VERT
B TRIGGER SOURCE	RIGHT VERT
CONTROL ILLUM	As desired
READOUT	As desired

7A13 (LEFT VERT Compartment)

With 10X Probe, Test Vertical Amplifier

+INPUT	DC (Connect 10X Probe)
-INPUT	V _c
BW	FULL
VOLTS/DIV	As shown on waveform.
COMPARISON VOLTAGE	As shown for centerline on waveform.

7A16 (RIGHT VERT Compartment)

POLARITY	+UP
BANDWIDTH	FULL
AC-GND-DC	DC
VOLTS/DIV	1
INPUT	Connected to 1 kHz sine-wave oscillator set for a 6 division display. A General Radio Type 1310-A was used for waveform photographs.

7B51 (A HORIZ Compartment)

LEVEL/SLOPE	0/+
TRIGGERING	
MODE	P-P AUTO
COUPLING	AC
SOURCE	INT
MAGNIFIER	X1
TIME/DIV	As shown on waveform.
B DELAY MODE	INDEPENDENT

7B52 (B HORIZ Compartment)

MAIN TRIGGERING	
LEVEL/SLOPE	0/+
MODE	AUTO
COUPLING	AC
SOURCE	INT
X10 MAG	Off
DISPLAY MODE	MIXED
DL'Y TIME	.5 ms
DLY'D SWEEP	50 μ s
DLY'D TRIGGERING	
LEVEL	OUT-Centered
SLOPE	+
COUPLING	AC
SOURCE	INT
DELAY TIME MULT	5.00

Voltmeter

Type	Digital Multimeter
Input Impedance	1 kM Ω on the 0-1.5 V range. 10 M Ω on the higher ranges.
Accuracy	0.1%
Ranges	0-1.5 V, 0-15 V, 0-150 V, and 0-1 kV.
Type used for voltages on diagrams	Fairchild Model 7050 Digital Multimeter.

Voltages and Waveforms on the diagrams (shown in blue) are not absolute and may vary between instruments because of component tolerances and internal calibration.

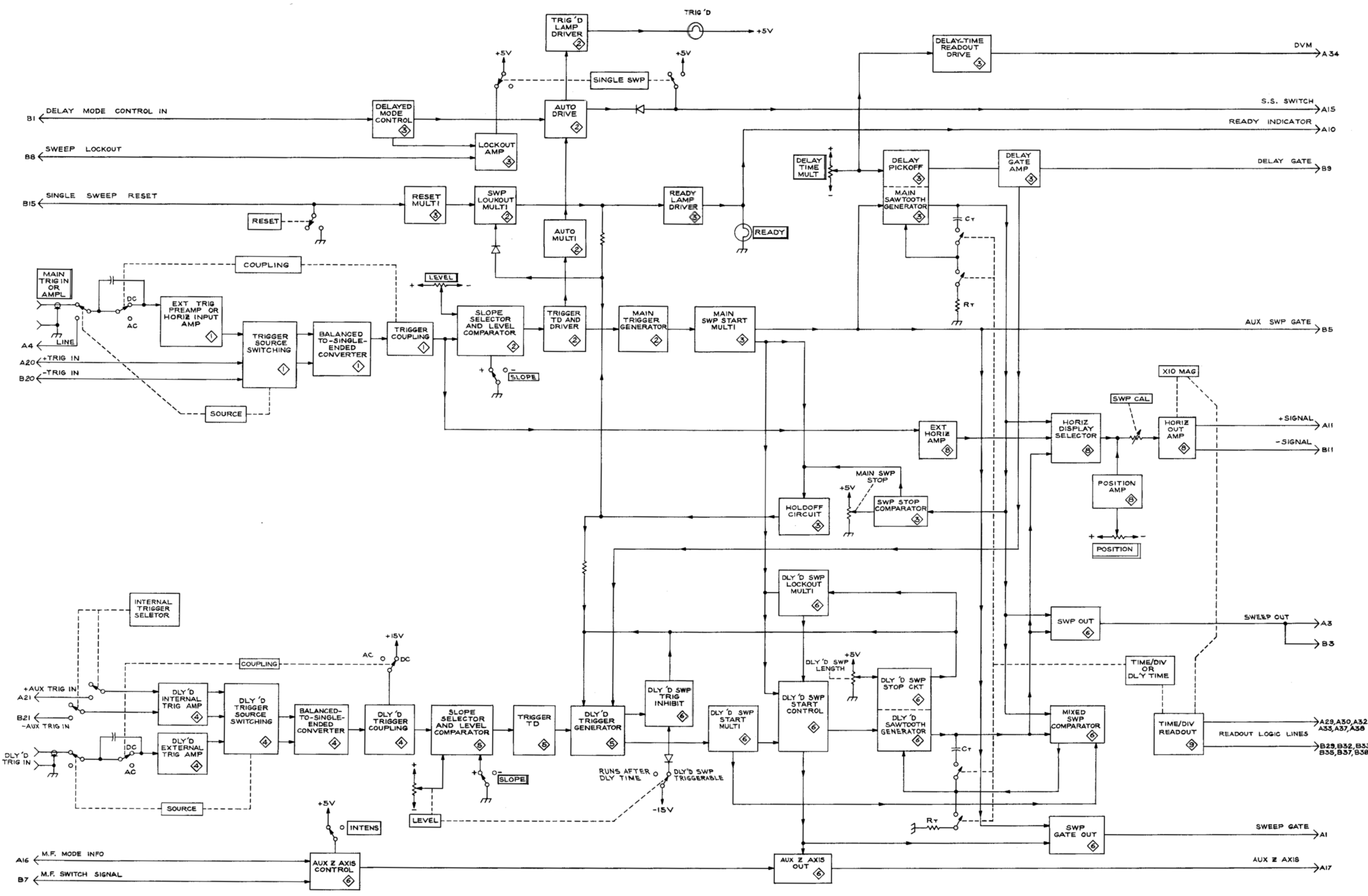

7B52 DUAL TIME BASE

1

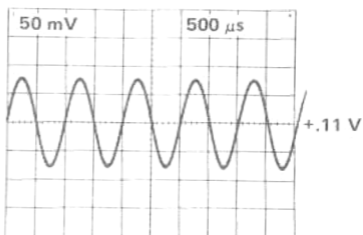

2

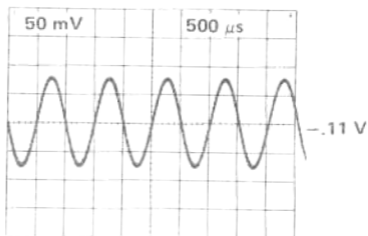

3

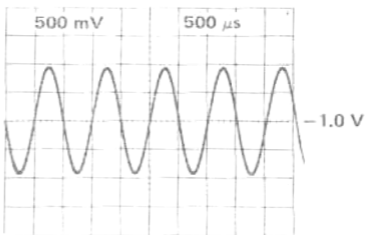

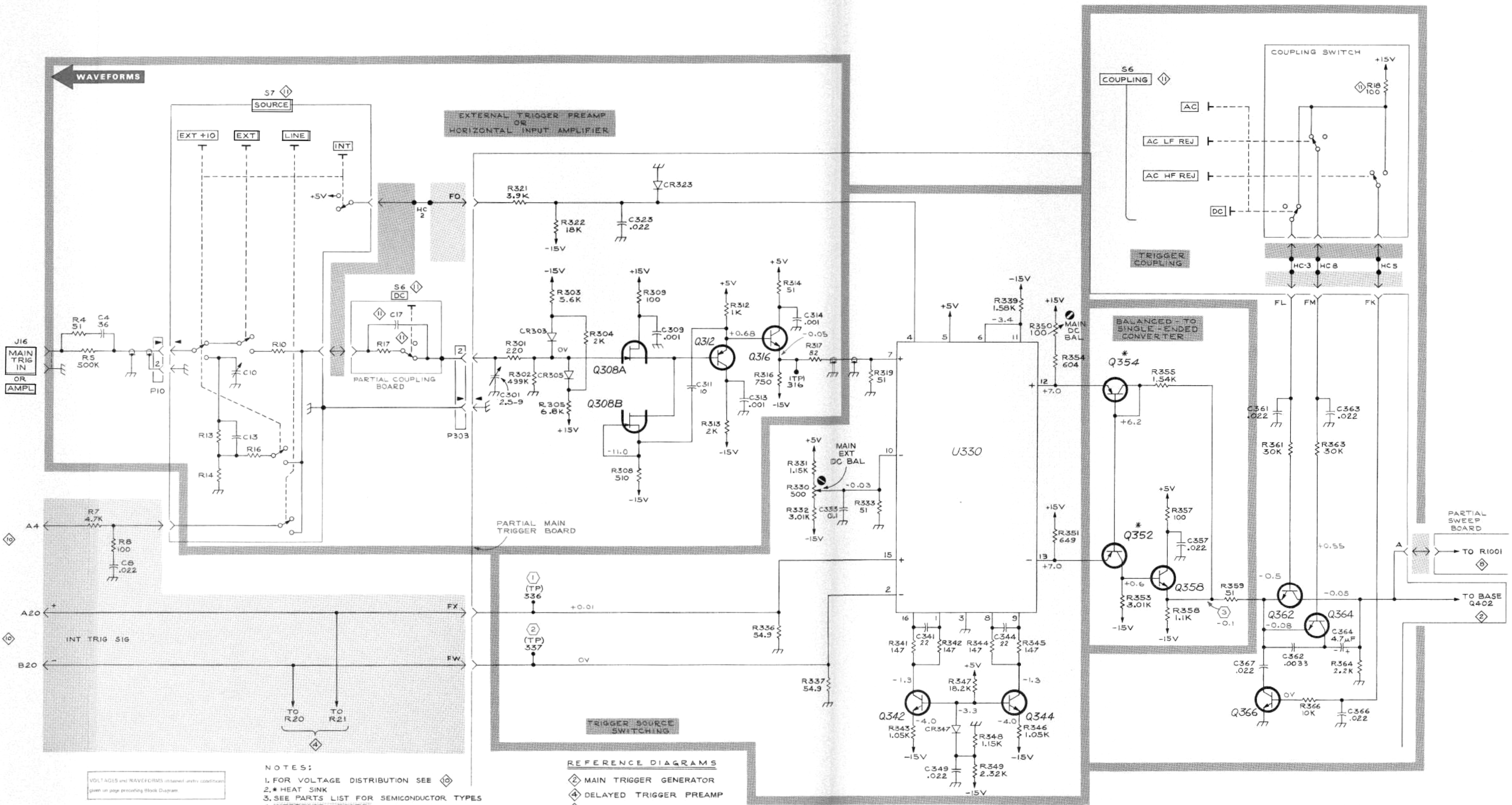

WAVEFORMS

- NOTES:
1. FOR VOLTAGE DISTRIBUTION SEE ⑩
 2. * HEAT SINK
 3. SEE PARTS LIST FOR SEMICONDUCTOR TYPES
 4. INTERFACE BOARD
 5. DISTRIBUTION BOARD

- REFERENCE DIAGRAMS
- ② MAIN TRIGGER GENERATOR
 - ④ DELAYED TRIGGER PREAMP
 - ⑥ HORIZONTAL PREAMP
 - ⑩ VOLTAGE DISTRIBUTION & OUTPUT CONNECTORS
 - ① TRIGGER SWITCHING

VOLTAGES and WAVEFORMS obtained under conditions given on page preceding Block Diagram

1

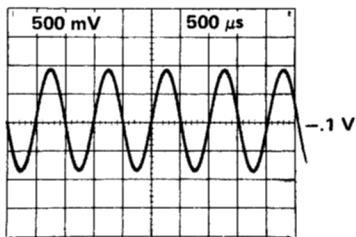

2

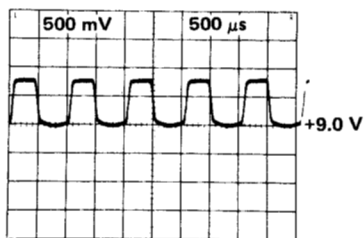

3

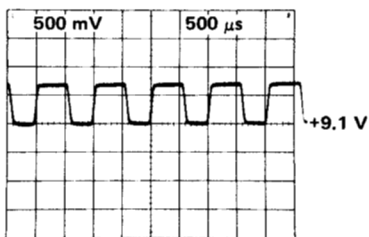

4

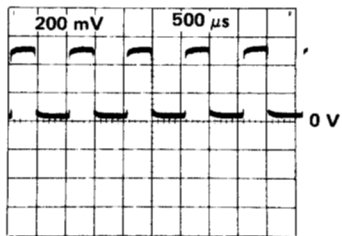

5

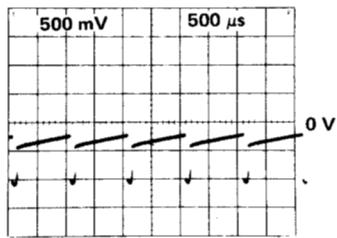

6

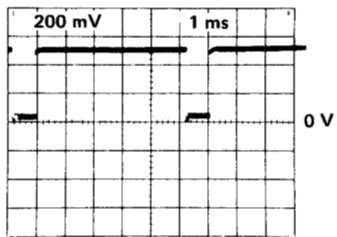

7

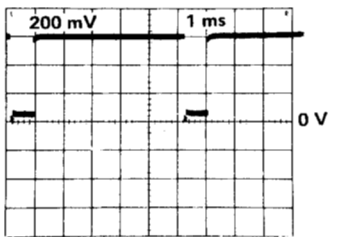

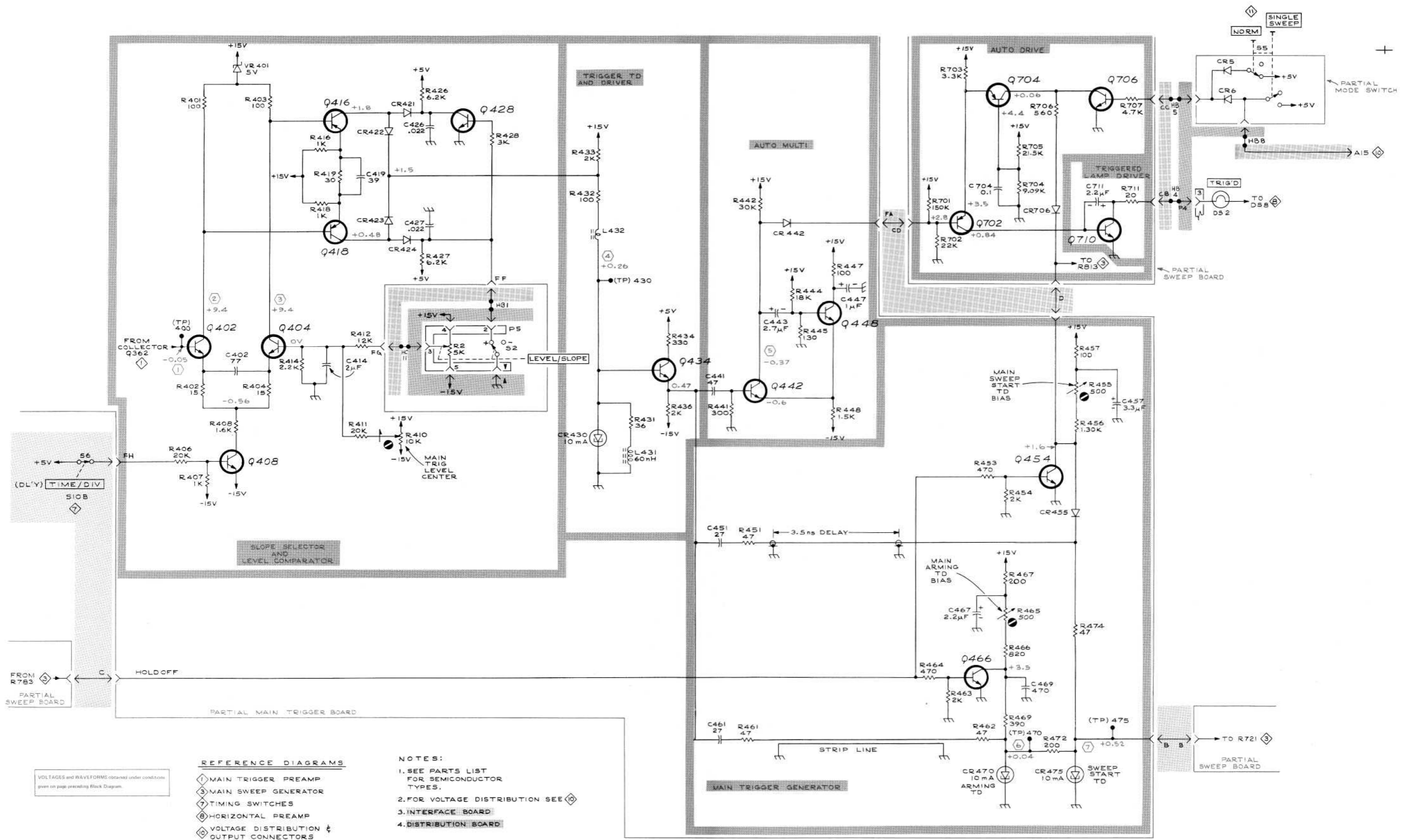

VOLTAGES and WAVEFORMS obtained under conditions given on page preceding Block Diagram.

REFERENCE DIAGRAMS

- ① MAIN TRIGGER PREAMP
- ② MAIN SWEEP GENERATOR
- ③ TIMING SWITCHES
- ④ HORIZONTAL PREAMP
- ⑤ VOLTAGE DISTRIBUTION & OUTPUT CONNECTORS
- ⑥ TRIGGER SWITCHING

NOTES:

1. SEE PARTS LIST FOR SEMICONDUCTOR TYPES.
2. FOR VOLTAGE DISTRIBUTION SEE ⑤
3. INTERFACE BOARD
4. DISTRIBUTION BOARD

1

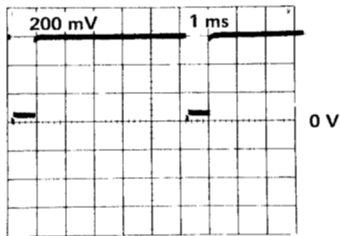

2

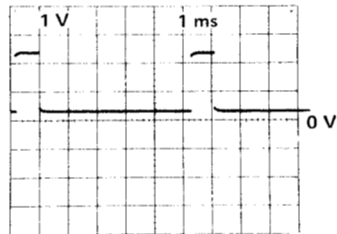

3

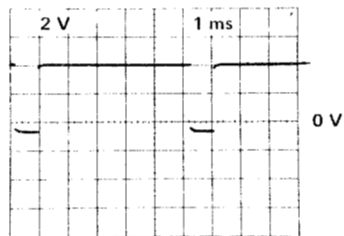

4

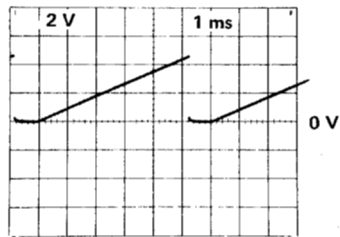

5

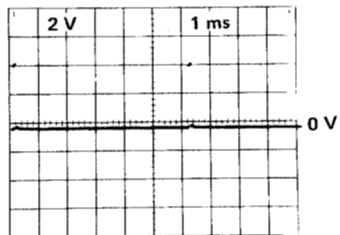

6

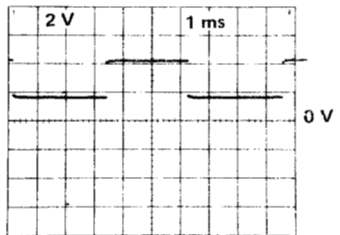

7

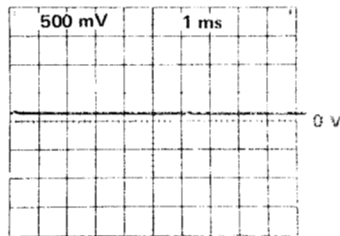

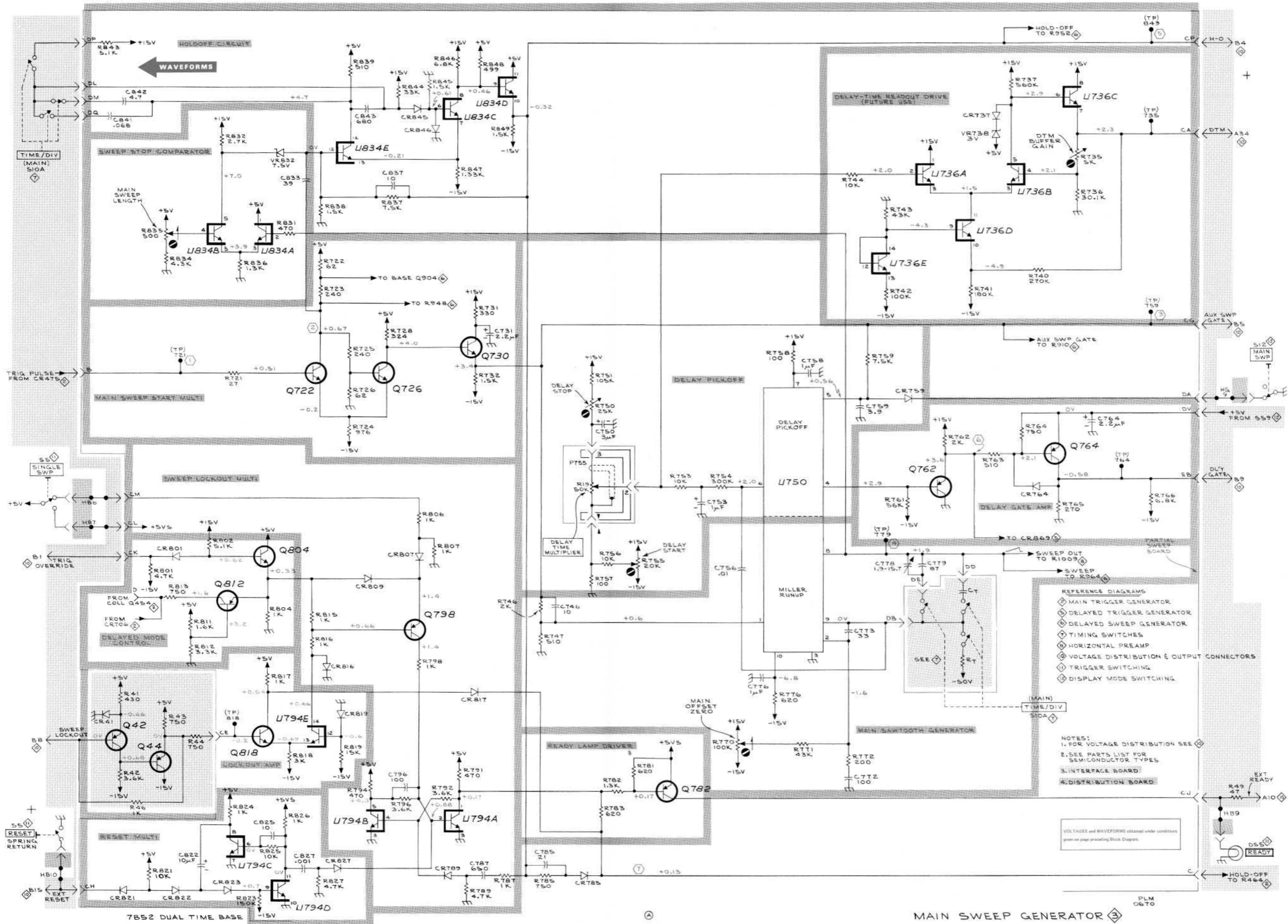

- REFERENCE DIAGRAMS**
- ◆ MAIN TRIGGER GENERATOR
 - ◆ DELAYED TRIGGER GENERATOR
 - ◆ DELAYED SWEEP GENERATOR
 - ◆ TIMING SWITCHES
 - ◆ HORIZONTAL PREAMP
 - ◆ VOLTAGE DISTRIBUTION & OUTPUT CONNECTORS
 - ◆ TRIGGER SWITCHING
 - ◆ DISPLAY MODE SWITCHING

- NOTES:**
1. FOR VOLTAGE DISTRIBUTION SEE
 2. SEE PARTS LIST FOR SEMICONDUCTOR TYPES
 3. INTERFACE BOARD
 4. DISTRIBUTION BOARD

VOLTAGES and WAVEFORMS obtained under conditions given on page preceding Block Diagram.

1

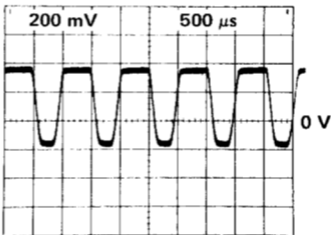

2

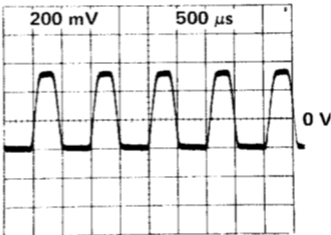

3

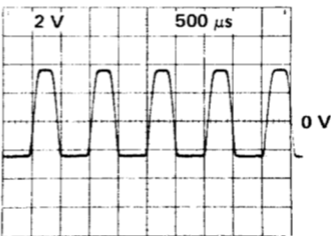

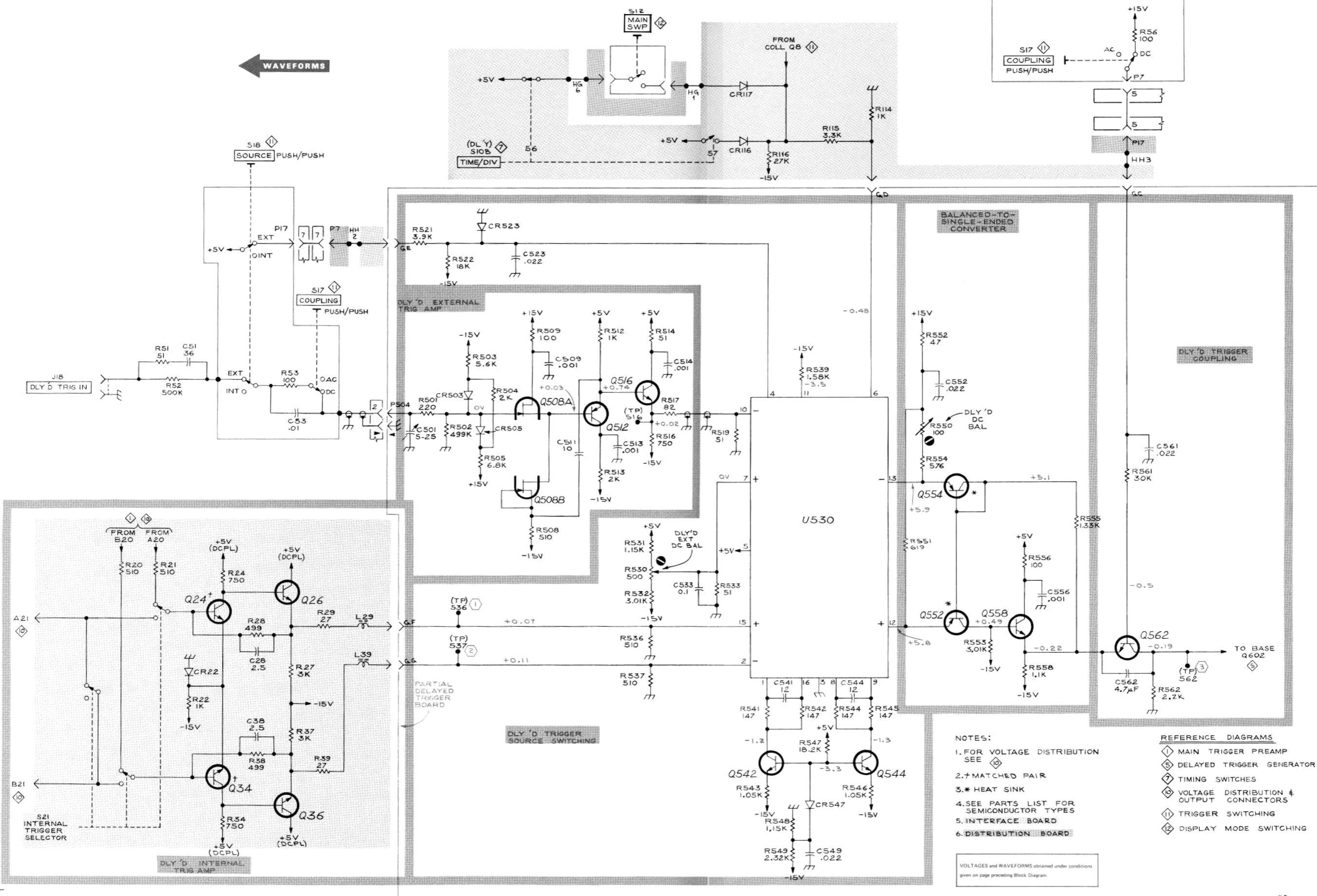

← WAVEFORMS

- NOTES:
1. FOR VOLTAGE DISTRIBUTION SEE [Symbol]
 2. † MATCHED PAIR
 3. * HEAT SINK
 4. SEE PARTS LIST FOR SEMICONDUCTOR TYPES
 5. INTERFACE BOARD
 6. DISTRIBUTION BOARD

- REFERENCE DIAGRAMS
- [Symbol] MAIN TRIGGER PREAMP
 - [Symbol] DELAYED TRIGGER GENERATOR
 - [Symbol] TIMING SWITCHES
 - [Symbol] VOLTAGE DISTRIBUTION & OUTPUT CONNECTORS
 - [Symbol] TRIGGER SWITCHING
 - [Symbol] DISPLAY MODE SWITCHING

VOLTAGES and WAVEFORMS obtained under conditions given on page preceding Block Diagram.

1

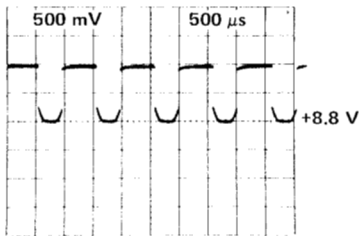

4

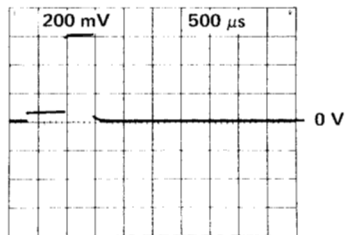

2

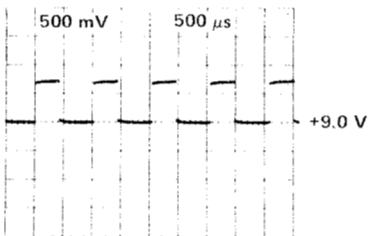

5

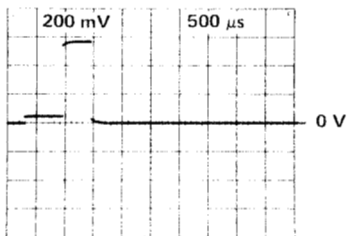

3

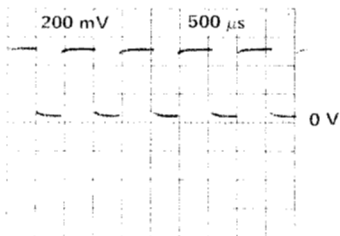

6

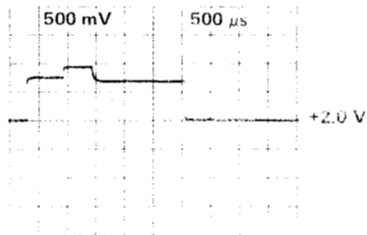

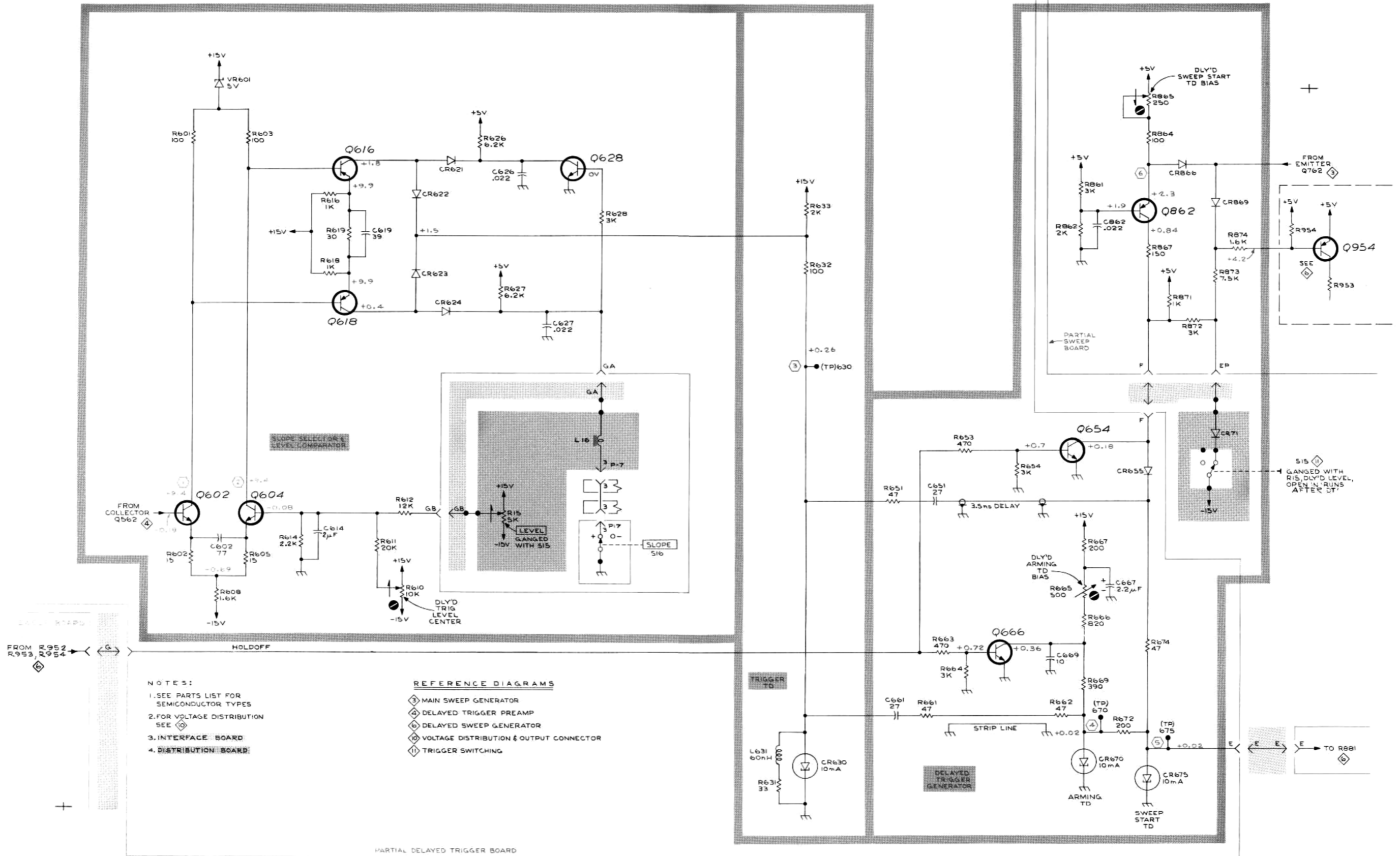

FROM R952, R954

- NOTES:**
1. SEE PARTS LIST FOR SEMICONDUCTOR TYPES
 2. FOR VOLTAGE DISTRIBUTION SEE ④
 3. INTERFACE BOARD
 4. DISTRIBUTION BOARD

- REFERENCE DIAGRAMS**
- ③ MAIN SWEEP GENERATOR
 - ④ DELAYED TRIGGER PREAMP
 - ⑤ DELAYED SWEEP GENERATOR
 - ⑥ VOLTAGE DISTRIBUTION & OUTPUT CONNECTOR
 - ⑦ TRIGGER SWITCHING

1

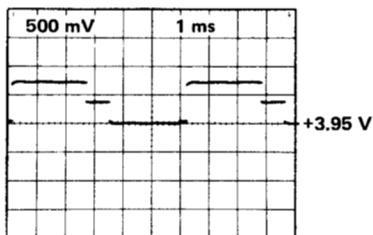

4

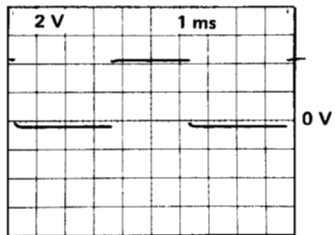

2

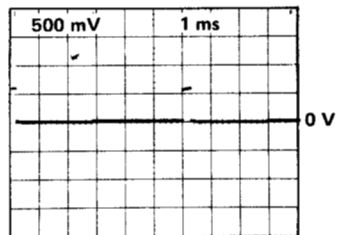

5

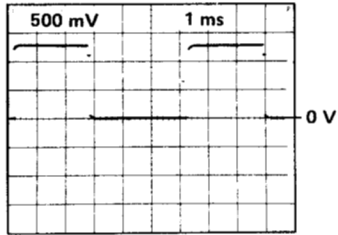

3

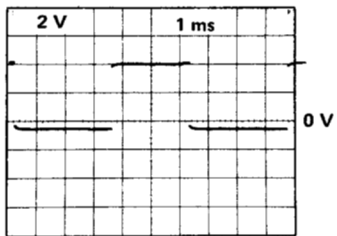

6

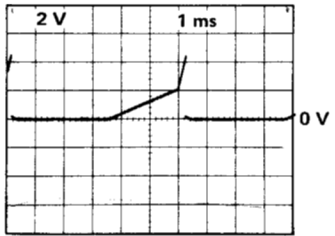

7

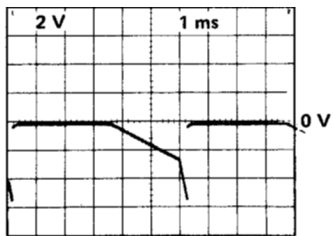

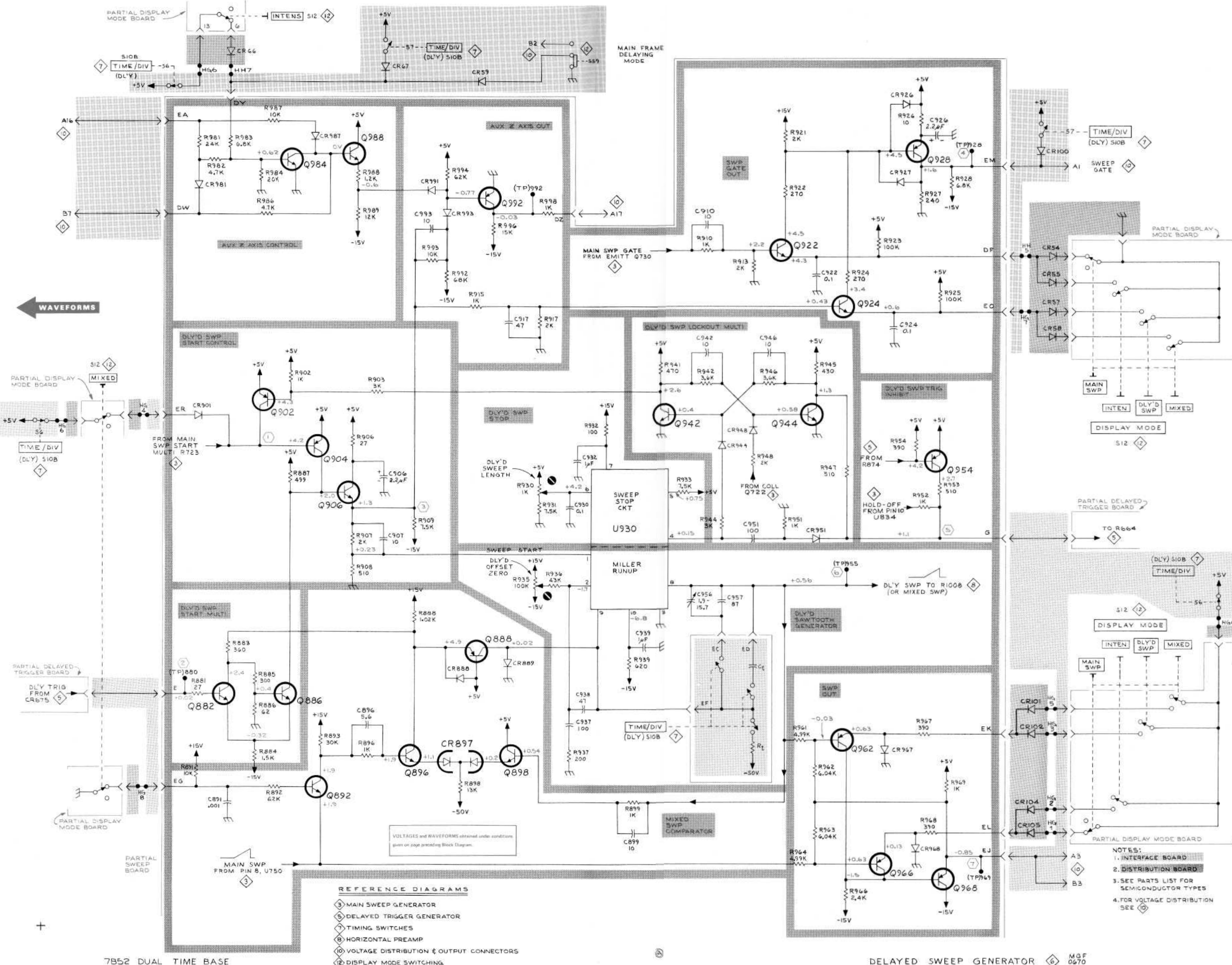

- REFERENCE DIAGRAMS**
- ① MAIN SWEEP GENERATOR
 - ② DELAYED TRIGGER GENERATOR
 - ③ TIMING SWITCHES
 - ④ HORIZONTAL PREAMP
 - ⑤ VOLTAGE DISTRIBUTION & OUTPUT CONNECTORS
 - ⑥ DISPLAY MODE SWITCHING

- NOTES:**
- 1. INTERFACE BOARD
 - 2. DISTRIBUTION BOARD
 - 3. SEE PARTS LIST FOR SEMICONDUCTOR TYPES
 - 4. FOR VOLTAGE DISTRIBUTION SEE ⑤

VOLTAGES and WAVEFORMS obtained under conditions given on page preceding Block Diagram.



REFERENCE DIAGRAMS

- ② MAIN TRIGGER GENERATOR
- ③ MAIN SWEEP GENERATOR
- ④ DELAYED TRIGGER PREAMP
- ⑥ DELAYED SWEEP GENERATOR
- ⑧ HORIZONTAL PREAMP
- ⑨ TIME/DIV READOUT SWITCHING
- ⑩ VOLTAGE DISTRIBUTION & OUTPUT CONNECTORS
- ⑫ DISPLAY MODE SWITCHING

NOTES:
 1. ● CAM SWITCH IN CLOSED POSITION
 2. INTERFACE BOARD

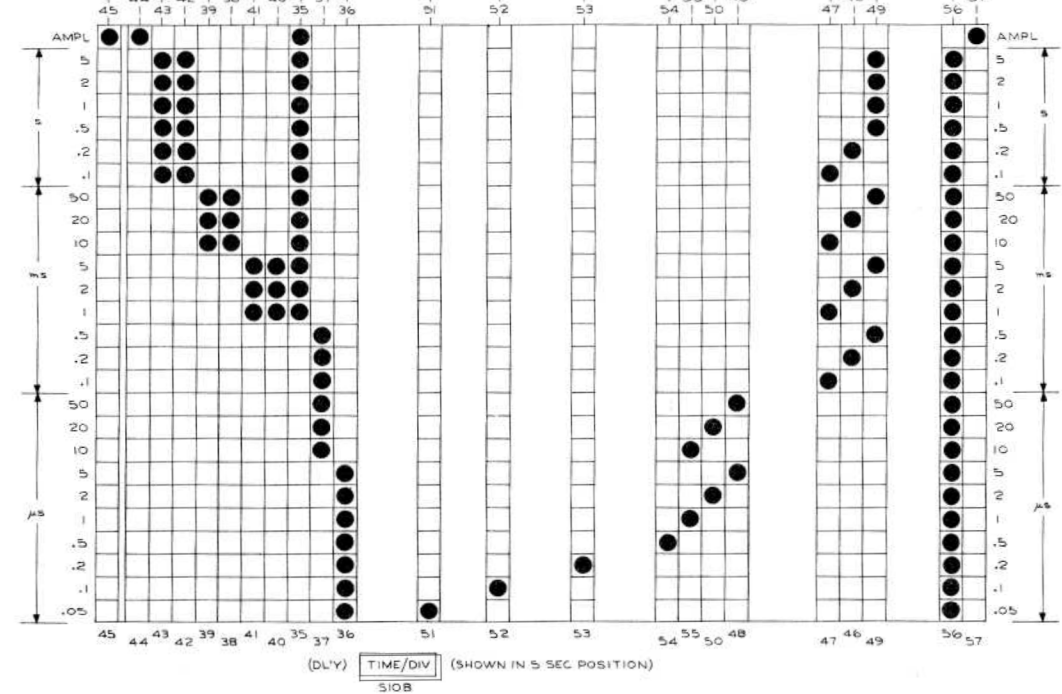
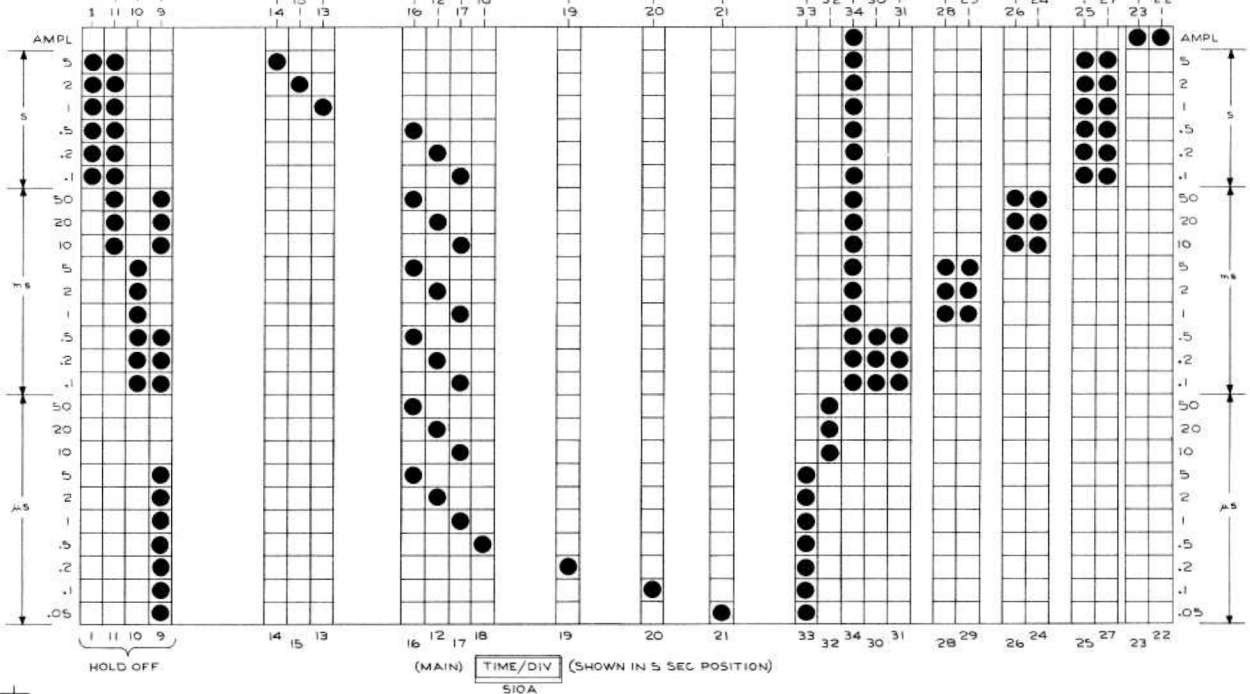
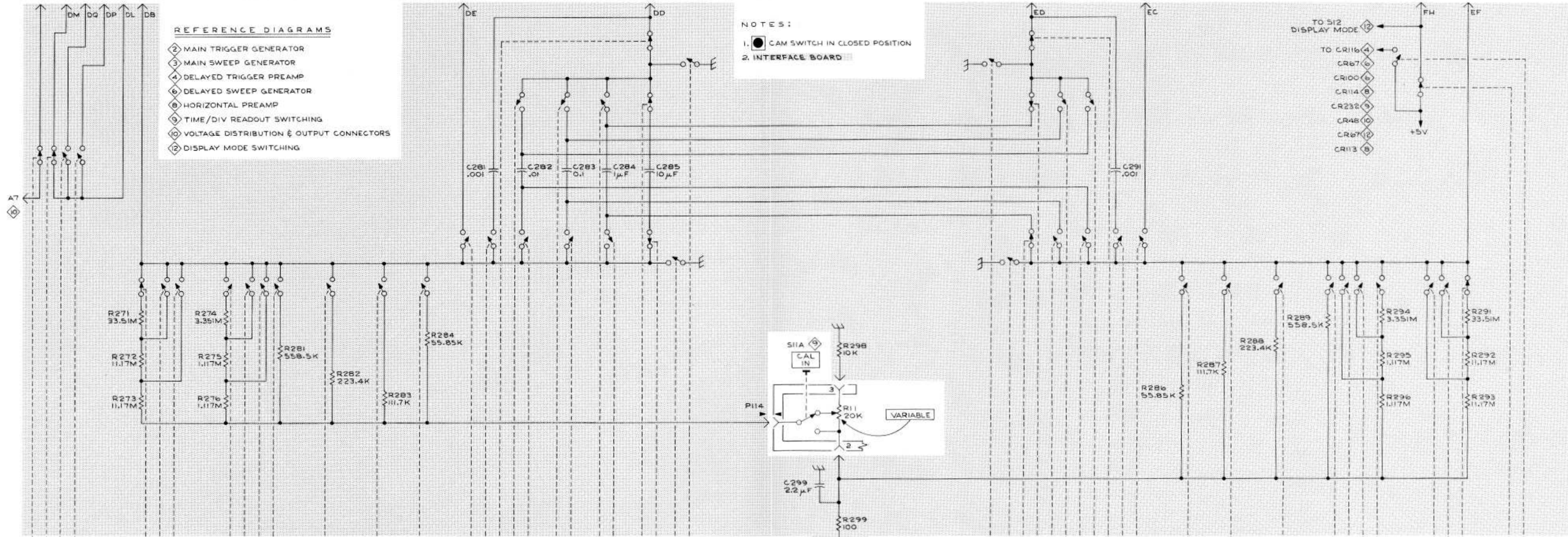

1

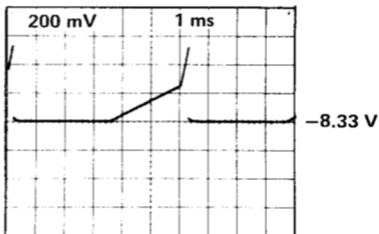

2

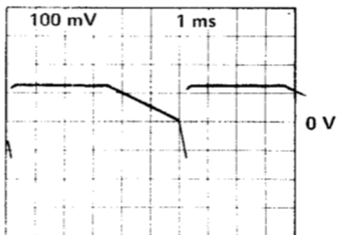

3

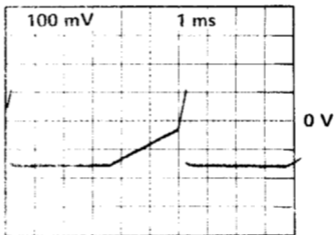

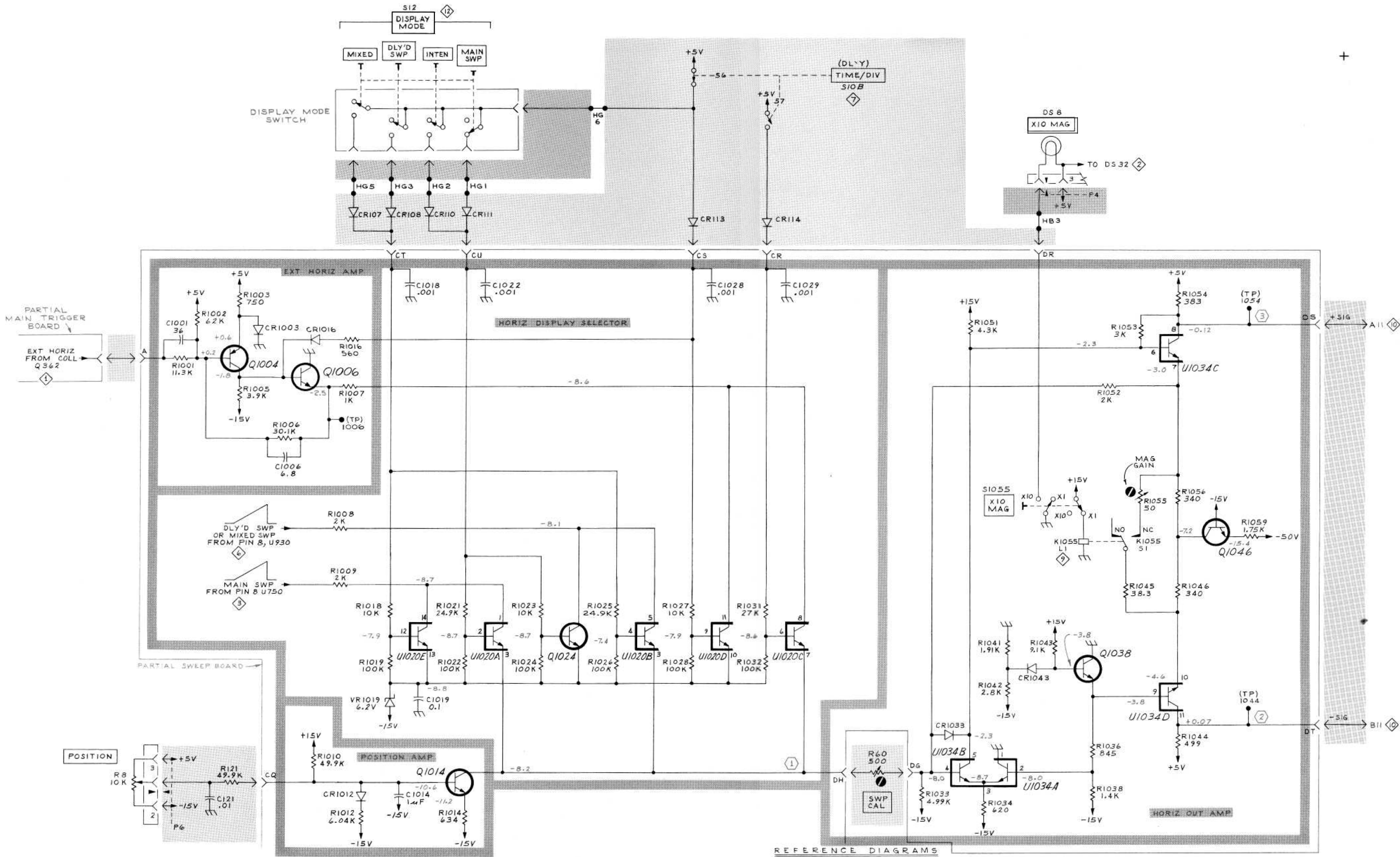

- NOTES:**
1. PINS 12, 13, 14, U1034 ARE TIED TO -15V.
 2. SEE PARTS LIST FOR SEMICONDUCTOR TYPES.
 3. INTERFACE BOARD
 4. DISTRIBUTION BOARD

- REFERENCE DIAGRAMS**
- 1 MAIN TRIGGER PREAMP
 - 2 MAIN TRIGGER GENERATOR
 - 3 MAIN SWEEP GENERATOR
 - 4 DELAYED SWEEP GENERATOR
 - 5 TIMING SWITCHES
 - 6 VOLTAGE DISTRIBUTION & OUTPUT CONNECTORS
 - 7 DISPLAY MODE SWITCHING

VOLTAGES and WAVEFORMS obtained under conditions given on page preceding Block Diagram.

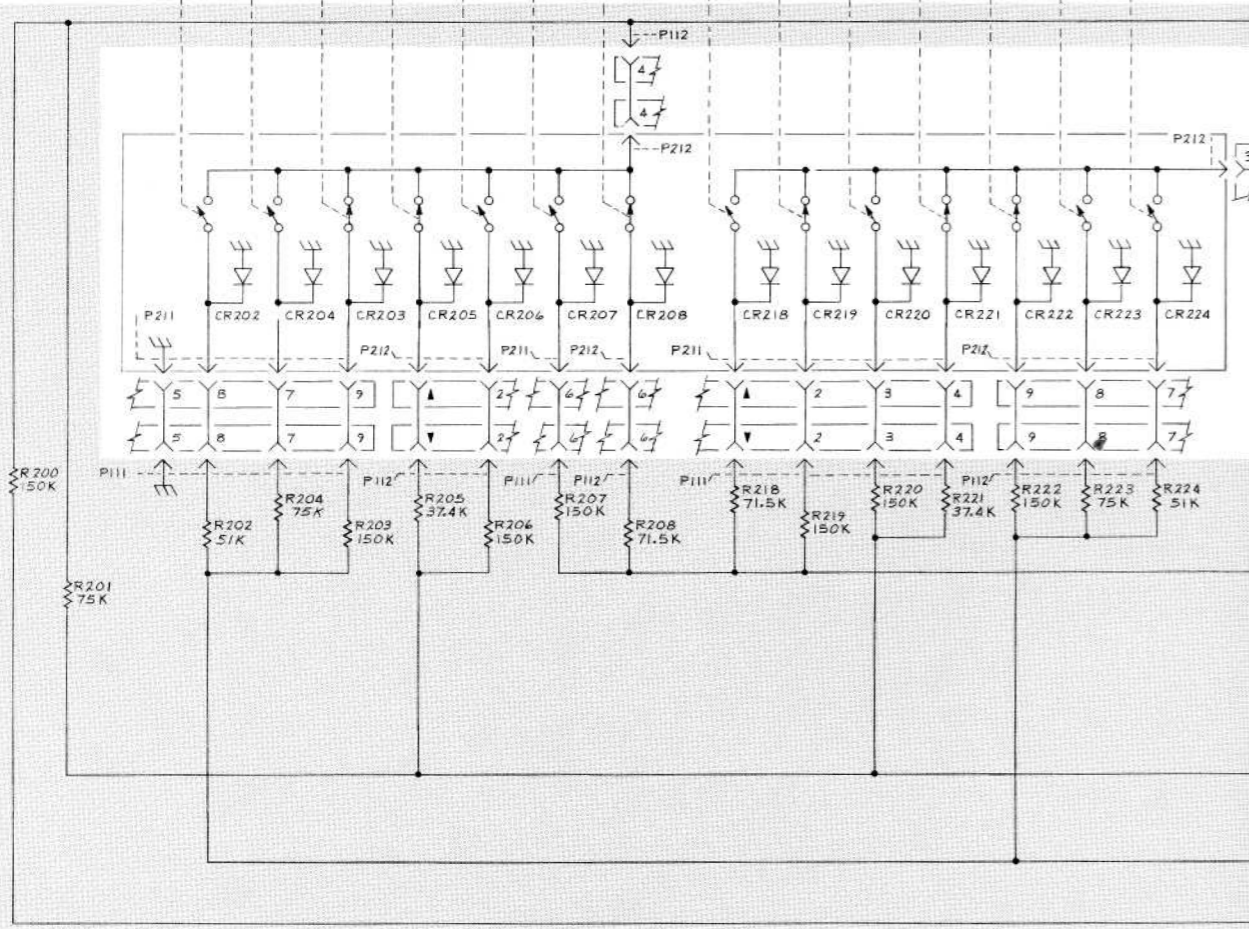
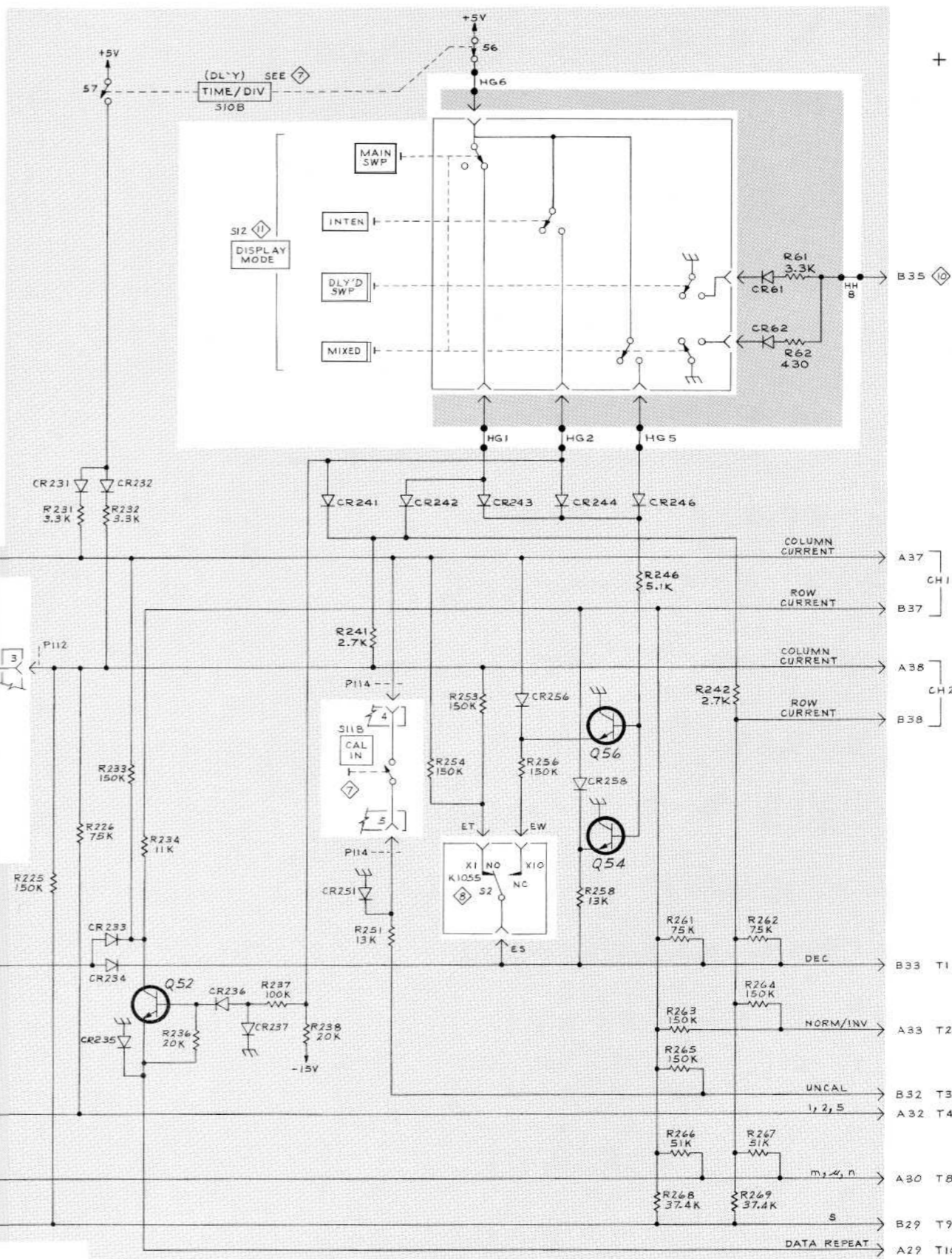
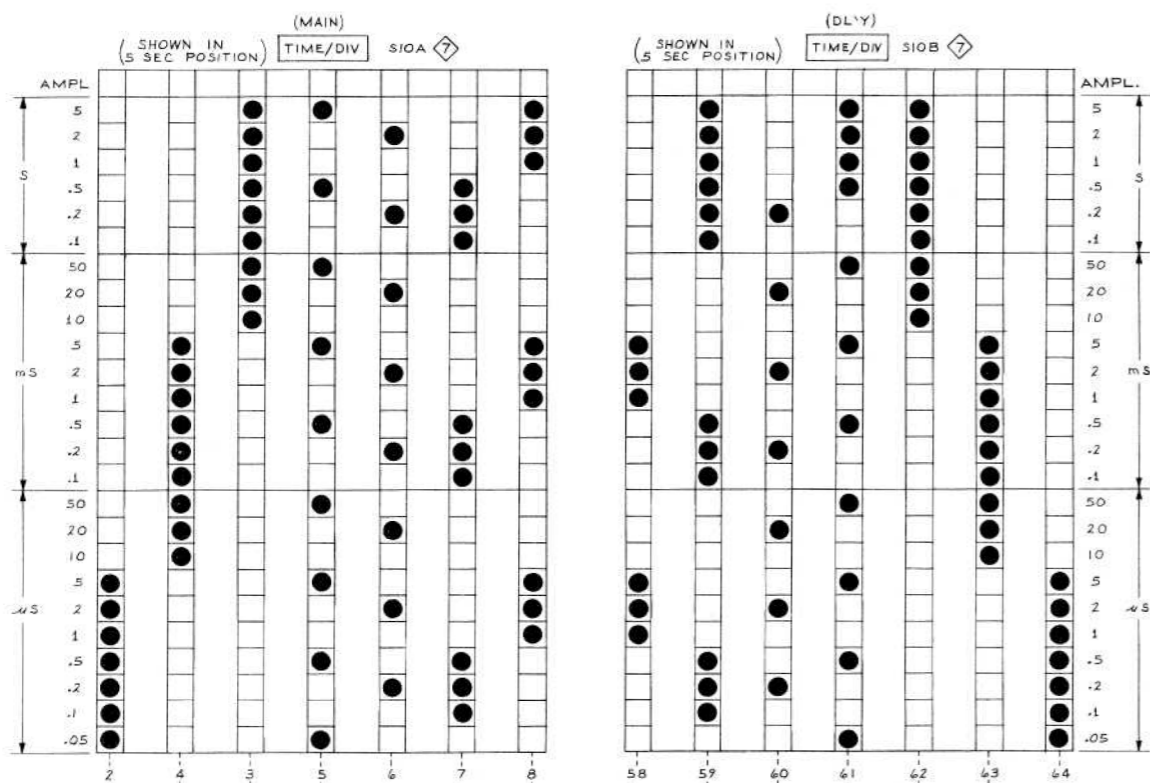

7B52 DUAL TIME BASE

REFERENCE DIAGRAMS

- ⑦ TIMING SWITCH
- ⑧ HORIZONTAL PREAMP
- ⑩ VOLTAGE DISTRIBUTION & OUTPUT CONNECTORS
- ⑪ TRIGGER SWITCHING

NOTES:

1. ● DENOTES CAM SWITCH IN CLOSED POSITION.
2. SEE PARTS LIST FOR SEMICONDUCTOR TYPES
3. INTERFACE BOARD
4. DISTRIBUTION BOARD

TIME/DIV READOUT SWITCHING ⑨ 0670 WLB

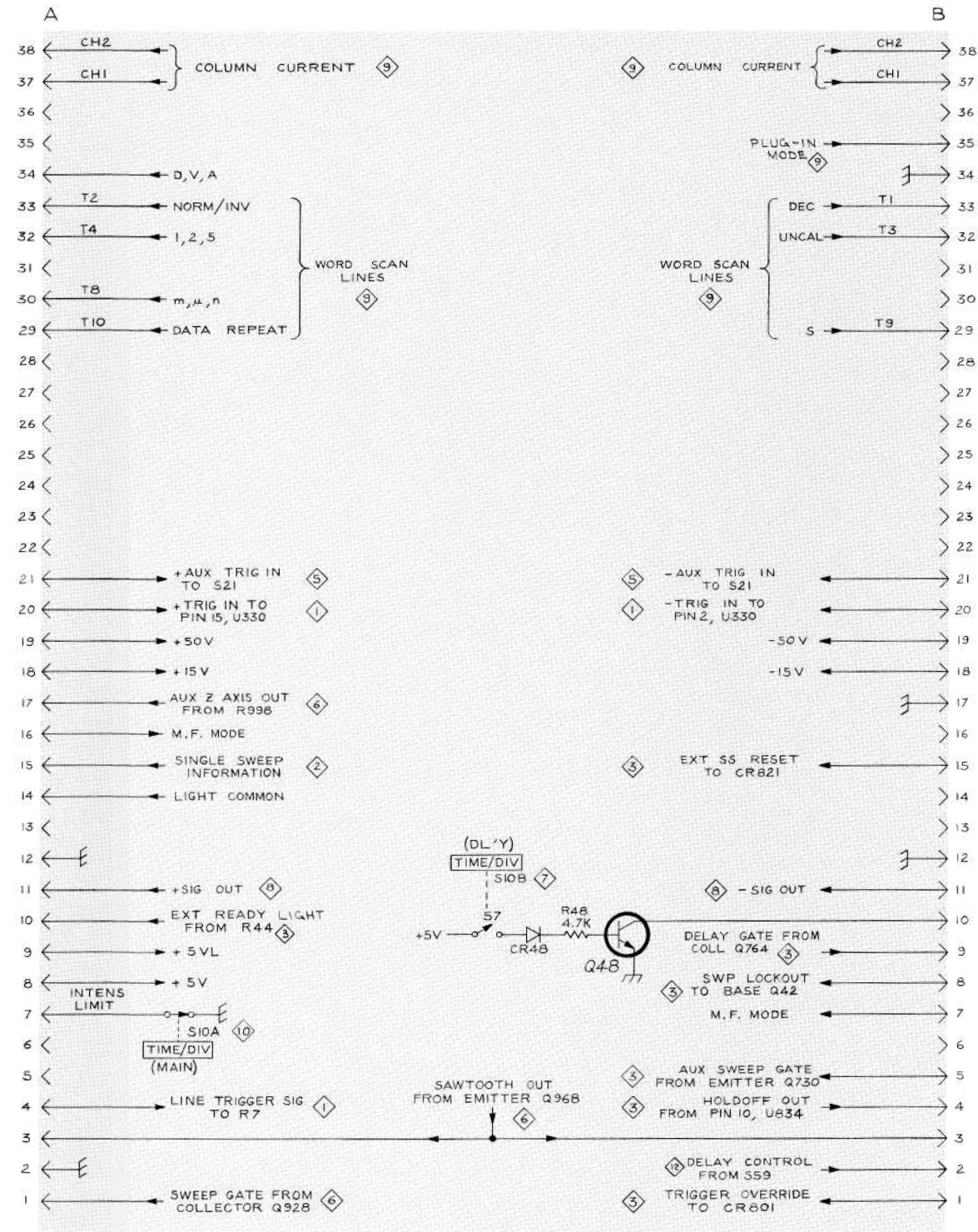
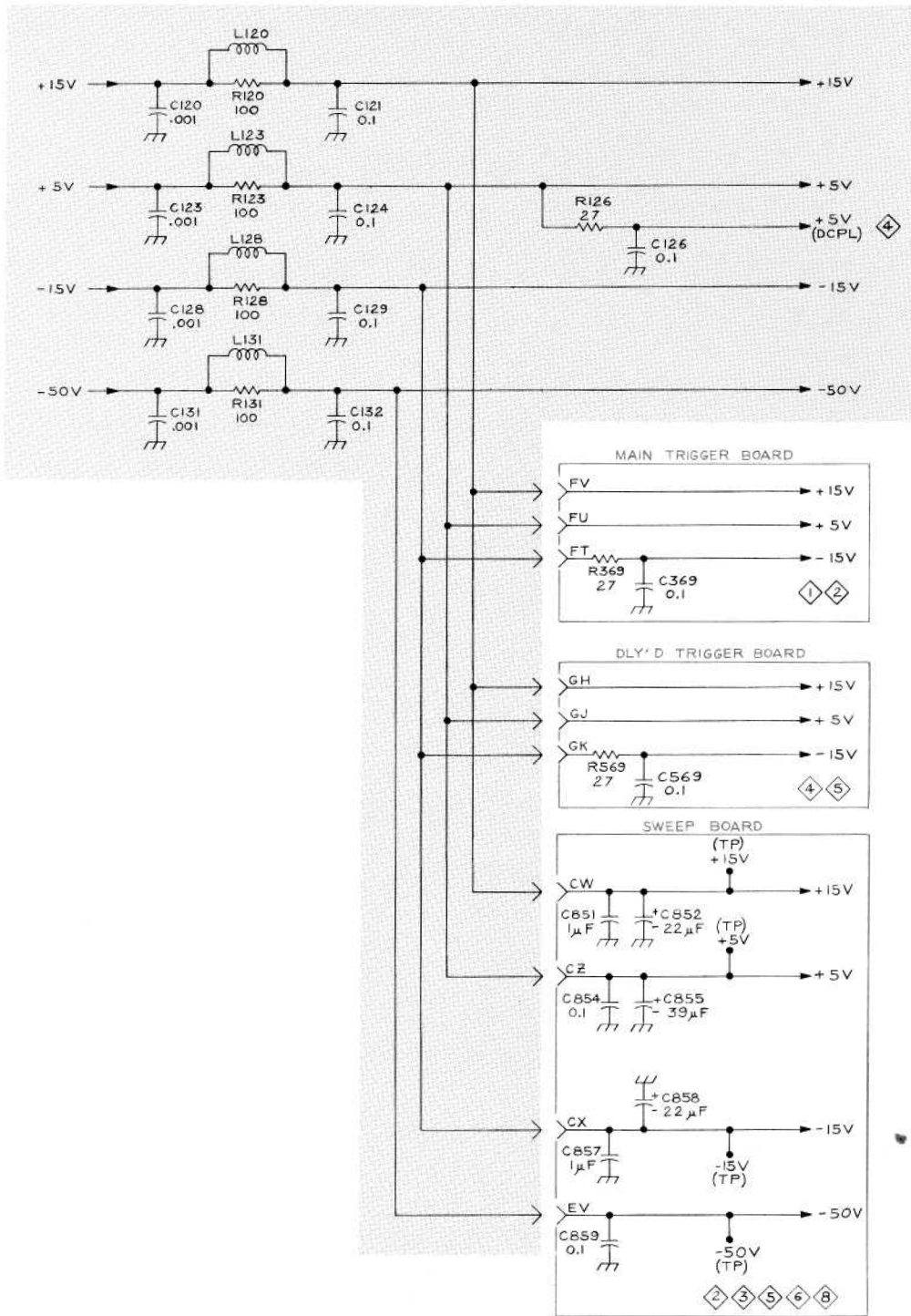

NOTES:
 1. SEE PARTS LIST FOR SEMICONDUCTOR TYPES
 2. INTERFACE BOARD

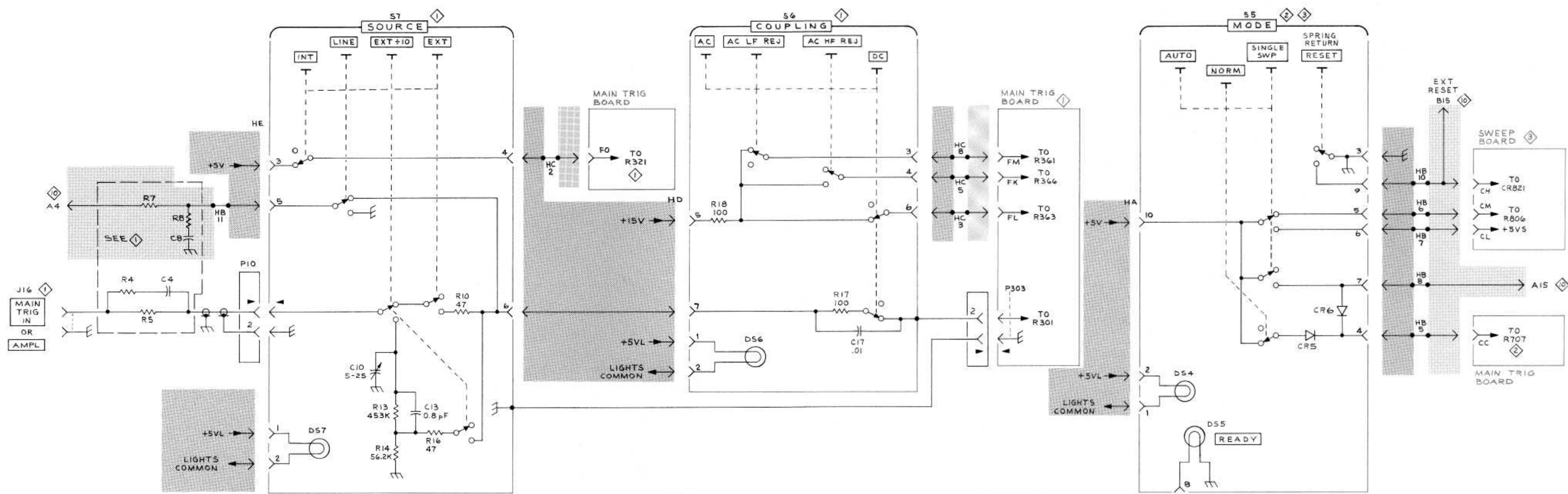

- NOTES:
1. SEE PARTS LIST FOR SEMICONDUCTOR TYPES
 2. INTERFACE BOARD
 3. DISTRIBUTION BOARD

- REFERENCE DIAGRAMS
- ① MAIN TRIGGER PREAMP
 - ② MAIN TRIGGER GENERATOR
 - ③ MAIN SWEEP GENERATOR
 - ④ DELAYED TRIGGER PREAMP
 - ⑤ DELAYED TRIGGER GENERATOR
 - ⑩ VOLTAGE DISTRIBUTION & OUTPUT CONNECTORS

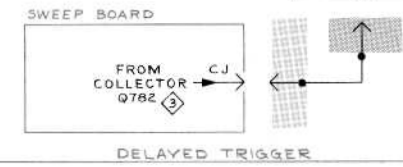

DELAYED TRIGGER

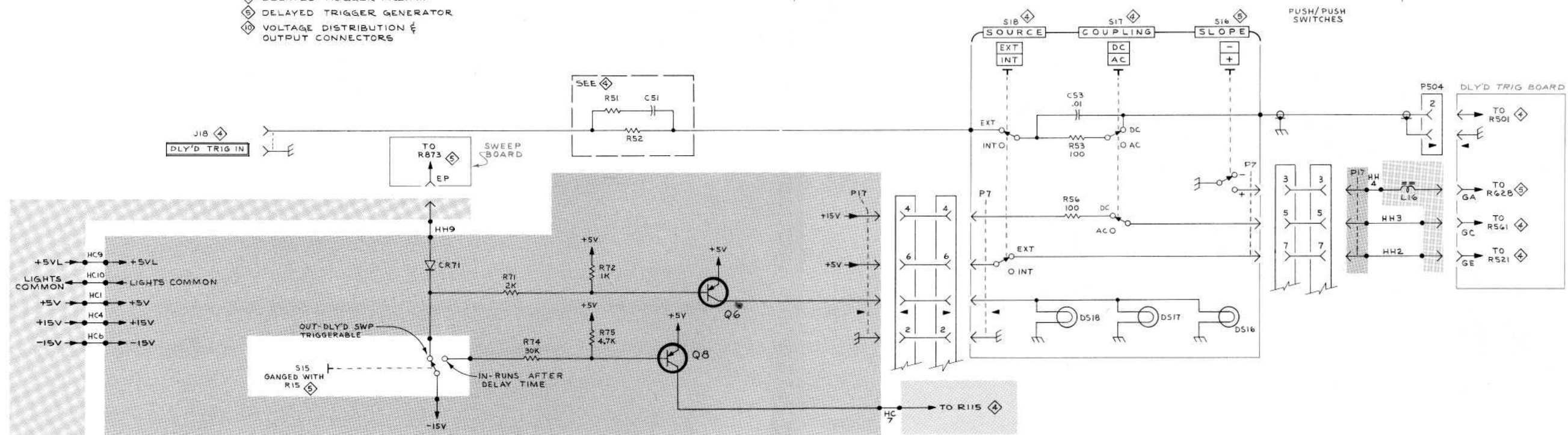

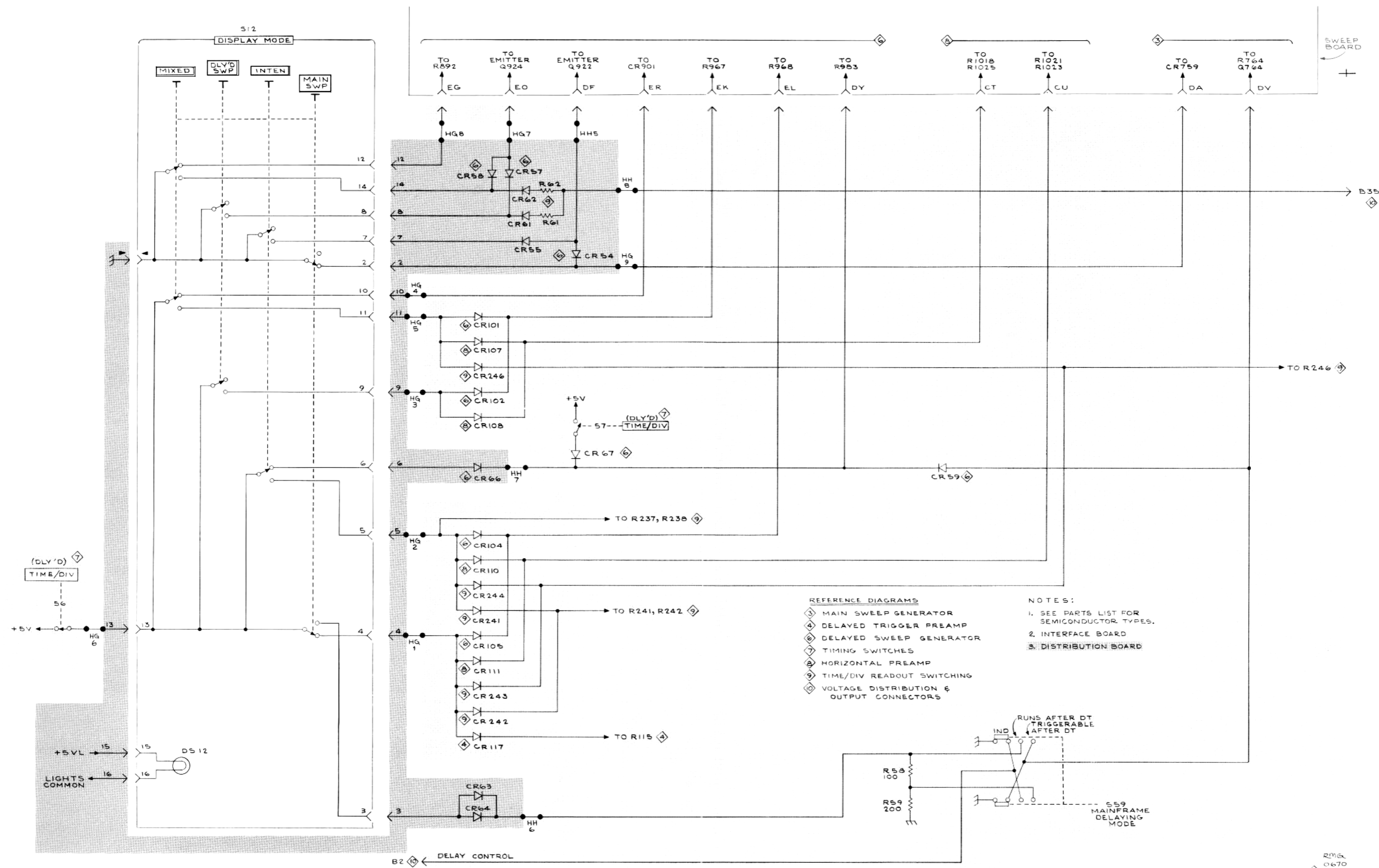

- REFERENCE DIAGRAMS
- ③ MAIN SWEEP GENERATOR
 - ④ DELAYED TRIGGER PREAMP
 - ⑤ DELAYED SWEEP GENERATOR
 - ⑦ TIMING SWITCHES
 - ⑧ HORIZONTAL PREAMP
 - ⑨ TIME/DIV READOUT SWITCHING
 - ⑩ VOLTAGE DISTRIBUTION & OUTPUT CONNECTORS

- NOTES:
1. SEE PARTS LIST FOR SEMICONDUCTOR TYPES.
 2. INTERFACE BOARD
 3. DISTRIBUTION BOARD

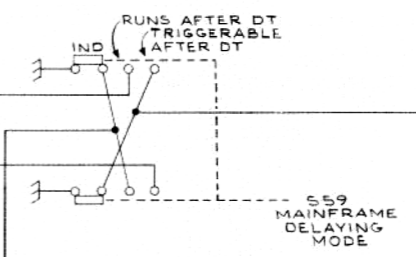

FIGURE AND INDEX NUMBERS

Items in this section are referenced by figure and index numbers to the illustrations which appear either on the back of the diagrams or on pullout pages immediately following the diagrams of the instruction manual.

INDENTATION SYSTEM

This mechanical parts list is indented to indicated item relationships. Following is an example of the indentation system used in the Description column.

Assembly and/or Component
Detail Part of Assembly and/or Component
mounting hardware for Detail Part
Parts of Detail Part
mounting hardware for Parts of Detail Part
mounting hardware for Assembly and/or Component

Mounting hardware always appears in the same indentation as the item it mounts, while the detail parts are indented to the right. Indented items are part of, and included with, the next higher indentation.

Mounting hardware must be purchased separately, unless otherwise specified.

PARTS ORDERING INFORMATION

Replacement parts are available from or through your local Tektronix, Inc. Field Office or representative.

Changes to Tektronix instruments are sometimes made to accommodate improved components as they become available, and to give you the benefit of the latest circuit improvements developed in our engineering department. It is therefore important, when ordering parts, to include the following information in your order: Part number, instrument type or number, serial or model number, and modification number if applicable.

If a part you have ordered has been replaced with a new or improved part, your local Tektronix, Inc. Field Office or representative will contact you concerning any change in part number.

Change information, if any, is located at the rear of this manual.

ABBREVIATIONS AND SYMBOLS

For an explanation of the abbreviations and symbols used in this section, please refer to the page immediately preceding the Electrical Parts List in this instruction manual.

INDEX OF MECHANICAL AND REPACKAGING PARTS ILLUSTRATIONS

Title	Location (reverse side of)
Figure 1 Exploded	Trigger Switching Diagram
Figure 2 Repackaging	Display Mode Switching Diagram

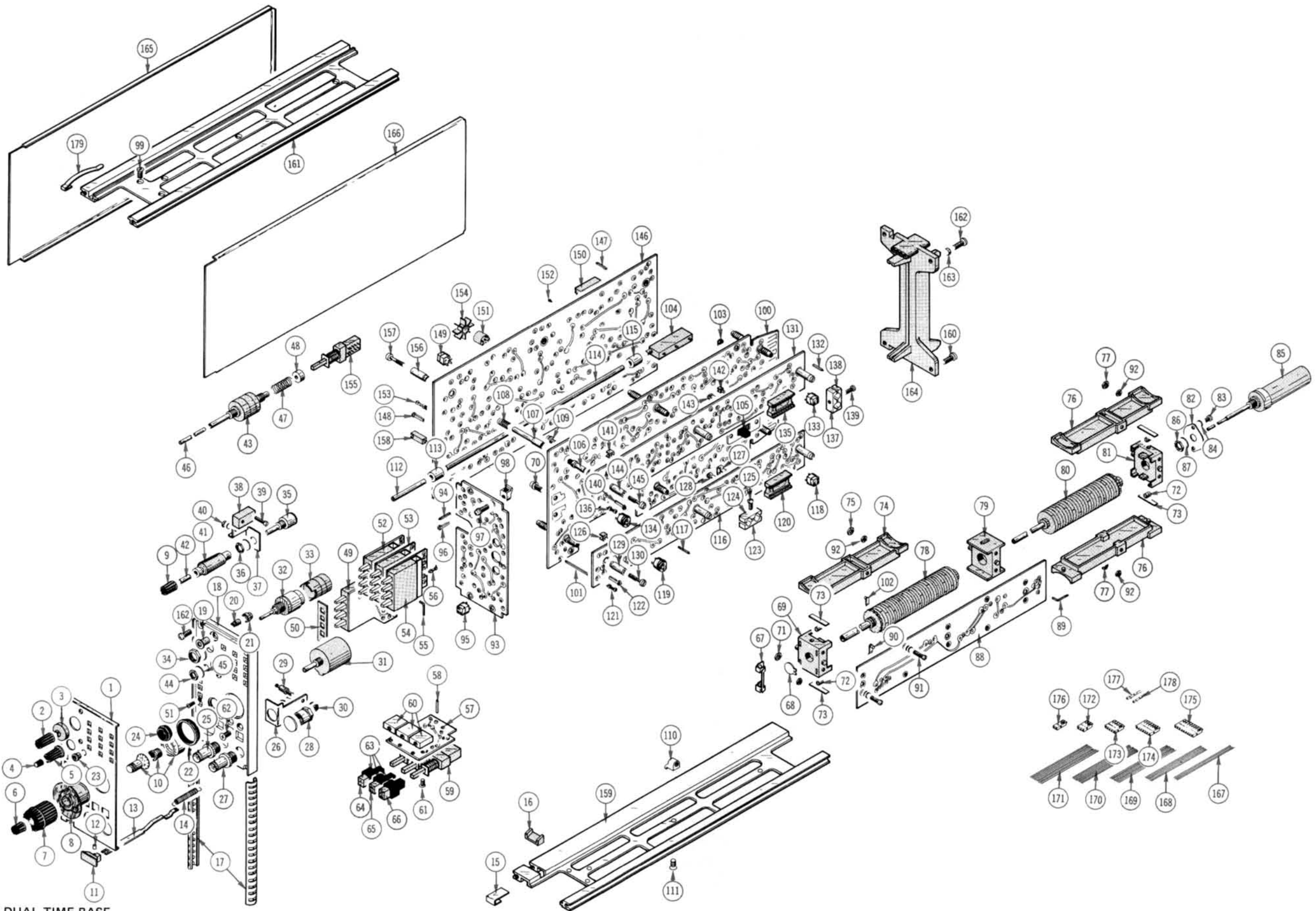

7B52 DUAL TIME BASE

SECTION 8

MECHANICAL PARTS LIST

FIGURE 1 EXPLODED

Fig. & Index No.	Tektronix Part No.	Serial/Model No.		Q † Y	Description
		Eff	Disc		
1-1	333-1308-00			1	PANEL, front
-2	366-1064-00			1	KNOB, gray—LEVEL/SLOPE
				-	knob includes:
	213-0153-00			1	SETSCREW, 5-40 x 0.125 inch, HSS
-3	354-0342-00			1	RING, knob skirt
-4	366-1059-00			1	KNOB, gray—X10 MAG
-5	366-1213-00			1	KNOB, gray—POSITION
				-	knob includes:
	213-0153-00			1	SETSCREW, 5-40 x 0.125 inch, HSS
-6	366-1168-00			1	KNOB, red—MAIN VARIABLE (CAL IN)
				-	knob includes:
	213-0153-00			1	SETSCREW, 5-40 x 0.125 inch, HSS
-7	366-1219-00			1	KNOB, gray—TIME/DIV, DLY TIME
				-	knob includes:
	213-0153-00			1	SETSCREW, 5-40 x 0.125 inch, HSS
-8	354-0383-00			1	RING, knob skirt
				-	ring includes:
	213-0153-00			1	SETSCREW, 5-40 x 0.125 inch, HSS
-9	366-1023-00			1	KNOB, gray—DLY TIME LEVEL
				-	knob includes:
	213-0153-00			1	SETSCREW, 5-40 x 0.125 inch, HSS
-10	331-0247-00			1	DIAL, control
-11	366-1058-14			1	KNOB, latch
-12	214-1095-00			1	PIN, spring, split
-13	105-0076-00			1	RELEASE BAR, latch
-14	214-1280-00			1	SPRING, helical compression
-15	214-1054-00			1	SPRING, flat, latch detent
-16	105-0075-00			1	BODY, latch
-17	348-0235-00			2	SHIELDING GASKET
-18	386-0447-39			1	SUBPANEL, front
-19	352-0157-00			2	HOLDER, lamp
-20	378-0602-00			2	LENS, lamp
-21	200-0935-00			2	CAP, lamp holder
-22	401-0080-00			1	BEARING, knob skirt
-23	358-0378-00			1	BUSHING, sleeve, front panel trim
-24	358-0408-00			1	BUSHING, sleeve
-25	131-0955-00			1	CONNECTOR, coaxial, BNC, female, w/hardware
				-	mounting hardware: (not included w/connector)
	210-0012-00			1	WASHER, lock, internal, 0.375 ID x 0.50 inch OD
-26	337-1317-00			1	SHIELD, electrical

FIGURE 1 EXPLODED (cont)

Fig. & Index No.	Tektronix Part No.	Serial/Model Eff	No. Disc	Q t y	1 2 3 4 5					Description
					1	2	3	4	5	
1-27	131-0955-00			1						CONNECTOR, coaxial, BNC, female w/hardware
	- - - - -			-						mounting hardware: (not included w/connector)
	210-0012-00			1						WASHER, lock, internal, 0.375 ID x 0.50 inch OD
-28	220-0581-00			1						NUT, sleeve, 0.375-32 x 0.437 inch long
-29	131-0373-00			1						CONNECTOR, standoff
	- - - - -			-						mounting hardware: (not included w/connector)
	210-0001-00			1						WASHER, lock, internal, #2
-30	210-0405-00			1						NUT, hex., 2-56 x 0.188 inch
-31	- - - - -			1						RESISTOR, variable
	- - - - -			-						resistor includes:
-32	214-1235-00			1						DRIVE, turns reduction
-33	- - - - -			1						RESISTOR, variable
	- - - - -			-						mounting hardware: (not included w/resistor)
	210-0978-00			1						WASHER, flat, 0.375 ID x 0.50 inch OD
-34	210-0590-00			1						NUT, hex., 0.375-32 x 0.438 inch
-35	- - - - -			1						RESISTOR, variable
	- - - - -			-						mounting hardware: (not included w/resistor)
-36	210-0583-00			1						NUT, hex., 0.25-32 x 0.312 inch
	210-0046-00			1						WASHER, lock, internal, 0.261 ID x 0.40 inch OD
-37	407-0749-00			1						BRACKET, component mounting
-38	260-0516-00			1						SWITCH, sensitive—DELAYED LEVEL
	- - - - -			-						mounting hardware: (not included w/switch)
-39	211-0159-00			2						SCREW, 2-56 x 0.375 inch, PHS
	210-0001-00			2						WASHER, lock, internal, #2
-40	210-0405-00			2						NUT, hex., 2-56 x 0.188 inch
-41	214-1190-00			1						EXTENDER-RETRACTER, knob
	- - - - -			-						extender-retractor includes:
	213-0075-00			1						SETSCREW, 4-40 x 0.094 inch, HSS
	213-0140-00			1						SETSCREW, 2-56 x 0.094 inch, HSS
-42	384-1009-00			1						SHAFT, extension, 0.56 inch long
-43	- - - - -			1						RESISTOR, variable
	- - - - -			-						mounting hardware: (not included w/resistor)
-44	210-0583-00			1						NUT, hex., 0.25-32 x 0.312 inch
-45	210-0940-00			1						WASHER, flat, 0.25 ID x 0.375 inch OD
	210-0046-00			1						WASHER, lock, internal, 0.261 ID x 0.40 inch OD
-46	384-1004-00			1						SHAFT, extension, 2.25 inches long
-47	214-1353-00			1						SPRING, helical compression
-48	214-1355-00			1						ACTUATOR, switch

FIGURE 1 EXPLODED (cont)

Fig. & Index No.	Tektronix Part No.	Serial/Model Eff	No. Disc	Q					Description	
				t	y	1	2	3		4
1-49	670-1220-00			1						CIRCUIT BOARD ASSEMBLY—DISPLAY MODE
	- - - - -			-						circuit board assembly includes:
	136-0328-02			16						SOCKET, terminal pin
-50	255-0375-01			ft						PLASTIC STRIP, switch alignment, 1.20 inches long
	380-0155-00			1						HOUSING, light
	- - - - -			-						mounting hardware: (not included w/housing)
	213-0181-00			1						SCREW, thread forming, #2 x 0.375 inch, PHS
	- - - - -			-						mounting hardware: (not included w/circuit board assembly)
-51	211-0156-00			2						SCREW, 1-72 x 0.25 inch, 82° csk, FHS
-52	670-1219-00			1						CIRCUIT BOARD ASSEMBLY—TRIGGER MODE
	- - - - -			-						circuit board assembly includes:
	136-0328-02			10						SOCKET, terminal pin
	255-0375-01			ft						PLASTIC STRIP, switch alignment, 1.20 inches long
	380-0155-01			1						HOUSING, light, 4 button, special
	- - - - -			-						mounting hardware: (not included w/housing)
	213-0181-00			1						SCREW, thread forming, #2 x 0.375 inch, PHS
	- - - - -			-						mounting hardware: (not included w/circuit board assembly)
	211-0156-00			2						SCREW, 1-72 x 0.25 inch, 82° csk, FHS
-53	670-1222-00			1						CIRCUIT BOARD ASSEMBLY—TRIGGER COUPLING
	- - - - -			-						circuit board assembly includes:
	136-0328-02			7						SOCKET, terminal pin
	255-0375-01			ft						PLASTIC STRIP, switch alignment, 1.20 inches long
	380-0155-00			1						HOUSING, light
	- - - - -			-						mounting hardware: (not included w/housing)
	213-0181-00			1						SCREW, thread forming, #2 x 0.375 inch, PHS
	- - - - -			-						mounting hardware: (not included w/circuit board assembly)
	211-0156-00			2						SCREW, 1-72 x 0.25 inch, 82° csk, FHS
-54	670-1221-00			1						CIRCUIT BOARD ASSEMBLY—TRIGGER SOURCE
	- - - - -			-						circuit board assembly includes:
-55	131-0589-00			2						TERMINAL, pin, 0.50 inch long
-56	136-0328-02			6						SOCKET, terminal pin
	255-0375-01			ft						PLASTIC STRIP, switch alignment, 1.20 inches long
	380-0155-00			1						HOUSING, light
	- - - - -			-						mounting hardware: (not included w/housing)
	213-0181-00			1						SCREW, thread forming, #2 x 0.375 inch, PHS
	- - - - -			-						mounting hardware: (not included w/circuit board assembly)
	211-0156-00			2						SCREW, 1-72 x 0.25 inch, 82° csk, FHS

FIGURE 1 EXPLODED (cont)

Fig. & Index No.	Tektronix Part No.	Serial/Model No. Eff Disc	Q					Description
			f	1	2	3	4	
1-57	670-1225-00		1					CIRCUIT BOARD ASSEMBLY—DELAYED TRIGGER
	- - - - -		-					circuit board assembly includes:
	388-1589-00		1					CIRCUIT BOARD
-58	131-0608-00		7					TERMINAL, pin, 0.365 inch long
-59	260-1133-00		1					SWITCH, push, set of 3—SLOPE, COUPLING, SOURCE
-60	352-0239-00		3					LAMPHOLDER
	- - - - -		-					mounting hardware for each: (not included w/lampholder)
-61	213-0098-00		2					SCREW, 0-80 x 0.125 inch, FHS
	- - - - -		-					mounting hardware: (not included w/circuit board assembly)
-62	211-0541-00		3					SCREW, 6-32 x 0.25 inch, 100° csk, FHS
-63	380-0200-00		3					HOUSING, pushbutton
-64	366-1214-03		1					KNOB, push— + & —
-65	366-1214-02		1					KNOB, push—AC-DC
-66	366-1214-01		1					KNOB, push—INT-EXT
	672-0411-00		1					CIRCUIT BOARD ASSEMBLY—INTERFACE READOUT
	- - - - -		-					circuit board assembly includes:
-67	131-0963-00		1					CONTACT, electrical, grounding
-68	354-0195-00		1					RING, retaining
-69	401-0081-02		1					BEARING, cam switch, front
	- - - - -		-					mounting hardware: (not included w/bearing)
-70	211-0116-00		2					SCREW, sems, 4-40 x 0.312 inch, PHB
-71	210-0591-00		2					NUT, hex., 4-40 x 0.188 inch
-72	214-1127-00		4					ROLLER, detent
-73	214-1139-00 ¹		-					SPRING, flat, gold
	214-1139-02 ¹		-					SPRING, flat, green
	214-1139-03 ¹		-					SPRING, flat, red
-74	200-1116-00		2					COVER, cam switch, front
	- - - - -		-					mounting hardware for each: (not included w/cover)
	211-0116-00		1					SCREW, sems, 4-40 x 0.312 inch, PHB
-75	210-0591-00		1					NUT, hex., 4-40 x 0.188 inch
-76	200-1115-00		2					COVER, cam switch, rear
	- - - - -		-					mounting hardware for each: (not included w/cover)
	211-0116-00		1					SCREW, sems, 4-40 x 0.312 inch, PHB
-77	210-0591-00		1					NUT, hex., 4-40 x 0.188 inch
-78	105-0189-00		1					DRUM, cam switch, front
-79	401-0083-00		1					BEARING, cam switch, center
	- - - - -		-					mounting hardware: (not included w/bearing)
	211-0116-00		2					SCREW, sems, 4-40 x 0.312 inch, PHB
	210-0591-00		2					NUT, hex., 4-40 x 0.188 inch
-80	105-0187-00		1					DRUM, cam switch, rear
-81	401-0081-01		1					BEARING, cam switch, rear
	- - - - -		-					mounting hardware: (not included w/bearing)
	211-0116-00		2					SCREW, sems, 4-40 x 0.312 inch, PHB
	210-0591-00		2					NUT, hex., 4-40 x 0.188 inch
	354-0391-00		1					RING, retaining

¹Replace only with part bearing the same color as the original part in your instrument.

FIGURE 1 EXPLODED (cont)

Fig. & Index No.	Tektronix Part No.	Serial/Model No. Eff Disc	Q					Description	
			t	y	1	2	3		4
1-82	386-1792-00		1						PLATE, variable resistor mounting
	- - - - -		-						mounting hardware: (not included w/plate)
-83	211-0087-00		2						SCREW, 2-56 x 0.188 inch, PHB
-84	210-0001-00		2						WASHER, lock, internal, #2
	- - - - -		1						RESISTOR, variable
	- - - - -		-						mounting hardware: (not included w/resistor)
-86	210-0583-00		1						NUT, hex., 0.25-32 x 0.312 inch
-87	210-0046-00		1						WASHER, lock, internal, 0.261 ID x 0.40 inch OD
	- - - - -		1						CIRCUIT BOARD ASSEMBLY—READOUT
	- - - - -		-						circuit board assembly includes:
	388-1590-00		1						CIRCUIT BOARD
	131-0589-00		9						TERMINAL, pin, 0.50 inch long
-89	131-0787-00		8						TERMINAL, pin, 0.65 inch long
-90	131-0604-00		14						CONTACT, electrical, spring
	- - - - -		-						mounting hardware: (not included w/circuit board assembly)
-91	211-0182-00		10						SCREW, sems, 2-56 x 0.312 inch, PHB
-92	210-0405-00		10						NUT, hex., 2-56 x 0.188 inch
	- - - - -		1						CIRCUIT BOARD ASSEMBLY—DISTRIBUTION
	- - - - -		-						circuit board assembly includes:
	388-1570-00		1						CIRCUIT BOARD
-94	131-0589-00		47						TERMINAL, pin, 0.50 inch long
	131-0590-00		3						TERMINAL, pin, 0.665 inch long
	131-0608-00		7						TERMINAL, pin, 0.365 inch long
-95	136-0220-00		2						SOCKET, transistor, 3 pin, square
-96	214-0579-00		2						PIN, test point
	- - - - -		-						mounting hardware: (not included w/circuit board assembly)
-97	211-0116-00		4						SCREW, sems, 4-40 x 0.312 inch, PHB
-98	220-0547-01		4						NUT BLOCK
-99	211-0105-00		4						SCREW, 4-40 x 0.188 inch, 100° csk, FHS
	- - - - -		1						CIRCUIT BOARD ASSEMBLY—INTERFACE
	- - - - -		-						circuit board assembly includes:
	388-1569-00		1						CIRCUIT BOARD
	131-0589-00		20						TERMINAL, pin, 0.50 inch long
	131-0590-00		23						TERMINAL, pin, 0.665 inch long
	131-0608-00		22						TERMINAL, pin, 0.365 inch long
	131-0591-00		20						TERMINAL, pin, 0.835 inch long
-101	131-0595-00		7						TERMINAL, pin, 1.37 inches long
	131-0592-00		55						TERMINAL, pin, 0.885 inch long
-102	131-0604-00		50						CONTACT, electrical, spring
-103	136-0350-00		9						SOCKET, transistor, 3 pin, low profile
-104	- - - - -		1						RESISTOR, variable
-105	260-0984-00		1						SWITCH, slide—DELAY
-106	351-0185-00		6						GUIDE-POST, lock, 0.65 inch long
-107	351-0186-00		6						GUIDE-POST, lock, 0.84 inch long
-108	214-1140-00		12						SPRING, helical compression
	- - - - -		-						mounting hardware: (not included w/circuit board assembly)
-109	211-0116-00		6						SCREW, sems, 4-40 x 0.312 inch, PHB
-110	220-0547-00		6						NUT BLOCK
-111	211-0105-00		6						SCREW, 4-40 x 0.188 inch, 100° csk, FHS

FIGURE 1 EXPLODED (cont)

Fig & Index No.	Tektronix Part No.	Serial/Model No. Eff Disc	Q					Description	
			t	y	1	2	3		4
1-112	384-1008-00		1						SHAFT, extension, 1.50 inches long
-113	376-0029-00		1						COUPLING, shaft, 0.128 ID x 0.312 inch OD
-114	384-1007-00		1						SHAFT, extension, plastic, 9 inches long
-115	376-0101-00		1						COUPLING, shaft, 0.375 inch long
-116	670-1218-00		1						CIRCUIT BOARD ASSEMBLY—DELAYED TRIGGER
	- - - - -		-						circuit board assembly includes:
	388-1572-00		1						CIRCUIT BOARD
-117	131-0608-00		2						TERMINAL, pin, 0.365 inch long
-118	136-0220-00		15						SOCKET, transistor, 3 pin, square
-119	136-0235-00		1						SOCKET, transistor, 6 pin
-120	136-0260-01		1						SOCKET, integrated circuit, 16 contact
-121	136-0263-03		13						SOCKET, pin, terminal
-122	214-0579-00		9						PIN, test point
-123	200-0945-01		1						COVER, half, transistor temperature stabilizer
-124	200-0945-00		1						COVER, half, transistor temperature stabilizer
-125	211-0062-00		1						SCREW, 2-56 x 0.312 inch, PHS
-126	352-0203-00		8						HOLDER, cable, double, plastic
-127	352-0213-00		1						HOLDER, coaxial, double, grounding
-128	352-0238-00		2						HOLDER, coaxial, single, grounding
-129	361-0238-00		3						SPACER, sleeve, 0.34 inch long
-130	211-0155-00		3						SCREW, relieved shank, 4-40 x 0.375 inch
-131	670-1224-00		1						CIRCUIT BOARD ASSEMBLY—MAIN TRIGGER
	- - - - -		-						circuit board assembly includes:
	388-1578-00		1						CIRCUIT BOARD
-132	131-0608-00		2						TERMINAL, pin, 0.365 inch long
-133	136-0220-00		21						SOCKET, transistor, 3 pin, square
-134	136-0235-00		1						SOCKET, transistor, 6 pin
-135	136-0260-01		1						SOCKET, integrated circuit, 16 contact
-136	136-0263-03		17						SOCKET, pin, terminal
-137	200-0945-01		1						COVER, half, transistor temperature stabilizer
-138	200-0945-00		1						COVER, half, transistor temperature stabilizer
-139	211-0062-00		1						SCREW, 2-56 x 0.312 inch, PHS
-140	214-0579-00		10						PIN, test point
-141	352-0213-00		7						HOLDER, cable, double, plastic
-142	352-0228-00		3						HOLDER, cable, single, plastic
-143	352-0238-00		4						HOLDER, coaxial, single, grounding
-144	361-0238-00		3						SPACER, sleeve, 0.34 inch long
-145	211-0155-00		3						SCREW, relieved shank, 4-40 x 0.375 inch
-146	670-1217-00		1						CIRCUIT BOARD ASSEMBLY—SWEEP
	- - - - -		-						circuit board assembly includes:
	388-1571-00		1						CIRCUIT BOARD
-147	131-0608-00		3						TERMINAL, pin, 0.365 inch long
-148	214-0579-00		24						PIN, test point
-149	136-0220-00		43						SOCKET, transistor, 3 pin, square
-150	136-0241-00		2						SOCKET, integrated circuit, 10 contact
-151	136-0269-00		5						SOCKET, integrated circuit, 14 contact
-152	136-0252-01		8						SOCKET, pin connector, 0.178 inch long
-153	136-0263-03		62						SOCKET, pin terminal
-154	214-1292-00		2						HEAT SINK, transistor

FIGURE 1 EXPLODED (cont)

Fig. & Index No.	Tektronix Part No.	Serial/Model No. Eff Disc	Q					Description
			t	y	1	2	3	
1-155	260-1132-00		1					SWITCH, push, X10 MAG
-156	361-0238-00		6					SPACER, sleeve, 0.34 inch long
-157	211-0155-00		6					SCREW, relieved shank, 4-40 x 0.375 inch
-158	352-0240-00		2					HOLDER, cable, plastic
-159	426-0499-11		1					FRAME SECTION, bottom
	- - - - -		-					mounting hardware: (not included w/frame section)
-160	213-0192-00		4					SCREW, thread forming, 6-32 x 0.50 inch, Fil HS
-161	426-0505-11		1					FRAME SECTION, top
	- - - - -		-					mounting hardware: (not included w/frame section)
-162	213-0192-00		4					SCREW, thread forming, 6-32 x 0.50 inch, Fil HS
-163	361-0326-00		1					SPACER, sleeve, 0.10 inch long
-164	386-1402-00		1					PANEL, rear
-165	337-1064-00		1					SHIELD, electrical, left
-166	337-1320-00		1					SHIELD, electrical, right
-167	175-0826-00		ft					WIRE, electrical, 3 wire ribbon, 6.75 inches long
-168	175-0828-00		ft					WIRE, electrical, 5 wire ribbon, 6.75 inches long
-169	175-0830-00		ft					WIRE, electrical, 7 wire ribbon, 2.50 inches long
-170	175-0831-00		ft					WIRE, electrical, 8 wire ribbon, 3.50 inches long
-171	175-0832-00		ft					WIRE, electrical, 9 wire ribbon, 3.25 inches long
-172	352-0161-04		1					HOLDER, terminal connector, 3 wire (yellow)
	352-0161-05		1					HOLDER, terminal connector, 3 wire (green)
	352-0161-06		1					HOLDER, terminal connector, 3 wire (blue)
-173	352-0163-04		1					HOLDER, terminal connector, 5 wire (yellow)
	352-0163-05		1					HOLDER, terminal connector, 5 wire (green)
-174	352-0165-07		2					HOLDER, terminal connector, 7 wire (violet)
-175	352-0167-01		2					HOLDER, terminal connector, 9 wire (brown)
	352-0167-02		2					HOLDER, terminal connector, 9 wire (red)
-176	352-0169-00		1					HOLDER, terminal connector, 2 wire (black)
	352-0169-03		1					HOLDER, terminal connector, 2 wire (orange)
	352-0169-04		1					HOLDER, terminal connector, 2 wire (yellow)
-177	131-0707-00		69					TERMINAL, connector
-178	131-0708-00		4					TERMINAL, connector
-179	214-1061-00		1					SPRING, flat, sliding ground

STANDARD ACCESSORIES

070-1043-00	2	MANUAL, instruction (not shown)
-------------	---	---------------------------------

CARTON ASSEMBLY
(Part No. 065-0125-00)

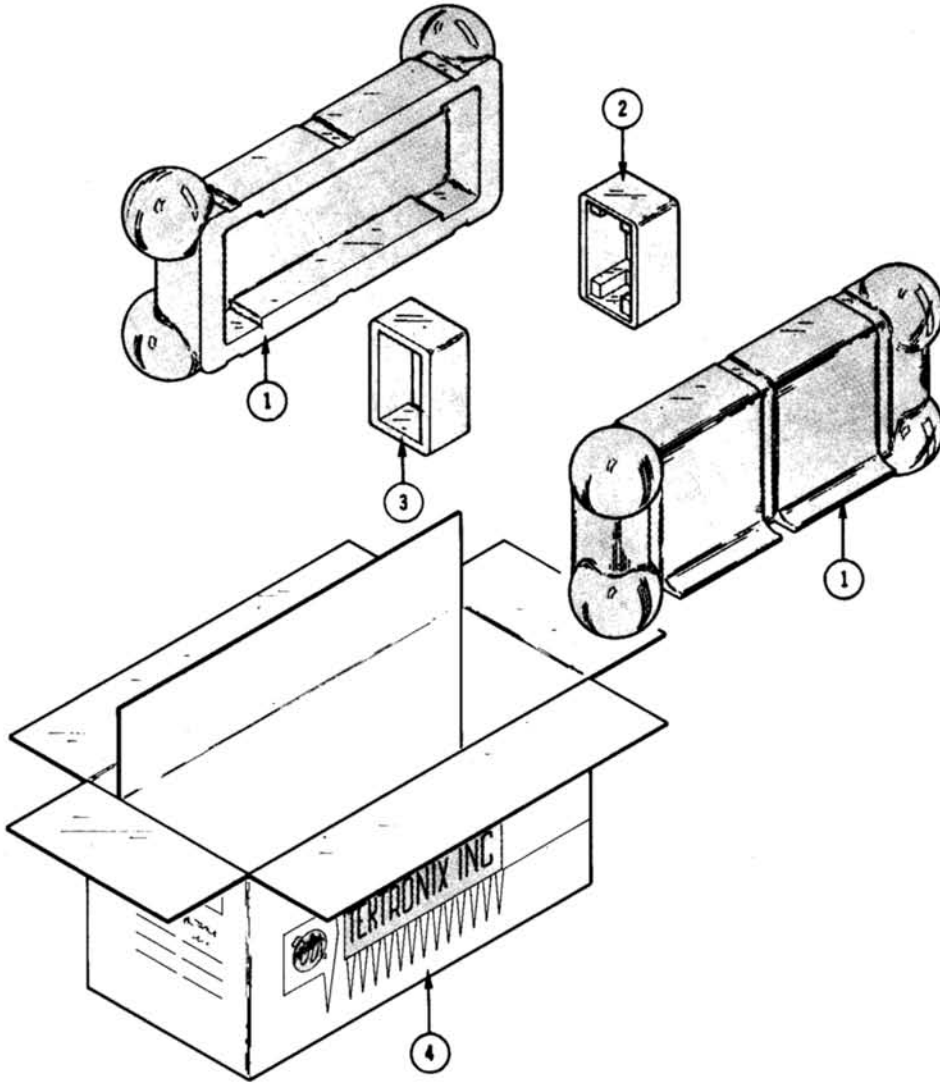

Fig. & Index No.	Tektronix Part No.	Serial/Model No. Eff	Disc	Q					Description	
				y	1	2	3	4		5
2-	065-0125-00			1						ASSEMBLY, carton
-1	004-0241-00			-						assembly includes:
-2	004-0242-00			2						CASE HALF
-3	004-0243-00			1						END CAP, rear
-4	004-0748-00			1						END CAP, front
				1						CARTON