

SERVICE INFORMATION

GENERAL

When the 7L18 is on extender cables, most minor adjustment controls are accessible from the top of the instrument without removing individual modules. For access to less frequently used adjustments, or for component replacements and major repairs, the 7L18 is hinged at the back between the vertical and horizontal plug-in sections. (We identify the sections as vertical and horizontal because they plug into the vertical and horizontal deflection compartments of an oscilloscope mainframe.) Two screws must be removed to separate these sections. Access to the rear of the hinged horizontal (wider) front panel is gained by removing another two screws and unhooking the rear end of the latch spring. Even with the hinged sections fully extended, the 7L18 is fully operational when connected to the mainframe with the extender cables.

The horizontal section consists of stacked, interlocking extrusions, each of which provides good shielding between adjacent functional modules. Any module can be removed without disturbing the structural or functional integrity of the remaining modules (refer to Figure 3-1). The module extenders will allow any module to function in an extended position for service or adjustment. The module circuit boards can be removed from the extrusions by removing their securing screws. Virtually all other circuit boards (which should require little or no servicing) are accessible by simply removing a cover plate.

NOTE

Disassembly of some of the modules, and the front panel assemblies, is a complex procedure and in some cases requires special tools. Since these less-likely procedures are beyond the scope of this manual at present, we recommend returning the instrument to Tektronix should service be necessary.

The phase lock system housing contributes greatly to the 7L18 stability. Four crystal-controlled oscillators are completely rf-isolated to ensure spurious-free response, yet are in close proximity to minimize cable losses and interactions with other functions. Other elements of the system are mounted back-to-back in the remaining compartments. All compartments are enclosed on both sides by mu-metal plates, and all interconnections between front and rear sides of the extrusion are made by feedthroughs rather than cables. If components in this housing are accessed, be sure that the shields and covers are properly reinstalled.

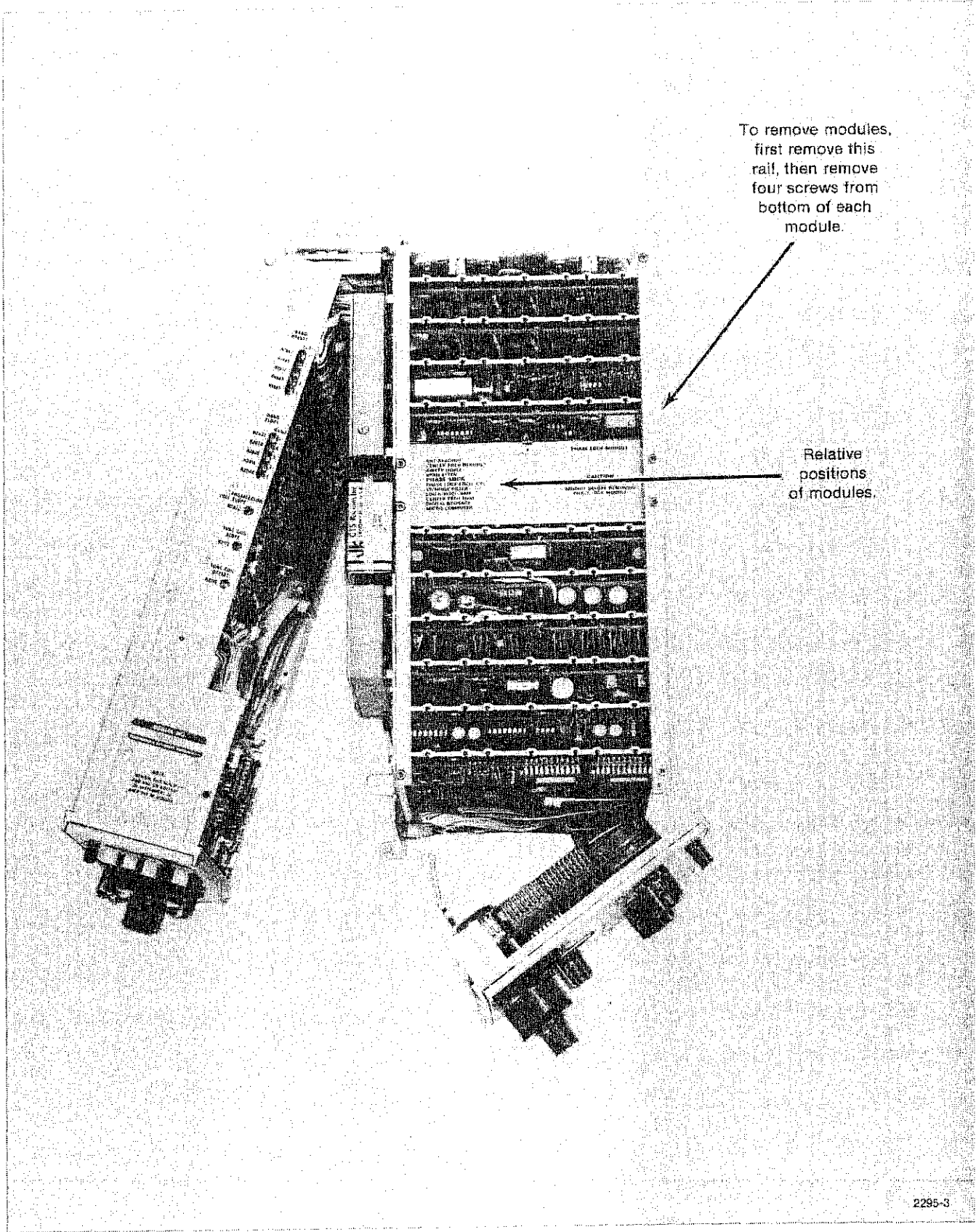

Figure 3-1. 7L18 Extended for servicing.

TEST FIXTURES

The following test fixtures allow operation of the 7L18 out of the mainframe, with some of its modules extended if desired, for calibration or troubleshooting purposes. In addition to this equipment, an extensive array of sophisticated instrumentation may be required for some troubleshooting or calibration procedures, both of which are beyond the scope of this interim manual at present. We therefore recommend that the instrument be returned to Tektronix for **all** repair or calibration.

Flexible Plug-in Extenders (three required)	067-0616-00
---	-------------

NOTE

The plug-in extenders above may need minor modification in order to fit properly on some spectrum analyzers. Consult a Tektronix Service Center for procedure if necessary.

Phase Lock Module Extender	067-0868-00
Standard Module Extender	067-0869-00
Narrow Module Extender	067-0870-00
7L18 Service Kit (includes all three extenders listed above)	006-2487-00

SETTING THE CONSTANT K

When the B—SAVE A display mode is selected, the constant K describes the position of the trace vertically when B equals A. The range of K is from 0 to 255, and is factory set to 192. (Zero is below the baseline, but the trace is clamped at baseline in the Log Amplifier. 255 is off the top of the screen.)

Figure 3-2 shows the positions and relative values of the selection resistors, R3561 through R3568. The numbers given are actually exponents of two, and are selected by setting the respective resistor to the +5 V bus. For example, $192 = 2^7 + 2^6 = 1\ 100\ 00_2$. Therefore, R3564 and R3568 are connected to +5 V; the rest are connected to ground (refer also to Digital Storage Diagram 25).

ELAPSED TIME METER

The 7L18 elapsed time meter is located on the bottom of the mother board. The meter is activated whenever power is applied to the instrument, and has a total recording time of 5000 hours. After this time has elapsed, the meter can be replaced if desired.

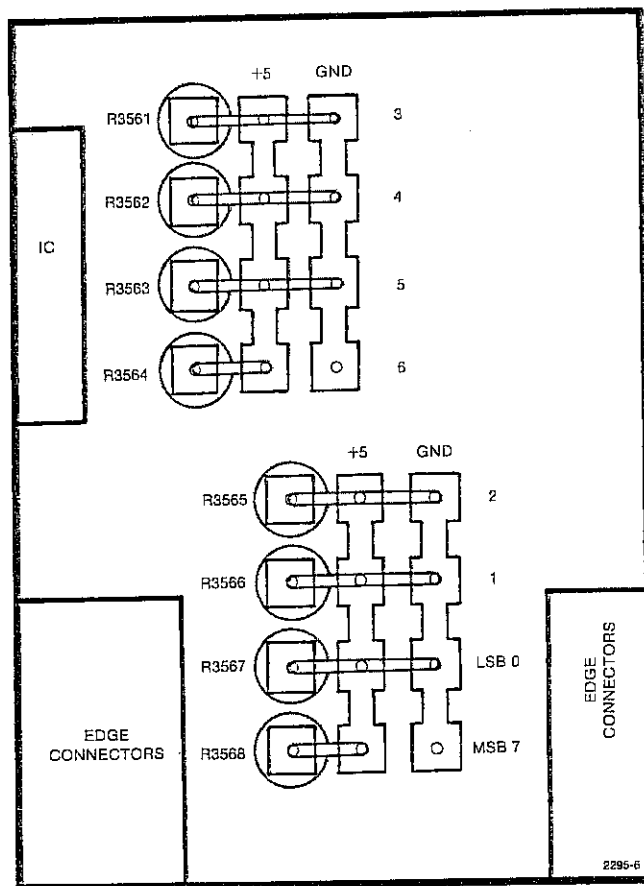

Figure 3-2. Locations and relative values of trace positioning resistors in B-SAVE A mode.

LOSS OF SIGNALS ON DISPLAY

If the analyzer seems to be working properly but no signal appears, check the two fuses located in the First LO and Preselector Driver board. To do this, open the RF Module, remove the fuses, and test them with an ohmmeter. See Figure 3-3.

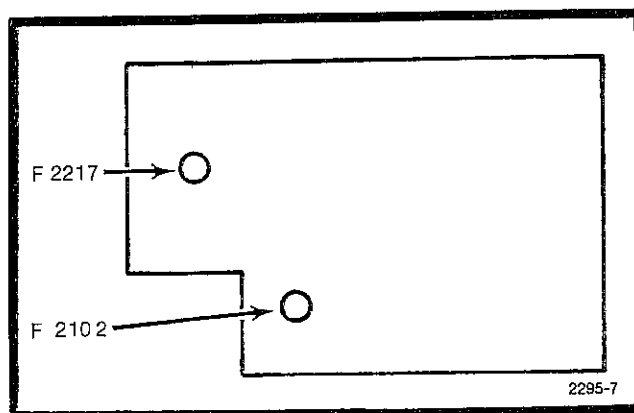

Figure 3-3. Location of F2217 and F2102 on First LO and Preselector Driver Board.

REPLACEMENT OF YIG OSCILLATOR

Two selected resistors, R2270 and R2276, located on the First LO and Preselector Driver board (diagram 13), may need to be replaced if the YIG oscillator is replaced. These resistors control the voltage required for the YIG oscillator to be within its second harmonic specification; this voltage is marked on the YIG oscillator housing. Refer to Table 3-1 to determine the resistor values, then replace the resistors with 1%, T0, 1/8W types.

Table 3-1

Voltage	R2270	R2276
11.0 to 11.4	14 k Ω	3.01 k Ω
11.5 to 11.9	16.5 k Ω	2.94 k Ω
12.0 to 12.4	20 k Ω	2.87 k Ω
12.5 to 12.9	24.9 k Ω	2.8 k Ω
13.0 to 13.4	32.4 k Ω	2.8 k Ω
13.5 to 13.9	45.3 k Ω	2.74 k Ω
14.0 to 14.5	76.8 k Ω	2.67 k Ω
14.6 to 15.0	not installed	2.61 k Ω

CALIBRATION

Introduction

This section consists of two parts: a Performance Check and a listing of Adjustment Procedures. Part 1 is used to determine the instrument's functional condition and to verify its performance with respect to given specifications. Part 2 provides the adjustment instructions for returning out-of-tolerance performance to specifications.

Do not arbitrarily perform an adjustment step without first establishing a need with the Performance Check; some adjustments may interact with the performance of other circuits. After performing any adjustment, always conduct a Performance Check to verify conformance with specifications.

TABLE OF CONTENTS

	Page
INTRODUCTION	4-1
Equipment Required for Calibration (Table 4-1)	4-2
PART 1 PERFORMANCE CHECK	
List of Performance Checks (Table 4-2)	4-4
List of Figures (Table 4-3)	4-5
Performance Check Record	4-6
Performance Check Steps	4-7
PART 2 ADJUSTMENT PROCEDURES	
List of Adjustment Steps (Table 4-7)	4-24
Instrument Construction	4-24
Flexible Plug-in Extenders and Module Assembly Extenders	4-25
Adjustment or Component Access	4-25
Microcomputer Component Access	4-28
Adjustment Procedures	4-31

Equipment Required for Calibration

The equipment listed in Table 4-1 is required for the Calibration of a 7L18 Spectrum Analyzer. The characteristics specified are minimum requirements. Substitute equipment must meet or exceed these characteristic requirements.

All items manufactured by Tektronix, Inc. may be ordered through your local Tektronix Field Office or representative.

Table 4-1

EQUIPMENT REQUIRED FOR CALIBRATION

Equipment or Test Fixture	Characteristics Required	Type or Model Recommended
PERFORMANCE CHECK		
7000-Series Oscilloscope with read-out	7000-Series interface with frequency bandwidth ≥ 50 MHz.	TEKTRONIX 7000-Series mainframe. ✓
Test Oscilloscope	Vertical sensitivity, 50 mV to 5 V/Div.	Any TEKTRONIX 7000-Series oscilloscope with plug-in units for a real-time display such as: a. 7A11, Single Trace Amplifier b. 7B50A, Time Base ✓
Time Mark Generator	Marker outputs, 1 s to 1 μ s; accuracy, 0.001%.	TEKTRONIX TM 501 and TM 500-Series Power Module. ✓
Function or Signal Generator	1 Hz to 3 MHz.	TEKTRONIX FG 503 Function Generator and TM 500-Series Power Module. ✓
Variable Voltage Source	0 to ± 12 V dc.	TEKTRONIX PS 501-1 Power Supply and TM 500-Series Power Module. ✓
Digital Frequency Counter	10 Hz to 1 GHz sensitivity, ≤ -35 dBm.	Hewlett Packard Model 5340A. ✓
Signal Generator(s)	800 MHz to 4500 MHz with output power \geq dBm.	Hewlett Packard Model 8614A. Hewlett Packard Model 8616A.
Sweep Oscillator	Minimum coverage, 2 GHz to 18 GHz; desirable coverage, 1.5 GHz to 18 GHz.	Hewlett Packard Model 8620C mainframe and Hewlett Packard Model 8629A Sweep Oscillator.
Power Meter with Power Sensor	Measures from -60 to -20 dBm full scale; frequency range, dc to 18 GHz.	Hewlett Packard Models 436A and 8482A.
Step Attenuators	Range, 0—110 dB in 10 dB steps; accuracy, ± 0.1 dB; frequency range, dc to 18 GHz.	Step attenuator such as Hewlett Packard Model 8496B calibrated by precision standard attenuators such as Weinschell Model AS-6.
2 GHz Bandpass	Filter must have a -40 dB response at ± 500 MHz.	
Harmonic Modulator		Tektronix Calibration Fixture, Part No. 067-0640-00.
N Male to BNC Female		Tektronix Part No. 103-0045-00.

Table 4-1 (cont)

Equipment or Test Fixture	Characteristics Required	Type or Model Recommended
ADJUSTMENTS		
All the items listed above plus the following are required for the adjustment procedures.		
Spectrum Analyzer	Frequency range to 2.0 GHz.	TEKTRONIX 7L18.
Signal Generator(s)	10 MHz to 520 MHz with calibrated output level to 0 dBm.	Hewlett-Packard Model 8624A.
Return Loss Bridge	10 MHz to 1 GHz, 50 ohms.	Wiltron VSWR Bridge Model 62NF50.
3 dB Miniature Attenuator	Frequency to 5 GHz; 5 mA connectors.	NARDA Model 4779 with male-to-male connectors.
Comb Generator	+10 dBm at 1 GHz	Tektronix Calibration Fixture, Part No. 067-0885-00.
DC Block		Tektronix Part No. 015-0221-00.
BNC Female-to-Selectro male		Tektronix Part No. 013-0180-00.
BNC-to-Selectro Adapter		Tektronix Part No. 175-0419-00.
BNC Female-to-SMA male		Tektronix Part No. 015-1018-00.
8" cable Tip Plugs to BNC		Tektronix Part No. 175-1178-00.
8" Coaxial Cable		Tektronix Part No. 012-0208-00.
8" Cable BNC to Harmonica		Must be fabricated; see drawing below.
Tuning Screwdriver		
Screwdriver, Flat		6" with 1/8" blade.
Screwdriver, Phillips type		No. 1.
Allen Wrenches		3/32", 5/64", 7/64".

PART 1—PERFORMANCE CHECK

The tolerances listed with each Performance Check Step are taken from the instrument specifications as described in Section 1 of this manual. Table 4-2 is a listing of the Performance Check steps.

Table 4-2
LIST OF PERFORMANCE CHECKS

Performance Check Step	Page
1. Check Calibrator (CAL OUT) Frequency	4-7
2. Check Calibrator (CAL OUT) Output Level	4-7
3. Check RF Attenuator Accuracy	4-8
4. Check LOG 2 dB/DIV and LIN Display Modes	4-9
5. Check Frequency Readout Accuracy	4-10
6. Check Resolution Bandwidth and Shape Factor	4-11
7. Check the REF VARIable and Gain Selector Range	4-11
8. Check Sensitivity	4-12
9. Check Stability	4-13
10. Check Incidental FM	4-14
11. Digital Storage	4-15
12. Check Frequency Response	4-15
13. Check Intermodulation Distortion	4-16
14. Check Triggering Operation and Sensitivity	4-17
15. Check External Horizontal Input Voltage Requirements	4-18
16. Check Video Output Level	4-19
17. Check Frequency Span Accuracy and Linearity	4-21
18. Check Sweep Rate	4-22
19. Check Preselector's Ultimate Rejection	4-23

Table 4-3
LIST OF FIGURES

Fig. No.	Description	Page
4-1	Calibrator Output Level Test Setup	4-7
4-2	RF Attenuator Test Setup	4-9
4-3	Display Mode Test Setup	4-10
4-4	Display Mode Log	4-11
4-5	Display Mode 10 dB/DIV	4-11
4-6	Measuring Average Noise Level as an Indication of Sensitivity	4-12
4-7	Measuring Stability Using MAX HOLD Feature of 7L18	4-13
4-8	Measuring Incidental FM	4-14
4-9	Using Digital Storage Feature to Measure Differential Between Two Displays ..	4-15
4-10	Frequency Response Test Setup	4-16
4-11	Intermodulation Distortion Check Test Setup	4-17

Table 4-3 (cont)

Fig. No.	Description	Page
4-12	Intermodulation Products (Distortion)	4-17
4-13	Triggering Operation and Sensitivity Test Setup	4-18
4-14	External Horizontal Input Voltage Test Setup	4-19
4-15	Video Output Level Test Setup	4-20
4-16	Video Output Test Waveshape	4-20
4-17	Freq. Span/Div Test Setup	4-21
4-18	Sweep Rate Test Setup	4-22
4-19	7L18 and 7000-Series Oscilloscope with Accessories and Tools used When Making Calibration Adjustments	4-25
4-20	Location of Side Panel and Retaining Rail Screws that must be moved to Gain Access to Calibration Adjustments	4-26
4-21	7L18 Showing how Two Sections are Hinged Together and Separated for Servicing	4-27
4-22	Location of the Hexagonal Head Screws that hold the Plug-in Module Assemblies	4-29
4-23	Location of Front Panel Securing Screws	4-30
4-24	Span Attenuator Test Points and Adjustments	4-31
4-25	Equipment Setup for Calibrating Sweep Timing	4-32
4-26	Time Marks Displayed for Calibrating Sweep Timing	4-33
4-27	Equipment Setup to Adjust and Calibrate Drive to FM Coil of the 1st LO	4-33
4-28	1 MHz Beat Notes as seen on the Display for Calibrating the 1st LO FM Coil Drive	4-34
4-29	Adjustments and Test Point Location on the 1st LO and Preselector Driver	4-35
4-30	Location of Reference Voltage Adjust and P2520	4-36
4-31	Location of Adjustments on Center Frequency DVM	4-37
4-32	Log and Video Amplifier Module on an Extender, Ready for Calibration	4-38
4-33	Log and Video Amplifier Test Points and Adjustments	4-39
4-34	Test Setup for Calibrating Phase Lock Control	4-40
4-35	Phase Lock Logic Control Test Points and Adjustments	4-41
4-36	Test Setup for Calibrating VR Circuits	4-42
4-37	Location of Connectors and Adjustments used When Calibrating the VR Circuits	4-43
4-38	Location of P2484 and 3-Cavity Filter	4-44
4-39	Bottom of 7L18 Showing Location of 510 MHz IF Module	4-45
4-40	Test Setup for Calibrating 510 MHz IF	4-46
4-41	Location of J2824, J2816 and Adjustments on Microcomputer Interface Board	4-47
4-42	Location of C2821 and C2815	4-48
4-43	500 MHz Calibrator and 2nd Mixer Adjustment and T.P. Locations	4-49
4-44	Digital Storage Calibration Adjustments	4-51
4-45	Location of B—SAVE A Reference Level Positioning Resistor Matrix	4-52
4-46	Adjustments for 300 kHz Filter, 300 kHz Noise Filter, and 3 MHz Noise Filter	4-53
4-47	Location of 3 MHz, Three-Section Filter Adjustments	4-54
4-48	Preselector Driver Adjustment and T.P. Locations	4-55
4-49	Vertical Microcomputer Interface Adjustment and T.P. Locations	4-56
4-50	Location of Preselector Driver Slope and Offset Correction Resistors Listed in Table 4-7	4-57
4-51	Test Setup for Calibrating Gain of the Waveguide Bands	4-61

Table 4-4
PERFORMANCE CHECK RECORD

Tektronix, Inc. gives permission to reproduce this Performance Check Record.

Performance Check Step	Tolerance	Reading
1. Check Calibrator Frequency	2.0 GHz \pm 0.01%	_____
2. Check Calibrator Output Level	-30 dBm \pm 0.5 dB	_____
3. Check RF Attenuator Accuracy	\pm 0.3 dB or 1% to 4 GHz; \pm 0.5 dB or 2% to 8 GHz.	_____
4. Check LOG 2 dB/DIV and LIN Display Modes	LOG 2 dB/DIV, \pm 0.4 dB/2 dB; LIN, Linear within 10% full screen.	_____
5. Check Frequency Readout Accuracy	\pm 5 MHz \pm 20% of Span/Div.	_____
6. Check Resolution Bandwidth and Shape Factor	Bandwidth, 3 MHz to 30 Hz \pm 20%; Shape Factor, 12:1 or less—30 Hz; Resolution, 4:1 or less—other Bandwidths.	_____
7. Check RF VARIABLE and Gain Selector Range	VAR, at least 10 dB. Gain, 90 dB in 10 dB steps.	_____
8. Check Sensitivity	-127 to -52 dBm.	_____
9. Check Stability	Within 2 kHz/hr x n, phaselocked. Within 50 kHz/hr x n, not phaselocked.	_____
10. Check Incidental FM	\geq 10 Hz x n, phaselocked. \geq 10 kHz x n, not phaselocked.	_____
11. Digital Storage	no tolerance	_____
12. Check Frequency Response	\pm 5 dB	_____
13. Check Intermodulation Distortion	1.5 to 1.8 GHz, down 70 dB with -40 dBm signals. 1.8 to 18 GHz, down 70 dB with -30 dBm signals.	_____
14. Check Triggering, Sensitivity	Internal, \geq 1 division. External, +0.5 Volt to 50 V peak. (15 Hz—1 MHz).	_____
15. Check External Horizontal Input Voltage Requirement	0 V to 10 V \pm 1 V.	_____
16. Check Video Output Level	500 mV \pm 5%/Div above baseline.	_____
17. Check Frequency Span, Accuracy and Linearity	Accuracy, 5% of Span; Linearity, 5% over center 8 div.	_____
18. Check Sweep Rate Accuracy	Within 5% of sweep rate.	_____
19. Check Preselectors Ultimate Rejection	At least 70 dB less on adjacent band.	_____

DETAILED PERFORMANCE CHECKS

Allow the instrument to warm up at least 30 minutes before proceeding with the Performance Checks.

1. Check Calibrator Frequency (Accuracy, 2.000 GHz \pm 0.01%)

The CAL OUT signal frequency can be measured by connecting it directly to the input of an accurate frequency counter such as the Hewlett-Packard 5340-A Digital Counter. The fundamental frequency of the CAL OUT signal is 500 MHz \pm 50 kHz.

CENTER FREQUENCY	2.0 GHz
Display Mode	LOG 2 dB/DIV
REFERENCE LEVEL	-20 dBm
RF Attenuation	10 dB
TRIGGERING	FREE RUN
Digital Storage	Display A/Display B
Band Selection	1.5—3.5
BASE LINE CLIPPER	Fully cw
TIME/DIV	AUTO
FREQ SPAN/DIV	500 kHz
RESOLUTION BANDWIDTH	3 MHz

2. Check Calibrator Output Level (-30 dBm \pm 0.5 dB)

The output level of the calibrator can be checked by either of two methods. The first is the power meter method, the second is a comparison method. Both of these are described below:

a. Power Meter Method

1. Connect the test setup as shown in Fig. 4-1. Set the 7L18 front panel controls as follows:

NOTE

Insertion loss of the filter, with attenuators (pads), measured at 2.0 GHz \pm 200 MHz, must be determined to within \pm 0.3 dB. Use approximately 3 dB minimum-loss matching pads on either side of the filter to ensure a 50-ohm impedance match.

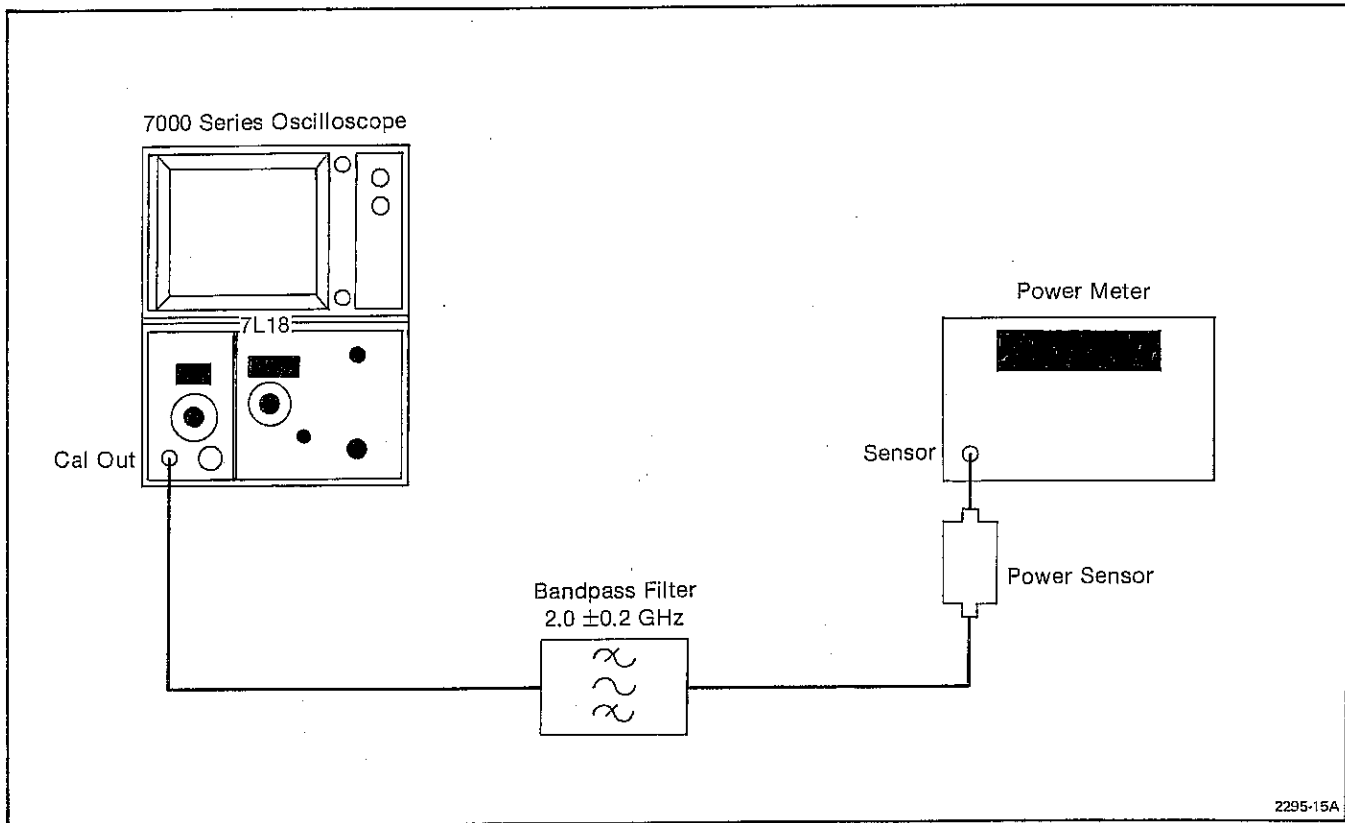

Fig. 4-1. Calibrator Output Level Test Setup.

Calibration—7L18 Interim Service

2. Connect the power meter through the filter to the CAL OUT connector and note the power reading. Power reading plus loss through filter and pads must equal $-30 \text{ dBm} \pm 2.55 \text{ dB}$.

3. Disconnect the test equipment to the 7L18.

b. Signal Substitution Method

NOTE

A power meter is used to verify the output level of the reference signal. Signal Generator harmonic distortion must be less than $+30 \text{ dB}$.

1. Apply the output of a 2.0 GHz signal generator, through a 3 dB attenuator, to the power meter and set the output level of the generator for a -30 dBm reading. Then disconnect the meter and (using the same instrument cable and attenuator), apply the calibrated reference signal to the RF INPUT of the 7L18.

2. Tune the signal to center screen and adjust the REF VAR control to position the top of the signal to a graticule line (2nd or 3rd from the reference-level line). Store the reference display by depressing the SAVE A pushbutton. It may be advisable to decrease the SPAN/DIV to obtain a broad display for a more accurate measurement.

3. Disconnect the -30 dBm reference signal, then apply the 7L18 CAL OUT signal to the RF INPUT.

4. Depress the B—SAVE A pushbutton and note the displacement of 7L18 CAL OUT signal amplitude from the reference stored in A memory. The displacement of the 7L18 calibrator 2.0 GHz signal level from the reference signal should not exceed $\pm 0.5 \text{ dB}$ (1.25 minor divisions with a 2 dB/DIV display mode).

NOTE

If greater accuracy is desired, the video can be amplified through an external amplifier, such as the 7A15, to increase the vertical sensitivity. This is done by connecting the VIDEO OUT signal to the external amplifier input and selecting the vertical amplification and TIME/DIV values that provide the degree of measurement accuracy desired.

3. Check RF Attenuator Accuracy (Incremental accuracy is $\pm 0.3 \text{ dB}$ or 1% of dB setting, whichever is greater, to 4 GHz; $\pm 0.5 \text{ dB}$ or 2% of dB setting, whichever is greater, from 4 GHz to 18 GHz.)

NOTE

Incremental accuracy tolerance values are not cumulative.

CAUTION

The RF Attenuator accuracy is checked at the factory to ensure that it is within specifications. Any change in attenuation should be large enough to notice during normal operation. If the exact attenuation error of the selector is required, a reference attenuator calibrated by the user or manufacturer to more rigid specifications than the 7L18 must be used. If there is any doubt about the accuracy of the available attenuators, this check should be omitted.

a. Connect the test setup as shown in Fig. 4-2. Set the front panel controls as follows:

CENTER FREQUENCY	2.0 GHz
Display Mode	LOG 2 dB/DIV
REFERENCE LEVEL	-80 dBm
RF Attenuation	0 dB
TRIGGERING	FREE RUN
Digital Storage	Display A/Display B
Band Selection	1.5—3.5
BASE LINE CLIPPER	Fully cw
TIME/DIV	AUTO
FREQ SPAN/DIV	As required
RESOLUTION BANDWIDTH	AUTO

b. Set the step attenuator to 90 dB. Apply a -0 dBm , 2.0 GHz signal from the signal generator through the step attenuator to the RF INPUT. Tune the CENTER FREQUENCY to the signal and adjust the REF VARIABLE control for a reference signal amplitude of four divisions.

c. Actuate the DIGITAL STORAGE SAVE A function to store this reference signal level for comparison with subsequent signals.

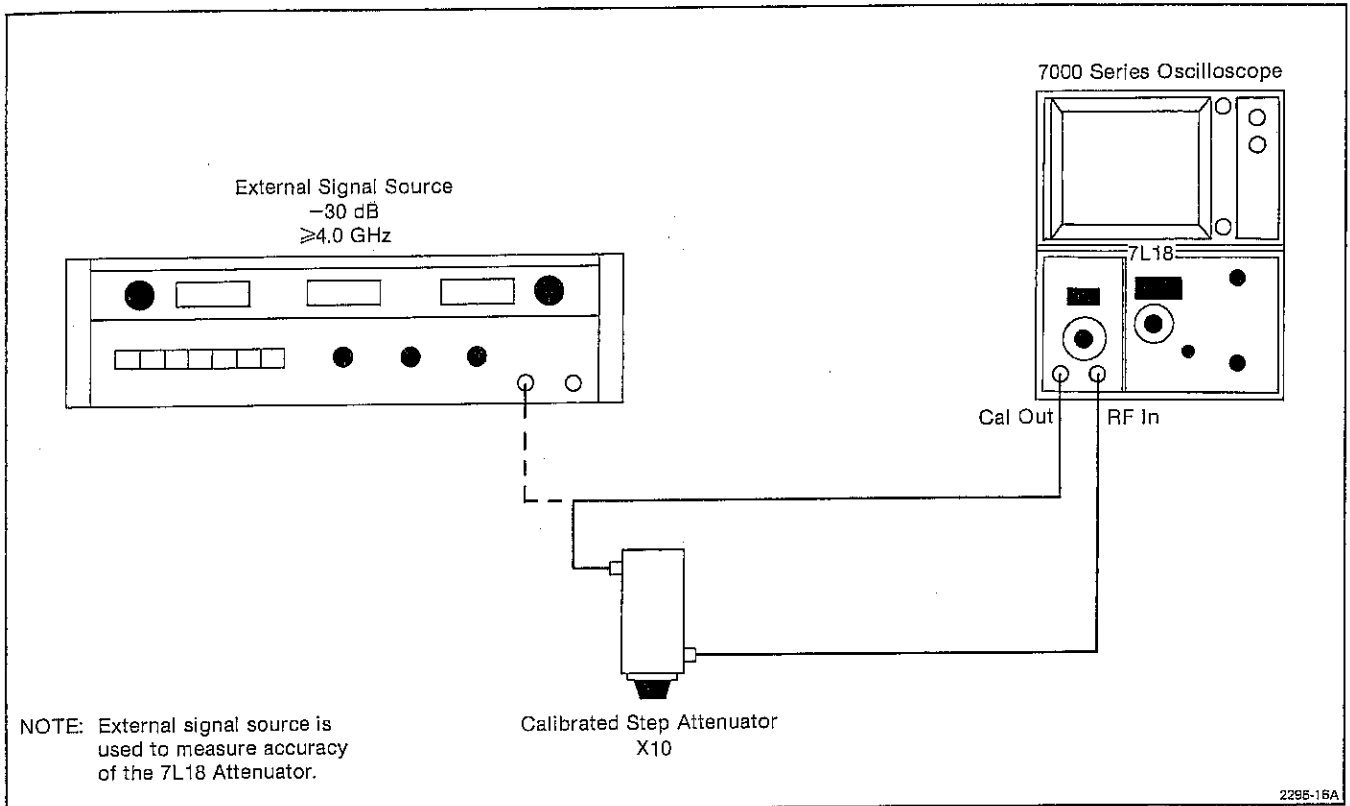

Fig. 4-2. RF Attenuator Test Setup.

d. Check the 7L18 RF Attenuator accuracy by increasing the RF attenuation setting in 10 dB increments while decreasing the reference step attenuator in 10 dB increments. The display amplitude should remain at four divisions ± 0.3 dB or 1% of the RF attenuator setting, whichever is greater.

e. Using the external -0 dBm, 4.0 GHz or higher signal source, repeat this procedure to check attenuator accuracy above 4 GHz.

f. Disconnect test equipment to the 7L18.

4. Check LOG 2 dB/DIV and LIN Display Modes (LOG 2 dB/DIV accuracy is within ± 0.4 dB/2 dB with a maximum error of 1.0 dB over any 10 dB range. LIN provides a linear display within 10% of full screen over the eight-division graticule height.)

The 10 dB/DIV display mode is checked under Operator's Functional Check procedure in the Operator's manual.

The performance procedure for the LOG 2 dB/DIV display is presented first followed by the LIN display procedure.

a. LOG 2 dB/DIV Display Mode

1. Connect the test setup as shown in Fig. 4-3. Set the front panel controls as follows:

CENTER FREQUENCY	2.0 GHz
RESOLUTION BANDWIDTH	3 MHz
Display Mode	LOG 2 dB/DIV
FREQ SPAN/DIV	1 MHz
RF Attenuation	10 dB
REFERENCE LEVEL	-30 dBm
Digital Storage	Display A/Display B

2. Tune the CENTER FREQUENCY to the signal. Adjust the REF VARIABLE control for a full-screen display (eight divisions) and switch 2 dB of attenuation into the circuit using the external 1 dB step attenuator.

3. Check that the displayed signal amplitude decreases by 1.0 ± 0.2 division.

4. Increase the step attenuator setting in 2 dB steps and check that the signal amplitude decreases 1.0 ± 0.2 division for each step. Total error over any 10 dB range must not exceed 1.0 dB (± 0.5 div).

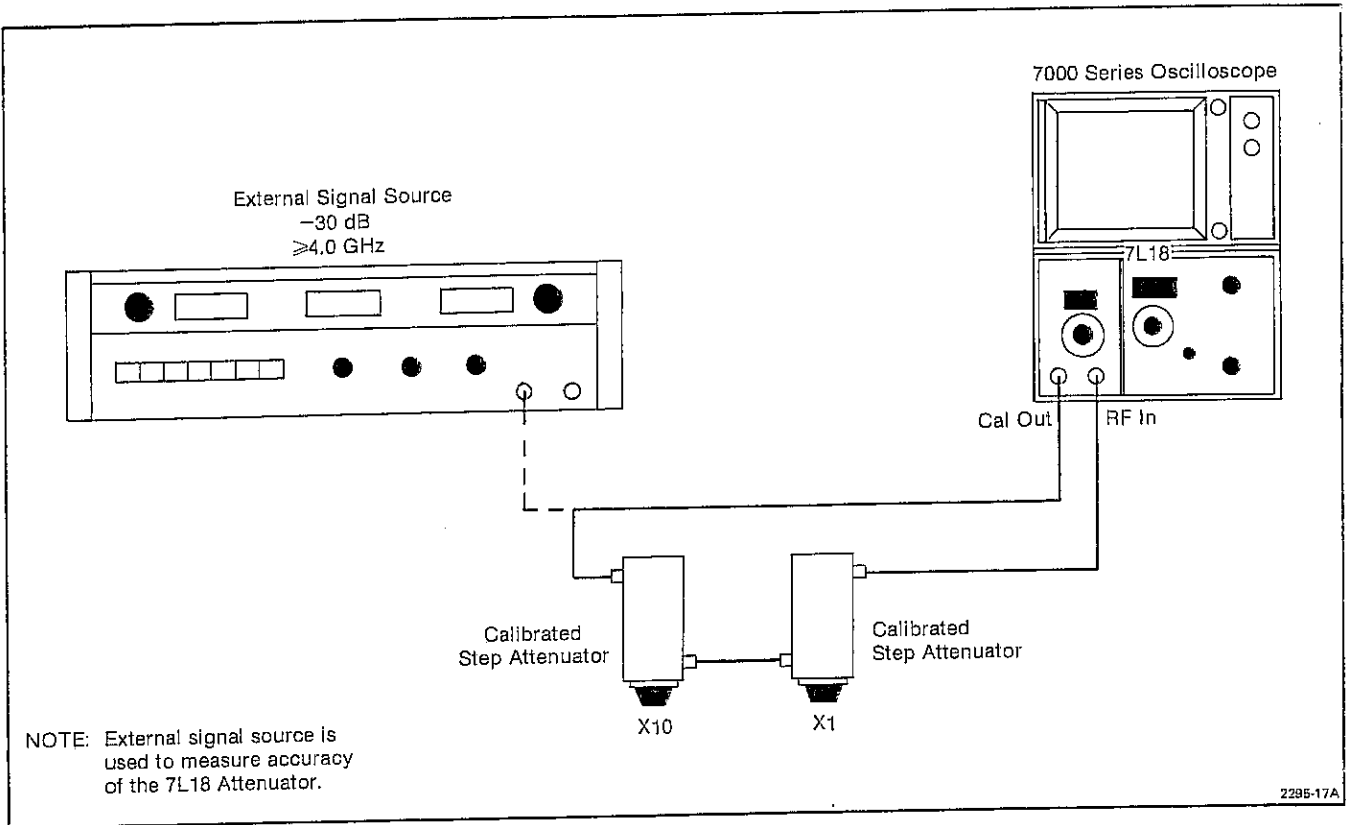

Fig. 4-3. Display Mode Test Setup.

b. LIN Display Mode

1. Reset the RF attenuator and step attenuator to 0 dB.
2. Set the display mode to LIN. Adjust the REF VARIABLE control for a full-screen display (eight divisions).
3. Switch the external attenuator to 6 dB.
4. Check that the signal amplitude decreases half screen or to 4.0 ± 0.8 division.
5. Increase the external attenuation to 12 dB.
6. Check that the signal amplitude decreases to 2.0 ± 0.8 division.
7. Disconnect the test equipment to the 7L18.

5. Check Frequency Readout Accuracy $\pm(5 \text{ MHz} + 20\% \text{ of Span/Div}) \times n$

NOTE

Due to hysteresis in the tuning system and residual magnetism buildup in the first (YIG) oscillator tuning coils, accuracy of the frequency readout should be checked by approaching each check point from the same direction (low to high). Degauss the tuning coil by pressing the DEGAUSS button within a few megahertz of the check point.

- a. With the Center Frequency readout calibrated at 2,000 GHz as described under Initial Operation and the SPAN/DIV at 1 MHz, tune the CENTER FREQUENCY to center the 2 GHz calibrator marker on screen. Press the DEGAUSS button and adjust PEAKING as the signal is tuned to center screen.

b. Check—the indicated frequency readout. Readout should be within 1.995 and 2.005 GHz or within ± 5.2 MHz of 2.000 GHz.

c. Repeat this procedure to check accuracy of the readout at the 3.0 GHz and 3.5 GHz markers. Accuracy must be within $\pm(5 \text{ MHz} + 20\% \text{ of } 1 \text{ MHz}) \times n$.

d. Switch to Band 2 (2.5—4.5 GHz) and repeat the procedure to check readout accuracy at 3.0 GHz, 3.5 GHz, and 4.0 GHz.

e. Since the other bands operate on harmonics of the oscillator fundamental, accuracy or error will be the same as that measured for the fundamental (bands 1 and 2) multiplied by the harmonic number (n) of the band.

NOTE

In some cases the calibrator harmonic may be very small or missing. Either ignore the check point or try reducing the resolution bandwidth (e.g., 30 kHz) to increase the signal to noise ratio or sensitivity. Adjust PEAKING at each check point.

6. Check Resolution Bandwidth and Shape Factor: (Bandwidth 3 MHz to 30 Hz $\pm 20\%$. Shape factor 12:1 or less for 30 Hz resolution and 4:1 or less for the other bandwidths.)

a. With the 7L18 tuned to the 2.000 GHz Calibrator signal and the Reference Level at -30 dBm, set the FREQ SPAN/DIV at 1 MHz and push the 3 MHz RESOLUTION BANDWIDTH button.

b. Switch the display mode to 2 dB/Div and adjust the REF VAR control so the signal amplitude level is full screen.

c. Measure the 6 dB bandwidth (see Fig. 4-4). Bandwidth must equal 3 MHz ± 600 kHz.

d. Switch the display mode to 10 dB/DIV, FREQ SPAN/DIV to 2 MHz, and the TIME/DIV to 0.5 s.

e. Estimate the -60 dB bandwidth by extending the slope of the response down through the noise level to the -60 dB graticule line. Calculate the shape factor (see Fig. 4-5). Shape factor must equal 4:1 or less.

f. Switch to 300 kHz RESOLUTION BANDWIDTH and 200 kHz Span/Div, then check the bandwidth and shape factor of the 300 kHz filter by repeating the foregoing procedure.

g. Switch to each remaining RESOLUTION BANDWIDTH selections, decrease the FREQ SPAN/DIV selection as necessary to check the bandwidth and shape factor of each selection. Bandwidth must be within 20% of that selected, shape factor is 4:1 or less except the 30 Hz filter which is 12:1 or less.

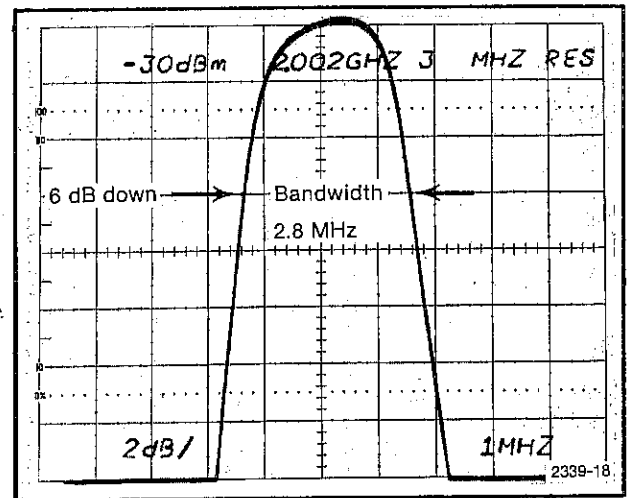

Fig. 4-4. Display Mode Log.

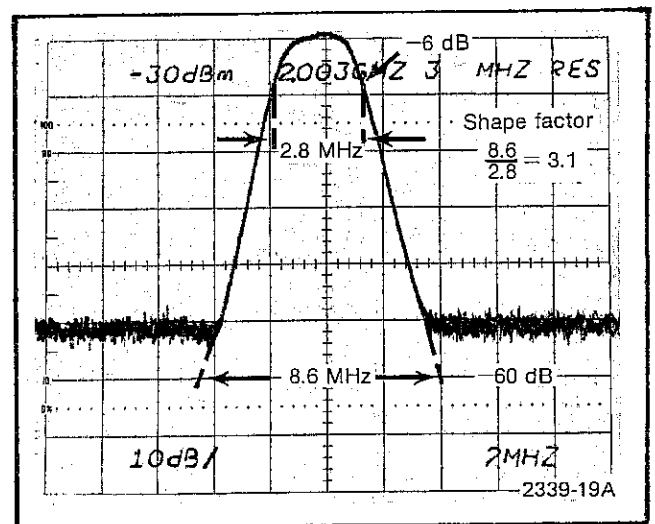

Fig. 4-5. Display Mode 10 dB/DIV.

7. Check the REF VARIable and Gain Selector Range: (Variable range is at least 10 dB, IF Gain selector range is 90 dB in 10 dB steps)

a. With the controls set as described in step 6 and the SPAN/DIV at 2 kHz, increase the RF Attenuator setting to 50 dB (Reference Level of +20 dBm).

b. Rotate the REF VAR control through its range and note signal amplitude change.

Calibration—7L18 Interim Service

c. Check—REF VAR control range should increase the signal level 10 dB or more. Return the control to its CAL detent.

d. Check—that the IF Gain selector increases the signal amplitude 10 dB \pm 1 dB for each increment in the blue (10 dB/Div) sector and decreases the gain 10 dB \pm 1 dB in the amber (gain reduction) sector. Overall deviation should not exceed 2 dB.

e. Change the display mode to 2 dB/DIV. Insert or add a 20 dB attenuator between the CAL OUT and RF Input connector. Set the RF Attenuator at 20 dB and the Gain selector for -50 dBm reference level readout (last position in the blue sector). Adjust the signal level to a graticule reference line (one or two divisions below center screen) with the REF VAR control.

f. Increase the RF Attenuator and IF Gain selector in 10 dB steps and check that each step of the IF Gain selector, in the 2 dB/Div portion (white sector), increases the calibrator signal amplitude 10 dB \pm 1 dB.

NOTE

Resolution bandwidth and frequency span must be reduced to check the last two Gain selector steps.

g. Return the RF Attenuator to 20 dB, the IF Gain selector for a Reference Level readout of -50 dBm, SPAN/DIV to 2 kHz, and RESOLUTION BANDWIDTH to 3 kHz. Adjust the Calibrator signal amplitude to a graticule reference line with the REF VAR control.

h. Check—gain variation as different resolution bandwidths are selected. Variation must not exceed 0.5 dB (1/4 div).

NOTE

When checking the 30 Hz resolution bandwidth, reduce the SPAN/DIV to 0.2 kHz.

i. Return the RF Attenuator to 0 dB, IF Gain selector for a Reference Level readout of -30 dBm, SPAN/DIV to 2 kHz, RESOLUTION BANDWIDTH to 3 kHz, and REF VAR control to CAL detent.

8. Check Sensitivity: (-127 to -52 dBm, depending on resolution bandwidth and frequency band)

NOTE

Sensitivity for the 7L18 is specified according to the input or average noise level. The 7L18 calibrator is the reference used to calibrate the display. Accuracy of this reference can be verified using a 2.0 GHz bandpass filter with known loss and an accurate power meter.

a. Set the front panel controls as follows:

CENTER FREQUENCY	Within Band 1 (1.5 to 3.5 GHz)
Display Mode	10 dB/DIV
RF Attenuator	0 dB
REFERENCE LEVEL	-30 dBm
FREQ SPAN/DIV	2 kHz
RESOLUTION BANDWIDTH	3 MHz
TIME/DIV	0.5 s
PEAK/AVERAGE Cursor	Top of Screen
Digital Storage	Display A/Display B

b. Disconnect the calibrator signal from the RF INPUT.

c. Check—noise level below the -30 dBm reference level (see Fig. 4-6). Must not exceed -79 dBm (see Table 4-5).

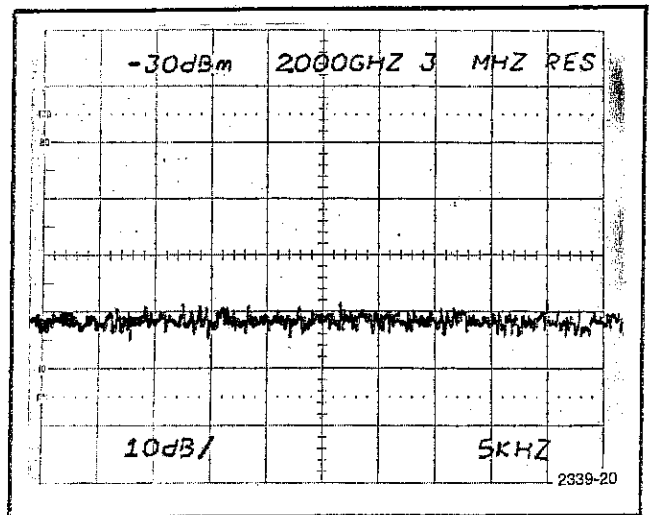

Fig. 4-6. Measuring Average Noise Level as an Indication of Sensitivity.

Table 4-5
7L18 SENSITIVITY

Frequency Range (GHz)	Average Noise Level dBm (max.)					
	Resolution Bandwidth					
	3 MHz	0.3 MHz	30 kHz	3 kHz	300 Hz	30 Hz
1.5 to 3.5	-79	-89	-99	-109	-119	-127
2.5 to 4.5	-79	-89	-99	-109	-119	-127
3.5 to 7.5	-69	-79	-89	-99	-109	-117
6.5 to 12.5	-67	-77	-87	-97	-107	-115
9.5 to 18.0	-52	-62	-72	-82	-92	
12.5 to 18.0	-50	-60	-70	-80	-90	
18.0 to 26.5 ^a	-60	-70	-80	-90	-100	
26.5 to 40 ^a	-55	-65	-75	-85	-95	
40 to 60.5 ^a	-45	-55	-65	-75	-85	

^aHigh performance type mixers.

d. Check—noise level for 300 kHz and 30 kHz resolution bandwidths. Compare this level with the characteristics listed in Table 4-5.

e. Increase the IF Gain for a REFERENCE LEVEL of -60 dBm and reduce TIME/DIV to 10 s.

f. Check—average noise level for 3 kHz, 300 Hz, and 30 Hz resolution bandwidths. Compare these levels with characteristics listed in Table 4-5.

g. Repeat this procedure for each coaxial (internal) mixer band (1—5).

b. Switch PHASE LOCK to AUTO and then decrease the SPAN/DIV to 500 Hz keeping the signal centered on screen with the tuning controls.

c. Activate MAX HOLD. Do **NOT** disturb the instrument for one hour.

d. Check—stability or drift as the width of the response (see Fig. 4-7) over the specified time period. Drift must not exceed 2 kHz.

e. Deactivate MAX HOLD, switch PHASE LOCK to OFF, SPAN/DIV to 20 kHz, re-center the calibrator signal, then reactivate MAX HOLD.

f. Check—stability over one hour period with phase lock inoperative. Drift must not exceed 50 kHz.

NOTE

This procedure may be used to check sensitivity characteristics for optional external waveguide mixers when an accurate signal source is used to establish a reference.

9. Check Stability: (Within 2 kHz/hr x n, when phase locked; and within 50 kHz/hr x n when phase lock is inoperative)

NOTE

Stability is checked only after a 2 hour warmup period at a fixed frequency.

a. Set the Display Mode to 10 dB/DIV, SPAN/DIV to 1 MHz, RESOLUTION BANDWIDTH and TIME/DIV at AUTO. Tune the Calibrator signal to center screen, and push DEGAUSS button.

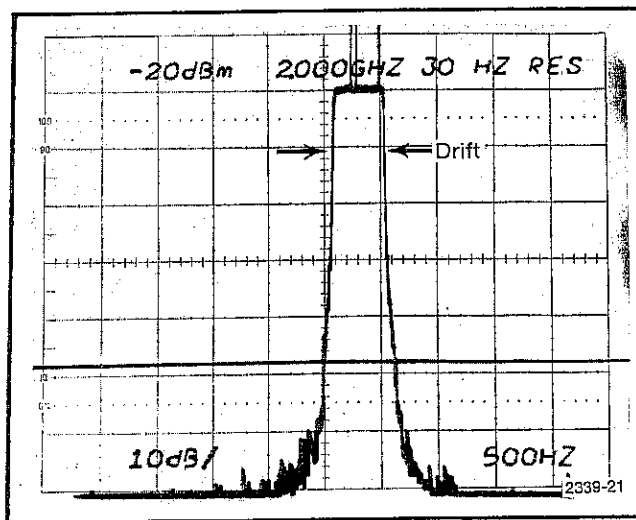

Fig. 4-7. Measuring Stability Using MAX HOLD Feature of 7L18.

10. Check Incidental FM: (≤ 10 Hz x n when phase locked; ≤ 10 kHz x n when not phase locked)

NOTE

This measurement is dependent on oscillator stability; therefore, the instrument must have at least a 2 hour warmup period. Recommend performing this check after stability has been checked.

a. Set the 7L18 controls as follows:

CENTER FREQUENCY	1.00
FREQ SPAN/DIV	100 kHz
RESOLUTION BANDWIDTH	30 kHz
TIME/DIV	AUTO
Display Mode	LIN
REFERENCE LEVEL	-30 dBm
Digital Storage	ON
PHASE LOCK	AUTO

b. With the calibrator signal tuned to center screen, decrease SPAN/DIV to 10 kHz and then position the signal with the FINE tune control, so the slope (horizontal span versus vertical excursion) or the filter response can be measured over four divisions of amplitude (see Fig. 4-8).

c. Calculate the frequency excursion per division of amplitude (e.g., if the horizontal excursion is 5 kHz over the four divisions, the slope equals 1.25 kHz/Div).

d. Switch PHASE LOCK to "OFF", decrease SPAN/DIV to 0 Hz, in steps, keeping the signal centered with the tuning control. At 0 Hz span, carefully tune so the display is near mid screen (see Fig. 4-8). Set TIME/DIV to 0.5 s.

e. Check—the peak-to-peak amplitude deviation over a 3 second (6 division) span. Deviation must not exceed 10 kHz (8 divisions at 1.25 kHz/div).

NOTE

Disregard radical excursions caused by frequency drift of the oscillator. Since FM is a multiple of "n" or the oscillator harmonic, there is no need to check bands above 4.5 GHz.

f. Switch PHASE LOCK to AUTO, SPAN/DIV to 10 kHz, TIME/DIV to AUTO, and RESOLUTION BANDWIDTH to 3 kHz.

g. Keep the calibrator signal centered with the FINE tuning control as the SPAN/DIV is reduced to 0.2 kHz and the RESOLUTION BANDWIDTH to 300 Hz.

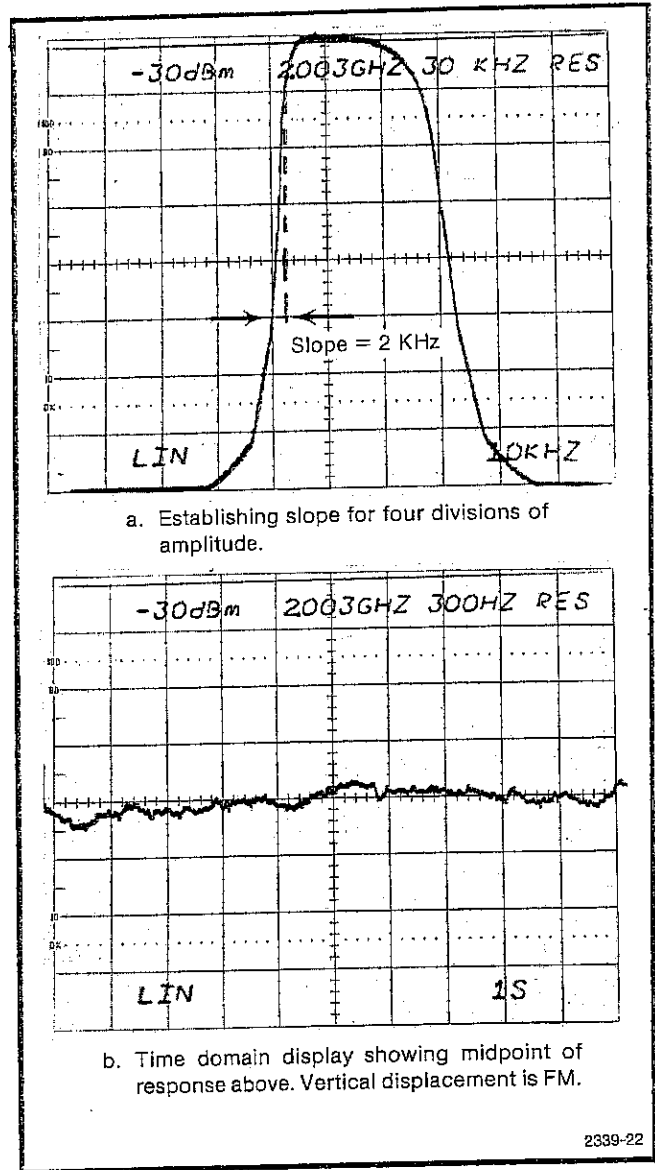

a. Establishing slope for four divisions of amplitude.

b. Time domain display showing midpoint of response above. Vertical displacement is FM.

Fig. 4-8. Measuring Incidental FM.

h. Again calculate the frequency excursion per division of display (e.g., 60 Hz ÷ 4 = 15 Hz/div).

i. Decrease the FREQ SPAN/DIV to 0 Hz and carefully adjust the FINE tuning to center the response. Set TIME/DIV to 0.5 s.

j. Check—the peak-to-peak deviation over six divisions (3 seconds) of span. Must not exceed 10 Hz (3/4 of a division as per the example in part h).

11. Digital Storage

a. Set the 7L18 controls as follows:

CENTER FREQUENCY	2.000 (1.500) GHz
Display Mode	10 dB/DIV
RF Attenuator	30 dB
REFERENCE LEVEL	+0 dBm
TIME/DIV	0.2 s
FREQ SPAN/DIV	1 MHz
RESOLUTION BANDWIDTH	3 MHz
Digital Storage	Display A

b. With the calibrator signal applied to the RF INPUT, tune the signal to center screen and activate SAVE A.

c. Change the RF Attenuator to 40 dB and activate DISPLAY B digital storage. Display B of the Calibrator signal should be 10 dB less than display A.

d. Activate B—(SAVE A).

e. Check—B—(SAVE A) display should be the difference between display B and display A (approximately 10 dB), see Fig. 4-9.

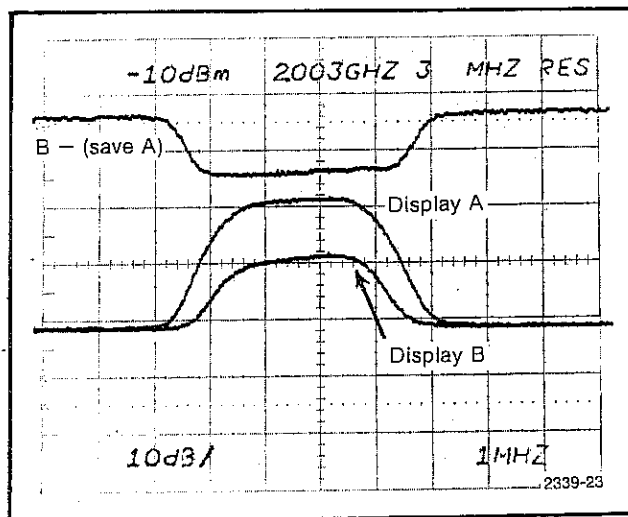

Fig. 4-9. Using Digital Storage Feature to Measure Differential Between Two Displays.

f. Deactivate SAVE A and B—(SAVE A) functions and activate MAX HOLD.

g. Change the RF Attenuator and CENTER FREQUENCY settings and then note that the MAX HOLD function retains and holds the maximum signal amplitude and frequency excursion.

h. Deactivate MAX HOLD and select DISPLAY A. Select AUTO BANDWIDTH resolution and reduce the SPAN/DIV to 100 kHz keeping the signal centered on screen with the tuning controls.

i. Vary the PEAK/AVERAGE control to shift the cursor over the screen and note that signal and noise are averaged below the cursor.

12. Check Frequency Response (Frequency Response from 1.5 GHz to 18 GHz is within ± 5 dB)

Frequency Response is the peak-to-peak variation of the displayed amplitude over a specified center frequency range, measured at the center frequency.

An exact measurement of frequency response over the 1.5 GHz to 18 GHz range would require setting each discrete frequency within the range to Center Frequency, maximizing the display with the PEAKING control, and noting the displayed amplitude. A procedure that is not exact but more expeditious and provides an indication of the instrument performance with respect to frequency response may be conducted as follows. First, perform a flatness check over the full frequency span with the PEAKING control set to the grey area. Note any segments of the display that are outside the ± 5 dB specification. Second, tune to the center of these segments, reduce the span as necessary to encompass the segment, then adjust the PEAKING control for optimum response and recheck the flatness of the segment for conformance with the specification.

NOTE

Because cable losses become significant at frequencies above 1.0 GHz, use short (25 inch or less) semi-rigid cable, with precision Type N fittings between the signal generator and the 7L18 RF INPUT connector. Impedance match between the source and the RF INPUT is important; refer to "Signal Application" under General Operating Information for more details.

a. Connect the test setup as shown in Fig. 4-10. Set the front panel controls as follows:

CENTER FREQUENCY	9.5 GHz
Band Selection	9.5—18.0
Display Mode	2 dB/DIV
REFERENCE LEVEL	-30 dBm
RF Attenuation	10 dB
TRIGGERING	FREE RUN
Digital Storage	Display A/Display B
BASE LINE CLIPPER	Fully cw
TIME/DIV	50 ms
FREQ SPAN/DIV	MAX
RESOLUTION BANDWIDTH	AUTO
PEAKING	Center of grey area

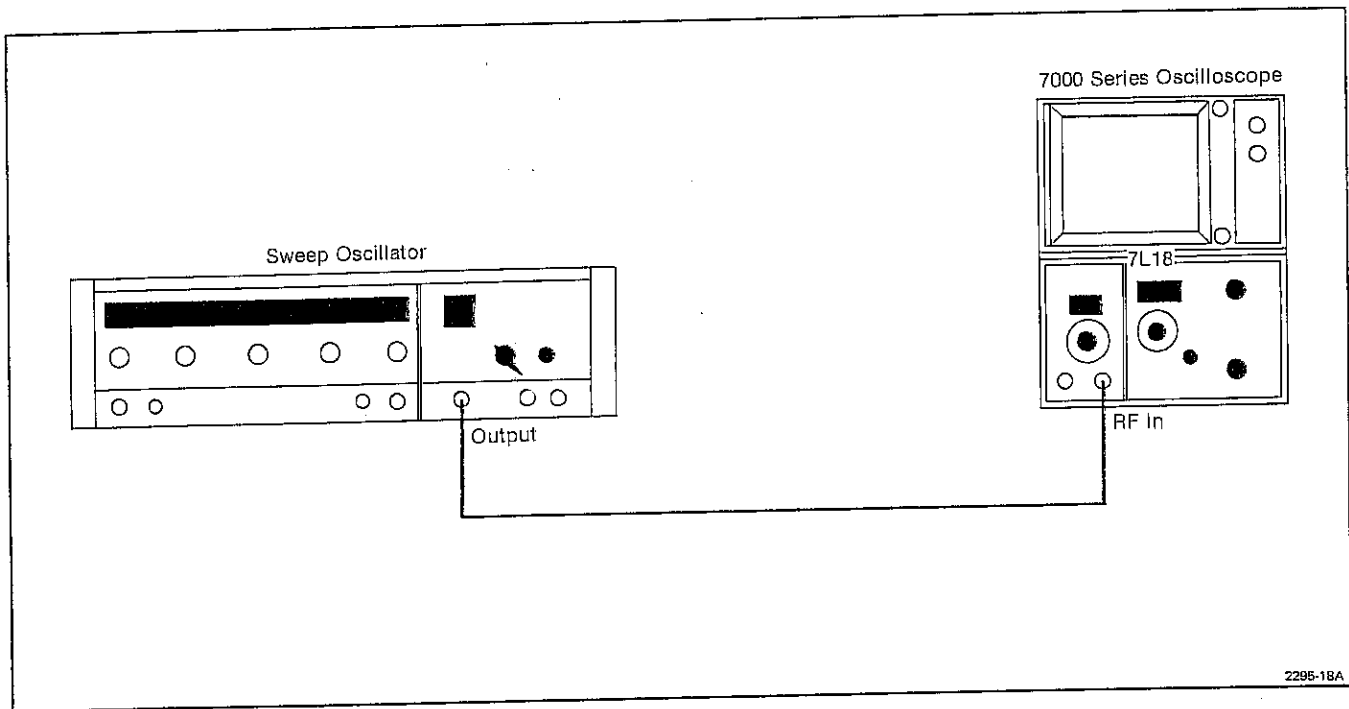

Fig. 4-10. Frequency Response Test Setup.

NOTE

Use power meter (see Calibration Output Level Check) to check flatness of the sweeper and cable before proceeding.

b. Set the frequency sweeper to sweep from 9.5 GHz to 18.0 GHz. Apply the sweeper output to the RF Input of the 7L18 and adjust the output for a mean average about a graticule line.

c. Check the flatness across the full frequency span. Note any segments where the flatness varies more than ± 5 dB with respect to the mean reference level. Total allowable deviation is 10 dB.

d. Tune to the center of an out of tolerance segment, reduce the SPAN/DIV as necessary, optimize the response with the PEAKING control, and recheck the flatness of the segment.

e. Change Band Selection to 6.5—12.5 GHz. Change the Sweeper controls to produce the appropriate frequencies, and repeat parts c and d.

f. Repeat this procedure for each Band Selection.

13. Check Intermodulation Distortion (Third-order products are down 70 dB or more from any two -40 dBm signals for 1.5 to 1.8 GHz, and 70 dB or more from any -30 dBm signals for 1.8 to 18 GHz, referenced to the input mixer, when the IF gain is not in the gain-reduced, red, position.)

a. Connect the test setup as shown in Fig. 4-11. Set the front panel controls as follows:

CENTER FREQUENCY	2.0 GHz
Display Mode	LOG 10 dB/DIV
REFERENCE LEVEL	-30 dBm
RF Attenuation	10 dB
TRIGGERING	FREE RUN
Digital Storage	Display A/Display B
Band Selection	1.5—3.5
BASE LINE CLIPPER	Fully cw
TIME/DIV	AUTO
FREQ SPAN/DIV	1 MHz
RESOLUTION BANDWIDTH	30 kHz

b. Apply a 2.001 GHz, -10 dBm signal from No. 1 signal generator through a 20 dB attenuator and the "T" connector to the RF INPUT. The displayed signal should appear about one division to the right of center screen.

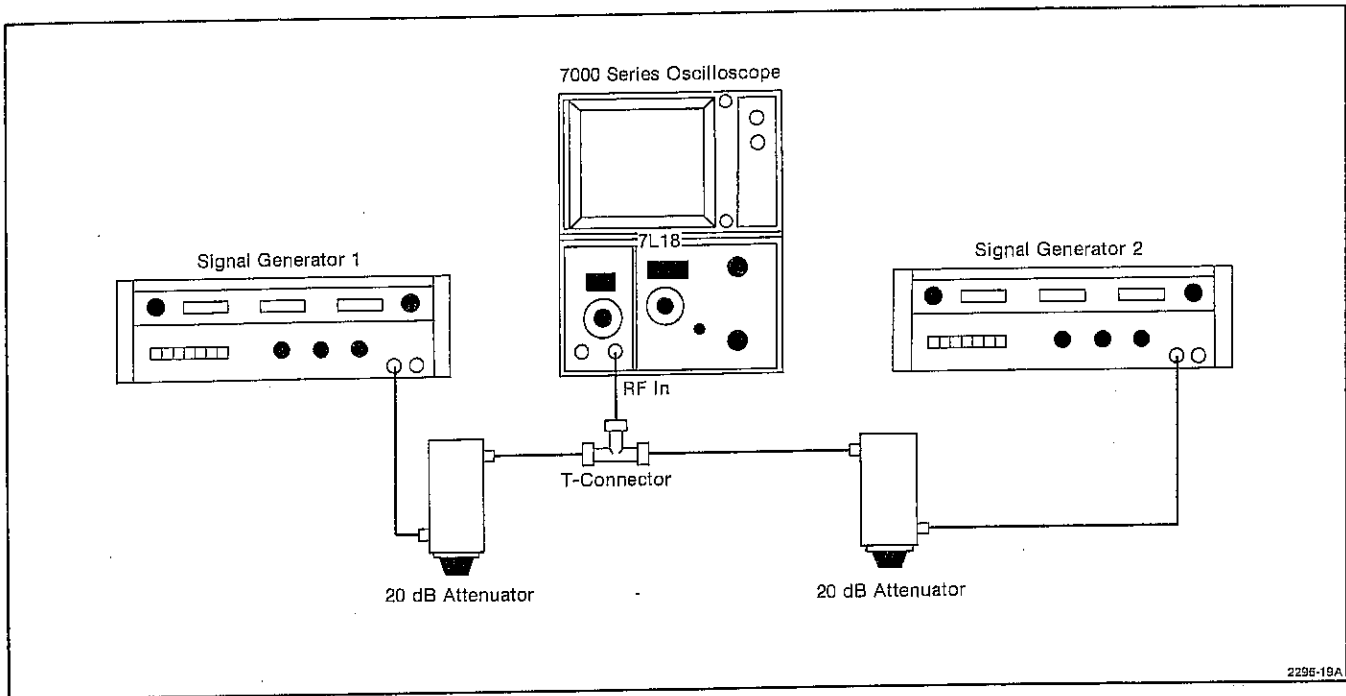

Fig. 4-11. Intermodulation Distortion Check Test Setup.

c. Apply a 2.000 GHz, -10 dBm signal from No. 2 signal generator through a 20 dB attenuator and the "T" connector to the RF INPUT. The displayed signal should appear at center screen over the center frequency line. Adjust the output level of the signal generators so that both signals are full screen (eight divisions).

d. Reduce the RESOLUTION BANDWIDTH to 300 Hz.

e. Check that the third order intermodulation product (about three divisions from center screen) are at least 7.0 divisions (-70 dB) below the full-screen signals (see Fig. 4-12).

f. Increase RF Attenuation to 20 dB.

g. Decrease the signal generator frequencies to check IM below 1.8 GHz. IM products must be down 70 dB or more below the reference signals.

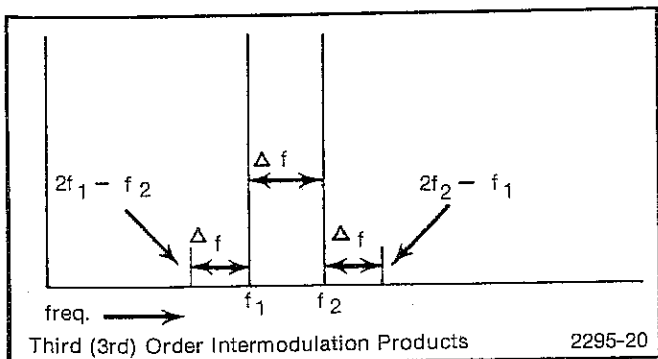

Fig. 4-12. Intermodulation Products (Distortion).

h. Increase the input frequencies to check IM distortion above 2.0 GHz using the preceding procedures. IM products must be down 70 dB or more below the reference signals.

i. Disconnect the test equipment to the 7L18.

14. Check Triggering Operation and Sensitivity (Internal trigger sensitivity ≥ 1 division, external trigger sensitivity +0.5 V to 50 V peak, 15 Hz—1 MHz.)

a. Connect the test setup as shown in Fig. 4-13. Set the 7L18 front panel controls as follows:

CENTER FREQUENCY	2.0 GHz
Display Mode	LIN
REFERENCE LEVEL	-30 dBm
RF Attenuation	0 dB
TRIGGERING	INT/EXT
Digital Storage	Display A/Display B
Band Selection	1.5—3.5
BASE LINE CLIPPER	Fully cw
TIME/DIV	20 ms
FREQ SPAN/DIV	500 MHz
RESOLUTION BANDWIDTH	3 MHz

b. Apply a 2.0 GHz signal from the UHF signal generator to the RF INPUT of the 7L18 and tune the CENTER FREQUENCY to the signal.

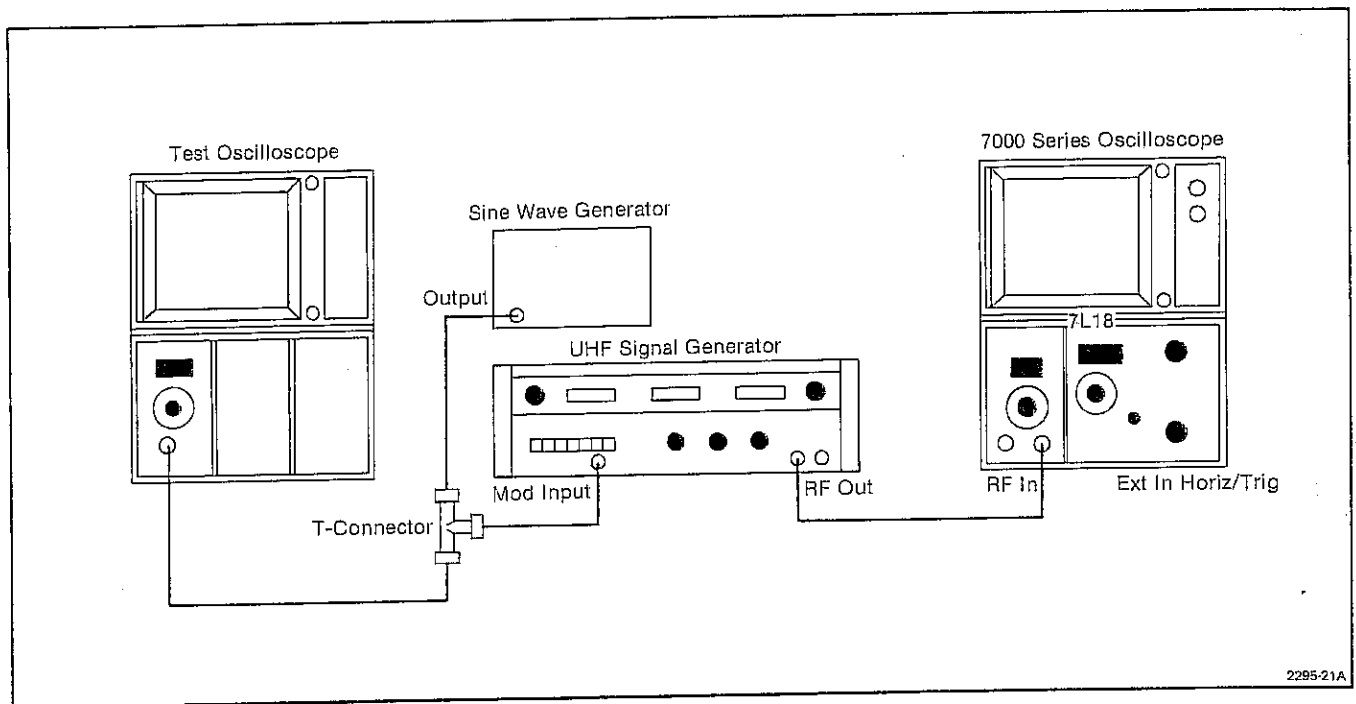

Fig. 4-13. Triggering Operation and Sensitivity Test Setup.

c. Apply the output of a sine-wave signal generator to the modulation input of the UHF generator. Reduce the RESOLUTION BANDWIDTH to 300 kHz, then decrease the FREQ SPAN/DIV to 0, keeping the CENTER FREQUENCY tuned to the UHF signal. Tune to the side of the signal with the FINE tuning adjustment so the display amplitude is about half screen.

d. Modulate the UHF signal with 15 Hz, adjusting the sine-wave generator output until the display amplitude of the 15 Hz modulation equals one division.

e. Check internal trigger operation by tuning through the 15 Hz to 1 MHz frequency range and noting that the display remains synchronized over the frequency range of the trigger input.

NOTE

At the upper limit (1 MHz) it may be necessary to detune the center frequency to obtain a modulation envelope of one division.

f. Remove the cables connecting the sine-wave generator to the UHF generator and the UHF generator to the 7L18. Return the RESOLUTION BANDWIDTH to 3 MHz.

g. Apply a 1 kHz signal from the sine-wave generator through a BNC to pin-jack cable to the EXT IN HORIZ/TRIG jacks on the 7L18. Using the test oscilloscope to monitor the generator output, set the sine-wave generator output level for 1.0 V peak-to-peak. Activate the SGL SWP function.

h. Check external triggering by depressing the SGL SWP pushbutton and checking for a single sweep each time the sweep button is depressed. As the applied trigger signal frequency is increased from 15 Hz to 1 MHz, ensure that the input level remains at 0.5 V peak.

i. At some frequency within the 15 Hz to 1 MHz range, increase the input level to 50 V peak and note that the display remains triggered.

j. Disconnect the test equipment to the 7L18.

15. Check External Horizontal Input Voltage Requirement (0 V to 10 V \pm 1 V should sweep the analyzer the full frequency span)

a. Connect the test setup as shown in Fig. 4-14. Set the 7L18 TIME/DIV to EXT IN, TRIGGERING to FREE RUN, FREQ SPAN/DIV to 500 MHz, and RESOLUTION BANDWIDTH to 300 kHz.

b. With the EXT IN HORIZ/TRIG pin-jack grounded, position the crt beam of the 7L18 oscilloscope to the left graticule edge to establish a zero voltage reference.

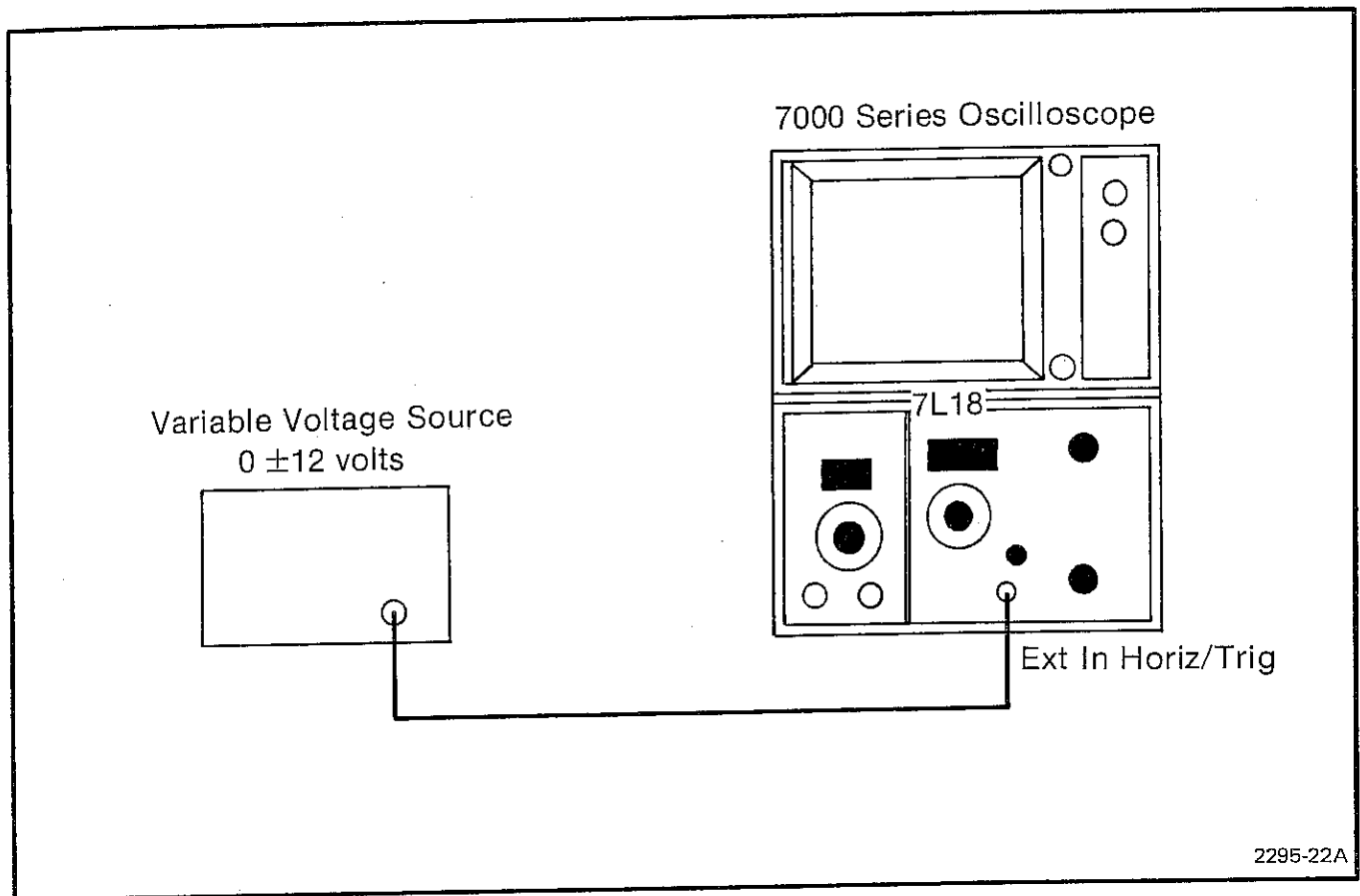

2295-22A

Fig. 4-14. External Horizontal Input Voltage Test Setup.

c. Apply a variable voltage source, such as the variable power supply, to the EXT IN HORIZ/TRIG pin-jacks and adjust the voltage output so the beam is deflected the full 10-division span.

d. Check—the voltage source should equal $+10\text{ V} \pm 1\text{ V}$.

NOTE

An alternate method using a sine wave to check external sweep operation is as follows:

1. After the crt beam has been positioned to the zero voltage reference as described in part b, apply a 1 kHz sine wave with an amplitude of 10 V peak (20 V p-p, referenced at 0 V) to the EXT IN HORIZ/TRIG connector.

2. The crt beam should sweep the full 10 divisions (+0.1 division) of the graticule when the input voltage is 10 V peak $\pm 1\text{ V}$.

e. Disconnect the voltage or signal source to the EXT IN HORIZ/TRIG connector and return the TIME/DIV selector to AUTO.

16. Check Video Output Level ($500\text{ mV} \pm 5\%$ of video signal per division of display above the baseline)

a. Connect the test setup as shown in Fig. 4-15. Apply the VIDEO OUT signal of the 7L18 to the input of a dc-decoupled test oscilloscope with sensitivity set to 1 V/div. Set the 7L18 Display Mode to LOG 2 dB/DIV, REFERENCE LEVEL to -20 dBm , TIME/DIV to AUTO, FREQ SPAN/DIV to 100 kHz, and RESOLUTION BANDWIDTH to 300 kHz.

b. Position the base of the CAL OUT signal on the bottom graticule line of the 7L18 display using the VERTICAL POSITION control and adjust the REF VARIABLE control for eight divisions of signal amplitude.

c. Check the amplitude of the video output signal using the test oscilloscope. Note the dc zero volt level. Video amplitude should equal 4.0 volts $\pm 0.2\text{ volt}$ as measured from the zero voltage reference level. See Fig. 4-16.

d. Disconnect the test equipment to the 7L18.

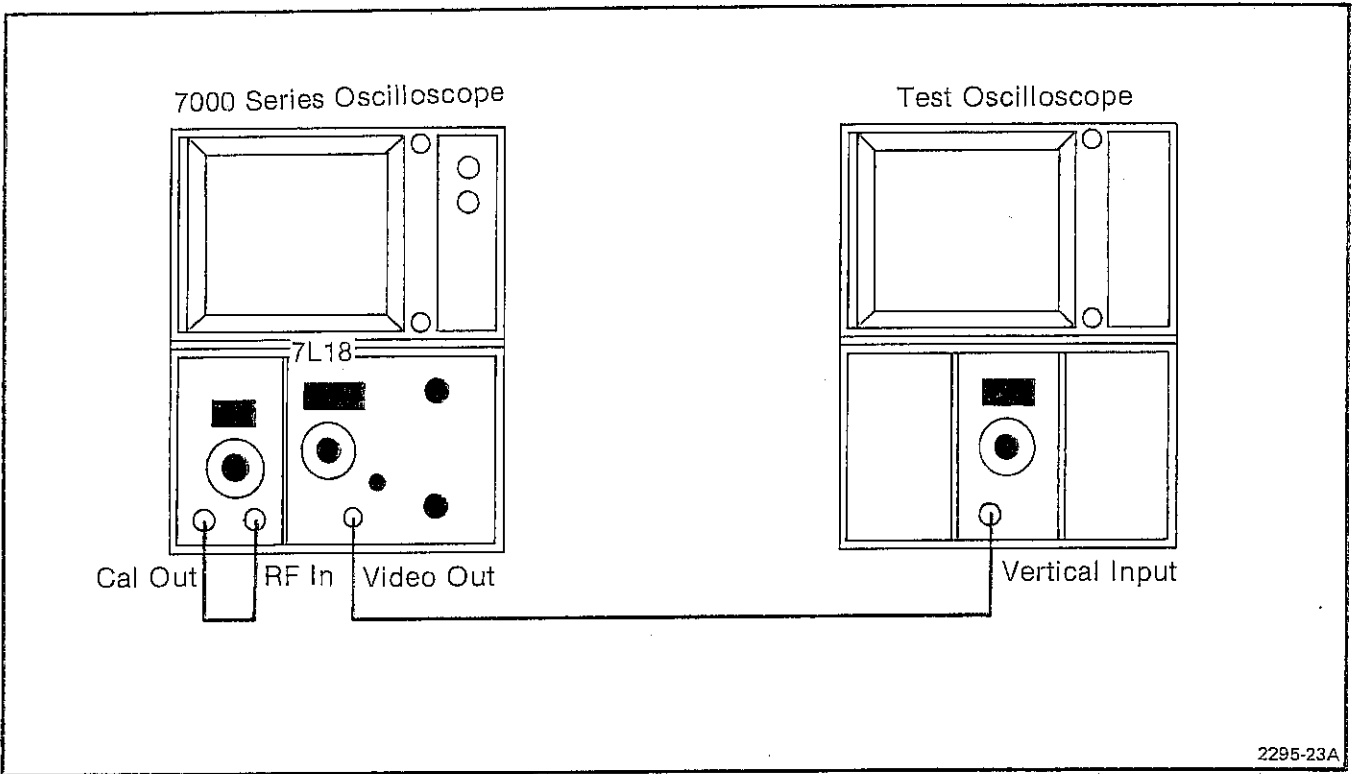

Fig. 4-15. Video Output Level Test Setup.

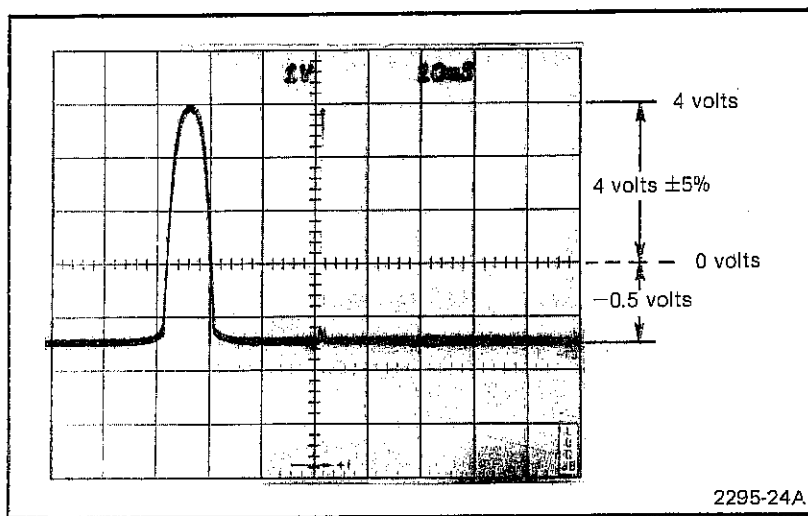

Fig. 4-16. Video Output Test Waveshape.

**17. Check Frequency Span Accuracy and Linearity
(Accuracy within 5% of span selected; linearity within 5% over the center eight divisions)**

Span Accuracy is the displacement error of calibrator markers from the center screen reference over ± 10 divisions of span. Linearity is the displacement error between successive markers with respect to the SPAN/DIV setting.

a. Connect the test setup as shown in Fig. 4-17. Set the 7L18 front-panel controls as follows:

CENTER FREQUENCY	2.0 GHz
Display Mode	LOG 10 dB/DIV
REFERENCE LEVEL	-30 dBm
RF Attenuation	0 dB
TRIGGERING	FREE RUN
Digital Storage	Display A/Display B
Band Selection	1.5—3.5
BASE LINE CLIPPER	Fully cw
TIME/DIV	AUTO
FREQ SPAN/DIV	200 MHz
RESOLUTION BANDWIDTH	AUTO

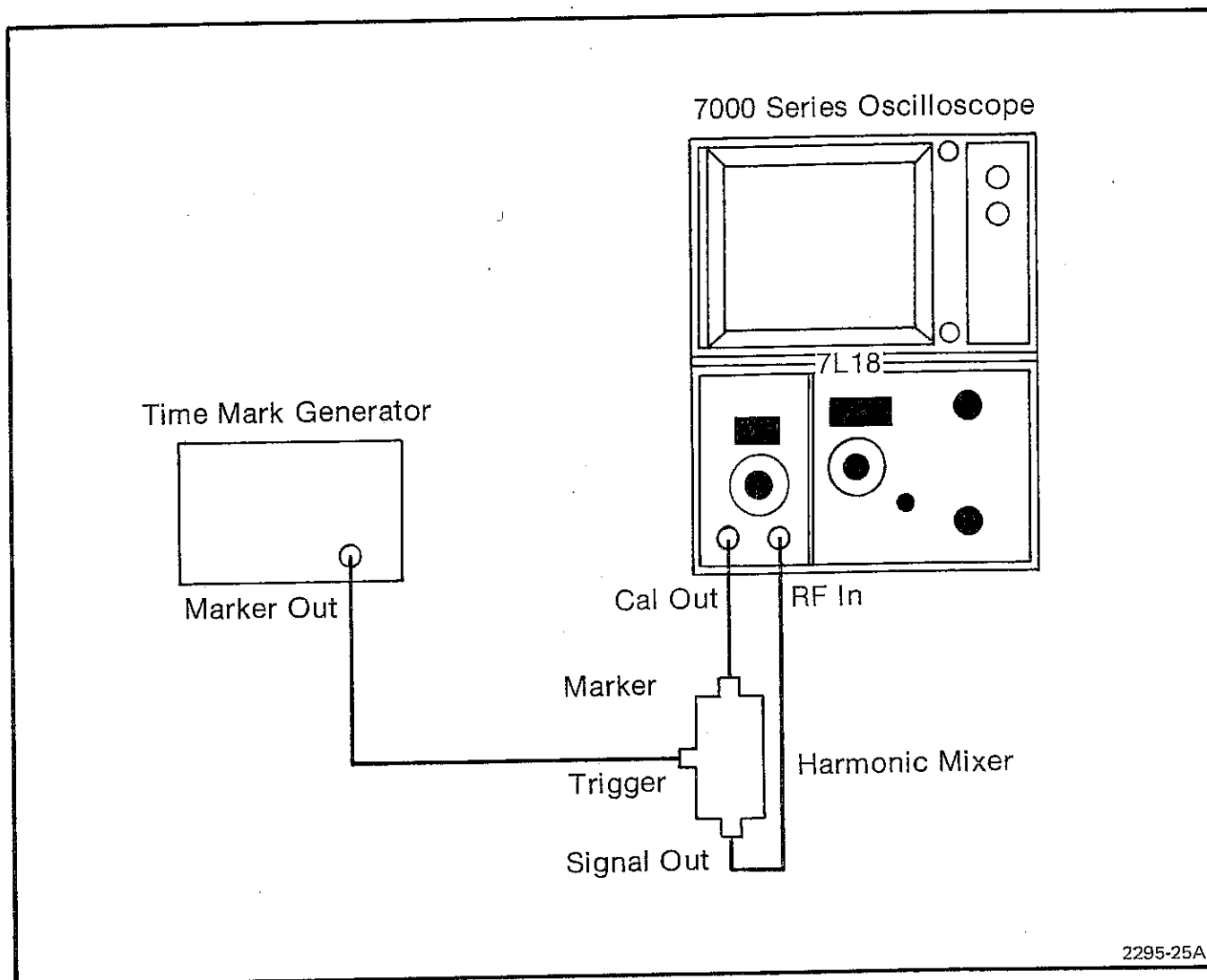

Fig. 4-17. Freq. Span/Div Test Setup.

Table 4-6

FREQUENCY SPAN/DIVISION MARKERS/DIVISION

Freq Span/Div	Resolution	Time Mark Generator	
		Marker Out	Markers/Div
500 MHz	3 MHz	0	1 per div ^a
200 MHz	3 MHz	10	2 per div ^b
100 MHz	3 MHz	10 ns	1 per div
50 MHz	300 kHz	20 ns	1 per div
20 MHz	300 kHz	50 ns	1 per div
10 MHz	300 kHz	100 ns	1 per div
5 MHz	300 kHz	200 ns	1 per div
2 MHz	30 kHz	500 ns	1 per div
1 MHz	30 kHz	1 μ s	1 per div
500 kHz	3 kHz	2 μ s	1 per div
200 kHz	3 kHz	5 μ s	1 per div
100 kHz	3 kHz	10 μ s	1 per div
50 kHz	3 kHz	20 μ s	1 per div
20 kHz	300 Hz	50 μ s	1 per div
10 kHz	300 Hz	100 μ s	1 per div
5 kHz	300 Hz	200 μ s	1 per div
2 kHz	30 Hz	500 μ s	1 per div
1 kHz	30 Hz	1 ms	1 per div
500 Hz	30 Hz	2 ms	1 per div
200 Hz	30 Hz	5 ms	1 per div

^a500 MHz calibration markers available between graticule lines 4 through 8 because of analyzer frequency range.

^b100 MHz markers available between graticule lines 2 through 7 because of analyzer frequency range.

b. Apply 10 ns markers through the Harmonic Mixer to the RF Input. Verify span/division and linearity accuracy by noting two (100 MHz) markers per division, $\pm 5\%$.

c. Change the FREQ SPAN/DIV to 100 MHz. Verify accuracy by noting one (100 MHz) marker per division, $\pm 5\%$.

d. Apply markers and set the FREQ SPAN/DIV control as directed in Table 4-6. Verify frequency span and linearity accuracy by noting the markers per division and dispersment across the full span for each setting. Adjust the RESOLUTION BANDWIDTH as required to optimize marker resolution.

18. Check Sweep Rate (TIME/DIV) Accuracy (Accuracy within 5% of the sweep rate selected)

a. Connect the test setup as shown in Fig. 4-18. Set the front panel controls as per test 10.

b. Apply a 2.0 GHz, -30 dBm signal from the UHF signal generator to the RF INPUT of the 7L18 and tune the CENTER FREQUENCY to the signal. Modulate the UHF carrier with time markers by connecting the Marker Out of the Time-Mark Generator to the External AM Inputs of the UHF signal generator.

c. With the CENTER FREQUENCY tuned to the 2.0 GHz signal from the UHF signal generator, reduce the FREQ

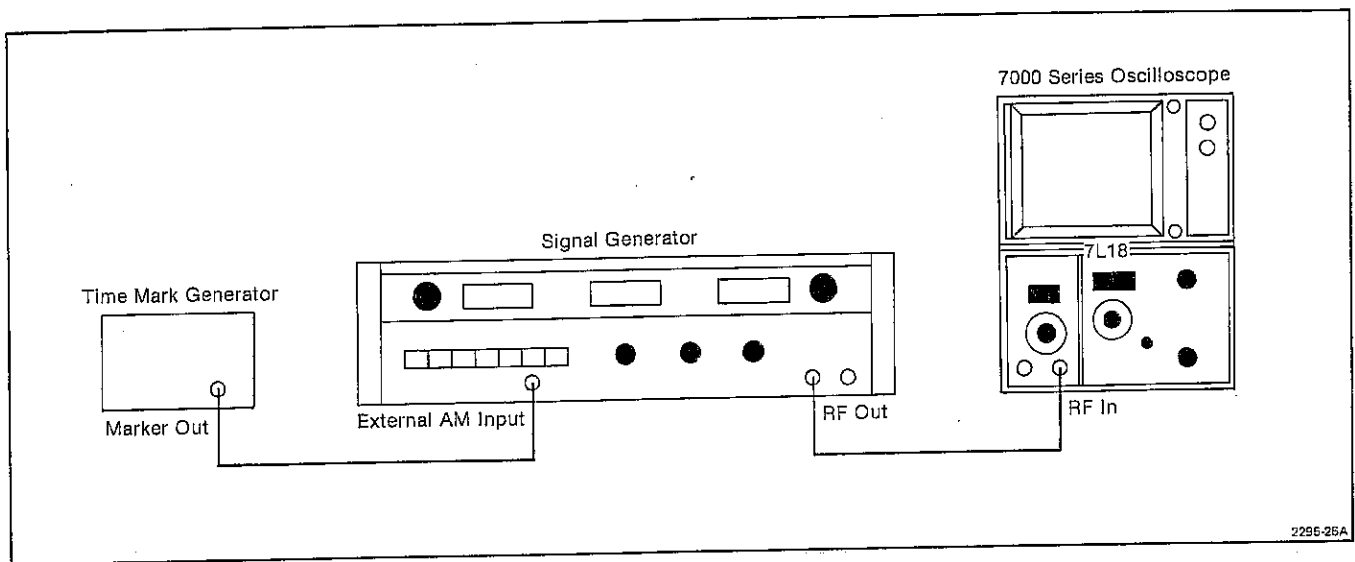

Fig. 4-18. Sweep Rate Test Setup.

SPAN/DIV to 0 for a time-domain display. If the markers are not clearly visible, it may be necessary to detune the center frequency with the FINE control.

d. Set the TIME/DIV to 0.1 ms. Adjust the UHF signal generator for a display amplitude of approximately two divisions. If the 7L18 is tuned to 2.0 GHz, a -30 dBm signal may be off screen at a setting of 0 SPAN/DIV. Reposition on the screen by using the VERTICAL POSITION control. Detune center frequency slightly with the FINE tune control.

e. Check the accuracy of the TIME/DIV selections by applying appropriate markers from the Time-Mark Generator for the TIME/DIV selection and noting the displacement between the time markers and their respective graticule divisions over the center eight divisions. The error displacement must be within 5% of the TIME/DIV selected.

NOTE

Use the HORIZ POSITION control to position a marker on the first graticule line, then note the displacement error between each marker and its respective graticule line.

f. Disconnect the test equipment to the 7L18.

19. Check the Preselector's Ultimate Rejection (at least 70 dB less on adjacent Band)

a. Connect the CAL OUT to the RF INput.

b. Set the front-panel controls as follows:

CENTER FREQUENCY	2.0 GHz
Display Mode	LOG 10 dB/DIV
Reference Level	-30 dBm
RF Attenuation	0 dB
TRIGGERING	FREE RUN
Digital Storage	Display A/Display B
Band Selection	1.5—3.5
BASE LINE CLIPPER	Fully cw
TIME/DIV	AUTO
FREQ SPAN/DIV	100 kHz
RESOLUTION BANDWIDTH	30 kHz

c. Adjust PEAKING for maximum signal amplitude.

d. Change Band selection to 2.5—4.5.

e. Any signal appearing on screen must be at least 70 dB less than the amplitude of the CAL OUT signal as it appeared on Band 1.5—3.5.

f. If this condition is not met, replace the Preselector.

PART 2—ADJUSTMENT PROCEDURES

When the 7L18 is not within the tolerance for a particular specification, determine the cause, repair as necessary, then use the appropriate adjustment procedure to return the instrument to its specification. After performing any adjustment, repeat the Performance Check to verify instrument conformance with specifications.

Allow instrument operation for at least 30 minutes in ambient air of +20°C to +30°C before performing an adjustment.

Waveform illustrations used in these instructions are often idealized. They are not intended to be representative of specification tolerances.

The numerical listing of the adjustment procedures is not an order of performance. Each procedure is independent.

Adjustments that are known to interact are noted and reference is made to the affected circuit.

Table 4-7

List of Adjustment Steps	Page
1. Adjust Sweep Amplitude and Timing	4-31
2. Adjust or Calibrate the Drive to 1st Local Oscillator FM Coil	4-33
3. Adjust 1st Local Oscillator Tuning Coil Drive Voltage and Calibrate the DVM readout	4-34
4. Calibration of the Log Amplifier	4-38
5. Calibration of the Phase Lock Control	4-40
6. Presetting the Variable Resolution Gain Adjustments	4-42
7. Calibration of the 510 MHz IF and Local Oscillators	4-44
8. Calibration of the 500 MHz Local Oscillator	4-45
9. Calibration of Digital Storage	4-50
10. Setting the constant "K" for the Zero Reference of the B-Save A Display	4-50
11. Calibration of the Resolution Bandwidth and Shape Factor	4-53
12. Input Compression Check (≥ -22 dBm, 1.5—1.8 GHz; ≥ -18 dBm, 1.8—18 GHz)	4-54
13. Adjustment of the Preselector Offset	4-54
14. Adjustment of Preselector Tracking and Flatness	4-55
15. Calibrate the Gain for Coaxial Bands 1 through 5	4-60
16. Calibrate the Gain for Waveguide Bands 6 through 10	4-60

Instrument Construction

The 7L18 is constructed to provide easy access to all adjustments while the instrument is operational, and to provide access to most components when repairs are necessary. In these procedures, the two major sections are referred to as Left and Right (see Fig. 4-19); the Right

section contains several interlocking Module Assemblies that have circuit adjustments and test points. All of these modules can be operated on extenders. Operation of the 7L18 outside the oscilloscope mainframe is through the use of three flexible plug-in extenders (see Fig. 4-19). Table 4-8 lists the items required to access all the adjustments and test points while the 7L18 is operational.

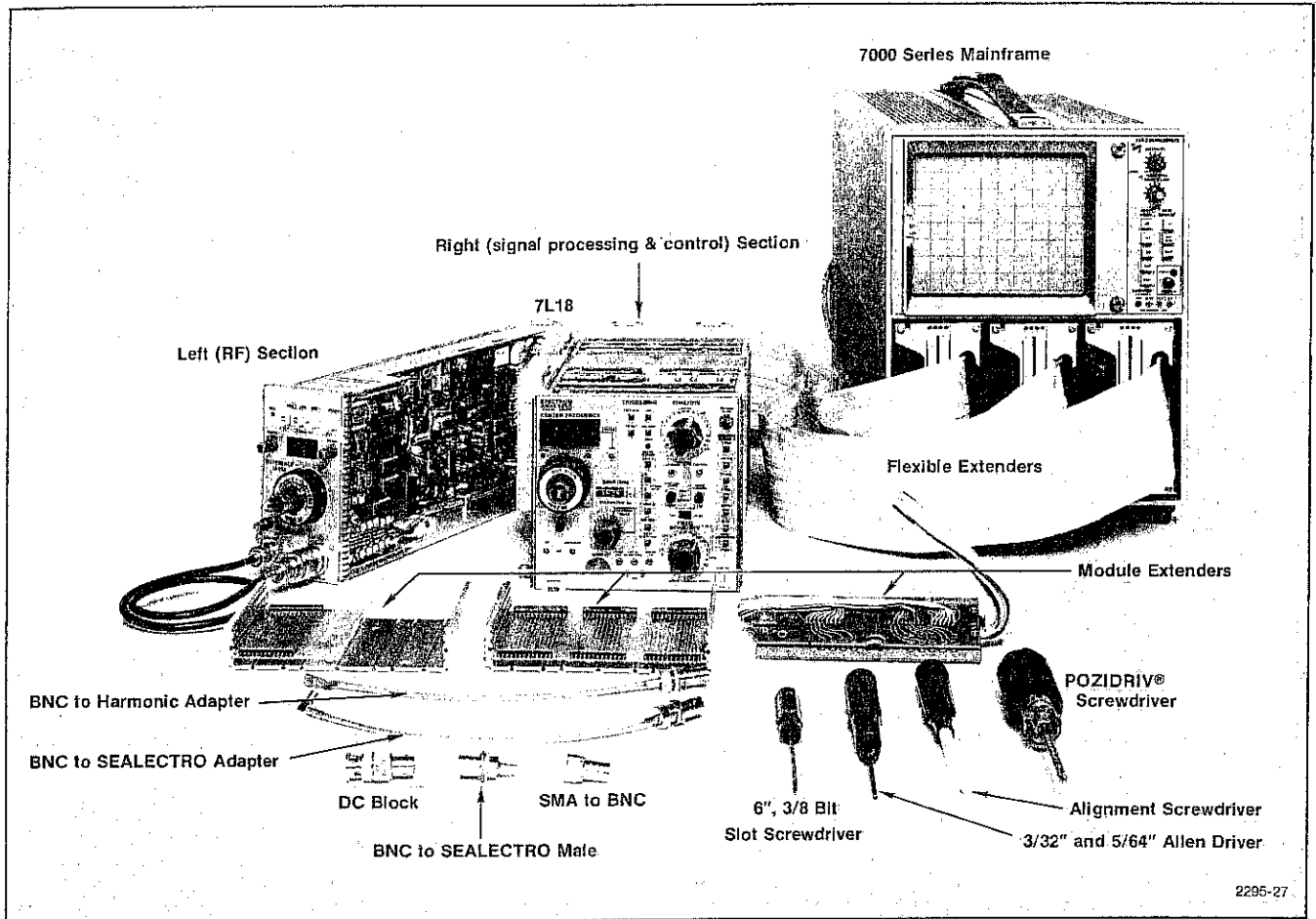

Fig. 4-19. 7L18 and 7000-Series Oscilloscope with Accessories and Tools Used When Making Calibration Adjustments.

Table 4-8

FLEXIBLE PLUG-IN EXTENDERS AND MODULE ASSEMBLY EXTENDERS

Item	Part Number	Remarks
Flexible Plug-in Extender	067-0616-00	Requires three each.
7L18 Module Extender Service Kit	006-2487-00	This Kit contains the extender types and an extractor tool.
Phase Lock Module Extender	067-0868-00	
Standard Module Extender	067-0869-00	
Narrow Module Extender	067-0870-00	
Module Extractor	003-0863-00	

Adjustment or Component Access

To access adjustments, test points, or components located on the inner sides of the Left and Right sections, separate the two sections as follows:

a. With the 7L18 outside the oscilloscope mainframe and power to the instrument turned off, remove the perforated side panel of the Left section by taking out four

Phillips-head screws. Two of these are located near the bottom edge of the side panel and two extend through the rear of the instrument into the side panel (see Fig. 4-20).

b. Remove the two screws that extend through the Left section into tabs on the Right section. These screws are located, top and bottom, near the front of the Left section and they are identified on the instrument by notes that describe their use (see Figs. 4-20 and 4-21).

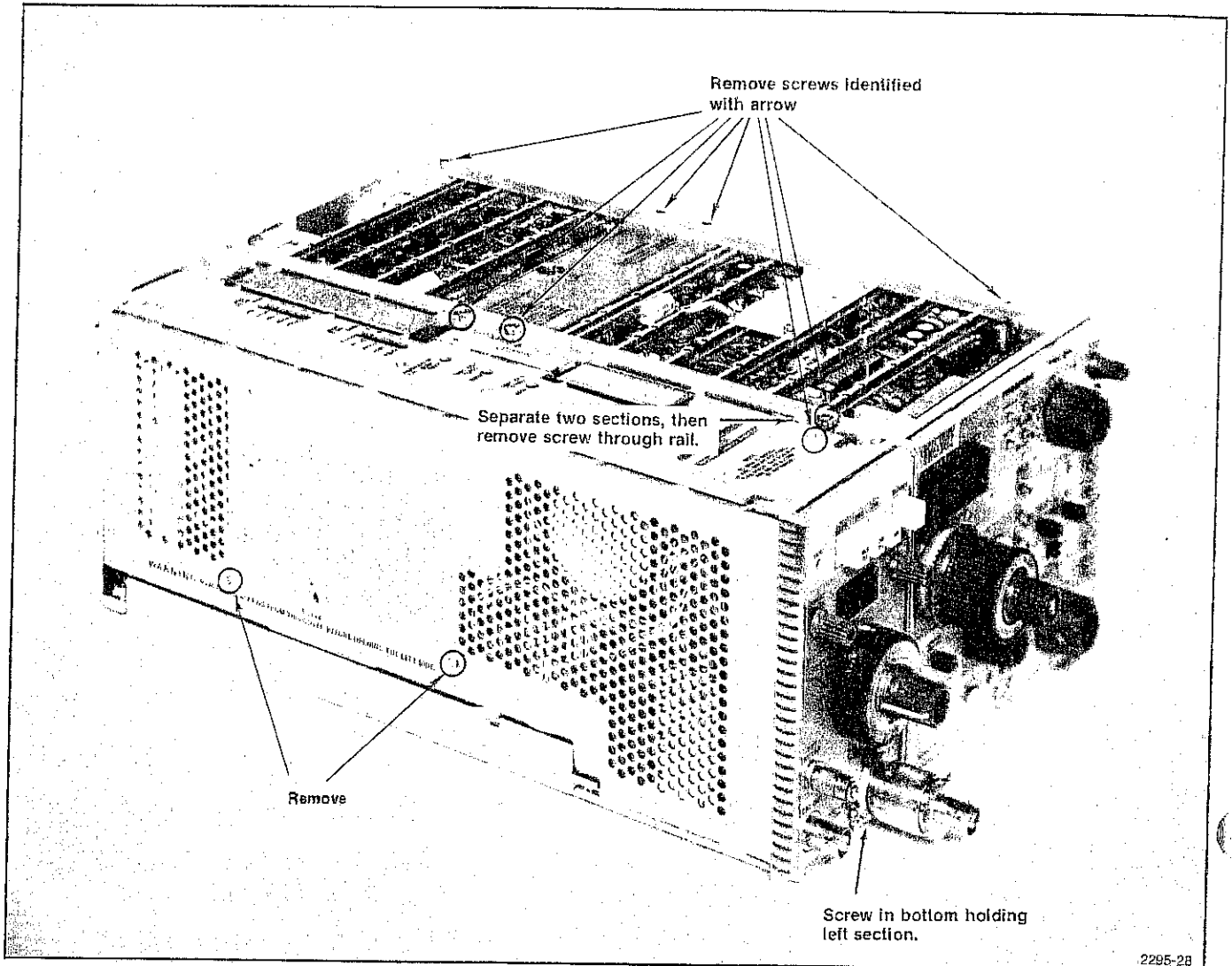

Fig. 4-20. Location of Side Panel and Retaining Rail Screws That Must be Removed to Gain Access to Calibration Adjustments.

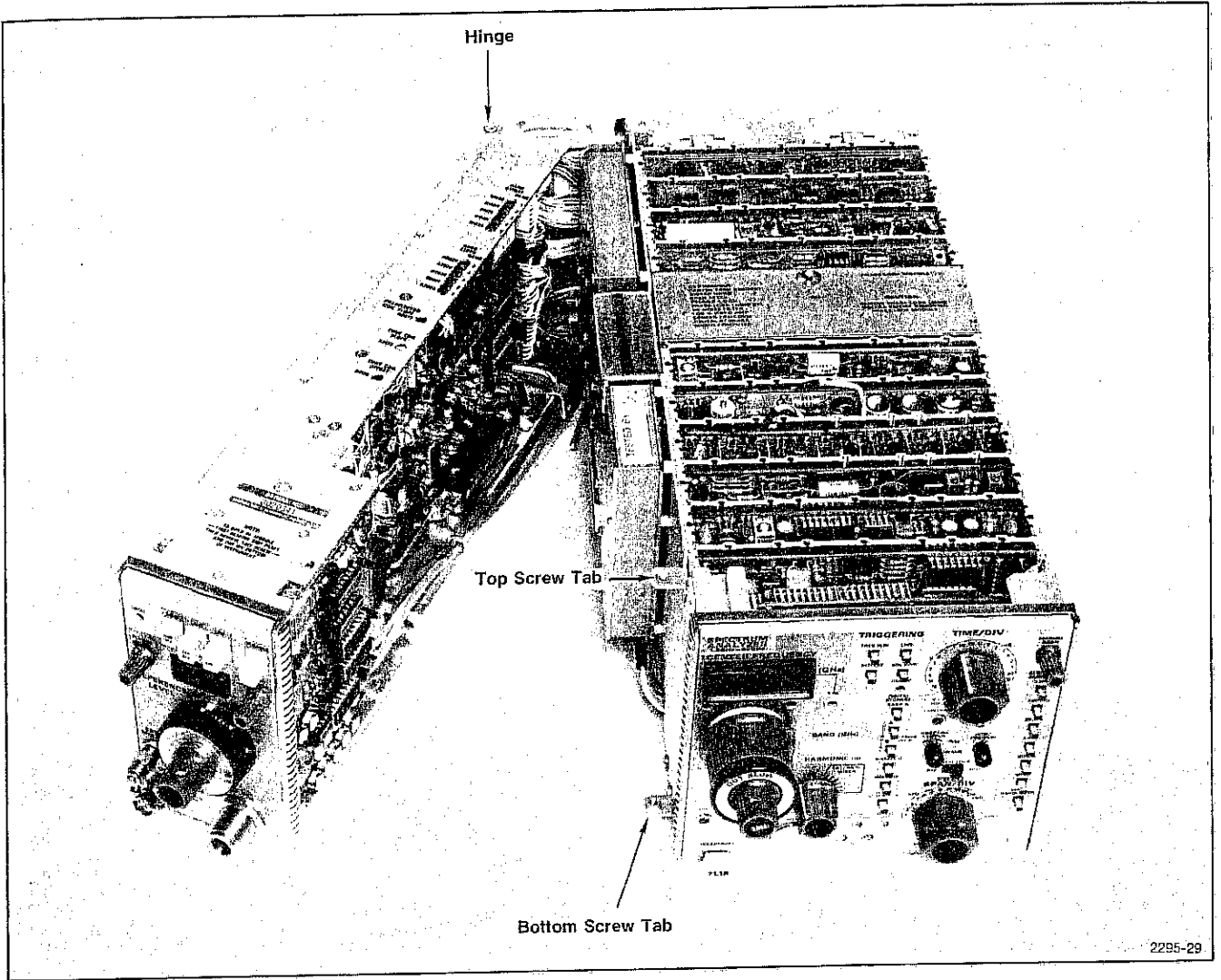

Fig. 4-21. 7L18 Showing How Two Sections are Hinged Together and Separated for Servicing.

c. The two sections can now be moved apart to expose the inner sides. The sections are mechanically and electrically connected by a hinge and cables at the rear of the instrument (see Fig. 4-21).

d. To separate a Module Assembly from the Right section, begin by removing the two retaining rails that are located along the top outside edges of the assemblies. Each rail is secured with four screws. Access to one of these screws requires that the Left section be moved apart from the Right section (see Fig. 4-20).

e. Invert the 7L18 and for any module, except Digital Storage, remove the four screws (see Fig. 4-22) that extend through the bottom of the instrument into the module being separated from the Right section. The Digital Storage Module is also fastened with four screws through the bottom of the instrument, but one is captive (see Fig. 4-22) between the outside-bottom rail and the instrument chassis. To remove this module, first remove the three non-captive screws, then unscrew the captive screw. The screw will remain in place, but the unscrewing action will force the module away from the bottom of the instrument.

f. Set the 7L18 upright and use the extractor tool to pull the selected module out of its seated position to service or plug it on an extender.

NOTE

The Phase Lock module may be pulled from the Right section by partially inserting two rail-holding screws to use as anchor pins for lifting the module.

g. A Module Assembly may be operated outside its normal position by using the appropriate Module Extender and connecting the 7L18 to the oscilloscope mainframe via Flexible Plug-in Extenders.

Access to the MICROCOMPUTER Components

The front panel of the Right section is hinged and connected to the main chassis via flexible cables. This construction provides the means to gain access to the Microcomputer components and the back side of the front panel. To open the front panel, proceed as follows:

a. With the 7L18 out of the oscilloscope mainframe and power to the instrument turned off, move the Left and Right sections apart to provide access to two Pozidriv® screws located at the top and bottom near the front of the instrument (see Fig. 4-23). Remove these two screws.

b. Invert the instrument and disconnect the retaining spring (see Fig. 4-22) to the front panel LATCH. The front panel can now be opened.

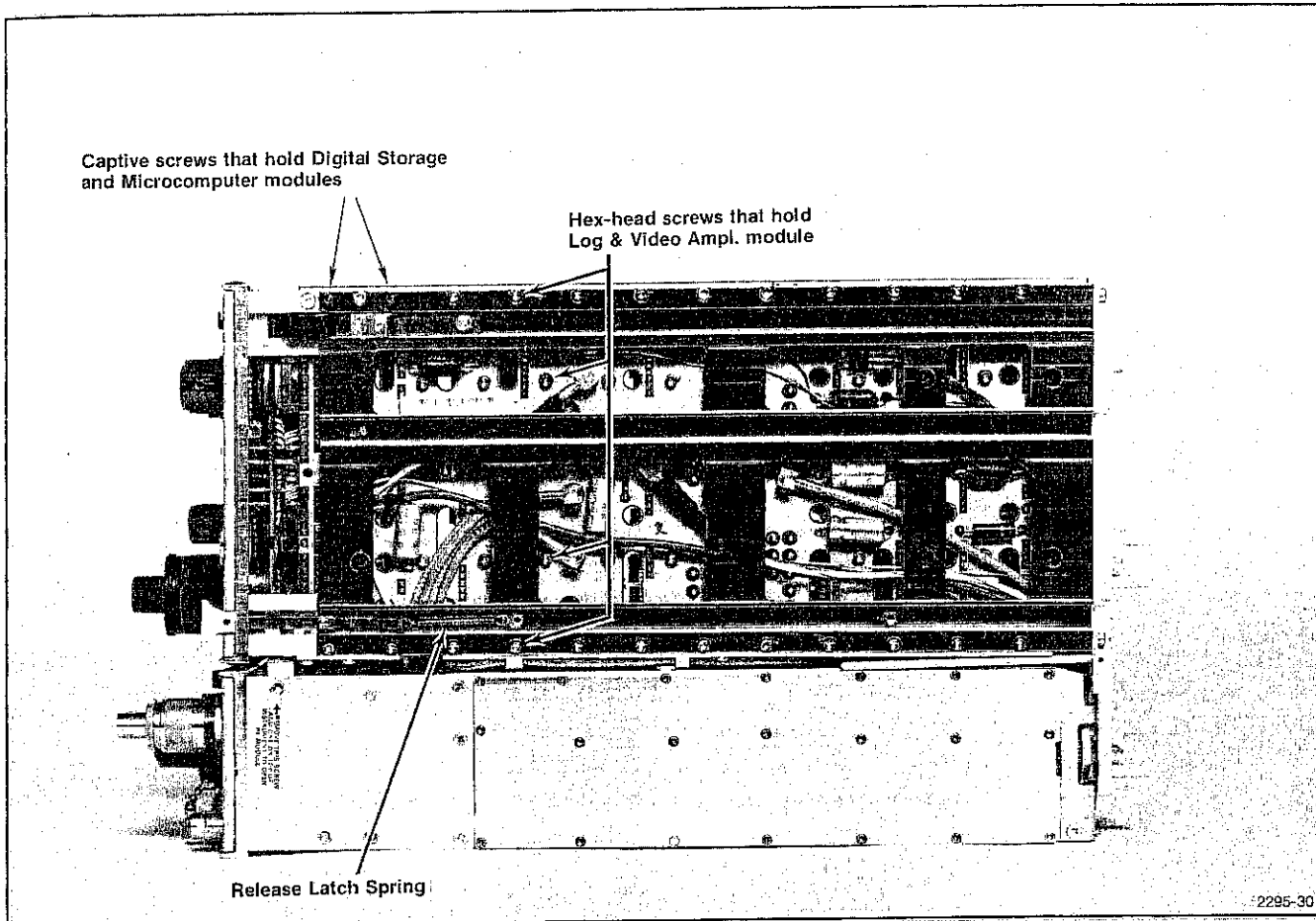

Fig. 4-22. Location of the Hexagonal Head Screws That Hold the Plug-in Module Assemblies.

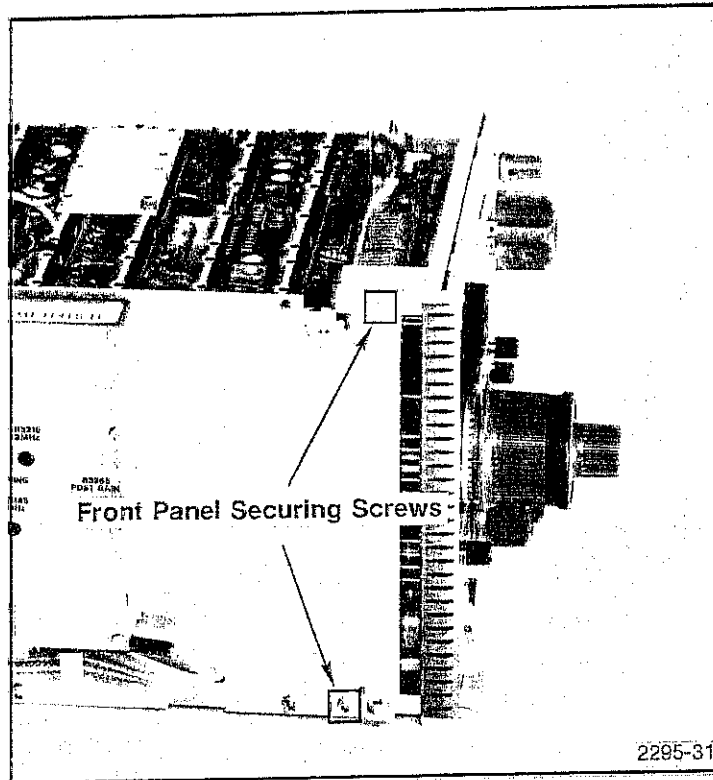

Fig. 4-23. Location of Front Panel Securing Screws.

ADJUSTMENT PROCEDURE

1. Adjust Sweep Amplitude and Timing

a. Set the following controls to the positions indicated.

7L18

FREQ SPAN/DIV	5 MHz
TIME/DIV	1 ms

Test Oscilloscope

TIME/DIV	0.1 ms
VOLTS/DIV	5 V
Input Coupling	dc

b. Remove the Span Attenuator module and use an extender to make the test points and adjustments accessible.

c. Connect the test oscilloscope probe to Zero Center Sweep, TP1340 (see Fig. 4-24). Set test oscilloscope Time/Div control to 10 ms.

d. Adjust Sweep Gain, R1308, and Sweep Centering, R1312 (see Fig. 4-30) for a 22 volt ramp centered at 0 volt.

e. Set the FREQ SPAN/DIV to 0 and connect the test oscilloscope probe to TP1370 (see Fig. 4-24).

f. Adjust the Sweep Offset, R1342, for 0 V at TP1370.

g. Remove the test oscilloscope probe.

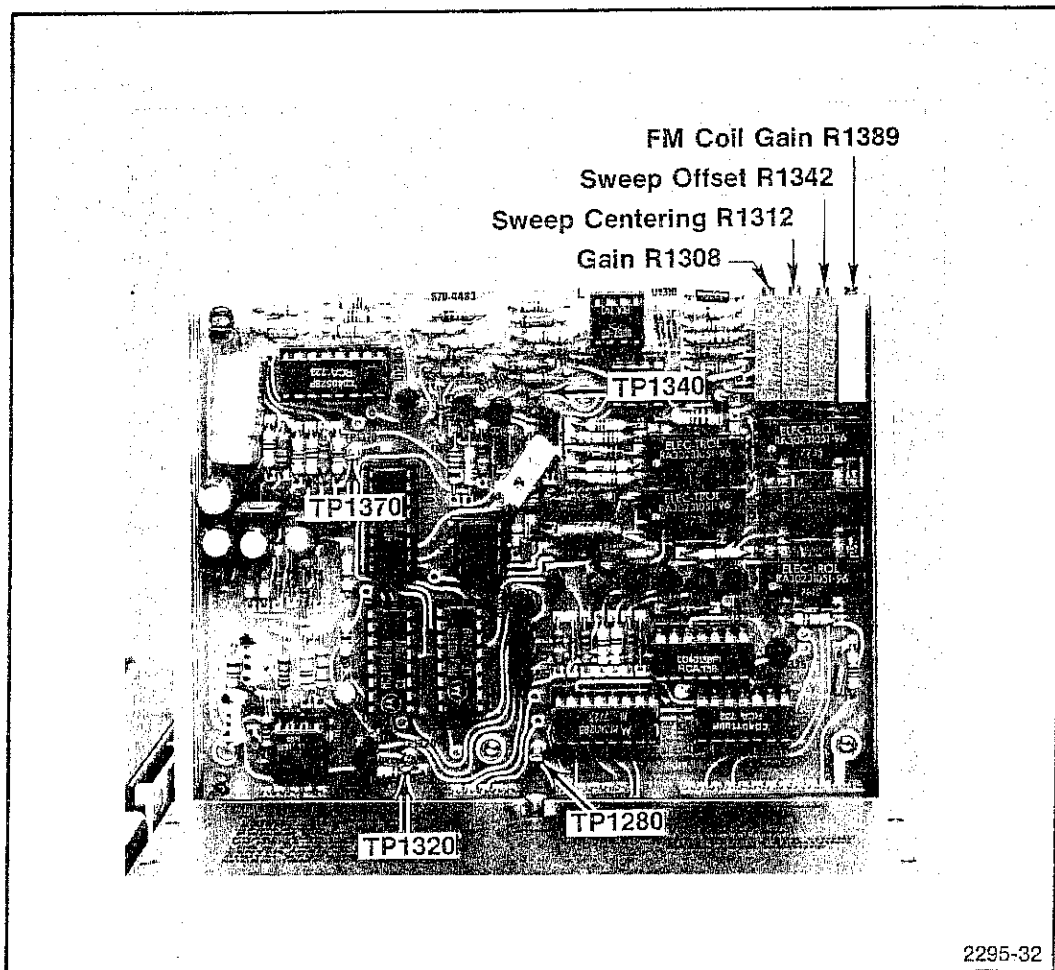

Fig. 4-24. Span Attenuator Test Points and Adjustments.