



**TDP0500 & TDP1000
High Voltage Differential Probes
Technical Reference**



071-1977-00



TDP0500 & TDP1000
High Voltage Differential Probes
Technical Reference

Revision B published August 21, 2019

www.tek.com

071-1977-00

Copyright © Tektronix. All rights reserved. Licensed software products are owned by Tektronix or its subsidiaries or suppliers, and are protected by national copyright laws and international treaty provisions.

Tektronix products are covered by U.S. and foreign patents, issued and pending. Information in this publication supersedes that in all previously published material. Specifications and price change privileges reserved.

TEKTRONIX and TEK are registered trademarks of Tektronix, Inc.

Contacting Tektronix

Tektronix, Inc.
14150 SW Karl Braun Drive
P.O. Box 500
Beaverton, OR 97077
USA

For product information, sales, service, and technical support:

- In North America, call 1-800-833-9200.
- Worldwide, visit www.tek.com to find contacts in your area.

Warranty

Tektronix warrants that this product will be free from defects in materials and workmanship for a period of one (1) year from the date of shipment. If any such product proves defective during this warranty period, Tektronix, at its option, either will repair the defective product without charge for parts and labor, or will provide a replacement in exchange for the defective product. Parts, modules and replacement products used by Tektronix for warranty work may be new or reconditioned to like new performance. All replaced parts, modules and products become the property of Tektronix.

In order to obtain service under this warranty, Customer must notify Tektronix of the defect before the expiration of the warranty period and make suitable arrangements for the performance of service. Customer shall be responsible for packaging and shipping the defective product to the service center designated by Tektronix, with shipping charges prepaid. Tektronix shall pay for the return of the product to Customer if the shipment is to a location within the country in which the Tektronix service center is located. Customer shall be responsible for paying all shipping charges, duties, taxes, and any other charges for products returned to any other locations.

This warranty shall not apply to any defect, failure or damage caused by improper use or improper or inadequate maintenance and care. Tektronix shall not be obligated to furnish service under this warranty a) to repair damage resulting from attempts by personnel other than Tektronix representatives to install, repair or service the product; b) to repair damage resulting from improper use or connection to incompatible equipment; c) to repair any damage or malfunction caused by the use of non-Tektronix supplies; or d) to service a product that has been modified or integrated with other products when the effect of such modification or integration increases the time or difficulty of servicing the product.

THIS WARRANTY IS GIVEN BY TEKTRONIX WITH RESPECT TO THE PRODUCT IN LIEU OF ANY OTHER WARRANTIES, EXPRESS OR IMPLIED. TEKTRONIX AND ITS VENDORS DISCLAIM ANY IMPLIED WARRANTIES OF MERCHANTABILITY OR FITNESS FOR A PARTICULAR PURPOSE. TEKTRONIX' RESPONSIBILITY TO REPAIR OR REPLACE DEFECTIVE PRODUCTS IS THE SOLE AND EXCLUSIVE REMEDY PROVIDED TO THE CUSTOMER FOR BREACH OF THIS WARRANTY. TEKTRONIX AND ITS VENDORS WILL NOT BE LIABLE FOR ANY INDIRECT, SPECIAL, INCIDENTAL, OR CONSEQUENTIAL DAMAGES IRRESPECTIVE OF WHETHER TEKTRONIX OR THE VENDOR HAS ADVANCE NOTICE OF THE POSSIBILITY OF SUCH DAMAGES.

[W2 – 15AUG04]

Table of Contents

General safety summary	iii
Preface	v
Specifications	1
Warranted Characteristics	1
Typical Characteristics	2
Nominal Characteristics	6
Probe Tip Adapter Specifications	7
Performance Verification	13
Required Equipment	14
Special Adapters	15
Preparation	17
DC Attenuation Accuracy	18
Differential Signal Range	20
Analog Bandwidth	22
Common Mode Rejection Ratio	26
Rise Time	27
High Voltage Rise Time Check (Optional)	31
Appendix A: Alternate Verification Procedures	35
Equipment Required	35
Preparation	35
Analog Bandwidth	36
CMRR (Common Mode Rejection Ratio)	39
Maintenance	40
Inspection and Cleaning	40
Replacement Parts	40
Preparation for Shipment	40

General safety summary

Review the following safety precautions to avoid injury and prevent damage to this product or any products connected to it.

To avoid potential hazards, use this product only as specified.

Only qualified personnel should perform service procedures.

While using this product, you may need to access other parts of a larger system. Read the safety sections of the other component manuals for warnings and cautions related to operating the system.

To avoid fire or personal injury

Connect and disconnect properly. Do not connect or disconnect probes or test leads while they are connected to a voltage source.

Ground the product. This product is indirectly grounded through the grounding conductor of the mainframe power cord. To avoid electric shock, the grounding conductor must be connected to earth ground. Before making connections to the input or output terminals of the product, ensure that the product is properly grounded.

Observe all terminal ratings. To avoid fire or shock hazard, observe all ratings and markings on the product. Consult the product manual for further ratings information before making connections to the product.

Connect the probe reference lead to earth ground only.

Do not apply a potential to any terminal, including the common terminal, that exceeds the maximum rating of that terminal.

Do not operate without covers. Do not operate this product with covers or panels removed.

Do not operate with suspected failures. If you suspect that there is damage to this product, have it inspected by qualified service personnel.

Avoid exposed circuitry. Do not touch exposed connections and components when power is present.

Do not operate in wet/damp conditions.

Do not operate in an explosive atmosphere.

Keep product surfaces clean and dry.

Terms in this manual

These terms may appear in this manual:



WARNING. *Warning statements identify conditions or practices that could result in injury or loss of life.*



CAUTION. *Caution statements identify conditions or practices that could result in damage to this product or other property.*

Symbols and terms on the product

These terms may appear on the product:

- DANGER indicates an injury hazard immediately accessible as you read the marking.
- WARNING indicates an injury hazard not immediately accessible as you read the marking.
- CAUTION indicates a hazard to property including the product.

The following symbol(s) may appear on the product:



CAUTION
Refer to Manual

Preface

This is the Technical Reference Manual for the TDP0500 & TDP1000 differential probes. This manual provides specifications and performance verification procedures for the probes.

Specifications

The specifications in Tables 1 through 4 apply to a TDP0500 or TDP1000 differential probe installed on a Tektronix DPO7000 oscilloscope. When the probe is used with another oscilloscope, the oscilloscope must have an input impedance of 50 Ω and a bandwidth of 1 GHz. The probe must have a warm-up period of at least 20 minutes and be in an environment that does not exceed the limits described. (See Table 1.) The probe calibration and Autozero routines should be run on the host instrument before verifying the warranted probe specifications. Specifications for the TDP0500 and TDP1000 differential probes fall into three categories: warranted, typical, and nominal characteristics.

Warranted Characteristics

Warranted characteristics describe guaranteed performance within tolerance limits or certain type-tested requirements. (See Table 1.) Warranted characteristics that have checks in the *Performance Verification* section are marked with the ✓ symbol.

Warranted characteristics describe guaranteed performance within tolerance limits or certain type-tested requirements. (See Table 1.) Warranted characteristics that have *Performance Verification* checks are marked with the ✓ symbol. Performance verification procedures are contained in the *TCP0500 & TDP1000 Technical Reference*, which is Tektronix part number 071-1977-XX.

Table 1: Warranted electrical characteristics

Specification	TDP0500	TDP1000
✓ Differential signal range (DC coupled)	$\pm 4.25 V_{(DC + peak AC)}$; $3 V_{RMS}$ $\pm 42 V_{(DC + peak AC)}$; $30 V_{RMS}$	$\pm 4.25 V_{(DC + peak AC)}$; $3 V_{RMS}$ $\pm 42 V_{(DC + peak AC)}$; $30 V_{RMS}$
Common-mode signal range (DC coupled)	$\pm 35 V_{(DC + peak AC)}$; $25 V_{RMS}$	$\pm 35 V_{(DC + peak AC)}$; $25 V_{RMS}$
Maximum nondestructive input voltage between signal and common of the same channel	$\pm 100 V_{(DC + peak AC)}$	$\pm 100 V_{(DC + peak AC)}$
✓ DC attenuation accuracy	$\pm 5\%$ of input (both ranges)	$\pm 5\%$ of input (both ranges)
✓ Bandwidth (4.25 V range, probe only)	DC to ≥ 500 MHz	DC to ≥ 1 GHz
✓ Rise time, 4.25 V range, probe only (10–90%, +20 °C to +30 °C)	≤ 700 ps	≤ 350 ps
✓ Common-mode rejection ratio	42 V range: >55 dB at 30 kHz >50 dB at 1 MHz >18 dB at 250 MHz	42 V range: >55 dB at 30 kHz >50 dB at 1 MHz >18 dB at 250 MHz
Temperature	Operating: 0 to +40 °C (32 °F to +104 °F) Nonoperating: –55 to +75 °C (–67 °F to +167 °F) ¹	
Humidity	Operating: 0-90% RH, tested at +30 to +40 °C (+86 °F to +104 °F) Nonoperating: 0-90% RH, tested at +30 to +60 °C (+86 °F to +140 °F)	

¹ See warning that follows.



WARNING. To avoid a burn hazard at high ambient temperatures, do not touch the probe with bare hands at nonoperating temperatures above +50 °C.

Typical Characteristics

Typical characteristics (Tables 2 and 3) describe typical but not guaranteed performance.

Table 2: Typical electrical characteristics

Differential input resistance, DC coupled	1 M Ω
Common mode input resistance	500 k Ω
Differential input capacitance	<1.0 pF at 100 MHz
Common-mode input capacitance	<2.0 pF per side at 100 MHz
Harmonic distortion	\leq 1.5% measured using 495 mV _{RMS} (or 1.4 V _{P-P}) output at 100 MHz
Offset accuracy	\pm 10 mV
Differential offset range	\pm 42 V (both ranges)
Common mode rejection ratio	(See Figure 5 on page 4.) (See Figure 6 on page 5.)
System noise	
Referred to probe output	<2.0 mV _{RMS} (4.25 V range), <1.0 mV _{RMS} (42 V range)
Referred to probe input	<10.0 mV _{RMS} (4.25 V range), <50.0 mV _{RMS} (42 V range)
Input impedance	(See Figure 7 on page 5.)
Bandwidth limit	-3 dB at 1 MHz -3 dB at 10 kHz -3 dB at 100 Hz
Propagation delay	6.5 ns from probe tip to output

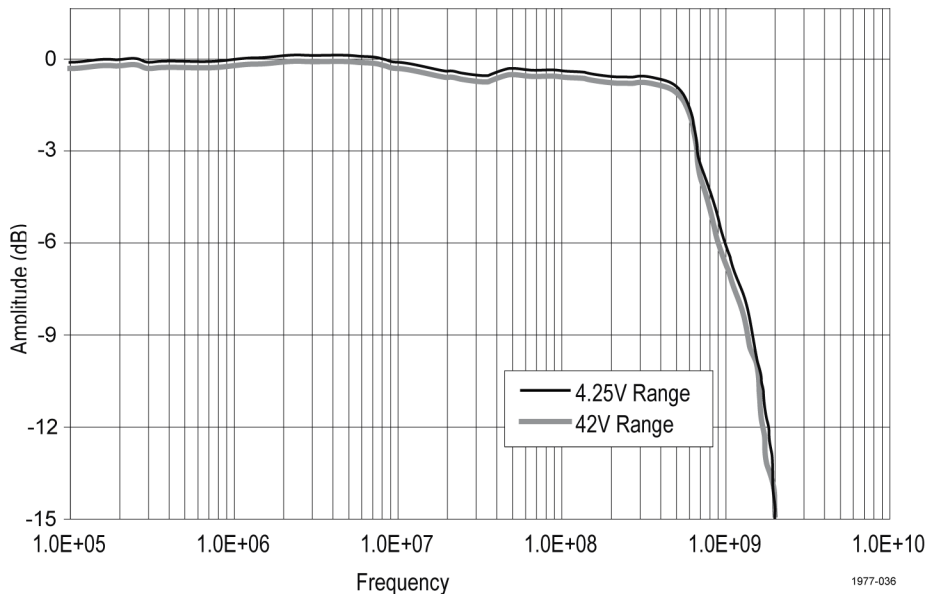

Figure 1: Typical bandwidth (TDP0500)

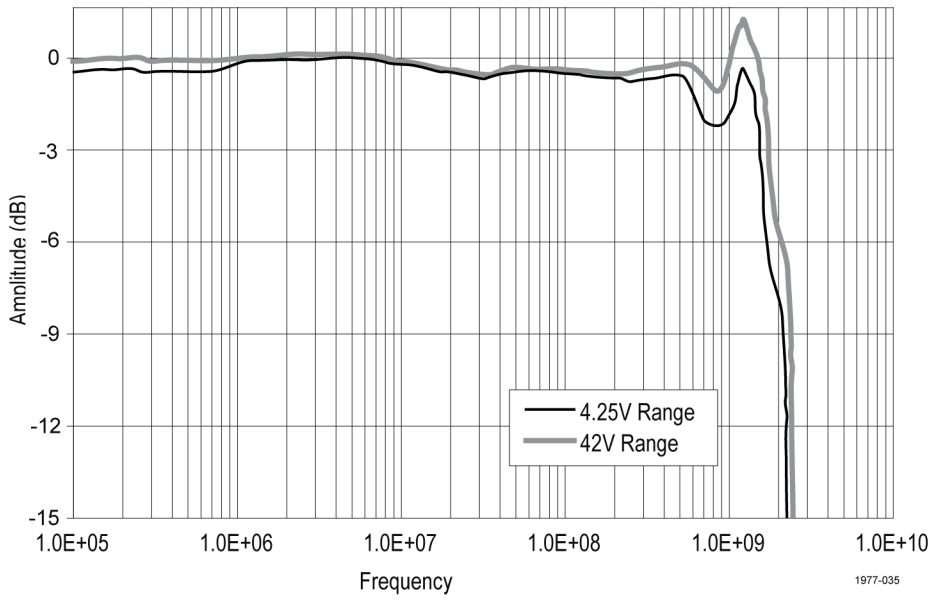

Figure 2: Typical bandwidth (TDP1000)

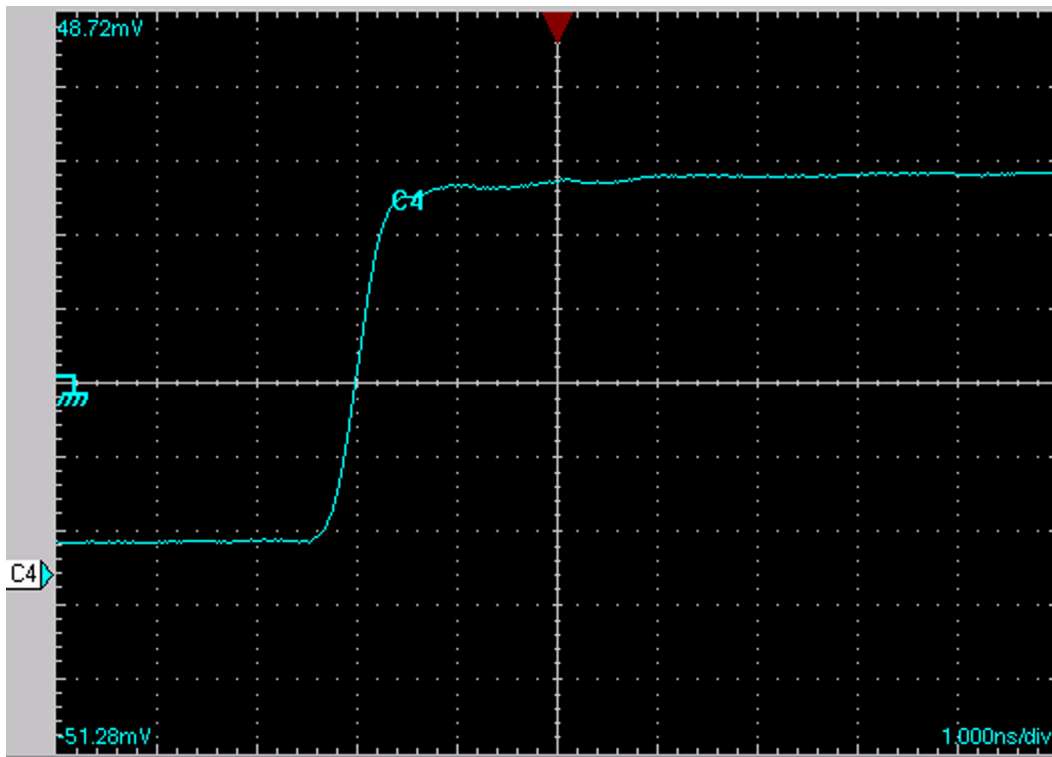

Figure 3: Typical rise time (TDP0500)

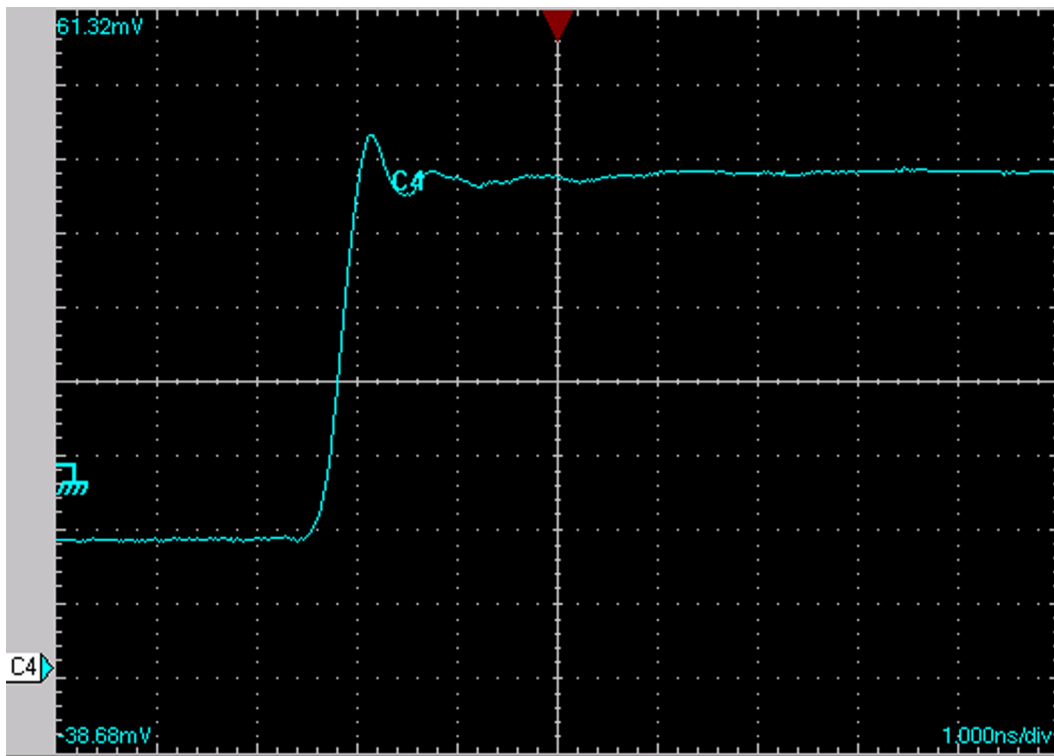

Figure 4: Typical rise time (TDP1000)

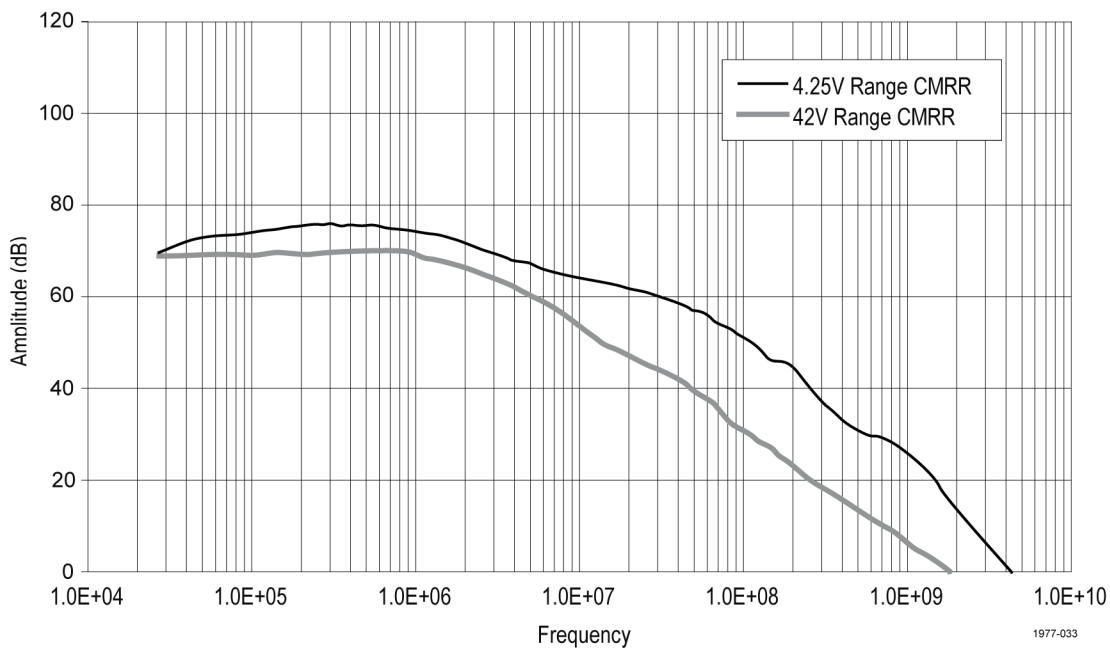

Figure 5: Typical Common-Mode Rejection Ratio (TDP0500)

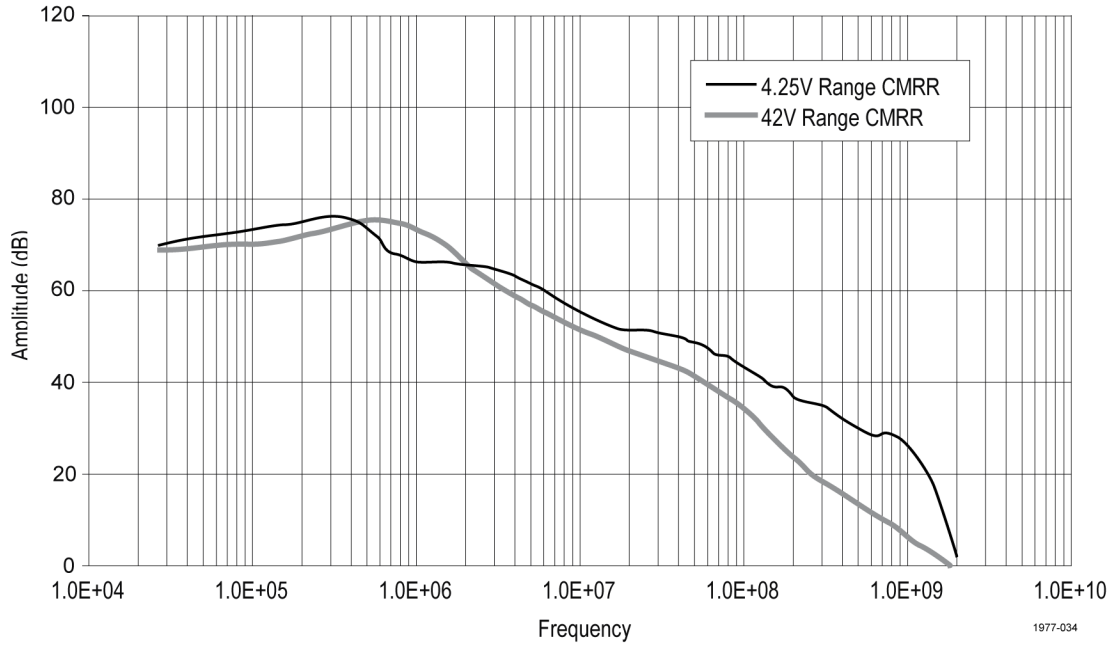

Figure 6: Typical Common-Mode Rejection Ratio (TDP1000)

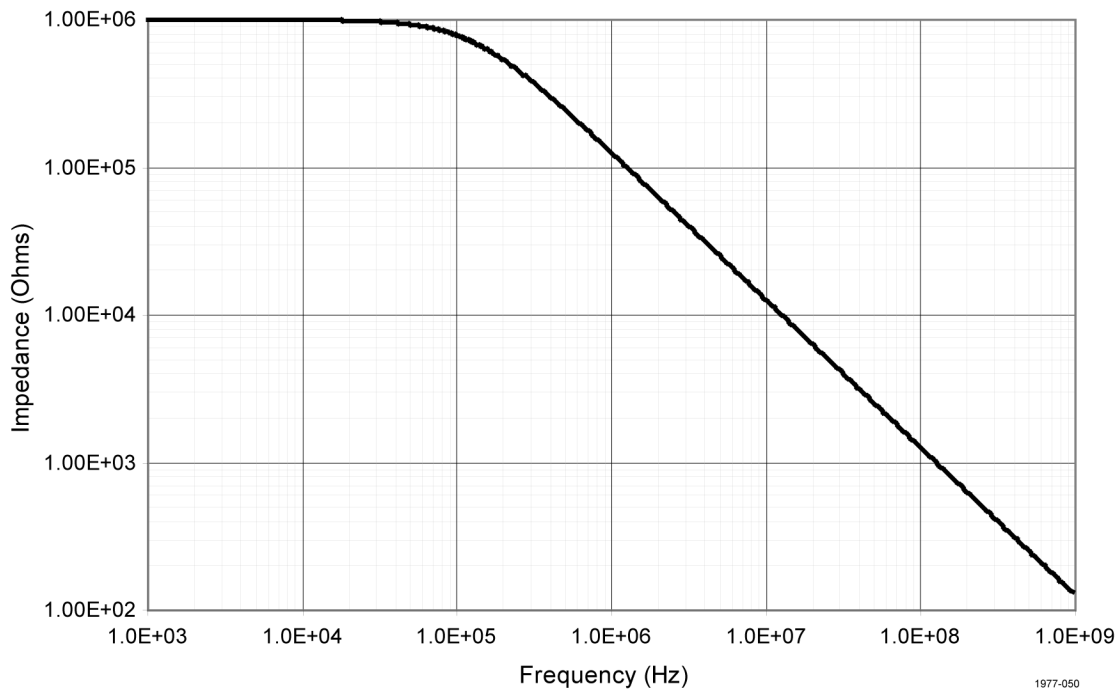
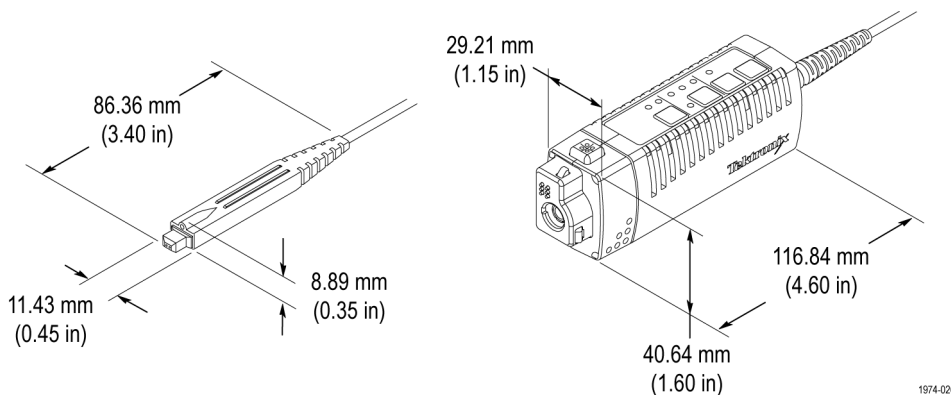

Figure 7: Typical input impedance versus frequency

Table 3: Typical mechanical characteristics

Dimensions, input connection	0.63 mm (0.025 in) square pin on 2.54 mm (0.100 in) centers
Dimensions, control box	117 mm × 41 mm × 29 mm (4.6 in × 1.6 in × 1.15 in)
Dimensions, probe head	86 mm × 11 mm × 8.9 mm (3.4 in × 0.45 in × 0.35 in)
Dimensions, output cable	1.22 m (48 in)
Unit weight (probe only)	144.5 g (5.1 oz)

**Figure 8: Probe dimensions**

Nominal Characteristics

Nominal characteristics (Table 4) describe guaranteed traits, but the traits do not have tolerance limits.

Table 4: Nominal electrical characteristics

Input configuration	Differential (two inputs, + and -), with case ground
Output coupling	DC coupling
Voltage ranges	4.25 V and 42 V
Termination	Terminate output into 50 Ω

Probe Tip Adapter Specifications

This section describes the characteristics of the adapters that are included in your accessory kit. The adapters are listed in order of performance, beginning with the fastest. You will get the best probe performance by connecting the probe directly to square pins on your circuit. However, as test points are not always as convenient, these adapters make taking measurements easier while maintaining the best signal fidelity.

NOTE. All adapter specifications are typical unless otherwise indicated.

Straight Pins

Tektronix part number: 016-1891-xx

Bandwidth: >1.0 GHz

10/90 Rise time: <350 ps

Best overall signal fidelity of the available adapters.

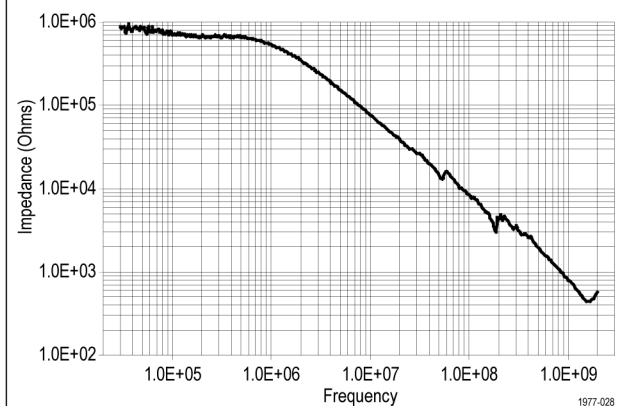
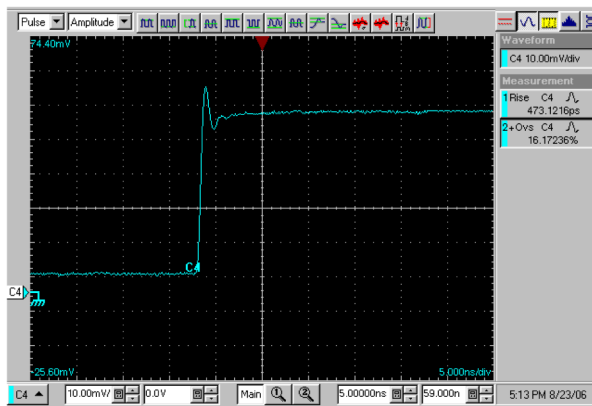
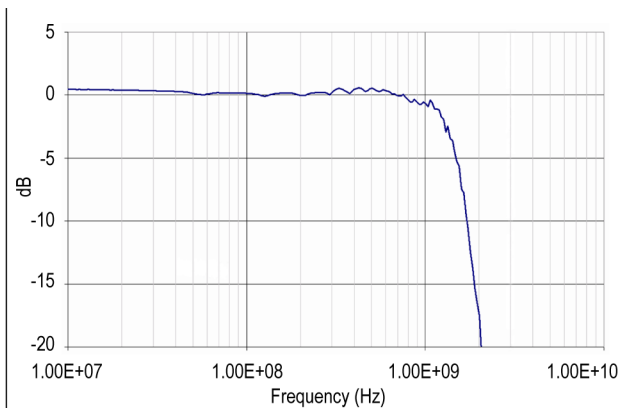
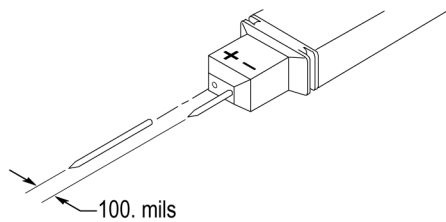

Longhorn Adapter

Tektronix part number: 016-1780-xx

Bandwidth: >1.0 GHz

10/90 Rise time: <350 ps

This adapter has sharp, adjustable pins that can span up to 0.35 inch apart. They are useful for probing small circuit board features such as vias and narrow traces.

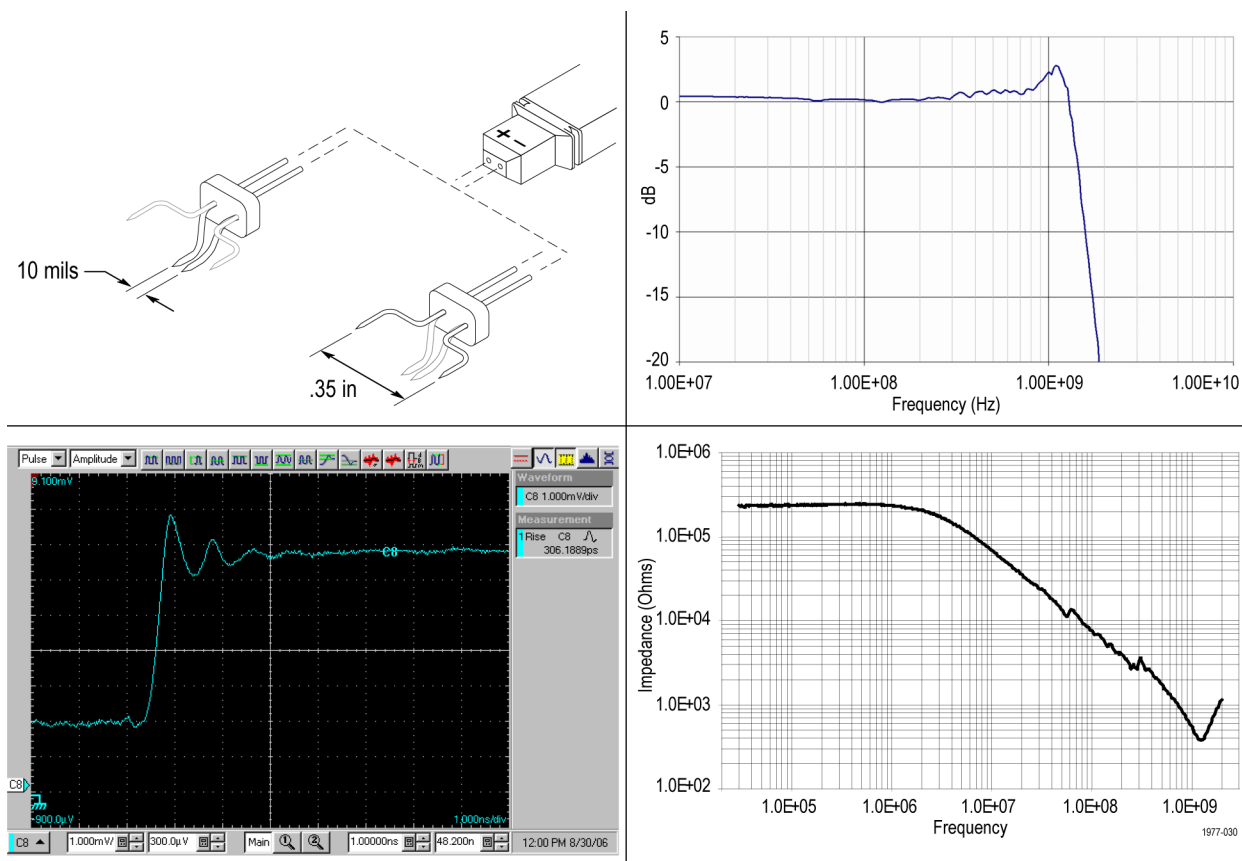

1" Solder Down Adapter

Tektronix part number: 196-3504-xx

Bandwidth: >820 MHz

10/90 Rise time: <430 ps

Use this adapter to provide easy access to test points that you frequently check, or that may be difficult to probe with other methods.

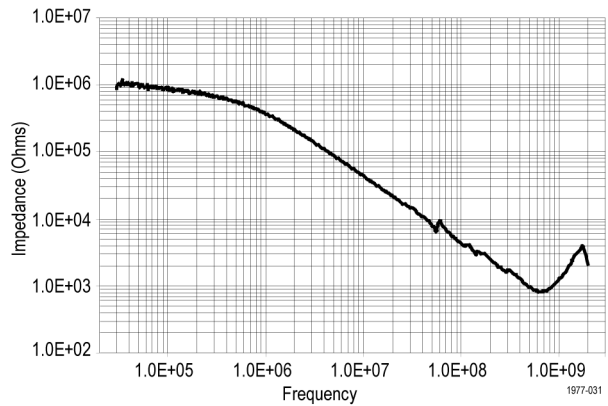
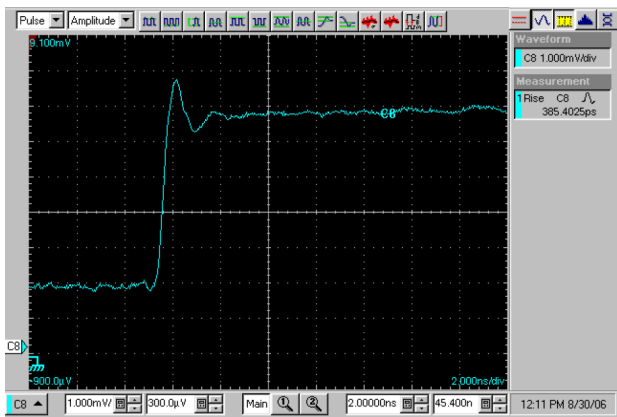
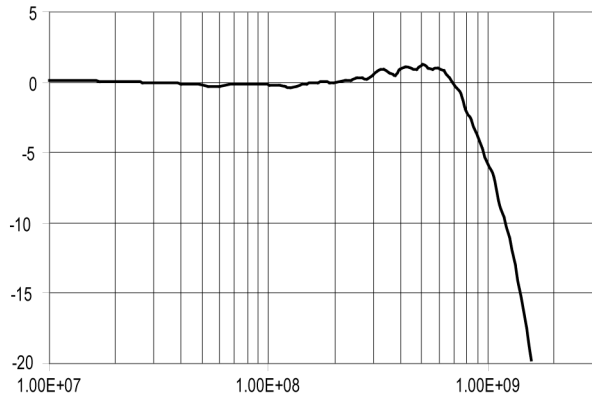
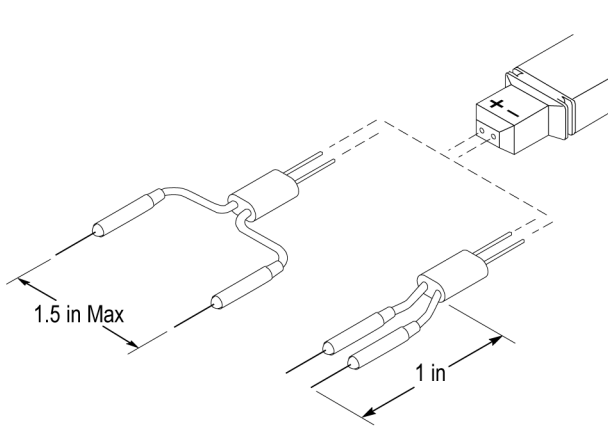

3" Solder Down Adapter

Tektronix part number: 196-3505-xx

Bandwidth: >550 MHz

10/90 Rise time: <635 ps

Use this adapter on test points that you frequently check that do not have square pins or other convenient connections. Solder the leads to your test points, spaced up to 5.5 inches apart.



CAUTION. To prevent short circuits, solder and dress the adapter leads carefully, and make sure that the adapter pins do not touch other conductors when the adapter is not connected to the probe.

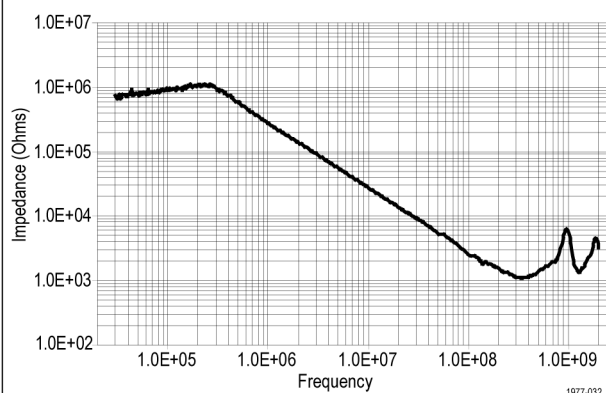
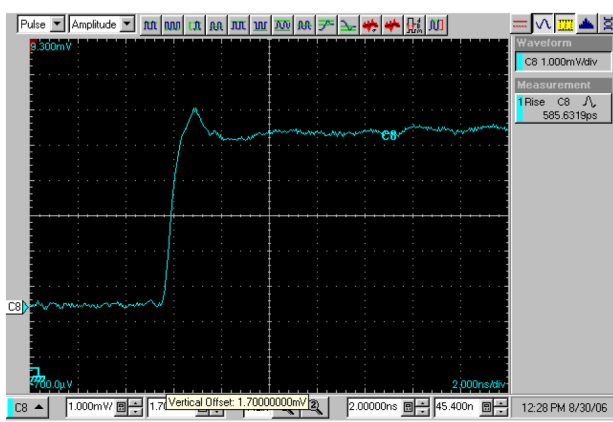
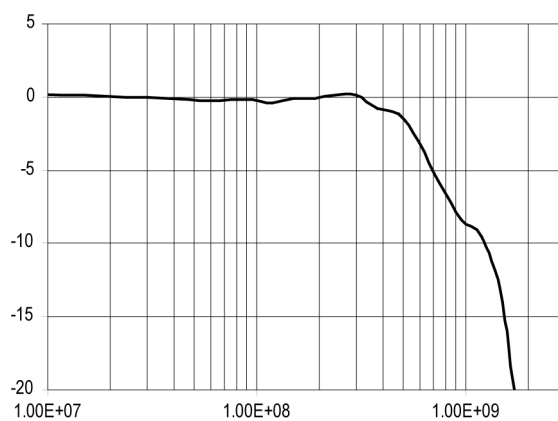
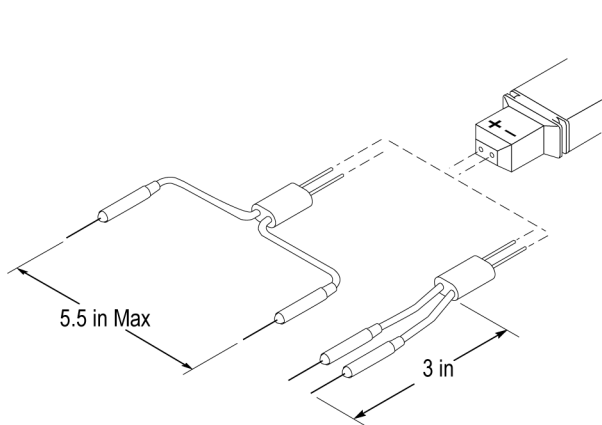

Y-Lead Adapter

Tektronix part number: 196-3434-xx

Usable Bandwidth: <250 MHz

Calculated rise time: 1.4 ns

Use this adapter for DC and low-frequency measurements. The socket ends plug onto square pins, component leads, and the KlipChip adapters included with the probe.

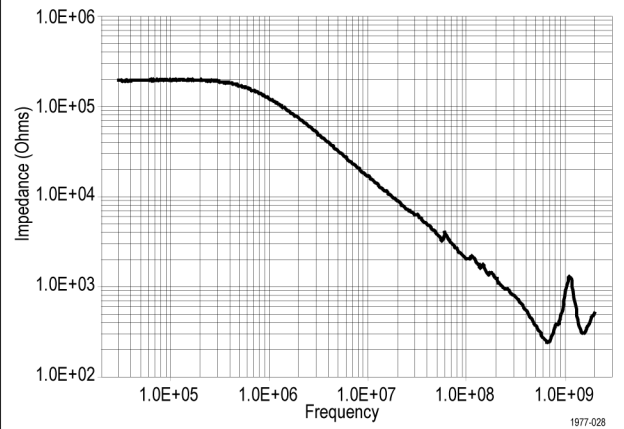
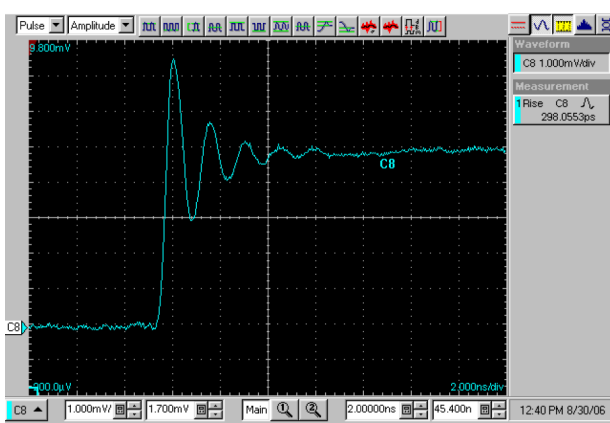
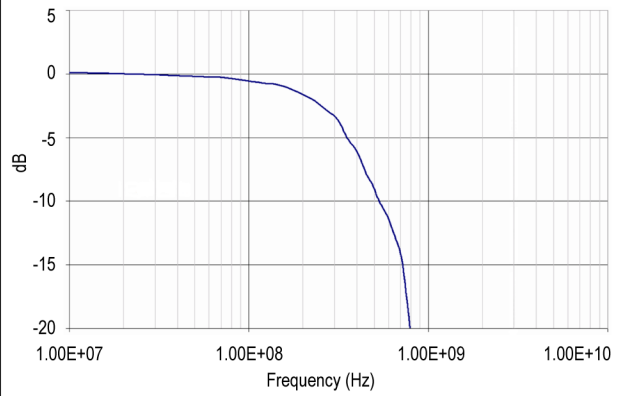
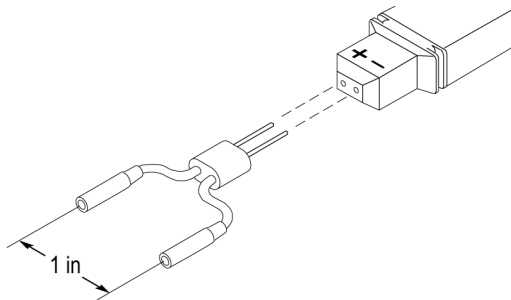

KlipChip Adapter

Tektronix part number: 206-0364-xx

Usable Bandwidth: <100 MHz

Calculated rise time: 3.5 ns

Use the KlipChip Adapters with the Y-lead adapters. Due to the length of these adapters, they are only recommended for DC and low-frequency measurements.

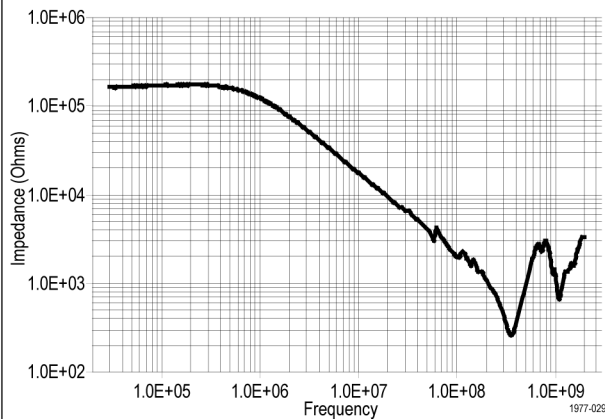
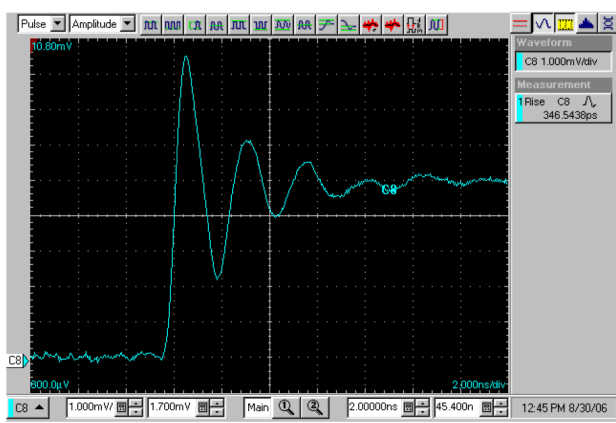
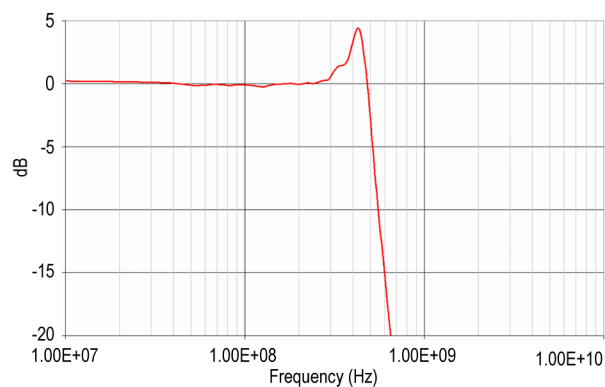
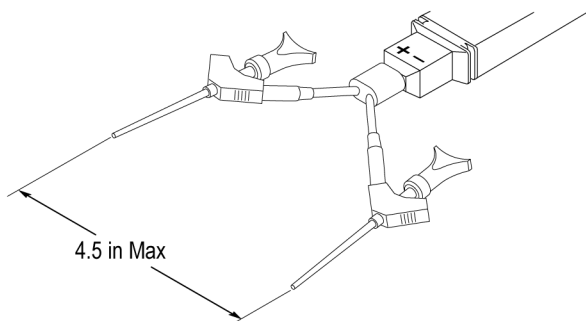

Performance Verification

Use the following procedures to verify the warranted specifications of the TDP0500 and TDP1000 Differential Probes. Before beginning these procedures, photocopy the test record and use it to record the performance test results. (See Table 7 on page 34.) The recommended calibration interval is one year.

These procedures test the following specifications:

- DC attenuation accuracy
- Differential signal range
- Analog bandwidth*
- Common mode rejection ratio*
- Rise time

* These tests require a network analyzer. Alternate test procedures that use a synthesizer and spectrum analyzer are provided in the Appendix.

Optional procedures are provided to test the following typical specifications:

- High voltage rise time

Required Equipment

Table 5 lists the equipment required to perform the performance verification procedure. The types and quantities of connectors may vary depending on the specific equipment you use.

NOTE. The procedures in this section require a network analyzer to perform the analog bandwidth and CMRR tests. Alternative procedures that do not require a network analyzer are included in this manual. (See page 35, Appendix A: Alternate Verification Procedures.)

Table 5: Test equipment

Description	Minimum requirements	Example product
Network analyzer	100 kHz to ≥ 2 GHz, with cables and adapters to BNC male and SMA male	Hewlett Packard 8753D
Digitizing oscilloscope with TekVPI interface	Fully compatible with TekVPI interface	Tektronix DPO7000 series oscilloscope
Sampling oscilloscope		Tektronix TDS8000 series oscilloscope
Sampling Module		Tektronix 80E0x
Sampling Module	TDR output; 250 mV step, <100 ps rise time	Tektronix 80E04
TekVPI Calibration Fixture	Optional probe accessory	Tektronix 067-1701-xx
BNC-to-probe tip adapter	Optional probe accessory	Tektronix 067-1734-xx
SMA M-to-BNC F adapter	As per description	Tektronix 015-0554-xx
Calibrated DC voltage source	Adjustable from 0 V to ≥ 42 V. Outputs must be isolated from earth ground.	Keithley 2400
DMM (2 required)	DC Accuracy $\geq 0.5\%$ on range to measure 42 V, averaging mode.	Fluke 187
BNC cables (2)	50 Ω , 42 inch	Tektronix 012-0057-xx
SMA cables (2)	50 Ω , 28 inch	Tektronix 012-0649-xx
Banana-to-banana patch cords (2)	1 red 1 black	Tektronix 012-0031-xx Tektronix 012-0039-xx
Dual-male-banana-to-female BNC adapter	As per description	Tektronix 103-0090-xx
Precision inline BNC terminator	50 $\Omega \pm 0.1\%$	Tektronix 011-0129-xx
Y-lead adapter	Standard accessory included w/probe	Tektronix 196-3434-xx
KlipChips (2)	Standard accessory included w/probe	Tektronix 206-0364-xx

Note: The equipment listed below is for the optional 42 V rise time test

High Voltage Pulse Generator	42 V, 300 ps rise time	Picosecond Labs 2600C
Probe calibration fixture	Optional probe accessory	Tektronix 067-0419-xx
Termination	50 W, 50 Ω , SMA connector	JFW 50T 334-1.0
Attenuator	100 X, 50 W, BNC connector	Aeroflex 60B50W-40dB
Spring-loaded probe tip pins	P7260 probe accessory	Tektronix 016-1917-xx

Special Adapters

Some of the adapters used in these procedures are available only from Tektronix. These adapters are described on the following pages.

TekVPI Calibration Fixture

The TekVPI Calibration Fixture, Tektronix part number 067-1701-xx, connects between the host instrument and the probe under test. (See Figure 9.) An SMA connector on the rear of the fixture provides access to the probe output signal for performance verification measurements.

1. SMA connector for probe output measurements
2. TekVPI socket for probe under test
3. BNC connection used for some tests

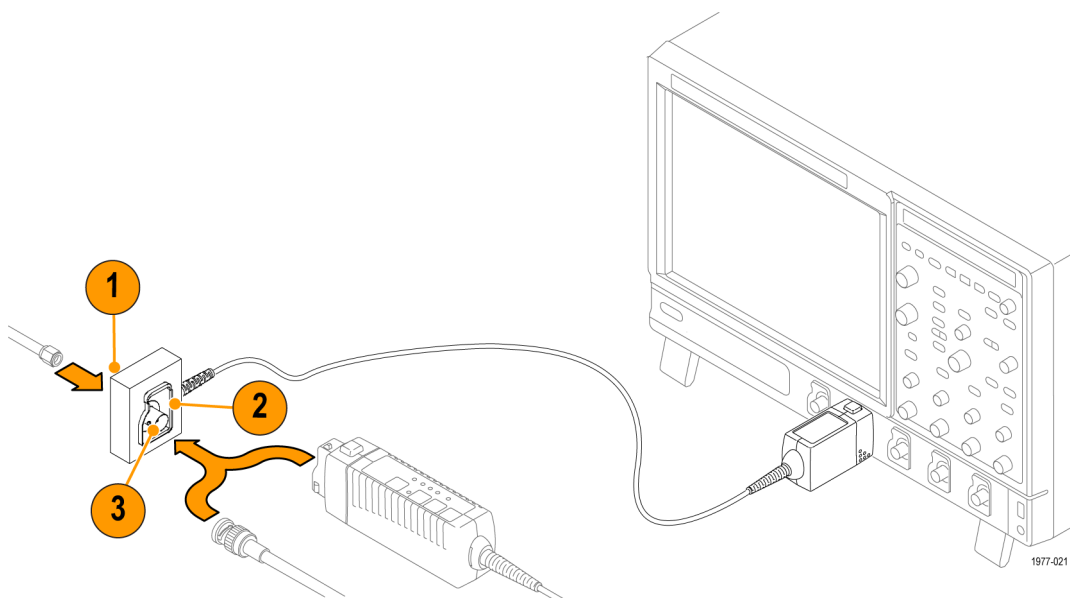

Figure 9: TekVPI Calibration Fixture

BNC-to-Probe Tip Adapter

The BNC-to-Probe Tip Adapter, Tektronix part number 067-1734-xx, provides connections for signal sources and probe test points. (See Figure 10.) The adapter breaks out the signal input on the BNC connector to pairs of square pins, one each for common-mode and differential-mode connections.

1. BNC connector for input signals
2. Differential Mode (DM) square-pin pair
3. Common Mode (CM) square-pin pair (with ground pin)

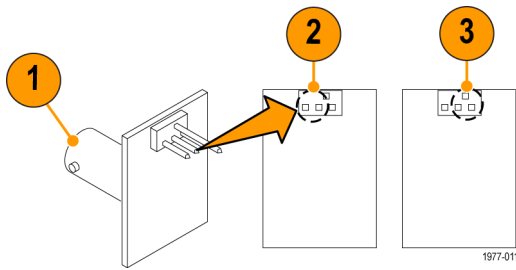

Figure 10: BNC-to-Probe Tip Adapter

Probe Calibration Fixture (Optional)

The Probe Calibration Fixture, Tektronix part number 067-0419-xx, provides a means to check the rise time specification of the probe at the 42 V range. (See Figure 11.) This check is not required to complete the performance verification of the probe, but is provided for users who want to check the probe rise time at the higher voltage range.

1. SMA connectors for input/output signals and terminations
2. Common Mode (CM) test points
3. Differential Mode (DM) test points

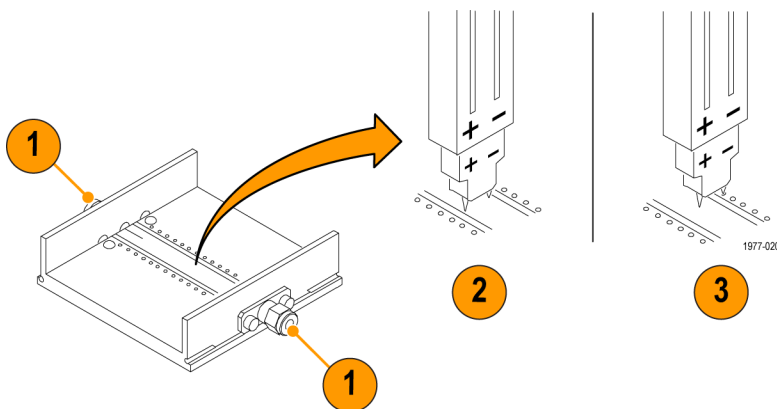

Figure 11: Probe calibration fixture connections

Preparation

Prepare the equipment as follows:

1. Turn on the TekVPI oscilloscope.
2. Connect the TekVPI Calibration Fixture to the oscilloscope.
3. Connect the SMA M-to-BNC F adapter to the SMA output of the TekVPI Calibration Fixture.
4. Connect the precision termination to the BNC end of the SMA M-to-BNC F adapter.
5. Connect one end of the BNC cable to the precision termination.
6. Connect the other end of the BNC cable to the BNC-to-dual banana adapter.
7. Connect the BNC-to-dual banana adapter to the DMM input. Note: This DMM is used to measure the probe output voltage.
8. Connect the probe to the TekVPI Calibration Fixture and verify that one of the Range LEDs on the probe illuminates.
9. Connect the Y-lead adapter to the probe head. Observe proper polarity: red to (+), black to (-).
10. Connect the MicroCKT test tips to the Y-lead adapter.
11. Set the vertical offset to 0 V. (Check that the offset is set to zero before performing each test unless instructed otherwise.)

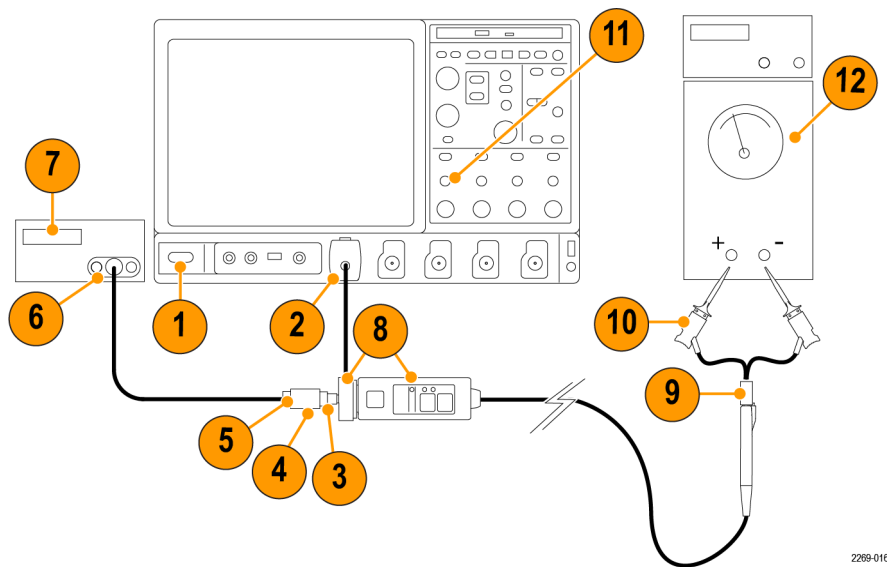

Figure 12: Preliminary test setup

12. Turn on the remaining test equipment listed in the table.
13. Allow the probe and test equipment to warm up for 20 minutes at an ambient temperature of 20 °C to 30 °C.
14. Photocopy the test record and use it to record the test results. (See Table 7 on page 34.)

Perform the verification procedures in order.

DC Attenuation Accuracy

This test checks the probe gain by measuring known voltages with a multimeter. The probe is then used to measure the same voltages, and then a comparison calculation is made.

Preparation

1. Set the vertical offset to 0 V.
2. Set the probe to the 42 V range, DC reject off, and full bandwidth.
3. Connect the KlipClips to the DC source. Observe proper polarity: red to (+), black to (-).
4. Connect a second DMM to the DC source.

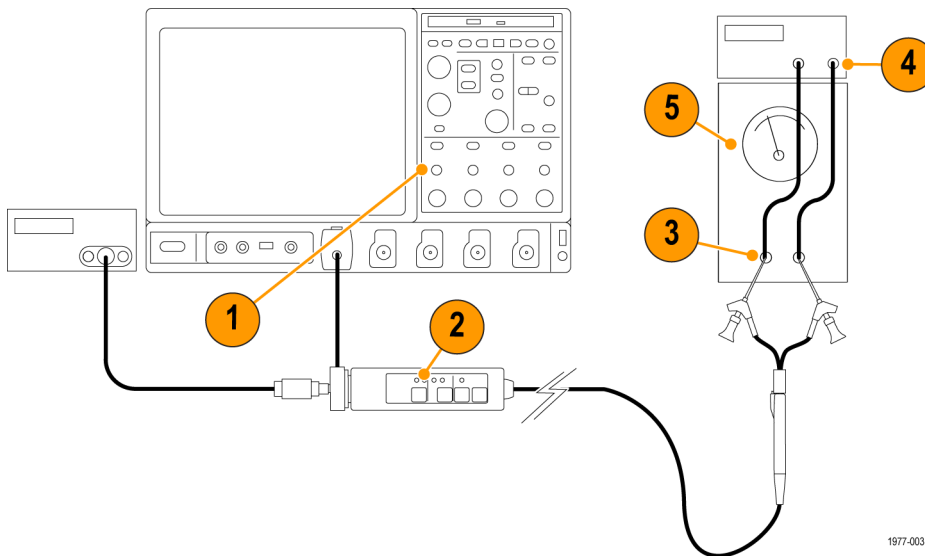

Figure 13: Setup for differential-mode tests

Verification

42 V Range.

5. Set the input voltage on the DC source to approximately 40 V. Record the actual voltage as V_{in1} .
6. Record the output voltage as V_{out1} .
7. Set the input voltage on the DC source to approximately 20 V. Record the actual voltage as V_{in2} .
8. Record the output voltage as V_{out2} .
9. Set the input voltage on the DC source to approximately 5 V. Record the actual voltage as V_{in3} .
10. Record the output voltage as V_{out3} .
11. Calculate the attenuation twice, using the values from the measurements as follows:

$$(V_{in1} - V_{in2}) \div (V_{out1} - V_{out2}) \text{ and } (V_{in2} - V_{in3}) \div (V_{out2} - V_{out3})$$

12. Verify that the attenuation is in the range of 47.5 to 52.5. Record the results in the test record.

4.25 V Range.

13. Set input voltage on the DC source to approximately 4.0 V. Record the actual voltage as V_{in1} .

14. Change the probe voltage range to 4.25 V.

15. Record the output voltage as V_{out1} .

16. Set the input voltage on the DC source to approximately 2.0 V. Record the actual voltage as V_{in2} .

17. Record the output voltage as V_{out2} .

18. Set the input voltage on the DC source to approximately 0.5 V. Record the actual voltage as V_{in3} .

19. Record the output voltage as V_{out3} .

20. Calculate the attenuation twice, using the formulas from the previous test.

21. Verify that the attenuation is in the range of 4.75 to 5.25. Record the results in the test record.

22. Press the DC Reject button on the probe to turn DC reject on.

23. Verify that the output returns to approximately 0 volts. (This is a functional check; there is no specified performance limit.)

24. Press the DC Reject button on the probe to turn DC reject off.

25. Keep the output connections for the next procedure.

Differential Signal Range

This procedure *directly* verifies the differential signal range and *indirectly* verifies the common-mode signal range. This procedure uses the setup from the previous test.

Verification

42 V Range.

1. Set the vertical offset to 0 V.
2. Set the probe to the 42 V range, DC reject off, and full bandwidth.
3. Set the input voltage on the DC source to 0 V, and verify that it is 0 V with the multimeter. (See Figure 14.)
4. Measure the probe output voltage as V_{offset} . You will use this offset voltage to get more accurate results in the calculations below.

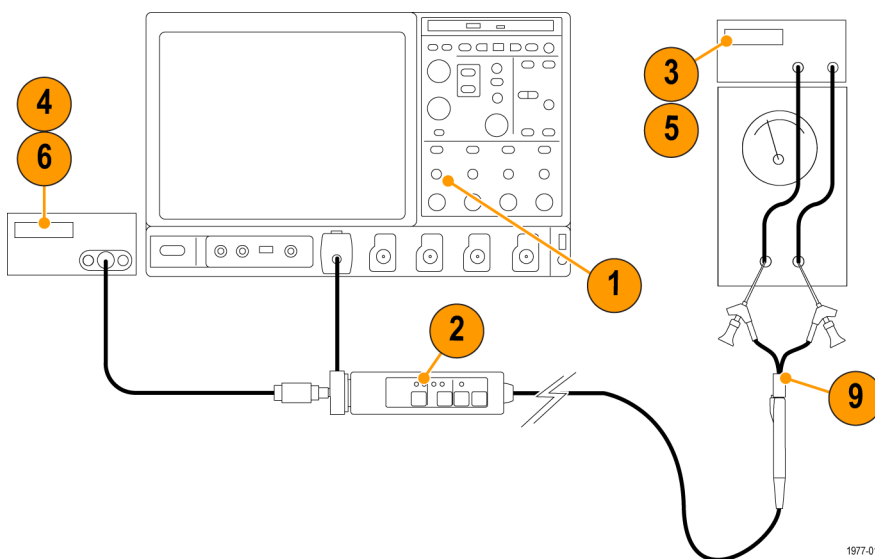

Figure 14: Differential signal range test

5. Set the input voltage on the DC source to $42\text{ V} \pm 100\text{ mV}$, and record the actual voltage as V_{in} .
6. Measure and record the output voltage as V_{out} .
7. Calculate attenuation as $|V_{\text{in}} \div (V_{\text{out}} - V_{\text{offset}})|$.
8. Verify that the attenuation is in the range of 47.5 to 52.5. Record the results in the test record.
9. Reverse the Y-lead connection on the probe to reverse the polarity of your following measurements.
10. Measure and record the output voltage as V_{out} .
11. Calculate attenuation using the formula in step 7.
12. Verify that the attenuation is in the range of 47.5 to 52.5. Record the results in the test record.

4.25 V Range.

13. Reverse the Y-lead connection on the probe (back to: red to +, black to -).
14. Set the DC source to $4.25\text{ V} \pm 10\text{ mV}$, and record the actual voltage as V_{in} .
15. Set the probe to the 4.25 V range.
16. Measure and record the output voltage as V_{out} .
17. Calculate attenuation using the formula in step 7.
18. Verify that the attenuation is in the range of 4.75 to 5.25. Record the results in the test record.
19. Reverse the Y-lead connection on the probe to reverse the polarity of your following measurements.
20. Measure and record the output voltage as V_{out} .
21. Calculate attenuation using the formula in step 7.
22. Verify that the attenuation is in the range of 4.75 to 5.25. Record the results in the test record.
23. Disconnect the probe from the test setup and connect it to any oscilloscope channel to keep the probe at operating temperature.

Analog Bandwidth

The following steps prepare the network analyzer for measuring bandwidth and CMRR. The actual settings may vary with different models of network analyzer. Refer to the user documentation supplied with the network analyzer for details on performing these steps.

Preparation

1. Set the network analyzer to measure transmission loss, S_{21} . Attach cables to both ports.
2. Set the display format to log magnitude, 1 dB/div, reference value -14 dBm, and linear frequency.
3. Set the start frequency to ≈ 1 MHz and the stop frequency to ≈ 2 GHz.
4. Set the test port power to $+10$ dBm.
5. Connect the TekVPI Calibration Fixture to any channel on the oscilloscope.
6. Attach the cable from port 1 of the network analyzer to the BNC connector in the probe socket on the TekVPI Calibration Fixture. Use a male BNC adapter if necessary.
7. Attach the cable from port 2 of the network analyzer to the SMA connector on the TekVPI Calibration Fixture. Use a male BNC adapter if necessary. The setup should now appear as shown. (See Figure 15.)
8. Normalize the network analyzer to remove the loss through the TekVPI Calibration Fixture.

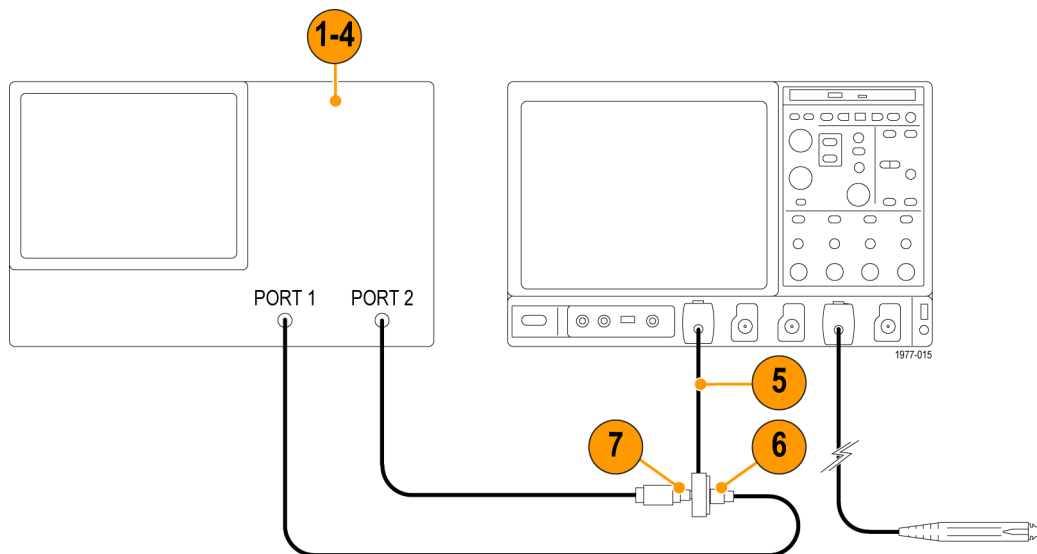

Figure 15: Normalize the signal path for the following tests

Verification

4.25 V Range.

NOTE. Do not remove the cable end that is connected to the network analyzer. Connect the cable to the Probe Tip-to-BNC adapter.

1. Disconnect the port 1 cable from the BNC connector in the probe socket on the TekVPI Calibration Fixture.
2. Connect the port 1 cable to the BNC connector on the Probe Tip to BNC adapter.
3. Connect the probe to the TekVPI Calibration Fixture.
4. Connect the probe head to the DM pins on the Probe Tip to BNC adapter. (See Figure 16.)
5. Set the probe for 4.25 V, full bandwidth, and DC reject off.

12. Press the bandwidth limit button on the probe to turn on the 1 MHz bandwidth limit.
13. Verify that the -3 dB bandwidth is approximately 1 MHz. (This is a functional check only. There is no specified performance limit for the bandwidth limit function.)
14. Cycle the bandwidth limit button on the probe back to full bandwidth.
15. Retain the setup for the next test.

Common Mode Rejection Ratio

If verification of analog bandwidth was not performed, or the calibration of the network analyzer has been altered, perform the calibration and normalization steps in the *Preparation* section of the Analog Bandwidth verification.

In this test, you first plot the differential mode gain, and then the common mode gain. Next, using the math function on the network analyzer, you create a plot that represents the reciprocal of the CMRR.

Verification

4.25 V Range.

1. Set the reference value of the network analyzer to -14 dB and position the reference near the top of the screen.
2. Verify that the test port power is set to $+10$ dBm.
3. Connect the probe input to the DM pins on the Probe Tip-to-BNC adapter. Polarity is unimportant.
4. Set the probe to the 4.25 V range, full bandwidth, and DC reject off.
5. The plot that is displayed represents the differential mode gain of the probe. Save this plot to the instrument memory.
6. Disconnect the probe input from the DM pins and connect it to the CM pins on the Probe Tip-to-BNC adapter. Make sure to connect the probe ground socket to the long ground pin on the fixture.
7. The plot that is displayed represents the common mode gain of the probe. You may need to adjust the reference level and scale to view the plot.
8. Use the math function of the network analyzer to divide this plot by the differential plot that you saved in step 5. The resulting plot is the reciprocal of the common mode rejection ratio. The CMRR can be read by inverting the sign of the magnitude.
9. Measure the CMRR at 30 kHz, 1 MHz, and 250 MHz. Analyzers with marker capability can do this directly by setting the marker intercepts at 30 kHz, 1 MHz, and 250 MHz. If necessary, turn on the network analyzer Average mode with 16 averages to stabilize the reading.
10. Verify that the CMRR is less than the values listed in Table 6, and record the results in the test record.

Table 6: CMRR limits

Frequency	4.25 V Range CMRR	42 V Range CMRR
30 kHz	≥ 50 dB	≥ 55 dB
1 MHz	≥ 45 dB	≥ 50 dB
250 MHz	≥ 25 dB	≥ 18 dB

42 V Range.

11. Change the voltage range on the probe to 42 V.
12. Measure the CMRR at 30 kHz, 1 MHz, and 250 MHz.
13. Calculate the actual CMRR by subtracting 20 dB from the absolute magnitudes to compensate for the attenuation (for example, $|-68 \text{ dB}| - 20 \text{ dB} = 48 \text{ dB}$).
14. Verify that the CMRR is less than the values in the 42 V column of Table 6, and record the results in the test record.
15. Disconnect the probe from the TekVPI Calibration Fixture and connect it to any channel on the oscilloscope to keep the probe at operating temperature.

Rise Time

This procedure verifies that the probe meets the warranted 4.25 V range rise time specification. Two rise times are measured; the test system alone, and then the test system with the probe included. The probe rise time is calculated using the two measurements.

This test uses the TDR function of the 80E04 sampling head as a fast rise time signal source. A second 80E0X sampling head is used to take the measurements. Although the following procedure assigns the TDR and measurement functions to specific oscilloscope channels, any channels can be used. However, the TDR function is only available on 80E04 sampling heads.



CAUTION. To prevent damage, use care when working with SMA connectors: support equipment to avoid mechanical strain on the connectors, and when tightening connections, use a torque wrench to 7.5 in-lbs.

Test System Rise Time

1. Connect the 80E04 sampling head to Channel 1 of the sampling oscilloscope. (See Figure 17.)
2. Connect the 80E0X sampling head to Channel 8 of the sampling oscilloscope.
3. Connect SMA cables to Channels 1 and 8 on the sampling heads.
4. Connect the SMA cable from Channel 1 to an SMA-to-BNC Adapter, and then to the BNC connector on the TekVPI Adapter.
5. Connect the SMA cable from Channel 8 to the SMA connector on the TekVPI Adapter.
6. Turn on Channel 8 and set the vertical scale to 50 mV/div.

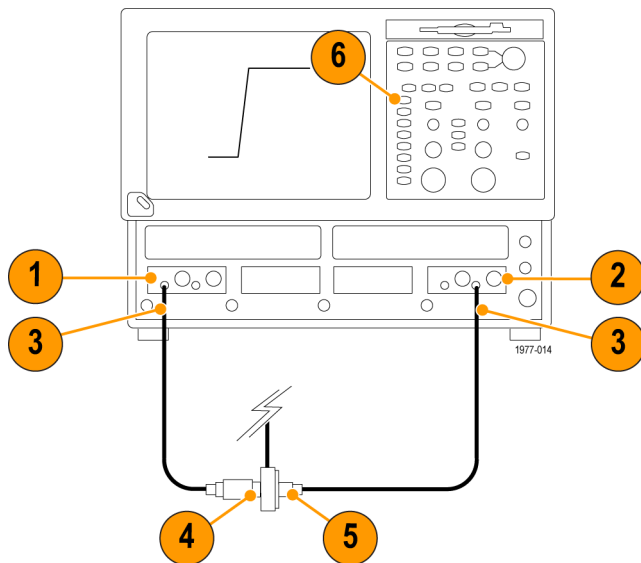

Figure 17: Test system rise time setup

7. Set the Channel 1 sampling head to TDR mode: press the **SETUP DIALOGS** button and select the TDR tab. (See Figure 18 on page 28.)
8. Set the Channel 1 (**C1**) **Polarity** to positive (rising).
9. Set the **Preset** of Channel 1 on. TDR Preset sets Internal Clock in the Trigger menu, turns on the TDR Step in the TDR Setups menu, turns on the channel and selects the acquisition Units in the TDR Setups menu, and sets the horizontal scale, position, and reference. The sampling module will turn on a red light next to the SELECT channel button, indicating that TDR is activated for that channel.

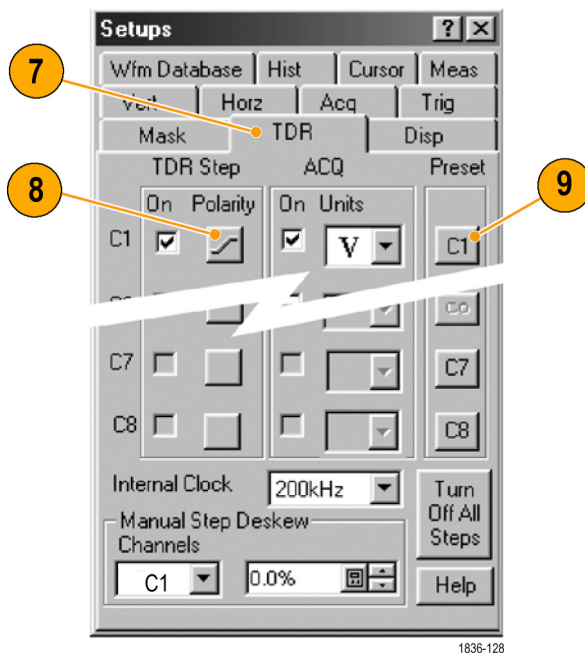

Figure 18: TDR parameter setup

10. Turn off the display for Channel 1 so that only Channel 8 is shown on screen.
11. Adjust the oscilloscope horizontal and vertical position controls to display a signal similar to that shown. (See Figure 17.)
12. Set the oscilloscope horizontal scale to 200 ps/div and center the waveform.
13. Use the oscilloscope measurement capability to display rise time. Increase the stability of the pulse edge measurement by using averaging, if available. Rise time is determined from the 10% and 90% amplitude points on the waveform. Record the rise time as t_s .

Test System and Probe Rise Time

14. Disconnect the SMA cable and BNC adapter from the Channel-1 side of the TekVPI Calibration fixture. (See Figure 19.)
15. Connect the SMA cable and BNC adapter from Channel 1 of the sampling oscilloscope to the BNC connector on the BNC-to-Probe Tip Adapter.
16. Connect the probe to the TekVPI Calibration fixture.
17. Connect the probe head to the DM pins on the BNC-to-Probe Tip Adapter.
18. Set the TekVPI oscilloscope offset to 0.0 V.

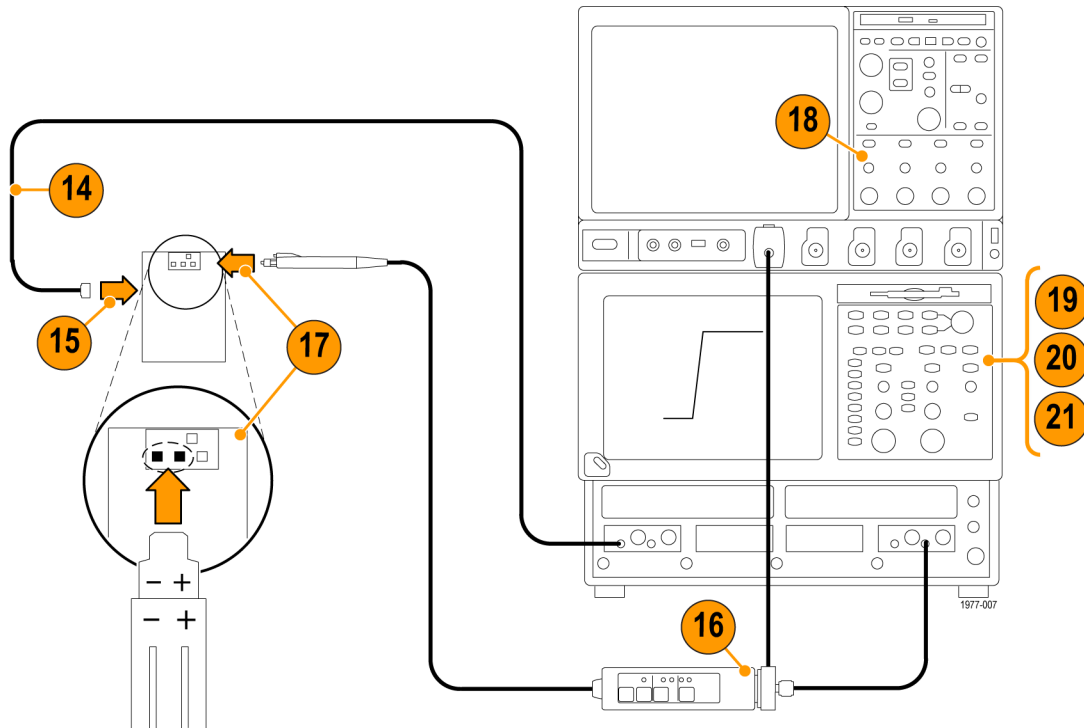

Figure 19: Probe rise time setup

NOTE. The following measurements are taken with the sampling oscilloscope. The TekVPI oscilloscope only provides power and offset to the probe.

19. On the sampling oscilloscope, expand the horizontal scale to locate the step edge: set the vertical scale to 10 mV/div, and adjust horizontal range to 200 ps/div while maintaining the edge view. For a more stable measurement display, turn on averaging.
20. Adjust the position controls on the sampling oscilloscope to display the entire leading edge waveform.
21. Use the measurement capability of the sampling oscilloscope to display rise time. Increase the stability of the pulse edge measurement by using averaging, if available. Rise time is determined from the 10% and 90% amplitude points on the waveform. Record the rise time as t_{s+p} .
22. Using the test system rise time (t_s) that you measured in step 13, and the test system and probe rise time (t_{s+p}) that you measured in step 21, calculate the probe-only rise time using the formula shown.

$$t_p = \sqrt{t_{(s+p)}^2 - t_s^2}$$

Example:

$$t_p = \sqrt{(450^2 - 50^2)}$$

$$t_p = \sqrt{202500 - 2500}$$

$$t_p = \sqrt{200000}$$

$$t_p = 447.2 \text{ ps}$$

This completes the performance verification. An optional rise time check for the 42 V range follows.

High Voltage Rise Time Check (Optional)

Use the following optional test to check the probe rise time on the 42 V range setting.



WARNING. Burn hazard exists. The 50 W termination used in this test will get hot if the duty cycle of the pulse generator is higher than 10%. Use caution when locating the termination in your test setup.

Test System Rise Time

1. Connect the TekVPI Calibration Fixture to the TekVPI oscilloscope.
2. Connect the 80E0X sampling head to Channel 8 of the sampling oscilloscope.
3. Connect an SMA cable to Channel 8 on the sampling head.
4. Connect the SMA cable from Channel 8 to the SMA connector on the TekVPI Adapter.
5. Connect an SMA-to-BNC adapter to one of the SMA connectors on the probe calibration fixture.
6. Connect one end of the high power attenuator to the BNC adapter on the probe calibration fixture.
7. Connect the other end of the high power attenuator to the BNC connector on the TekVPI Adapter.
8. Connect a short SMA cable from the other SMA connector on the probe calibration fixture to the high voltage output connector on the pulse generator.
9. Connect the trigger out from the pulse generator to the trigger in on the sampling oscilloscope.

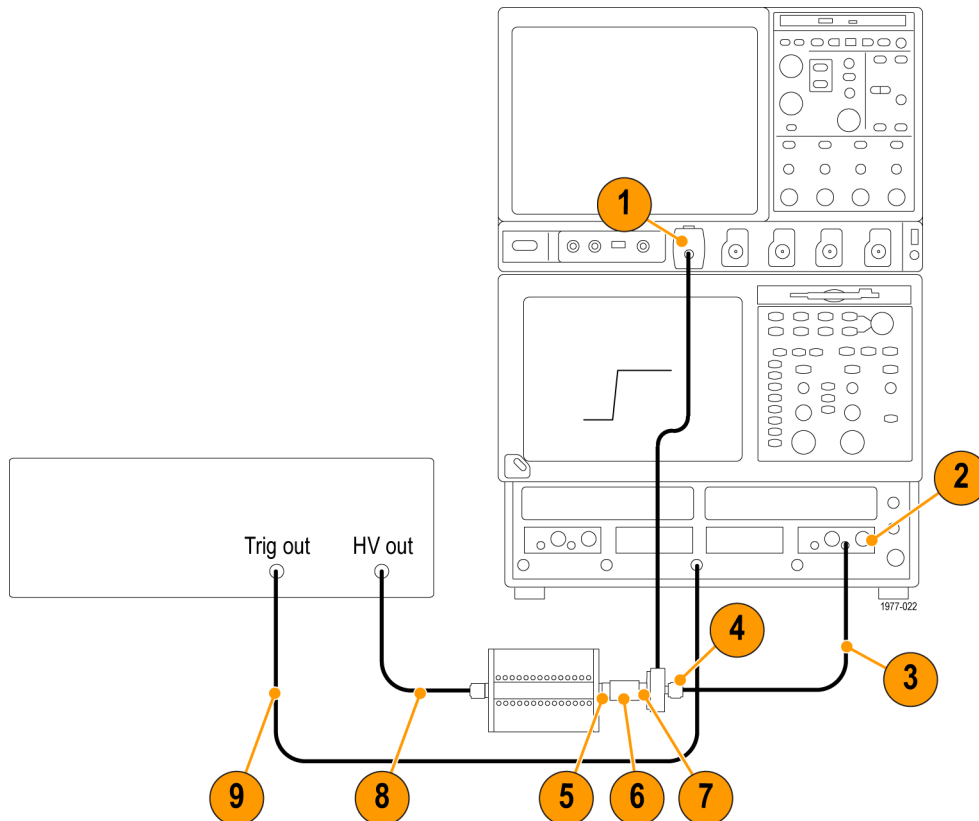

10. Turn on Channel 8 and set the vertical scale to 100 mV/div.
11. Turn on the pulse generator and set the output to approximately 40 V.
12. Adjust the oscilloscope horizontal and vertical position controls to display a rise time signal similar to that shown in the setup figure.
13. Set the oscilloscope horizontal scale to 500 ps/div and center the waveform.
14. Use the oscilloscope measurement capability to display rise time. Increase the stability of the pulse edge measurement by using averaging, if available. Rise time is determined from the 10% and 90% amplitude points on the waveform. Record the rise time as t_s .

Test System and Rise Time

15. Disconnect the SMA-to-BNC adapter from the BNC connector on the TekVPI Adapter.
16. Connect the BNC end of the adapter to the 50 W termination.
17. Connect the probe to the TekVPI Calibration fixture.
18. Connect two spring-loaded probe tips to the probe head sockets.
19. Set the probe to the 42 V range.

20. Touch the probe tips to the DM pads on the probe calibration adapter and measure the rise time. (See Figure 20 on page 33.) Record the measured rise time of the system and probe as t_{s+p} . This measurement at the 42 V range is typically about 400 ps.
21. Perform the calculation with the two measured rise times and the formula below. A typical result will be about 330 ps.

$$t_p = \sqrt{t_{(s+p)}^2 - t_s^2}$$

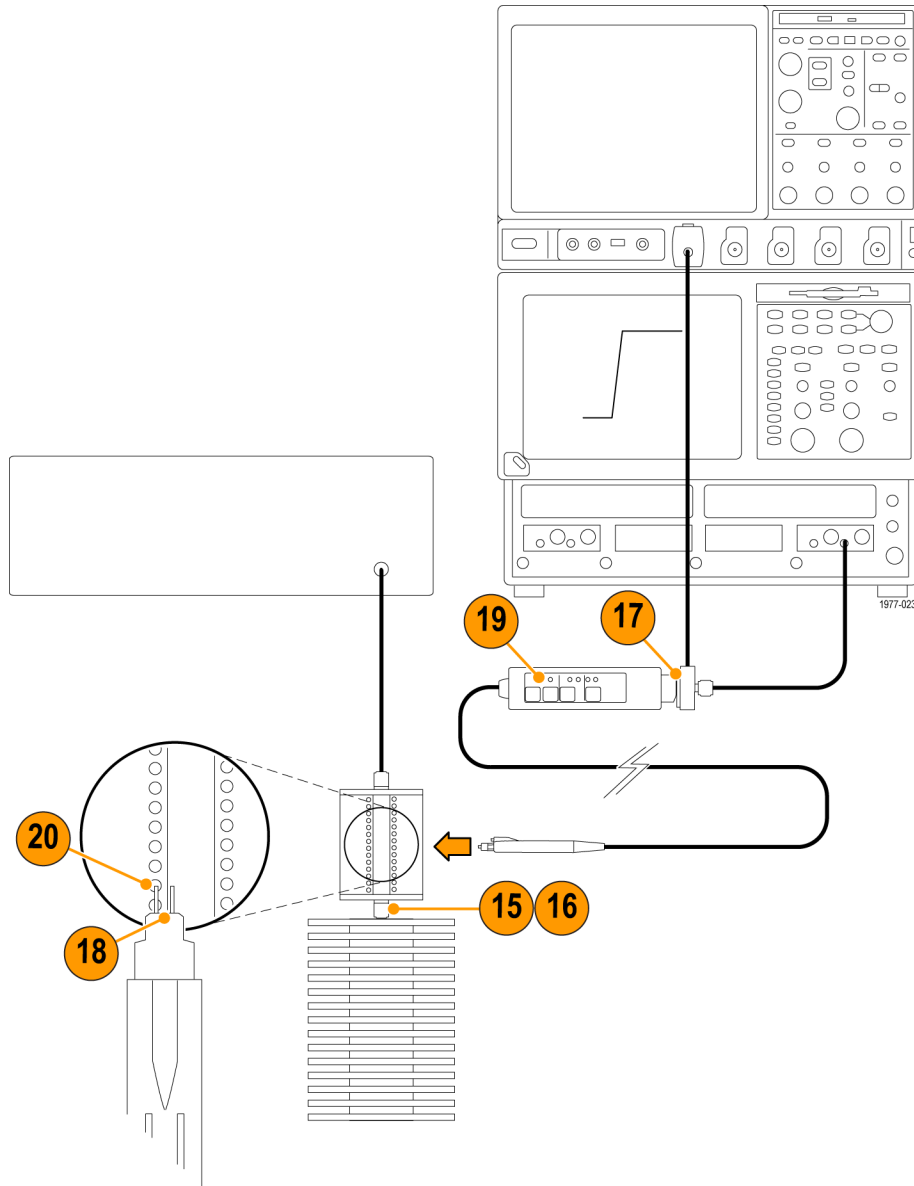

Figure 20: Probe rise time setup (42 V range)

Table 7: Test Record

Probe Model/Serial Number: _____ Certificate Number: _____

Temperature: _____ RH % : _____

Date of Calibration: _____ Technician: _____

Performance test	Minimum	Measured/Calculated	Maximum
DC attenuation accuracy			
42 V range	47.5	_____	52.5
4.25 V range	4.75	_____	5.25
Differential signal range			
42 V range	47.5	_____	52.5
with connections reversed	47.5	_____	52.5
4.25 V range	4.75	_____	5.25
with connections reversed	4.75	_____	5.25
Rise Time			
4.25 V range			
TDP0500 at 500 MHz	≤700 ps	_____	N/A
TDP1000 at 1 GHz	≤350 ps	_____	N/A
Analog bandwidth			
TDP0500 at 500 MHz			
TDP1000 at 1 GHz			
4.25 V range	- 3 dB	_____	N/A
42 V range	- 3 dB	_____	N/A
CMRR			
4.25 V range			
30 kHz	50 dB	_____	N/A
1 MHz	45 dB	_____	N/A
250 MHz	25 dB	_____	N/A
42 V range			
30 kHz	55 dB	_____	N/A
1 MHz	50 dB	_____	N/A
250 MHz	18 dB	_____	N/A

Appendix A: Alternate Verification Procedures

This appendix contains alternate procedures for verifying the following specifications:

- Analog bandwidth
- Common mode rejection ratio

Use these alternate procedures only if you cannot obtain a network analyzer.

Equipment Required

Table 8: Test equipment

Description	Minimum requirements	Example product
Sine wave generator (preferably a synthesizer)	0 dBm to 20 dBm from 1 MHz to 1 GHz.	Fluke 6066
Spectrum analyzer	DC to 3 GHz (dynamic range ≥ 100 dBm at 1 MHz)	Advantest RSA 3303A
TekVPI Calibration Fixture	Optional probe accessory	Tektronix 067-1701-xx
BNC-to-Type N coaxial adapters (2)	Type N male-to-BNC female	Tektronix 103-0045-xx
BNC cables (2)	50 Ω , 18 inch	Tektronix 012-0076-xx
Probe tip adapter BNC-to-probe tip	Optional probe accessory	Tektronix 067-1734-xx

Preparation

Prepare the equipment as follows:

1. Connect the equipment as shown. (See Figure 21 on page 36.) This setup is identical to the network analyzer setup in the main procedure, except that the synthesizer and spectrum analyzer replace the network analyzer. (See Figure 15 on page 22.)
2. Allow all test equipment to warm up for 20 minutes in an environment that is within the environmental conditions listed in the specifications section.

Perform the verification procedures in order.

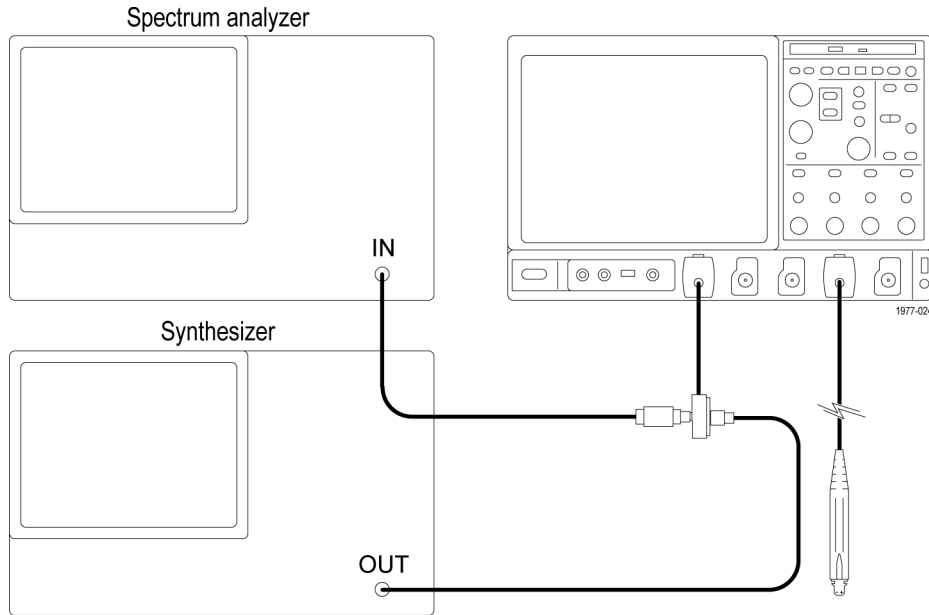

Figure 21: Alternate Bandwidth and CMRR test setup

Analog Bandwidth

Normalize the Setup

1. Set the synthesizer for 1 GHz/10 dBm for the TDP1000 probe and 500 MHz/10 dBm for TDP0500 probe.
2. Set the spectrum analyzer:
 - Center frequency at 500 MHz for the TDP0500 probe, and 1 GHz for the TDP1000 probe.
 - Span to 10 MHz.
 - Resolution bandwidth to auto.
 - Reference level to 10 dBm.
 - Vertical sensitivity to 2 dB/div.
3. Record the level displayed on the spectrum analyzer. (This level represents the synthesizer output minus the signal path loss.)

Verification

4. Disconnect the BNC cable from the BNC connector in the probe socket on the TekVPI Calibration Fixture.
5. Connect the BNC cable to the BNC-to-probe tip adapter.
6. Connect the probe into the probe socket on the TekVPI Calibration Fixture.
7. Connect the probe tip to the DM pins of the BNC-to-probe tip adapter. (See Figure 22.)

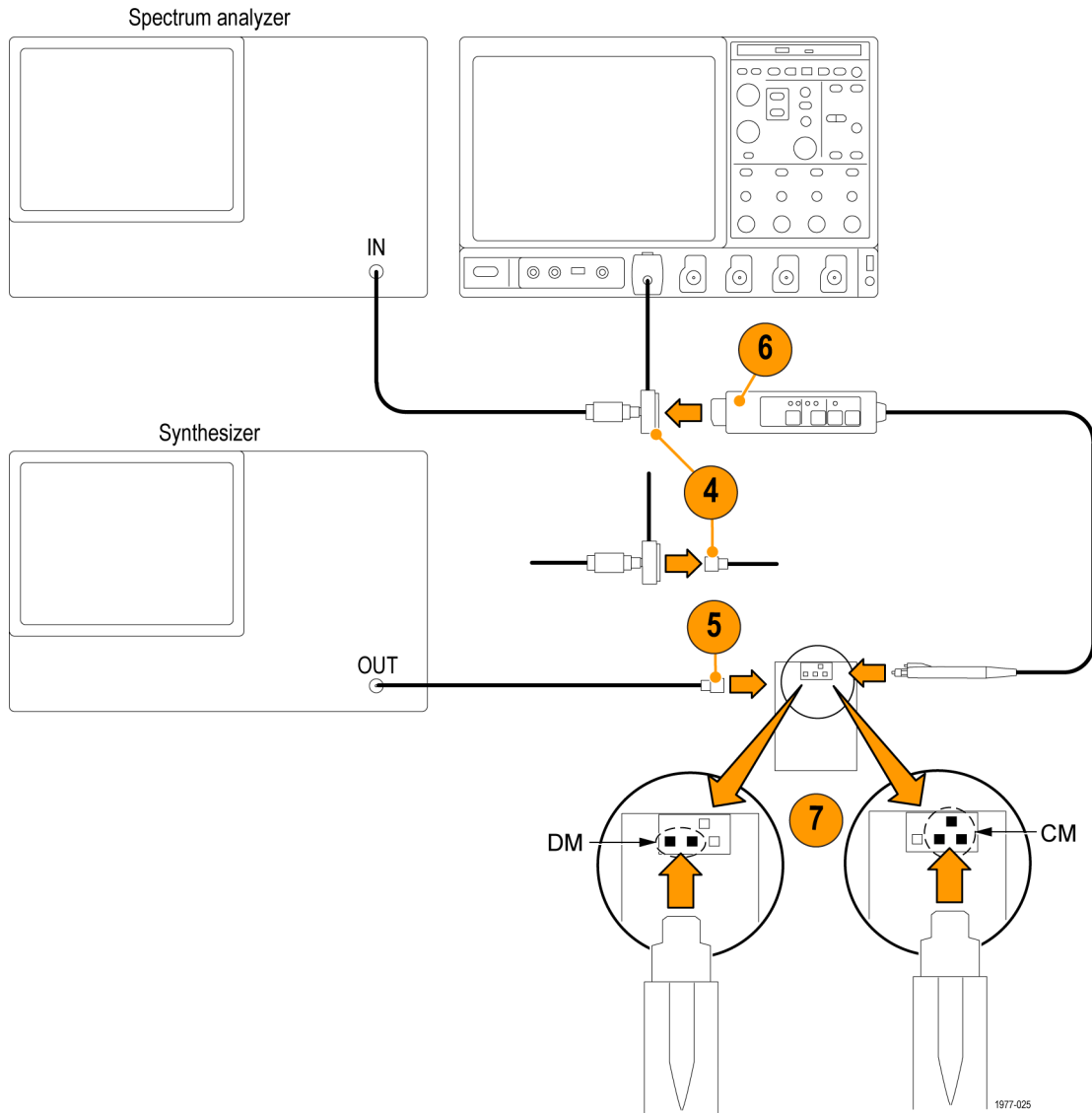

Figure 22: Probe tip test connections

8. Set the probe to 4.25 V range, DC reject off, full bandwidth.
9. Adjust the reference level of the spectrum analyzer to display a signal on screen.

10. Record the level displayed on the spectrum analyzer. This level must be within 17 dB of the level that you recorded in step 3. For example, if the reference level from step 3 is 9 dBm, and the level that you measured in this step is -7 dBm, then the difference between the two measurements is 16 dBm, which is within the probe specification.
11. Set the probe to the 42 V range.
12. Change the reference level of the spectrum analyzer to -24 dBm.
13. Record the level displayed on the spectrum analyzer. This level must be within 37 dB of the level that you recorded in step 3. For example, if the reference level from step 3 is 9 dBm, and the level that you measured in this step is -26 dBm, then the difference between the two measurements is 35 dBm, which is within the probe specification.
14. Keep the setup for the next procedure (CMRR).

CMRR (Common Mode Rejection Ratio)

Verification

Use the setup from the previous test, and enter your measurements in the table below to calculate the CMRR. Record the calculated CMRR in the test record.

1. Set the probe to the 4.25 V range.
2. Connect the probe to the DM pins of the BNC-to-probe tip adapter.
3. Set the synthesizer for 1 MHz and 10 dBm.
4. Adjust the spectrum analyzer input attenuator to accept the high level of 10 dBm.
5. Set the reference level to 0 dBm, the center frequency to 1 MHz, and the vertical scale to 10 dB/div.
6. Adjust the span to 10 kHz and the resolution bandwidth to auto.
7. Record the level displayed on the spectrum analyzer. This represents the differential mode measurement at the 4.25 V range.
8. Set the probe to the 42 V range.
9. Record the level displayed on the spectrum analyzer. This represents the differential mode measurement at the 42 V range.
10. Connect the probe to the CM and ground pins on the BNC-to-probe tip adapter.
11. Adjust the reference level of the spectrum analyzer to display the waveform. Use the noise filter for easier measuring.
12. Record the level displayed on the spectrum analyzer. This represents the common mode measurement at the 42 V range.
13. Set the probe to the 4.25 V range.
14. Record the level displayed on the spectrum analyzer. This represents the common mode measurement at the 4.25 V range.
15. Calculate the CMRR for each voltage range by subtracting the common mode measurement from the differential mode measurement.
16. Repeat the procedure for the remaining frequencies listed in the table.

Test Frequency	Differential Mode Measurements		Common Mode Measurements		CMRR @4.25 V (Calculated)	CMRR @42 V (Calculated)
	4.25 V	42 V	42 V	4.25 V		
30 kHz						
1 MHz						
250 MHz						

Maintenance

This section contains maintenance information for the TDP0500 and TDP1000 differential probes.

Inspection and Cleaning

Protect the probe from adverse weather conditions. The probe is not waterproof.



CAUTION. To prevent damage to the probe, do not expose it to sprays, liquids, or solvents. Do not use chemical cleaning agents; they may damage the probe. Avoid using chemicals that contain benzene, benzene, toluene, xylene, acetone, or similar solvents.

Clean the exterior surfaces of the probe with a dry, lint-free cloth or a soft-bristle brush. If dirt remains, use a soft cloth or swab dampened with a 75% isopropyl alcohol solution. A swab is useful for cleaning narrow spaces on the probe. Do not use abrasive compounds on any part of the probe.



CAUTION. To prevent damage to the probe, avoid getting moisture inside the probe during exterior cleaning, and use only enough solution to dampen the swab or cloth. Use a 75% isopropyl alcohol solution as a cleanser, and rinse with deionized water.

Replacement Parts

Due to the sophisticated design of these differential probes, there are no user replaceable parts within the probes. Refer to the *Quick Start User Manual* for a list of replaceable accessories for your probe.

If your probe does not meet the specifications tested in the Performance Verification, you can send the probe to Tektronix for repair. Follow the procedure below to prevent damage to the probe during shipping.

Preparation for Shipment

If the original packaging is unfit for use or not available, use the following packaging guidelines:

1. Use a corrugated cardboard shipping carton having inside dimensions at least one inch greater than the probe dimensions. The box should have a carton test strength of at least 200 pounds.
2. Put the probe into an antistatic bag or wrap to protect it from dampness.
3. Place the probe into the box and stabilize it with light packing material.
4. Seal the carton with shipping tape.
5. Refer to *Contacting Tektronix* on the copyright page for the shipping address.