

TEKTRONIX®

**147A/149A
NTSC TEST
SIGNAL GENERATORS**

INSTRUCTION MANUAL

Tektronix, Inc.
P.O. Box 500
Beaverton, Oregon 97077

Serial Number

5081282



WARRANTY

All TEKTRONIX instruments are warranted against defective materials and workmanship for one year. Any questions with respect to the warranty should be taken up with your TEKTRONIX Field Engineer or representative.

All requests for repairs and replacement parts should be directed to the TEKTRONIX Field Office or representative in your area. This will assure you the fastest possible service. Please include the instrument Type Number or Part Number and Serial Number with all requests for parts or service.

Specifications and price change privileges reserved.

Copyright © 1976 by Tektronix, Inc., Beaverton, Oregon. Printed in the United States of America. All rights reserved. Contents of this publication may not be reproduced in any form without permission of Tektronix, Inc.

U.S.A. and foreign Tektronix products covered by U.S. and foreign patents and/or patents pending.

TEKTRONIX is a registered trademark of Tektronix, Inc.

OPERATING INSTRUCTIONS AND SPECIFICATION

INSTRUMENT DESCRIPTION

The 147A and 149A NTSC Test Signal Generators are high-quality test instruments capable of providing a variety of functions useful in testing video systems or discrete parts of systems. Most of the test signals generated are available as full-field signals and as Vertical Interval Test Signals (VITS). The front-panel selected signals will accommodate most users; however, certain parameters may be changed by internal programming. Test signals available are: Noise (147A only), Flat Field, Multiburst, Linearity, Composite, Sin² Pulse & Bar, Window, Field Square Wave, Color Bars or Modulated Pedestal (149A only), and VIRS (Vertical Interval Reference Signal).

The 147A and 149A signals are Gen-Locked¹ to the incoming program signal or to a black burst master generator, assuring accurate timing and phasing of the output. A front-panel light activates with loss of incoming sync, indicating the free-running state of the instrument.

INSTALLATION

NOTE

Installation of this instrument should be performed or supervised by a qualified technician or engineer.

Rackmounting

Complete information for mounting the 140-Series of instruments in a standard 19" rack is given in Section 5 of this manual.

¹Synchronization of signals in both frequency and phase.

Power Source

WARNING

This instrument is intended to be operated from a single-phase power source which has one of its current-carrying conductors (the neutral conductor) at or near ground (earth) potential. Operation from other power sources where both current-carrying conductors are live with respect to ground (such as phase-to-phase on multi-phase systems) is not recommended, as only the Line Conductor has over-current (fuse) protection within the instrument.

Operating Voltage

The 147A and 149A may be operated from either 115-Vac or 230-Vac (nominal) line voltage sources. Quick-change line-voltage plugs, located under the fuse cover on the rear panel, change the transformer primary connections. The plugs permit one of three line-voltage operating ranges to be selected. Table 1-1 lists the voltage ranges that enable the instrument dc power supplies to regulate properly.

To convert to a different line voltage, proceed as follows:

1. Disconnect the 147A or 149A from the power source.
2. Unscrew the two captive screws holding the fuse cover. Remove the cover and attached fuses.
3. Pull out the 115/230 Voltage Selector plug (see Fig. 1-2), then rotate the plug 180° and insert it into the opposite set of holes. The 115/230 Voltage Selector plug is located in the upper position for 115 V operation, and in the lower position for 230 V operation.

Operating Instructions and Specifications—147A/149A

4. To change the line-voltage operating range (LO, M, or HI), pull out the Range Selector plug (see Fig. 1-2) and insert it in the desired hole locations. Select a range with a center voltage (see column 3 in Table 1-1) closely corresponding to the line voltage that will be applied in regular instrument operation.

TABLE 1-1

115/230 Voltage Selector Plug Position	Range Selector Plug Position	Nominal Line (Center) Voltage	Line Voltage Plug Range ²	Fuse Values
115 V	LO (Low)	100 Vac	90 to 110 Vac	0.75 A
	M (Medium)	115 Vac	104 to 126 Vac	Fast-Blow
	HI (High)	124 Vac	112 to 136 Vac	Blow
230 V	LO (Low)	200 Vac	180 to 220 Vac	0.5 A
	M (Medium)	230 Vac	208 to 252 Vac	Fast-Blow
	HI (High)	248 Vac	224 to 272 Vac	Blow

²Applicable when the line contains less than 2% total distortion.

5. Re-install the cover with two captive screws and fuses. Be sure the cover fits firmly against the rear panel. This indicates that the line fuses are seated properly in the fuse clips.

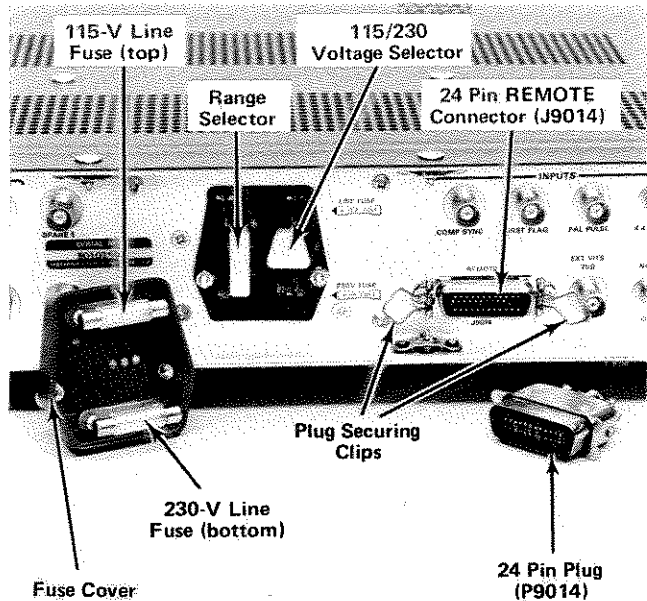

Fig. 1-2. Location of Range and Voltage Selector plugs with fuse cover removed (plugs are set for 115-V medium range operation as shown). Also shown is the REMOTE connector (J9014), Plug (P9014), and plug securing clips.

6. Before applying power to the instrument, check that the indicating tabs on the selector plugs protrude through the proper holes in the cover for the correct line voltage and the proper operating range.

CAUTION

The 147A and 149A should not be operated with the 115/230 Voltage Selector and/or Range Selector plugs in the wrong position for the line voltage applied.

Local/Remote Connector

The 147A or 149A may be installed at one location and functionally-controlled from a remote location by means of the REMOTE connector-plug (J9014-P9014) and the LOCAL/REMOTE switch. FULL FIELD and PROGRAM/PREVIEW switching is available at the front panel and at the REMOTE connector. In addition, the REMOTE connector provides access for switching of Sync Source, NORM/BYPASS, VIRS insert-delete, and for relay control of the CW Subcarrier. The REMOTE plug comes factory-wired for LOCAL operation as shown in Fig. 1-3.

To operate in REMOTE, separate switching must be used at the remote location(s). Typical wiring for remote switches, with their connections to the REMOTE plug, is shown in Fig. 1-4. Pin 6 of the REMOTE plug has a multiple purpose. It can be grounded to provide CW Subcarrier at all times whether burst is present or absent. Also, pin 6 can be used as an output to control circuitry as a function of burst presence. When incoming burst is present, the level at pin 6 will be low, about 0 volt. If burst is absent, the output will be high, about 5 volts. This high level is obtained through relay K390; therefore, any circuit driven by the high level must be of sufficiently high impedance to keep K390 from activating.

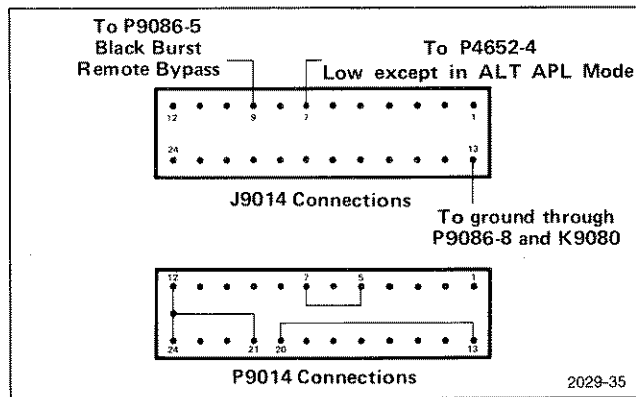

Fig. 1-3. Wiring diagram of Remote Plug for LOCAL operation (factory connected).

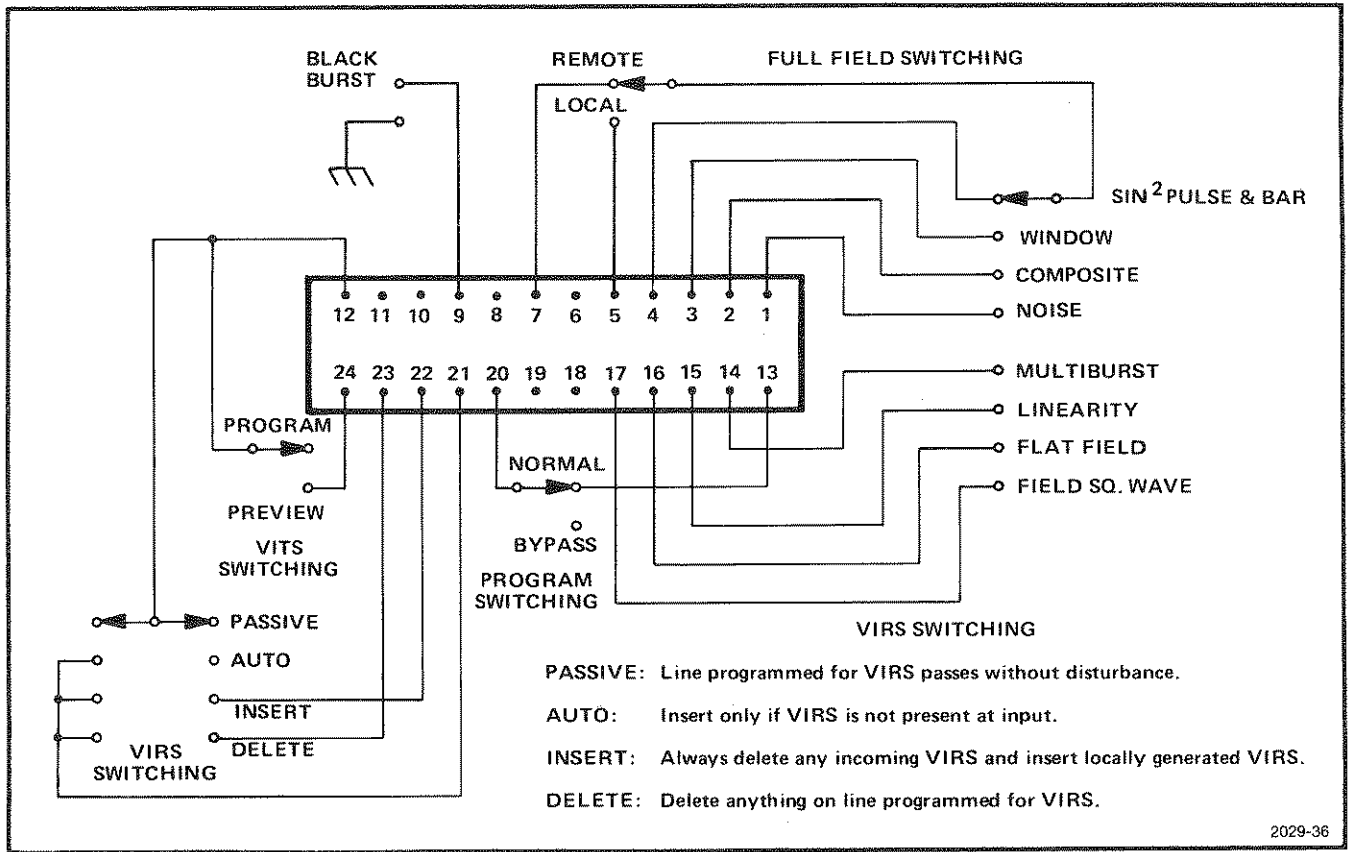

Fig. 1-4. Wiring Diagrams for REMOTE operation.

NOTE

Due to the many possible combinations of cable lengths and configurations, it may be necessary to compensate for the reactance added to the 147A or 149A circuitry by the remote cabling.

BNC-T Connectors

A pair of BNC-T connectors are supplied as accessories to this instrument. These connectors should be installed on the PROGRAM LINE IN and PROGRAM LINE OUT connectors. When the instrument needs to be removed during a program, a short coaxial cable connected between the two BNC-T connectors allows program continuity. (See Fig. 1-5.)

Repackaging

If this instrument is to be shipped long distances by commercial transportation, repackage it in the original

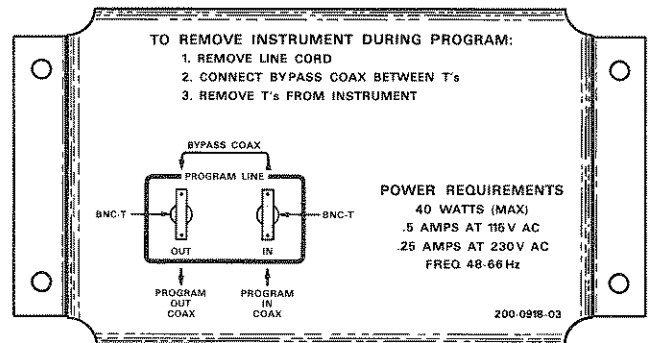

Fig. 1-5. Installing the BNC-T connectors.

manner for maximum protection. The original shipping carton can be saved and used for this purpose. An illustration in the Maintenance section, Fig. 2-4, shows how to repackage the instrument. Contact your local Tektronix Field Office, Service Center, or Representative for shipping instructions.

FRONT- AND REAR-PANEL DESCRIPTION

Introduction

The following describes the function or operation of the various controls and connectors found on the front- and rear-panel of the 147A and 149A. Front-panel controls are functionally-grouped for ease in operation. Each major function (Program Control, Full Field Sig, etc.) is identified and enclosed within an outlined area on the panel. Individual controls related to each function are enclosed within the separate outlined areas. Refer to Figs. 1-6, 1-7, and 1-8 as these items are explained.

Front-Panel

- 1 POWER Toggle switch to turn instrument power ON and OFF.
- 2 POWER ON Lamp Green light which indicates when the POWER switch is ON and the instrument is connected to a line voltage source.
- 3 NONSYNCHRO- NOUS MODE— NO VITS A red light indicates the absence of incoming sync information. In this condition, no VITS will be inserted. Full-field

4 PROGRAM CONTROL

signals are generated, but line and field sync are not locked to subcarrier.

Consists of three level switches, four variable controls, and two indicator lamps to: select signal modes, control their amplitude, phase, and timing relationships, and indicate operating status.

5 UNITY GAIN/ VAR

UNITY GAIN position selects unity gain between the program input and the program output.

The VAR position connects the front-panel LEVEL control.

6 LEVEL

This control varies the gain of the program amplifier, allowing the incoming signal to match the inserted signal amplitude.

7 INSERT DELAY

A screwdriver adjustment which permits time-positioning of the internally-generated VIT signals with respect to the incoming signal.

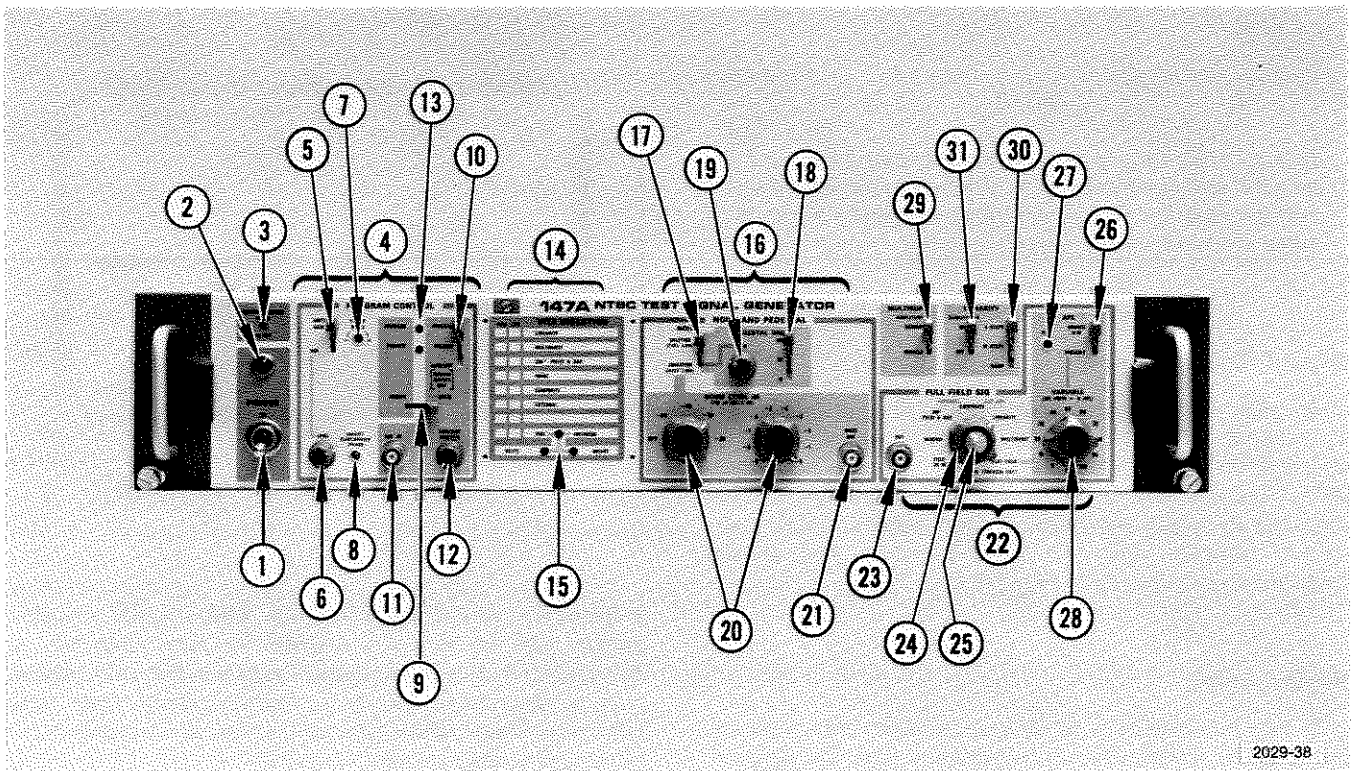

Fig. 1-6. 147A front-panel controls and connectors.

- | | | | |
|--------------------------------------|--|--|---|
| 8 INSERT SUB-CARRIER PHASE | A screwdriver adjustment which permits setting the phase of the color subcarrier on internally generated signals with respect to the incoming color burst signal. | | lamps indicate the actual operating mode of PROGRAM and PREVIEW, in that order, whether in LOCAL or REMOTE. All lamps "out" indicate that the program signal is bypassed to PROGRAM LINE OUT. |
| 9 LOCAL/REMOTE | The LOCAL position enables front-panel control of the 147A or 149A Program or Preview modes. In the REMOTE position, operation is controllable by connection of a remote switching circuit to the rear-panel REMOTE connector (see Fig. 1-4). With the factory-wired REMOTE plug connected, the instrument will be in the PREVIEW mode when this switch is in REMOTE. | 14 VITS INSERTION | Cover plate with a table showing the factory programming of the VIT signals. The cover plate may be removed, leaving a blank programming panel to label any changes in the VITS programming. |
| 10 PROGRAM/
PREVIEW/
AUXILIARY | <p>The PROGRAM position inserts VITS on the PROGRAM, PROGRAM MONITOR, and PREVIEW MONITOR outputs.</p> <p>The PREVIEW position inserts VITS on the PREVIEW MONITOR outputs only, allowing verification prior to inserting VITS on PROGRAM OUT.</p> <p>The AUXILIARY position permits a non-video signal to be inserted on a pedestal during active video time. The resulting composite video signal is available at the PREVIEW MONITOR OUTPUTS.</p> | 15 VIRS Lamps | Three lamps indicate status of the VIR signal. |
| | | INCOMING | A green lamp indicates that the VIRS is present on the incoming composite video signal. |
| | | DELETE | A red lamp indicates that any incoming signal on the line programmed for VIRS is being deleted. |
| | | INSERT | A yellow lamp indicates that an internally generated VIRS is being inserted on the line programmed for VIRS. |
| | | 16 NOISE AND
PEDESTAL
(147 only) | Consists of two level switches, two rotary switches, and one variable control to select conditions of the NOISE signal. |
| | | 17 NOISE | Two-position lever switch to select mode. |
| 11 AUX IN | BNC input connector. Accepts non-video signal (e.g., sinewave or sweep generator signals) and inserts it on a pedestal during active video time. The combined signal appears at the PREVIEW MONITOR OUTPUTS when the instrument is in the AUXILIARY mode. | DELETION
(FULL LINE) | This position deletes any signal on the NOISE VITS lines and inserts a pedestal. When the FULL FIELD SIG Selector switch is in NOISE position, and the PROGRAM/PREVIEW/AUXILIARY switch is in PREVIEW position, the full field signal at the PREVIEW MONITOR OUTPUTS will be deleted and a pedestal inserted. |
| 12 AUXILIARY
PEDESTAL | Controls the level of the AUXILIARY signal with respect to the blanking level. This allows positioning between the white and black levels. | INSERTION
(HALF LINE) | This position deletes noise during the center half of the NOISE VITS lines, and half of the full field signal on the PREVIEW MONITOR OUTPUTS if PREVIEW and NOISE are selected. Noise and pedestal, as selected by the NOISE LEVEL dB, PEDESTAL (IRE) and VAR controls, is inserted in the space deleted. |
| 13 PROGRAM/
PREVIEW Lamps | When in REMOTE, the status of the instrument may not be indicated by the position of the PROGRAM/PREVIEW/AUXILIARY switch. Green and yellow | | |

Operating Instructions and Specifications—147A/149A

18 PEDESTAL (IRE)	Selects one of three pedestal levels; 10, 50, or 100 IRE.	26 APL	Two-position level switch to control APL of the FLAT FIELD signal.
19 VAR	Potentiometer controls the change in the pedestal level of at least ± 10 IRE. This permits accurate matching of the pedestal level with the level of the measured signal.	BOUNCE 10-90	In this position, the APL will automatically bounce between 10 IRE and 90 IRE at a repetition rate determined by the RATE control.
20 NOISE LEVEL dB	Two rotary switches vary the amplitude of the internally generated noise signal from -20 dB to -59 dB. The left-hand switch controls in 10 dB increments, and the right-hand switch controls in 1 dB increments.	27 RATE	Screwdriver adjustment sets the repetition rate of bounce from 1 second to about 15 seconds.
21 NOISE OUT Connector	This output contains only the NOISE signal. It does not have comp sync, blanking, or pedestal. A 4.2 MHz low-pass filter should be used in series with this output.	VARIABLE	In this position, the level of the active portion of the line is selectable as determined by the VARIABLE APL switch.
22 FULL FIELD SIG	Consists of two rotary switches and one lever switch to select the type of test signal available at the OUT (or rear-panel FULL FIELD TEST SIGNAL) connector and to select the type of control over the FLAT FIELD signal.	28 VARIABLE APL	Rotary switch selects one of eleven APL's at 10 IRE increments from 0 to 100 IRE. 50% APL is repeated between the 0% and 100% APL's to provide a quick change from 0% to 50% to 100%. This is useful for determining APL dependent distortions.
23 FULL FIELD SIG OUT	The front-panel connector for the full field test signals.	29 MULTIBURST AMPLITUDE	Two-position lever switch to select peak-to-peak amplitude of the MULTIBURST signal.
24 FULL FIELD SIG Selector	Eight-position rotary switch to select one of the following test signals: MULTIBURST, LINEARITY, COMPOSITE, SIN^2 PULSE & BAR, WINDOW, FIELD SQ WAVE, FLAT FIELD, and either NOISE (147A only), or COLOR TEST SIGNAL (149A only).	NORMAL	In this position, the multiburst amplitude is 90 IRE peak-to-peak, centered at the 55 IRE level.
25 FULL FIELD SIG Mode	Two-position rotary switch (concentric with FULL FIELD SIG Selector switch) to select Full Field mode.	REDUCED	In this position, the multiburst amplitude is 60 IRE peak-to-peak, centered at the 40 IRE level.
NORMAL	In this position, the selected full field signal is available on each active line.	30 LINEARITY	Consists of two lever switches to control the LINEARITY test signal.
ALT APL	In this position, the full field signal occurs every fifth line, followed by four lines of FLAT FIELD.	5 STEP/ 10 STEP/ RAMP	Three-position lever switch to select type of LINEARITY test signal.
		5 STEP	LINEARITY signal consists of the 5 step staircase.
		10 STEP	LINEARITY signal consists of the 10 step staircase.
		RAMP	LINEARITY signal consists of the RAMP signal.

- | | | | |
|---|--|--|---|
| <p>31 LINEARITY SUB-CARRIER</p> <p>ON</p> <p>OFF</p> | <p>This position adds 40 IRE peak-to-peak of 180° subcarrier to the selected LINEARITY signal.</p> <p>This position disables the LINEARITY subcarrier.</p> | <p>FULL FIELD</p> | <p>This position enables both chrominance and luminance during the entire field of active lines.</p> |
| <p>32 COLOR TEST SIGNAL (149A only)</p> | <p>Consists of two lever switches to control the signal at the FULL FIELD SIG output when the FULL FIELD Selector is in the COLOR TEST SIGNAL position.</p> | <p>34 COLOR TEST SIGNAL Selector</p> <p>COLOR BARS</p> <p>MODULATED PEDESTAL</p> | <p>This switch selects either COLOR BARS, MODULATED PEDESTAL, or 50 IRE PEDESTAL.</p> <p>In this position, color bars in accordance with FCC Rules and Regulations §73.699 are provided.</p> <p>In this position, three levels of color subcarrier superimposed on a luminance pedestal are provided. The test signal is in accordance with STOC (Satellite Technical and Operational Committee) Test Signal No. 2.</p> |
| <p>33 COLOR TEST SIGNAL Field Timing</p> <p>SPLIT FIELD</p> | <p>This switch controls the field timing of the chrominance portion of the COLOR BAR signal.</p> <p>This position enables chrominance only during lines 66 through 216 of the Full Field signal.</p> | <p>50 IRE PEDESTAL</p> | <p>In this position, all active lines are at 50 IRE.</p> |

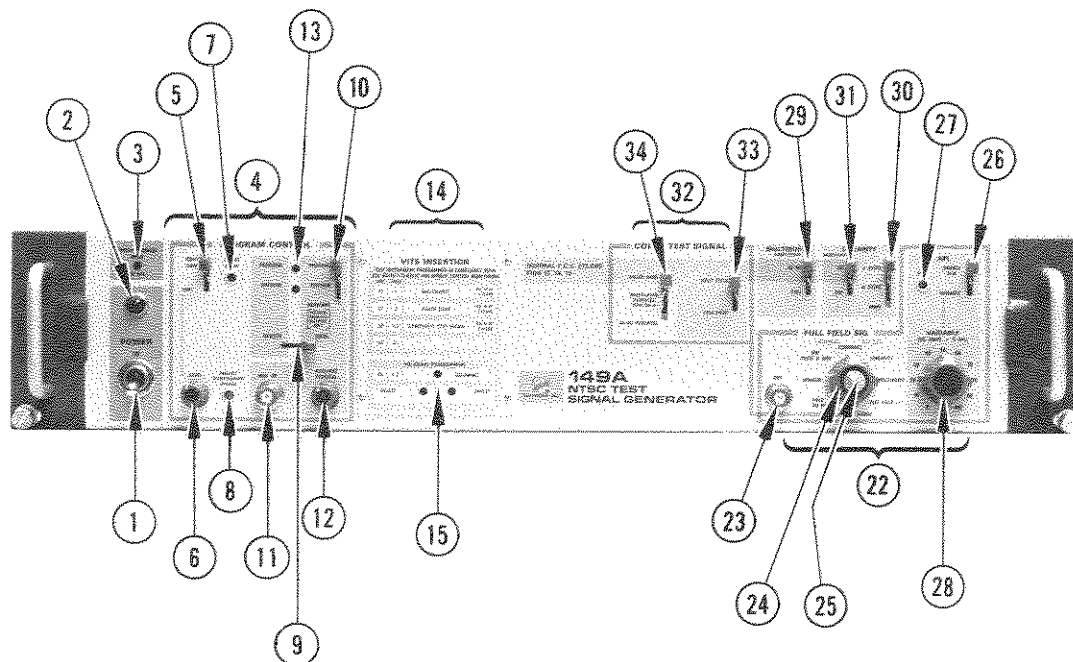

Fig. 1-7. 149A front-panel controls and connectors.

2029-39

Operating Instructions and Specifications—147A/149A

Rear-Panel

- | | | | |
|--|--|--|--|
| <p>35 Power Connector</p> <p>36 Voltage and Range SELECTOR</p> <p>37 REMOTE Connector</p> <p>38 SPARE Connectors</p> <p>39 EXT VITS IN</p> | <p>Twist-lock type of power connector with built-in RF filter.</p> <p>Allows programming the power supply input to accept a wide range of input voltages. Ranges are LO, M, and HI for either the 115 V or 230 V source.</p> <p>J9014. Allows remote control operation of some features of the 147A or 149A if desired. See Figs. 1-3 and 1-4.</p> <p>These connectors are included for use with any modifications the user may wish to add.</p> <p>The input connector for a signal with desired VITS when the VITS and FF logic board is programmed for EXT VITS. (External sync and burst must be turned off when the instrument is in the AUXILIARY mode.)</p> | <p>40 PROGRAM LINE IN</p> <p>41 COMPOSITE VIDEO (BLACK BURST)</p> <p>42 PROGRAM LINE OUT</p> <p>43 PROGRAM MONITOR OUT</p> | <p>The normal input for a program signal or composite video from an external source.</p> <p>A high-impedance loop-thru connection that is not usually connected. It can be switched into via the REMOTE connector. When switched in, the instrument will lock to the signal applied to this input, rather than the signal applied to the PROGRAM LINE IN.</p> <p>Program output signal with VITS controlled by the PROGRAM CONTROL switches. Connected to PROGRAM LINE IN through a relay in the BYPASS and POWER OFF conditions.</p> <p>This output has the same signals as the PROGRAM LINE OUT; except, in the BYPASS and AUXILIARY modes, there is no signal output.</p> |
|--|--|--|--|

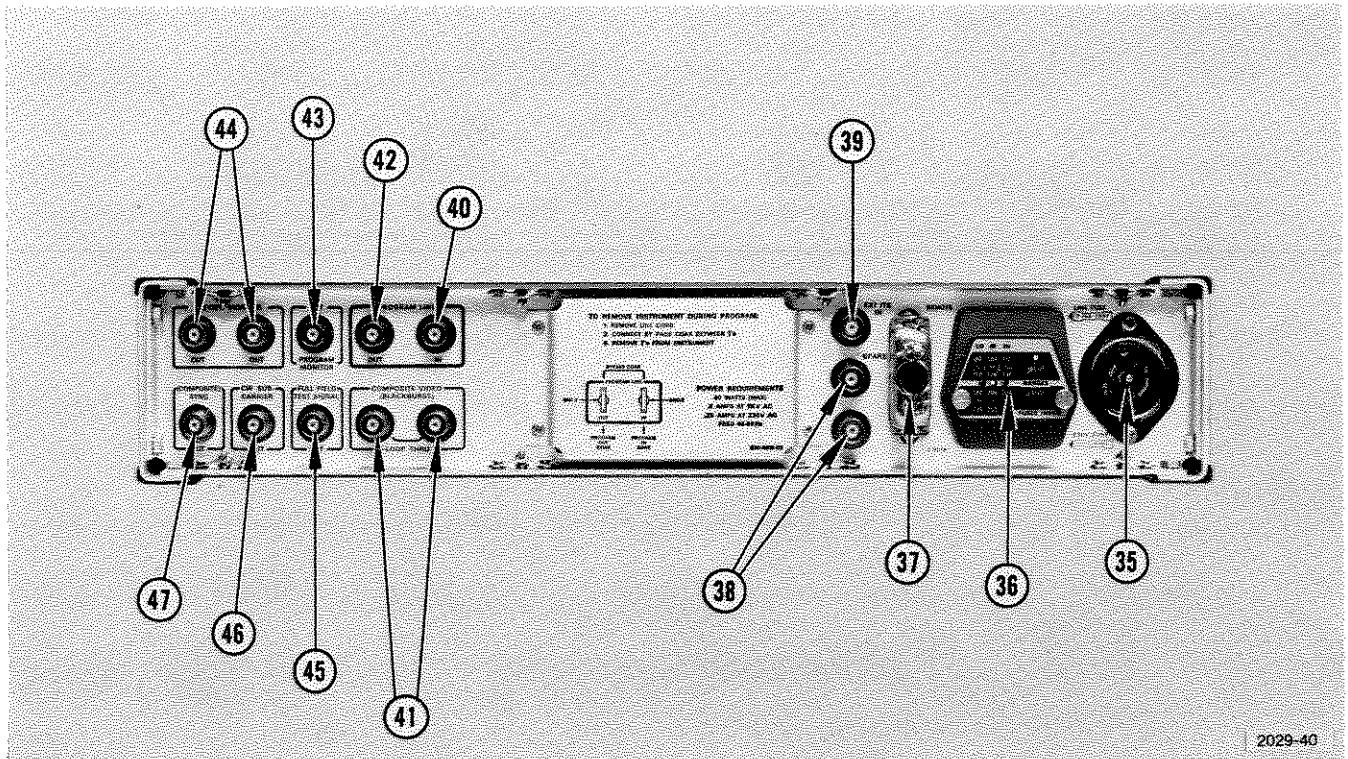

Fig. 1-8. 147A and 149A rear-panel controls and connectors.

- 44 PREVIEW MONITOR OUT This output always has VITS added, allowing VITS to be viewed before inserting into the program line. Also, full field noise measurements (147A only) and the AUXILIARY function are available at this output.
- 45 FULL FIELD TEST SIGNAL OUT The rear-panel output connector for the full field test signals.
- 46 CW SUB-CARRIER OUT Regenerated subcarrier signal, approximately 2 volts peak-to-peak into 75 Ω .
- 47 COMPOSITE SYNC OUT Regenerated sync signal, approximately 4 volts negative into 75 Ω .

all controls and connectors of the associated equipment will be initial upper-case letters only (e.g., waveform monitor A Input).

The procedure is arranged in a sequence that depends upon previous control settings and connections, and should be performed in sequence. There are, however, certain places where all equipment is disconnected, allowing an operator to start the procedure at this point if desired.

NOTE

The following procedure uses the equipment listed. If substitute equipment is used, control settings and/or connections may need to be altered.

FIRST-TIME OPERATION

General

The following is primarily intended to familiarize operating personnel with the operation of the 147A and 149A. It consists of a step-by-step procedure which makes use of each front- and rear-panel control and connector. This procedure will, in most cases, simulate the actual in-service operation of the instrument.

The procedure makes use of a waveform monitor to observe field and line rate displays and a vectorscope to observe phase characteristics. An external video source is needed to provide program material (composite video) and an external VIT signal. The following equipment is used: Tektronix 140 NTSC Test Signal Generator, used as an external video and VIT signal source; Tektronix 1480-Series Waveform Monitor, used to observe field and line rate displays; Tektronix 520A NTSC Vectorscope, used to observe phase characteristics. Proper operation of each unit is assumed; refer to the individual operating instructions for each.

The procedure requires the use of seven (7), 75 Ω BNC coaxial cables (Tektronix Part No. 012-0074-00), four (4), 75 Ω end-line terminations (Tektronix Part No. 011-0102-00), and one (1) 75 Ω feed-thru termination (Tektronix Part No. 011-0103-02, supplied as a standard accessory with 147A and 149A). A small blade screwdriver (Xcelite R3323 or equivalent) is also required.

Unless stated otherwise, all 147A and 149A front- and rear-panel controls and connectors referred to will be in upper-case letters (e.g., LINEARITY SUBCARRIER), and

Procedure

1. Remove the REMOTE plug, P9014, from the rear-panel REMOTE connector, J9014. (See INSTALLATION; Local-Remote Connector, in this section for details.)

2. Set the 147A or 149A front-panel controls as follows:

PROGRAM CONTROL

UNITY GAIN/VAR	UNITY GAIN
PROGRAM/PREVIEW/AUXILIARY	PROGRAM
LOCAL/REMOTE	LOCAL

NOISE AND PEDESTAL (147A only)

NOISE	DELETION
PEDESTAL	100 IRE
NOISE LEVEL dB	OFF, 0

COLOR TEST SIGNAL (149A only)

Selector	COLOR BARS
Field Timing	SPLIT FIELD

MULTIBURST AMPLITUDE NORMAL

LINEARITY

SUBCARRIER Mode	ON 5 STEP
-----------------	--------------

FULL FIELD SIG

Selector	LINEARITY
APL	BOUNCE 10-90
VARIABLE	0
Mode	NORM
POWER	OFF

Operating Instructions and Specifications—147A/149A

3. Check for correct positioning of the 147A or 149A rear-panel Range and Voltage Selector. (See INSTALLATION; Operating Voltage, in this section for details.) These must be in agreement for the power source to be used. Connect the 147A or 149A to the power source via the three-connector power cord supplied.

4. Set the POWER switch ON. Note that the green power-on indicator lamp is lit, to indicate that power is being supplied to the instrument; note that the red NONSYNCHRONOUS MODE — NO VITS lamp is lit, indicating lack of Gen-Lock.

NOTE

Without Gen-Lock, the 147A or 149A will not delete or insert VITS.

5. From the 147A or 149A FULL FIELD SIG OUT connector, connect a 75 Ω cable to the waveform monitor A Input connector. Terminate the loop-thru A Input with a 75 Ω end-line termination.

6. Observing the waveform monitor at a 2 Field display rate, note that comp sync is the only signal being generated.

7. Connect the REMOTE plug, P9014, to the rear-panel REMOTE connector, J9014.

8. Observing the waveform monitor, note that Full Field signals are being generated by the 147A or 149A. Observe the display at a 10 $\mu\text{s}/\text{div}$ display rate. The display should be the 5 Step LINEARITY test signal, similar to that shown on Fig. 1-9 of this manual.

NOTE

Without proper connection to the REMOTE connector, Full Field signals will not be generated.

9. Switch the 147A or 149A LINEARITY controls. The display will be either the 5 Step, 10 Step, or Ramp

LINEARITY signal (according to the LINEARITY switch), with or without modulation as determined by the setting of the SUBCARRIER switch. Return the LINEARITY switches to produce the 5 Step, with modulation, LINEARITY signal.

10. Set the FULL FIELD SIG Selector switch to FLAT FIELD. Observing the waveform monitor display for several seconds, notice that the display consists of sync and a square wave. The square wave should automatically bounce between 10 and 90 IRE. Using a small screwdriver, rotate the front-panel RATE control fully counterclockwise. Note that the time now required for the square wave to bounce between 10 and 90 IRE is slow (approximately 15 seconds). Turn the RATE control fully clockwise. The rate of bounce should have increased (approximately 1 second). Set the RATE control as desired.

11. Set the APL switch to VARIABLE. The display will consist of sync only. Observing the display, rotate the VARIABLE switch to 10, then 20. Notice that the square wave increases in amplitude as the VARIABLE is increased. This control allows the operator to select any APL level desired in 10 IRE increments between 0 and 100 IRE. Notice the (50) position of this switch between 0 and 100. As a convenience to the operator, this position allows standard 10-50-90 APL measurements to be made without completely rotating the switch 360°. Observe the display at a 2 Field display rate. The FLAT FIELD signal should occupy all active video lines. Set the waveform monitor for a 10 $\mu\text{s}/\text{div}$ display rate; set the 147A or 149A VARIABLE switch to 50 IRE.

12. Set the 147A or 149A FULL FIELD SIG selector switch to FIELD SQ WAVE. Notice that the display is similar to the FLAT FIELD signal, except the square wave is at 100 IRE at all times. Observe the display at a 2 Field display rate. Notice that the square wave does not occupy all active video lines. Only lines 57 through 227 of each field are used. Set the waveform monitor for a 10 $\mu\text{s}/\text{div}$ display.

13. Set the 147A or 149A FULL FIELD SIG selector switch to WINDOW. This signal will be similar to that shown in Fig. 1-9 of this manual. It consists of 2T pulse,

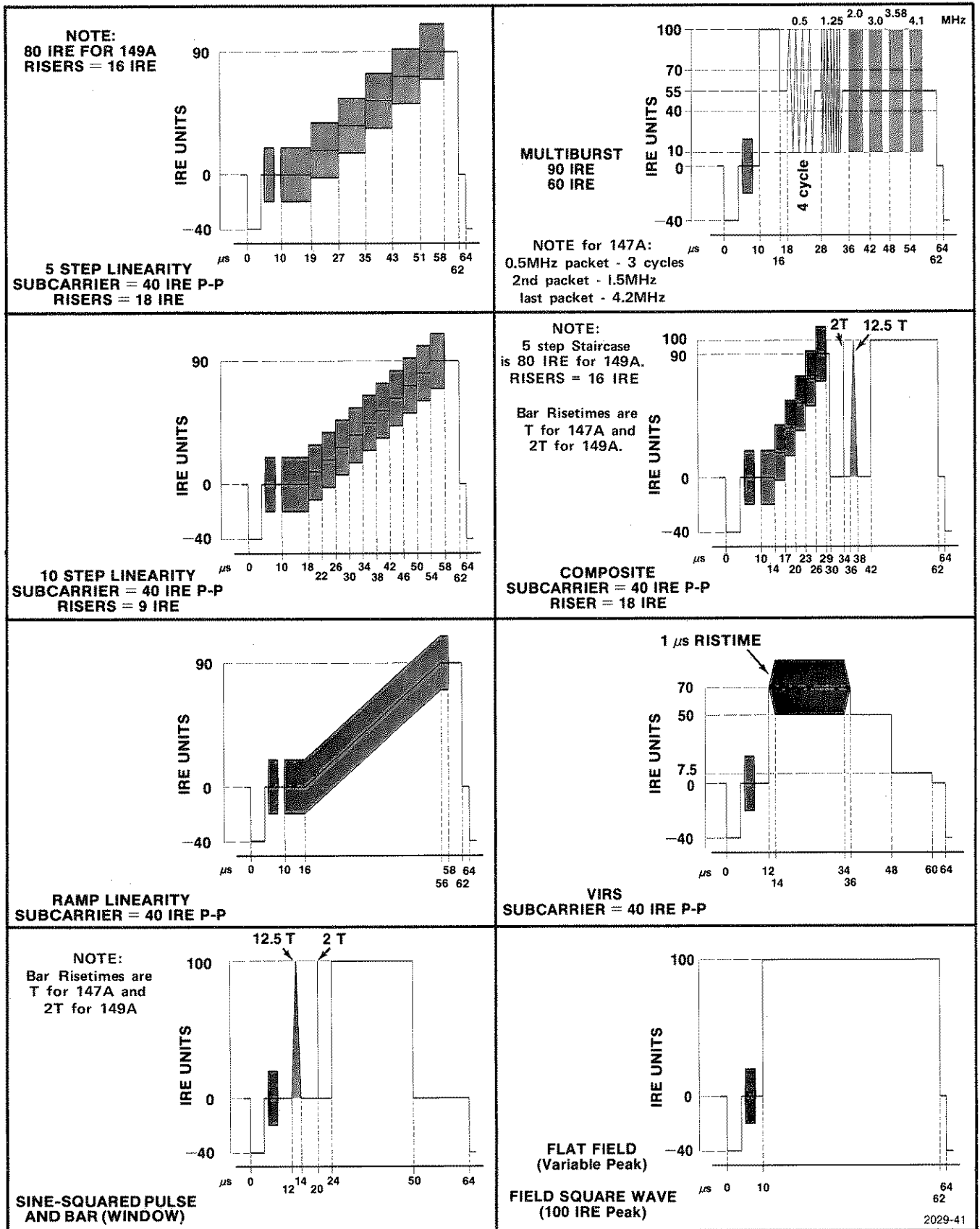

Fig. 1-9. Test signal output timing details.

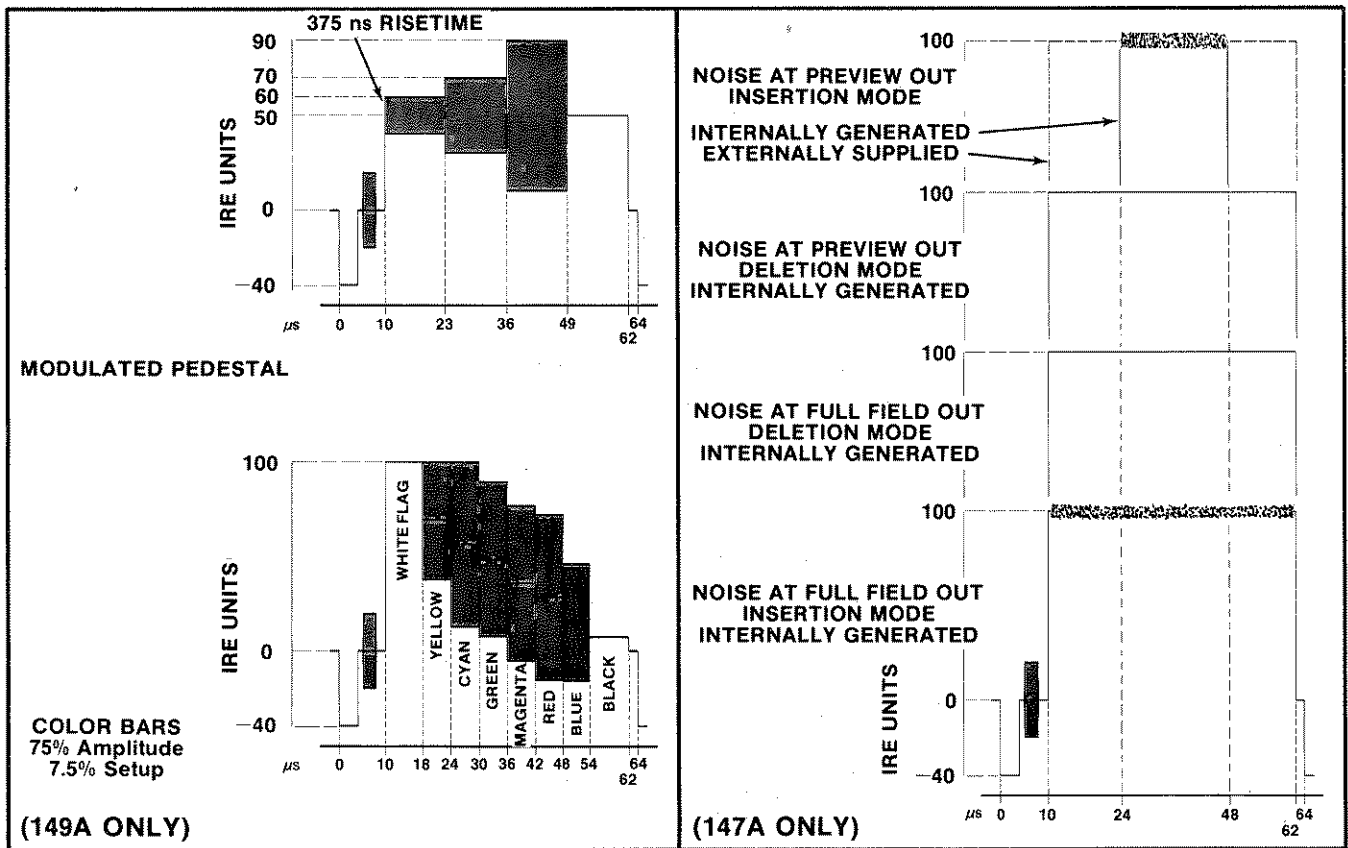

Fig. 1-9. (Cont.) Test signal output timing details.

modulated 12.5T pulses, and a Bar. Observe the display at a 2 Field display rate. Notice the 2T and modulated 12.5T pulses occur each active line of both fields, but the Bar occurs only part of the time. The Bar portion of this signal occupies lines 66 through 218 of each field. Set the waveform monitor for a 10 μ s/div display.

14. Set the 147A or 149A FULL FIELD SIG selector switch to SIN² PULSE AND BAR. This signal should be similar to the WINDOW signal observed in step 13. Observe the display at a 2 Field display rate. Notice that the Bar occupies all active video lines. This is the only difference between SIN² PULSE AND BAR and the WINDOW signal. Set the waveform monitor for a 10 μ s/div display.

15. Set the 147A or 149A FULL FIELD SIG selector switch to COMPOSITE. The display should be similar to

that shown in Fig. 1-9 of this manual. It consists of the 5 Step Staircase (LINEARITY) and the SIN² PULSE AND BAR signal. Only the line timing has been changed on these signals. Switch the LINEARITY controls. Notice the 5 Step Staircase cannot be changed, but the modulation on the steps corresponds to the setting of the SUB-CARRIER switch. Return the LINEARITY switches to 5 STEPS and SUBCARRIER ON.

16. Set the 147A or 149A FULL FIELD SIG selector switch to MULTIBURST. This signal should be similar to that shown in Fig. 1-9 of this manual. The signal occupies all active video lines of both fields. Set the MULTIBURST AMPLITUDE switch to REDUCED. Notice the reduced peak-to-peak amplitude of each burst packet and the level about which the burst packets are centered. The white level should remain at 100 IRE. Return the MULTIBURST AMPLITUDE switch to NORMAL.

17. (149A only.) Set the FULL FIELD SIG selector switch to COLOR TEST SIGNAL. This signal is controlled by the COLOR TEST SIGNAL switches. Set the waveform monitor for a 2 Field display rate. The first and last portions of the field do not contain chrominance information. Turn the COLOR TEST SIGNAL Field Timing switch to FULL FIELD. The signal will have chrominance on during the entire field. Set the waveform monitor to 10 μ s/div display rate. The COLOR BARS signal will be displayed. Return the Field Timing switch to SPLIT FIELD. The luminance portion of the COLOR BARS signal can be seen overlaying the chrominance portion. Set the COLOR TEST SIGNAL selector switch to MODULATED PEDESTAL. The signal consists of a 50 IRE luminance pedestal with chrominance modulation levels of 20, 40, and 80 IRE. Set the COLOR TEST SIGNAL selector to 50 IRE PEDESTAL. The chrominance modulation is removed from the 50 IRE pedestal. Return the COLOR TEST SIGNAL selector to COLOR BARS.

18. Set the 147A or 149A FULL FIELD SIG selector switch to LINEARITY, and the mode switch to ALT. The LINEARITY signal will appear overlayed by the 50% APL signal. Set the waveform monitor for a 2 Field display, and Mag to X50. The signal consists of one line of LINEARITY, followed by four lines of the 50% APL signal. Note that the FLAT FIELD controls affect the four-line portion of the signal, and the FULL FIELD SIG selector controls the one-line portion of the signal. Return the mode switch to NORMAL.

19. (147A only.) Set the FULL FIELD SIG selector switch to NOISE. This signal is controlled by the NOISE AND PEDESTAL switches and controls. Set the PEDESTAL (IRE) switch to 50, then 10, and back to 100. Note that the pedestal amplitude corresponds to the setting of this switch. (In the DELETION mode, this is the only switch affecting the signal.) Set the NOISE switch to INSERTION. The display should be similar to that obtained in the DELETION mode. Rotate the VAR control. Note that the pedestal level can be changed approximately ± 10 IRE about the level determined by the setting of the PEDESTAL switch. Set the NOISE LEVEL dB OFF/−20 switch to −20. Notice that noise has been added on the pedestal. Rotate the NOISE LEVEL dB 9/0 switch. There should be a decrease in noise level. These two dB switches provide noise attenuation from −20 dB to −59 dB in 1 dB steps. (700 mV RMS = 0 dB.) Set the dB switches to −20 and 0. Rotate the VAR control to center the NOISE about the 100 IRE level.

NOTE

In steps 8 through 19, each FULL FIELD SIG OUT has been demonstrated. These same signals are also available at the rear-panel FULL FIELD TEST SIGNAL OUTPUT.

20. (147A only.) Disconnect the 75 Ω cable from the OUT connector and reconnect it to the NOISE OUT connector. Observing the waveform monitor display, switch the NOISE and PEDESTAL switches. Note that the signal is controlled only by the NOISE LEVEL dB switches and that the signal is continuous (e.g., no line or field sync).

NOTE

In actual use, an in-line 4.2 MHz low-pass filter must be used with the NOISE OUT signal.

21. Disconnect the 75 Ω cable from the NOISE OUT (if 147A) connector or from the OUT connector (if 149A) and reconnect it to the rear-panel COMPOSITE SYNC connector. There should be no display, as the 147A or 149A must be Gen-Locked to provide composite sync to this connector.

22. Disconnect the 75 Ω cable from the rear-panel COMPOSITE SYNC connector and reconnect it to the CW SUBCARRIER OUT connector. Disconnect the 75 Ω cable from the waveform monitor A Input and connect it to the Vectorscope CH A Input connector; terminate the other CH A loop-thru connector with a 75 Ω end-line termination. There should be no vector display, as the 147A or 149A must be Gen-Locked to provide CW to this connector.

23. Disconnect all connections.

Operating Instructions and Specifications—147A/149A

NOTE

In the steps to follow, this procedure will, where possible, simulate the actual in-service operation of the 147A or 149A.

24. Using 75 Ω cables and 75 Ω end-line terminations, make the following connections:

a. 147A or 149A PROGRAM LINE OUT to waveform monitor A Input; waveform monitor A Input loop-thru to Vectorscope CH A connector; terminate Vectorscope CH A loop-thru connector into 75 Ω .

b. 147A or 149A PREVIEW MONITOR OUT to waveform monitor B Input; waveform monitor B Input loop-thru to Vectorscope CH B connector; terminate Vectorscope CH B loop-thru connector into 75 Ω .

c. 140 NTSC Test Signal Generator (external video source) Subcarrier to Vectorscope Ext CW \emptyset Ref connector; terminate Vectorscope Ext CW \emptyset Ref loop-thru into 75 Ω .

d. 140 (external video source) Comp Sync to waveform monitor Ext Neg Sync Input; waveform monitor Ext Neg Sync Input loop-thru to Vectorscope Ext Sync J120 connector; terminate Vectorscope Ext Sync J121 connector into 75 Ω .

e. 140 (external video source) Comp Video to 147A or 149A PROGRAM LINE IN connector.

25. Set the 147A or 149A controls and switches as given in step 2, except set the POWER switch ON and the PROGRAM CONTROL PROGRAM/PREVIEW/AUXILIARY switch to PREVIEW. Set the Vectorscope to view the CH A Input in a vector mode, using external sync and \emptyset Reference. Set the waveform monitor to view the A Input at a 10 $\mu\text{s}/\text{div}$ display rate, using external sync with line 19 of field one (1) selected. Set the external video source (140) to provide Full Field color bars with a color bar VIT signal on line 19.

26. Observe the 147A or 149A front-panel. The NON-SYNCHRONOUS MODE/NO VITS lamp should be extinguished. This indicates that the 147A or 149A has been Gen-Locked with the external video, and is capable of deleting and inserting internally-generated VITS.

27. Notice that the 147A or 149A front-panel PREVIEW lamp is lit to indicate status (lamp extinguished indicates relay not energized). In this mode of operation, program video to the PROGRAM LINE IN is being passed to the PROGRAM LINE OUT without interruption as indicated by the waveform monitor and Vectorscope displays. Observe the waveform monitor at 10 $\mu\text{s}/\text{div}$ display rate

with the Dig (digital) button pushed, and line 20 selected. The external color bar VIT signal should be on line 19 of field one (1).

28. Observe the waveform monitor B Input (PREVIEW MONITOR). VITS should be present on line 19 of field one (1). This signal is similar to that shown in Fig. 1-9 of this manual. Also, note that the 147A or 149A front-panel VITS INCOMING lamp is extinguished and (2) the VITS INSERT and VITS DELETE lamps are lit. This indicates (1) the external video source does not contain a VITS, and (2) if the external video source contains a VIT signal on the line programmed for VITS, it will be deleted and replaced by the internally-generated VITS.

NOTE

The signal appearing at the PREVIEW MONITOR OUTPUT allows operating personnel to observe the actual signal after insertion without actually going to an 'on the air' mode of operation.

29. Using the waveform monitor digital line selector, check that all VIT signals, as factory programmed, are being inserted on the proper line and field, according to Tables 1-2 or 1-3.

TABLE 1-2

147A FACTOR VITS PROGRAMMING

LINE	FIELD	SIGNAL
17	1	MULTIBURST
17	2	NOISE ³
18	1	COMPOSITE
18	2	LINEARITY
19	1 & 2	VITS

³NOISE will be displayed in the center half of line 17 only, and will be dealt with later in the procedure.

TABLE 1-3

149A FACTORY VITS PROGRAMMING

LINE	FIELD	SIGNAL
17	1	MULTIBURST
17	2	COLOR TEST SIGNAL
18	1 & 2	LINEARITY
19	1 & 2	VITS

30. Set the 147A or 149A PROGRAM CONTROL PROGRAM/PREVIEW/AUXILIARY switch to PROGRAM. Observing the waveform monitor A Input (PROGRAM

LINE OUT), notice that the internally-generated VIT signals have been applied to the 'on the air' signal. Note that the 147A or 149A front-panel PROGRAM CONTROL PROGRAM lamp is lit to indicate status.

31. Set the waveform monitor to view line 19 of field 1. Observing the display, set the 147A or 149A POWER switch to OFF. Notice that the color bar VIT signal has returned. This indicates that external video has bypassed the 147A or 149A, and demonstrates the fail-safe characteristic of the instrument should loss of power, sync, etc., occur during an 'on the air' (PROGRAM) situation. Return the 147A or 149A POWER switch to ON.

32. (147A only). Set the waveform monitor to observe line 17 of field two (2), using the A Input (PROGRAM MONITOR). Set the external video source to provide a 50% APL VIT signal on line 17 of field two (2). (If using the Tektronix 140, set the Mod Staircase 0° Subcarrier and Steps switches down and the APL switch to 50; this will produce the 50% APL signal). Set the 147A controls as follows: PROGRAM CONTROL PROGRAM/ PREVIEW/AUXILIARY to PREVIEW; NOISE to INSERTION; PEDESTAL to 100; NOISE LEVEL dB to -20 and 0; FULL FIELD SIG selector to NOISE. The display should be similar to that shown in Fig. 1-10A. Next, set the waveform monitor to view the B Input (PREVIEW MONITOR). The display should appear similar to that shown in Fig. 1-10B. Change the NOISE and PEDESTAL switches and control; their effect should be as demonstrated using the Full Field signal. This signal allows 'on the air' noise measurements to be made during the vertical interval, by deleting the center portion of the external VIT signal and inserting internal noise which is of known amplitude for comparison purposes.

33. (147A only). Set the waveform monitor for a 10 μ s/div display rate with the Line Selector Off. Notice that each active video line contains the external video signal with interruptions for noise. Set the 147A FULL FIELD SIG selector switch to any position other than NOISE. Each active line should contain only the external video. Return the FULL FIELD SIG selector switch to NOISE.

NOTE

The signal appearing at the PREVIEW MONITOR OUTPUT is available in the PREVIEW mode only.

34. (147A only). Set the 147A PROGRAM CONTROL PROGRAM/PREVIEW/AUXILIARY switch to PROGRAM, and the waveform monitor to display the A Input (PROGRAM LINE OUT). The display should contain only the external video. Push the Dig button. Again, the display should appear similar to that shown in Fig. 1-10B.

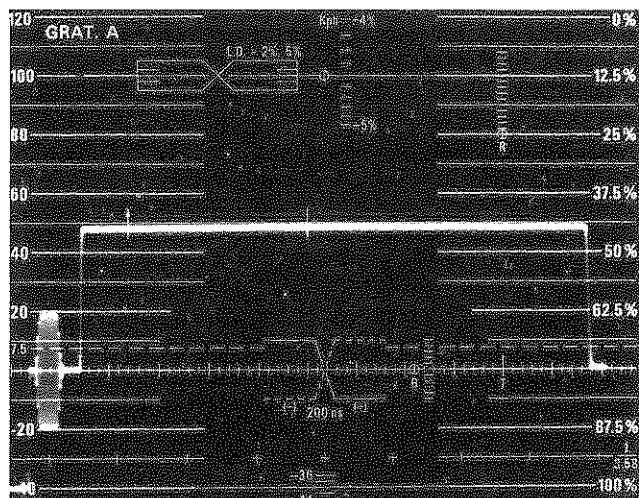

(A) VITS Bar before noise insertion.

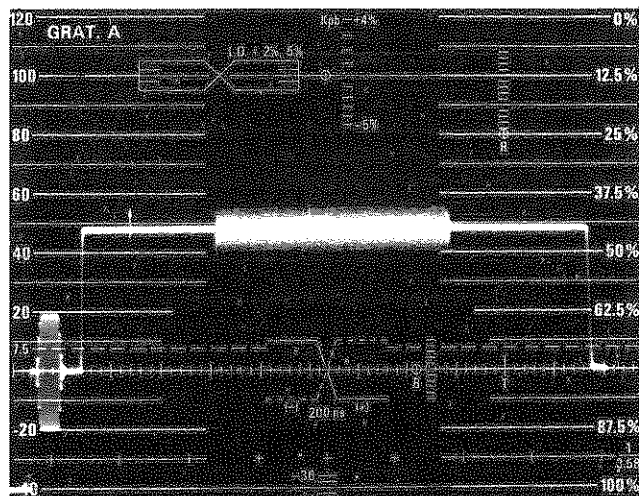

(B) VITS Bar with inserted noise measurement signal.

Fig. 1-10. Typical waveform monitor displays of (A) 50 IRE VIT Signal without noise, and (B) 50 IRE VIT Signal with noise measurement signal inserted.

35. Observing the waveform monitor A Input at a 2 Field display rate and the Vectorscope CH A Input vectors (both are PROGRAM LINE OUTPUTS), set the 147A or 149A PROGRAM CONTROL UNITY GAIN/VAR switch to VAR and rotate the LEVEL control. The amplitude of the external video can now be varied with the LEVEL control. Observe the waveform monitor display of the vertical interval with X25 magnification. Rotation of the LEVEL control should not affect internally-generated VITS. Turn off the waveform monitor magnification and adjust the LEVEL control for a signal amplitude of 140 IRE peak-to-peak. (The LEVEL control allows the operator to match incoming program material to the internally-generated signals). Return the PROGRAM CONTROL to UNITY GAIN.

Operating Instructions and Specifications—147A/149A

36. Observing the Vectorscope display, use a small screwdriver and rotate the 147A or 149A PROGRAM CONTROL INSERT SUBCARRIER PHASE control. There should be a vector representing internally-generated subcarrier which is controlled by rotation of this control. Superimpose this vector on the vector representing external subcarrier. The INSERT SUBCARRIER PHASE control enables the operator to match the phase of the internally-generated subcarrier to the phase of the external subcarrier.

37. Connect the unused Comp Video output from the 140 to the EXT VITS IN connector. Set the 147A or 149A PROGRAM CONTROL PROGRAM/PREVIEW/AUXILIARY switch to AUXILIARY and view the waveform monitor B Input (PREVIEW MONITOR) at a 10 μ s/div display rate. Sync and burst will be double amplitude. As explained under Controls and Connectors, when in AUXILIARY mode of operation with an external VITS applied to the EXT VITS IN connector, there must be no sync or burst added with the external VIT signal. Disconnect the 75 Ω cable from the EXT VITS IN connector. Sync and burst should now be normal amplitude.

38. Observing the waveform monitor display, rotate the 147A or 149A PROGRAM CONTROL AUXILIARY PEDESTAL control. The peak amplitude of the displayed square wave (pedestal) can now be varied between 0 and 100 IRE. Disconnect the 75 Ω cable from the rear-panel PREVIEW MONITOR OUTPUT and reconnect it to the PROGRAM MONITOR OUTPUT connector. There is no signal from the PROGRAM MONITOR OUTPUT in this mode. Observing the waveform monitor A Input (PROGRAM LINE OUT), notice that external color bars are displayed and rotation of the AUXILIARY PEDESTAL control has no effect. The Auxiliary signal will be only applied to the PREVIEW MONITOR OUTPUT with the PROGRAM LINE IN bypassed through the relay to the PROGRAM LINE OUTPUT. This is the only mode where the PROGRAM MONITOR OUTPUT does not contain the same signal as the PROGRAM LINE OUTPUT. Set the waveform monitor to view the B Input, and reconnect the PREVIEW MONITOR OUTPUT.

39. Apply a color bar signal via a 75 Ω cable to the 147A or 149A AUX IN connector. (If using the Tektronix 140, use the same signal applied to the EXT VITS IN from the Comp Video output). The external applied color bar has been added on the pedestal level of the auxiliary signal. Rotate the AUXILIARY PEDESTAL control. The pedestal on which the external color bar is riding can again be changed between 0 and 100 IRE with rotation of this control. This input, although demonstrated using a color bar, can be driven by any signal desired for a specific application, such as a sweep generator output, etc.

40. Set the 147A or 149A PROGRAM CONTROL REMOTE/LOCAL switch to REMOTE. Note that the PROGRAM CONTROL PREVIEW lamp is lit to indicate status. Observe the waveform monitor, first at a 10 μ s/div display rate, then a 2 Field display rate. The display should contain the external video signal with VITS inserted. Switch the PROGRAM CONTROL PROGRAM/PREVIEW/AUXILIARY switch to any position. There should be no change to the displayed output.

NOTE

With the PROGRAM CONTROL REMOTE/LOCAL switch set to REMOTE, control is via the rear-panel REMOTE connector. As factory-connected, the 147A or 149A operates in PREVIEW.

41. Set the 147A or 149A switches and controls as given in step 2 of this procedure, except set the POWER switch ON, and the PROGRAM CONTROL PROGRAM/PREVIEW/AUXILIARY switch to PROGRAM. Ground pin 9 of J9014 to enable the BLACK BURST input. Observing the waveform monitor B Input at a 2 Field display rate, notice that only the external video is being passed by the 147A or 149A. Also, note that the front-panel NONSYNCHRONOUS MODE — NO VITS lamp is lit, indicating lack of Gen-Lock. Under this condition, the 147A or 149A will not insert or delete.

42. Disconnect the external color bar signal from the 147A or 149A AUX IN connector and reconnect it to the rear-panel BLACK BURST input connector; terminate the other BLACK BURST input loop-thru connector into 75 Ω . Set the external sync source to obtain 'Black Burst'. (If using the Tektronix 140, set the Video switch to Off.) The 147A or 149A NONSYNCHRONOUS MODE — NO VITS lamp should be extinguished, and the waveform monitor should be displaying the inserted VITS.

43. Push the waveform monitor Dig Line Selector button and set the monitor to view line 19 of field one (1) of the A Input at a 10 μ s/div display rate. The VIRS will be displayed. Using a small blade screwdriver, rotate the 147A or 149A INSERT DELAY control. The position on the line of the VIR signal can be changed, thus allowing the operator to control time-positioning of internally-generated VITS with respect to the incoming signal.

NOTE

The following demonstrates if the 147A or 149A will accept and display an external VIRS. It is not intended that the operator use the instrument in the manner described.

44. Connect a 75 Ω cable between the rear-panel FULL FIELD TEST SIGNAL output connector and the rear-panel PROGRAM LINE IN connector.

45. Notice the 147A or 149A front-panel VIRS IN-COMING, VIRS DELETE, and VIRS INSERT lamps; each should be flickering. This merely indicates that the VIRS IN-COMING circuits are working properly. If an external VIRS were used, these lights would stay on to indicate VIRS status. (Refer to Operating Options in this section for additional details.)

46. This completes the first-time operation. Disconnect all connections.

GENERAL INFORMATION

Test Signals

The 147A and 149A generate the following test signals:

MULTIBURST. The MULTIBURST signal consists of a white flag (100 IRE) and six packets of sine wave bursts, each at a discrete frequency. This allows an approximation of the frequency response of a system driven by this signal. When measuring frequency response using the MULTIBURST signal, measure the peak-to-peak amplitudes of the individual packets, near their center if possible (see Fig. 1-11). Avoid using the outline of the packets as a frequency response curve, because the center level of the packets might be shifted vertically by distortions in the system being measured.

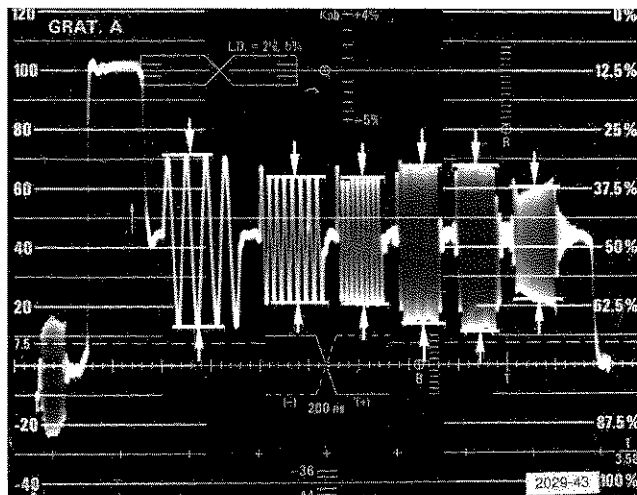

Fig. 1-11. Using the MULTIBURST signal to measure frequency response. Measure peak-to-peak amplitudes at the center of each packet as shown.

LINEARITY. The LINEARITY test signals consist of the 5 STEPS, 10 STEPS, and RAMP. These signals are useful in measuring nonlinear distortions such as differential gain, differential phase, and line-time nonlinearity.

Differential-Gain. Differential gain is basically the change in the chrominance signal amplitude as the amplitude of the luminance signal changes between black and white. A picture affected by differential gain shows a change in the saturation of the colors.

The method of measuring differential gain, as recommended by IEEE Method (C), is to measure the difference between the two extremes of the largest amplitude and the smallest amplitude, using the largest amplitude as a reference. The formula for this method is

$$100 \left(1 - \frac{a}{b} \right) \%$$

where (b) is the largest chrominance amplitude, and (a) is the smallest.

To perform the measurement, the luminance signal should be filtered out with a 3.58 MHz bandpass filter which has a bandwidth wide enough to show all of the chrominance packet without appreciable rolloff, say between 500 kHz and 2 MHz. Most waveform monitors have built-in bandpass filters which can be switched in from the front-panel. See Fig. 1-12 for an example of differential gain measured on a waveform monitor or oscilloscope.

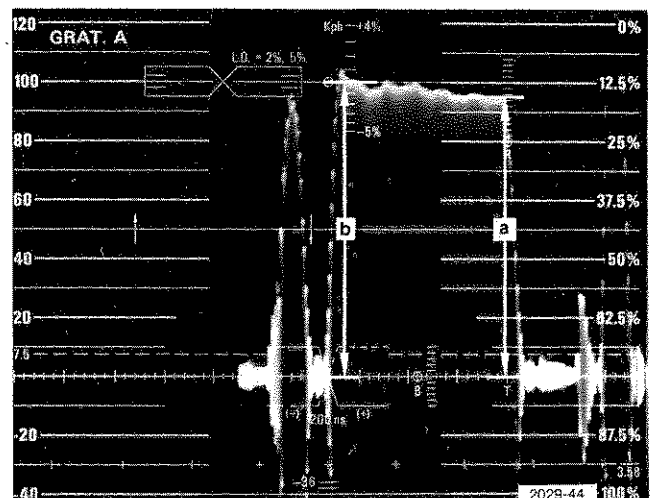

Fig. 1-12. Differential Gain as measured on a waveform monitor, using the COMPOSITE test signal.

Operating Instructions and Specifications—147A/149A

The Tektronix 520A Vectorscope has differential phase and gain measurement capabilities. When set up properly, differential gain can be read directly from the graticule of the 520A. To set up the 520A, couple the signal to be measured (LINEARITY test signal) into Channel A, and terminate the loop-through connector in 75 Ω . Push the Ch A, Full Field, A ϕ , and Vector buttons. Set the Channel A switch to Max Gain, and adjust the variable Gain control to place the largest LINEARITY signal vector dot to the outer circle on the Vector graticule. Next, push the Diff Gain button and vertically position the peak of the trace to the 0% Diff Gain graticule line. Read the maximum amount of differential gain on the graticule line corresponding to the smallest portion of the signal or a dip in the trace.

Differential Phase. Differential phase is the change in phase of the chrominance signal as the luminance signal amplitude changes between black and white. This will show up on a picture as a change in the hues of the colors.

The 520A Vectorscope has built-in differential phase measurement capabilities. These include a fairly accurate graticule scale readout, which is quick and easy to use. For more accurate measurements, the 520A has a Calibrated Phase dial. Refer to the 520A Instruction Manual for measurement information.

Line-Time Nonlinearity. Line-time nonlinearity is a difference in gain from the black level to the white level of a video signal. Monochrome signals and the luminance portion of color signals are affected by this distortion.

The 5 STEPS or 10 STEPS staircase signals are usually used to measure the amount of line-time nonlinearity. The output of the circuit being measured is differentiated and fed to an oscilloscope or waveform monitor. An external differentiating network may be used, such as the Tektronix Video Staircase Differentiator, p.n. 015-0154-00. The Tektronix 1480 Waveform Monitor has a Differentiated Step position on the Response switch and doesn't need an external network.

Fig. 1-13 shows the waveforms used in this measurement. The largest spike is the reference amplitude, (b). Adjust the oscilloscope or waveform monitor variable amplitude control for a convenient amplitude of (b), normally 100 IRE units on a waveform monitor graticule. Next, measure the relative amplitude difference of the spike with the greatest amplitude difference from (b). This amplitude will be called (a). Calculate the amount of nonlinearity using the formula:

$$D_{NL} = 100 \left(1 - \frac{a}{b} \right) \%$$

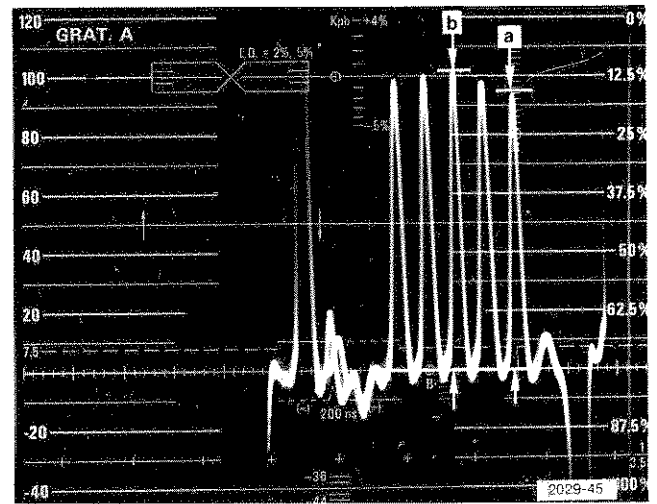

Fig. 1-13. Line Time Nonlinearity as measured on a waveform monitor, using the COMPOSITE test signal.

SIN² PULSE & BAR. The components of this signal are the 12.5T Modulated Pulse, the 2T Pulse, and the T Bar. The signal is used to perform a variety of linear distortion measurements. Some of the parameters measured on this signal, and the distortions which can cause a change in these parameters are as follows:

- Pulse-to-Bar Ratio — Bandwidth distortion
- Pulse ringing — Frequency response
- Pulse Rise- and Fall-times — Quadrature distortion
- Bar Tilt — Line-time distortion
- Modulated Pulse baseline — Chrominance/Luminance delay
- Modulated Pulse amplitude — Chrominance/Luminance gain

WINDOW. The WINDOW signal is similar to the SIN² PULSE & BAR signal except that the Bar portion of the signal only occurs during the center part of the field, lines 66 through 217. This allows the signal to be used for field time measurements and short time measurements.

FIELD SQUARE WAVE. The FIELD SQUARE WAVE test signal is used to evaluate field time distortions. The signal consists of a 100 IRE bar occurring on lines 57 through 227 of each field, approximating a 60 Hz square wave. Composite sync and blanking allow this square wave to pass through clamping circuits in the equipment under test.

FLAT FIELD. During the active portion of each field, this signal has a luminance level which is variable from 0 to 100 IRE in 10 IRE increments, or which bounces automatically between 10 and 90 IRE at a repetition rate

variable from about 1 to 10 seconds. It is used to test clamper amplifiers, and systems in general, for APL dependent distortions.

NOISE (147A only). Noise encountered in a television system is usually of the type called "White Noise" or "Flat Noise", which contains equal amounts of energy over a wide frequency spectrum. This noise mixes with the television signal, producing unwanted distortion.

Accurate measurement of noise is important to determine the amount of noise added by each stage of the television system. The 147A measures noise by deleting a portion of the incoming signal and inserting a known amount of noise from the internal noise generator. The amount of noise inserted is controlled by the NOISE LEVEL dB switches. When the inserted noise matches the incoming noise, the amount can be read directly from the NOISE LEVEL dB switch settings. This method is accurate within 2 dB.

In the DELETION mode, the 147A deletes the entire active portion of the line and inserts a pedestal which is free of noise. This pedestal establishes a zero noise reference at that point in the video chain. Another 147A inserted in the video chain at a later point, used in the INSERTION mode can determine the amount of noise generated between the two points.

To measure noise amplitude during the active field; connect the PREVIEW MONITOR OUT to a waveform monitor, set the PROGRAM CONTROL switch to PREVIEW, the FULL FIELD SIG Selector to NOISE, and the NOISE switch to INSERTION (HALF LINE). The center half of the signal on each active line will be deleted, and the internally generated noise will be inserted. Adjust the NOISE LEVEL dB switches until the internally generated noise amplitude matches the signal noise amplitude. Then, just read the total of the two NOISE LEVEL dB switches to see how much noise was inserted. This is the amount of "white noise" or "flat noise" present on the incoming signal.

To measure noise amplitude during the vertical interval, either the PROGRAM LINE OUT or the PREVIEW MONITOR OUT may be used. Perform the measurement as described above for measuring on the full field, except set the waveform monitor to display the VITS line for which the NOISE signal is programmed. Measuring during the vertical interval has the advantage of avoiding a change in the RMS level caused by the active video signal. It also allows measuring noise on an in-service basis, when a full field noise pedestal may not be available.

COLOR BARS (149A only). The 149A generates Color Bars with 75% Amplitude, 100% Saturation, and 7.5% Setup level. These color bars are in compliance with the FCC Rules and Regulations 73.676 (f) for Remote Control Monitoring. The COLOR BARS signal is generally used for checking luminance, hue, and saturation levels. It represents a scene with high brightness and saturation.

SPLIT FIELD COLOR BARS are available as a full field signal. This signal consists of the luminance portion of the COLOR BARS signal on each active line of each field, and the chrominance portion of the COLOR BARS signal only on lines 66 through 218 of each field.

MODULATED PEDESTAL (149A only). This signal consists of three chrominance levels (20, 40, and 80 IRE) superimposed on a 50 IRE pedestal, followed by a 50 IRE pedestal with no modulation. Phase of the chrominance is -90° from burst. Chrominance/luminance cross-modulation can be measured using this signal when demodulated.

COMPOSITE. This signal is composed of the LINEARITY 5 STEP staircase and the SIN^2 PULSE & BAR signals. The horizontal timing has been changed to allow all of the components to be placed on one line. This allows measurement of many linear and nonlinear distortions on only one VITS line if desired.

VIRS. The Vertical Interval Reference Signal (VIRS) consists of a 7.5 IRE pedestal, a 50 IRE pedestal, and a 70 IRE pedestal with 40 IRE of chrominance modulation phased at $+180^\circ$ from the B-Y axis. The 70 IRE luminance level with modulation approximates the average program chrominance at typical skin tone luminance. The 50 IRE luminance pedestal represents average scene brightness, and corresponds to the bottom of the chrominance reference, allowing easy comparison to the two levels. The 7.5 IRE luminance pedestal provides a reference for setup.

VERTICAL INTERVAL INSERTION/DELETION. When the digital programmer is Gen-Locked to a program signal, it may delete and re-insert local VITS as determined by the programming.

As the VITS Deleter/Insertor function involves active circuit elements in the programming within the 147A or 149A, fail-safe means are provided in the event of a malfunction within the instrument, such as loss of sync, power, etc.

A PREVIEW function allows the observation of exactly what lines will be deleted and exactly what signals and levels will be inserted on the program line signal before they are inserted on the program signal itself.

Operating Instructions and Specifications—147A/149A

Changes in the programming of the several VIT signals are readily done by removing or moving coded jumpers within the 147A or 149A. Any signal may be eliminated or moved.

OPERATING CHANGES

General Information

The 147A and 149A are factory-connected to produce the output signals which are most frequently used by the television industry. However, the 147A and 149A are versatile, in that many internal changes can be made which alter these signals to meet certain applications. For example, the COMPOSITE signal (both Full Field and VITS) as shipped from the factory generates and displays the 5 Step Staircase as a portion of the total signal. This may be internally changed to provide the Ramp signal (in place of the staircase) on the COMPOSITE signal.

NOTE

Some of the changes or modifications that follow require internal adjustment to comply with industry standards. We recommend that only qualified personnel, thoroughly familiar with calibration procedures and video signals, make these changes.

The following provides the information necessary to change or modify the instrument, where possible.

VITS Line and Field Selection

VITS may be selected to appear on lines 10 through 21 of field one, field two, or both fields. Line and Field Selection is accomplished by selecting various internal quick-change pin connectors on the VITS and FF circuit board. An access door is provided so that VITS selection can be made without removing the top cover from the instrument.

Referring to Fig. 1-14, notice that a rectangular matrix is used to select the line and field for each VIT signal. Two jumper plugs must be used to select the VITS; one for field selection, the other for line selection. To prevent or disable a particular VITS, move the line jumper plug to the OFF position.

Each jumper plug has been assigned a particular color, which are brown, red, orange, yellow, green, and blue respectively. This coding simplifies identifying the various VIT signals, and any same-color jumper plug (except black) on the VITS and FF circuit board will affect only that particular signal.

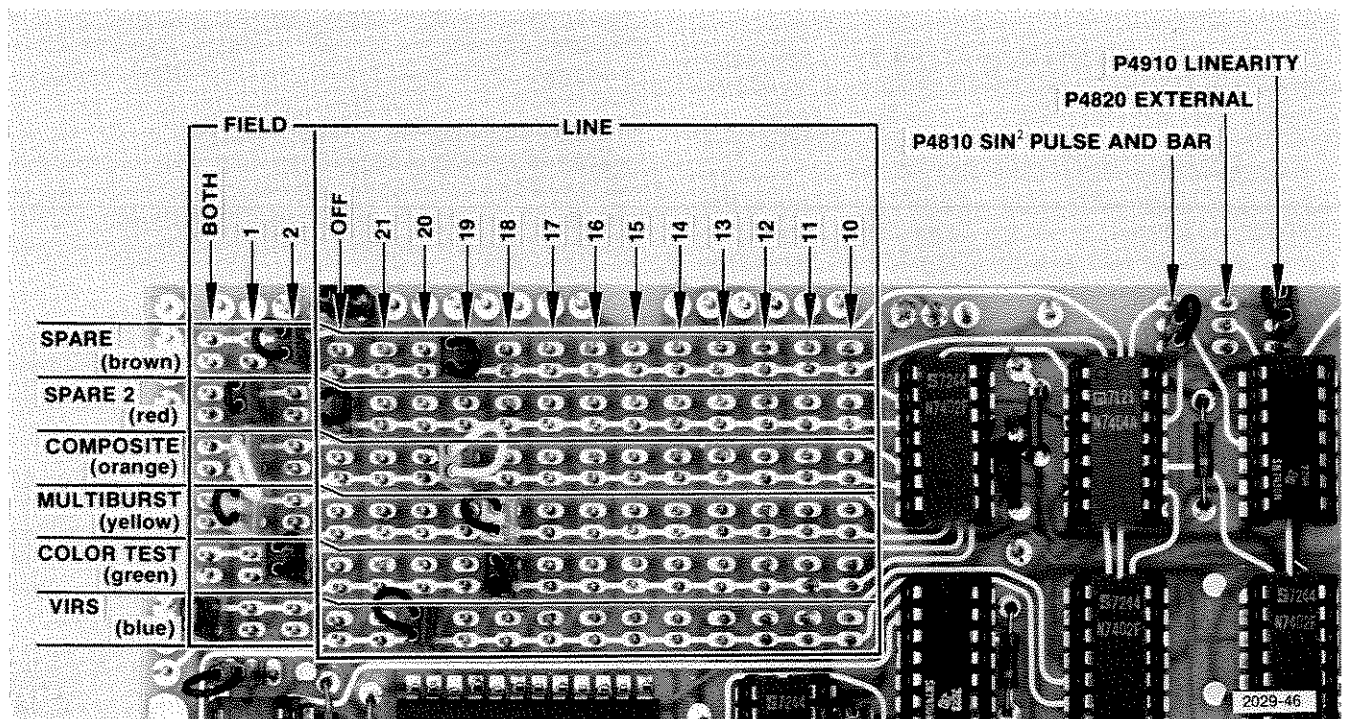

Fig. 1-14. VITS and FF circuit board location of VITS Line and Field selector plugs.

The following information details each VIT signal available.

COLOR TEST SIGNAL (149A), NOISE (147A), MULTIBURST, COMPOSITE, and VIRS: Operating personnel may select any line from 10 through 21 of field one, field two, or both fields.

SPARE 2: Operating personnel may select any line from 10 through 21 of field one, field two, or both fields for one of the following:

SIN² PULSE AND BAR: Pins two (2) and three (3) of P4810 (see Fig. 1-14) must be connected.

LINEARITY: Pins two (2) and three (3) of P4910 must be connected.

EXTERNAL: Pins two (2) and three (3) of P4820 must be connected.

SPARE 1: Operating personnel may select any line from 10 through 21 of field one, field two, or both fields for the SIN² PULSE AND BAR, LINEARITY, or EXTERNAL VITS. Selection is accomplished as for SPARE 2, except connections must be made between pins one (1) and two (2) of P4810, P4820, or P4910.

NOTE

To delete an incoming VITS, program for EXTERNAL, and do not put an EXTERNAL VITS into the EXT VITS IN connector.

VITS Cover

As a convenience to the operator, a VITS program cover is supplied with the 147A and 149A with factory-connected VITS written in; see Figs. 1-6 and 1-7 of this manual. This cover can be removed and the front panel will consist of an array of write-in spaces where the internal line and field addresses of the VIT signals may be indicated as programmed by the operator.

Line 21 Deletion/Pass

As factory-connected, any incoming signal on line 21 of either field will be passed. To delete the first half-line of line 21, field one (1), and the full active line time of line 21, field two (2); change the connector on pins one (1) and two (2) of P4200 to pins two (2) and three (3) (see Fig. 1-15).

VIRS Insertion on a Monochrome Program Signal

The 147A and 149A will not normally insert the VIR signal on a monochrome program signal. To insert the VIR signal in the presence of a monochrome program signal, move the jumper on P4779 from pins two (2) and three (3) to pins one (1) and two (2) (see Fig. 1-15).

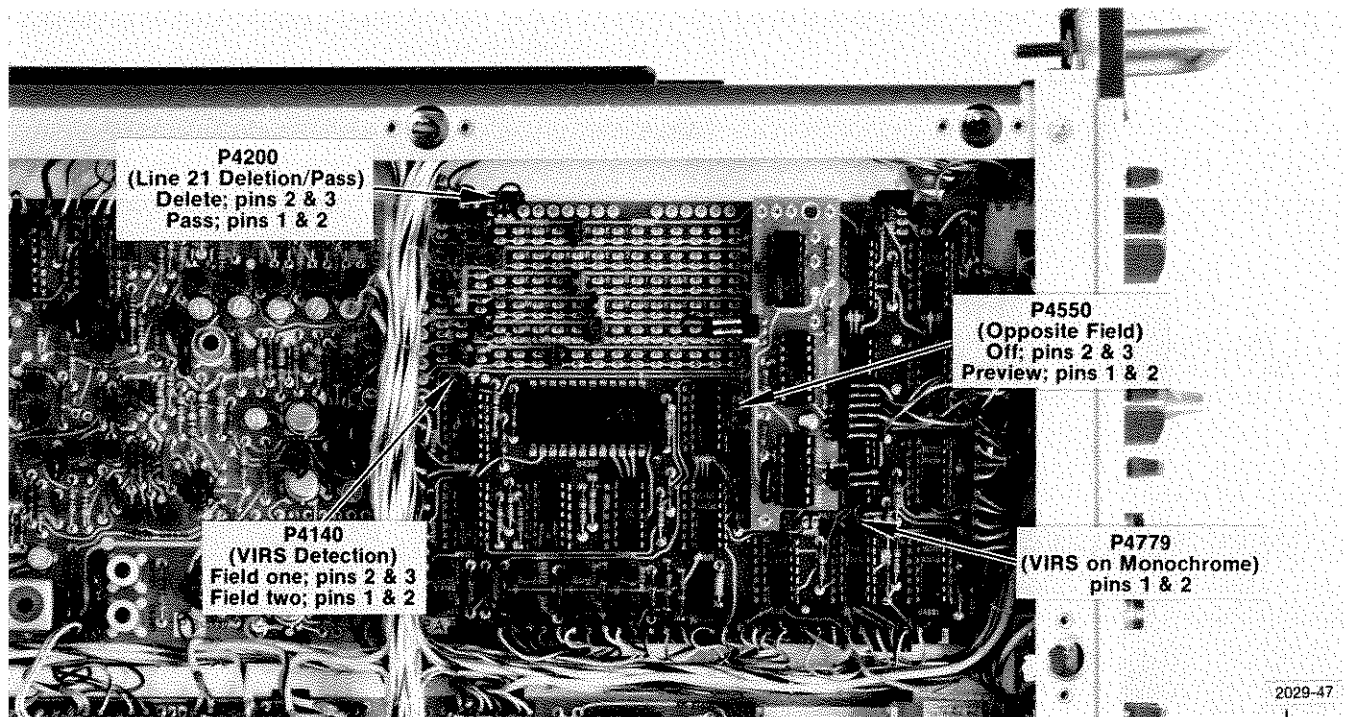

Fig. 1-15. VITS and FF circuit board location of VIRS Detect, Opposite Field Preview, VIRS on Monochrome, and Line 21 Delete plugs.

Operating Instructions and Specifications—147A/149A

External VIRS Detection and Opposite Field Preview

The following options have been grouped together because of interaction between them. They are also dependent upon the presence or absence of an external VIRS to the PROGRAM LINE IN, and upon the 147A or 149A internal field programming for VIRS.

The position of the connector on P4140 (see Fig. 1-15) determines which field of the incoming signal is detected for VIRS. Field one detection is obtained by connecting between pins two (2) and three (3). Field two detection is obtained by connecting between pins one (1) and two (2).

The position of the connector on P4550 determines whether internal VIRS will be inserted on the opposite field from external VIRS in the PREVIEW mode of operation. Connecting pins one (1) and two (2) of P4550 allows insertion (PREVIEW); pins two (2) and three (3) connected will not.

Table 1-4 lists the various conditions under which this change is effective.

NOTE

With (1) no external VIRS in, or (2) 147A or 149A programmed for BOTH fields, the Opposite Field Preview is inoperative.

NOTE

With P4550 in OFF (pins 2 and 3), PREVIEW and PROGRAM are the same.

Fig. 1-16 demonstrates a use of the Opposite Field Preview mode. An off-the-air signal has been demodulated and fed to the PROGRAM LINE IN of the generator. The PREVIEW MONITOR OUT is connected to the Tektronix 1480 Waveform Monitor, which has selected Line 19, All Fields. This allows the incoming VIRS on Field one to be overlaid with the internally-generated VIRS on Field two. Fig. 1-16b shows that the incoming VIRS has been restored to an acceptable level by the Tektronix 1440 Automatic Video Corrector.

Horizontal Programming

The 147A and 149A are versatile, in that any signal generated may be internally reprogrammed, using quick-change connectors, to produce signals which are timed according to specific user applications. Fig. 1-9 shows the signals generated by the 147A and 149A, along with all timing information.

Using the COMPOSITE test signal as an example, notice that the horizontal axis has been plotted in microseconds from 0 to 64 (in NTSC, this is actually 63.56 μ s, the difference to be explained later) with 10, 14, 17, etc. listed along the axis. Each of these listed times corresponds to a particular portion of the complete signal, which can be reprogrammed as desired. In other words, the 2T pulse might be reprogrammed to start at 32 μ s, or completely eliminated.

TABLE 1-4

External VIRS Detection and Opposite Field Preview

VIRS Field Programming		Changes		Program Control			
		VIRS Field Detection (P4140)	Opposite Field Preview (P4550)	PREVIEW MODE; PREVIEW MONITOR DISPLAY of VIRS		PROGRAM MODE; PROGRAM MONITOR DISPLAY of VIRS	
				Field One	Field Two	Field One	Field Two
Int	Incoming						
1	1	1	PREVIEW	EXT	INT	EXT	NONE
1	1	1	OFF	EXT	NONE	EXT	NONE
2	2	2	PREVIEW	INT	EXT	NONE	EXT
2	2	2	OFF	NONE	EXT	NONE	EXT
1	BOTH	1	PREVIEW	EXT	INT	EXT	EXT
1	BOTH	1	OFF	EXT	EXT	EXT	EXT
1	BOTH	2	PREVIEW	EXT	INT	EXT	EXT
1	BOTH	2	OFF	EXT	EXT	EXT	EXT
2	BOTH	1	PREVIEW	INT	EXT	EXT	EXT
2	BOTH	1	OFF	EXT	EXT	EXT	EXT
2	BOTH	2	PREVIEW	INT	EXT	EXT	EXT
2	BOTH	2	OFF	EXT	EXT	EXT	EXT

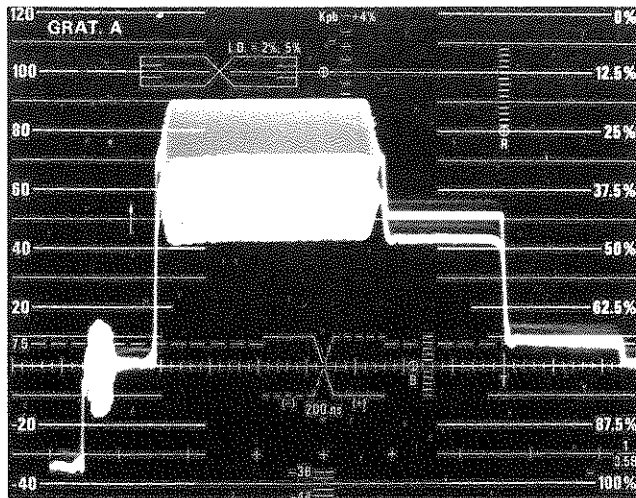

(A)

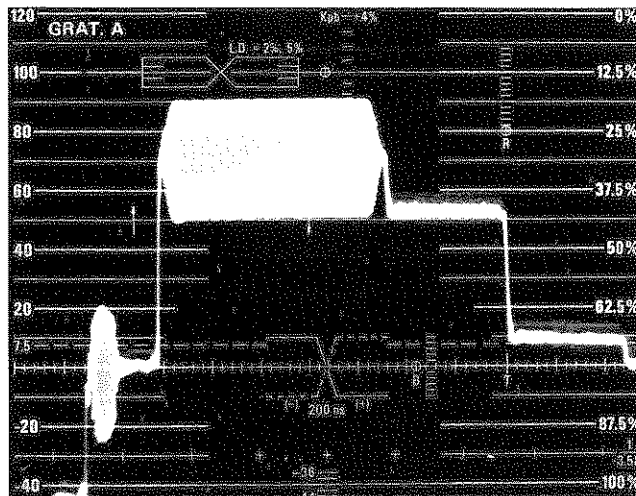

(B)

Fig. 1-16. Opposite Field VIRS Preview showing (A) uncorrected overlay of fields one and two, and (B) incoming VIRS corrected by TEKTRONIX 1440 overlaying internal VIRS.

Characteristic Instants

All signal programming is controlled by selection of various gate signals derived by the Horizontal Counter. These gate signals are brought to circuit board square pins for easy access (see Fig. 1-17). There are three groups of pin connectors; Instant, +, and 1/2 Instant. The first group, Instant, is arranged to provide 32 columns with nine rows of pins per column row. These columns are numbered, left to right, 3, 4, ..., 32, 1, and 2. Each number is a Characteristic Instant and is exactly equal to:

$$\frac{63.56 \mu s}{32} = 1.98725 \mu s,$$

or approximately 2 μs . The Characteristic Instant, therefore, represents the time axis of Fig. 1-9, and is the reason for an apparent H Rate of 64 μs .

The second group of pins, + (P2730), contains three (3) pins. This column of pins is used to connect unused inputs. Its use will be explained shortly. The third group of pins, 1/2 Instant (P2950), contains two pins which are internally connected to provide a 1/2 Characteristic Instant (1 μs) timing change. This will also be covered in the example to follow.

Table 1-5 lists the programming as factory-connected. Use of Table 1-5 will be covered in the following example.

NOTE

Reprogramming of some signals may require internal calibration. We recommend that only qualified personnel, thoroughly familiar with the different signal characteristics and calibration procedures, perform these programming changes.

The following example uses the staircase portion of the COMPOSITE signal and involves all three groups of Instants. It is assumed that the staircase portion of this signal has (1) been completely disabled (e.g., all programming wires associated with this signal are disconnected) and (2) the staircase signal will be programmed to provide the same timing as that shown in Fig. 1-9 of this manual.

Proceed as follows:

a. Referring to Table 1-5, scan the Signal, Affected Portion, and Function columns for all possible connections for the staircase portion of the COMPOSITE signal. These are (1) Modulation Set; (2) Modulation Reset; (3) Step Enable Set; (4) Step Enable Reset; (5) 1st Level Set; (6) 2nd and 4th Level Set; (7) 3rd Level Set; and (8) 5th Level Set.

b. Directly opposite the Signal, Affected Portion, and Function columns for each possible connection found in part a, note the Instant Timing column and the Wire and Connector Color Code column. This gives the color code of the wire, color code of the connector connected to the wire, and the instant which corresponds to the time of the signal segment. For connection (3), Steps Enable Set, notice for the wire code a 9-4, for the connector a 0, and for Instant a 4. This indicates that a white wire with a yellow stripe (9-4) and black connector (0) is the only programming wire for the Steps Enable Set circuitry within the instrument. This 9-4/0 combination, when connected to Instant 4 (8 μs) on the Horizontal Timing circuit board, will enable the steps portion of the COMPOSITE signal to be generated.

Using the above connection as a guide, connect the signal segment wires for (1), (4), (5), (7), and (8).

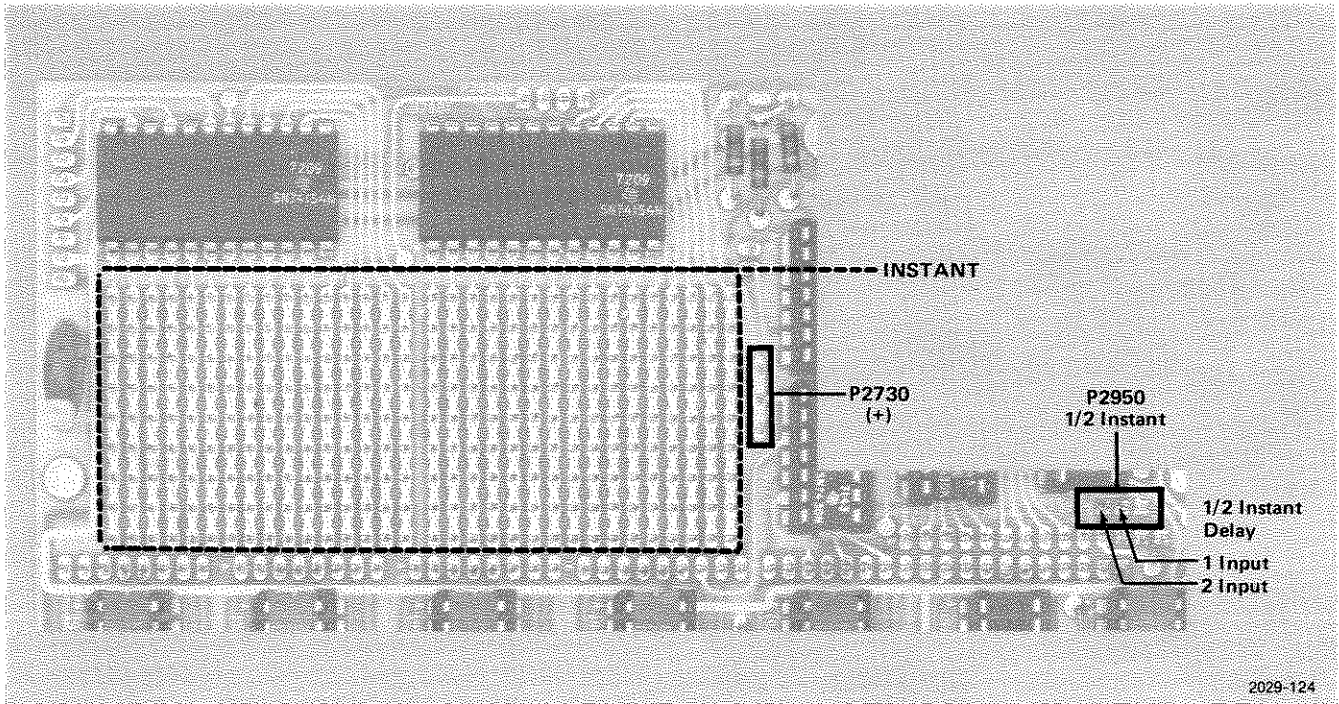

Fig. 1-17. Horizontal Timing circuit board showing location of Characteristic Instants. Use with Table 1-5.

TABLE 1-5
Factory Horizontal Programming

Signal	Affected Portion	Function	Timing Instant	Color Code	
				Connector	Wire
All	Horizontal Blanking	Set	5	0	9-5
		Reset	31	0	9-34
Composite	Setup and Phase Sw.	Set	16	0	9-07
		Reset	31	3	9-34
	Step Modulation	Set	5	2	9-5
		Reset	14 ⁴	1	9-05
	Step Enable	Set	4	0	9-4
		Reset	16	1	9-07
	1st Level	Set	7	0	9-7
	2nd Level	Set	8 ⁴	3	9-8
	3rd Level	Set	10	0	9-01
	4th Level	Set	11 ⁴	1	9-02
	5th Level	Set	13	0	9-04
	Pulse	Set	18	3	9-12
	Modulated Pulse	Set	19	0	9-13
		Reset	21	0	9-15
	Bar	Set	22	0	9-16
Reset		31	1	9-34	

⁴Actual timing of the output signals is delayed 1/2 instant.

TABLE 1-5 (cont)

Signal	Affected Portion	Function	Timing Instant	Color Code	
				Connector	Wire
Linearity	Modulation	Set	5	3	9-5
		Reset	29	0	9-27
	10 Step 1st Level	Set	9	0	9-0
		Set	11	0	9-02
		Set	13	0	9-04
		Set	15	0	9-06
		Set	17	1	9-08
		Set	19	1	9-13
		Set	21	0	9-15
		Set	23	0	9-17
		Set	25	1	9-23
		Set	27	2	9-25
	Ramp	Set	8	0	9-8
		Reset	28	0	9-26
Multiburst	White Flag	Set	5	1	9-5
		Reset	8	2	9-8
	Center Level	Set	8	4	9-8
		Reset	31	2	9-34
	Burst Width	Set	1	0	9-1
		Reset	17	2	9-08
	0.5 MHz	Set	9	1	9-0
	1.25 MHz (149A)	Set	14	0	9-05
	1.5 MHz (147A)	Reset	18	1	9-12
	2.0 MHz	Set	18	2	9-12
		Reset	21	1	9-15
	3.0 MHz	Set	21	2	9-15
		Reset	24	2	9-18
	3.58 MHz	Set	24	0	9-18
Reset		27	0	9-25	
4.1 MHz (149A)	Set	27	1	9-25	
	Reset	31	4	9-34	
Pulse & Bar	Mod Pulse	Set	6	1	9-6
		Reset	8	1	9-8
	Pulse	Set	10	2	9-02
	Bar	Set	12	0	9-03
		Reset	25	0	9-23
	Color Bars (149A only)	White Bar	Clock	5	0
Yellow Bar		Clock	9	0	9-0
Cyan Bar		Clock	12	0	9-03
Green Bar		Clock	15	0	9-06
Magenta Bar		Clock	18	0	9-12
Red Bar		Clock	21	0	9-15
Blue Bar		Clock	24	0	9-18
Black Bar		Clock	27	0	9-25
Modulated Pedestal (149A only)		20 IRE Modulation	Set	5	4
	40 IRE Modulation	Set	11 ⁴	0	9-02
	80 IRE Modulation	Set	18	2	9-12
		Reset	24 ⁴	3	9-18

⁴Actual timing of the output signals is delayed 1/2 instant.

TABLE 1-5 (cont)

Signal	Affected Portion	Function	Timing Instant	Color Code	
				Connector	Wire
Modulated Pedestal (Half-Line) (149A only)	40 IRE Modulation	Set	8	0	9-8
	80 IRE Modulation	Set	12	0	9-03
		Reset	16	0	9-18
Noise (147A only)	1/2 Line Insert	Set	12	0	9-03
		Reset	24	0	9-18
VIRS	Modulation	Set	6	0	9-6
		Reset	17	0	9-08
	70 IRE Level	Set	6	2	9-6
		Reset	18	0	9-12
	50 IRE Level	Set	6	4	9-6
		Reset	24	1	9-18
	7.5 IRE Level	Set	6	3	9-6
		Reset	30	0	9-28

c. For signal segment (2), Modulation Reset, notice the Timing column. A 1/2 Instant (14.5) is being used. This is accomplished by programming to Instant 14, delaying 1 μ s, then applying the delayed programming signal to the Steps Modulation Reset circuitry within the 147A or 149A.

Locate the wire and connector combination of 9-05/1 (used with Instant 14) and connect it to Instant 14 (input to 1 μ s delay). Now, locate the 9-36/0 combination and connect it to pin 2 of P2950 (output of 1 μ s delay). Connections made will add 1/2 Instant or 1 μ s to the count, allowing the Steps Modulation to Reset (stop) at 29 μ s.

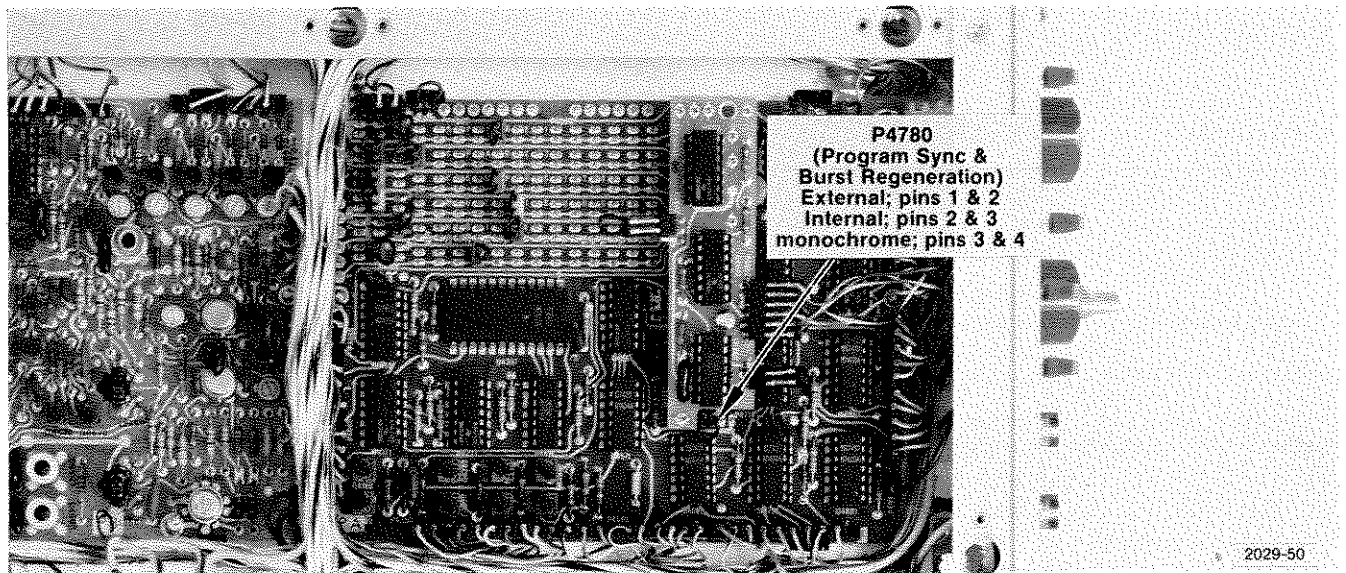

Fig. 1-18. VITS and FF circuit board showing location of the Program Sync and Burst Regeneration plug, P4780.

d. For signal segment (6), notice the Timing column. Two 1/2 Instants (8.5 and 11.5) are given. Locate the 9-8/3 and 9-02/1 combinations and connect them to Instant 14 (2 input to 1 μ s delay). Next, locate the 9-37/0 combination and connect it to pin 1 of P2950 (output of 1 μ s delay). This will add 1 μ s to the second and fourth step starting points, starting them at 17 and 23 μ s respectively.

e. Once all the above connections have been made, check that all signal segments appear as shown in Fig. 1-9.

Removing 1/2 Instants

In the above procedure, it was shown how to program in a 1/2 Instant. Now, assume the staircase portion of the COMPOSITE signal was to contain no 1/2 Instants. That is, signal segment (2) was to be programmed to reset at Instant 14 and that signal segments of (6) were to be programmed to Set at Instants 8 and 11.

To Reset at Instant 14 rather than 14.5, disconnect the 9-36/0 combination from pin 2 of P2950 and reconnect it to Instant 14. To start the second step at Instant 8, disconnect the 9-37/0 combination from pin 1 of P2950 and reconnect it to Instant 8. Disconnect the 9-45/0 combination from + (P2730) and connect it to Instant 11.

Deleting Instants

To delete any programming, connect the signal segment programming wire to the + connector (P2730). Connecting any wire to the + will disable that particular function. For example, locate the 9-4/0 combination for the Steps Enable Set, connected in part b of the example, and connect it to the + connector. The staircase portion of the COMPOSITE signal will now be eliminated.

Program Sync and Burst Regeneration

Internally-processed sync and burst (Gen-Locked to the PROGRAM LINE IN signal) can be substituted for the PROGRAM LINE IN sync and burst. To insert internal sync and burst on a color signal, change the connector on P4780 from pins 1 and 2, to pins 2 and 3. This position will not insert sync on a monochrome signal. To insert internal sync and burst on a color signal, and internal sync on a monochrome signal, change the connector on P4780 to pins 3 and 4. See Fig. 1-18 for the location of P4780.

VIT signals on lines 15 and lower of the Program signal will be deleted when internal sync and burst are being inserted. A VIT signal on line 16 or above will be passed when internally-generated VITS are not programmed on the same lines. The front-panel PROGRAM CONTROL/VAR LEVEL adjustment can be used with an incoming VIT signal to set the correct amplitude of the signal with inserted sync and burst. See Fig. 1-19 for an illustration of this.

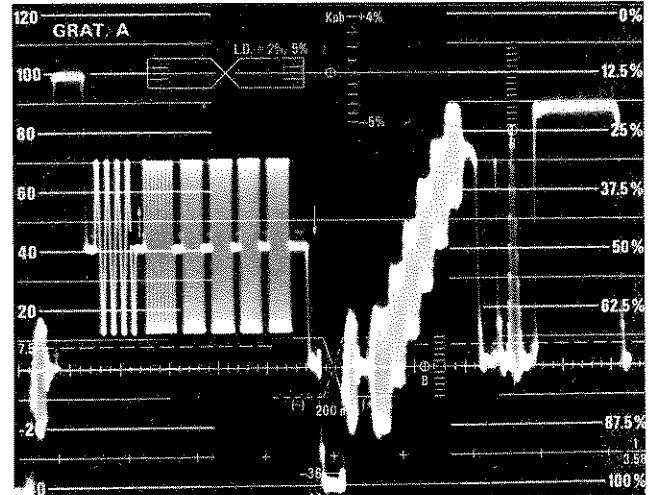

(A)

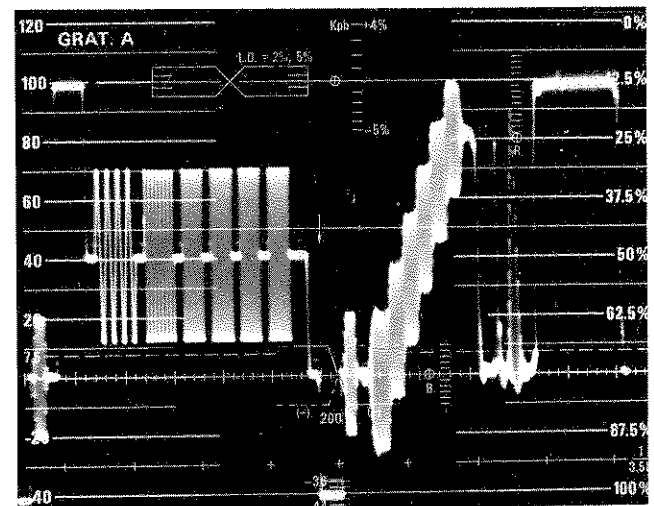

(B)

Fig. 1-19. Illustration of Program Sync and Burst Regeneration showing (A) incoming Program signal, and (B) Program signal with sync and burst regenerated, and amplitude adjusted with the VAR LEVEL control.

CW Subcarrier Lock

If desired, the 147A or 149A can be Gen-Locked to a composite sync signal with superimposed subcarrier (such as RCA CompSync) through the BLACK BURST input. This is accomplished by changing the connector on P5141 (see Fig. 1-20) from pins 1 and 2 to pins 2 and 3.

LINEARITY Modulation and Staircase Levels

The following options have been grouped, since there is interaction between them, and depending upon needed signal levels, could require internal calibration.

As shipped from the factory, the LINEARITY test signal modulation amplitude is 40 IRE peak-to-peak. To obtain a modulation amplitude of 20 IRE peak-to-peak, change the connector on pins 2 and 3 of P3400 (see Fig. 1-21) to pins 1 and 2.

To obtain different levels of staircase or ramp, proceed as follows:

- | | |
|---------|---|
| 5 STEP | Set the LINEARITY switches for 5 STEPS and SUBCARRIER OFF. For a 5 Step amplitude of between 80 and 90 IRE, adjust C3565 (see Fig. 1-21) for the desired amplitude. For a 149A 5 Step amplitude of between 90 and 100 IRE, connect P3470 between pins 2 and 3 (see Fig. 1-21) and adjust C3565 for the desired amplitude. For a 147A 5 Step amplitude between 90 and 100 IRE, connect C3467 to the socket provided, and adjust C3565 for the desired amplitude. |
| 10 STEP | Set the LINEARITY switches for 10 STEPS and SUBCARRIER OFF. Adjust C3470 for the desired 10 Step amplitude. |
| RAMP | Set the LINEARITY switches for RAMP and SUBCARRIER OFF. Adjust R3616 for the desired Ramp amplitude. |

COMPOSITE Test Signal with Ramp

As shipped from the factory, the 5 Step Staircase is generated as a portion of the COMPOSITE signal. To replace the steps with a ramp, rotate P3760 (see Fig. 1-21) 180°, and connect P3620 (see Fig. 1-21) between pins 2 and 3.

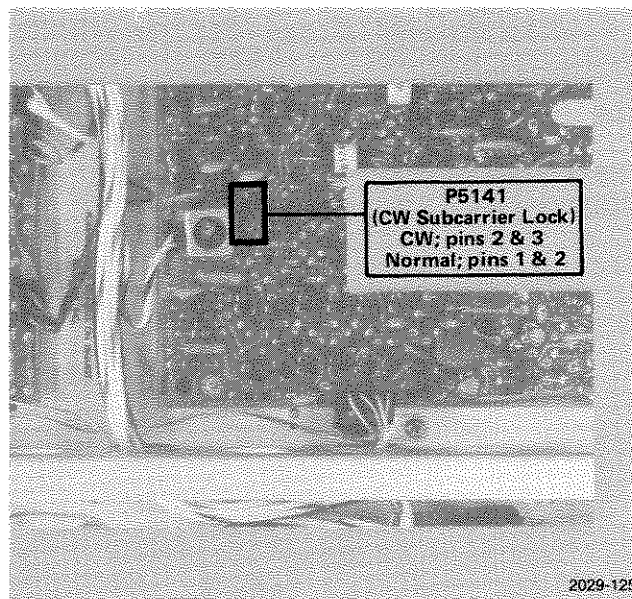

Fig. 1-20. Gen-Lock circuit board location of CW Subcarrier Lock selector plug.

NOTE

Requires horizontal reprogramming and internal adjustment.

Adjustment Procedure

- a. Set the LINEARITY SUBCARRIER switch OFF.
- b. Using Fig. 1-17 and Table 1-5 as guides, reprogram the RAMP as follows:
Set, Instant 7 (9-8/0); Reset, Instant 14 (9-26/0).
- c. Change the connector between pins 1 and 2 of P3620 (see Fig. 1-21) to pins 2 and 3.
- d. Adjust Ramp Amplitude control; R3616, for 80 IRE between blanking and the ramp peak.

APL Bounce Trigger (149A only)

As factory-connected, the FLAT FIELD BOUNCE signal switches on line 57. If desired, the switching can be made to occur at random by changing the connector on pins 2 and 3 of P3926 (see Fig. 1-21) to pins 1 and 2.

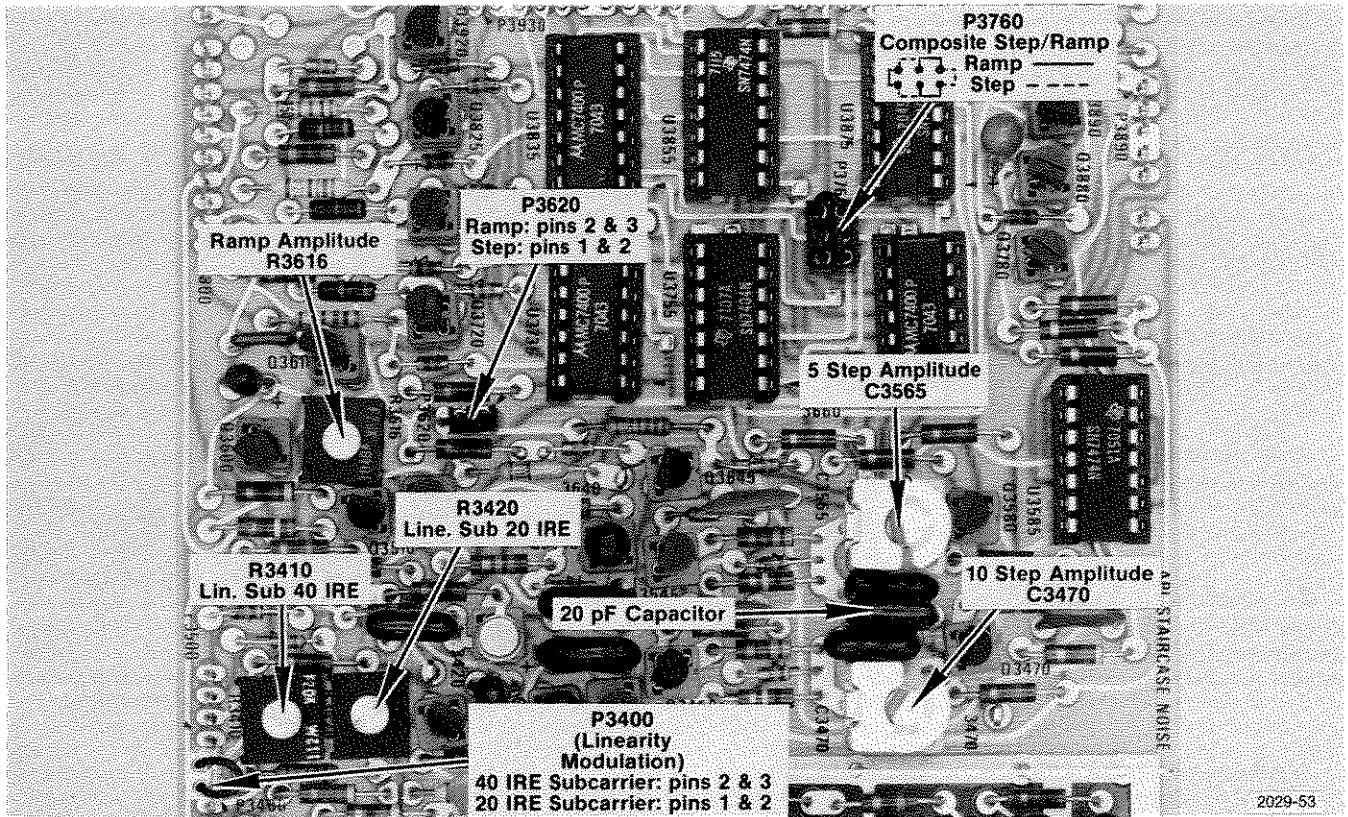

Fig. 1-21. APL and Staircase circuit board location of selector plugs and adjustments for LINEARITY operating changes.

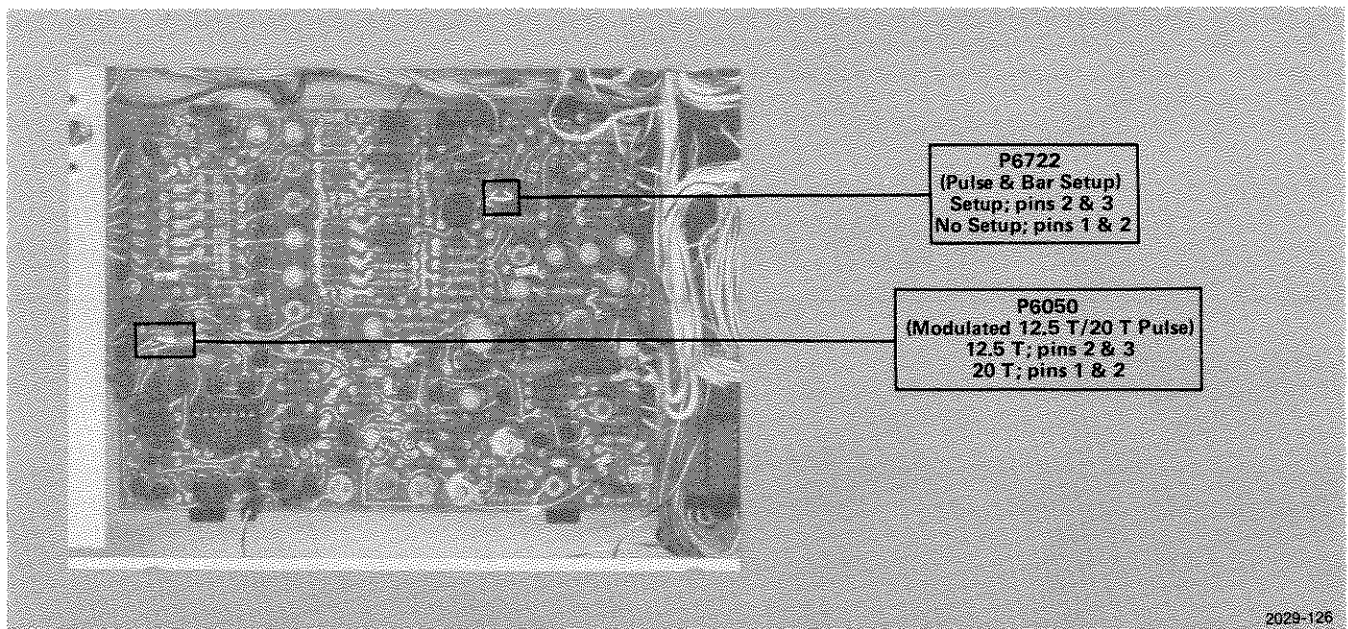

Fig. 1-22. Function Generator circuit board location of selector plugs.

Modulated 12.5T/20T Sine-Squared Pulse

NOTE

This reconnection requires internal adjustment.

As factory-connected, the 147A or 149A displays the modulated 12.5T Pulse. This may be changed to display the modulated 20T Pulse by changing the connector on pins 2 and 3 of P6050 (see Fig. 1-22) to pins 1 and 2.

147A Adjustment Procedure

1. Observe the SIN² PULSE AND BAR FULL FIELD TEST SIGNAL OUT signal.

Operating Instructions and Specifications—147A/149A

2. Adjust R7661 (Modulation Gain) and R7357 (Luminance Gain) for (1) a peak modulation amplitude of 714 mV, and (2) the best flat bottom on the modulated pulse. See Fig. 1-23 for the location of all adjustments in this procedure.

3. Adjust R7453 (P & B Sync Level) to align the vertical and horizontal blanking levels.

4. Adjust R8630 (Burst Amplitude) for peak-to-peak burst amplitude of 285.6 mV (40 IRE).

5. Observe the LINEARITY test signal. Adjust R3410 (40 IRE Mod Amplitude) for a Linearity Modulation amplitude of 285.6 mV (40 IRE).

6. Move the connector on P3400 to pins 1 and 2. Adjust P3420 (20 IRE Mod Amplitude) for a Linearity Modulation amplitude of 142.8 mV (20 IRE). Replace the connector on P3400 to pins 2 and 3.

7. Observe the MULTIBURST test signal. Adjust R6741 (MB Gain) for a 500 kHz packet amplitude of 642.6 mV (90 IRE).

8. Observe the VIR Signal. Adjust R8380 (VIRS Modulation Amplitude) for a VIRS Modulation amplitude of 285.6 mV (40 IRE).

149A Adjustment Procedure

1. Observe the SIN² PULSE AND BAR FULL FIELD TEST SIGNAL OUT signal.

2. Adjust R8109 (Sin² Chroma Gain), see Fig. 1-24, and R7357 (Luminance Gain), see Fig. 1-25, for (1) a peak modulation amplitude of 714 mV (100 IRE) and (2) the best flat bottom on the pulse.

3. Adjust R7453 (P & B Sync Level), see Fig. 1-25, until the horizontal and vertical blanking levels are aligned.

Sine-Squared Pulse and Bar Setup

As factory-connected, setup is not present on this signal. Setup can be obtained by changing the connector on pins 1 and 2 of P6722 (see Fig. 1-22) to pins 2 and 3.

NOTE

This reconnection requires internal adjustments.

147A Adjustment Procedure

1. Observe the SIN² PULSE AND BAR FULL FIELD OUT signal.

2. Adjust R7131 (2T Pulse Amplitude), see Fig. 1-25, for a peak pulse amplitude of 714 mV (100 IRE).

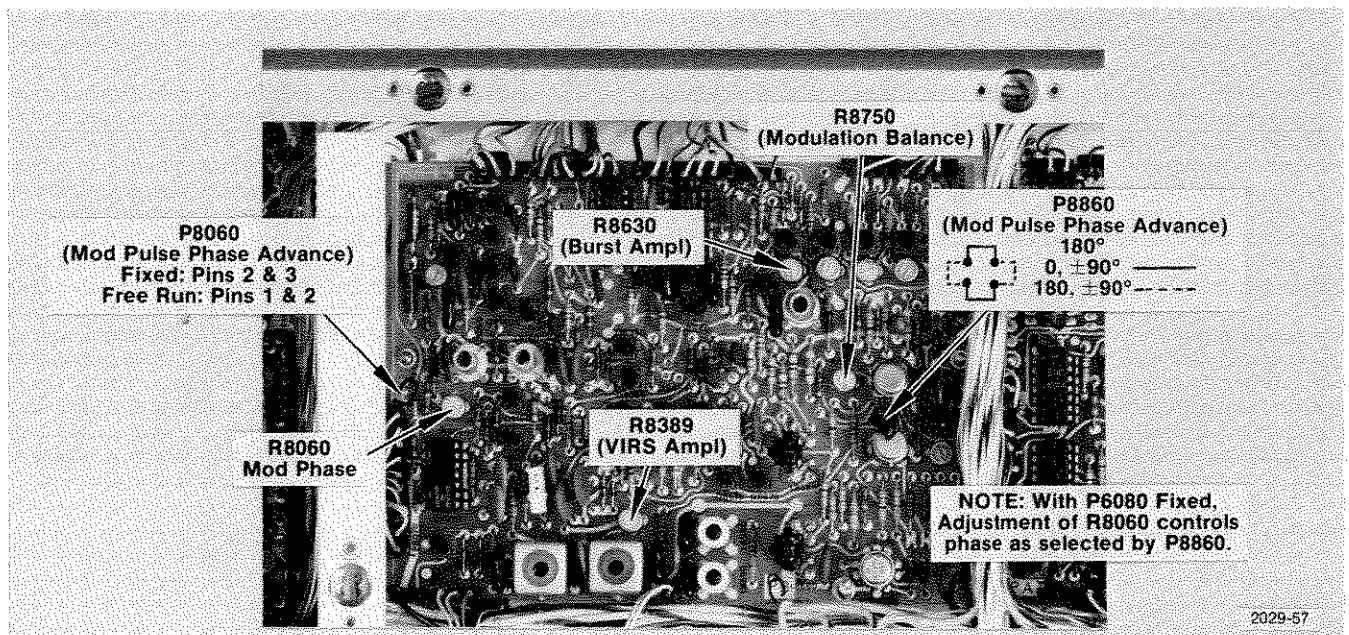

Fig. 1-23. 147A chrominance adjustments.

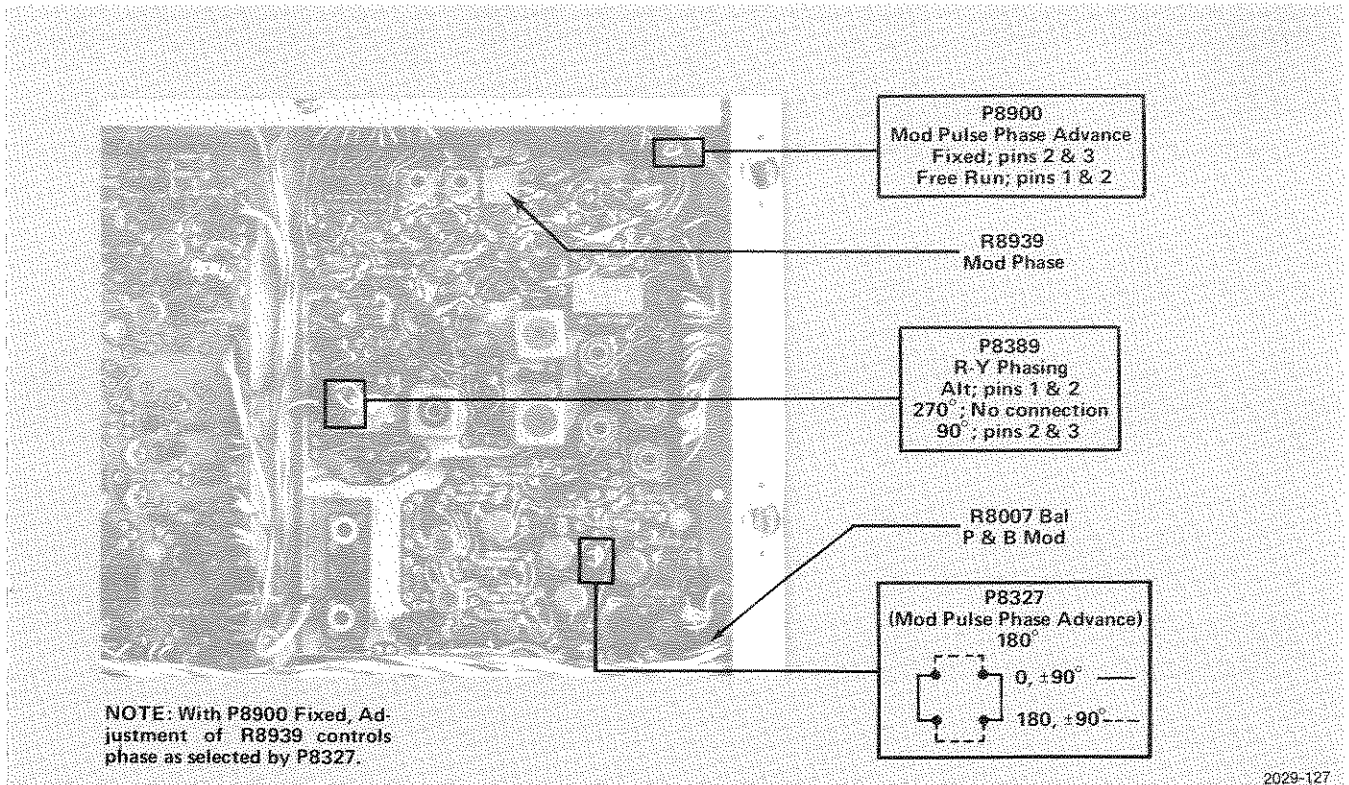

Fig. 1-24. 149A chrominance adjustments.

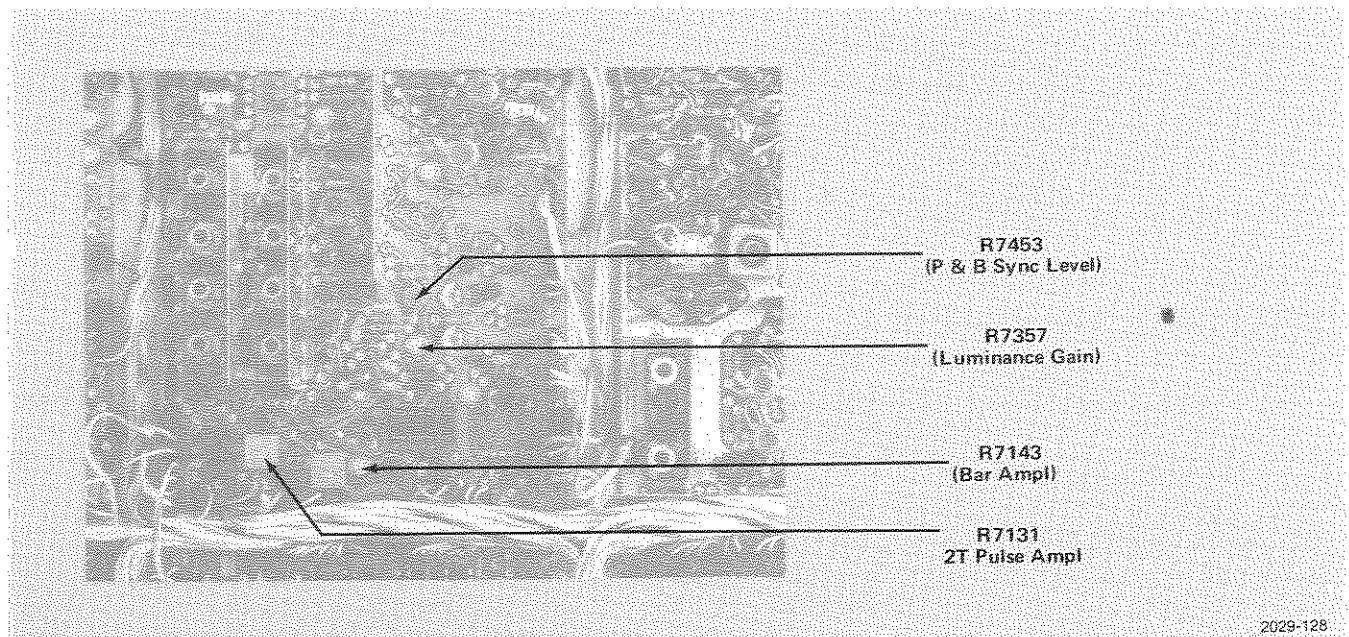

Fig. 1-25. Output Amplifier circuit board location of adjustments.

Operating Instructions and Specifications—147A/149A

3. Adjust R7143 (Bar Amplitude) for a peak bar amplitude of 714 mV (100 IRE).

4. Adjust R7357 (Luminance Gain) for equal amounts of chrominance above the 100 IRE level and below the setup level (10 IRE).

5. Adjust R7455 (P & B Sync Level) until the horizontal and vertical blanking levels are aligned.

6. Adjust R7661 (Modulation Gain) until the peak of chrominance within the modulated pulse is at 100 IRE and the bottom portion of chrominance within the modulated pulse is flat at 10 IRE.

7. Adjust R8630 (Burst Amplitude), see Fig. 1-25, for a burst amplitude of 285.6 mV (40 IRE) peak-to-peak.

8. Observe VIRS. (Programmed on line 19 of either field.)

9. Adjust R8380 (VIRS Amplitude) for a VIRS sub-carrier amplitude of 285.6 mV (40 IRE) peak-to-peak.

10. Observe the LINEARITY test signal with modulation.

11. Adjust R3420 (40 IRE Modulation Amplitude) for a modulation amplitude of 285.6 mV (40 IRE) peak-to-peak.

12. Change the connector on pins 2 and 3 of P3400 to pins 1 and 2.

13. Adjust R3410 (20 IRE Modulation Amplitude) for a modulation amplitude of 142.8 mV (20 IRE) peak-to-peak.

14. Change the connector on pins 1 and 2 of P3400 back to pins 2 and 3.

149A Adjustment Procedure

1. Observe the SIN² PULSE AND BAR FULL FIELD OUT signal.

2. Adjust R7131 (2T Pulse Amplitude), see Fig. 1-25, for a peak pulse amplitude of 714 mV (100 IRE).

3. Adjust R7143 (Bar Amplitude) for a peak bar amplitude of 714 mV (100 IRE).

4. Adjust R7357 (Luminance Gain) for equal amounts of chrominance above the 100 IRE level and below the setup level (10 IRE).

5. Adjust R7453 (P & B Sync Level) until the horizontal and vertical blanking levels are aligned.

6. Adjust R8109 (Sin² Chroma Gain), see Fig. 1-24, until the peak of chrominance within the modulated pulse is at 100 IRE and the bottom portion of chrominance within the modulated pulse is flat at 10 IRE.

2T/T Sine-Squared Pulse

As factory-connected, the 147A or 149A displays the 2T Pulse. To display the T Pulse in place of the 2T Pulse, (1) change the connector on pins 1 and 2 of P7131 (see Fig. 1-25) to pins 2 and 3, and (2) change the connector on pins 5 and 6 of P7321 to pins 4 and 5.

T/2T Bar (Integrated Sine-Squared Pulse) (147A)

As factory-connected, the 147A displays the T Bar. To display the 2T Bar in place of the T Bar, change the connector on pins 1 and 2 of P7321 to pins 2 and 3.

2T/T Bar (Integrated Sine-Squared Pulse) (149A)

As factory-connected, the 149A displays the 2T Bar. To display the T Bar in place of the 2T Bar, change the connector on pins 2 and 3 of P7321 to pins 1 and 2.

Modulated Sine-Squared Pulse Phase Advance/Advance 180° (147A)

The following changes have been grouped because of interaction.

Phase Advance. As factory-connected, the phase of the Full Field Modulated Sine-Squared Pulse is not fixed. This can be demonstrated by observing the 147A FULL FIELD SIN² PULSE AND BAR test signal on a vectorscope. A fan-shaped display, as shown in Fig. 1-26A, will be observed. This enables the test signal to be used where measurement accuracy is of prime importance.

By changing the connector on pins 1 and 2 of P8060, see Fig. 1-23, to pins 2 and 3, the phase of the Full Field Modulated Sine-Squared Pulse will be fixed. This is shown in Fig. 1-26B.

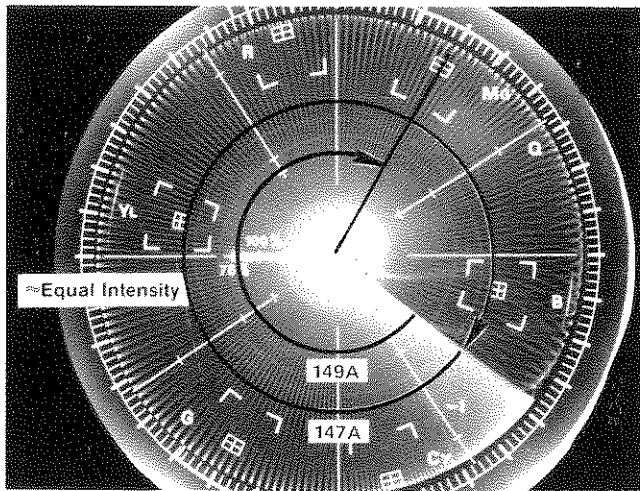

(A) Full Field Modulated Pulse phase; normal operating mode.

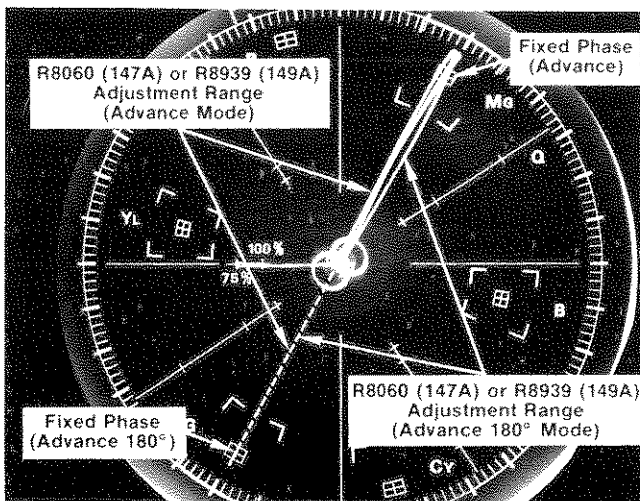

(B) Full Field Modulated Pulse phase (including VITS phase) advance and advanced 180° operating modes.

Fig. 1-26. Typical vectorscope display of the modulated pulse in (A) normal mode, and (B) advance mode.

Once Phase Advance has been established, adjustment of R8060 (Mod Phase) can be used to vary the fixed phase to any point within an approximate 180° range.

NOTE

In the Phase Advance mode, the Full Field and VITS Modulated Sine-Squared Pulse have the same phase. This allows source coding of the VIT Signal.

Advance 180°. As discussed above, it is possible to obtain Phase Advance of the Modulated Sine-Squared Pulse during VITS. If needed, the phase can be changed 180° from that obtained with adjustment of R8060 by rotating the connector on P8860 (see Fig. 1-23) by 90°. This provides a 360° control range of the VITS phase.

NOTE

The Phase of the Full Field Modulated Pulse will also be advanced 180° in this mode.

This connection requires internal adjustment.

Adjustment Procedure

1. Observe the SIN² PULSE AND BAR FULL FIELD TEST SIGNAL OUT.

2. Adjust R8750 (Modulation Balance), see Fig. 1-23, for minimum modulation on the blanking level.

Modulated Sine-Squared Pulse Phase Advance/ Advance 180° (149A)

The following changes have been grouped because of interaction.

Phase Advance. As factory-connected, the phase of the Full Field Modulated Sine-Squared Pulse is not fixed. This can be demonstrated by observing the 149A FULL FIELD SIN² PULSE AND BAR test signal on a vectorscope. A fan-shaped display, as shown in Fig. 1-26A, will be observed. This enables the test signal to be used where measurement accuracy is of prime importance.

By changing the connector on pins 1 and 2 of P8900, see Fig. 1-24, to pins 2 and 3, the phase of the Full Field Modulated Sine-Squared Pulse will be fixed. This is shown in Fig. 1-26B.

Once Phase Advance has been established, adjustment of R8939 (Mod Phase) can be used to vary the fixed phase approximately 180°

NOTE

In the Phase Advance mode, the Full Field and VITS Modulated Sine-Squared Pulse have the same phase. This allows source coding of the VITS.

Advance 180°. As discussed above, it is possible to obtain Phase Advance of the Modulated Sine-Squared Pulse during VITS. If needed, the phase can be changed 180° from that obtained with adjustment of R8939 by rotating the connector on P8327 (see Fig. 1-24) 90°. This provides a 360° control range of the VITS phase.

NOTE

The Phase of the Full Field signal will also be advanced 180° in this mode.

This connection requires internal adjustment.

Adjustment Procedure.

1. Observe the SIN² PULSE AND BAR FULL FIELD TEST SIGNAL OUT.

2. Adjust R8007 (P and B Mod Ball), see Fig. 1-24, for minimum modulation on the blanking level.

Modulated Pedestal Half Line (149A only)

As factory-connected, the MODULATED PEDESTAL COLOR TEST SIGNAL occupies a full line. If desired, the horizontal timing may be changed for utilization of active line time.

Proceed as follows: (1) Change the connector on pins 1 and 2 of P402 (see Fig. 1-27) to pins 2 and 3; (2) Change the connector on pins 1 and 2 of P478 to pins 2 and 3; and (3) Change the connector on pins 1 and 2 of P499 to pins 2 and 3.

With the above connections, the MODULATED PEDESTAL will be as shown in Fig. 1-28.

Color Bar R-Y Phase (149A only)

As factory-connected, the color bar R-Y phase is locked to 90° (normal NTSC operation). For test purposes, the R-Y phase can be locked to 270° by removing the connector on P8389 (see Fig. 1-24). For quadrature-phase testing, the R-Y phase can be alternated between 90° and 270° by connecting pins 1 and 2 of P8389.

ALT APL on Alternate Lines

As factory-connected, when ALT APL is selected, the FULL FIELD signal will consist of the selected FULL FIELD SIG on every fifth line, and the FLAT FIELD signal on the remaining 4/5 of the lines. If desired, the sequence may be change to one line of the FULL FIELD SIG alternating with one line of FLAT FIELD. To accomplish this, move the jumper on P4662 from pins 2 and 3 to pins 1 and 2. (See Fig. 1-29.)

Transmitter Protection

To prevent overdriving a transmitter, a video signal should always be present at the transmitter input. Often, one piece of equipment in the video chain will be designated to detect the loss of the program signal, and insert a new signal in its place. The 147A and 149A are factory-connected to automatically bypass the PROGRAM LINE IN to the PROGRAM LINE OUT connector when the incoming signal loses sync. This allows other equipment to detect the signal loss, and to do the appropriate switching of signals.

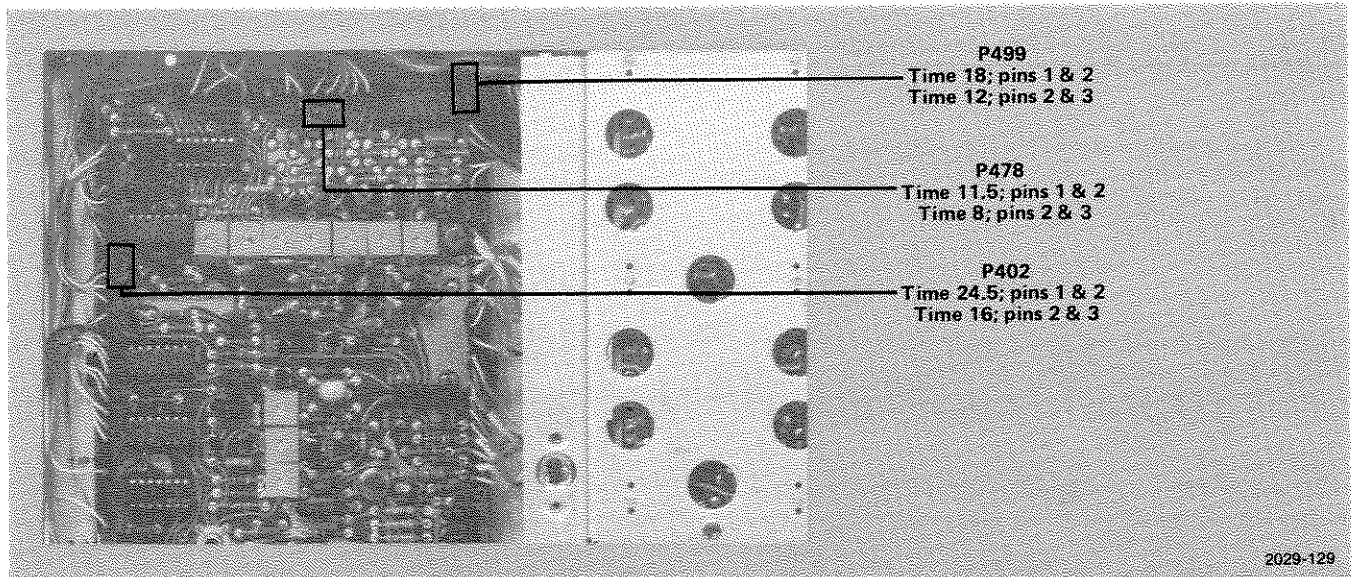

Fig. 1-27. 149A Subcarrier and Sync Out circuit board location of Modulated Pedestal selector plugs.

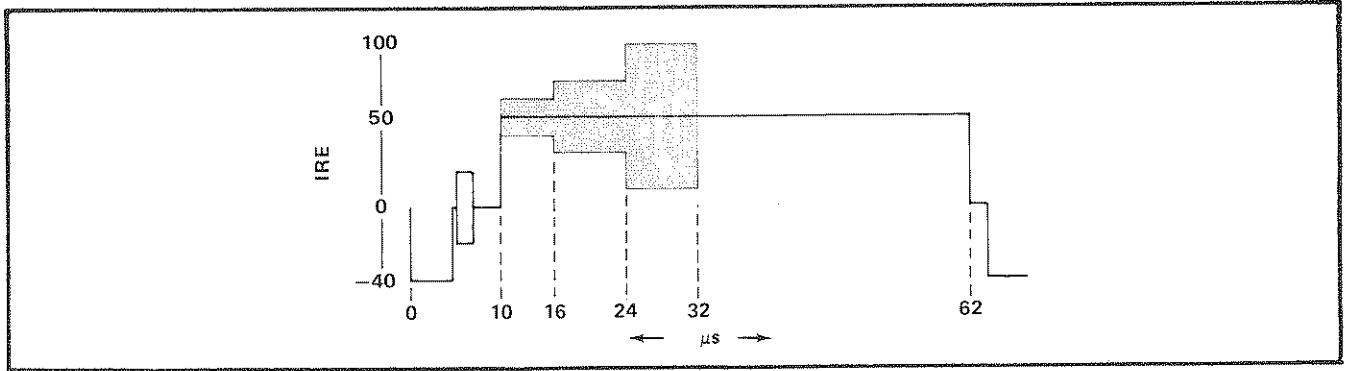
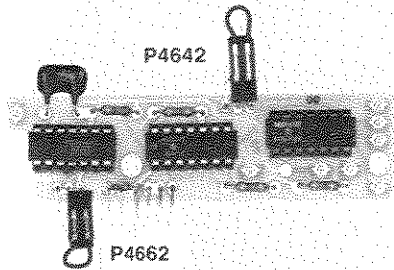

Fig. 1-28. Modulated Pedestal; half line option.



2029-61

Fig. 1-29. ALT APL circuit board locations of P4662 and P4642.

If desired, the 147A and 149A can be programmed to insert a full field test signal at the PROGRAM LINE OUT connector if the signal at the PROGRAM LINE IN connector loses sync. P9082, see Fig. 1-30, on the Relay board, must be turned 180°, connecting pin 1 to pin 2 and pin 5 to pin 6. This will provide the Flat Field Test Signal at the output.

To select any other test signals P4642, see Fig. 1-29, must be moved to connect pins 2 and 3. This allows the signal at the output to be selected by the FULL FIELD SIG Selector.

The time between loss of signal and switching of the 147A and 149A is about 1/2 second, determined by the

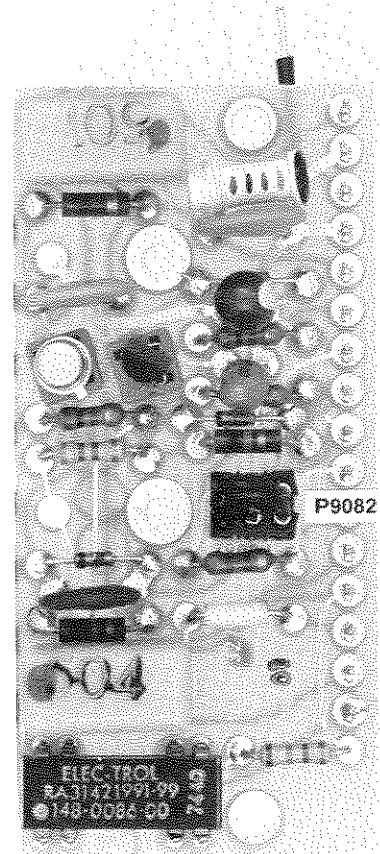

2029-62

Fig. 1-30. Relay circuit board location of P9082.

value of C345, see Fig. 1-27. If less delay is desired, C345 can be replaced with a lower value capacitor with the same voltage rating. A minimum value of about 15 μ F should be retained in the circuit to avoid relay chatter in the bypass mode, and to avoid switching on a momentary loss of sync.

GLOSSARY OF TERMS

ACTIVE VIDEO LINES: All video lines not occurring in the vertical blanking interval.

APL: Average picture level. The average signal level, with respect to blanking level, during active picture scanning time, expressed as a percentage of the difference between the blanking and reference white levels.

BACK PORCH: That portion of the composite video signal which lies between the trailing edge of the horizontal sync pulse and the trailing edge of the horizontal blanking pulse.

BLACK BURST: A signal consisting of composite sync and burst. Normally has setup.

BLANKING LEVEL: The level of the front and back porches of the composite video signal. Normally at 0 IRE.

BREEZEWAY: In NTSC color, the portion of the back porch between the trailing edge of the sync pulse and the start of the color burst.

BURST FLAG: Pulses used to key out a portion of the 3.579545 MHz sine wave subcarrier for use as a reference for the color signal.

CHROMINANCE: That property of light which produces a sensation of color in the human eye apart from any variation in luminance that may be present.

COLOR BAR: A test signal, typically containing eight basic colors: white, yellow, cyan, green, magenta, red, blue, and black, which is used to check the chrominance functions of color TV systems.

COLOR BURST: In NTSC color systems, this normally refers to a burst of approximately 8 to 10 cycles of 3.579545 MHz subcarrier frequency on the back porch of the composite video signal to establish a frequency and phase reference for the chrominance signal.

COLOR SUBCARRIER: In color systems, this is the carrier signal whose modulation sidebands are added to the monochrome signals to convey color information; in NTSC, it is a 3.579545 MHz sinewave.

COMPOSITE BLANKING: This signal is composed of pulses at line and field frequencies used to make the return traces of a picture tube invisible.

COMPOSITE SYNC: The line and field rate synchronizing pulses (including the field equalizing pulses) when combined together form the composite sync signal.

COMPOSITE VIDEO: For color, this consists of blanking, field and line synchronizing signals, color synchronizing signals, chrominance and luminance picture information. These are all combined to form the complete color video signal.

DIFFERENTIAL GAIN: The difference between (1) the ratio of the output amplitude of a small, high-frequency sine-wave signal at two stated levels of a low frequency signal on which it is superimposed and (2) unity.

DIFFERENTIAL PHASE: The difference in output phase of a small high-frequency sine-wave signal at two stated levels of a low-frequency signal on which it is superimposed.

EIA: An abbreviation for Electronic Industries Association.

EQUALIZING PULSES: Pulses of one half the width of the horizontal sync pulses which are transmitted at twice the rate of the horizontal sync pulses during the portions of the vertical blanking interval immediately preceding and following the vertical sync pulses. The purpose of these pulses is to cause the vertical deflection to start at the same time in each interval, and also serves to keep the horizontal sweep circuits in step during the portions of the vertical blanking interval immediately preceding and following the vertical sync pulse.

FIELD: One half of a complete picture (or frame) interval, containing all of the odd, or all of the even, lines of the picture.

FIELD BLANKING: Refers to the blanking signals which occur at the end of each field. Also called vertical blanking.

FIELD FREQUENCY: The rate at which one complete field is scanned, normally 59.94 times a second in NTSC.

FRAME: One complete picture consisting of two fields of interlaced scanning lines.

FRONT PORCH: That portion of the composite picture signal which lies between the leading edge of the horizontal blanking pulse and the leading edge of the corresponding sync pulse. Normally 1.59 μ s.

GEN LOCK: Subcarrier to burst lock.

H RATE: The time for scanning one complete line, including trace and retrace. NTSC equals 1/15,734 second (color) or 63.56 μ s.

IRE: An abbreviation for Institute of Radio Engineers.

IRE SCALE: An oscilloscope scale that applies to composite video levels. There are 140 IRE units in 1 volt.

LINE BLANKING: The blanking signal at the end of each scanning line. Used to make the horizontal retrace invisible. Also called horizontal blanking.

LINE FREQUENCY: The number of horizontal scans per second, normally 15,734.26 times per second in NTSC.

LUMINANCE (Y): The amount of light intensity, which is perceived by the eye as brightness (referred to as 'Y').

NTSC: National Television Systems Committee. An industry-wide engineering group which, during 1950-1953, developed the color television specifications now established in the United States.

REFERENCE WHITE LEVEL: The level corresponding to the specified maximum excursion of the luminance signal in the white direction.

SETUP: The separation in level between blanking and reference black levels. Normally 7.5 IRE.

STAIRCASE: A video test signal containing several steps at increasing luminance levels. The staircase signal is usually amplitude modulated by the subcarrier frequency and is useful for checking amplitude and phase linearities in video systems.

SYNC: An abbreviation for the words 'synchronization', 'synchronizing', etc. Applies to the synchronization signals, or timing pulses, which lock the electron beam of the picture monitors in step, both horizontally and vertically, with the electron beam of the pickup tube. The color sync signal (NTSC) is known as the color burst.

VERTICAL BLANKING INTERVAL: The blanking portion at the beginning of each field. It contains the equalizing pulses, the vertical sync pulses, and VITS (if desired). Presently 18-21 lines duration.

VERTICAL DRIVE: A pulse at field rate used in TV cameras. Its leading edge is coincident with the leading edge of the vertical blanking pulse and its duration may be 10.5 lines.

VIRS: Vertical Interval Reference Signal. A reference signal authorized by the Federal Communications Commission for use on line 19 of the vertical interval.

VITS: Vertical Interval Test Signal. A signal which may be included during the vertical blanking interval to permit inservice testing and adjustment of video transmission.

SPECIFICATIONS

TABLE 1-6
Program Control System

Characteristic	Performance Requirement
Signal Input Level	
UNITY GAIN	±0.5% of Unity Gain.
VAR	1 V P-P variable ±30%.
PROGRAM Input Impedance	75 Ω nominal.
PROGRAM Input Return Loss	
POWER ON	At least 46 dB to 5 MHz.
POWER OFF or BYPASS	At least 40 dB to 5 MHz.
Output Impedance (All)	75 Ω nominal.
Output Return Loss (All)	At least 36 dB to 5 MHz.
Output Blanking DC Level (All)	0 V ±50 mV.
Isolation	
PROGRAM to PREVIEW MON OUT	At least 46 dB to 5 MHz.
PROGRAM to PROGRAM MON OUT	At least 34 dB to 5 MHz.
Inserted Signal Amplitude	±1% of nominal input amplitude.
Amplitude Ratio	
2T Pulse to Bar	100% ±0.25% (149), 100% ±0.5% (147A).
Mod Sin ² Pulse (Chrominance + Luminance)	100% ±0.5% (149A), 100% ±1.0% (147A).
Waveform Tilt	
Field Rate Square Wave	0.5% or less.
25 μs Bar	0.5% or less.
Differential Phase (10-90 APL)	
PROGRAM OUTPUT	0.15° or less.
PREVIEW OUTPUT	0.3° or less.
Differential Gain (10-90 APL)	
PROGRAM OUTPUT	0.2% or less.
PREVIEW OUTPUT	0.4% or less.

TABLE 1-6 (cont)

Characteristic	Performance Requirement
Line Time Amplitude Non-Linearity (unmodulated staircase)	0.25% or less.
Random Noise Output Program Output	At least 75 dB (RMS) down.
Residual Subcarrier	At least 60 dB down.
Hum or Transients	At least 60 dB down.
Spurious Signals During Blanking Lines	At least 40 dB down.
External Signal Attenuation in "Delete" Mode	
2T Pulse	At least 70 dB.
Subcarrier (Color Bars)	At least 60 dB.
Crosstalk into Program Channel from Internal Signal	
2T Pulse	At least 70 dB down.
Subcarrier (Staircase)	At least 60 dB down.
Adjustment Range of Inserted Signal Blanking for use with External Sync	At least $\pm 3 \mu\text{s}$.
INSERT DELAY Range	At least $\pm 0.5 \mu\text{s}$ ($1 \mu\text{s}$ total).
Time Jitter	5 ns or less.
Unwanted Pedestal at time of VITS Insertion	0.7 IRE or less.

TABLE 1-7
Test Signals

Characteristic	Performance Requirement
FLAT FIELD Signal	
BOUNCE (10-90 APL)	Automatic bounce between 10 and 90 IRE ± 2 IRE.
RATE	Adjustable from approximately 1 second to greater than 10 seconds.
VARIABLE	0-100 IRE in 10 IRE increments, equal within 2%.
Risetime	≈ 230 ns.
Timing	See Fig. 1-9.

Operating Instructions and Specifications—147A/149A

TABLE 1-7 (cont)

Characteristic	Performance Requirement																																																	
FIELD SQUARE WAVE																																																		
Amplitude	100 IRE \pm 2 IRE.																																																	
Lines at White	Lines 57 through 227 in each field.																																																	
Lines at Blanking	All other active lines.																																																	
Risetime	230 ns \pm 15%.																																																	
Timing	See Fig. 1-9.																																																	
NOISE Signal (147A only)																																																		
Pedestal Amplitude																																																		
10 IRE	10 IRE \pm 0.2 IRE.																																																	
50 IRE	50 IRE \pm 1 IRE.																																																	
100 IRE	100 IRE \pm 2 IRE.																																																	
Variable Pedestal Range (Insertion Mode only)	\pm 10 IRE from nominal.																																																	
Noise Amplitude	-20 dB to -59 dB (0 dB = 700 mV RMS).																																																	
Noise Attenuator Accuracy	\pm 1 dB.																																																	
Noise Spectrum Bandwidth	15 kHz to 5 MHz, flat within 6 dB.																																																	
Timing	See Fig. 1-9.																																																	
COLOR TEST SIGNAL (149A only)																																																		
Luminance and Chrominance	<p>Absolute amplitudes of luminance signal, set-up, and sync are within 1% or 1.5 mV, whichever is greater, with respect to blanking.</p> <p>Absolute amplitudes of all subcarrier frequency components (B-Y, R-Y) are within 3%.</p> <p>With the red chrominance bar as an absolute reference, all other subcarrier frequency component amplitudes are within 1% or 1 mV plus the peak-to-peak residual subcarrier amplitude, whichever is greater, of their assigned values listed below.</p>																																																	
Blanking Level (With respect to ground)	0 V within 50 mV.																																																	
75% Amplitude, 7.5% Setup	<table border="1"> <thead> <tr> <th rowspan="2"></th> <th colspan="4">Millivolts</th> </tr> <tr> <th>Lum</th> <th>Chroma (P-P)</th> <th>B-Y (P-P)</th> <th>R-Y (P-P)</th> </tr> </thead> <tbody> <tr> <td>White</td> <td>714.3</td> <td>2.5 or less</td> <td>----</td> <td>----</td> </tr> <tr> <td>Yellow</td> <td>494.6</td> <td>445.1</td> <td>434.7</td> <td>95.6</td> </tr> <tr> <td>Cyan</td> <td>400.4</td> <td>625.9</td> <td>146.5</td> <td>608.5</td> </tr> <tr> <td>Green</td> <td>345.9</td> <td>588.3</td> <td>288.2</td> <td>512.9</td> </tr> <tr> <td>Magenta</td> <td>256.7</td> <td>588.3</td> <td>288.2</td> <td>512.9</td> </tr> <tr> <td>Red</td> <td>202.2</td> <td>625.9</td> <td>146.5</td> <td>608.5</td> </tr> <tr> <td>Blue</td> <td>108.1</td> <td>445.1</td> <td>434.7</td> <td>95.6</td> </tr> <tr> <td>Black</td> <td>53.6</td> <td>2.5 or less</td> <td>----</td> <td>----</td> </tr> </tbody> </table>		Millivolts				Lum	Chroma (P-P)	B-Y (P-P)	R-Y (P-P)	White	714.3	2.5 or less	----	----	Yellow	494.6	445.1	434.7	95.6	Cyan	400.4	625.9	146.5	608.5	Green	345.9	588.3	288.2	512.9	Magenta	256.7	588.3	288.2	512.9	Red	202.2	625.9	146.5	608.5	Blue	108.1	445.1	434.7	95.6	Black	53.6	2.5 or less	----	----
	Millivolts																																																	
	Lum	Chroma (P-P)	B-Y (P-P)	R-Y (P-P)																																														
White	714.3	2.5 or less	----	----																																														
Yellow	494.6	445.1	434.7	95.6																																														
Cyan	400.4	625.9	146.5	608.5																																														
Green	345.9	588.3	288.2	512.9																																														
Magenta	256.7	588.3	288.2	512.9																																														
Red	202.2	625.9	146.5	608.5																																														
Blue	108.1	445.1	434.7	95.6																																														
Black	53.6	2.5 or less	----	----																																														

TABLE 1-7 (cont)

Characteristic	Performance Requirement			
	Lum	Chroma (P-P)	B-Y (P-P)	R-Y (P-P)
Blanking Level	0	2.5 or less	-----	-----
Sync	-285.7	2.5 or less	-----	-----
Burst	0	285.7	285.7	0
Chrominance				
Time Difference Between Luminance and Chrominance	20 ns or less.			
B-Y, R-Y Quadrature Error	0.5° or less.			
R-Y Axis Phase Switcher	0.5° or less.			
Residual Subcarrier	At least 52 dB below 1 V on White, Black, (2.5 mV peak-to-peak or less).			
Aberrations	Within 4% P-P of 1 V.			
Spurious Subcarrier	At least 52 dB below 1 volt, except 30 dB at the end of H Blanking.			
Other Spurious Outputs	At least 52 dB below 1 volt, except 30 dB down during Sync and at the end of H Blanking.			
COLOR BARS				
Luminance Risetime	250 ns within 50 ns.			
Chrominance Risetime	400 ns within 15%.			
Bar Duration	8 μs each.			
Timing				
SPLIT FIELD				
Luminance Component	All active lines.			
Chrominance Component	All active lines programmed for "WINDOW" signal (lines 66-218 of each field).			
FULL FIELD				
All active lines.				
MODULATED PEDESTAL				
Pedestal				
Amplitude	50 IRE within 0.5 IRE.			
Risetime	250 ns within 50 ns.			
Tilt	0.3% or less of Pedestal Amplitude.			
Timing	See Fig. 1-9.			

Operating Instructions and Specifications—147A/149A

TABLE 1-7 (cont)

Characteristic	Performance Requirement
Chrominance Levels	
20 IRE	20 IRE peak-to-peak, within 0.1 IRE.
40 IRE	40 IRE peak-to-peak, within 0.1 IRE.
80 IRE	80 IRE peak-to-peak, within 0.1 IRE.
0 IRE	2.5 mV peak-to-peak or less.
Chrominance Phase	
Relative to Burst	90° within 1.0°.
Relative to Phase of other two levels	0° within 0.2°.
Harmonic Distortion	Less than 1%.
Risetime of Modulated Envelope	375 ns within 50 ns.
SIN² PULSE & BAR	
Modulated Pulse	
Amplitude	100% ±0.5% of Bar.
HAD (Half-Amplitude Duration)	
12.5T (Factory-Set)	1.57 μs ±75 ns.
20T (Available by jumper option)	2.5 μs ±100 ns.
Luminance Amplitude	50 IRE within 0.25 IRE.
Chrominance/Luminance Peak Amplitude Diff.	0.5% or less.
Chrominance/Luminance Delay	5 ns or less (149A), 10 ns or less (147A).
Other Perturbations on Baseline	Less than 0.5 IRE.
Harmonic Content of Subcarrier	At least 40 dB down.
Phase	
VITS Range	0° to 360°
FULL FIELD	Phase modulated at field rate.
Pulse	
Pulse-to-Bar Ratio	100% ±25%.
HAD	
2T (Factory-Set)	250 ns ±15%.
T (Available by jumper option)	125 ns ±15%.
Ringing Amplitude	0.5 IRE or less.
Ringing Duration	4 cycles or less.
Bar	
Amplitude	100 IRE ±1 IRE.
Risetime	
T (Factory-Set 147A, Available by jumper 149A)	115 ns ±15%.
2T (Factory Set 149A, Available by jumper 147A)	230 ns ±15%.
Timing	See Fig. 1-9.

TABLE 1-7 (cont)

Characteristic	Performance Requirement
WINDOW Signal	
Amplitude	Same as Bar.
Risetime	Same as Bar.
Duration	26 μ s/Line X 152 lines (lines 66 through 218).
COMPOSITE Signal	
Modulate 5-Step Staircase (Ramp available by jumper option)	
Luminance	
Amplitude	90 IRE \pm 1 IRE (adjustable \pm 10 IRE).
Riser Amplitude	1/5 of 5-Step Amplitude \pm 1%.
Risetime (All Identical)	\approx 230 ns.
Chrominance	
Phase	180°.
Amplitude	40 IRE \pm 0.5 IRE.
Inherent Differential Gain	0.5% or less.
Inherent Differential Phase	0.2° or less.
Envelope Rise and Fall Times	\approx 375 ns.
Pulse	
Pulse-to-Bar Ratio	100% \pm 0.25%.
HAD	
2T (Factory-Set)	250 ns \pm 15%.
T (Available by jumper option)	125 ns \pm 15%.
Ringing Amplitude	0.5 IRE or less.
Ringing Duration	4 cycles or less.
Modulated Sin ² Pulse	
Amplitude of Luminance Component	50 IRE \pm 1 IRE.
Amplitude Difference of Peak Chrominance to Peak Luminance	0.5 IRE or less.
Chrominance to Luminance Delay	5 ns or less.
Other Perturbations on Baseline	0.5 IRE or less.
Harmonic Distortion of Subcarrier	At least 40 dB down.
Phase	
VITS Range	0° to 360°.
FULL FIELD	Phase modulated at field rate.

Operating Instructions and Specifications—147A/149A

TABLE 1-7 (cont)

Characteristic	Performance Requirement
Bar	
Amplitude	100 IRE \pm 1 IRE.
Risetime	
T (Factory-Set 147A, Available by jumper 149A)	115 ns \pm 15%.
2T (Factory-Set 149A, Available by jumper 147A)	230 ns \pm 15%.
Timing	See Fig. 1-9.
LINEARITY Signal	
Luminance	
Staircase Signal	
Amplitude	
10 Step	90 IRE \pm 1 IRE (adjustable \pm 10 IRE).
5 Step (147A)	90 IRE \pm 1 IRE (adjustable \pm 10 IRE).
5 Step (149A)	80 IRE \pm 1 IRE (adjustable to 100 IRE).
Riser	
10 Step	1/10 of 10 Step Amplitude \pm 1%.
5 Step	1/5 of 5 Step Amplitude \pm 1%.
Risetime (All Identical)	\approx 230 ns.
RAMP Signal	
Amplitude	90 IRE \pm 1 IRE (adjustable within 10 IRE).
Linearity	Within 1%.
Chrominance	
Amplitude	40 IRE \pm 0.5 IRE.
Inherent Differential Gain	0.5% or less.
Inherent Differential Phase	0.2° or less.
Envelope Rise and Fall Times	\approx 375 ns.
Phase	180°.
Timing	See Fig. 1-9.
MULTIBURST Signal	
White Reference Amplitude	100 IRE \pm 1 IRE.
Burst Amplitude (Peak-to-Peak)	
NORMAL	90 IRE \pm 1 IRE.
REDUCED	60 IRE \pm 1 IRE.
Average Level	
NORMAL	55 IRE \pm 1 IRE.
REDUCED	40 IRE \pm 1 IRE.

TABLE 1-7 (cont)

Characteristic	Performance Requirement
Burst Frequencies	0.5 MHz \pm 3%. 1.25 MHz \pm 3% (149A). 1.5 MHz \pm 3% (147A). 2.0 MHz \pm 3%. 3.0 MHz \pm 3%. 3.58 MHz \pm 3%. 4.1 MHz \pm 2% (149A). 4.2 MHz \pm 2% (147A).
Burst Harmonic Content	At least 40 dB down.
Burst Phasing	Each burst starts and stops at 0°.
Timing	See Fig. 1-9.
VERTICAL INTERVAL REFERENCE SIGNAL (VIRS)	
Chrominance Reference	
Amplitude	40 IRE \pm 0.4 IRE.
Phase	180° (adjustable with INSERT SUBCARRIER PHASE).
Envelope Risetime	1 μ s \pm 15%.
Average Level of Chrominance Signal	70 IRE \pm 0.7 IRE.
Luminance Reference	
50 IRE Level	50 IRE \pm 0.5 IRE.
Black Reference	7.5 IRE \pm 0.5 IRE.
Timing	See Fig. 1-9.

TABLE 1-8

Full Field Output

Characteristic	Performance Requirement
Full Field Test Signal Outputs	
Amplitude Relative to Inserted Signals of Same Type	Within 1% (both outputs).
Sync Amplitude	-40 IRE \pm 1 IRE.
Sync Timing	See Fig. 1-31.
Burst Amplitude (Peak-to-Peak)	40 IRE \pm 0.5 IRE.
Burst Phase	180° \pm 1°.
Burst Timing	See Fig. 1-31.
Chrominance Subcarrier Frequency	
Free Run	3.579545 MHz \pm 25 Hz.
Locked Mode	Locked to incoming Burst or Subcarrier.
Return Loss	At least 36 dB to 5 MHz.

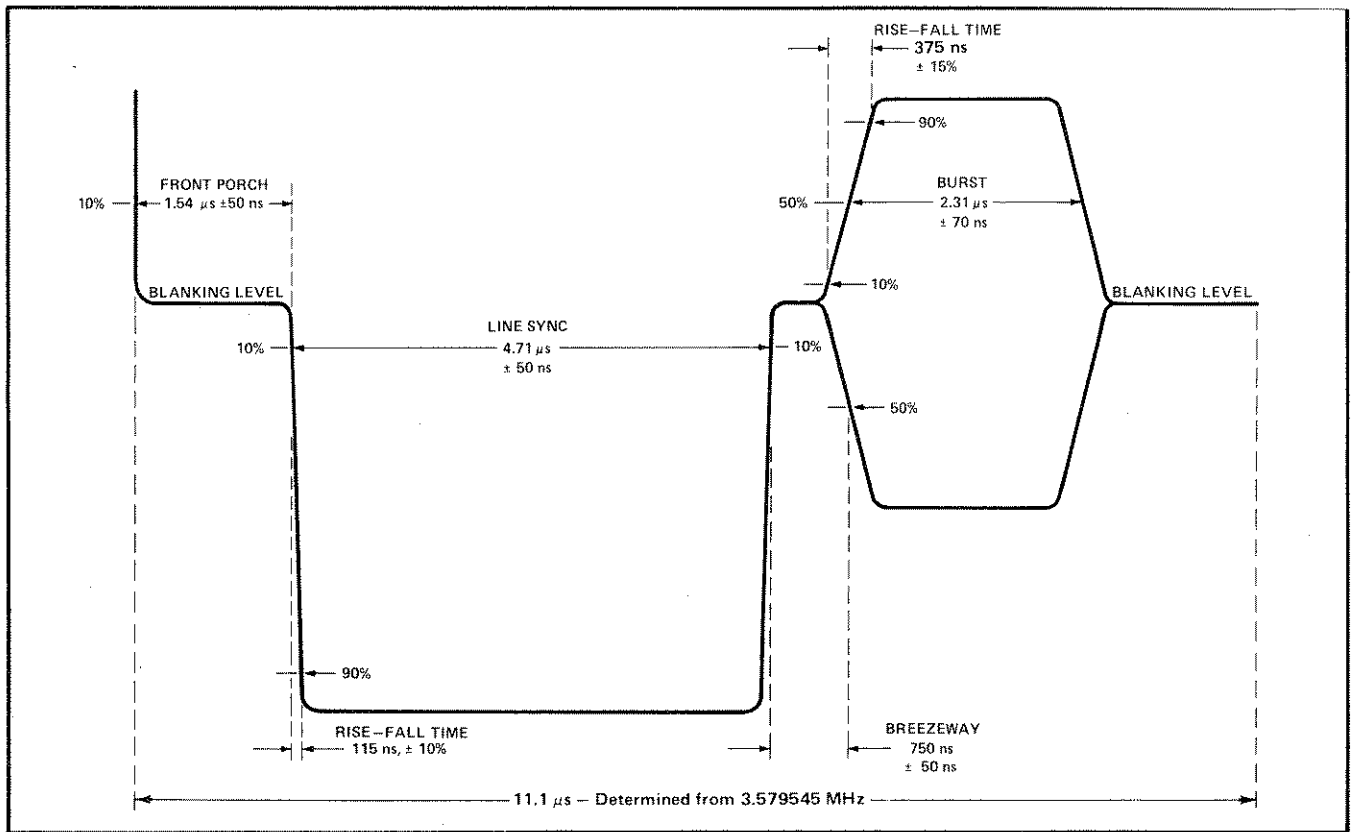

Fig. 1-31. Horizontal blanking details.

TABLE 1-9
Other Signal Outputs

Characteristic	Performance Requirement
COMPOSITE SYNC (see Fig. 1-32)	
Amplitude	4 V, Negative-going, $\pm 10\%$.
Return Loss	At least -30 dB to 3.6 MHz.
Rise and Fall Times	$115 \text{ ns} \pm 15\%$.
Line Sync Duration	$4.71 \mu\text{s} \pm 50 \text{ ns}$.
Line Period	$63.56 \mu\text{s}$.
Equalizer Pulse	
Duration	$2.33 \mu\text{s} \pm 50 \text{ ns}$.
Sequence Duration	3 lines each.
Field Sync Pulse	
Duration	$27.3 \mu\text{s} \pm 0.2 \mu\text{s}$.
Sequence Duration	3 lines.
Interval between Pulses	$4.5 \mu\text{s} \pm 0.2 \mu\text{s}$.

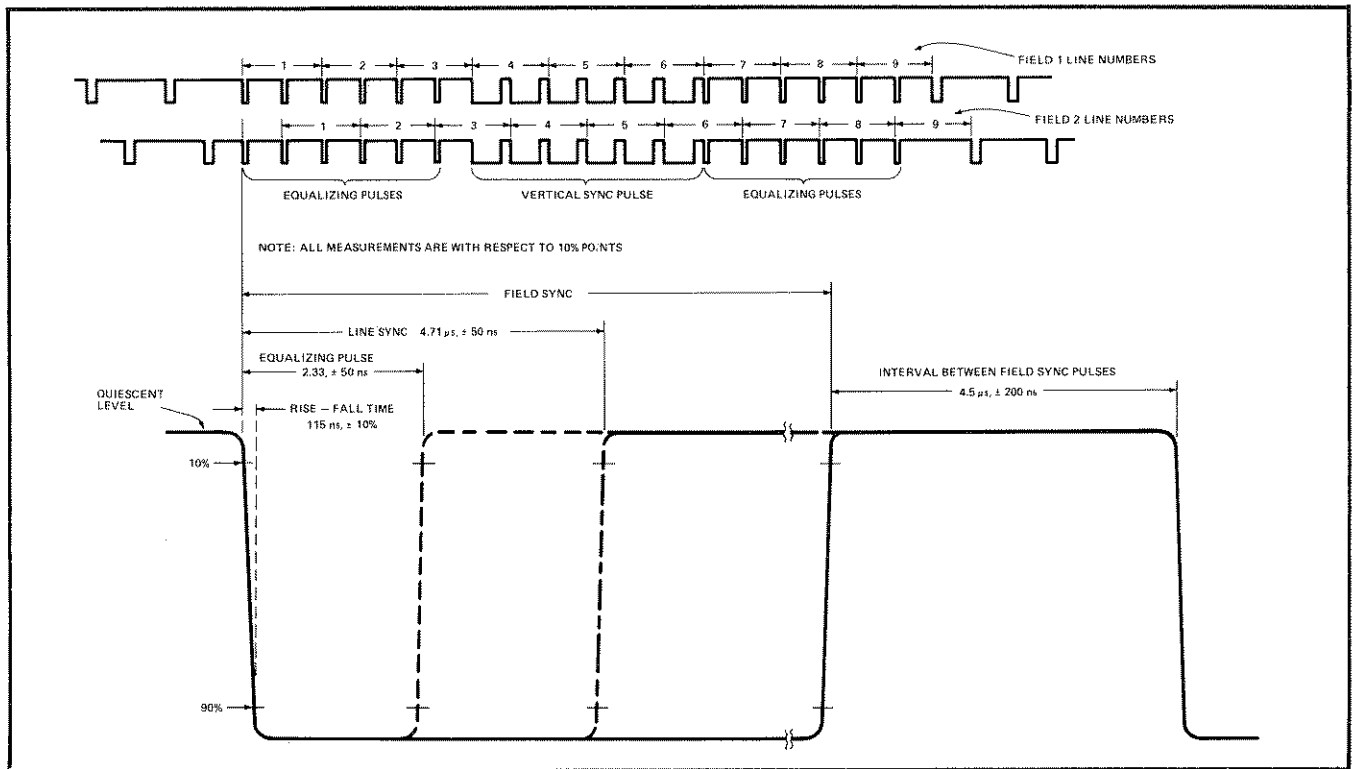

Fig. 1-32. Composite Sync details.

TABLE 1-9 (cont)

Characteristic	Performance Requirement
Field Period	262.5 lines.
Note:	COMPOSITE SYNC is disabled with a loss of incoming sync.
CW SUBCARRIER	
Amplitude	2 V P-P $\pm 10\%$ into 75 Ω .
Return Loss	At least -30 dB to 5 MHz.
Frequency	Locked to incoming burst.
Note:	CW SUBCARRIER is disabled with a loss of incoming sync or burst.
NOISE (147A only)	
Noise Amplitude	-20 dB to -59 dB (using a 4.2 MHz low-pass filter). (0 dB = 700 mV.)
Noise Attenuator Accuracy	Within 1 dB.
Noise Spectrum Bandwidth	15 kHz to 5 MHz, flat within 6 dB.
Return Loss	At least -30 dB to 5 MHz.

TABLE 1-10
Power Supply

Characteristic		Performance Requirement
Line Voltage Range		
115 Vac	Low	90 V to 110 V
	Medium	104 V to 125 V
	High	112 V to 136 V
230 Vac	Low	180 V to 220 V
	Medium	208 V to 252 V
	High	224 V to 272 V
Crest Factor		At least 1.35
Maximum Line Current		0.5 A
Maximum Power Consumption		40 W
Line Frequency Range		48 to 66 Hz

TABLE 1-11
Physical

Characteristic	Information	
	Rackmount	Bench Model
Finish	Cabinet is blue-vinyl painted. Front panel is anodized aluminum.	
Dimensions		
Overall		
Height	8.81 cm (3.47 inches)	9.7 cm (3.82 inches)
Width	48.26 cm (19.0 inches)	46.36 cm (18.225 inches)
Length	49.94 cm (19.66 inches)	48.51 cm (19.1 inches)
Cabinet		
Height	---	8.81 cm (3.47 inches)
Width	42.88 cm (16.88 inches)	43.43 cm (17.1 inches)
Length	46.76 cm (18.41 inches)	46.76 cm (18.41 inches)
Width Over Sides	44.77 cm (17.625 inches)	---
Length with BNC-T	47.24 cm (18.6 inches)	48.03 cm (18.91 inches)
Length with BNC Cable to Connector	47.42 cm (18.67 inches)	48.21 cm (18.98 inches)

ENVIRONMENTAL CHARACTERISTICS

The following environmental test limits apply when tested in accordance with the recommended test procedure. This instrument will meet the electrical performance requirements given in this section following an environmental test. Complete details on environmental test procedures, including failure criteria, etc., may be obtained from Tektronix, Inc. Contact your local Tektronix Field Office or representative.

TABLE 1-12
Environmental

Characteristic	Information
Temperature	
Non-Operating Range	-40°C to +65°C
Operating Range	0°C to +50°C
Altitude	
Non-Operating Range	To 50,000 feet
Operating Range	To 15,000 feet

ACCESSORIES

Standard accessories supplied with this instrument are listed in the Mechanical Parts List.



MAINTENANCE

This section of the manual contains information for use in maintenance of the 147A or 149A as follows.

Preventive Maintenance: Cleaning, lubrication, visual inspection, etc.

Troubleshooting: Aids for isolating trouble to a particular stage, etc.

NOTE

Maintenance and repair of the 147A and 149A should be performed or supervised by a qualified technician or engineer familiar with solid state circuitry.

PREVENTIVE MAINTENANCE

Preventive maintenance consists of cleaning, visual inspection, and lubrication. Preventive maintenance performed on a regular basis may prevent instrument breakdown, and will improve the reliability of this instrument.

Cleaning

General. The 147A or 149A should be cleaned as often as operating conditions require. Accumulation of dirt in the instrument can cause overheating and component breakdown. Dirt on components acts as an insulating blanket that prevents efficient heat dissipation. It also provides an electrical conduction path.

CAUTION

Avoid the use of chemical cleaning agents which might damage the plastics used in this instrument. Avoid chemicals which contain benzene, toluene, xylene, acetone, or similar solvents.

Exterior. Loose dirt accumulated on the outside of the instrument can be removed with a soft cloth or small paint brush. The paint brush is particularly useful for dislodging dirt on and around the front-panel controls. Dirt which remains can be removed with a soft cloth dampened in a solution of water and mild detergent. Abrasive cleaners should not be used.

Interior. Dust in the interior of the instrument should be removed occasionally due to its electrical conductivity under high-humidity conditions. The best way to clean the interior is to blow off the accumulated dust with dry, low velocity air. Remove any dirt which remains with a soft paint brush or a cloth dampened with a mild detergent and water solution. A cotton-tipped applicator is useful for cleaning in narrow spaces.

Lubrication

The reliability of switches and other moving parts can be maintained if they are kept properly lubricated. Use a cleaning-type lubricant (e.g., Tektronix Part No. 006-0172-00) for switch contacts. This lubricant does not affect the electrical characteristics of the switch. To lubricate the switch detent, use a heavier lubricant (e.g., Tektronix Part No. 006-0219-00). Do not over-lubricate.

Visual Inspection

The instrument should be inspected occasionally for such defects as broken connections, loose or disconnected pin connectors, improperly seated solid-state devices, damaged circuit boards and heat-damaged components.

The correct procedure for most defects is obvious; however, particular care must be taken if heat-damaged components are found. Overheating usually indicates other trouble in the instrument; therefore, it is important that the cause of overheating be corrected to prevent recurrence of the damage.

Transistor and Integrated Circuit Checks

Periodic checks of the transistors and integrated circuits (IC's) used in the instrument are not recommended. The best indication of performance is the actual operation of the component in the circuit. Performance of the circuit is thoroughly checked when performing either the performance check or calibration procedure. Any substandard transistors or integrated circuits will usually be detected at that time.

TROUBLESHOOTING

The following information is provided to facilitate troubleshooting of the 147A or 149A. Information contained in other sections of this manual should be used along with the following information to aid in locating the defective component. An understanding of the circuit operation is very helpful in locating troubles.

Troubleshooting Aids

Diagrams. Circuit diagrams are provided on foldout pages at the rear of this manual. Each component, its electrical value and circuit number are shown on the diagrams. In addition, typical voltages which can be expected are also shown.

Each diagram has been assigned a diagram number and name. For example, the first diagram has been assigned the number 1 and is called PROGRAM LINE AMPLIFIER. (Other circuitry exists on this diagram but, since the program line amplifier is of prime importance, it was so called.) Notice the solid blue line that surrounds most of the circuitry on this diagram. This line is used to identify a particular circuit board on which the components are physically located. This reference allows for correlation between the diagrams, circuit boards, and electrical parts list. All other components on the circuit board will be found on diagram 2.

Table 2-1 lists the various electrical numbers, circuit boards, and reference diagrams used in the 147A or 149A. All components located outside the blue line are chassis mounted components and have numbers from 9000 to 9499.

Circuit Boards. Fig. 2-1 shows the location of each circuit board within the instrument. Each circuit board is shown (full view) opposite the appropriate diagram in the Diagram section. Each electrical component on the board is identified by its circuit number. In most cases, these circuit numbers were assigned on a grid system as a convenience to the user of the instrument. For example,

notice the circuit board photo opposite diagram 1. The upper left-hand corner of this board has been assigned numbers around 500. Proceeding left to right, the numbers go towards 900 at the upper right-hand corner. From top to bottom, the numbers increase to 590 at the bottom left corner and 991 at the bottom right corner. Using this method, the physical location of each component is readily available.

TABLE 2-1

Circuit Numbers	Function or Circuit Board Name	Diagram
0-499	Subcarrier & Sync	19 (149A) & 20
500-999	VITS Insertion	1 & 2
1000-1999	Horiz and Vert Counters	3 & 4
2000-2999	Horiz Timing	5 & 6
3000-3999	APL Color Bar (149A) APL Staircase (147A)	7 & 8
4000-4999	VITS & FF Logic	9 & 10
5000-5999	Genlock	11, 12, & 13
6000-6999	Function Gen	14 & 15
7000-7999	Output Amplifier	16 & 17
8000-8999	Modulator	18 & 19 (147A)
9000-9499	Controls	22
9500-9999	Power Supply	21

Waveforms. Important waveforms (typical) are given opposite the appropriate diagram in the Diagram section. These waveforms aid in determining if a circuit is functioning properly.

Wire Color Codes. All insulated wires in the 147A or 149A are color-coded to facilitate circuit tracing. Table 2-2 summarizes the coding system used in the instrument.

NOTE

The power cord on Tektronix instruments may conform to either of the following two electrical codes:

Conductor	USA (NEC) & Canada	IEC
Line	Black	Brown
Neutral	White	Light Blue*
Safety Earth	Green w/yellow stripe	Green w/yellow stripe

*Tinned copper conductor.

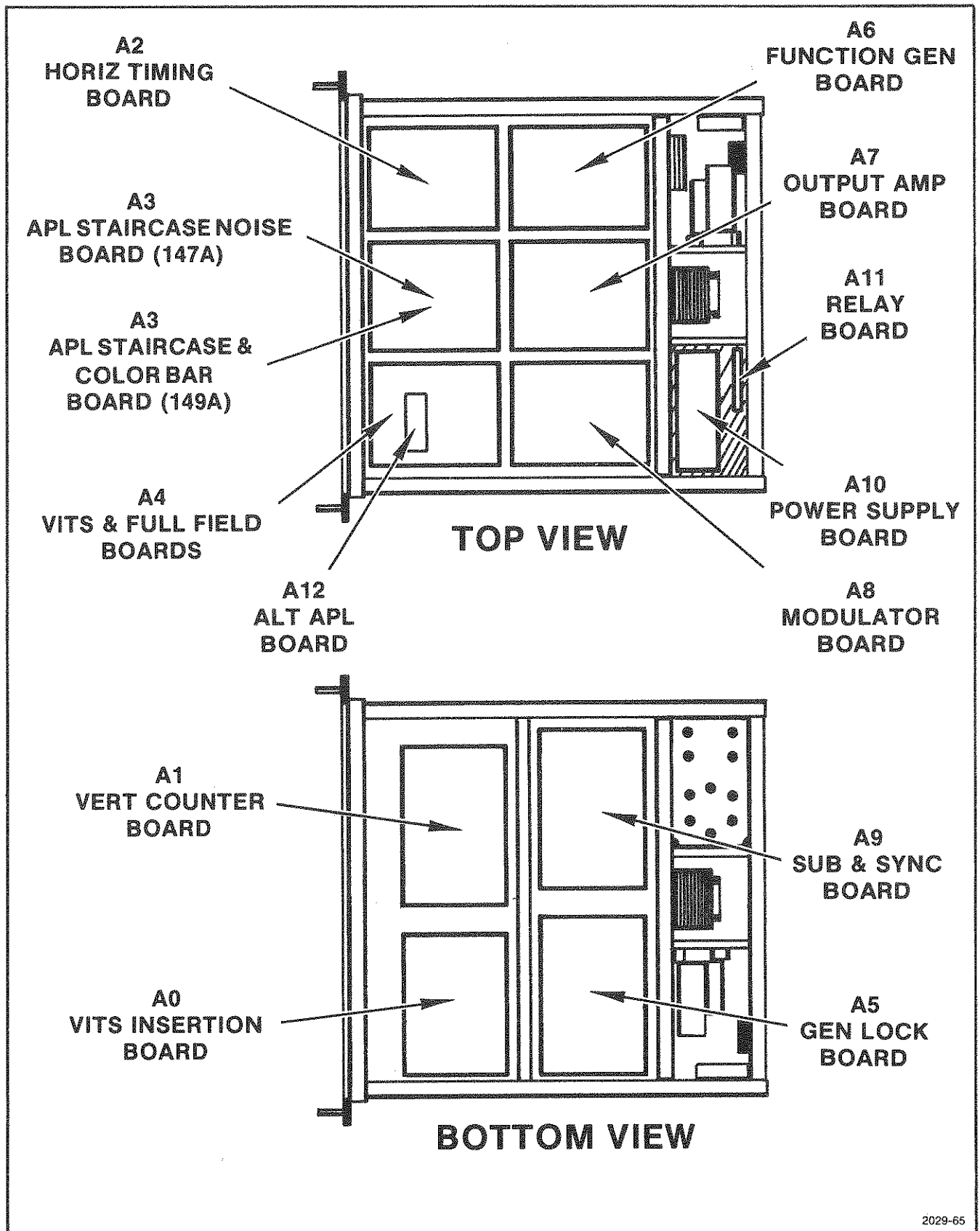

Fig. 2-1. Location of circuit boards.

CA 3046 17090

TABLE 2-2

Color Code	Significance
Black	Chassis Ground
White on Black	Floating Ground
Yellow on Green	Safety Ground
Gray ¹	AC Line
White ¹	Signal
Red ²	+V _{cc}
Violet ²	-V _{cc}

Resistor Color Code. In addition to the brown composition resistors, metal film resistors (identified by their gray or light blue color) are used in the 147A or 149A. The resistance values of composition and metal film resistors are color-coded on the components with the standard EIA color code.

Capacitor Markings. The capacitance value of a common disc capacitor or small electrolytic is marked in microfarads on the side of the component body. The white ceramic capacitors used in the instrument are color-coded in picofarads using a modified EIA code. The new "tear drop" capacitors are color-coded in microfarads using a modified EIA code, with the dot indicating both temperature and the negative (-) side.

Troubleshooting Techniques

This troubleshooting procedure is arranged in an order which checks the simple possibilities before proceeding with extensive troubleshooting.

1. Check Control Settings. Incorrect control settings can indicate trouble that does not exist. If there is any question about the correct function or operation of any control, see the Operating Instructions.

2. Check Operation of Associated Equipment. Many times malfunction of equipment can be traced to associated equipment.

3. Visual Check. Visually inspect the portion of the instrument in which the trouble is located. Look for unsoldered connections, loose pin connectors, broken wires, damaged circuit boards, damaged components, etc.

¹Color Stripes are used on these wires as an aid to circuit tracing.

²Color Stripe on wire indicates position of supply with respect to 0 volt (e.g., a black stripe on a red wire would be the first voltage in the positive direction). If a second stripe is used (white only), this indicates a non-regulated supply.

4. Check Circuit or Instrument Calibration. The apparent trouble may only be a result of misadjustment and may be corrected by calibration. Complete calibration instructions are given in this section.

5. Isolate Trouble to a Circuit. To isolate trouble to a circuit, note the trouble symptoms. The symptoms often identify the circuit in which the trouble is located. When trouble symptoms appear in more than one circuit, check affected circuits by taking voltage and waveform readings.

Incorrect operation of all circuits often indicates trouble in the power supply. Check first for correct voltage of the individual supplies. A defective component elsewhere in the circuit can also appear as a power supply trouble, and affect the operation of other circuits.

The Circuit Description section of this manual can be used as a guide for isolating a trouble. This description explains how the various signal components are combined to form the video signal. By using the front-panel controls and checking the signals at the bnc connectors, it is possible to determine circuits that are functioning properly and those that are not.

When a trouble is isolated to the smallest possible area, proceed with steps 6 through 8 in this troubleshooting procedure to locate the defective component(s).

6. Check Circuit Board Interconnections. After the trouble has been isolated to a particular area or circuit, check the pin connectors on the circuit board for correct connection.

The pin connectors used in this instrument also provide a convenient means of circuit isolation. For example, a short in a power supply can be isolated by disconnecting the power distribution pin connectors for the voltage at the Power Supply board when making resistance to ground checks.

7. Check Voltage and Waveforms. Often the defective component can be located by checking for the correct voltage or waveform in the circuit. Typical voltages and waveforms are given in the Diagrams section.

NOTE

Voltages and waveforms given on the diagrams are not absolute and may vary slightly between instruments. To obtain operating conditions similar to those used to take these readings, see the back side of the Diagrams title page.

CAUTION

Due to the component density on the circuit boards, care should be taken with meter leads and probe tips. Accidental shorts can cause abnormal voltage or transients which may destroy many components.

WARNING

"Ground lugs" are not always at ground potential. Check the diagrams before using such connections as a ground for the voltmeter test prod or oscilloscope probe. Some transistor cases may be elevated.

8. Check Individual Components. The following procedures describe methods of checking components in the 147A or 149A. Components which are soldered in place should be checked without removal, by isolating the component if circuit conditions allow. If component isolation is questionable unsolder one end.

a. **Transistors.** The best check of transistor operation is actual performance under operating conditions. If a transistor is suspected of being defective, it can best be checked by substituting a new transistor. However, be sure that circuit conditions are not such that a replacement might also be damaged. If substitute transistors are not available, use a dynamic tester such as the Tektronix Type 576.

b. **Diodes.** A diode can be checked for an open or shorted condition by measuring the resistance between terminals.

CAUTION

Do not use an ohmmeter range that has a high internal current. High current may damage some signal diodes. Never test tunnel diodes with an ohmmeter.

Repair and Readjust the circuit. If any defective component or part is located, follow the replacement procedure given in this section. Be sure to check the performance of any circuit that has been repaired or that has had any electrical components replaced.

CORRECTIVE MAINTENANCE

Corrective maintenance consists of component replacement and instrument repair. Special techniques or procedures required to replace components in this instrument are described here.

Obtaining Replacement Parts

All electrical and mechanical replacement parts for the 147A or 149A can be obtained through your local Tektronix Field Office or representative. However, many of the standard electronic components can be obtained locally in less time than is required to order from Tektronix, Inc. Before purchasing or ordering replacement parts, consult the Parts List for value, tolerance, and rating.

NOTE

When selecting replacement parts, it is important to remember that the physical size and shape of a component may affect its performance at high frequencies.

Multiple Terminal Connector Holders. Most inter-circuit connections between the circuit boards, or between the boards and chassis mounted components, are made through pin connectors. The terminals in the connector holder are identified with numbers. Connector orientation to the circuit board is keyed with triangles, one on the holder and one on the circuit board. See Fig. 2-2.

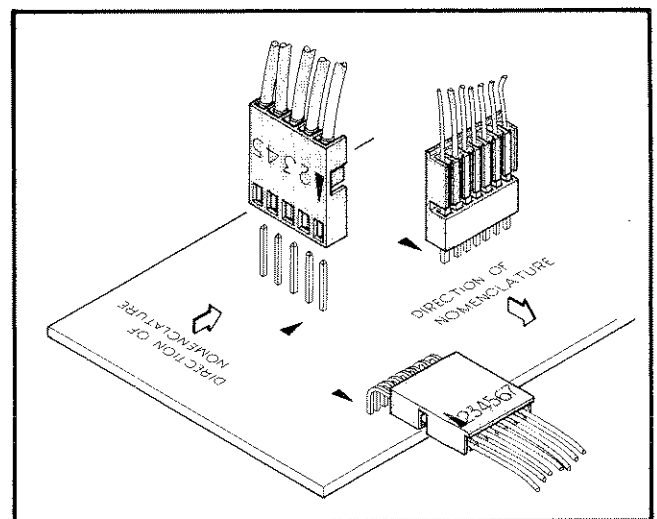

Fig. 2-2. Multipin circuit board connectors.

Circuit Boards. If the circuit board is damaged beyond repair, the entire assembly including all soldered-on components can be replaced.

Transistor and Integrated Circuit Replacement. Transistors and integrated circuits, (IC's) should not be replaced unless they are actually defective. Replacement or exchange of components may affect the calibration of the instrument. If a transistor or integrated circuit is removed during routine maintenance, return it to its original socket.

Any replacement component should be of the original type or a direct replacement. Bend the leads to fit the socket and cut the leads to the same length as on the component being replaced. See Fig. 2-3 for basing diagrams.

The chassis-mounted power supply transistors and their mounting bolts are insulated from the chassis. In addition, silicone grease is used to increase heat transfer capabilities. Re-install the insulators and replace the silicone grease when replacing these transistors. The grease should be applied to both sides of the mica insulators, and should be applied to the bottom side of the transistor where it comes in contact with the insulator.

WARNING

Voltages are present on the exterior surface of the chassis-mounted power supply transistors if applied to the instrument and the POWER switch is on.

After any component is replaced, check the operation and calibration of the associated circuits.

Indicator Lamp Replacement. To remove the POWER ON indicator lamp, remove the top dust cover from the instrument, then reach behind the front-panel and unplug the lamp from its socket. To replace the lamp, reverse the procedure.

The NONSYNCHRONOUS MODE/NO VITS, PROGRAM, PREVIEW, VIRS INCOMING, VIRS INSERT, and VIRS DELETE indicators consist of two parts: a lens that is attached to the instrument, and a lens cap (connected to the back of the lens) into which the lamps have been soldered. To remove the lamps, reach behind the front-panel, grasp the lens cap and pull straight away from the front panel. The lens cap will unsnap from the lens, allowing lamp access. Unsolder the lamp. To replace, solder the new lamp into the lens cap. Then place the lens cap on the back of the lens and apply enough pressure to snap the cap into place over the lens.

Fuse Replacement. Both line fuses are contained in plastic holders in the cover for the Line Voltage Selector Assembly at the rear of the instrument. Use only the correct value replacement fuse. Only the upper fuse within the assembly (3/4 A) is used for 115-volt operation. However, for 230-volt operation both the upper and lower fuse (1/2 A) must be installed.

Switches. If a switch is defective, replace the entire assembly. Replacement switches can be ordered by referring to the Parts List for the applicable part numbers.

Power Transformer Replacement. If the power transformer becomes defective, contact your local Tektronix Field Office or representative for replacement. Replace only with a direct replacement Tektronix transformer.

Power Input Connector and RFI Filter Replacement. The Power Input Connector and RFI Filter is replaceable as a unit and repair should not be attempted. If replacement is necessary, observe proper polarity to assure instrument protection.

The narrow blade (terminal number 4) should show continuity to terminal number 3, which connects to fuse F9201, see diagram 21. (The filter contains an internal non-replaceable fuse between these two terminals.) Use care when soldering to terminals numbers 1 and 3, as excess solder should possibly short the filter case.

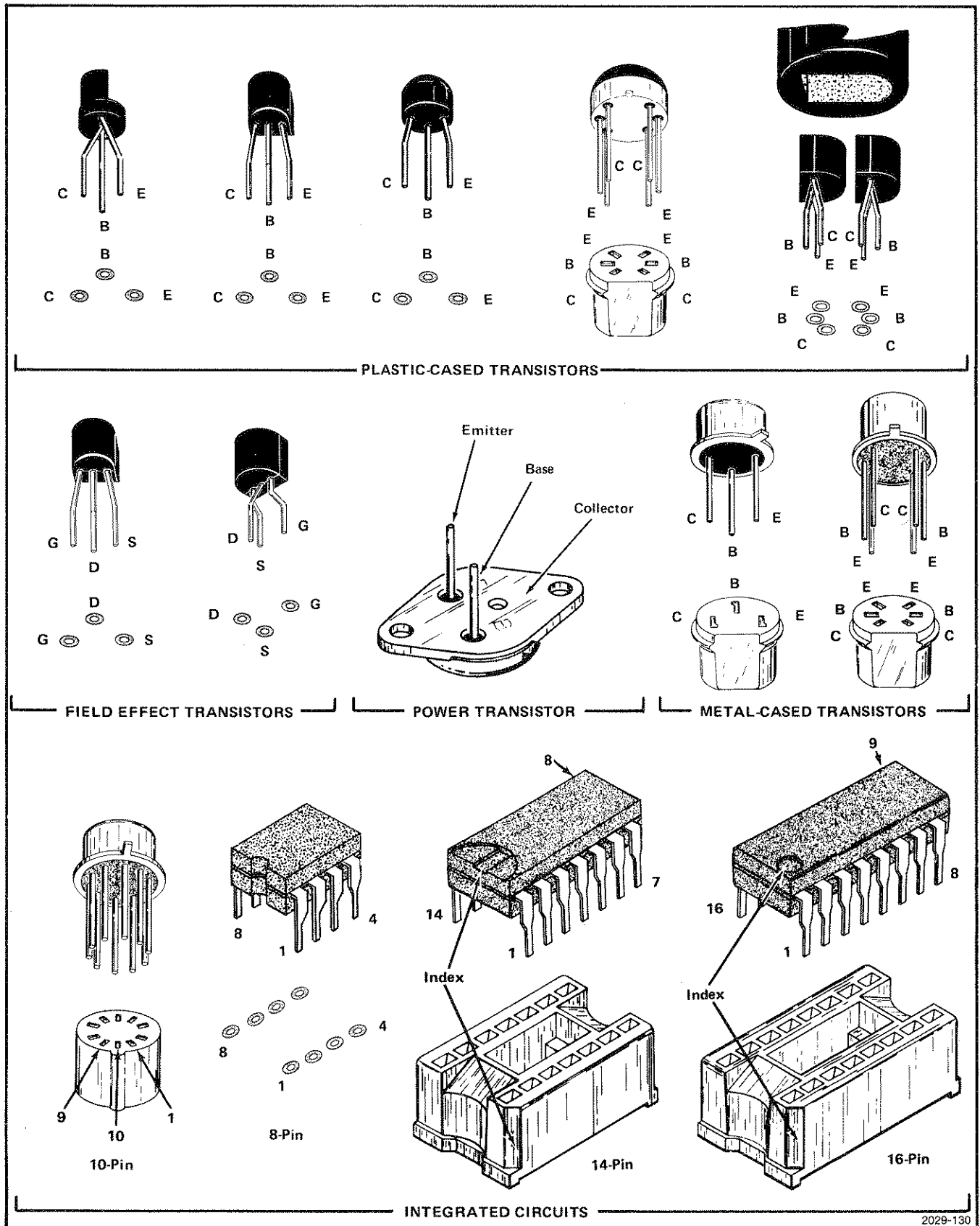

2029-130

Fig. 2-3. Transistor and Integrated Circuit basing diagrams.

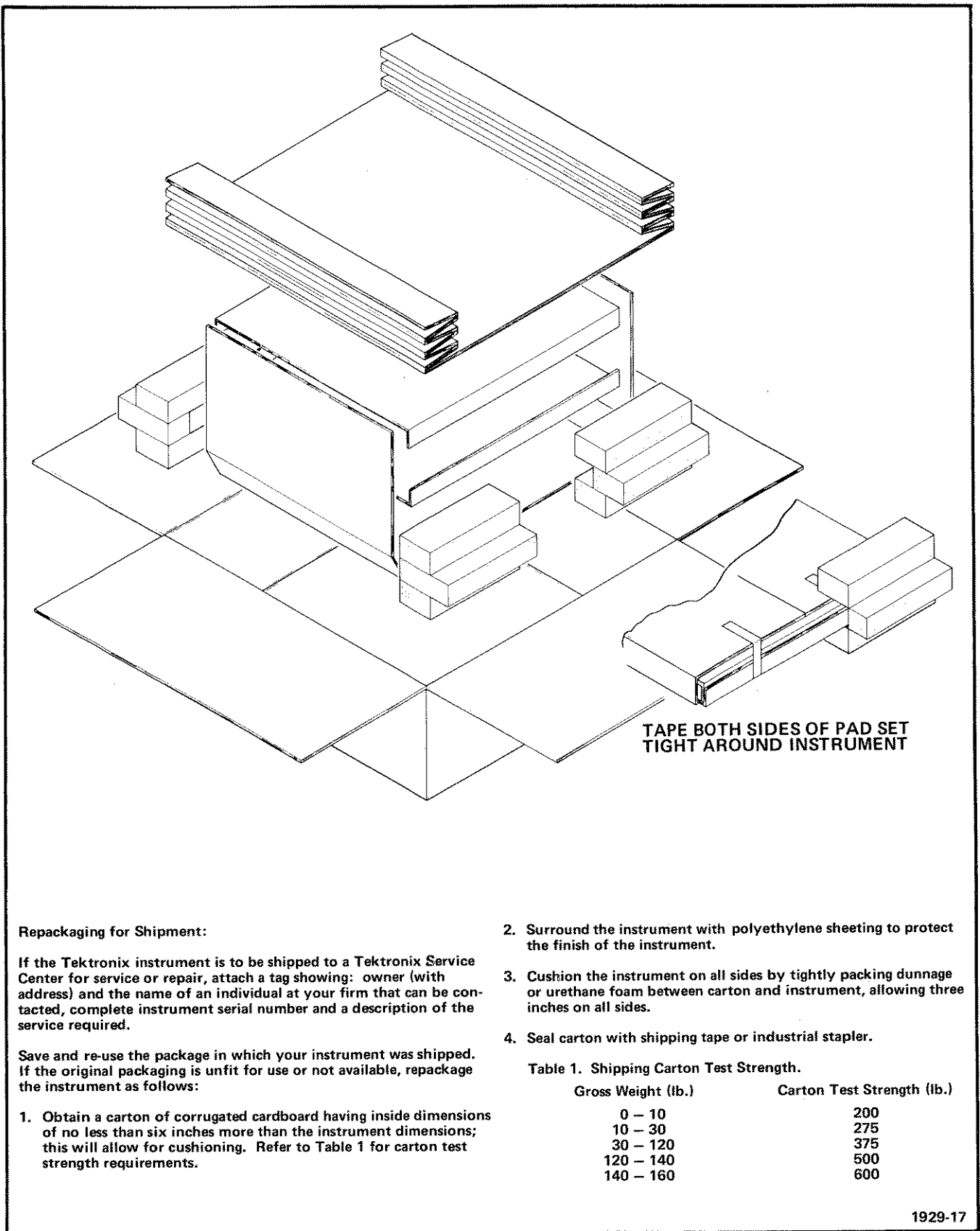

Fig. 2-4. Repackaging instructions.

CALIBRATION PROCEDURE

General

The calibration procedure is arranged in a sequence designed for calibration with minimum interaction of adjustments and reconnection of equipment. However, some adjustments affect the calibration of other circuits, and it may be necessary to check the operation of other parts of the instrument. Where adjustments interact, they are noted.

The procedure uses the equipment and fixtures listed in the Test Equipment list. If test equipment is substituted for that on the list, control settings, setups, and methods of measuring may have to be altered.

The 147A and 149A front- and rear-panel control titles and signal output connectors are capitalized (i.e., COMP SYNC). Internal adjustment titles are initial capitalized only (i.e., Subcarrier Ampl.).

Test Equipment

All test equipment is assumed to be correctly calibrated and operating within the given specifications.

1480 Option 1 Waveform Monitor

This calibration procedure uses a Tektronix 1480 Option 1 Waveform Monitor for most amplitude and timing checks and adjustments. The probe input of the Option 1 allows this waveform monitor to be used in many applications where a test oscilloscope would ordinarily be used. The NTSC graticule is calibrated in IRE units (140 IRE = 1 Volt). The graticule is divided into major divisions representing 10 IRE each at 1 Volt Full Scale, and minor divisions representing 2 IRE each at 1 Volt Full Scale. Conversion from each major and minor division into IRE/Division and mV/Division is as follows:

Volts Full Scale	IRE/Division		mV/Division	
	Major	Minor	Major	Minor
1.0	10	2	71.4	14.3
0.5	5	1	35.7	7.1
0.2	2	0.4	14.3	2.9

Timing is directly readable by the front-panel controls and the graticule horizontal timing marks. The controls read in $\mu\text{s}/\text{Div}$, meaning each major horizontal division is equal to whatever the Mag or Display switch is set to. The Mag switch will override the Display switch in $10 \mu\text{s}/\text{Div}$ and $5 \mu\text{s}/\text{Div}$.

In the 2 Field Display position, each major division is equal to 2.627 ms, and each minor division is equal to $525 \mu\text{s}$. When the Mag switch is on, the above values should be divided by the magnification power to determine the appropriate time/division.

Calibration Fixture

A calibration fixture used with the 1480 Waveform Monitor provides a variable calibrator level which can be read directly from a 10-turn dial. The schematic diagram and parts list for the fixture appear in Fig. 3-1. When S1 is in the Fixed position, the 1480 calibrator voltage is determined by the internal calibrator circuit. When S1 is in the Variable position, the calibrator voltage is determined by the circuit in the fixture.

With P9034 connected to J9034 on the 1480, and S1 in the Fixed position, calibrate the graticule for 100 IRE (714.3 mV). Set the Amplitude dial for 714.3, and S1 to Variable. Adjust R3 (Cal), to exactly match the internal 714.3 mV calibrator level. The dial is now calibrated so that each turn of the dial represents 100 mV.

Measurements

The signal to be measured must be fed to the 1480 Ch. A Input, and both the Oper and Cal buttons pushed. To check luminance amplitudes within a given tolerance, adjust the Amplitude dial while watching the waveform monitor display. When the level being measured overlays the blanking level, read the amplitude directly from the dial.

Peak-to-peak chrominance amplitudes can be checked for tolerance by adjusting the dial until the peaks of the chrominance packet being measured just meet.

To adjust a signal level, use the calibration fixture as a reference. First, set the Amplitude dial to the desired level. Then, for luminance signals, adjust the required control so the luminance level overlays the blanking level. For chrominance, adjust for the peaks to just meet.

Using The Spectrum Analyzer

Connect the 147A or 149A front-panel FULL FIELD SIG OUT to the input of a Tektronix 1401A Spectrum Analyzer (or equivalent). Connect the 1401A Video Out to the 1480 B Input. Connect the 1401A Sweep Voltage (5 V) to the 1480 External Horizontal Input (check the 1480 Instruction

CALIBRATION FIXTURE

1480 REAR PANEL

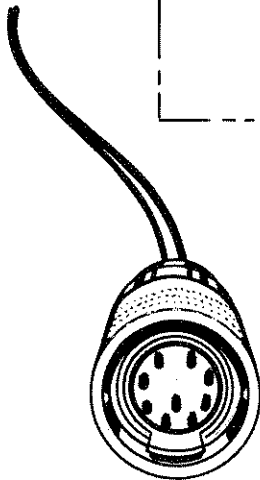
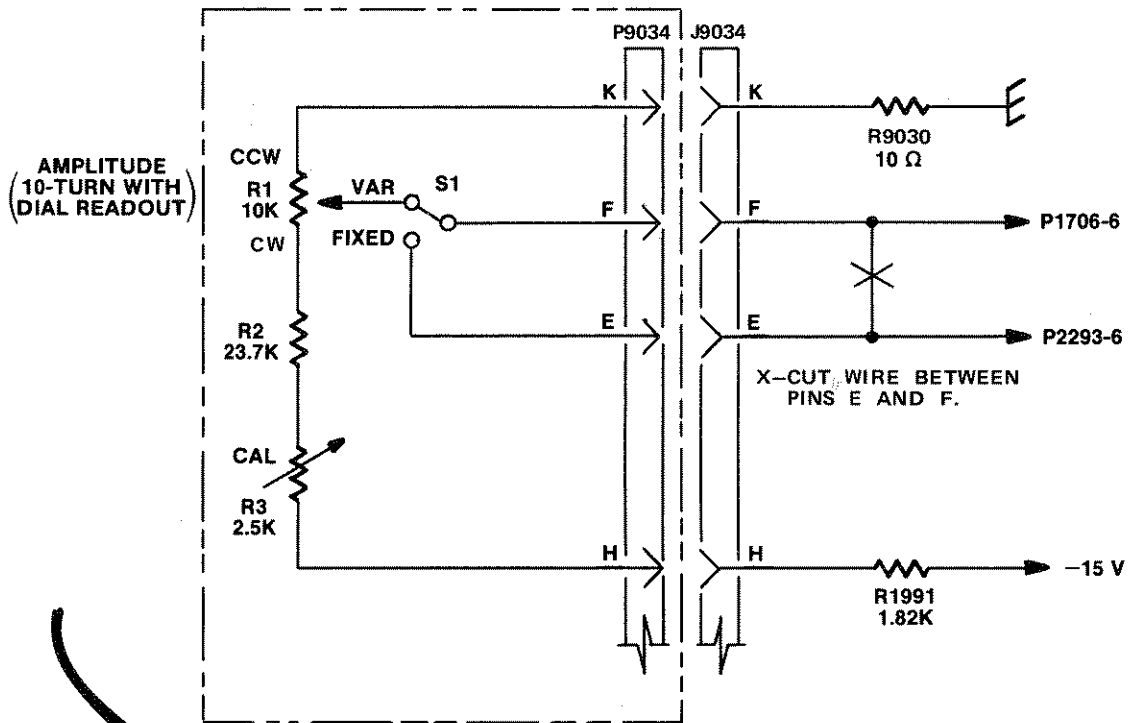

**P9034
REAR VIEW**

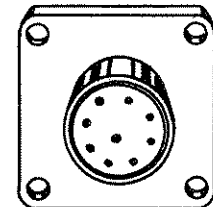

**J9034
REAR VIEW**

PARTS LIST

Ckt No.	Description	TEKTRONIX p/n
P9034	9-pin Amphenol #165-13	134-0049-00
R1	10 kΩ ±5%, Ind. Lin. ±0.1%, 10-turn 10-turn prec. var.	311-1729-00
R2	23.7 kΩ ±1%, 1/8 W, metal film	321-0325-00
R3	2.5 kΩ ±20%, Cermet var.	311-1561-00
S1	SPDT Toggle switch	260-0613-00
	10-turn dial for R1, Kilo-dial Mod. 461-S-41	331-0139-00
Misc.	Approx. 3 ft. of 4-conductor cable, small piece of Vectorboard, and a small metal or plastic enclosure or case.	

Set R1 fully counterclockwise (ccw) and the dial at 0 when installing.

2029-69

Fig. 3-1. 1480 Test Fixture schematic and parts list.

Manual for any special instructions on operating the External Horizontal function). Set the 1480 for 1.0 Volt Full Scale and Ext Display. Set up the 1401A as follows:

Power	On
RF Atten dB	20
IF Gain	ccw
Vertical Display	Log
Center Freq MHz	
1-500	000
Fine	0
Sweep Mode	Free Run
Sweep Rate	10 o'clock
Resolution kHz	100
Freq Span	
MHz/Div	.5
Var (Cal In)	pushed in
Video Filter	Off

Allow a 20 minute warmup time for the batteries to charge on the 1401A.

To determine the -40 dB point, set the 1401A RF Atten to 10 dB, and adjust the IF Gain cw until the Multiburst frequencies are of maximum amplitude. Adjust the 1480 Var Volts Full Scale for 6 major divisions of signal. Set the 1401A RF Atten to 60 dB. Position the peaks of the Multiburst frequencies to the horizontal reference graticule line on the 1480. Set the 1401A back to 20 dB. Any signal over the reference line is greater than -40 dB in amplitude.

Test Equipment for Adjustment Steps

1. Waveform Monitor. Tektronix 1480 Option 1 Waveform Monitor (SN B02960 or above). If a 1480-Series monitor is not available, a test oscilloscope with differential inputs, and the Chopped Voltage Reference listed in the optional test equipment list should be used.
2. Test Fixture for 1480. Constructed by user (see Fig. 3-1).
3. Vectorscope. Tektronix 520A NTSC Vectorscope or equivalent.
4. Video Signal Source. Signals: NTSC color bars or modulated staircase (5 steps and 140 mV subcarrier) and VITS insertion; composite sync, and subcarrier. Tektronix 140 NTSC Test Signal Generator or equivalent.
5. DC Voltmeter. Capable of measuring 5 and 15 volts within 1%. Tektronix DM 501 or equivalent.
6. Coaxial Cables (7). 75 Ω with BNC connectors. Tektronix Part No. 012-0074-00 or equivalent.

7. Terminations (3). 75 Ω end-line, with BNC connectors. Tektronix Part No. 011-0102-00 or equivalent.

8. Spectrum Analyzer. Center frequency, 0.1 MHz; resolution, 100 kHz; frequency span, at least 2 MHz/Div; RF attenuation range, capable of measuring 40 dB below the reference signal. Tektronix 1401A or equivalent.

9. RMS Voltmeter (required for 147A, optional for 149A). Must be capable of measuring -20 dB to -75 dB from 700 mV within 1 dB. Hewlett-Packard Model 3400A or equivalent.

10. Low-Pass Filter (required for 147A, optional for 149A). Noise Measurement Low-Pass Filter. $F_c = 4.2$ MHz. Tektronix Calibration Fixture 015-0212-00 or equivalent.

Optional Test Equipment

1. Variable Autotransformer. Power supply regulation. Capable of supplying at least 200 volt-amperes over the desired line voltage range. General Radio W10MT3W Metered Variac Autotransformer or equivalent.
2. Test Oscilloscope. Bandwidth, dc to at least 30 MHz; minimum deflection factor, 1 mV/division; two input channels capable of independent or differential operation; time base, at least 0.1 μ s/division and slower. Tektronix 7603 Oscilloscope with 7A13 and 7B53A plug-ins or equivalents.
3. Chopped Voltage Reference. Tektronix Calibration Fixture 067-0596-00 (chopper) or equivalent. Use with test oscilloscope if a 1480-Series Waveform Monitor is not available (carefully follow the instruction manual to determine the correct voltage being measured).
4. Sinewave Generator. Return loss and frequency response. Output of at least 500 mV; frequency range, 50 kHz reference and variable from 1 MHz to 6 MHz. Tektronix SG 503 Leveled Sinewave Generator or equivalent (signal generator).
5. Return Loss Bridge. Use with differential amplifier and signal generator. Tektronix Part No. 015-0149-00.
6. Minimum Loss Attenuator, 50 Ω to 75 Ω . Use with spectrum analyzer and signal generator. Tektronix Part No. 011-0057-00.
7. RMS Voltmeter. Capable of measuring -20 dB to -75 dB from 700 mV within 1 dB. Hewlett-Packard Model 3400A or equivalent.

Calibration Procedure—147A/149A

8. Low-Pass Filter. Program Line Out aberrations. $F_c = 5$ MHz. Tektronix Calibration Fixture 015-0213-00.

9. Noise Weighting Filter. $F_c = 5$ MHz. Tektronix Calibration Fixture 015-0215-00.

PRELIMINARY Setup

1. Install the rear-panel REMOTE plug P9014. Allow a ten minute warmup at $25^\circ\text{C} \pm 5^\circ\text{C}$ before checking or calibrating the instrument.

2. Set the 147A or 149A switches to the up position, except:

PROGRAM CONTROL	LOCAL
FULL FIELD SIG	
Selector	FLAT FIELD
Mode	NORMAL
APL	VARIABLE
VARIABLE	100 IRE
COLOR TEST SIGNAL	
(149A only)	
COLOR BARS	FULL FIELD
NOISE AND PEDESTAL	
(147A only)	
NOISE LEVEL dB	OFF

3. Connect an external 1-volt peak-to-peak composite video signal to the 147A or 149A PROGRAM LINE IN.

NOTE

Unless otherwise noted, connections made to the 147A and 149A are via a 75 Ω coaxial cable.

4. From the 147A or 149A rear-panel FULL FIELD TEST SIGNAL output connector, connect a cable to the monitor A Input; loop-through with another cable, to the vectorscope A Input; terminate the vectorscope loop-through with a 75 Ω end-line termination.

5. Connect the video signal source composite sync signal to the waveform monitor Ext Sync input; connect the loop-through, with another cable, to the vectorscope Ext Sync input; terminate the vectorscope loop-through with a 75 Ω end-line termination.

6. Connect the video signal source subcarrier to the vectorscope Ext \emptyset Ref input; terminate the vectorscope loop-through with a 75 Ω end-line termination.

GROUP 1—INITIAL

NOTE

Do not adjust the power supplies if they are within the listed tolerances. Adjustment of any supply will affect the operation of other circuits within the instrument. If a complete recalibration is being performed, set each voltage to the exact setting.

1. Check/Adjust Power Supply Voltages

Connect a precision dc voltmeter between chassis ground (pin 1 of P9834) and P9852 (-15 V), see Fig. 3-2.

CHECK—Voltage should be -15 V within 1% (-14.85 to -15.15 V).

ADJUST—R9851 (-15 Volt Adj) for -15 V.

Connect the voltmeter between chassis ground and P9832 (+15 V).

CHECK—Voltage should be +15 V within 1% (14.85 to 15.15 V).

ADJUST—R9831 (+15 Volts Adj.) for +15 V.

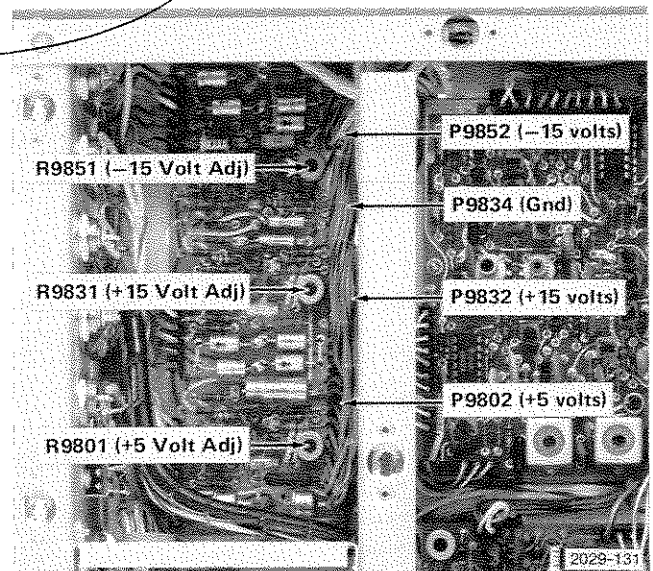

Fig. 3-2. Power Supply test point and adjustment locations.

Connect the voltmeter between chassis ground and P9082 (+5 V).

CHECK—Voltage should be +5 V within 1% (4.95 to 5.05 V).

ADJUST—R9801 (+5 Volts Adj) for +5 V.

Repeat the above adjustments to remove any interaction.

2. Check Power Supply Ripple

Use a 1X probe between the supply under test and the test oscilloscope.

CHECK—Power-line related ripple at these plugs:

Plug	Supply	Max Ripple
P9852	-15 V	10 mV
P9832	+15 V	10 mV
P9802	+5 V	10 mV

3. Check/Adjust 1 MHz Oscillator Lock

Establish a 0-volt (ground) reference point on the test oscilloscope. Connect a 10X probe to TP1720, see Fig. 3-3.

CHECK—Display dc level should be approximately +2.5 V.

ADJUST—L1670 (1 MHz Osc) to position the display midway between the two levels at which the oscillator free-runs (one level near +5 V dc and the other near 0 V dc).

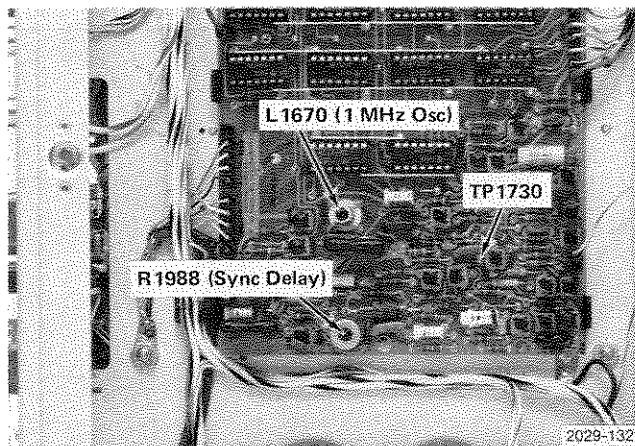

Fig. 3-3. Horizontal Counter test point and adjustment locations.

4. Check/Adjust INSERT DELAY Range

Connect the 10X probe to the back of the FULL FIELD TEST SIGNAL OUT connector. Display the full-field signal and establish a horizontal timing reference point.

CHECK—Rotation of the INSERT DELAY control, through its range, should move the display 1 μs or more.

ADJUST—INSERT DELAY control to electrical midrange.

5. Check/Adjust Subcarrier Amplitude

Display the CW SUBCARRIER OUT on the test oscilloscope.

CHECK—Subcarrier amplitude should be between 1.8 and 2.2 V peak-to-peak.

ADJUST—L190 (Subcarrier Ampl), see Fig. 3-4, for a subcarrier amplitude of 2 V peak-to-peak.

6. Check/Adjust Composite Sync

Display the COMP SYNC on the test oscilloscope.

CHECK—Composite Sync amplitude should be between 4 V and 5 V peak-to-peak.

CHECK—Aberrations on leading corner of the sync should be 4%, or less, of the total amplitude.

ADJUST—L20 and L120 (Sync Filter), see Fig. 3-4, for the best square corner on the leading edge of sync with aberrations 4% or less.

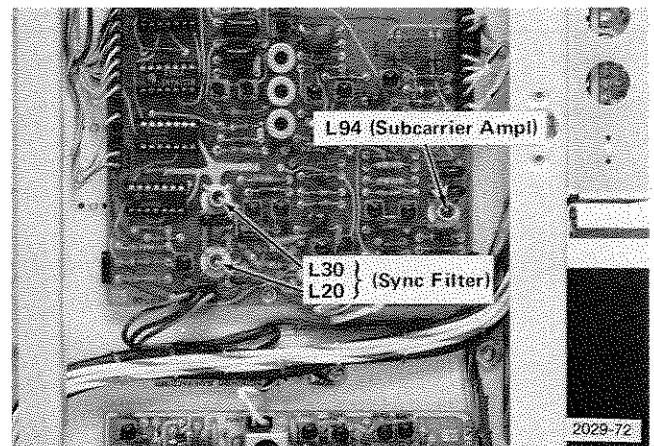

Fig. 3-4. Subcarrier & Sync filter adjustment locations.

*Page
Reference—17*

GROUP 2—OUTPUT AMPLITUDES

1. Setup

Display the rear-panel FULL FIELD TEST SIGNAL on the A Input of the 1480 Waveform Monitor. Set the Waveform Monitor for Ch. A, DC Cpl'd, 0.2 Volt Full Scale, 10 μ s/Div, Mag off, all grey pushbuttons in, except DC Restorer is Off, and Waveform Comparison Off. Position the blanking level to midscreen.

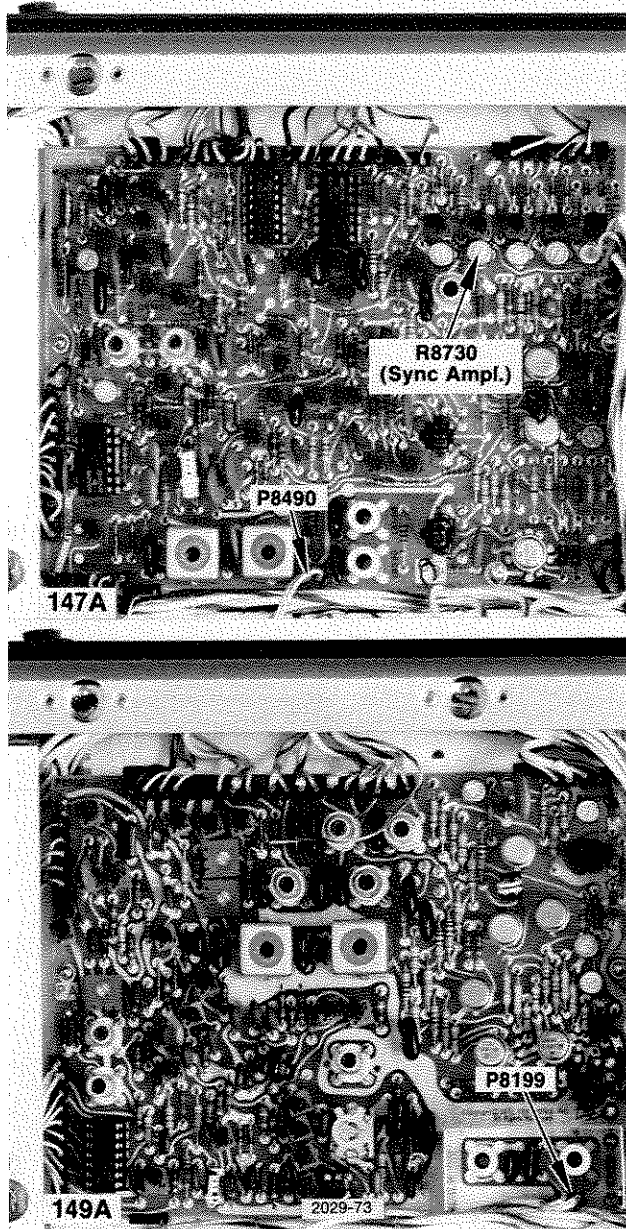

Fig. 3-5. 147A Modulator circuit board locations of P8490 and Sync Ampl. adjustment, and 149A Modulator circuit board showing the location of P8199.

Disconnect P8490 of the 147A or P8199 of the 149A (see Fig. 3-5) to remove chrominance from the signal during this part of the procedure.

Push the Back Porch DC Restorer button (714 mV Cal squarewave), and both the Oper and Cal buttons. Position the display to show the pedestal and the blanking level, overlaid. (See Fig. 3-6).

2. Check/Adjust Pedestal Amplitude

CHECK—Pedestal matches the blanking level within 2.5 minor divisions (100 IRE within 1 IRE).

ADJUST—R7735 (Reference Ampl), see Fig. 3-7, so the pedestal exactly overlays the blanking level (100 IRE).

3. Check/Adjust Sync Amplitude (147A)

Push the 1480 Sync Tip DC Restorer button (1 V Cal squarewave). Position the display to show the overlaid sync tip and pedestal (see Fig. 3-8).

CHECK—Sync and pedestal overlays within 2.5 minor divisions (-40 IRE within 1 IRE).

ADJUST—R8730 (Sync Ampl), see Fig. 3-5, so the sync and pedestal exactly overlay (-40 IRE).

Check/Adjust Sync Amplitude (149A)

Push the 1480 Sync Tip DC Restorer button (1 V Cal). Position the display to show the overlaid sync tip and pedestal (see Fig. 3-8).

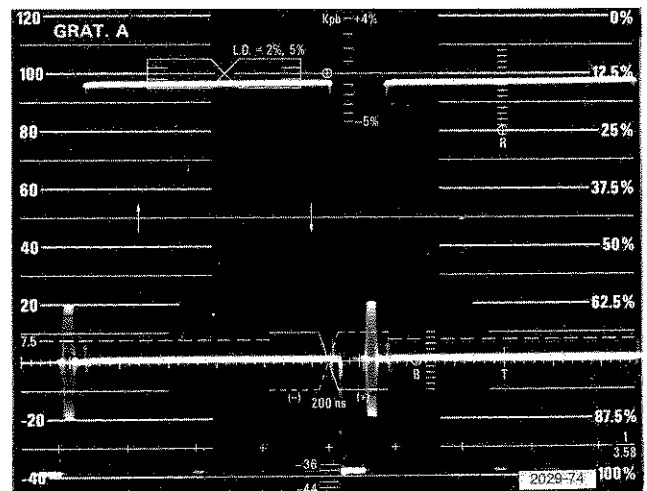

Fig. 3-6. Waveform showing 100 IRE pedestal overlaying the blanking level (signals offset 100 IRE).

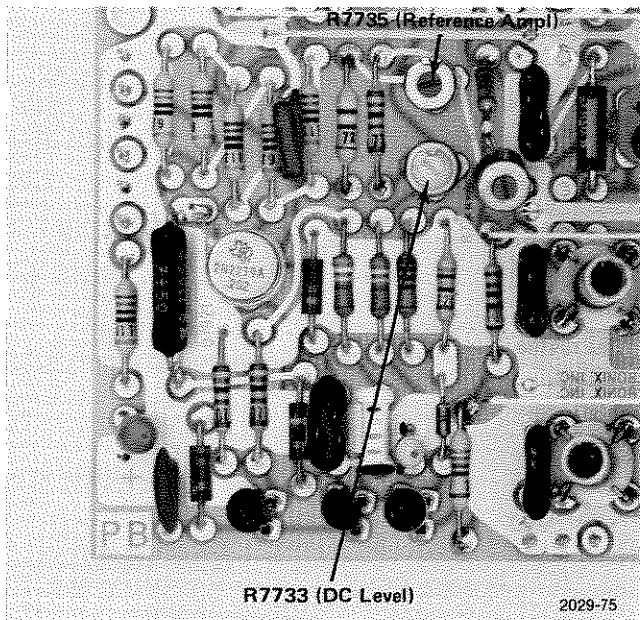

Fig. 3-7. Output Amplifier adjustment locations.

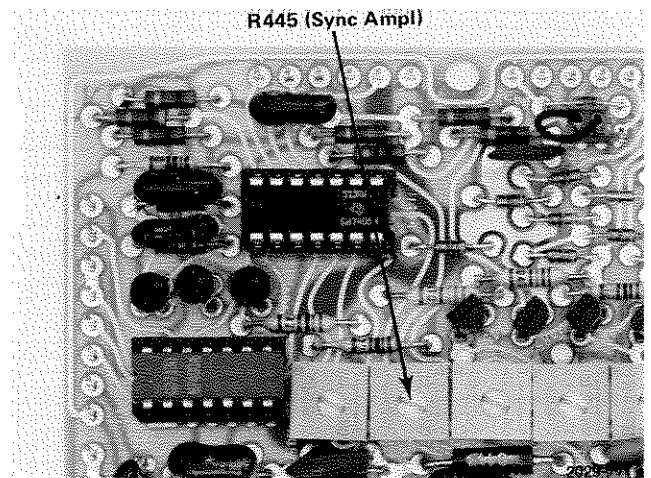

Fig. 3-9. 149A Subcarrier & Sync circuit board showing Sync Ampl. adjustment.

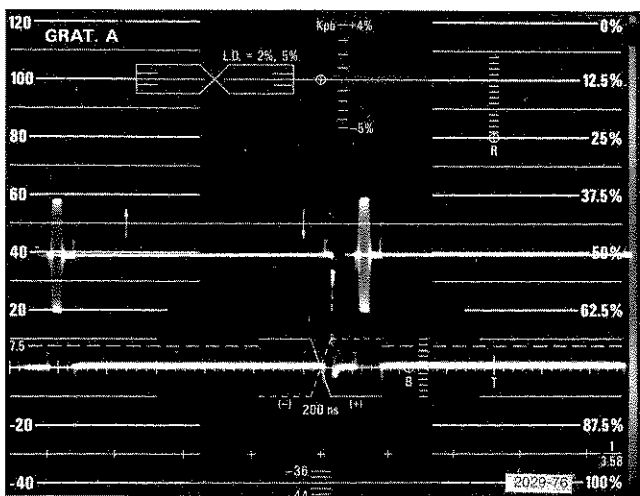

Fig. 3-8. Waveform showing Sync tip overlaying 100 IRE pedestal (140 IRE offset).

CHECK—Sync and pedestal overlay within 2.5 minor divisions (−40 IRE within 1 IRE).

ADJUST—R455 (Sync Ampl, see Fig. 3-9) so the sync and pedestal exactly overlay (−40 IRE).

4. Check/Adjust Output DC Level

Push just the 1480 Oper button. Disconnect the FULL FIELD TEST SIGNAL temporarily. Set the 1480 Vertical Position to establish a ground reference on a horizontal graticule line. Reconnect the 147A or 149A to the A Input.

CHECK—Blanking level is at the ground reference line within 3.5 major divisions (0 volt within 50 mV).

ADJUST—R7733 (DC Level, see Fig. 3-7) to position the blanking level to the ground reference line (0 volt).

5. Calibration Test Fixture (See Fig. 3-1)

Push the Back Porch DC Restorer button (714 mV Cal), and both the Oper and Cal buttons on the 1480. Set the Test Fixture Amplitude dial to 714.3 mV.

CHECK—The displayed signal does not change level when S1 is switched between Fixed and Variable.

ADJUST—R3 (Cal Adjust) on the Test Fixture so that the displayed signal level does not change when S1 is switched between Fixed and Variable.

Leave S1 set to Variable.

6. Check FULL FIELD SIGNAL Outputs

Display the front-panel FULL FIELD TEST SIGNAL OUT on the 1480 Waveform Monitor. Set the Amplitude dial to overlay the pedestal and blanking level.

CHECK—The Amplitude dial reads between 707.2 mV and 721.4 mV (100 IRE within 1 IRE).

Return the rear-panel FULL FIELD TEST SIGNAL OUT to the A Input of the 1480. Set the 1480 for 1.0 Volt Full Scale.

7. Check Full Field Signal Timing

Using Fig. 1-9 of this manual as a guide, check that each full-field signal generated by the 147A or 149A is horizontally timed as shown.

GROUP 3—LUMINANCE

1. Check FLAT FIELD VARIABLE APL Linearity

Push both the Oper and Cal buttons on the 1480. Using the 1480 Test Fixture and Table 3-1, note the amplitude of each APL pedestal and determine the difference amplitude between each increment.

CHECK—Each 10 IRE increment of the VARIABLE APL pedestal is equal in amplitude within 2% (10 IRE within 2%).

TABLE 3-1

% APL	Approx. Dial Setting	Change from Previous Setting
0	0	
10	71.4 mV	70-73 mV
20	142.9 mV	70-73 mV
30	314.3 mV	70-73 mV
40	285.7 mV	70-73 mV
50	357.1 mV	70-73 mV
60	428.6 mV	70-73 mV
70	500.0 mV	70-73 mV
80	571.4 mV	70-73 mV
90	642.9 mV	70-73 mV
100	714.3 mV	70-73 mV

2. Check BOUNCE Signal

Set the APL switch to BOUNCE 10-90, and the RATE control to maximum CW.

CHECK—BOUNCE APL changes between two levels:

Bottom level 57.1 mV to 85.7 mV (10 IRE within 2 IRE).

Top level 628.6 mV to 657.2 mV (90 IRE within 2 IRE).

Push the 1480 Oper button. Using the second hand on a watch or clock:

CHECK—BOUNCE signal changes at a rate of approximately once per second.

Set the BOUNCE RATE control to maximum CCW.

CHECK—BOUNCE switching occurs at 10 second or longer intervals.

Return the BOUNCE RATE control to maximum CW.

(149A only) Set the 1480 to a 2 Field Display rate.

CHECK—BOUNCE switching occurs at line 57.

NOTE

When P3926 pins 1 and 2 are connected on the 149A, switching occurs at random points in the field.

3. Check FIELD SQ. WAVE Test Signal

Set the FULL FIELD SIG selector switch to FIELD SQ. WAVE.

CHECK—The duration of the pedestal is from line 57 through line 227 in each field.

Set the 1480 for a 10 μ s/Div Display rate, and push both the Oper and Cal buttons.

CHECK—Pedestal amplitude is between 700.0 mV and 728.6 mV (100 IRE within 2 IRE).

4. Check NOISE Pedestal Amplitudes (147A Only)

Set the FULL FIELD SIG selector switch on the 147A to NOISE.

CHECK—Pedestal amplitudes selected by the PEDESTAL switch are as follows:

Pedestal	Amplitude
100 IRE	707.2 mV to 721.4 mV (100 IRE within 1 IRE)
50 IRE	350.0 mV to 364.3 mV (50 IRE within 1 IRE)
10 IRE	70.0 mV to 72.9 mV (10 IRE within 0.2 IRE)

Set the 147A Noise switch to INSERTION (HALF LINE).

CHECK—The VARIABLE PEDESTAL control changes the amplitude of each pedestal at least ± 10 IRE around the nominal amplitude.

Pedestal	Amplitude Range
100 IRE	642.9 mV to 785.7 mV (90 IRE to 110 IRE)
50 IRE	285.7 mV to 428.6 mV (40 IRE to 60 IRE)
10 IRE	0.0 mV to 142.9 mV (0 IRE to 20 IRE)

Return the NOISE and PEDESTAL switches to DELETION (FULL LINE) and 100 IRE PEDESTAL.

5. Check/Adjust MULTIBURST Pedestals

Set the 147A or 149A FULL FIELD SIG selector switch to MULTIBURST. Set R6938 (see Fig. 3-10) fully cw. Set the 1480 to a 2 Field Display rate.

CHECK—Horizontal and vertical blanking levels are matched.

ADJUST—R6942 (MB Sync Level, see Fig. 3-10) so the horizontal and vertical blanking levels are matched.

Set the 1480 for a 10 μ s/Div Display Rate. Push both the Oper and Cal buttons.

CHECK—The MB White Reference Flag amplitude is between 707.2 mV and 721.4 mV (100 IRE within 1 IRE).

ADJUST—R6833 (MB Pedestal Amplitude) for a MB White Reference Flag amplitude of exactly 714.3 mV (100 IRE).

CHECK—The MB center level is between 385.7 mV and 400.0 mV (55 IRE within 1 IRE).

ADJUST—R6836 (MB Center Level, see Fig. 3-10) for a MB center level of exactly 392.9 mV (55 IRE).

Set the MULTIBURST AMPLITUDE switch to REDUCED (147A) or 60 IRE (149A).

CHECK—Center level amplitude is between 278.6 mV and 292.9 mV (40 IRE within 1 IRE).

Return the MULTIBURST AMPLITUDE switch to NORMAL (147A) or FULL (149A).

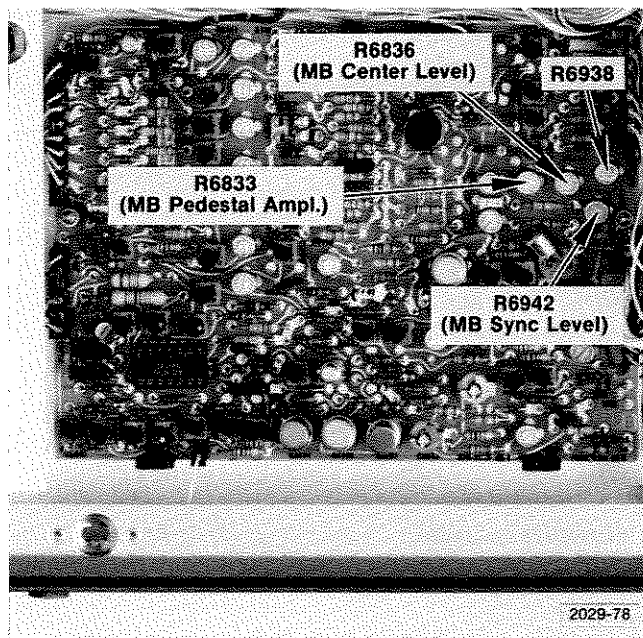

Fig. 3-10. Function Generator circuit board showing MULTIBURST luminance adjustments.

6. Check/Adjust LINEARITY Amplitudes

Set the FULL FIELD SIG selector switch to LINEARITY.

CHECK—Peak LINEARITY amplitudes are as follows:

Signal	Amplitude
LINEARITY	
RAMP	635.7 mV to 650.0 mV (90 IRE within 1 IRE)
10 STEPS	635.7 mV to 650.0 mV (90 IRE within 1 IRE)
5 STEPS (147A)	635.7 mV to 650.0 mV (90 IRE within 1 IRE)
5 STEPS (149A)	564.3 mV to 578.6 mV (80 IRE within 1 IRE)

ADJUST—Peak LINEARITY amplitudes as follows (see Fig. 3-11 for adjustment locations):

Signal	Adjust	Amplitude
LINEARITY		
RAMP	R3616 (Ramp Ampl)	642.9 mV (90 IRE)
10 STEPS	C3470 (10 Step Ampl)	642.9 mV (90 IRE)
5 STEPS (147A)	C3565 (5 Step Ampl)	642.9 mV (90 IRE)
5 STEPS (149A)	C3565 (5 Step Ampl)	571.4 mV (80 IRE)

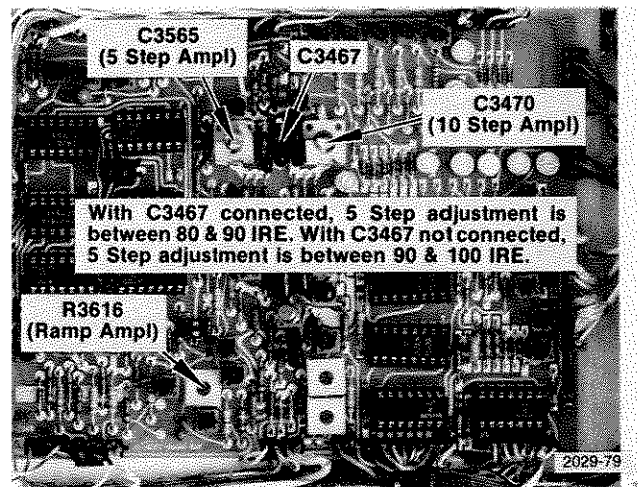

Fig. 3-11. Staircase and APL circuit board locations of LINEARITY adjustments.

Calibration Procedure—147A/149A

7. Check/Adjust Bar Amplitude

Set the FULL FIELD SIG selector switch to COMPOSITE.

CHECK—Bar amplitude at the center portion is between 707.2 mV and 721.4 mV (100 IRE within 1 IRE).

ADJUST—R7143 (Bar Amplitude), see Fig. 3-12, for the amplitude at the center portion of the Bar to be exactly 714.3 mV (100 IRE).

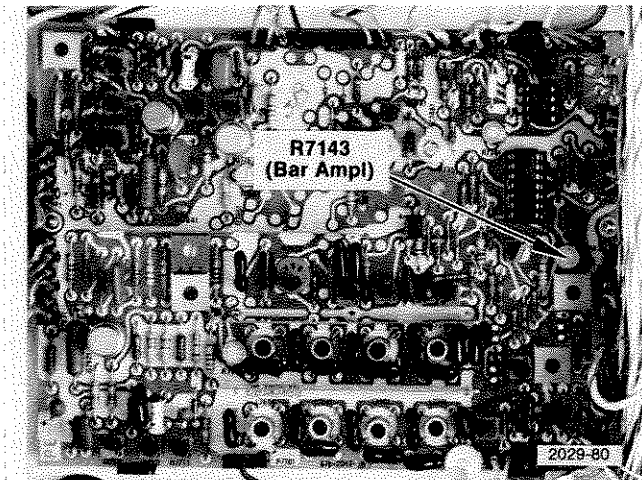

Fig. 3-12. Output Amplifier circuit board showing location of Bar adjustment.

8. Check/Adjust VIRS Luminance Amplitudes

Set the 1480 Line Selector to Line 19. Push the 1480 Dig (Digital) Line Selector button and the All Fields On button. Program the 147A or 149A to generate VIRS only on Field 1 (see Fig. 3-13). This allows the VIRS pedestals on Field 1 to be overlaid with a bright baseline at the blanking level on Field 2.

CHECK—VIRS pedestal amplitudes are as follows:

Signal Level	Amplitude
7.5 IRE	50.0 mV to 57.1 mV (7.5 IRE within 0.5 IRE)
50 IRE	353.6 mV to 360.7 mV (50 IRE within 0.5 IRE)
70 IRE	495.0 mV to 505.0 mV (70 IRE within 0.7 IRE)

ADJUST (147A)—VIRS pedestal amplitudes as follows (see Fig. 3-14 for 147A adjustment locations):

Signal Level	Adjust	Amplitude
7.5 IRE	R8830 (VIRS 7.5% Level)	53.6 mV
50 IRE	R8930 (VIRS 50% Level)	357.1 mV
70 IRE	R8835 (VIRS 70% Level)	500.0 mV

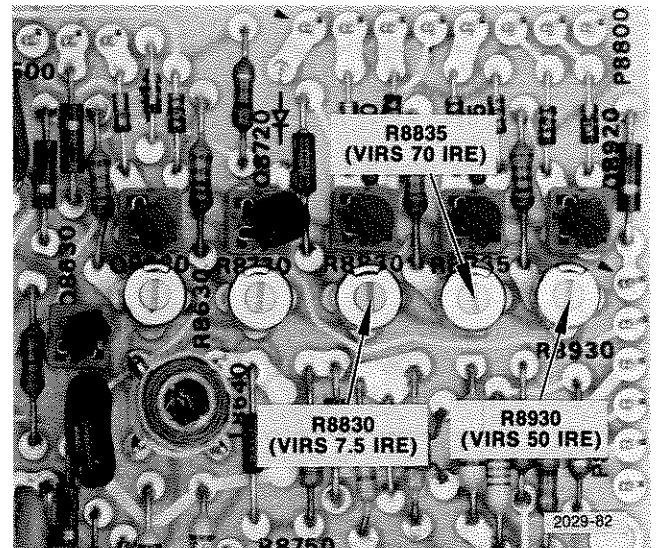
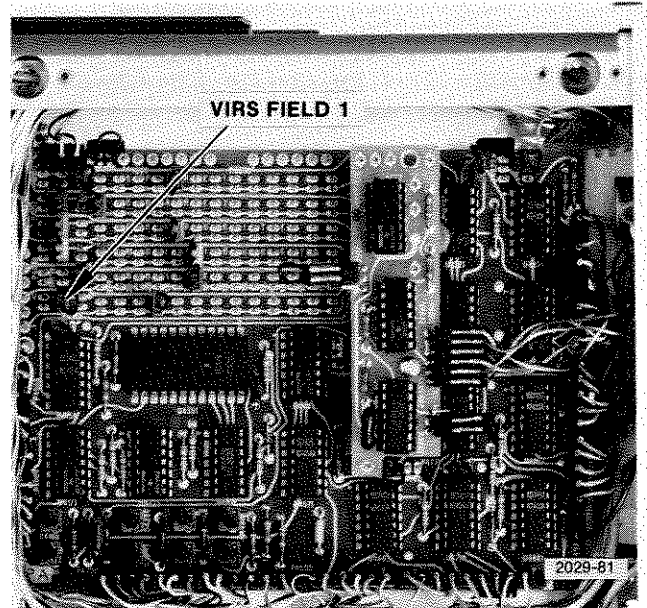

Fig. 3-14. 147A Modulator circuit board showing location of VIRS pedestal adjustments.

ADJUST(149A)—VIRS pedestal amplitudes as follows (see Fig. 3-15 for 149A adjustment locations):

Signal Level	Adjust	Amplitude
7.5 IRE	R467 (VIRS 7.5% Ped)	53.6 mV
50 IRE	R476 (VIRS 50% Ped)	357.1 mV
70 IRE	R475 (VIRS 70% Ped)	500.0 mV

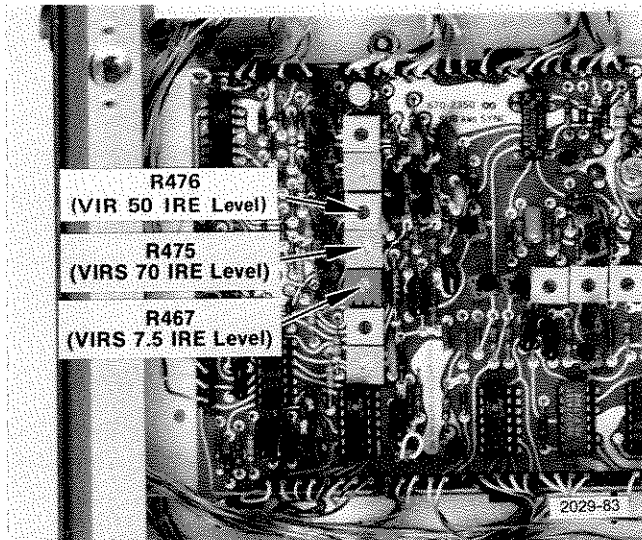

Fig. 3-15. 149A Subcarrier & Sync circuit board showing location of VIRS pedestal adjustments.

Return the 1480 Line Selector and All Fields buttons to Off. Reprogram the 147A or 149A to generate VIRS on Line 19 of Both Fields (see Fig. 3-13).

9. Check/Adjust COLOR BARS Luminance Amplitudes (149A only)

Set the 149A FULL FIELD SIG selector switch to COLOR TEST SIGNAL.

CHECK—Luminance levels are as follows:

Color Bar	Amplitude
Black	52.6 mV to 54.6 mV (53.6 mV within 1 mV)
Blue	107.0 mV to 109.2 mV (108.1 mV within 1%)
Red	200.2 mV to 204.2 mV (202.2 mV within 1%)
Magenta	254.1 mV to 259.3 mV (256.7 mV within 1%)
Green	342.4 mV to 349.4 mV (345.9 mV within 1%)
Cyan	396.2 mV to 404.4 mV (400.4 mV within 1%)
Yellow	489.7 mV to 499.5 mV (494.6 mV within 1%)
White	707.2 mV to 721.4 mV (714.3 mV within 1%)

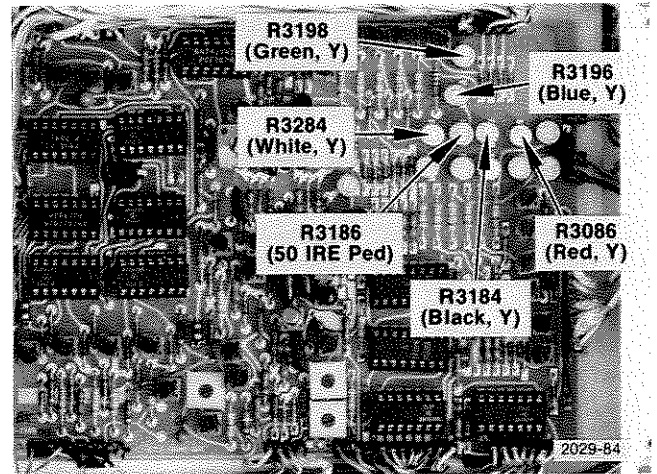

Fig. 3-16. 149A APL and Color Bar circuit board showing COLOR TEST SIGNAL luminance adjustment locations.

ADJUST—Luminance levels to the values given below; check those levels which have no adjustments (see Fig. 3-16 for adjustment locations):

Color Bar	Adjust	Amplitude
Black	R3184 (Black, Y)	53.6 mV
Blue	R3196 (Blue, Y)	108.1 mV
Red	R3086 (Red, Y)	202.2 mV
Magenta	Check	254.1 mV to 259.3 mV
Green	R3198 (Green, Y)	345.9 mV
Cyan	Check	396.4 mV to 404.4 mV
Yellow	Check	489.7 mV to 499.5 mV
White	R3284 (White, Y)	714.3 mV

10. Check/Adjust 50 IRE PEDESTAL (149A only)

Set the COLOR TEST SIGNAL switch to 50 IRE PEDESTAL.

CHECK—Pedestal amplitude is between 353.6 mV and 360.7 mV (50 IRE within 0.5 IRE).

ADJUST—R3186 (50 IRE Pedestal), see Fig. 3-16, for a 50 IRE PEDESTAL amplitude of exactly 357.1 mV (50 IRE).

Return the COLOR TEST SIGNAL switch to COLOR BARS. Push the 1480 Oper button. Reconnect P8490 on the 147A or P8199 on the 149A.

GROUP 4 (149A)—COLOR TEST SIGNAL CHROMINANCE

1. Check/Adjust Color Difference Filter Response

Set the 149A FULL FIELD SIG switch to COLOR TEST SIGNAL. Use a properly compensated 10X probe between the 1480 or the test oscilloscope and test point (TP) under test.

CHECK—Signals at the following test points should have good transient response and similar risetimes, approximately 250 ns: TP8300, TP8309, TP8330, and TP8400 (see Fig. 3-17).

ADJUST—Filters for best transient response and similar risetimes.

L8501	+(R-Y)	TP8300
L8401	-(R-Y)	TP8309
L8531	+(B-Y)	TP8330
L8431	-(B-Y)	TP8400

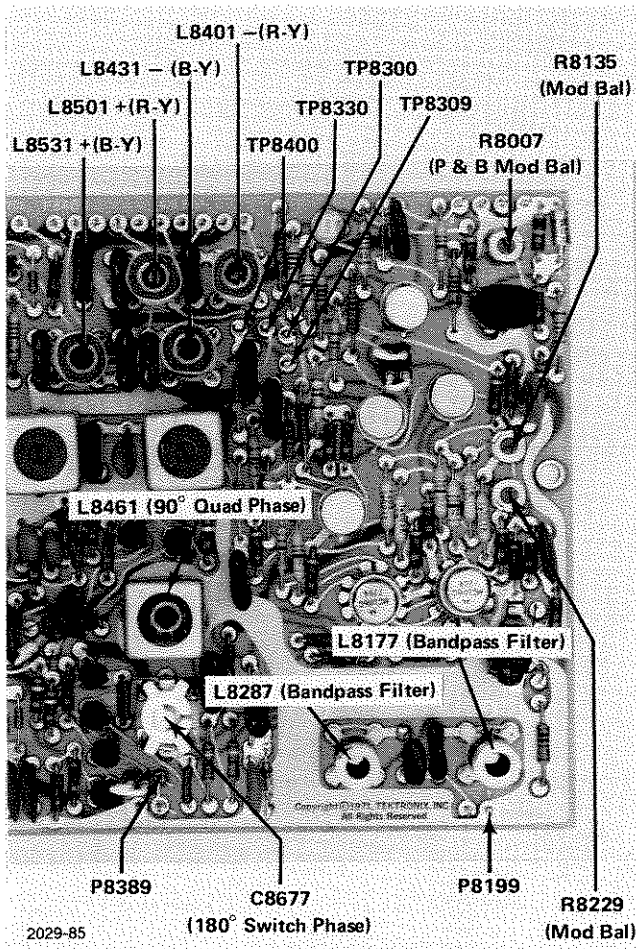

Fig. 3-17. 149A Modulator test point, plug, and adjustment location.

2. Check/Adjust Modulator Balance

CHECK—Each position of the FULL FIELD SIG switch for a modulation amplitude of 2.5 mV or less on the blanking level (0.9 minor divisions or less). If the modulation on the blanking level is acceptable, go to step 3.

Set the FULL FIELD SIG switch to FLAT FIELD.

ADJUST—R8229 and R8135 (Modulator Balance), see Fig. 3-17, for minimum residual subcarrier on the blanking level.

Set the FULL FIELD SIG switch to SIN² PULSE & BAR.

ADJUST—R8007 (P & B Modulator Balance), see Fig. 3-17, for minimum modulation on the blanking level.

3. Check/Adjust 180° Switch Phase

Set the FULL FIELD SIG switch to COLOR TEST SIGNAL. Change the connector on P8389 (see Fig. 3-17) to pins 1 and 2 (alternate). Notice that there are alternate color bar vectors on the vectorscope display.

Disconnect plug P3040 (B-Y), see Fig. 3-18. Vary the vectorscope gain to put a color bar vector on the outer graticule ring (compass rose).

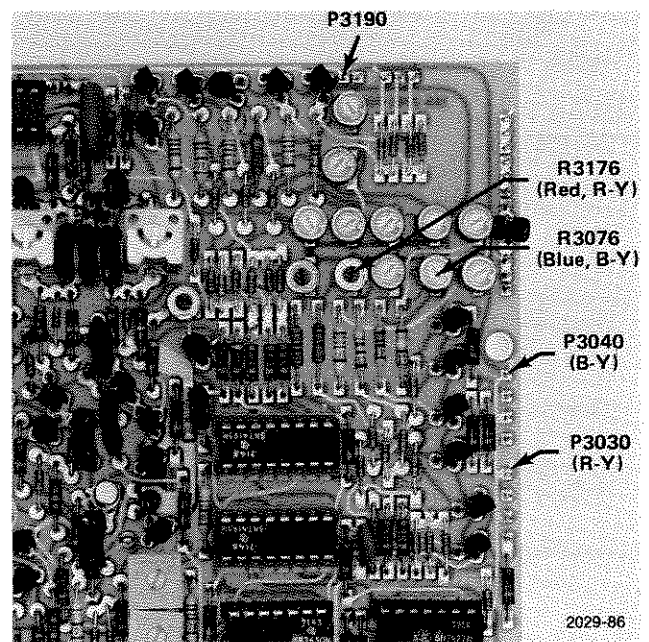

Fig. 3-18. 149A Color Bar pin connector location.

CHECK—Phase error between color bar vectors should be 0.5° or less (see Fig. 3-19).

NOTE

Fig. 3-19B shows misadjustment of the R-Y 180° Phase Switcher. Use the vectorscope calibrated phase dial to measure any error.

ADJUST—C8677 (180° Switcher Phase), see Fig. 3-17, for best overlay of color dots; overlay should be within 0.5° .

Connect Plug P3040 (B-Y) and disconnect plug P3030 (R-Y), see Fig. 3-19.

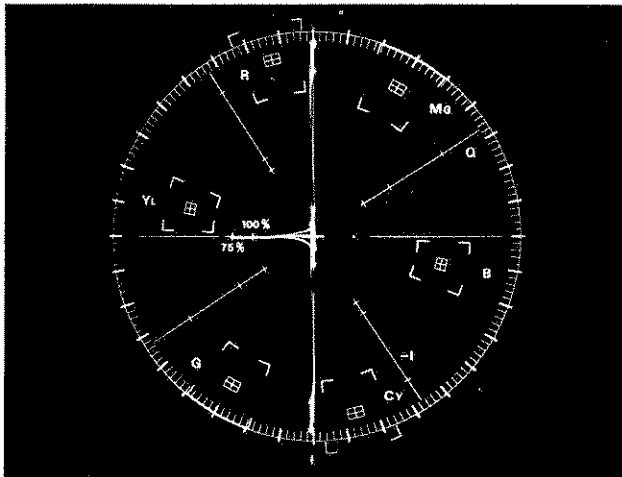

(A) R-Y 180° Phase Switcher properly adjusted.

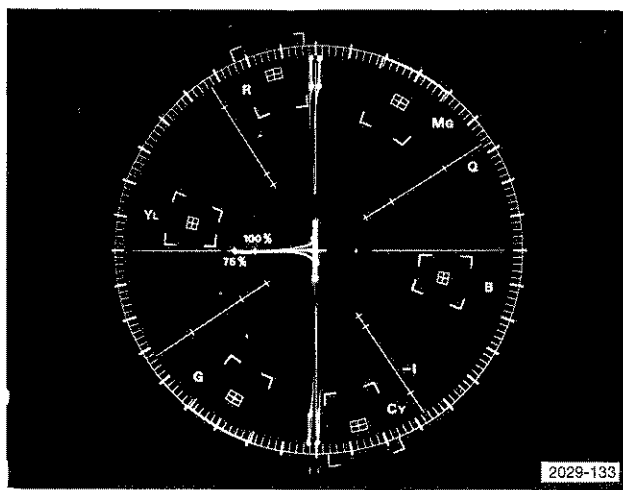

(B) R-Y 180° Phase Switcher misadjusted.

Fig. 3-19. Typical vectorscope displays used to check and/or adjust the 149A R-Y 180° Phase Switcher.

CHECK—Phase error between color dots should be 0.5° or less.

Connect plug P3030.

4. Preset Quadrature Phase

Set the waveform monitor for a 0.2 Volt Full Scale deflection factor and 3.58 MHz Bandpass Response. Position the tops of the cyan (2nd) and red (5th) color packets to the graticule center (see Fig. 3-20).

CHECK—Color bars should overlay within 10 mV (3.5 minor divisions). See Fig. 3-20B for improper overlay.

ADJUST—L8461 (90° Quad Phase), see Fig. 3-17, for best color bar overlay; should be within 10 mV (3.5 minor divisions). Recheck Modulator Balance. Return 1480 Reponse to Flat.

5. Check/Adjust Bandpass Filter Response

Disconnect P3190 (see Fig. 3-19) to remove Luminance component.

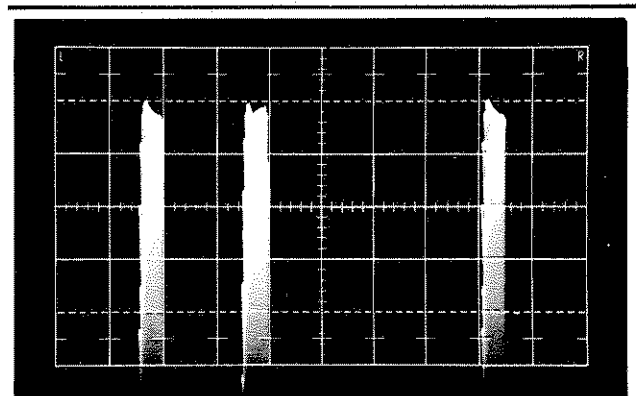

(A) Correct color bar phasing.

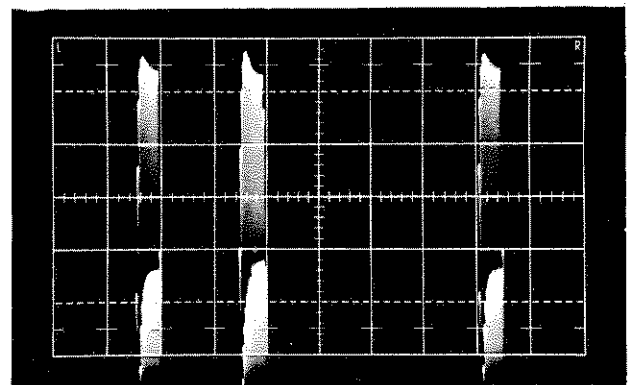

(B) Incorrect color bar phasing.

2029-134

Fig. 3-20. Typical displays showing correct and incorrect adjustment of Color Bar phasing.

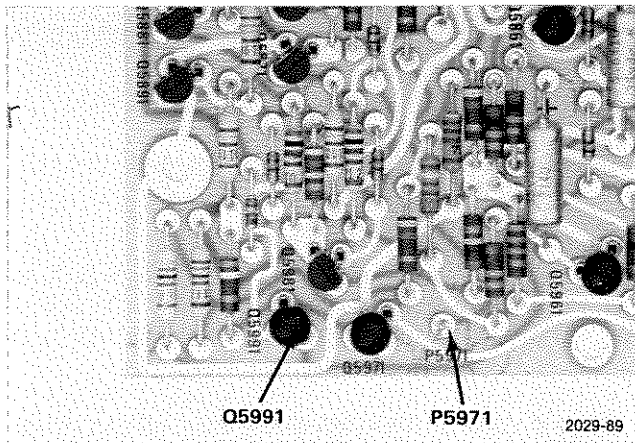
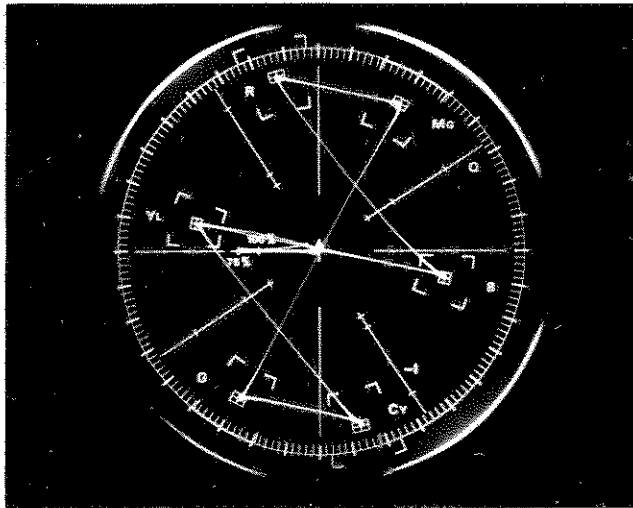
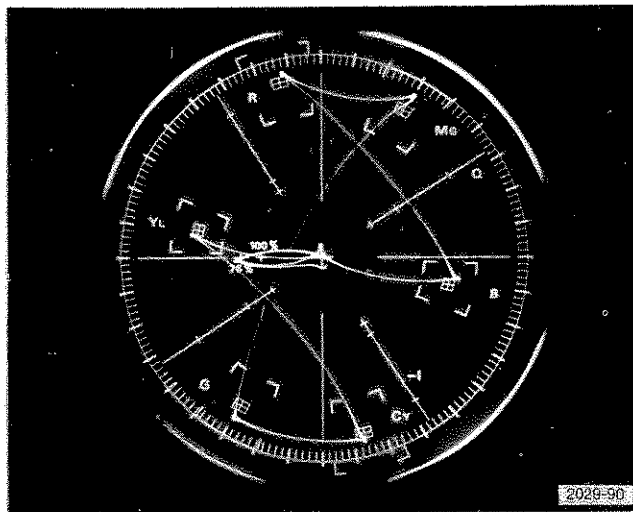

Fig. 3-21. Location of components to remove for free-running chrominance on the 149A.



A. Correctly adjusted.



B. Incorrectly adjusted.

Fig. 3-22. 149A Color filter adjustment.

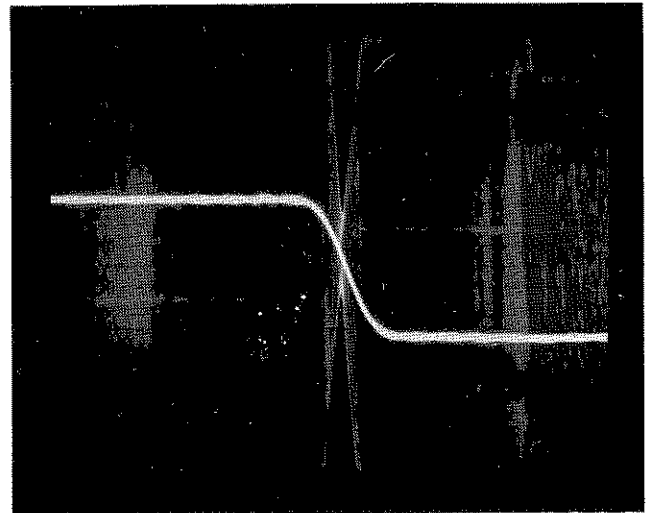

A. Improperly adjusted.

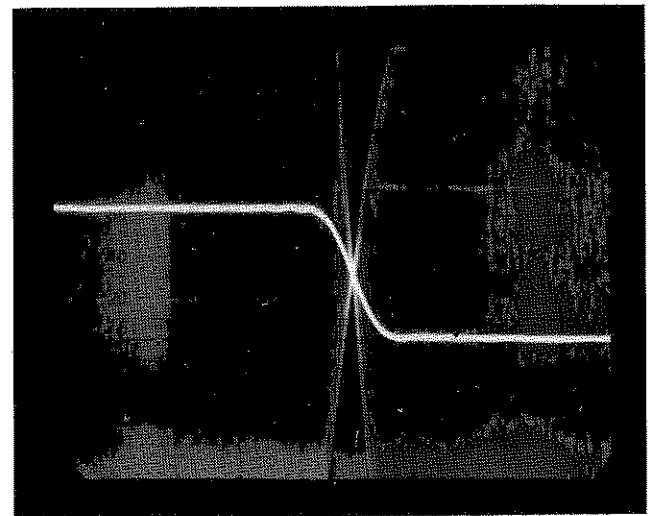

B. Properly adjusted.

2029-91

Fig. 3-23. 149A Bandpass filter response.

Set the SPLIT FIELD/FULL FIELD switch to SPLIT FIELD. Center the green to magenta transition on the monitor. (See Fig. 3-24 for location of green and magenta).

Disconnect P5971 and remove Q5991 to free-run the chrominance signal (see Fig. 3-21).

CHECK—Vectorscope display should be similar to that shown in Fig. 3-22.

CHECK—Monitor display should be similar to that shown in Fig. 3-23.

CHECK—Harmonics should be 40 dB or more below the reference signal.

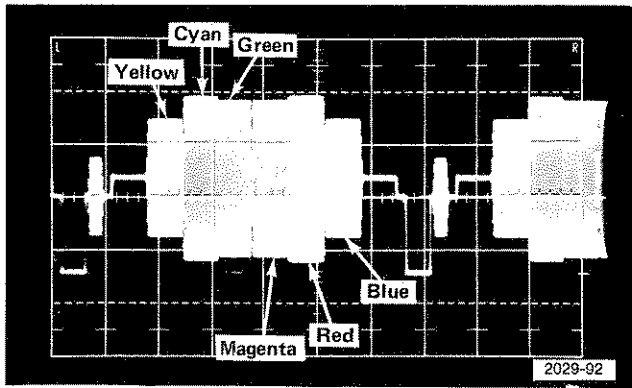

Fig. 3-24. 149A Color Bar signal components.

NOTE

The adjustments in this step affect the harmonic content of the output signal. Only slight adjustment from the original calibration should be attempted without using a spectrum analyzer.

ADJUST—L8287 and L8177 (Bandpass Filter), see Fig. 3-19, for a vector display with straight lines, and for a monitor display having a null at the crossover point.

Connect P5971 and install Q5991.

NOTE

Adjustments performed in step 2 through step 5 of this group interact. Repeat as necessary.

6. Check/Adjust Quadrature Phase

Display the FULL FIELD TEST signal on the test oscilloscope. Connect P8389, see Fig. 3-17, between pins 1 and 2 (alternate). Set the 1480 for a 0.2 Volts Full Scale deflection factor. Position the tops of the cyan (2nd) and red (5th) color packets to the graticule center, see Fig. 3-20.

CHECK—Color bars should overlay within 2 mV at tops and bottoms of the color bars (0.7 minor division).

ADJUST—L8461 (90° Quad Phase) for best color bar overlay; should be within 2 mV at tops and bottoms of the color bars.

Connect P8389 between pins 2 and 3 (normal). Set the FULL FIELD SIG switch to FLAT FIELD.

ADJUST—R8229 and R8135 (Modulator Balance), see Fig. 3-17, for minimum modulation on the blanking level at the white bar.

Set the FULL FIELD SIG switch to COLOR TEST SIGNAL.

ADJUST—R3176 (Red, R-Y) and R3076 (Blue, B-Y), see Fig. 3-19, for minimum modulation on the blanking level at the white bar.

7. Check Spurious Subcarrier Amplitude

Observe the area of the color bar signal between blue and the front porch (set up level, Black).

CHECK—Residual subcarrier should be 2.5 mV or less (0.7 minor division or less).

Observe the area of the color bar signal between the back porch and yellow (white reference).

CHECK—Residual subcarrier should be 2.5 mV or less.

Observe the starting point of the white reference portion of the signal.

CHECK—Aberration at the start of the white reference should be 32 mV or less.

8. Check Chrominance Amplitude

Push the 1480 Oper and Cal buttons. Use the test fixture to measure the chrominance amplitudes. Leave P3190 (Y) disconnected. Fig. 3-25 shows the waveform for measuring the red color bar with the 1480 test fixture.

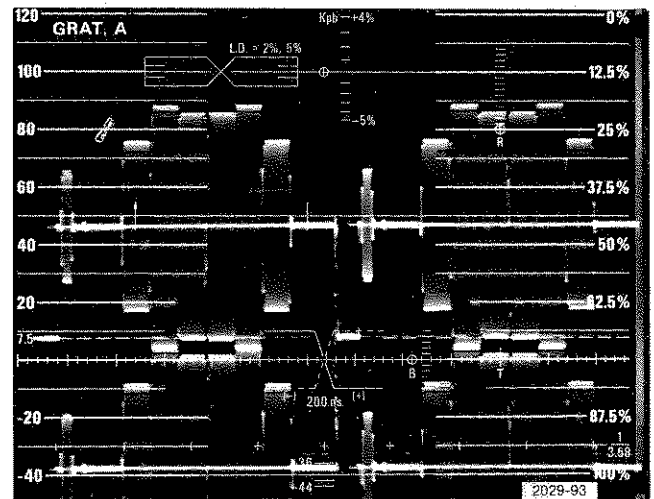

Fig. 3-25. Waveform showing 149A red color bar peaks just overlaying.

Calibration Procedure—147A/149A

CHECK—Total amplitudes within 3% as follows:

Color	Absolute Amplitude	Tolerance
Blue, Yellow	445.1 mV	431.7 - 458.5 mV
Red, Cyan	625.9 mV	607.1 - 605.9 mV
Green, Magenta	588.3 mV	570.7 - 605.9 mV
White, Black	0 mV	2.5 mV or less

Note the amplitudes measured.

CHECK—Relative amplitudes are within 1% of each other. Measure the Red color bar amplitude, and apply the result to the formula:

$$\frac{\text{Measured Value}}{\text{Standard Value}} \times 100 = \text{Red relative amplitude in \%}$$

where the standard value is the absolute value given in the table above.

EXAMPLE: Assume that the red color bar measured 632.2 mV. Applying the formula:

$$\frac{632.2 \text{ mV}}{625.9 \text{ mV}} \times 100 = 101\%$$

Note that the red color bar is 1% above the standard value.

Repeat this step for each remaining color listed in the table. All other amplitudes should be within 1% of the red relative amplitude.

EXAMPLE: Assume that the blue color bar measured 454.0 mV. Applying the formula:

$$\frac{454.0 \text{ mV}}{445.1 \text{ mV}} \times 100 = 102\%$$

Note that the blue color bar is within 1% of the red relative amplitude.

If the above requirements are met, go to step 12. If the above requirements are not met, steps 9, 10 and 11 must be performed.

9. Check/Adjust R-Y Chrominance Amplitudes

Disconnect P3040 (B-Y). Preset R3274 (Blue) to midrange. Leave P3190 (Y) disconnected. (See Fig. 3-26 for location of adjustments and connectors).

CHECK—R-Y chrominance amplitudes are within 1% or 1 mV, whichever is greater, as follows:

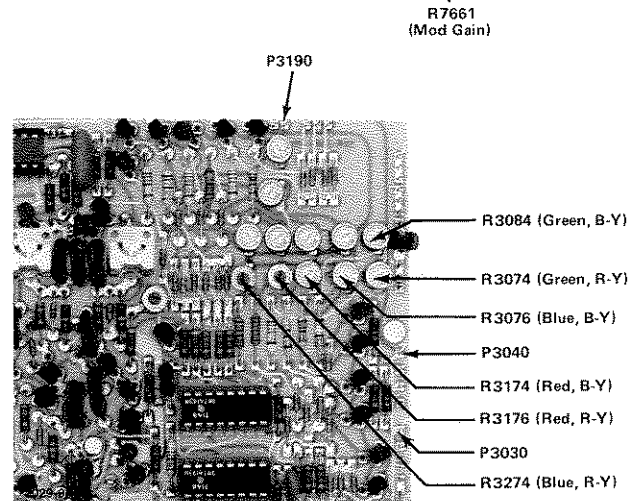
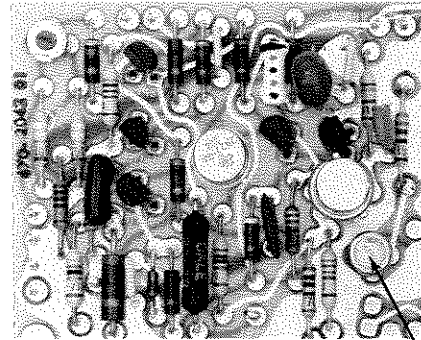

Fig. 3-26. 149A Color Bar pin connector and adjustment locations.

Color	P-P Amplitude	Tolerance
Red, Cyan	608.5 mV	602.4 - 614.6 mV
Blue, Yellow	95.6 mV	94.6 - 96.6 mV
Green, Magenta	512.9 mV	507.8 - 518.0 mV

ADJUST—R-Y chrominance amplitudes as follows:

Adjust	Color	Amplitude
R7661 (Mod Gain)	Blue	95.6 mV
R3074 (Green, R-Y)	Green	512.9 mV
R3176 (Red, R-Y)	adjust for modulation null on white bar	
check	Red	602.4 - 614.6 mV
check	Cyan	602.4 - 614.6 mV
check	Magenta	507.8 - 518.0 mV
check	Yellow	94.6 - 96.6 mV

Connect plug P3040.

10. Check/Adjust B-Y chrominance amplitudes

Disconnect P3030 (R-Y). (See Fig. 3-26 for location of adjustments and connectors.)

CHECK—B-Y chrominance amplitudes as follows:

Color	P-P Amplitude	Tolerance
Red, Cyan	146.5 mV	145.0 - 148.0 mV
Blue, Yellow	434.7 mV	430.6 - 439.0 mV
Green, Magenta	288.2 mV	285.3 - 291.1 mV

ADJUST—B-Y chrominance amplitudes as follows:

Adjust	Color	P-P Amplitude
R3174 (Red, R-Y)	Red	146.5 mV
R3084 (Green, R-Y)	Green	288.2 mV
R3076 (Blue, R-Y)	adjust for modulation null on white bar	
check	Blue	430.4 - 439.0 mV
check	Yellow	430.4 - 439.0 mV
check	Magenta	285.3 - 291.1 mV
check	Cyan	145.0 - 148.0 mV

Connect P3030.

11. Check Total Chrominance Amplitudes

Repeat step 8.

12. Check/Adjust Modulated Pedestal Chrominance

Set the COLOR BARS/MODULATED PEDESTAL/50 IRE PEDESTAL switch to MODULATED PEDESTAL. Leave P3190 (Y) disconnected.

CHECK—Modulated pedestal chrominance within 0.1 IRE as follows:

Pedestal	Amplitude	Tolerance
20 IRE	142.9 mV	142.1 - 143.6 mV
40 IRE	285.7 mV	285.0 - 286.4 mV
80 IRE	571.4 mV	570.7 - 572.2 mV

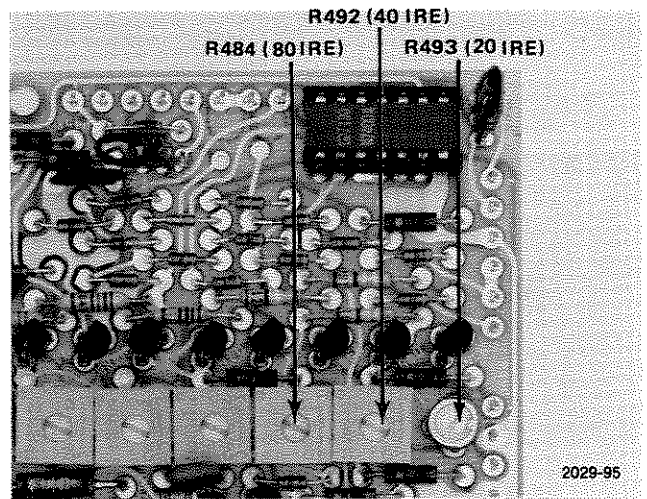

Fig. 3-27. 149A Modulated Pedestal chrominance adjustment locations.

ADJUST—Modulated pedestal chrominance as follows. See Fig. 3-27 for adjustment location.

Adjust	Amplitude
R493 (20 IRE)	142.9 mV
R492 (40 IRE)	285.7 mV
R485 (80 IRE)	571.4 mV

Connect P3190.

13. Check SPLIT FIELD Sequence

Display the rear-panel FULL FIELD TEST signal on the monitor.

Check—The SPLIT FIELD signal should start with luminance, switch to a half field of chrominance, then switch back to luminance.

14. Check MODULATED PEDESTAL Phase

Set the COLOR TEST SIGNAL switch to MODULATED PEDESTAL.

CHECK—Chroma-to-burst phase as displayed on the vectorscope should be 90° within 1°.

CHECK—Phase error between the different chrominance levels should be 0.2° or less.

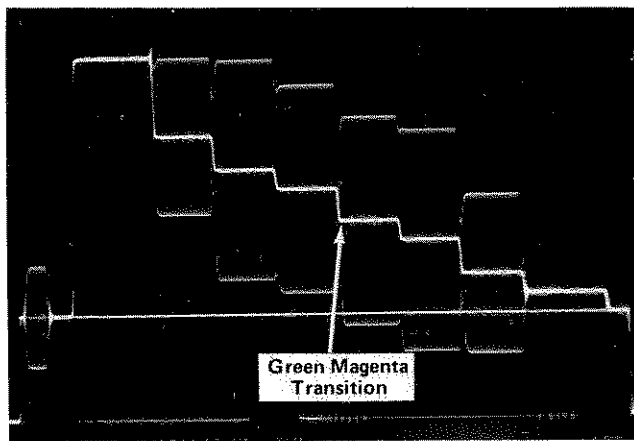

A. Color bar component location.

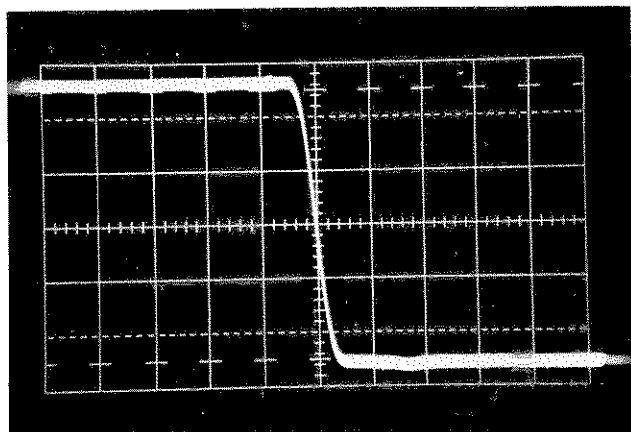

B. Properly centered luminance display.

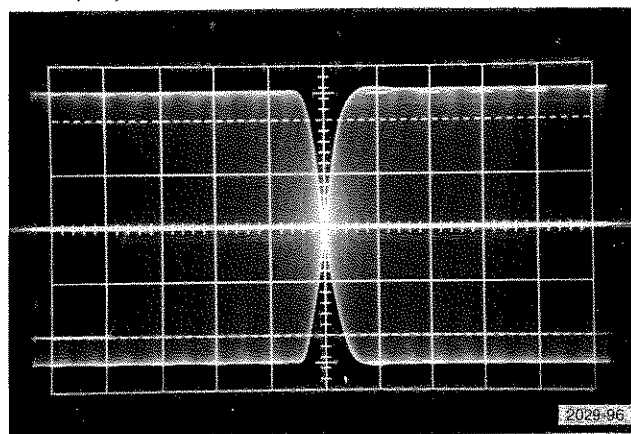

C. Properly centered chrominance display.

Fig. 3-28. Typical displays to check or adjust luminance to chrominance delay.

15. Check/Adjust Luminance-to-Chrominance Delay

Set the COLOR TEST SIGNAL switch to COLOR BARS. Display the front-panel FULL FIELD SIG OUT signal on the test oscilloscope. Set the waveform monitor to display the green, magenta cross-over point (see Fig. 3-28A).

Disconnect plug P5971 and remove Q5991 (see Fig. 3-21).

Set the waveform monitor vertical gain and positioning controls so that the luminance component is 4 to 5 divisions high and exactly centered vertically (see Fig. 3-28B).

CHECK—Luminance transition crosses through the chrominance null at the 50% amplitude point (crt center) within 20 ns (see Fig. 3-28C for chrominance null).

ADJUST—R3369 (Delay), see Fig. 3-29, for matching luminance to chrominance, within 20 ns.

16. Check Chrominance Envelope Risettime

Disconnect plug P3190 (Y), see Fig. 3-26.

CHECK—Yellow (1st) chrominance envelope risetime should be between 323 and 431 ns.

Connect plug P5971 and install Q5991.

17. Check Modulated Pedestal Duration

Set the COLOR TEST SIGNAL switch to MODULATED PEDESTAL.

CHECK—Modulated pedestal duration as given below:

20 IRE modulation	13 μ s wide
40 IRE modulation	13 μ s wide
80 IRE modulation	13 μ s wide

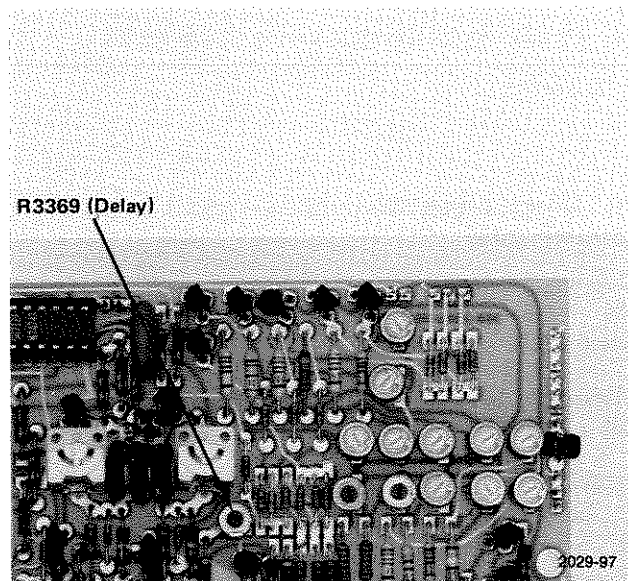

Fig. 3-29. Location of Color Bar delay adjustment.

GROUP 5 (147A)—MODULATED PULSE

1. Check/Adjust Modulator Balance (FLAT FIELD)

Set the 147A FULL FIELD SIG selector switch to FLAT FIELD, and the 1480 Waveform Monitor controls to 3.58 MHz Bandpass and 0.2 Volts Full Scale.

CHECK—Residual subcarrier is 2.5 mV or less (0.9 minor division or less).

ADJUST—R8960 and C8689 (Modulator Balance), see Fig. 3-30, for minimum residual subcarrier (0.9 minor division or less).

2. Check/Adjust Modulator Balance (PULSE & BAR)

Set the 147A FULL FIELD SIG selector switch to SIN² PULSE & BAR.

CHECK—Residual subcarrier is 2.5 mV or less (0.9 minor division or less).

ADJUST—R8750 (Modulation Balance), see Fig. 3-30, for minimum residual subcarrier (0.9 minor division or less).

3. Check/Adjust 12.5T/20T Pulse Luminance

Set the waveform monitor Response switch to Flat, and 1.0 Volts Full Scale.

Disconnect plug P8490 (see Fig. 3-30).

CHECK—Trailing corner of the modulated 12.5T Pulse is flat.

CHECK—12.5T Pulse is symmetrical.

Set the 1480 Mag switch to .25 μ s/Div.

CHECK—12.5T Pulse Half Amplitude Duration (HAD) is 1.57 μ s within 75 ns (1.495 to 1.645 μ s).

Reset the 1480 Mag switch to Off.

ADJUST—R6458 (Mod Pulse Level), see Fig. 3-30, for the best trailing corner of the 12.5T pulse.

ADJUST—R6362 (Mod Pulse Symmetry), see Fig. 3-30, for a symmetrical pulse. Measure at the HAD points.

Set the 1480 Mag switch to .25 μ s/Div.

ADJUST—R6354 (Mod Pulse Width), see Fig. 3-30, for a 12.5T pulse HAD of 1.57 μ s.

Reset the 1480 Mag switch to Off.

Change the connector on P6050 to pins 1 and 2 (20T Pulse), see Fig. 3-30.

CHECK—Trailing corner of 20T pulse is flat.

CHECK—20T pulse is symmetrical.

CHECK—20T pulse HAD is 2.5 μ s within 0.1 μ s.

If necessary, readjust R6458, R6362, and R6354 for the best compromise between the 12.5T pulse and the 20T pulse.

Replace the connector on P6050 to pins 2 & 3 (12.5T).

CHECK—12.5T pulse amplitude is 357.1 mV within 1.8 mV (50 IRE within 0.25 IRE).

ADJUST—R7357 (Luminance Gain), see Fig. 3-3, for a 12.5T pulse luminance amplitude of 357.1 mV (50 IRE).

CHECK—Horizontal and vertical blanking levels match.

ADJUST—R7453 (P & B Sync Level), see Fig. 3-30, to match the horizontal and vertical blanking levels.

Reconnect P8490.

4. Check/Adjust Modulated Pulse Chrominance

CHECK—Modulation at the bottom of the pulse is symmetrical.

CHECK—Harmonics are -40 dB or lower in amplitude at all positions of the FULL FIELD SIG Selector, except MULTIBURST. (Use spectrum analyzer.)

CHECK—Modulated Pulse amplitude is 714.3 mV within 36 mV (100 IRE within 0.5 IRE).

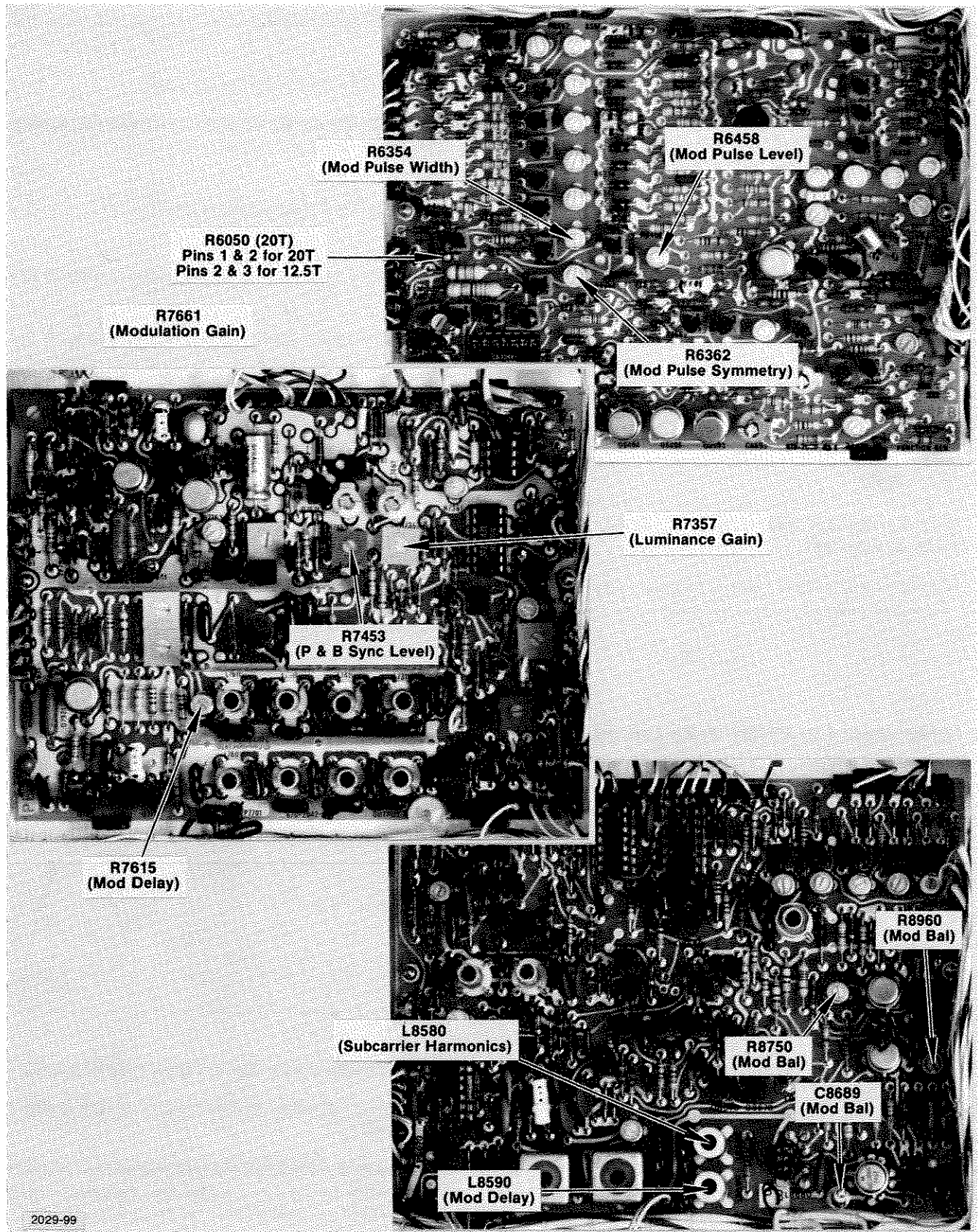

Fig. 3-30. 147A Modulated Pulse adjustments and connectors.

The following three adjustments interact. Repeat as necessary.

ADJUST—R7615 and L8590 (Mod Delay), see Fig. 3-30, for symmetrical modulation on the bottom of the pulse.

ADJUST—L8580 (Subcarrier Harmonics), see Fig. 3-30, for minimum amplitude of harmonics measured with spectrum analyzer (≤ -40 dB).

ADJUST—R7661 (Modulation Gain), see Fig. 3-30, for a Modulated Pulse amplitude of 714.3 mV (100 IRE).

NOTE

A slight adjustment of R7357 may be necessary to obtain a flat bottom on the pulse baseline.

5. Check/Adjust Modulated Pulse Phasing

Observe the vectorscope display of the Modulated Pulse signal. Set R8060 (Mod Pulse Phase), see Fig. 3-30, fully cw.

CHECK—Vectorscope display appears as a fan shaped circle with an opening of approximately 20° to 60° , as shown in Fig. 3-31.

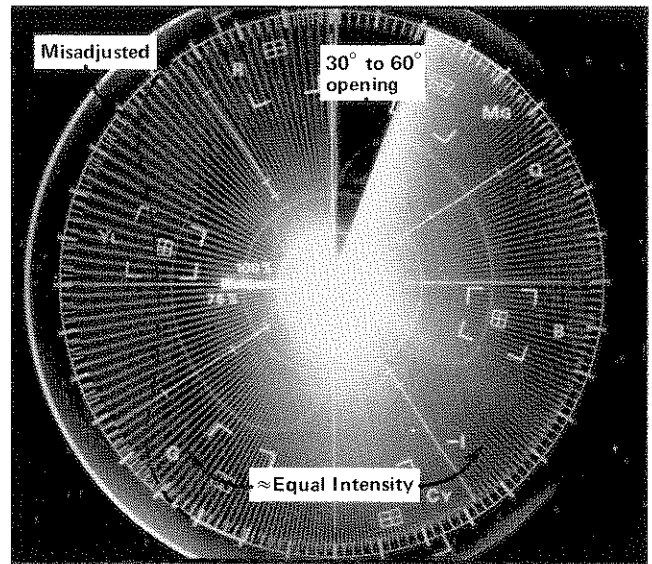

Fig. 3-31. Typical vectorscope display of the 147A Modulated Pulse when the variable modulation filters are adjusted.

ADJUST—L8050 and L8150 (Variable Modulation Filters) to obtain the symmetrical display as shown in Fig. 3-31.

GROUP 5 (149A)—MODULATED PULSE

1. Check/Adjust 12.5T/20T Pulse Luminance

Set the 149A to SIN² PULSE & BAR. Disconnect P8199 (see Fig. 3-32). Set the 1480 Waveform Monitor to 1.0 Volts Full Scale.

CHECK—Trailing corner of the modulated 12.5T pulse is flat.

CHECK—12.5T pulse is symmetrical.

Set the 1480 Mag switch to .25 μ s/Div.

CHECK—12.5T pulse Half Amplitude Duration (HAD) is 1.57 μ s within 75 ns (1.495 to 1.645 μ s).

Reset the 1480 Mag switch to Off.

ADJUST—R6458 (Mod Pulse Level), see Fig. 3-32, for the best trailing corner of the 12.5T pulse.

ADJUST—R6362 (Mod Pulse Symmetry), see Fig. 3-32, for a symmetrical pulse. Measure at the HAD points.

Set the 1480 Mag switch to .25 μ s/Div.

ADJUST—R6354 (Mod Pulse Width), see Fig. 3-32, for a 12.5T pulse HAD of 1.57 μ s.

Reset the 1480 Mag switch to Off.

Change the connector on P6050 to pins 1 and 2 (20T Pulse), see Fig. 3-32.

CHECK—Trailing corner of 20T pulse is flat.

CHECK—20T pulse is symmetrical.

CHECK—20T pulse HAD is 2.5 μ s within 0.1 μ s.

If necessary, readjust R6458, R6362, and R6354 for the best compromise between the 12.5T and 20T pulses.

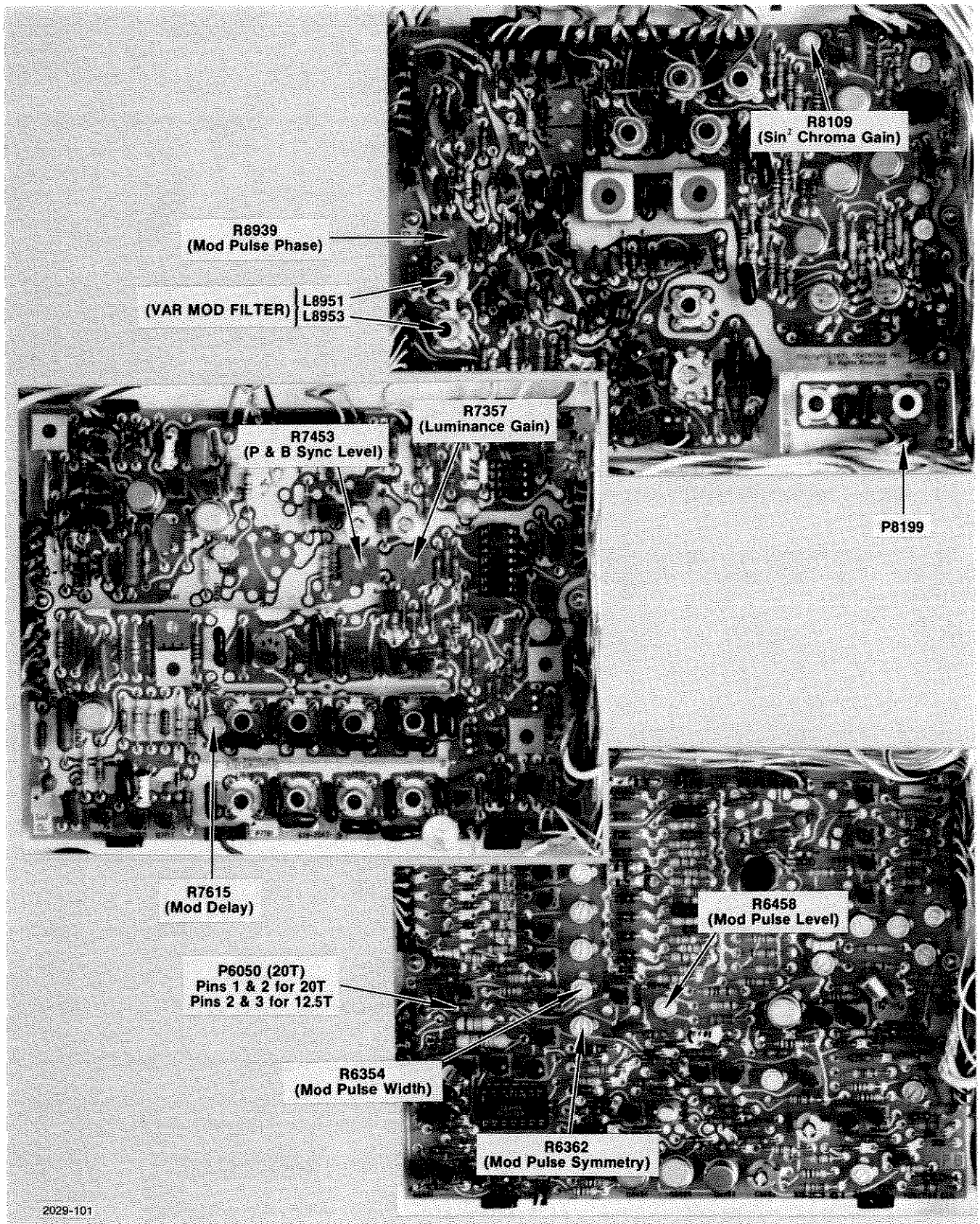

Fig. 3-32. 149A Modulated Pulse adjustments and connectors.

Replace the connector on P6050 to pins 2 and 3 (12.5T).

CHECK—12.5T pulse amplitude is 357.1 mV within 1.8 mV (50 IRE within 0.25 IRE).

ADJUST—R7357 (Luminance Gain), see Fig. 3-32, for a 12.5T Pulse luminance amplitude of 357.1 mV (50 IRE).

CHECK—Horizontal and vertical blanking levels match.

ADJUST—R7453 (P & B Sync Level), see Fig. 3-32, to match the horizontal and vertical blanking levels.

Reconnect plug P8199.

2. Check/Adjust Modulated Pulse Chrominance

CHECK—Modulation on the bottom of the pulse is symmetrical.

CHECK—Modulated Pulse amplitude is 714.3 mV within 3.6 mV (100 IRE within 0.5 IRE).

ADJUST—R7615 (Mod Delay), see Fig. 3-32, for a symmetrical bottom on the Modulated Pulse.

ADJUST—R8109 (Sin^2 Chroma Gain), see Fig. 3-32, for a Modulated Pulse amplitude of 714.3 mV (100 IRE).

NOTE

A slight readjustment of R7357 (Luminance Gain) may be necessary to obtain a flat bottom on the pulse baseline.

3. Check/Adjust Pulse Phasing

Observe the vectorscope display of the Modulated Pulse signal. Preset R8939 (Mod Pulse Phase), see Fig. 3-32, fully clockwise.

CHECK—Vectorscope display appears as a fan-shaped circle with an opening of approximately 0° to 60° .

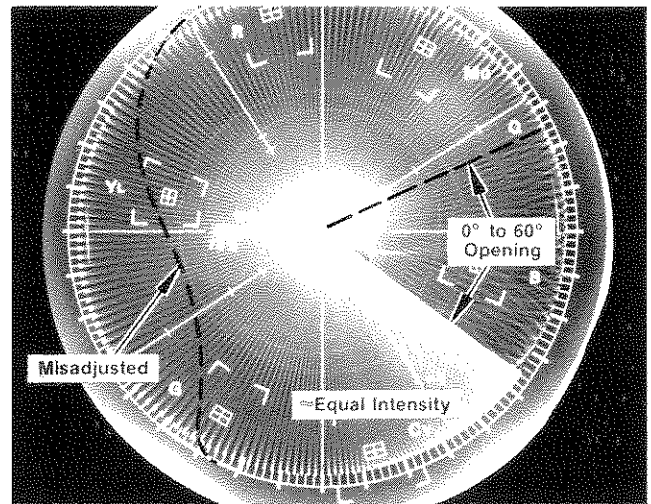

A.

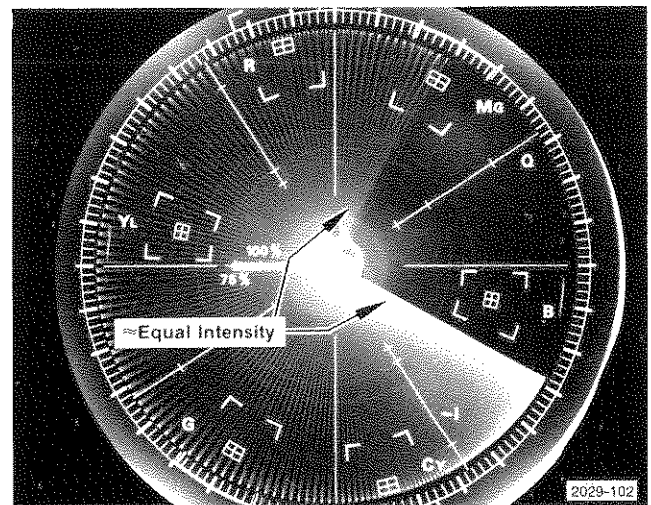

B.

Fig. 3-33. Typical vectorscope displays of modulated pulse when the variable modulation filter is adjusted.

ADJUST—L8591 and L8593 (Var Mod Filter), see Fig. 3-32, for the best symmetry on the vector display, as shown in Fig. 3-33A.

Set R8939 for the vector display opening to stop at Magenta, about 61° , as shown in Fig. 3-33B.

GROUP 6—CHROMINANCE

1. Check/Adjust LINEARITY Subcarrier Amplitude

Set the FULL FIELD SIG Selector switch to LINEARITY, and the SUBCARRIER switch to ON.

CHECK—Peak-to-peak subcarrier amplitude is between 282.1 mV and 289.3 mV (40 IRE within 0.5 IRE).

ADJUST—R3410 (40 IRE Mod Ampl), see Fig. 3-34, for exactly 285.7 mV (40 IRE).

Change the connector on P3400 to pins 1 and 2 (20 IRE).

CHECK—Peak-to-peak subcarrier amplitude is between 139.3 mV and 146.5 mV (20 IRE within 0.5 IRE).

ADJUST—R3420 (20 IRE Mod Ampl), see Fig. 3-34, for exactly 142.9 mV (20 IRE).

Return the connector on P3400 to pins 2 and 3 (40 IRE).

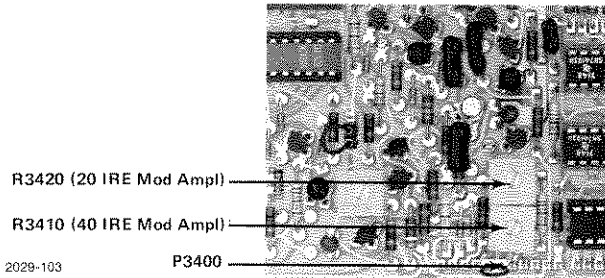

Fig. 3-34. Linearity chrominance adjustment and connector locations.

2. Check/Adjust BURST Amplitude

CHECK—Peak-to-peak Burst amplitude is between 282.1 mV and 289.3 mV (40 IRE within 0.5 IRE).

ADJUST—R8705 (149A) or R8620 (147A), (Burst Ampl), see Fig. 3-35, for a peak-to-peak Burst amplitude of exactly 285.7 mV (40 IRE).

3. Check/Adjust VIRS Modulation Amplitude

Set the 1480 Line Selector to Line 19. Push the 1480 Dig (Digital) Line Selector button and the All Fields On button.

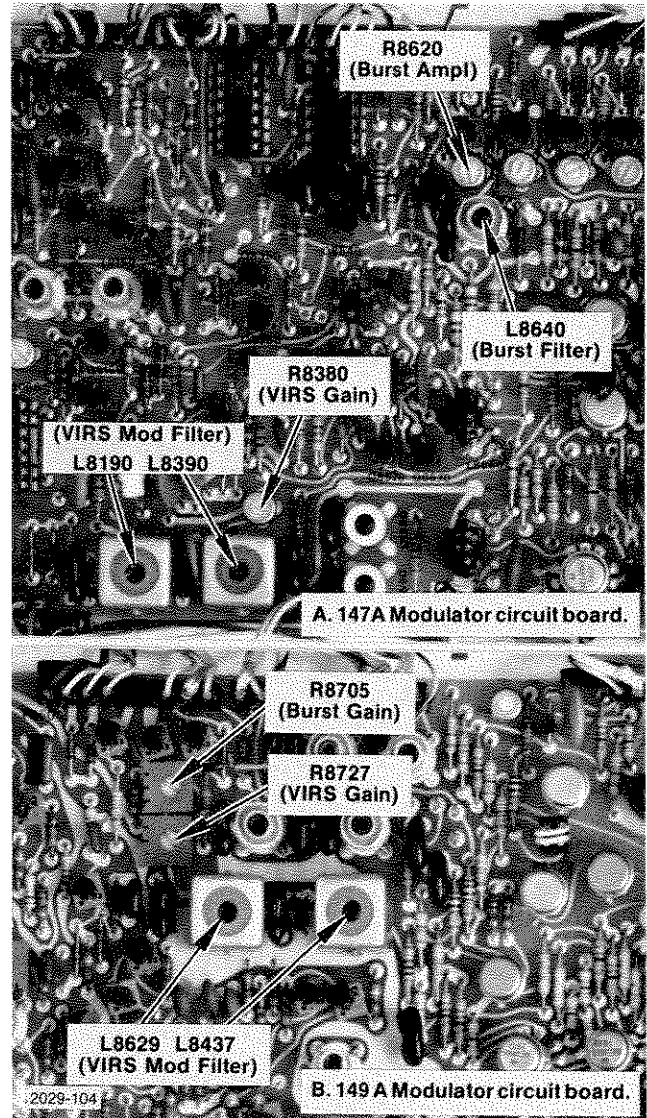

Fig. 3-35. Burst and VIRS modulation adjustment locations.

CHECK—VIRS modulation amplitude is between 282.8 mV and 288.6 mV (40 IRE within 0.4 IRE).

ADJUST—R8280 (147A) or R8727 (149A), (VIRS Gain), see Fig. 3-35, for VIRS chrominance amplitude of exactly 285.7 mV (40 IRE).

4. Check/Adjust VIRS and Burst Envelope Risetimes

Push the 1480 Oper button. Shut off the burst on the incoming video signal source (140). Disconnect plug P5971 and remove Q5991, see Fig. 3-36, so that the chrominance smoothly free runs.

CHECK—VIRS envelope risetime (10% to 90% peak) should be $0.85 \mu\text{s}$ to $1.15 \mu\text{s}$ ($1 \mu\text{s}$ within 15%).

ADJUST—L8190 and L8390 for the 147A, or L8629 and L8437 for the 149A (VIRS Mod Filter), see Fig. 3-35, for the best front corner and a risetime of $0.85 \mu\text{s}$ to $1.15 \mu\text{s}$ ($1 \mu\text{s}$ within 15%).

Push the 1480 Line Selector and All Fields Off buttons.

CHECK—Burst envelope risetime should be between 323 ns and 431 ns (375 ns within 15%).

ADJUST (147A only)—L8640 (Burst Filter), see Fig. 3-35, for the best front corner on the burst, and for risetime between 323 ns and 431 ns (375 ns within 15%).

Turn the incoming video source (140) Burst on. Replace P5971 and Q5991.

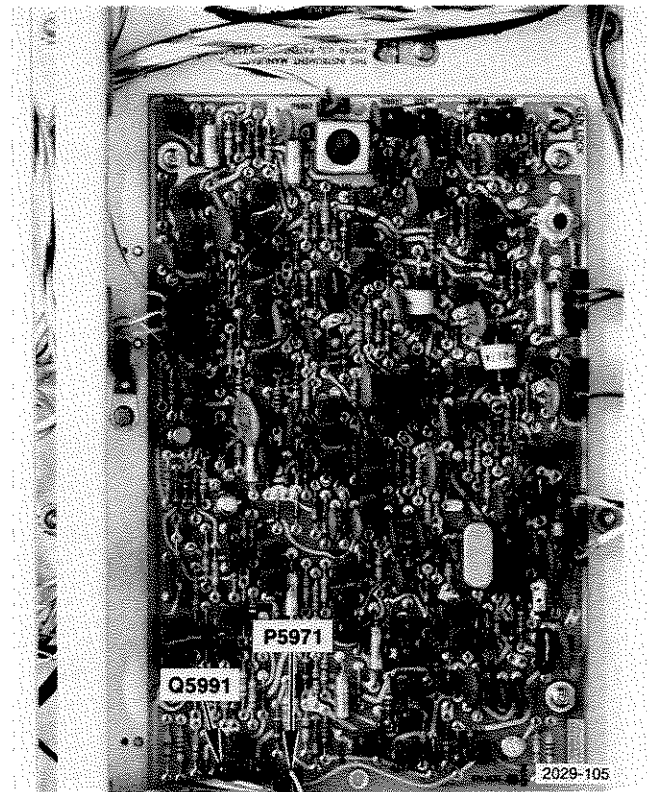

Fig. 3-36. Gen Lock circuit board showing locations of components to free-run chrominance.

GROUP 7—MULTIBURST

NOTE

See Fig. 3-37 for adjustment locations.

1. Check/Adjust Harmonics

Connect the 1401A Spectrum Analyzer as instructed in the Test Equipment portion of this section.

Set the FULL FIELD SIG selector switch to MULTIBURST. Remove P8490 from the 147A, or P8199 from the 149A.

CHECK—All Multiburst harmonics are lower in amplitude than -40 dB from the reference.

ADJUST—C6693, C6788, R6898, and R6977 (MB Harmonics) for minimum harmonics (-40 dB attenuation or more).

Replace P8490 on the 147A, or P8199 on the 149A.

2. Check/Adjust Multiburst Frequencies

Check and adjust the Multiburst frequency accuracy as follows:

Burst Packet	Waveform Monitor	CHECK	ADJUST
500 kHz	$.5 \mu\text{s}/\text{Div}$	2 cycles in 8 div $\pm 0.24 \text{ div}$	R6304
1.25 MHz (149A)	$.2 \mu\text{s}/\text{Div}$	2 cycles in 8 div $\pm 0.24 \text{ div}$	R6202
1.5 MHz (147A)	$.2 \mu\text{s}/\text{Div}$	3 cycles in 10 div $\pm 0.3 \text{ div}$	R6202
2.0 MHz	$.2 \mu\text{s}/\text{Div}$	4 cycles in 10 div $\pm 0.3 \text{ div}$	R6314
3.0 MHz	$.1 \mu\text{s}/\text{Div}$	3 cycles in 10 div $\pm 0.3 \text{ div}$	R6324
3.58 MHz	$.1 \mu\text{s}/\text{Div}$	3 cycles in 8.13 to 8.63 div	R6334
4.1 MHz (149A)	$.1 \mu\text{s}/\text{Div}$	3 cycles in 7.17 to 7.46 div	R6344
4.2 MHz (147A)	$.1 \mu\text{s}/\text{Div}$	3 cycles in 7.00 to 7.23 div	R6344

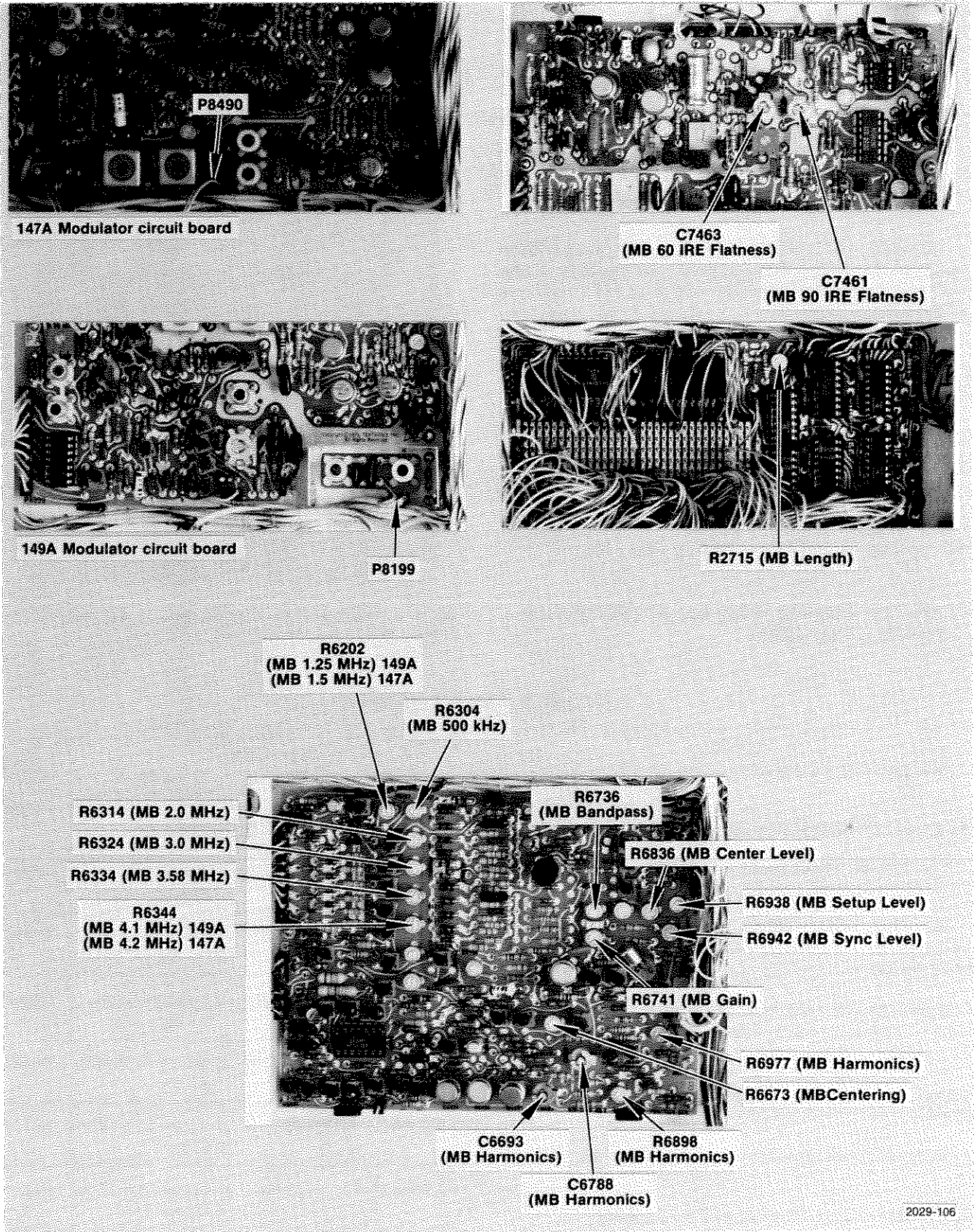

2029-106

Fig. 3-37. Multiburst adjustment locations.

Recheck harmonics. The harmonics and frequency adjustments are interactive; if either is adjusted, the other must be checked.

3. Check/Adjust for Whole Cycles

Reset the waveform monitor to 5 μ s/Div and the Volts Full Scale Var in detent.

CHECK—The 500 kHz packet contains at least three complete cycles for the 147A, or at least four complete cycles for the 149A; and the remaining packets consist of complete sinewave starting and stopping at the center reference level.

ADJUST—R7615 (MB Length) for three complete cycles of 500 kHz for the 147A, or four complete cycles of 500 kHz for the 149A, and complete cycles of the remaining packets.

4. Check/Adjust Multiburst Flatness

Set the MULTIBURST AMPLITUDE switch to REDUCED (147A) or 60 IRE (149A). Set the 1480 to 0.2 Volt Full Scale (calibrated), 2 Field Display, and X50 Mag.

CHECK—Tops and bottoms of Multiburst packets are flat within 1.25 minor divisions (0.5 IRE).

ADJUST—R6736 (MB Bandpass) for symmetrical tops and bottoms, and C7463 (60 IRE MB Flatness) for flat tops and bottoms.

Set the MULTIBURST AMPLITUDE switch to NORMAL (147A) or FULL (149A).

CHECK—Tops and bottoms of packets are flat within 1.25 minor divisions (0.5 IRE).

ADJUST—C7461 (90 IRE MB Flatness) for flat tops and bottoms.

Recheck the 60 IRE flatness, then leave the MULTIBURST AMPLITUDE switch set to NORMAL (147A) or FULL (149A).

If the packets are not flat, re-do steps 1 through 3 of this group. Adjust for the best compromise between harmonics and flatness.

5. Check/Adjust Multiburst Average Level

Push the vectorscope Y button.

CHECK—The last packet level matches the reference level (see Fig. 3-38).

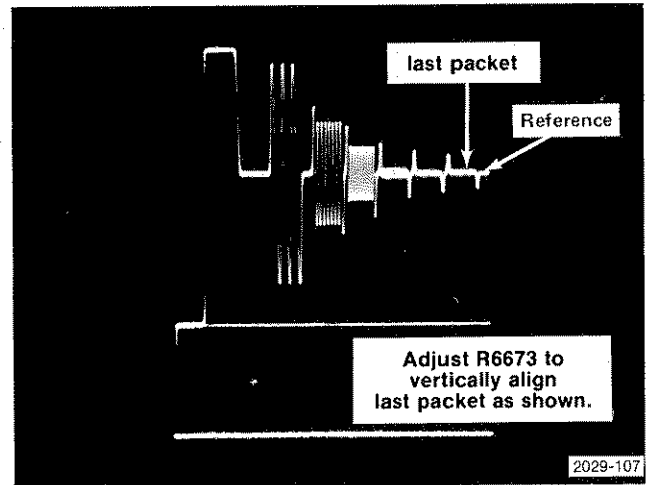

Fig. 3-38. Typical vectorscope (Y) display of Multiburst luminance.

ADJUST—R6673 (MB Centering) to match the level of the last packet to the reference level.

6. Check/Adjust Multiburst Sync Level

CHECK—Horizontal and vertical sync levels are the same.

ADJUST—R6942 (MB Sync Level) to match the horizontal and vertical sync levels.

7. Check/Adjust Multiburst Amplitudes

Recheck accuracy of the MB center level (R6836) for 55 IRE within 1 IRE.

CHECK—Peak-to-peak amplitude of the 500 kHz packet is between 635.7 mV and 650.0 mV (60 IRE within 1 IRE).

ADJUST—R6741 (MB Gain) for exactly 642.9 mV (60 IRE).

Set the MULTIBURST AMPLITUDE switch to REDUCED (147A) or 60 IRE (149A).

CHECK—The peak-to-peak amplitude of the 500 kHz packet is between 421.4 mV and 435.7 mV (60 IRE within 1 IRE).

8. Recheck Mod Pulse

Recheck Step 1 of Group 5 for proper width, symmetry, and matching of blanking levels. These adjustments interact with the Multiburst adjustments (if one is adjusted, the others must be checked).

GROUP 8—PULSE AMPLITUDE AND WIDTH

NOTE

See Fig. 3-39 for adjustment and pin connector locations for this group.

1. Check/Adjust 2T PULSE Amplitude and Width

Set the FULL FIELD SIG selector switch to SIN² PULSE & BAR.

CHECK—2T PULSE amplitude is within 7.14 mV of the BAR amplitude (100 IRE within 1 IRE). (Use the 1480 Waveform Comparison controls for this measurement.)

Set the 1480 for 1.0 Volt Full Scale, Mag to .1 μ s/Div. Position the half-amplitude point of the 2T PULSE at the horizontal reference graticule line.

CHECK—Half Amplitude Duration (HAD) is between 212 ns and 288 ns (250 ns within 15%).

Set the 1480 to 0.2 Volt Full Scale.

CHECK—Ringing after the pulse is 1.25 minor divisions or less (0.5% or less).

ADJUST—L7301, L7401, L7501, L7601 and C7303 for a Half Amplitude Duration of 250 ns within 15%, ringing of 0.5% or less, and symmetrical rise and fall times.

ADJUST R7131 (2T Pulse Amplitude) to match the BAR amplitude exactly (100 IRE).

2. Check/Adjust T PULSE Amplitude and Width

Change the grey connector on P7131 to pins 2 and 3, and the grey connector on P7321 to pins 4 and 5.

CHECK—T PULSE amplitude is within 1% of BAR Amplitude, ringing is 1% or less, and Half Amplitude Duration is 125 ns within 15% (106 ns to 144 ns).

ADJUST—L7311, L7411, L7511 and L7611 for a Half Amplitude Duration of 125 ns within 15%, and ringing of 1% or less.

ADJUST—R7138 (T Pulse Ampl) for the T PULSE amplitude to exactly match the BAR amplitude (100 IRE).

Reconnect the gray connectors for a 2T PULSE (P7131-1 & -2, and P7321-5 & -6).

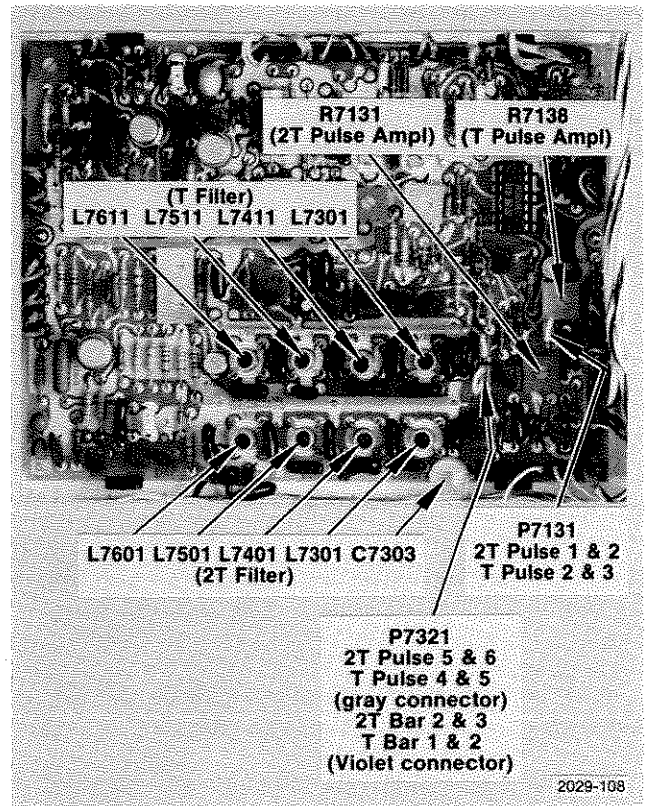

Fig. 3-39. Pulse and Bar adjustment and connector locations.

3. Check BAR Risetimes

CHECK—BAR risetime is 115 ns within 15% (98 to 132 ns).

Change the violet connector on P7321 to pins 2 and 3.

CHECK—BAR risetime is 230 ns within 15% (195 ns to 265 ns).

Return the violet connector to P7321-4 & -5 (T BAR).

CHECK—BAR tilt is 3.6 mV or less in any 10 μ s segment (0.5% or less).

GROUP 9—FULL FIELD DIFF GAIN & DIFF PHASE

1. Check Diff Gain

Set the FULL FIELD SIG switch to LINEARITY. Set the vectorscope to measure differential gain.

CHECK—Diff gain is 0.5% or less.

2. Check Diff Phase

Set the vectorscope to measure differential phase.

CHECK—Diff phase is 0.2° or less.

GROUP 10—VIRS SENSITIVITY

Connect the composite video signal to the BLACK BURST input. Connect pin 9 of the REMOTE plug, P9014, to ground. (This enables the BLACK BURST input as described in Section 1.) Connect the rear-panel FULL FIELD TEST signal to the PROGRAM LINE IN connector. Display Line 19 of the PROGRAM LINE OUT signal on the waveform monitor.

CHECK—VIRS display is flickering, and the front-panel VIRS program indicator lamps are flickering. (This indicates that the VIRS Detector is working properly.)

ADJUST—R8030 on the 147A, or R450 on the 149A (VIRS Detect Sens), see Fig. 3-40, to the center of the detection range (flickering). Set the PROGRAM CONTROL UNITY GAIN/VAR switch to VAR. Set the LEVEL control for minimum amplitude. Notice the detector still works. If not, readjust R8030 or R450 for VIRS detection at all positions of the LEVEL control.

Reset the PROGRAM CONTROL switch to UNITY GAIN. Disconnect the FULL FIELD TEST signal from the PROGRAM LINE IN connector, and remove the ground connection from pin 9 of the REMOTE connector, P9014. Return the video signal source to the PROGRAM LINE IN connector.

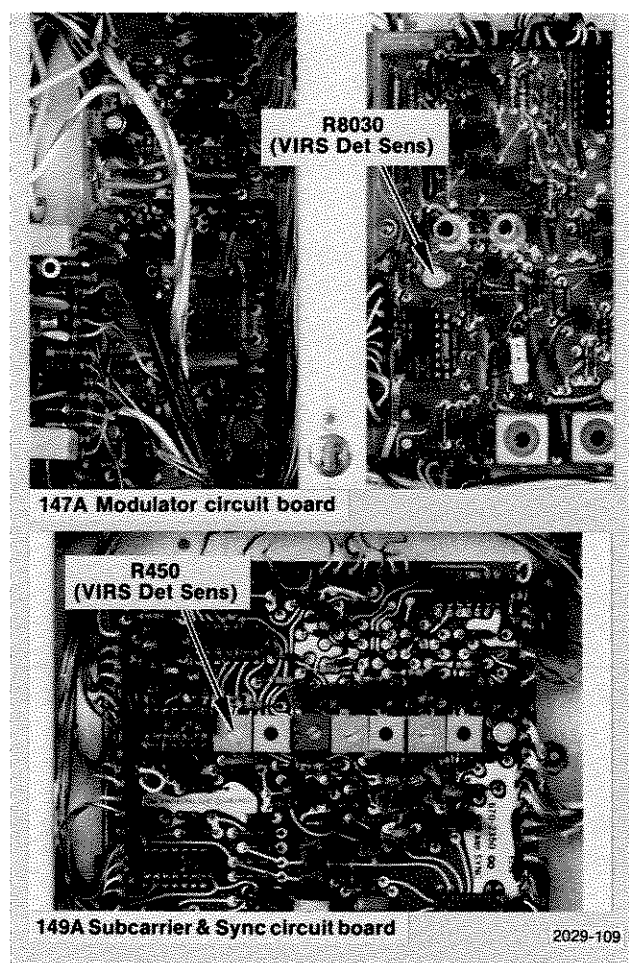

Fig. 3-40. VIRS Detector sensitivity adjustment location.

GROUP 11—GEN-LOCK

1. Check Light and Output Operation

Set the video signal source to provide a modulated staircase VITS on line 19 of both fields. Connect the PROGRAM LINE OUT signal to the monitor, and display the vertical interval.

CHECK—NONSYNCHRONOUS MODE—NO VITS lamp is extinguished; ADD (amber), DELETE (red), and PROGRAM (green) lamps are lit; and there are VITS and the VIR Signal in the vertical interval.

Turn off the video signal source Sync switch.

CHECK—The NON-SYNC lamp is lit; ADD, DELETE and PROGRAM lights are extinguished; and there are no VITS except that from the video signal source.

CHECK—There should be no signal available at the CW SUBCARRIER OUT or COMP SYNC outputs.

Turn the video signal source Sync switch on and the Burst switch off.

CHECK—NON-SYNC, ADD, DELETE and VIRS IN-COMING lights are extinguished; PROGRAM light is lit; there are VITS, but no VIRS.

CHECK—There should be no signal available at the CW SUBCARRIER OUT, but there is a signal at COMP SYNC OUT.

Turn the external Burst on.

CHECK—ADD and DELETE lights are on, VIRS is displayed, and there is a signal at CW SUBCARRIER OUT.

2. Check Sync Stripper Operation

Ground pin 9 of the REMOTE connector, P9014, to enable the BLACK BURST input.

CHECK—Loss of VITS and VIRS.

Connect Comp Sync from the video signal source to the BLACK BURST input, do not terminate. Use a 10X probe between the 1480 Probe Input and the test points.

CHECK—TP5290, see Fig. 3-41, for 0.8 V to 1.2 V of sync.

CHECK—P5294, pin 2, see Fig. 3-41, for a composite sync amplitude of 5.0 to 6.0 V.

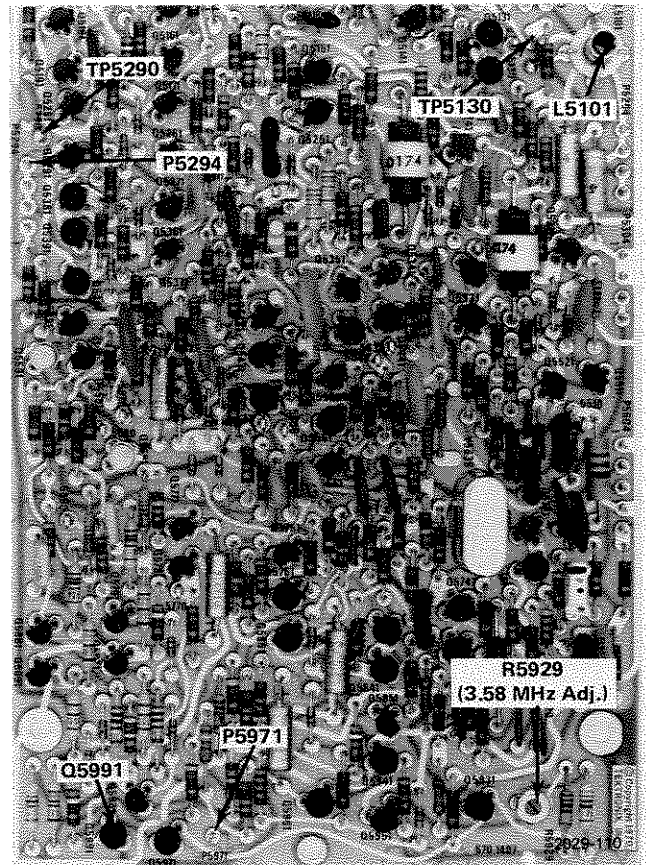

Fig. 3-41. Gen Lock test point, pin connector, and adjustment locations.

Remove the ground connection from pin 9 of the REMOTE plug, P9014.

CHECK—TP5290 should have about the same peak-to-peak signal gain with the video signal source sync on or off, and with either color bars or modulated staircase.

3. Check Chroma AGC Ratio

NOTE

R5929 (3.58 MHz Adj.) is adjusted so that the chroma change is easier to see. It will be reset in step 4.

Connect a 10X probe to TP5130. Remove Q5991 (see Fig. 3-41) and adjust R5929 for a chroma variation of about once a second.

CHECK—Chroma amplitude ratio should not vary more than 1:1.6.

Replace Q5991.

4. Adjust 3.58 MHz Frequency

Monitor the rear-panel FULL FIELD TEST signal on the vectorscope. Turn off the video signal source Burst switch.

ADJUST—R5929 (3.58 MHz Adj.), see Fig. 3-41, for minimum vector rotation (3.579545 MHz within 25 Hz).

Turn the video signal source Burst on.

GROUP 12—VITS INSERTION, DIFF PHASE AND DIFF GAIN

1. Check/Adjust PROGRAM LINE OUT

Set the video signal source for a full-field modulated staircase test signal. Display the PROGRAM LINE OUT signal on the monitor and vectorscope.

Set the vectorscope to measure differential phase.

CHECK—Diff Phase should be 0.15° or less.

Set the vectorscope to measure differential gain.

CHECK—Diff Gain should be 0.2% or less.

2. Check PREVIEW MONITOR OUT

Display the PREVIEW MONITOR OUT signal on the waveform monitor.

CHECK—Diff Gain should be 0.4% or less.

Set the vectorscope to measure differential phase.

CHECK—Diff Phase should be 0.3° or less.

GROUP 13—VITS INSERTION

NOTE

The adjustments and checks in this group, except step 1, require that any errors in the full-field signal be noted or adjusted out.

The full-field signal output dc level should be close to 0 volts. Adjust R7733 (DC Level) for 0 volt.

All adjustments, except Auxiliary Sync Level and Ext VITS Gain, are shown in Fig. 3-44.

Display the vertical interval of the rear-panel FULL FIELD TEST signal on the monitor. If the back porch of the Multiburst and Sin² Pulse & Bar signals are not superimposed with the blanking level, they will show up as unwanted VITS pedestal error.

1. Check/Adjust Auxiliary Sync Level

Display the horizontal interval of the PREVIEW MONITOR OUT signal on the monitor. Set the PROGRAM CONTROL switch to AUXILIARY.

Small errors may be adjusted out without further recalibration. Adjust R6942 (MB Sync Level), and R7453 (P & B Sync Level) for horizontal and vertical blanking levels to match in all positions of the FULL FIELD SIG selector switch.

CHECK—Display should be similar to the display shown in Fig. 3-43.

ADJUST—R7361 (Aux Sync Level), see Fig. 3-42, to match the levels as shown in Fig. 3-43.

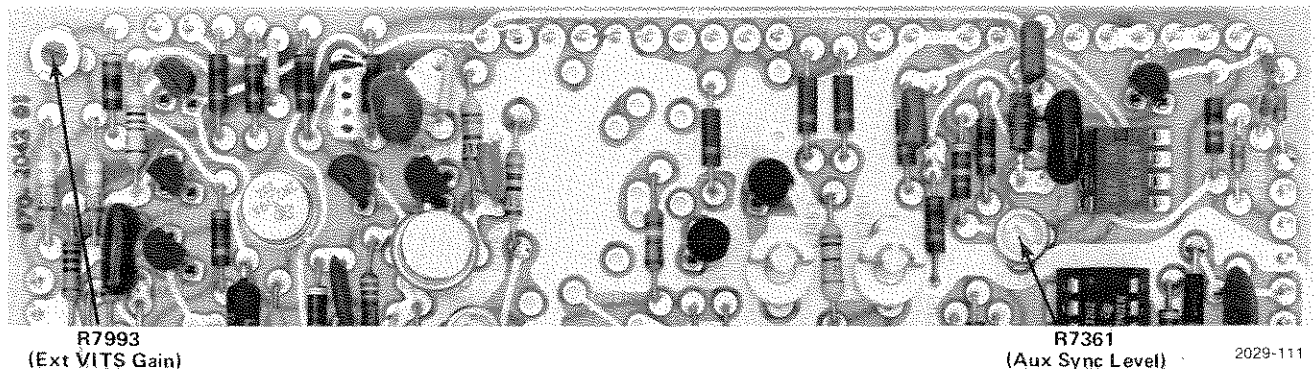

Fig. 3-42. Auxiliary sync level and external VITS gain adjustment locations.

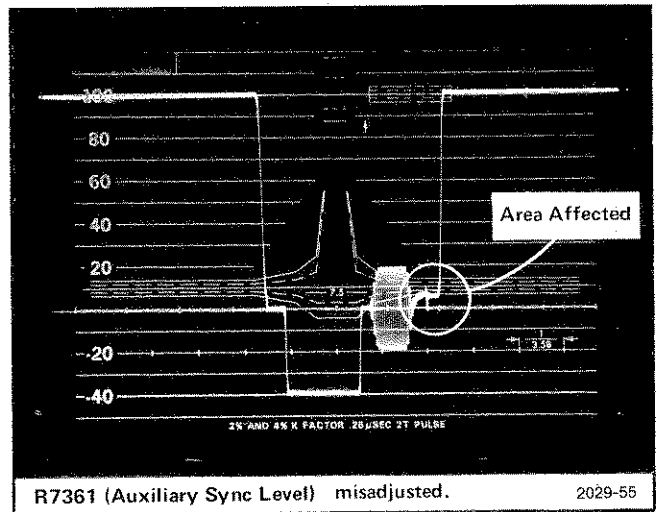
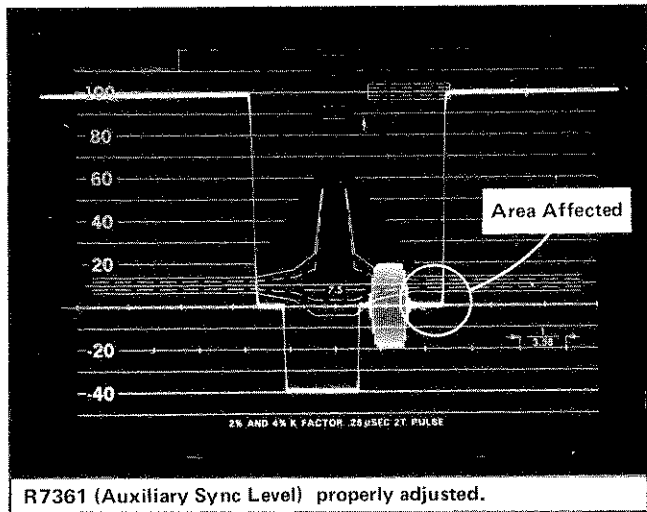

Fig. 3-43. Typical waveform monitor display used to check or adjust auxiliary sync level.

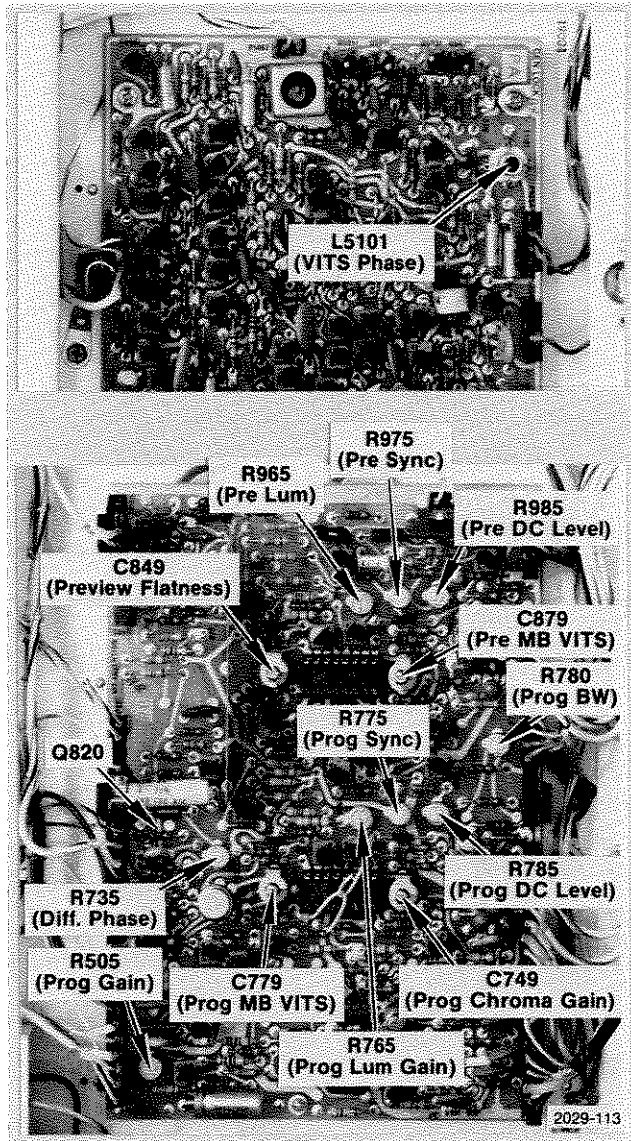

Fig. 3-44. VITS Insertion adjustment locations.

Return the PROGRAM CONTROL switch to PROGRAM.

2. Check/Adjust External VITS Gain

Connect the video signal source (140) Comp Video to the BLACK BURST input, and connect the loop-through to the EXT VITS IN connector. Ground pin 9 of P9014, the REMOTE plug. Set the 140 to provide a 100 IRE Pedestal VITS on Line 16 of Field 2; program the 147A or 149A for this external VITS (see the Operating Changes portion of Section 1 for programming external VITS). Display the vertical interval of the PROGRAM LINE OUT signal on the monitor.

CHECK—External VITS amplitude matches the internal VITS 100% levels within 1% (these amplitudes may not actually be 100 IRE at this point; however, the levels should match).

ADJUST—R7993 (Ext VITS Gain), see Fig. 3-42, to match the external and internal VITS 100% levels.

Set the 140 to generate a modulated staircase VITS. Set the vectorscope to measure differential gain on Line 16 of Field 2 of the PROGRAM LINE OUT signal.

CHECK—Diff gain of the external VITS amplifier is 0.4% or less.

Set the vectorscope to measure differential phase.

CHECK—Diff phase of the external VITS amplifier is 0.3° or less.

Return the VITS Spare 1 programming to Linearity, Field 2, Line 18 (147A) or Line Off (149A).

3. Check/Adjust PROGRAM LINE OUT

Connect the rear-panel FULL FIELD TEST SIGNAL to the PROGRAM LINE IN connector. Display the PROGRAM LINE OUT signal on the monitor.

Set the FULL FIELD SIG selector switch to FLAT FIELD and the VARIABLE APL switch to 100.

CHECK—VITS blanking level and the non-inserted blanking level are within 5 mV of each other (0.7 IRE less).

ADJUST—R775 (Prog Sync Level) to match the blanking levels.

CHECK—Blanking level is 0 volt within 50 mV.

ADJUST—R785 (Prog DC Level) so that no blanking level change occurs when switching between PROGRAM and AUXILIARY (PROGRAM matches 140).

CHECK—VITS 100% amplitudes match the full-field 100% amplitude within 1%.

ADJUST—R505 (Prog Gain) to match the VITS and full-field 100% amplitudes.

CHECK—Full-field pedestal amplitude is 714.3 mV within 1% (100 IRE within 1 IRE).

ADJUST—R765 (Prog Lum Gain) for exactly the same amplitude as the 140 pedestal (100 IRE within 1 IRE).

Set the FULL FIELD SIG selector to MULTIBURST. Remove the FULL FIELD SIG from the PROGRAM LINE IN connector. Display the PROGRAM MONITOR OUT signal on the waveform monitor.

CHECK—Switching transients are less than 5 mV (0.7 IRE).

Reconnect the FULL FIELD TEST SIGNAL to the PROGRAM LINE IN connector. Display the vertical interval of the PROGRAM LINE out signal, showing both the multiburst VITS and the full-field multiburst.

CHECK—VITS and full-field multiburst are flat within 1%.

ADJUST—C779 (Prog MB VITS) so that the tilt of the multiburst VITS is the same when switching between the PROGRAM and AUXILIARY Positions of the PROGRAM CONTROL switch (flat within 1%).

If more range is needed in the adjustment of C779, adjust R895 (Prog Bandwidth) and C779 for the best

compromise between a flat multiburst and minimum switching transients.

ADJUST—C749 (Prog Chroma Gain) for the tilt of the full-field multiburst to be the same when switching between the PROGRAM and AUXILIARY positions of the PROGRAM CONTROL switch (flat within 1%).

4. Check/Adjust PREVIEW MONITOR OUT

Note the dc level of the PROGRAM LINE OUT blanking level.

Display the PREVIEW MONITOR OUT signal on the waveform monitor. Set the PROGRAM CONTROL switch to PREVIEW. Set the FULL FIELD SIG selector switch to FLAT FIELD.

CHECK—Preview blanking level should be within 50 mV of the program blanking level.

ADJUST—R975 (Pre Sync Level) so that the VITS blanking level matches the full-field blanking level.

ADJUST—R985 (Pre DC Level) so that the preview blanking level matches the program blanking level (0 V plus any full-field blanking level error).

CHECK—Preview signal overall amplitude should match the program signal overall amplitude within 1%.

ADJUST—R965 (Pre Gain) for a pedestal amplitude of 714.3 mV within 1% (preview signal matches program signal).

Change the cable to display the other PREVIEW MONITOR OUT signal.

CHECK—Preview signal should be the same amplitude.

Set the FULL FIELD SIG selector switch to MULTIBURST. Display the vertical interval, showing both the multiburst VITS and full-field signals.

Change the cable to the PROGRAM LINE OUT. Note the multiburst flatness of the VITS and full-field signals. Return the cable to the PREVIEW MONITOR OUT.

CHECK—Preview VITS and full-field multiburst signals are flat within 1% (same as program flatness).

ADJUST—C879 (Pre MB VITS Flatness) for a flat multiburst VITS (match program flatness).

ADJUST—C849 (Preview Flatness) for flat full-field multiburst (match program flatness).

5. Check/Adjust INSERT SUBCARRIER PHASE

Disconnect the ground from pin 9 of the REMOTE connector, P9014. Disconnect the FULL FIELD TEST SIGNAL from the PROGRAM LINE IN. Connect the video signal source to the PROGRAM LINE IN. Display the PROGRAM LINE OUT on the vectorscope.

CHECK—INSERT SUBCARRIER PHASE control will position the VIRS vector at least 5° on either side of the burst vector; total range should be approximately 28° .

ADJUST—L5101 (VIRS Phase) so that when the INSERT SUBCARRIER PHASE control is centered, the VIRS vector will overlay the VIRS vector on the burst vector.

Display the PREVIEW MONITOR OUT signal on the vectorscope.

CHECK—Preview VIRS overlays on the burst vector.

ADJUST—C849 (Preview Flatness) to overlay the VIRS vector with the burst vector. Recheck multiburst flatness if C849 is adjusted.

6. Check Waveform Tilt

Connect the rear-panel FULL FIELD TEST SIGNAL to the waveform monitor A Input. Connect the front-panel FULL FIELD SIG OUT to the waveform monitor B Input. Set the waveform monitor for $10 \mu\text{s}/\text{Div}$ and DC Cpl'd A-B. Set the FULL FIELD SIG selector switch to $\text{SIN}^2 \text{ PULSE \& BAR}$. Note any tilt (low frequency slope) of the $25 \mu\text{s}$ Bar.

Connect the rear-panel FULL FIELD TEST SIGNAL to the PROGRAM LINE IN. Ground pin 9 of the REMOTE connector, P9014. Connect the PROGRAM LINE OUT to the waveform monitor A Input.

CHECK—Tilt should be within 0.5% of that noted (3.6 mV or less).

Connect the PREVIEW MONITOR OUT to the waveform monitor A Input.

CHECK—Tilt should be less than 0.5% of that noted (3.6 mV or less).

7. Check PROGRAM and PREVIEW Pulse and Bar

Switch the waveform monitor between the A Input and the B Input.

CHECK—The preview signal is the same as the full-field signal with respect to the following:

2T Pulse-to-Bar ratio;	100% within 0.5% (147A), 2.5 mV 100% within 0.25% (149A), 1.8 mV
12.5T Pulse-to-Bar ratio;	100% within 1% (147A), 7.14 mV 100% within 0.5% (149A), 2.5 mV
12.5T baseline ripple;	0.5% or less, 3.5 mV

Connect the PROGRAM LINE OUT to the waveform monitor A Input. Repeat the above checks for the program signal.

8. Check AUXILIARY PEDESTAL

Display the PREVIEW OUT signal on the monitor. Set the PROGRAM CONTROL switch to AUXILIARY.

CHECK—AUXILIARY PEDESTAL control range should be from 0 (or less) to 100 IRE (or more).

Connect a 0.1 to 0.5 V signal to the AUX IN input (the video signal source Subcarrier signal via a 10X attenuator is acceptable).

CHECK—The external signal rides on the auxiliary pedestal; it should not affect sync or VITS.

9. Check UNITY GAIN/VAR & LEVEL

Set the PROGRAM CONTROL switch to PROGRAM. Set the UNITY GAIN/VAR switch to VAR. Display the PROGRAM LINE OUT signal on the monitor.

CHECK—LEVEL control range should be from 70 IRE (or less) to 130 IRE (or more).

GROUP 14—TIMING

1. Check INSERT DELAY Range

Display the FULL FIELD TEST SIGNAL on the waveform monitor. Make sure that the waveform monitor Ext Sync is connected to the external video signal source Comp Sync.

Select a reference point on the signal and vary the INSERT DELAY control.

CHECK—Range of the control should be greater than 1 μ s.

Leave the control at electrical center.

2. Check/Adjust Pulse Width

Set the waveform monitor to 10 μ s/Div Display Rate, and the Mag switch to 1 μ s/Div. Display the horizontal blanking interval, and adjust the waveform monitor intensity so that the serration and equalizing pulses can be seen, as shown in Fig. 3-45.

CHECK—Timing accuracy, as measured at the 10% points, is as follows:

Fig. 3-45 Component	Timing
A Serration Width	4.3 to 4.7 μ s
B Sync Width	4.65 to 4.75 μ s
C Equalizer Width	2.28 to 2.38 μ s

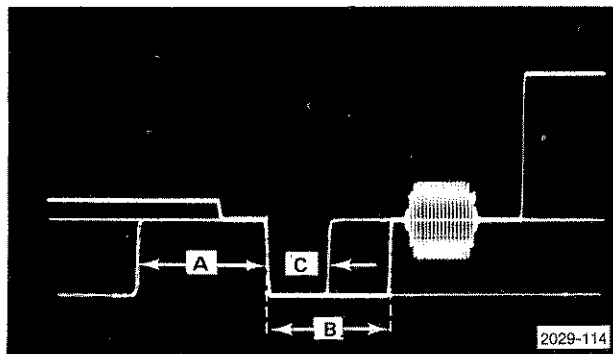

Fig. 3-45. Areas affected by timing adjustments.

ADJUST—Timing accuracy, as measured at the 10% points, as follows: (See Fig. 3-46 for adjustment locations).

Fig. 3-45	Timing
R350 (Serration Width)	4.5 μ s
R250 (Sync Width)	4.71 μ s
R150 (Equalizer Width)	2.33 μ s

3. Check/Adjust Sync Delay

Display the vertical interval of the PROGRAM LINE OUT signal on the waveform monitor. INSERT DELAY control should be at electrical center. Observe the sync pulse of the Multiburst VITS.

CHECK—Timing, as shown in Fig. 3-45 as width D, should be 10 μ s within 50 ns.

ADJUST—R1988 (Sync Delay), see Fig. 3-46, for 10 μ s.

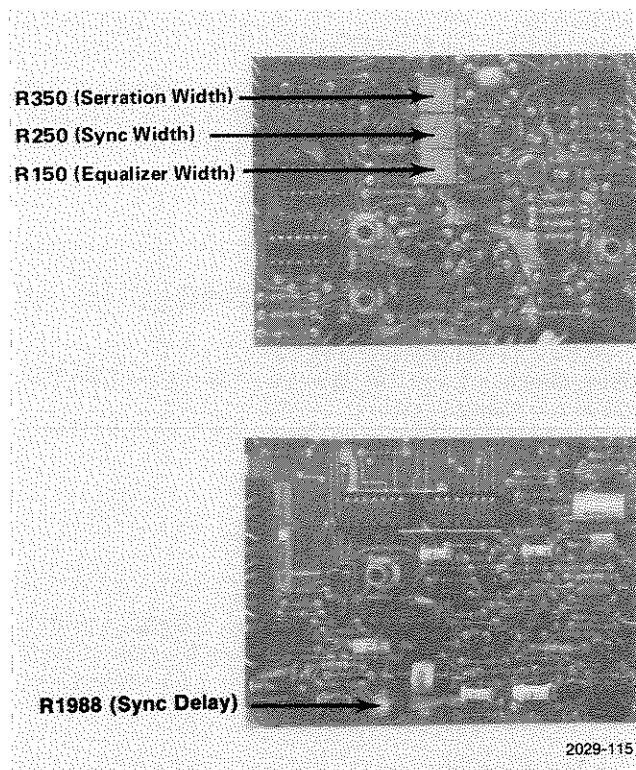

Fig. 3-46. Timing adjustment locations.

GROUP 15—NOISE (147A only)

1. Check/Adjust Noise Amplitude

Connect the 147A NOISE OUT through a 75 Ω coax cable, 4.2 MHz Low Pass Filter, and 75 Ω feed-thru termination to the RMS Voltmeter. Set the NOISE LEVEL dB switches to -20 dB.

CHECK—Noise amplitude is 70 mV RMS within 1%.

ADJUST—R3270 (Noise Bandwidth) fully clockwise, and R3260 (Noise Ampl) for 70 mV RMS.

2. Check Noise Spectrum

Connect a Spectrum Analyzer to the 147A NOISE OUT.

CHECK—Noise spectrum should be flat to 5 MHz within 6 dB.

3. Check Half-Line Insertion

Display the PREVIEW MONITOR OUT signal on the waveform monitor. Set the PROGRAM CONTROL switch to PREVIEW. Set the FULL FIELD SIG Selector switch to NOISE.

CHECK—Half line of noise should be displayed in the middle of the line when in NOISE INSERTION, or a full line of noise pedestal in NOISE DELETION.

4. Check/Adjust Noise Match

Connect Composite Video from the video signal source to the 147A BLACK BURST input, and terminate the loop-thru in 75 Ω . Set the 147A to gen lock to the BLACK BURST input (ground pin 9 of the REMOTE plug, J9014).

Connect the NOISE OUT signal to PROGRAM LINE IN. Set the noise pedestal to match the baseline. Insert -20 dB of noise.

CHECK—Noise amplitudes match.

ADJUST—R7561 (Noise Match) to match the half line noise amplitude to the noise inserted on the program line.

GROUP 16—OPTIONAL CHECKS

This group of checks has been performed at the factory, and may not be desired by the user.

1. Power Supply Regulation

Requires a variable autotransformer.

Repeat the checks given in Group 1, Steps 1 and 2, while varying the autotransformer over the line voltage range listed for the LINE VOLTS selector switch position being used.

2. Return Loss

Requires a return-loss bridge, constant amplitude signal generator and a minimum loss attenuator. See the Optional Test Equipment list. This is to be used in conjunction with the return-loss bridge instruction manual.

Connect the composite video from the video signal source to the BLACK BURST signal. Ground pin 9 of the REMOTE plug, P9014. Externally trigger the test oscilloscope from Comp Sync.

Balance the bridge.

Check return loss with the POWER switch OFF and the PROGRAM LINE OUT connector terminated with the return-loss bridge termination.

CHECK—Return loss should be at least -30 dB (7.9 mV) from 50 kHz to 6 MHz.

Turn the POWER switch ON.

CHECK—Return loss as follows:

PROGRAM LINE IN	−30 dB to 5 MHz
PROGRAM LINE OUT	−30 dB to 5 MHz
PROGRAM MONITOR	−30 dB to 5 MHz
PREVIEW MONITOR (both)	−30 dB to 5 MHz
COMPOSITE SYNC	−30 dB to 3.6 MHz
FULL FIELD OUT (both)	−30 dB to 5 MHz
EXT VITS IN	−34 dB to 5 MHz
AUX IN	−30 dB to 5 MHz

3. PROGRAM LINE OUT Aberrations

Requires an RMS voltmeter, a 5 MHz low-pass filter, and a 5 MHz weighting filter. See the Optional Test Equipment list. A separate 147A or 149A is also required for inserting an external 2T Pulse.

Connect the video signal source composite video to the BLACK BURST input. Ground pin 9 of the REMOTE plug, P9014. (There is no input to the PROGRAM LINE IN). Display the PROGRAM LINE OUT signal on the test oscilloscope.

Residual Subcarrier. Set the PROGRAM CONTROL switch to PROGRAM.

CHECK—Residual subcarrier on lines 10 through 17 and on line 21, of both fields, should be 0.7 mV or less (−60 dB).

Set the PROGRAM CONTROL switch to PREVIEW.

CHECK—Residual subcarrier on lines 10 through 21, of both fields, should be 0.7 mV (−60 dB).

All Blanking Lines and Inactive Parts of Lines. Connect a 5 MHz low-pass filter between the cable and the 75 Ω termination to the test oscilloscope. View the entire vertical interval.

CHECK—Except for programmed VITS, there should be no signal greater than 7.0 mV (40 dB).

Active Parts of Lines. Set the FULL FIELD SIG selector switch to FLAT FIELD and the APL switches to VARIABLE and 0. The 5 MHz low-pass filter remains connected. Display the active portion (10 μs to 62 μs) of any line (22 through 262).

CHECK—Spurious coherent signals should be 0.7 mV or less (−60 dB).

Delete Mode. The 5 MHz low-pass filter remains connected.

CHECK—Active portion of line 21, field 1, for signal attenuation as follows:

Any internal signal (all positions of the FULL FIELD SIG selector switch), −60 dB (0.7 mV or less).

2T Pulse (Pulse and Bar VITS from another 147A or 149A), −70 dB (0.222 mV or less).

Subcarrier (color bar VITS from 140 or another 149A), −60 dB (0.7 mV or less).

Non-Inserted Lines. Connect (from the PROGRAM LINE OUT in listed order) a 75 Ω cable, 5 MHz weighting filter, 5 MHz low-pass filter, 75 Ω termination to the test oscilloscope. Trigger the test oscilloscope on the power input line.

CHECK—Power line transients and hum should be 0.7 mV or less (−60 dB).

Random Noise Output. Terminate the PROGRAM LINE IN connector with a 75 Ω termination. Connect (from the PROGRAM LINE OUT in listed order) a 75 Ω cable, a 5 MHz weighting filter, 5 MHz low-pass filter, and a 75 Ω termination to the RMS voltmeter.

CAUTION

Check PREVIEW and AUXILIARY modes only. Program signals may damage the voltmeter.

CHECK—Random noise should be 0.14 mV RMS or less (−75 dB).

NOTE

If the above requirement is not met, coherent noise (produced by a clamp pulse circuit) may be at fault. To eliminate the coherent noise, remove Q820 (see diagram 1) and temporarily connect a 5 kΩ resistor between TP801 and ground while making the above check.

