

User Manual



1740A/1750A Series Waveform/Vector Monitor

070-8470-06

This document supports firmware version 2.2 and above.

www.tektronix.com

Copyright © Tektronix, Inc. All rights reserved.

Tektronix products are covered by U.S. and foreign patents, issued and pending. Information in this publication supercedes that in all previously published material. Specifications and price change privileges reserved.

Tektronix, Inc., P.O. Box 500, Beaverton, OR 97077

TEKTRONIX and TEK are registered trademarks of Tektronix, Inc.

WARRANTY

Tektronix warrants that the products that it manufactures and sells will be free from defects in materials and workmanship for a period of three (3) years from the date of shipment. If a product proves defective during this warranty period, Tektronix, at its option, either will repair the defective product without charge for parts and labor, or will provide a replacement in exchange for the defective product.

In order to obtain service under this warranty, Customer must notify Tektronix of the defect before the expiration of the warranty period and make suitable arrangements for the performance of service. Customer shall be responsible for packaging and shipping the defective product to the service center designated by Tektronix, with shipping charges prepaid. Tektronix shall pay for the return of the product to Customer if the shipment is to a location within the country in which the Tektronix service center is located. Customer shall be responsible for paying all shipping charges, duties, taxes, and any other charges for products returned to any other locations.

This warranty shall not apply to any defect, failure or damage caused by improper use or improper or inadequate maintenance and care. Tektronix shall not be obligated to furnish service under this warranty a) to repair damage resulting from attempts by personnel other than Tektronix representatives to install, repair or service the product; b) to repair damage resulting from improper use or connection to incompatible equipment; c) to repair any damage or malfunction caused by the use of non-Tektronix supplies; or d) to service a product that has been modified or integrated with other products when the effect of such modification or integration increases the time or difficulty of servicing the product.

THIS WARRANTY IS GIVEN BY TEKTRONIX IN LIEU OF ANY OTHER WARRANTIES, EXPRESS OR IMPLIED. TEKTRONIX AND ITS VENDORS DISCLAIM ANY IMPLIED WARRANTIES OF MERCHANTABILITY OR FITNESS FOR A PARTICULAR PURPOSE. TEKTRONIX' RESPONSIBILITY TO REPAIR OR REPLACE DEFECTIVE PRODUCTS IS THE SOLE AND EXCLUSIVE REMEDY PROVIDED TO THE CUSTOMER FOR BREACH OF THIS WARRANTY. TEKTRONIX AND ITS VENDORS WILL NOT BE LIABLE FOR ANY INDIRECT, SPECIAL, INCIDENTAL, OR CONSEQUENTIAL DAMAGES IRRESPECTIVE OF WHETHER TEKTRONIX OR THE VENDOR HAS ADVANCE NOTICE OF THE POSSIBILITY OF SUCH DAMAGES.

General Safety Summary

Review the following safety precautions to avoid injury and prevent damage to this product or any products connected to it. To avoid potential hazards, use this product only as specified.

Only qualified personnel should perform service procedures.

To Avoid Fire or Personal Injury

Use Proper Power Cord

Use only the power cord specified for this product and certified for the country of use.

Connect and Disconnect Properly

Do not connect or disconnect probes or test leads while they are connected to a voltage source.

Ground the Product

This product is grounded through the grounding conductor of the power cord. To avoid electric shock, the grounding conductor must be connected to earth ground. Before making connections to the input or output terminals of the product, ensure that the product is properly grounded.

Observe All Terminal Ratings

To avoid fire or shock hazard, observe all ratings and markings on the product. Consult the product manual for further ratings information before making connections to the product.

General Safety Summary

The common terminal is at ground potential. Do not connect the common terminal to elevated voltages.

Do Not Operate Without Covers. Do not operate this product with covers or panels removed.

Use Proper Fuse. Use only the fuse type and rating specified for this product.

Avoid Exposed Circuitry. Do not touch exposed connections and components when power is present.

Do Not Operate With Suspected Failures. If you suspect there is damage to this product, have it inspected by qualified service personnel.

Do Not Operate in Wet/Damp Conditions.

Do Not Operate in an Explosive Atmosphere.

Keep Product Surfaces Clean and Dry.

Provide Proper Ventilation. Refer to the manual's installation instructions for details on installing the product so it has proper ventilation.

Safety Terms and Symbols

Terms in This Manual. These terms may appear in this manual:



WARNING. Warning statements identify conditions or practices that could result in injury or loss of life.



CAUTION. Caution statements identify conditions or practices that could result in damage to this product or other property.

Terms on the Product. These terms may appear on the product:

DANGER indicates an injury hazard immediately accessible as you read the marking.

WARNING indicates an injury hazard not immediately accessible as you read the marking.

CAUTION indicates a hazard to property including the product.

Symbols on the Product. These symbols may appear on the product:



CAUTION
Refer to
Manual



WARNING
High Volt-
age



Double
Insu-
lated



Protective
Ground (Earth)
Terminal



Not suitable for
connection to
the public tele-
communica-
tions network

General Safety Summary

TABLE OF CONTENTS

Introduction

Product Description	1-1
Features	1-2
Options	1-5
Power Cord Options	1-5
CRT Options	1-6
Accessories	1-7
Standard Accessories	1-7
Optional Accessories	1-7
Field Upgrade Kits	1-8
Installation	1-9
Repackaging for Shipment	1-9
Electrical Installation	1-10
Mains Frequency and Voltage Range	1-11
Remote Connector	1-11
RS232 Connector	1-11
Mechanical Installation	1-12
Cabinets	1-12
Custom Installation	1-12
Rackmounting	1-13
Instrument Configuration	1-15
At A Glance	2-1
Front-Panel Controls	2-1
Rear-Panel Connectors	2-8
Operator's Checkout Procedure	2-12
Required Equipment	2-12
Initial Equipment Connections	2-12
Procedure	2-13

Operation Basics

Functional Overview	3-1
----------------------------------	------------

Table of Contents

Display Modes	3-1
Vector	3-1
Waveform	3-1
Audio	3-2
SCH	3-2
Picture	3-2
Time Code	3-3
Multiple	3-3
Displaying a Signal	3-3
Inputs	3-3
Using the Menus	3-5
General Menu Information	3-5
Multi-Use Bezel Controls and Buttons	3-5
Moving Between Menus	3-5
Clear Menu	3-6
Exiting a Menu Function	3-6
Filter Menu	3-7
Cursor Menu	3-8
Waveform Cursor Control	3-9
Vector + Waveform (Multiple)	3-11
Using the Cursors	3-11
Line Select Menu	3-14
Preset Menu	3-16
Configure Menu	3-18
INPUT	3-18
VECTOR	3-18
FORMAT	3-19
STANDARD	3-20
OFFSET	3-21
CALIBRATE	3-21
REMOTE	3-23
REFERENCE (Dual Standard Only)	3-23
Gain Menu	3-24
CRT Menu	3-24
Remote Operation	3-25
Using Presets through the Remote	3-25

Making Measurements

Basic Measurements	4-1
Waveform Graticule	4-1
Horizontal Scale	4-1
NTSC Vertical Scales	4-2
PAL Vertical Scale	4-3
Dual-Standard Vertical Scale	4-4
Making Waveform Measurements	4-5
Horizontal Sync Amplitude	4-5
Peak White	4-5
K-Factor Measurements	4-5
Vector Graticule	4-7
Making Vector Measurements	4-9
Chroma Bandwidth	4-9
Differential Phase and Gain	4-9
Making SC/H Phase Measurements	4-10
NTSC	4-10
PAL	4-12
SC/H R–Y	4-12
Making Audio Measurements	4-15
Time Code Display	4-16
Calibration	4-17
Adjusting Instrument Gain	4-17

Appendices

Appendix A	
Performance Specifications	A-1
Reliability	A-1
Electrical Specifications	A-2
Certifications and compliances	A-13
Appendix B	
Remote Connectors	B-1
Remote Connector Converter	B-4
Appendix C	
User Service	C-1
Cleaning or Replacing the Fan Filter	C-1
Fuse Replacement	C-1
Graticule Light Replacement	C-2
Cleaning	C-4
Replacing the CRT Filter	C-5
Appendix D	
Software Version	D-1
Glossary	G-1
Index	I-1

LIST OF FIGURES

Figure 2-1. Multi-Use Bezel Controls and Buttons.	2-2
Figure 2-2. 1740A Front Panel.	2-3
Figure 2-3. 1750A Front Panel.	2-4
Figure 2-4. 1740A/ 1750A-Series Rear Panel.	2-10
Figure 2-5. Equipment hook-up for Operator's Checkout Procedure.	2-12
Figure 2-6. Calibrator display.	2-14
Figure 2-7. Two-Line LUM filter display of color bar signal. . .	2-17
Figure 2-8. Two-Line CHROM filter display of color bar signal.	2-17
Figure 2-9. Two-Line DIFF filter display.	2-18
Figure 2-10. Two-Line R-Y display of color bar signal.	2-19
Figure 2-11. SC/H R-Y display (NTSC).	2-19
Figure 2-12. SC/H R-Y display (PAL).	2-20
Figure 2-13. Line Select display in 2 FIELD sweep.	2-21
Figure 2-14. Vectorscope color bar display.	2-22
Figure 2-15. Picture mode display of color bar signal.	2-22
Figure 2-16. Audio display with phase error.	2-23
Figure 2-17. NTSC SC/H display.	2-24
Figure 2-18. PAL SC/H display.	2-24
Figure 3-1. The CRT menu.	3-6
Figure 3-2. The VECTOR CURSOR menu.	3-8
Figure 3-3. The WAVEFORM CURSOR menu.	3-10
Figure 3-4. The VECTOR+WFM CURSOR menu.	3-10
Figure 3-5. The PRESET menu display.	3-16
Figure 3-6. The CONFIGURE menu display.	3-19
Figure 4-1. NTSC waveform/vector graticule.	4-2
Figure 4-2. PAL waveform/vector graticule.	4-3
Figure 4-3. Dual Standard waveform/vector graticule.	4-4
Figure 4-4. Vector targets.	4-8
Figure 4-5. Differential Gain and Phase Measurements.	4-9
Figure 4-6. NTSC dual-dot SC/H display.	4-11
Figure 4-7. NTSC single-dot SC/H display.	4-11
Figure 4-8. PAL SC/H display.	4-12
Figure 4-9. Two-Line SC/H R-Y display (NTSC).	4-13
Figure 4-10. Two-Field SC/H R-Y display (NTSC).	4-13
Figure 4-11. Two-Field SC/H R-Y display (NTSC), showing approximate 10° phase error.	4-14

Table of Contents

Figure 4-12. Two-Field SC/H R-Y display (PAL).	4-14
Figure 4-13. Audio displays.	4-15
Figure B-1. Rear panel REMOTE connector.	B-1
Figure B-2. REMOTE adapter.	B-4
Figure B-3. Rear panel RS232 connector.	B-5
Figure C-1. Graticule light replacement.	C-3

Preface

This user manual is one of a set of two manuals that document the Tektronix 1740A/1750A-Series Waveform/Vector monitors. To purchase a service manual, please refer to “Contacting Tektronix” on Page xiv for address and phone number information.

User Manual

Instrument controls and readouts appear in ALL CAPITALS. Topics covered in the user manual are as follows:

Introduction

Getting Started

Operation Basics

Making Measurements

Appendix A provides instrument specifications, both electrical and mechanical.

Appendix B describes remote control interfaces.

Appendix C covers routine service procedures, such as replacing fuses and graticule light bulbs.

The appendixes are followed by a glossary of specialized terms and an index.

Service Manual

Topics covered in the service manual are as follows:

Specifications

Operating Information

Theory of Operation

Performance Verification

Adjustment Procedures

Maintenance

Options

Electrical Parts List

Diagrams

Mechanical Parts List



1750A Waveform / Vector Monitor.

Contacting Tektronix

Phone	1-800-833-9200*
Address	Tektronix, Inc. Department or name (if known) 14200 SW Karl Braun Drive P.O. Box 500 Beaverton, OR 97077 USA
Web site	www.tektronix.com
Sales support	1-800-833-9200, select option 1*
Service support	1-800-833-9200, select option 2*
Technical support	Email: techsupport@tektronix.com 1-800-833-9200, select option 3* 6:00 a.m. - 5:00 p.m. Pacific time

* **This phone number is toll free in North America. After office hours, please leave a voice mail message. Outside North America, contact a Tektronix sales office or distributor; see the Tektronix web site for a list of offices.**



Introduction

Product Description

The 1740A/1750A-Series are combination waveform/vector monitors in half-rack size packages. The 1740A-Series provides all basic waveform monitor and vectorscope functions; the 1750A-Series provides the same functions with SCH measurement capabilities added. The following products are available:

1740A / 1750A	NTSC
1741A / 1751A	PAL
1745A / 1755A	NTSC / PAL (dual-standard)

Applications

Typical applications for these monitors include video signal monitoring in camera control units, VTR bridges, production switcher consoles, mobile vans and field production systems.

The 1740A-Series is well-suited for portable applications where a small, lightweight monitor is needed, and SCH capability is not required. It is appropriate for many VTR bridge applications, providing remote control and 90/100 Hz sweeps for D-2 servo observation.

The 1750A-Series is useful in the composite edit suite, providing all 1740A-Series features, plus the Tektronix polar SCH display to match color subcarrier-to-horizontal sync timing and color framing among edit sources.

Features

- Composite or Component Waveform Monitoring
- Composite Vector Display
- Menu-Assisted Operation allows expanded feature set.
- Assignable cursors for time and voltage.
- Picture monitor mode for verifying signal source
- Stereo Audio Display
- Longitudinal time code display mode for editing applications
- SCH and Color Framing Display (1750A-Series only)
- External staircase from a camera control unit can be selected remotely.
- Internal video filters provide specialized measurements, with dual or triple filter modes available in PARADE or OVERLAY.
- Eight video inputs can be individually displayed or selected in various combinations.
- Remote interface and serial RS232 interface.

Description of Features

Menu

A notable feature of these monitors is the menu-assisted operation. An expanded feature set is possible through the use of menus and multi-use controls and buttons. When the operator selects a menu item, such as VOLTAGE/TIMING CURSORS, VARIABLE GAIN, or LINE SELECT, an on-screen label shows the current function of the controls.

Many instrument configurations that required moving internal jumpers or wire straps in the 1740/1750-Series monitors are made through an on-screen menu in the 1740A/1750A-Series. The operator can also recall up to 10 front-panel setups through the RECALL menu; 9 recalls are user-program-

mable and 1 is factory-programmed. The FILTER menu also provides a choice of four filters in addition to flat. Two combination filtering modes can be displayed in OVERLAY or PARADE. Refer to “Using the Menus” on page 3-5 for more menu information.

CRT

The monitors have a bright, post-accelerated CRT with lighted internal graticule. The parallax-free internal graticule structure contains targets and markings for both the vector and waveform functions. A white phosphorus CRT is optional; refer to page 1-6 for details.

The bright CRT allows use in high ambient light conditions, such as those encountered in field production applications.

Calibrator

Vertical and horizontal instrument gain can be set using the calibrator signal. The 1 Volt calibrator signal is available in 100 kHz and F_{SC} (color subcarrier) rates.

More Information

- Standard and optional accessories are listed in the Accessories section, which follows this product description.
- Instrument options are listed on page 1-5.
- A complete listing of instrument specifications begins on Appendix page A-1.

Product Description

Options

White phosphor CRT and power cord options are the only options currently available for the 1740A/1750A-Series. Field upgrade kits listed in this section can also be used with these monitors.

Power Cord Options

Any of the following power cord options can be ordered for the 1740A/1750A-Series. If no power cord option is specified, instruments are shipped with a North American 125 V power cord and one replacement fuse.

Unless otherwise specified, power cords for use in North America are UL listed and CSA certified. Cords for use in areas other than North America are approved by at least one test house acceptable in the country to which the product is shipped.

Option A1. Power, Universal Europe, 220 V/16 A
(Locking Power Cord)

Option A2. Power, United Kingdom, 240 V/15 A
(Power Cord)

Option A3. Power, Australia, 240 V/10 A
(Power Cord)

Option A4. Power, North America, 250V/10 A
(Power Cord)

Option A5. Power, Swiss, 240 V/6 A
(Power Cord)

CRT Options

The standard instrument is shipped with a P31 (green) phosphor CRT installed. If Option 74 is ordered, the instrument is shipped with a P4 (white) phosphor CRT installed. The Option 74 CRT part numbers are given in the service manual, at the end of the Replaceable Electrical Parts List.

Accessories

Standard Accessories

These accessories are included with the product:

- 1 Manual, user: 1740A/1750A-Series (070-8470-XX)
- 1 Cable assembly, power: United States and Japan only (161-0216-XX)
- 1 Cable assembly, power: all other countries (161-0066-XX)
- 1 Fuse, cartridge: 3AG, 2A, 250V, fast-blow (159-0021-00)
- 4 Light bulbs: graticule scale (150-0168-00). See page C-1 for replacement instructions.
- 4 Air filters: fan (378-0335-00). See page C-1 for replacement instructions.

This accessory is installed on the product:

- 1 CRT filter: smoke gray (378-0258-00)

Optional Accessories

Manual, service: 1740A/1750A/1760-Series (070-8469-XX)

Camera, C9 Option 20

Viewing Hood (016-0475-00)

Front-Panel Cover (200-3897-01)

Field Upgrade Kits

1700F00 Plain Cabinet — This plain metal half-rack size cabinet is painted silver-gray. Ventilating holes in top, bottom, and sides of the cabinet allow heat generated within the instrument to dissipate.

1700F02 Carrying Case — This portable cabinet is similar to the 1700F00, but has feet, carrying handle, flip-stand, and front cover.

1700F05 Side-by-Side Rack Adapter — The 1700F05 allows the user to mount two half-rack width instruments in a standard 19-inch rack.

1700F06 Blank Panel — If only one section of a 1700F05 is used, the 1700F06 Blank Panel can be inserted in the unused section to improve appearance and air flow.

1700F07 Utility Drawer — When only one side of a 1700F05 is used, this utility drawer can be installed in the unused section to provide storage. The drawer opens and closes freely, unless latched for transport.

Ordering — These items can be ordered with the monitor, or purchased through a Tektronix field office or distributor. When ordering, include both the name and number of the Field Upgrade Kits.

Installation — Cabinet installation instructions begin on page 1-12. Dimensional drawings are also shipped with each cabinet. For more information, contact a Tektronix field office or distributor.

Installation

Unpacking

Save the shipping carton and packing materials (including anti-static bag) in case it becomes necessary to ship the instrument to a Tektronix Service Center for service or repair.

Accessories

Check that the following accessory items are included:

- User Manual
- Service Manual
Note: The Service Manual is an optional accessory that must be ordered to be received.
- Power Cord
- Replacement Fuse Cartridge (1)
- Replacement Graticule Light Bulbs (4)
- Replacement Air Filters for Fan (4)

Repackaging for Shipment

If it becomes necessary to ship the instrument to a Tektronix Service Center for service or repair, follow these instructions for repackaging:

1. Attach a tag to the instrument showing: the owner, complete address and phone number of someone at your firm who can be contacted, the instrument serial number and a description of the required service.
2. Package the instrument in the original packaging materials. If the original packaging materials are not available, follow these directions:

Installation

- a. Obtain a carton of corrugated cardboard having inside dimensions six or more inches greater than the dimensions of the instrument. Use a shipping carton that has a test strength of at least 275 pounds.
 - b. Surround the instrument with a protective bag (anti-static preferred). For instruments which are not in a cabinet, wrap a cardboard piece around the bagged instrument to protect components.
 - c. Pack dunnage or urethane foam between the instrument and the carton. If using Styrofoam kernels, overfill the box and compress by closing the lid. There should be three inches of tightly packed cushioning on all sides of the instrument.
3. Seal the carton with shipping tape, industrial stapler, or both.

Electrical Installation

Power Source

These monitors are designed to operate from a single-phase power source having one of its current-carrying conductors at or near earth ground (the neutral conductor). Only the line conductor is fused for over-current protection. Systems that have both current-carrying conductors live with respect to ground (such as phase-to-phase on multiphase systems) are not recommended as power sources. A protective ground connection by way of the grounding conductor in the power cord is essential for safe operation.

NOTE

When power is supplied, line voltage will be present in the instrument, even if the POWER switch is set to STANDBY.

WARNING

Mains Frequency and Voltage Range

The 1740A/1750A-Series monitors operate at 50 and 60 Hz, over the range of 90-250 Volts, without operator adjustment.

Remote Connector

The rear-panel REMOTE connector is a 25-pin, D-type connector. It provides the input for RGB/YRGB staircase, external horizontal, and remote sync. It also accepts the input signals for external blanking, time code, stereo L and R audio. TTL signal or ground closure to designated pins will enable Staircase, External Horizontal, or Remote Sync displays. Eight front-panel setups can also be stored and recalled through the REMOTE connector. REMOTE connector pin assignments begin on page B-1.

RS232 Connector

The rear-panel RS232 connector is a 9-pin subminiature D-type connector that provides a serial interface for remote control. The RS232 pin assignments are given on page B-1.

The RS232 interface is not supported at the time of this printing.

Operational Changes

No operational modifications are made to these monitors through internal jumper settings. Input coupling, DC RESTORER clamp time, RGB/YRGB selections and other similar configurations are changed through the on-screen menu. Instrument configuration is described on page 3-18.

Mechanical Installation

All qualification testing was performed with a Tektronix 1700F00 cabinet installed. To guarantee compliance with specifications, the instrument should be operated in a cabinet or rackmount adapter. The Tektronix 1700F00, 1700F02, and 1700F05 provide the proper electrical environment for the instrument, supply adequate shielding, minimize handling damage, and reduce dust collection within the instrument.

Cabinets

WARNING

Do not lift a cabinetized instrument without installing the mounting screws. There is nothing to hold the instrument in the cabinet if it is tipped forward.

The 1700F00 is a plain cabinet designed for permanent installations, and the 1700F02 is a portable cabinet with handle, feet, flipstand, and front cover. Ordering information is given on page 1-8.

Custom Installation

For applications such as consoles, the instrument can be mounted with front molding flush or protruding from the console. In both cases, allow approximately three inches of rear clearance for BNC and power-cord connections. To mount the instrument safely, attach it to a shelf strong enough to hold its weight, using the four 0.156-inch diameter holes in the bottom of the 1700F00 cabinet. Refer to the data sheet included with the cabinet for hole locations.

Rackmounting

The 1740A/1750A-Series monitors are half-rack width and three rack units high. They require approximately three inches of rear clearance for power cord and cable connections, and 20 inches in front of a rack for installation and removal of the instrument.

The optional 1700F05 rack adapter allows two Tektronix half-rack instruments to be mounted side-by-side in a rack. It is adjustable so that the instrument can be closely aligned with other equipment in the rack. If only one section of the rack adapter is used, a 1700F06 blank panel or 1700F07 utility drawer can be inserted in the unused section. Ordering information is given on page 1-8.

Installation

Instrument Configuration

Focus, scale illumination, signal intensity, readout intensity, and trace rotation are set through the CRT menu.

Several instrument operating parameters can be set through the CONFIG menu.

Instructions for using these menus begin on page 3-18.

Instrument Configuration



Getting Started

AT A GLANCE

Front-Panel Controls

The following is an overview of front-panel controls. Figure 2-2 shows the 1740A front panel and Figure 2-3 shows the 1750A front panel.

Controls—Switches—LEDs

- All front-panel controls are the continuous action type, and all front-panel buttons are push-and-release toggle switches.
- Green LEDs light to indicate the current switch selection.

POWER

- **ON/STANDBY** turns the instrument on or to standby status. An LED indicates when power is on.

WARNING

If an appropriate power source is supplied to this instrument, line voltage will be present, even when in STANDBY mode. Do not operate the instrument without a cabinet or rack adapter such as those described on page 1-8; serious injury could result.

Instrument Reset

Certain conditions may cause the 1740A/1750A-Series instrument front-panel controls to become locked. Reset as follows:

- Turn off instrument power.
- Depress and hold the CLEAR MENU and WAVEFORM buttons while you turn instrument power on again. Hold both buttons in until the instrument returns to its normal operating state.
- If this reset does not unlock the controls, contact your Tektronix field office or call Tektronix at the phone number listed in the front of this manual.

Multi-Use Controls

- The center three controls located under the CRT have functions assigned and labeled through the on-screen menus and readouts. These controls will be referred to as *Bezel Controls*. See Figure 2-1.
- Five small buttons along the right side of the CRT enable users to make selections when on-screen menus are in use. These buttons will be referred to as *Bezel Buttons*.

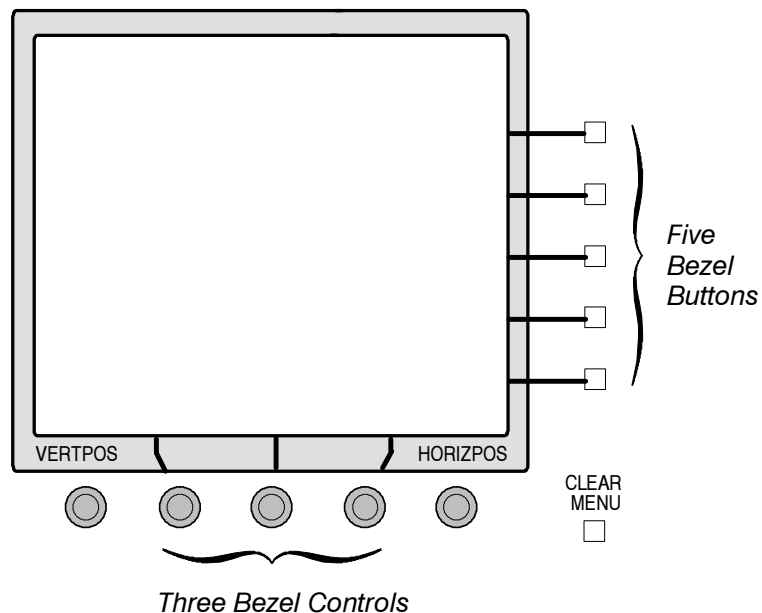

Figure 2-1. Multi-Use Bezel Controls and Buttons.

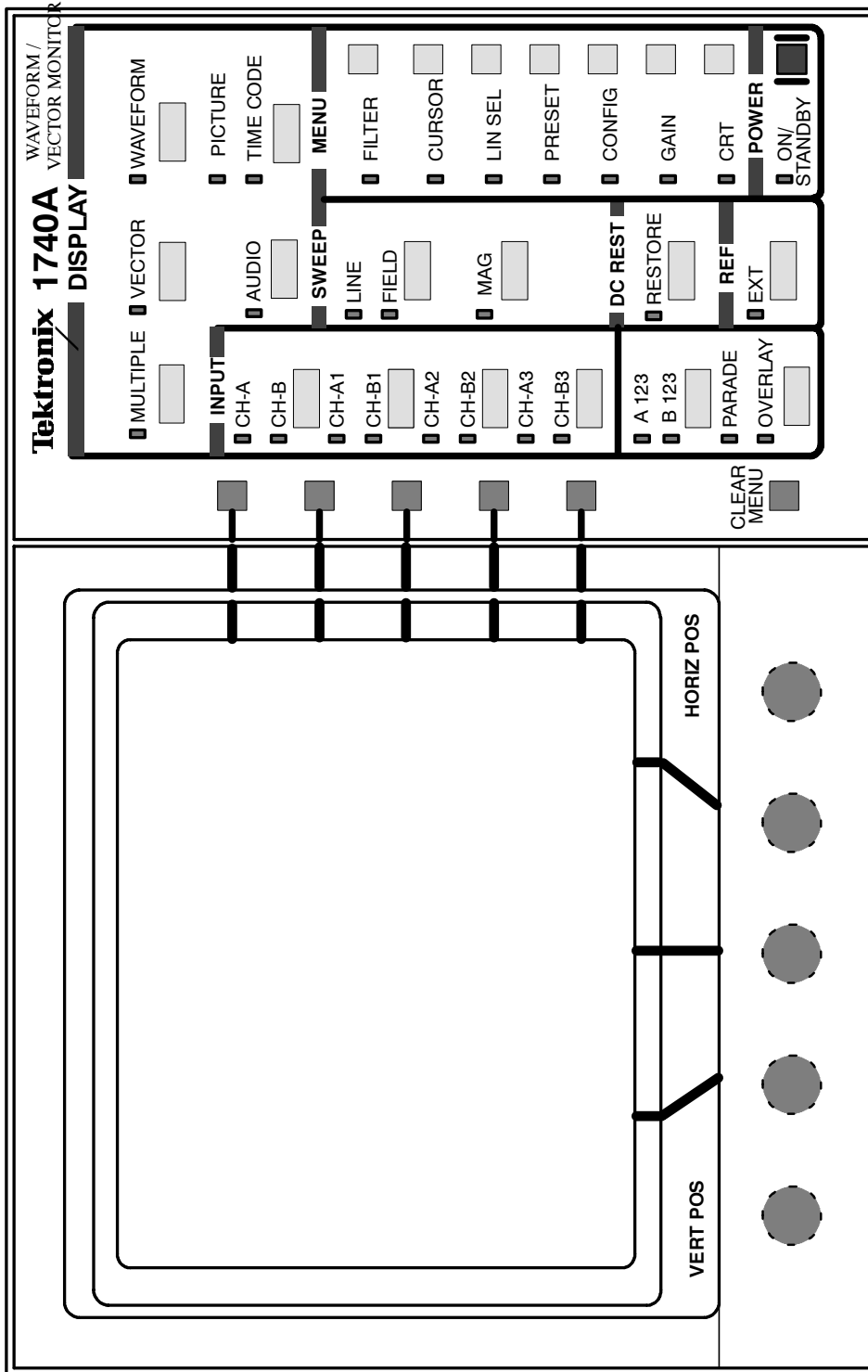

Figure 2-2. 1740A Front Panel.

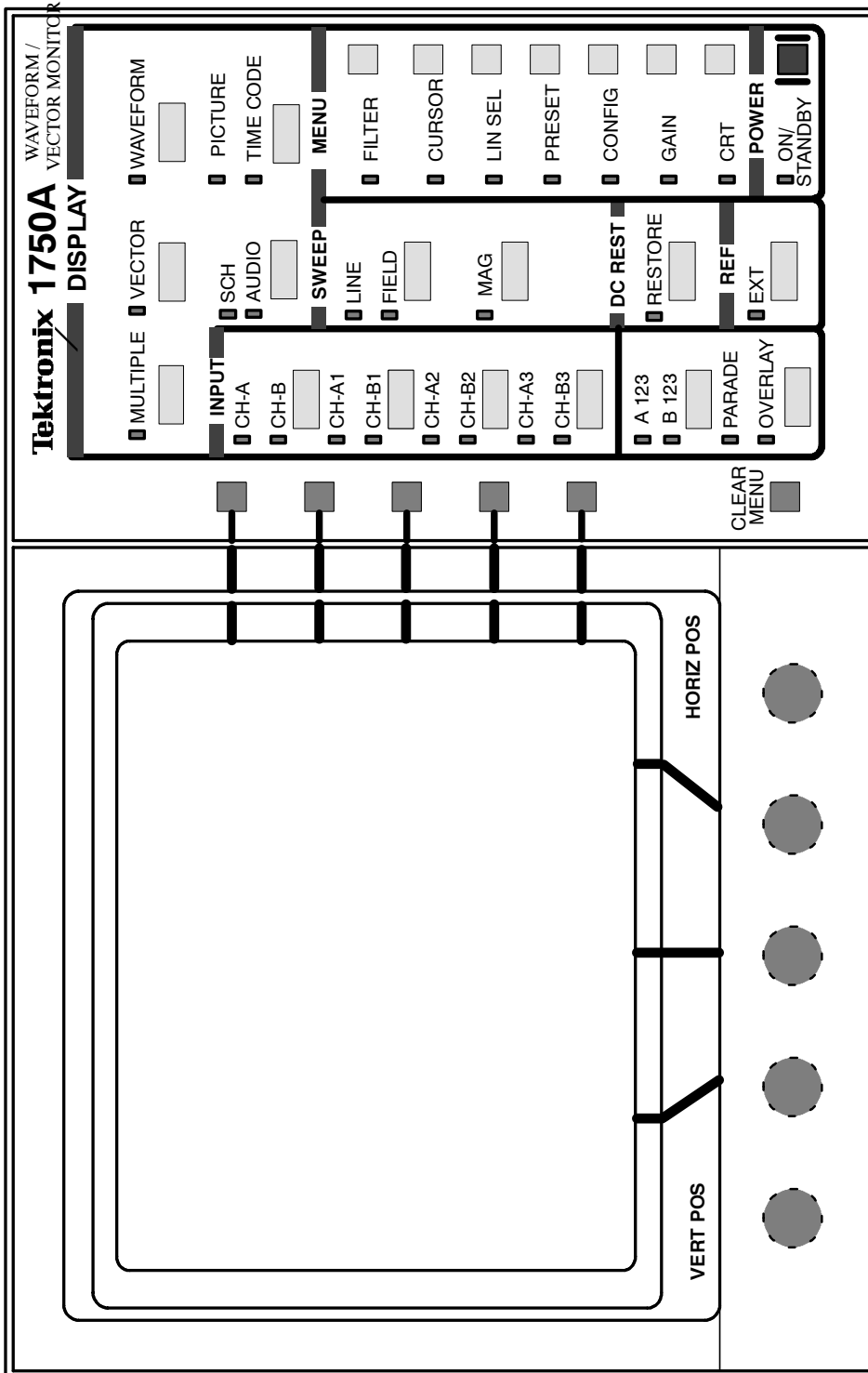

Figure 2-3. 1750A Front Panel.

POSITION

- **VERT POS** allows the signal display to be moved vertically. Offsets for channels A2/A3 and B2/B3 are enabled through the CONFIGURE menu.

DISPLAY

- **WAVEFORM** provides voltage vs. time display of the video signal.
- **VECTOR** presents an XY plot of demodulated chrominance phase and amplitude.
- **AUDIO** amplitude and phase is monitored using a calibrated X/Y Lissajous display.
- **SCH** provides a vector display of the subcarrier-to-horizontal-sync phase relationship.
- **PICTURE** allows the operator to verify the signal source.
- **TIME CODE** provides monitoring of longitudinal time code in a frame-rate display.
- **MULTIPLE** allows simultaneous selection of multiple DISPLAY modes.

SWEEP

Sweep buttons are used to select the waveform sweep rate.

- **LINE/FIELD** sequences through four sweep rate selections: one line, two line, one field, and two field.
- **MAG** turns on the sweep magnifier. See page 3-4.

DC REST

- **RESTORE** turns DC Restorer on or off. The DC Restorer speed and clamp point are selected through the CONFIGURE menu, shown on page 3-18.

REF

- **EXT** toggles between external reference (EXT LED on) and internal reference. Internal reference can be configured for component operation, and two external reference inputs can be designated for dual-standard instruments. See the CONFIGURE menu on page 3-18.

INPUT

- Selecting a front-panel input causes the signal that is input to the corresponding rear-panel connector to be displayed on screen.
- Without PARADE or OVERLAY selected, only one input selection can be made at a time. Each input channel button (including A123 / B123) toggles between A and B, and is cancelled when another input button is pressed.
- With PARADE or OVERLAY selected, multiple input selections can be made; input buttons select A, B, both, or off, and do not cancel each other.

A123

A123 provides a side-by-side display of the CH-A1, CH-A2, and CH-A3 inputs (B123 displays the CH-B1, CH-B2, and CH-B3 inputs). Selecting A123 or B123 turns off all other input channels. When PARADE or OVERLAY is selected, A123 and B123 can be displayed together and in combination with other inputs.

PARADE

PARADE displays up to four input channels side-by-side, with any additional inputs overlaid. Selecting PARADE displays the input channel(s) last selected for PARADE, allowing a custom configuration of inputs. In PARADE mode, the LINE/FIELD button offers only two choices: one line and one field.

OVERLAY

OVERLAY provides an overlaid display of all selected inputs.

MENU

Push the desired menu button to enter that menu and enable the associated functions. Push the button again to exit the menu and disable the function. Refer to page 3-5 for more information about using menus.

- **FILTER** allows choice of flat or filtered display of the waveform signal.
- **CURSOR** enables timing cursors, voltage cursors, and markers for the waveform display. Polar cursors and markers are available for the vector display.
- **LIN SEL** allows the selection of a single line or group of lines for display.
- **PRESET** allows the user to store and recall up to 9 front-panel setups. One additional recall is factory pre-programmed. Presets one through eight can also be accessed remotely.
- **CONFIG** allows the user to configure several operating parameters, such as input coupling, dc restorer speed, and internal reference designation.
- **GAIN** provides selection of X1, X5, X10, and variable gain.
- **CRT** menu allows adjustment of CRT focus, signal intensity, and trace rotation.
- **CLEAR MENU** turns off the selection portions of the menu readout. When CLEAR MENU has been used to clear a menu readout, push the menu button once to reinstate the readout, and once again to exit the menu.

Rear-Panel Connectors

The following is an overview of rear-panel connectors. Figure 2-4 shows the 1750A rear panel.

Loop-Through Inputs

- **INPUTS A, A1, A2, A3, B, B1, B2, and B3** are passive loop-through video inputs, compensated for 75 Ω . The front-panel INPUT switch settings determine which channel(s) are displayed. The eight inputs can be configured for composite or component video signals.
- **EXT REF** is a 75 Ω compensated loop-through synchronization input. Internal or external reference is selected through the front-panel REF EXT switch; the LED lights to show when external is selected. The instrument will operate from external references of composite video or black burst.

Outputs

- **PIX OUT** is a 75 Ω compensated output of the video signal selected by the front-panel INPUT switches. This signal has bright-up in LINE SELECT mode, and is used to drive a picture monitor. PIX OUT strobe is not present below line 11.

Multi-Pin Connectors

- **REMOTE** is a 25-pin subminiature D-type connector which uses TTL signal or ground closures to provide remote control of many front-panel functions. For more information, see page 3-25 and page B-1.
- **RS232** is a 9-pin subminiature 'D-type connector that provides a serial interface for remote control. *The RS232 interface is not supported at the time of this writing.*

Fuse

- The instrument's mains fuse should be replaced only with a 250V, 2A, F-type cartridge fuse. A replacement fuse is included with the instrument.

AC Power

- The **AC POWER** plug is a standard ac plug receptacle for 120 or 240 Vac power mains. The plug is compatible with any of the power cord options available with the 1740A/1750A-Series.

Fan Filter

- Four replacement air filters for the fan are included with the instrument. Refer to page C-1 for replacement and cleaning instructions.

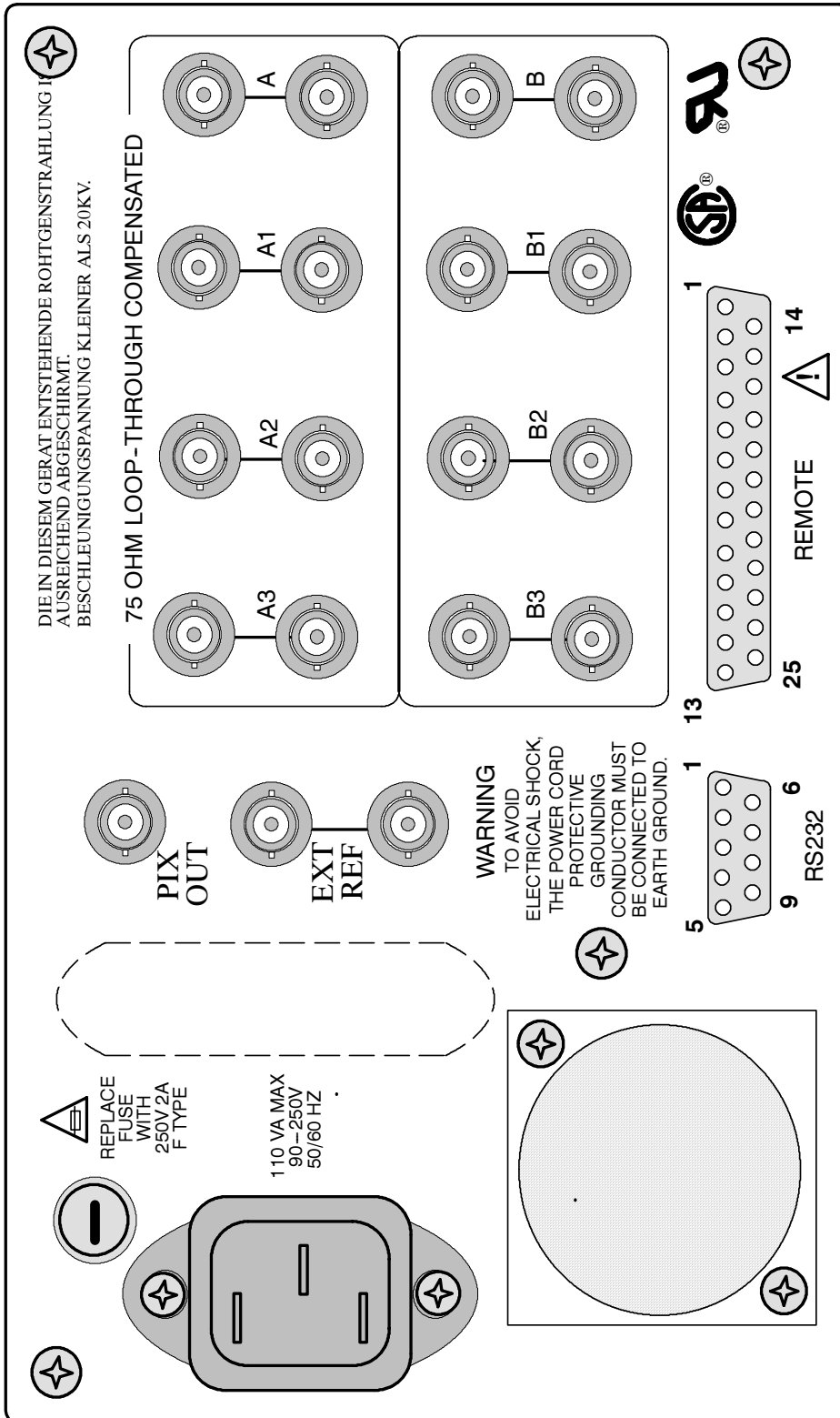

Figure 2-4. 1740A/1750A –Series Rear Panel.

Operator's Checkout Procedure

Before proceeding, read *At A Glance* starting on page 2-1.

This procedure is designed for operator familiarization and for checking basic instrument operation (not measurement quantities or specifications). All illustrations are of the 1750A unless otherwise noted.

If performing this procedure reveals improper instrument operation, first check the operation of the associated equipment. If the associated equipment is operating normally, refer the 1740A/1750A-Series to qualified service personnel for repair or adjustment.

Required Equipment

The following equipment is required to perform this procedure:

1. Television Signal Generator with:

Composite Color Bars

For example: TEKTRONIX TSG 130 Series Signal Generator.

2. Coaxial Cable, 75 Ω (5)

For example: 42-inch RG59U (Tektronix Part No. 012-0159-00)

3. 75 Ω Terminators, End-line (4)

For example: (Tektronix Part No. 011-0102-00)

Initial Equipment Connections

- Connect the 1740A/1750A-Series to an appropriate AC power source.

Operator's Checkout Procedure

- Connect the generator NTSC output (COMPOSITE for TSG131) to the CH-A input. Connect the CH-A loop-through to the EXT REF input and connect a 75Ω terminator to the EXT REF loop-through. See Figure 2-5.

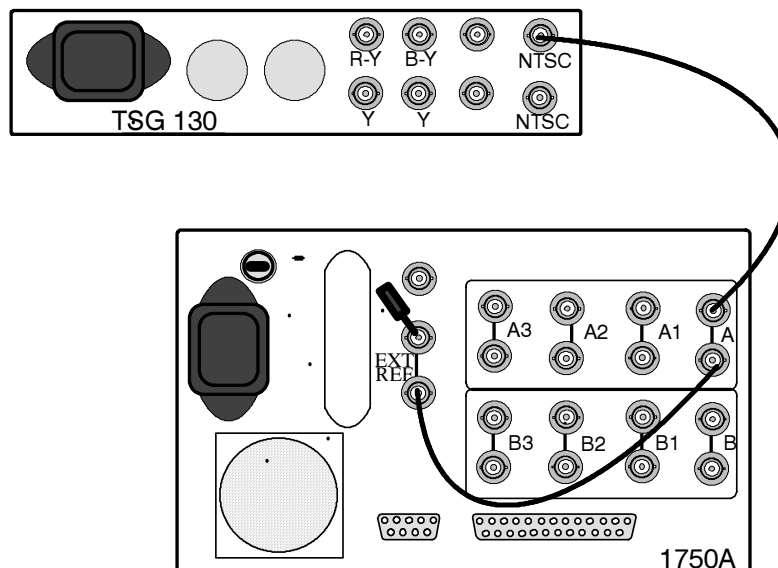

Figure 2-5. Equipment hook-up for Operator's Checkout Procedure.

Procedure

1. Initialize the Front-Panel Controls

Enter the PRESET menu and select FACTORY. Press the bezel button corresponding to RECALL. The front-panel controls are now set to the factory preset (described on page 3-16), and the PRESET menu is automatically exited. Notice that the instrument is in the WAVEFORM display mode with the CH-A INPUT displayed in two-line sweep.

2. Adjust the Display

Use the VERT POS and HORIZ POS controls to center the display.

Enter the CRT menu. DISPLAY will be outlined. Adjust the bezel controls for optimum focus, graticule scale illumination, and signal intensity. Select READOUT and adjust the right bezel control for desired readout intensity. Select TRACE and adjust the center bezel control for a level trace.

Exit the CRT menu. The changes made while in the menu remain in effect.

3. Input Channel Selection

Press the EXT and PARADE buttons. Check that CH-A, CH-A1, CH-A2, and CH-A3 inputs are selected.

The CH-A signal should appear on the left side of the CRT.

Move the generator signal (and EXT REF cable) to CH-A1. The display should move to the right. Repeat this step until the signal is connected to CH-A3 and the display is at the far right-hand side of the screen.

Change the input selections to CH-B, CH-B1, CH-B2, and CH-B3. Repeat the process of moving the generator signal.

4. Check Gain

The 1740A/1750A-Series internal calibrator can be used to check instrument calibration. Select CH-A input and set the generator for NTSC Color Bars output.

Enter the configuration menu and select CALIBRATE. Turn on the calibrator signal and note that the amplitude is 140 IRE (1.0 V PAL), with one cycle per division. See Figure 2-6.

Select VECTOR display mode. Note that the calibrator signal overlays the compass rose. Return to WAVEFORM display mode.

Exit the configuration menu. Note that the calibrator signal is automatically turned off. (For more information on using the calibrator signal, see page 3-21 and page 4-17.)

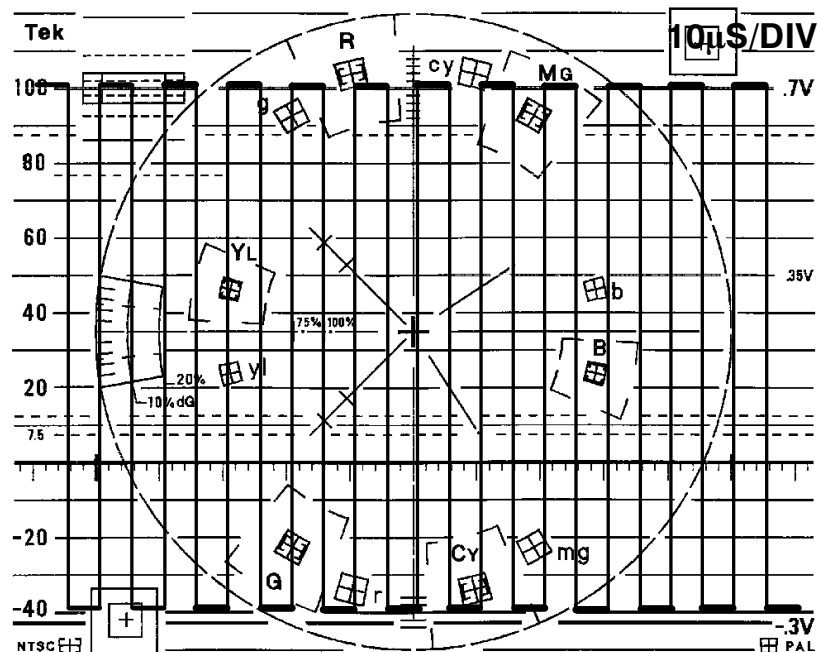

Figure 2-6. Calibrator display.

5. Gain Control

There are three calibrated vertical gain settings available (X1, X5, and X10), as well as an independent variable gain control. Enter the GAIN menu and select X5. Note that X5 is outlined and the display is amplified. Select X10. Note that X10 is outlined and the display is amplified again.

Select variable gain and use the right bezel control to adjust the gain to the minimum and maximum settings.

Exit the GAIN menu, then enter it again. Note that the variable and X10 gain settings are restored. Exit the GAIN menu. Adjust the VERT POS control to place the signal on baseline.

6. Select Timing Reference

The factory preset selects a two-line sweep. Note that pressing the LINE/BUTTON button will cycle through four selections: one-line, two-line, one-field, and two-field sweeps. Return to the two-line sweep.

Press the MAG button. The MAG indicator lights and a 1 μ S/Div sweep is displayed. Use the HORIZ POS control to view the magnified display, then turn off the MAG. (See page 3-4 for a list of sweep rates.)

7. Voltage and Timing Cursors

The 1740A/1750A-Series voltage, timing, and vector cursors can be used to measure any portion of the displayed signal.

Enter the CURSOR menu (factory preset selects voltage cursors; VOLT is outlined on screen). The voltage cursors appear as two dashed horizontal lines: cursor 1 has single dashes and cursor 2 has double dashes. Use the left and center bezel controls to adjust the cursors individually, or the right control to move both cursors by the same amount (TRACK). The voltage difference between the cursors is displayed as ΔV . Align a voltage cursor with a signal reference point and press MAG. The cursor is still at the same point on the signal (use the HORIZ POS control if needed to view the cursor).

Select timing cursors (TIME). The timing cursors appear as two vertical dashed lines: cursor 1 has single dashes and cursor 2 has double dashes. The time difference between them is displayed as ΔT . Select voltage and timing cursors together (V+T). Note that when CONTROL is set to TIME, the three bezel controls adjust timing cursors; when set to VOLT, they adjust voltage cursors.

Select markers (MARK). The markers appear as three dashed lines; marker 1 has long single dashes, marker 2 has double dashes, and marker 3 has short dashes. Use the three bezel controls to position the markers to a reference point on the etched graticule (such as peak white, baseline, and sync tip). Select X5 gain and notice that the markers do not move. These markers can be used to highlight desired features of the waveform graticule.

Turn off the GAIN menu, then press the CURSOR button. Select VECTOR display mode. The vector cursor menu is displayed (POLAR has been selected by the factory preset). The polar cursor appears as cross hairs. Use the left bezel

control to move the cursor away from graticule center, and the center bezel control to move the cursor around the graticule center point. Note that the amplitude and phase of the cursor are displayed on screen.

Select MARK and set QUANTITY to 2. Move the marker by rotating the AMPLITUDE knob. Note that the two graticule markers appear as small numbered boxes. Set CONTROL to 1 and use the left bezel control to move marker 1 away from the graticule center. Use the center control to move the marker around the graticule center point. Change CONTROL to 2. Use the bezel controls as for marker 1. Select X5 gain and note that the markers do not move. These markers can be used to highlight desired features of the vector graticule. Return to WAVEFORM display mode.

Exit the CURSOR menu, then enter the menu again. Note that MARK is still selected and marker positions are unchanged. Exit the menu. (For more information about using the cursors, see page 3-8.)

8. Filter Selection

The 1740A/1750A-Series offers several filter selections for the waveform display.

Ensure that the instrument is operating in waveform mode. Enter the FILTER menu (FLAT is selected by the factory preset). Select LUM filter. This provides a low-pass-filtered display of the luminance portion of the signal. See Figure 2-7.

Select CHROM. This provides a bandpass-filtered display of the chrominance portion of the signal. See Figure 2-8.

Select F+L (FLAT plus LUM). The flat display is superimposed on the luminance-filtered display (overlay is selected by the factory preset). Press the appropriate bezel button (not the front-panel PARADE button) to select parade. The flat display is now on the left, followed by the luminance-filtered display.

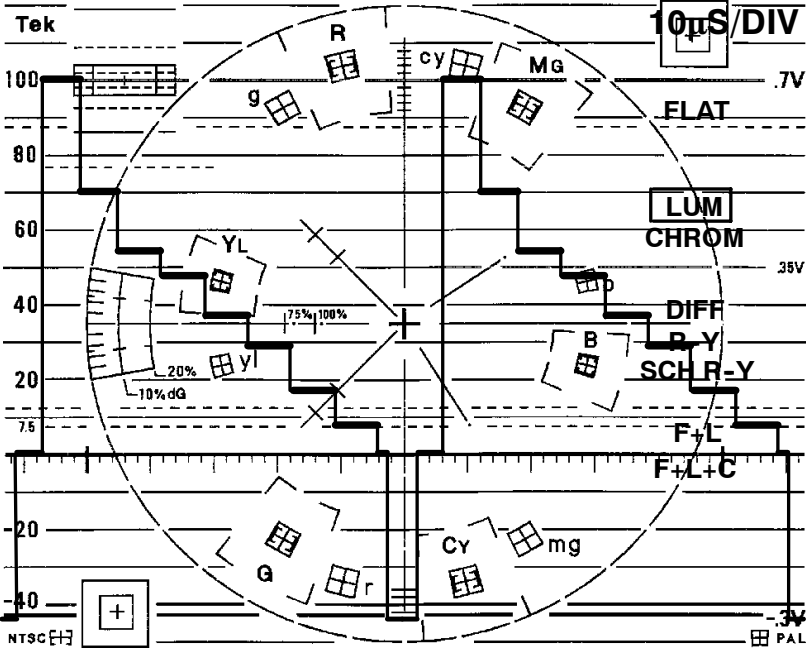

Figure 2-7. Two-Line LUM filter display of color bar signal.

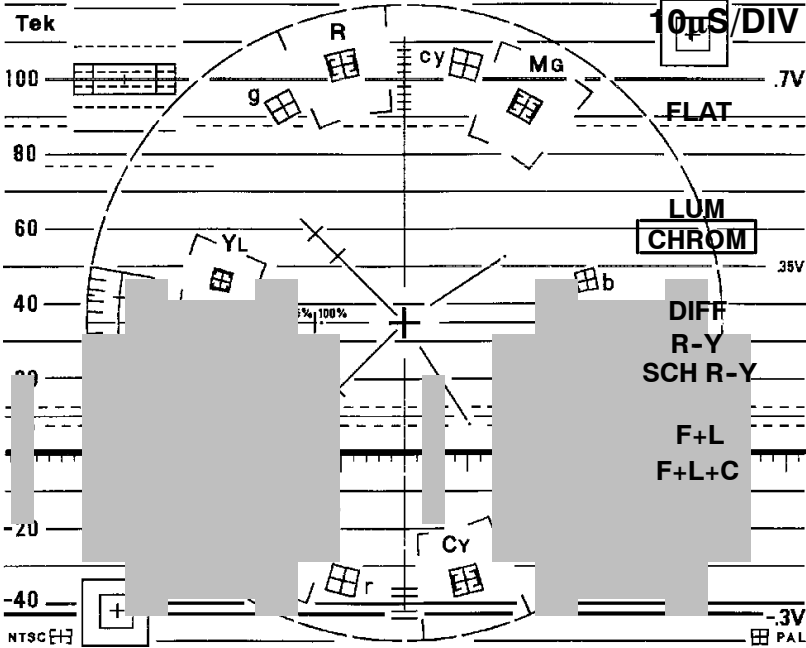

Figure 2-8. Two-Line CHROM filter display of color bar signal.

Operator's Checkout Procedure

Select F+L+C (FLAT plus LUM plus CHROM). The display is similar to the F+L display, with the chrominance-filtered signal added on the right.

Select DIFF. Select the generator 5-step staircase signal. The differentiated-step filtered display appears similar to Figure 2-9.

Select R-Y. This provides a demodulated chrominance-versus-time display. Use the right bezel control to adjust vector phase. See Figure 2-10.

Select SCH R-Y (1750A only). This provides a demodulated SC/H sync-locked oscillator display, useful for viewing SC/H variations versus time. A sample NTSC display is shown in Figure 2-11. NTSC signals can be viewed in either line or field sweeps. For PAL applications, view the signal in two-field sweep (see Figure 2-12). Use the right bezel control to adjust vector phase.

Exit the FILTER menu. Enter the menu again and note that the filter selections are unchanged. Select FLAT. Exit the menu.

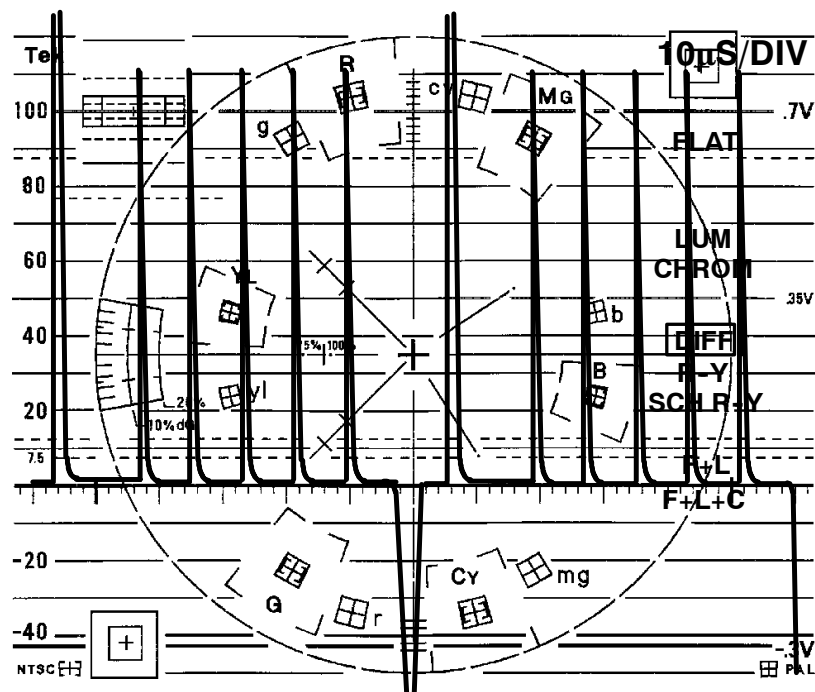

Figure 2-9. Two-Line DIFF filter display of 5-step staircase signal.

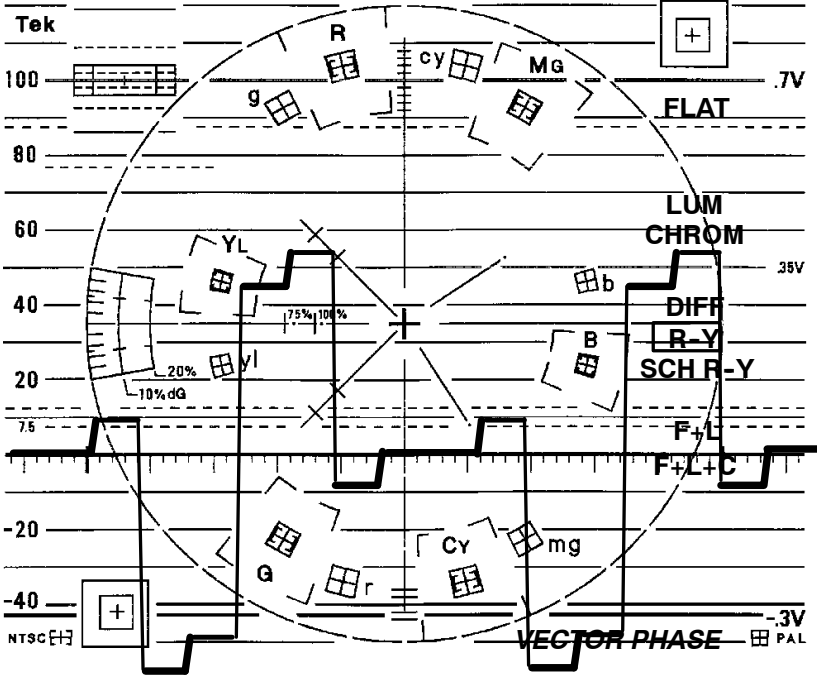

Figure 2-10. Two-Line R-Y display of color bar signal.

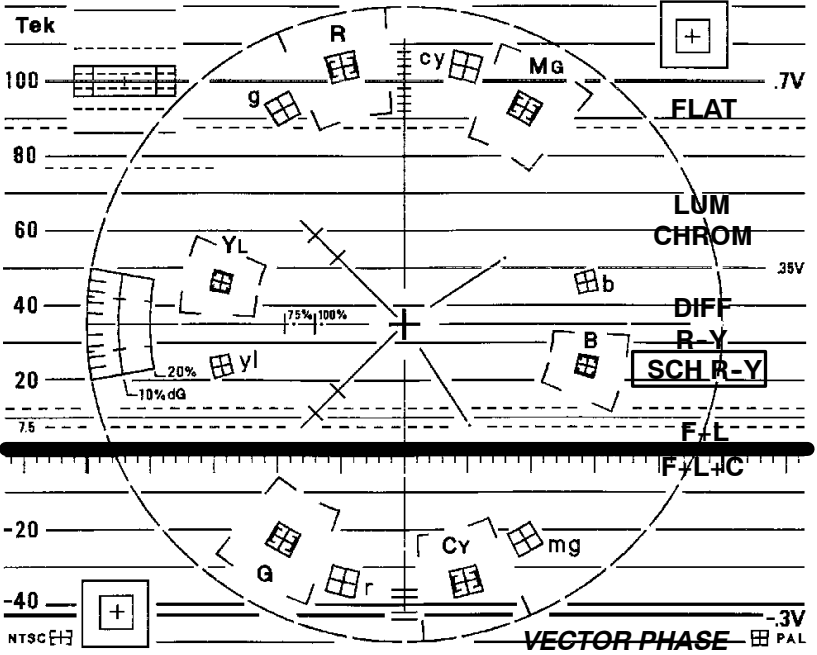

Figure 2-11. Two-Field SC/H R-Y display (NTSC), showing proper SCH phase.

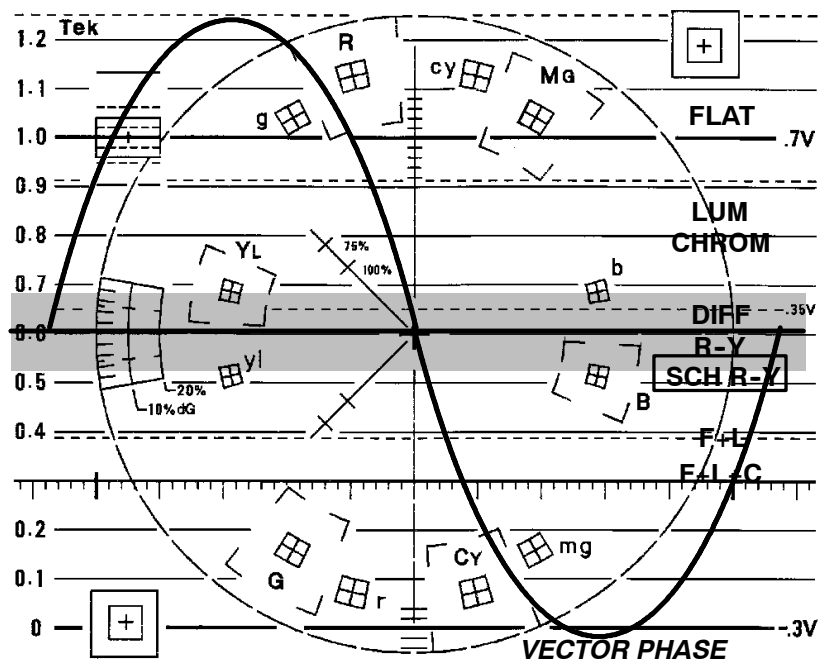

Figure 2-12. Two-Field SC/H R–Y display (PAL), showing proper SCH phase.

9. Line Selection

Line select is available in the following display modes: WAVEFORM, VECTOR, SCH (1750A-Series only), and PICTURE. Enter the LINE SELECT menu and turn the center bezel control until the readout displays **ALL 131**. In a two line display, line 131 appears on the left, followed by line 132.

Select 2 FIELD sweep and note the intensified line in each field. Select 15H and note that 15 lines are now intensified in each field (intensified portion appears wider). The readout is now **ALL 131-- 145**. See Figure 2-13.

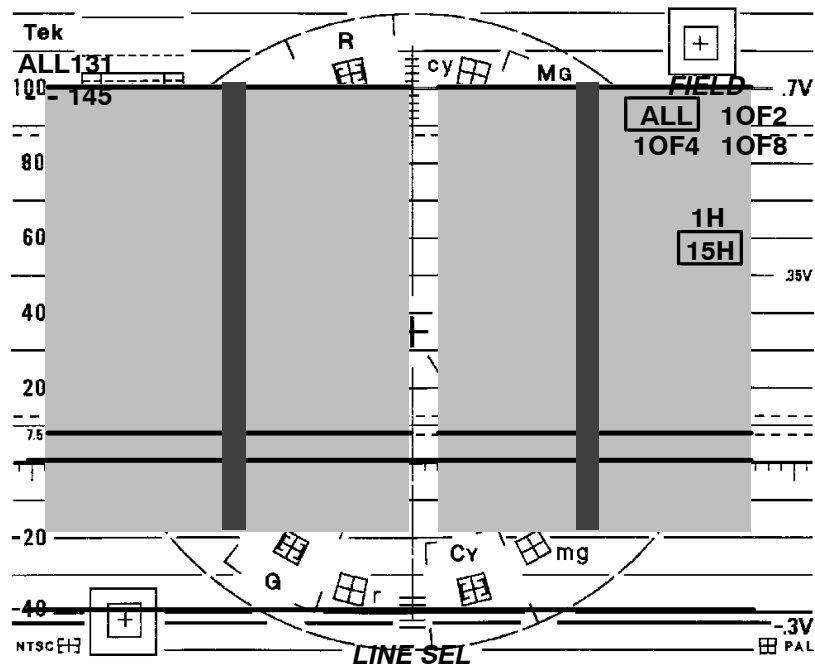

Figure 2-13. Line Select display with 15H selected, in 2 FIELD sweep.

Select 1 of 2. Now only the first field has intensified lines, and a NEXT FIELD selection appears. Select NEXT FIELD and note that the intensified lines now appear only in the second field and the readout is **F2 131 F2 145**.

Select MULTIPLE with WAVEFORM, VECTOR, and SCH (1750A-Series only). Note that the displays appear in the order listed here. Exit the line select menu. Enter the menu again and note that the user settings are saved. Exit the menu.

10. Vectorscope Display

Select VECTOR display mode. Adjust the right bezel control to place the burst vector on the 180° graticule line. The display should appear similar to Figure 2-14.

11. Picture Monitor Display

Select PICTURE display mode. A picture monitor display of the selected input signal appears. This can be used to visually identify the signal source. See Figure 2-15.

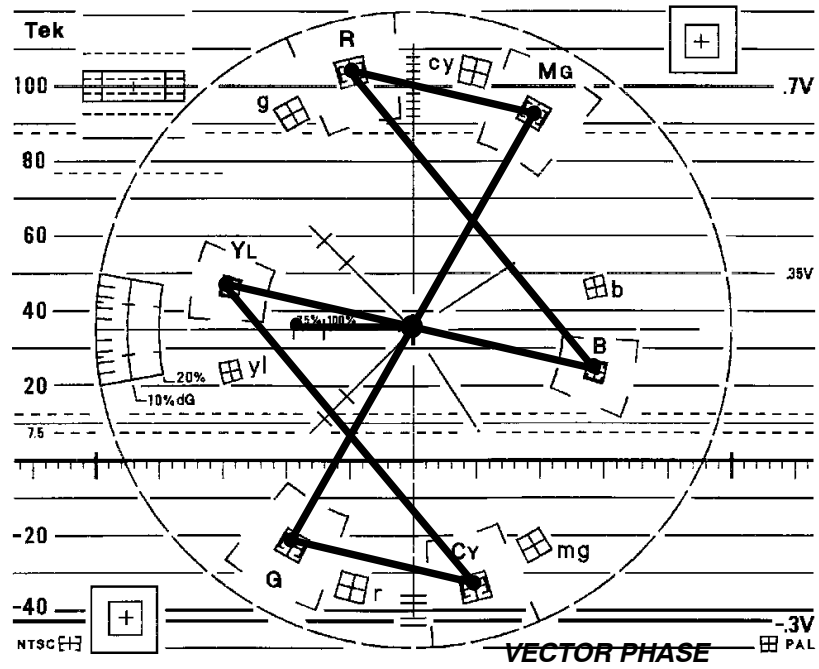

Figure 2-14. Vectorscope color bar display.

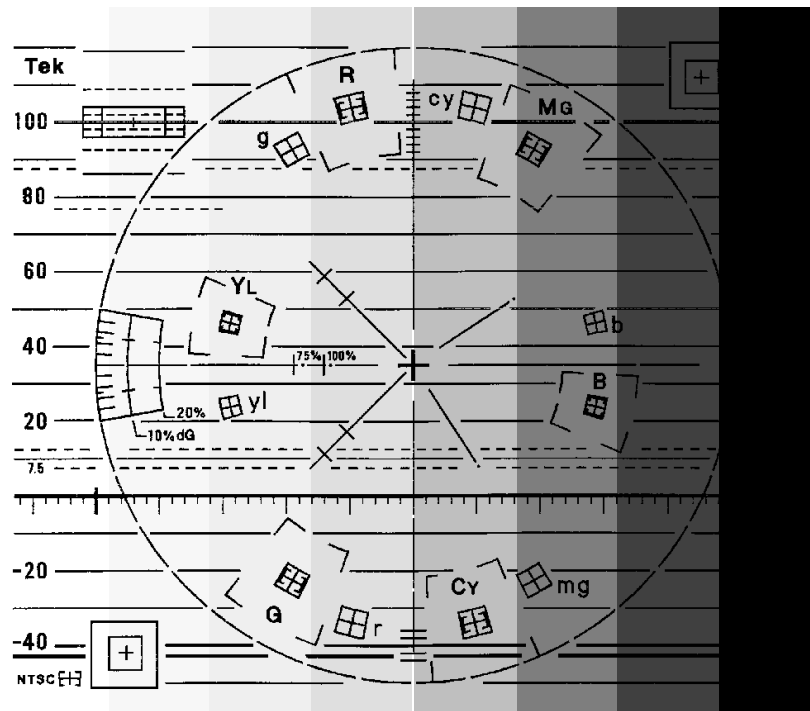

Figure 2-15. Picture mode display of color bar signal.

12. Audio Display

To obtain an audio display, connect the left and right audio signals to the rear-panel REMOTE connector as follows: +Y to pin 8, -Y to pin 9, +X to pin 10, and -X to pin 11. Select AUDIO display mode.

An audio signal with no phase error appears as a straight line extending from the audio box in the upper right corner of the graticule to the box in the lower left. A signal with phase error appears as an opening in a lissajous waveform. See Figure 2-16.

13. SCH Display (1750A Only)

The SCH display mode provides a vector display of the subcarrier-to-horizontal-sync phase relationship. (SCH measurements appear on page 4-10.)

For NTSC operation, verify that REF is set to internal, then select SCH display mode. This provides a dual-dot display, as shown in Figure 2-17. Select EXT REF. This provides the single-dot display, shown in Figure 2-18.

For PAL operation, the REF selection does not affect the display. A sample PAL display is shown in Figure 2-18.

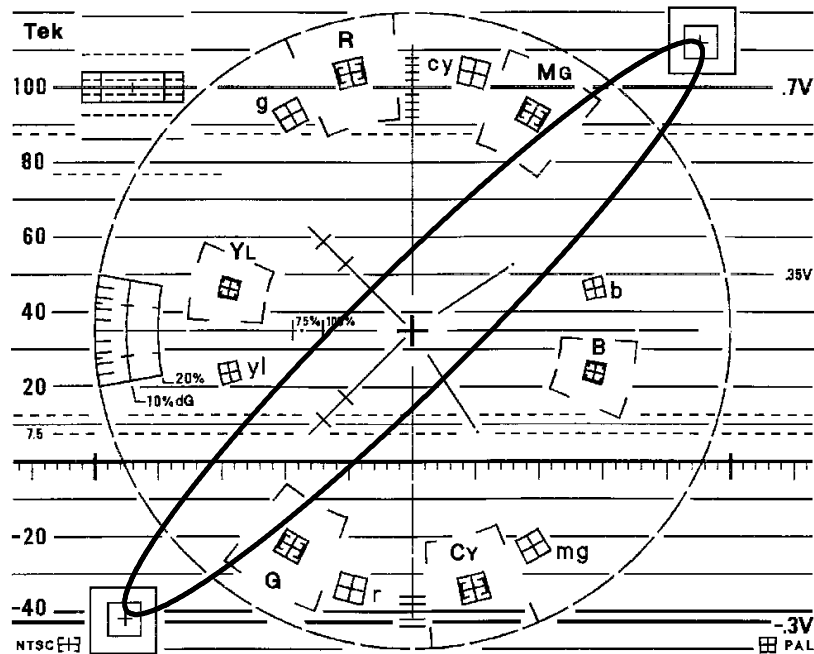

Figure 2-16. Audio display with phase error.

Operator's Checkout Procedure

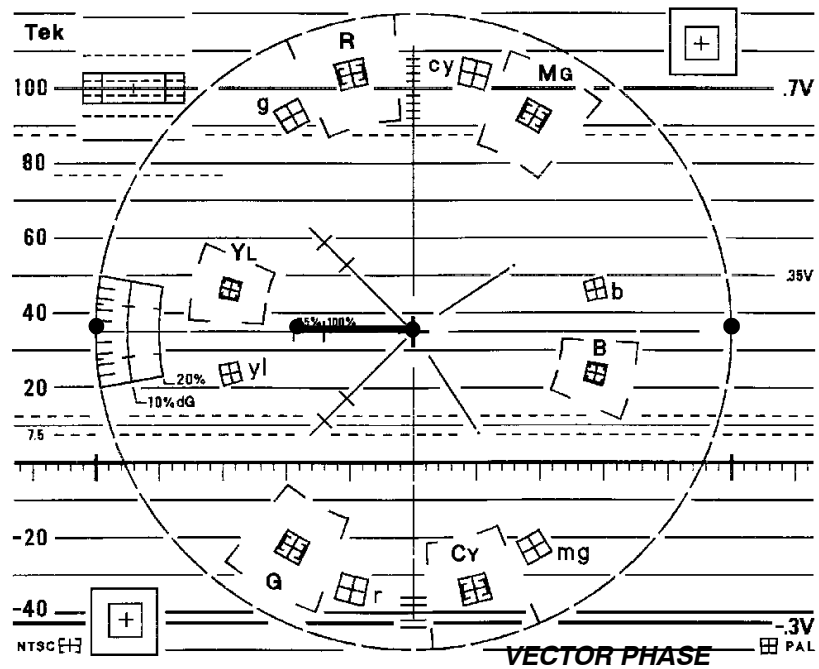

Figure 2-17. NTSC SC/H display with internal reference selected.

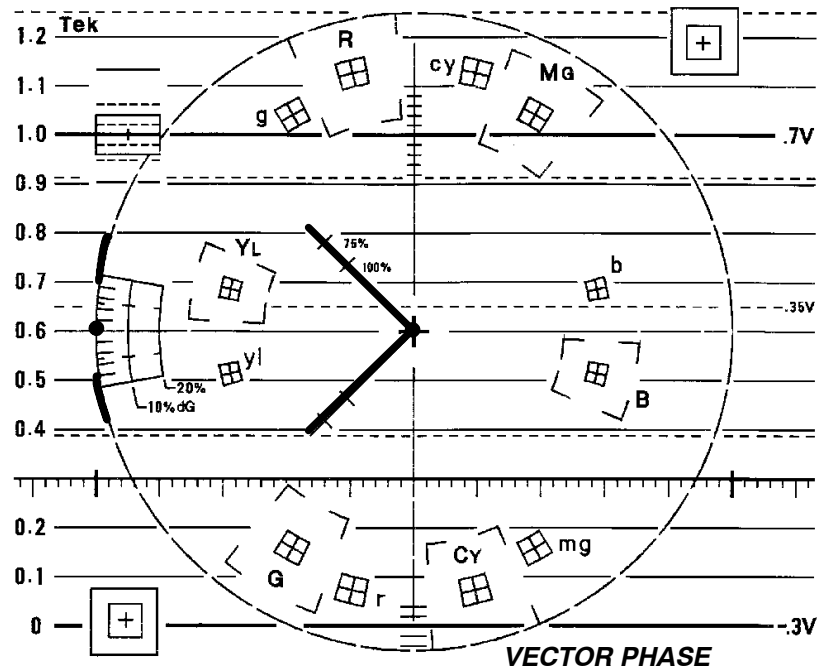

Figure 2-18. PAL SC/H display.

This concludes the *Operator's Checkout Procedure*.



Operation Basics

Functional Overview

The “Functional Overview” section describes the front- and rear-panel functions in greater detail than the “At A Glance” section.

Display Modes

The following display types are available:

- VECTOR
- WAVEFORM
- AUDIO
- SCH (1750A-Series only)
- PICTURE
- TIME CODE
- MULTIPLE displays

Vector

The vector mode presents an XY plot of demodulated chrominance phase and amplitude. The angle represents chrominance phase and the distance from the center represents chrominance amplitude. A bezel control is assigned to adjust **VECTOR PHASE**.

Waveform

The waveform monitor portion of the instrument provides a voltage versus time display of the video signal. The selected input can be displayed in one or two line, or one or two field sweeps. In **LINE SELECT** mode, identified lines of any field can be selected and displayed. Multiple inputs can be displayed at the same time, or multiple filters can be applied to one input for signal analysis. **TIME** and **VOLTAGE** cursors

can be activated and positioned for reference or measurement. LINE SELECT is discussed on page 3-14 and CURSORS are discussed on page 3-8.

Audio

Audio amplitude and phase is monitored using a calibrated X/Y Lissajous display. The operator can verify that the program audio will be properly reproduced on both monaural and stereo receivers. Correct phasing between two audio channels is quickly verified by the direction of the display.

SCH

SCH provides a vector display of the subcarrier-to-horizontal-sync phase relationship. The burst vector and the phase of the 50% point of the leading edge of sync are displayed.

Subcarrier-to-horizontal phase and color framing are displayed graphically in the polar SCH display. Sync jitter over the field is displayed as a moving sync vector dot. Correct color framing can be verified by the position of the single sync vector dot, relative to the color subcarrier vector when the monitor is externally referenced.

The SCH phase of the reference signal is separately sensed to allow reliable color framing comparison. Using this method of determining relative color framing eliminates the requirement for a precise horizontal timing match between the reference and measured signals. An external color-field identification input is also required.

Picture

The PICTURE mode allows the operator to verify the signal source. In PICTURE mode with LINE SELECT on, a bright-up marker identifies the selected line in the picture.

Time Code

Longitudinal time code is monitored in a frame-rate display to allow observation of amplitude, synchronization, and phase with respect to reference vertical sync. Synchronization is confirmed by the stationary display and time code phase is determined by horizontal position of the time code sync word on the CRT.

Multiple

When MULTIPLE is pushed, any combination of front-panel DISPLAY modes can be selected at the same time, with the exception of TIME CODE and PICTURE displays.

With MULTIPLE selected, the SCH/AUDIO switch sequences through SCH, AUDIO, and both. If waveform or vector is also selected, the switch will also sequence to OFF. (At least one mode must be on at all times.)

When exiting MULTIPLE, the instrument will return to the previous (non-MULTIPLE) display settings. When entering MULTIPLE again, the previous MULTIPLE display settings will be restored.

Displaying a Signal

Inputs

There are eight rear-panel loop-through inputs, which may eliminate the need for an external routing switcher. The inputs can be displayed singly or in combination.

Without PARADE or OVERLAY selected, only one input selection can be made at a time. Each input channel button (including A123 / B123) toggles between A and B, and is cancelled when another input button is pressed.

With PARADE or OVERLAY selected, the input channels can be displayed in combination. Pushing an input channel button sequences through the labeled channels, both, then off. Pushing another input button does not cancel the current selection, but adds to it. To return to “single input” operation, push the PARADE / OVERLAY button until it is off (LED is no longer lighted).

Inputs A1, A2, A3, and B1, B2, B3 are designed to be used as three-wire inputs for component signals.

A123 / B123

Selecting **A123** provides a side-by-side display of the CH-A1, CH-A2, and CH-A3 inputs (**B123** displays the CH-B1, CH-B2, and CH-B3 inputs). This is designed for monitoring component signals.

Parade

Selecting PARADE displays the input channels last selected for PARADE, allowing a custom configuration of inputs. In PARADE mode, the LINE/FIELD button offers only two choices: one line and one field. Up to four channels can be displayed side-by-side; additional channels are overlaid.

Overlay

OVERLAY superimposes the selected input signals. The LINE/FIELD button remains a four-way toggle, providing one line, two line, one field, and two field displays.

Sweep

Sweep buttons are used to select the waveform sweep rate. LINE/FIELD toggles through four sweep rate selections: one line, two line, one field, and two field. In PARADE mode, the LINE/FIELD button becomes a two-way switch, toggling between line and field.

The sweep rate is displayed in the upper right corner of the CRT (for field-rate sweeps, 1F or 2F is displayed).

The MAG button is used with LINE/FIELD to provide horizontal magnification of each rate as follows:

- One line magnified = 200 ns/division
- Two line magnified = 1 μ s/division
- One field or two field magnified = approximately X20 magnification.

Using the Menus

General menu information here is followed by detailed information about each menu: FILTER, CURSOR, LIN SEL, PRESET, CONFIG, GAIN and CRT. To set instrument operating parameters, see CONFIG and CRT menu information.

General Menu Information

Push the desired menu button to obtain an on-screen menu readout.

Multi-Use Bezel Controls and Buttons

Menu selections appear along the right side of the screen. Descriptive labels, when present, appear in *ITALIC* text. Actual selections appear in **STANDARD** text, with the present selection outlined. Use the five buttons along the right side of the CRT (referred to as bezel buttons) to change the selections.

The center three controls under the CRT are referred to as Left, Center, and Right bezel controls. Control functions vary with menu choice; a readout just above each active control shows its present function. These controls are used as variable analog controls to set values such as phase, amplitude, and intensity. The left control is also used to select categories within the CONFIG menu.

Figure 3-1 shows the bezel controls and buttons.

Moving Between Menus

Selecting a second menu removes the present menu display, but the functions typically remain active (with the menu LED remaining lighted to show this state). To reinstate a menu display, push that menu button again.

Using the Menus

CRT, PRESET, and CONFIG menus will be exited completely when another menu button is pushed.

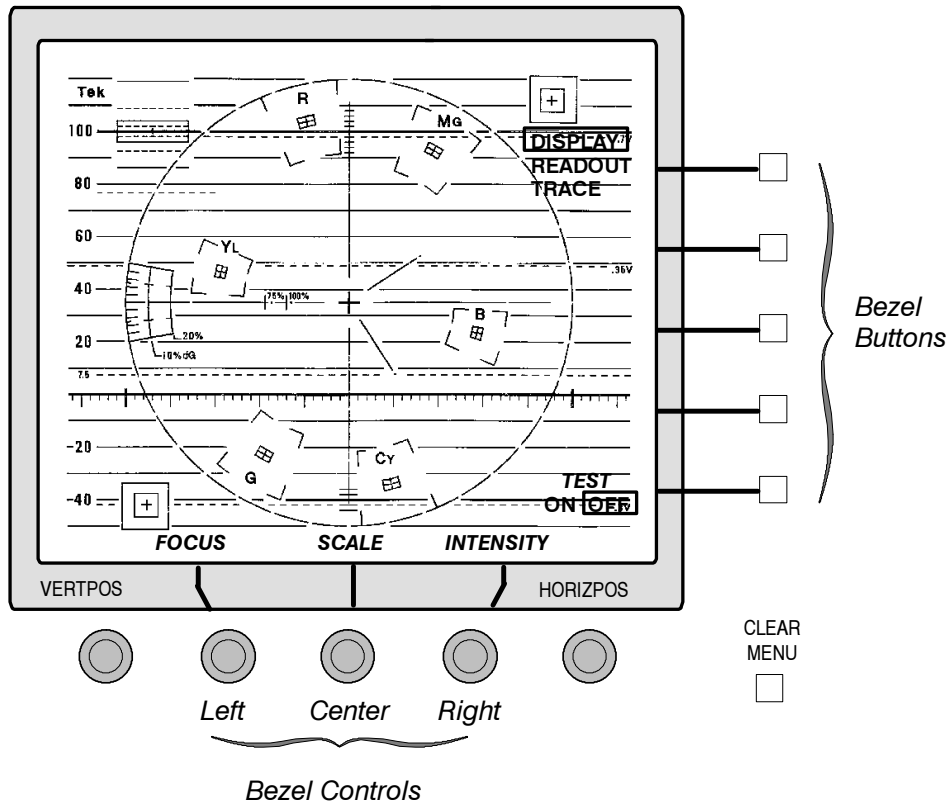

Figure 3-1. The CRT menu, showing bezel controls and bezel buttons.

Clear Menu

Push CLEAR MENU to clear part of the menu display, but leave essential readout elements such as control assignments and measurement readouts. (The menu LED remains lighted to show this state.) Push the menu button to bring back the full display.

CRT, PRESET, and CONFIG menus will be exited completely when CLEAR MENU is pushed.

Exiting a Menu Function

To exit a menu function while its display is present, push that menu button. (The menu button is functioning as an on-off toggle switch). If the menu display is not present, but the

menu function is still in effect (LED is lighted), push the menu button to bring back the full display, then push it again to exit the menu.

Filter Menu (WAVEFORM Mode Only)

The FILTER menu is available for WAVEFORM mode only. Note that the instrument must be in WAVEFORM mode to access the R-Y displays. When the FILTER button is pushed in WAVEFORM mode, an on-screen menu allows the following selections. The bezel buttons are self-cancelling.

- **FLAT** — provides flat (normal) response.
- **LUM** — provides a low-pass response to display the luminance portion of the composite video signal.
- **CHROM** — provides bandpass response centered on the chrominance subcarrier frequency, and displays frequencies around the subcarrier frequency.
- **DIFF** — is a differentiated step filter (linearity steps are translated into impulses for amplitude comparison).
- **R-Y** — selects demodulated chrominance-versus-time display. The chrominance is demodulated on the R-Y (V) axis when burst is lined up on the normal axis. The VECTOR PHASE control can adjust the demodulator phase to any axis.
- **SCH R-Y (1750A-Series Only)** — demodulates the SCH sync-locked oscillator. This display is useful for viewing SCH variations versus time.
- **F + L** — displays the video signal both flat and luminance filtered. The display is in parade or overlay mode, as selected through the on-screen menu. When PARADE is selected, the flat display is on the left.

- **F + L + C** — displays the video signal flat, luminance filtered, and chrominance filtered. The signal is displayed in parade or overlay mode, as selected through the on-screen menu. When PARADE is selected, the flat display is on the left, with the chrominance-filtered display on the right.

Cursor Menu

Press the CURSOR menu button to enter the cursor menu. Cursors are available for VECTOR, WAVEFORM, and VECT+WFM DISPLAY modes.

Vector Cursor Control

In VECTOR display mode, a bezel button is used to select polar cursors (POLAR) or markers (MARK). The polar cursor appears as crosshairs, as shown in Figure 3-2. The left bezel control is used to adjust cursor amplitude, and the center control adjusts cursor phase. The right bezel control adjusts the phase of the vector signal.

When Vector markers are selected, additional readouts appear, allowing the user to select the quantity of markers that will be present (1 through 8), and which of these markers is currently controlled by the bezel controls. The left bezel control adjusts the amplitude of the selected marker, and the center bezel control adjusts its phase. The right bezel control adjusts the phase of the vector signal.

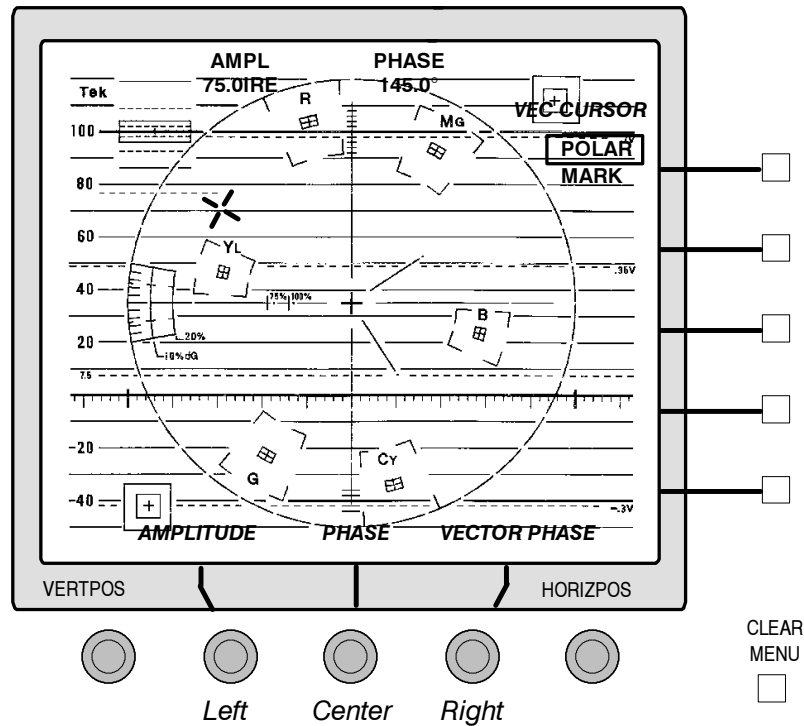

Figure 3-2. The VECTOR CURSOR menu.

Waveform Cursor Control

In WAVEFORM display mode, the bezel buttons are used to select timing cursors (TIME), voltage cursors (VOLT), both voltage and timing (V+T), or markers (MARK). The Waveform cursor menu is shown in Figure 3-3.

- When voltage cursors are selected (**VOLT**), the left bezel control is used to adjust the vertical position of the first voltage cursor, and the center bezel control adjusts the second voltage cursor. The right bezel control is used to move the vertical position of both cursors vertically, in tandem. The readout ΔV shows the voltage difference (positive or negative) between the two cursor positions, up to four significant digits.

- When timing cursors are selected (**TIME**), the left bezel control is used to adjust the horizontal position of the first timing cursor, and the center control adjusts the horizontal position of the second timing cursor. The right bezel control moves both cursors horizontally, in tandem. The readout ΔT shows the time difference (positive or negative) between the two cursor positions, up to four significant digits.
- When markers are selected (**MARK**), the left bezel control is used to adjust the horizontal position of the first marker line, the center bezel control adjusts the second marker, and right bezel control adjusts the third marker.
- When both voltage and timing cursors are selected (**V+T**), a control assignment appears on the screen. The bezel button is used to assign the control to voltage or timing cursors. The bezel controls work the same as for the individual timing and voltage cursor modes. Both voltage and timing readouts are present.

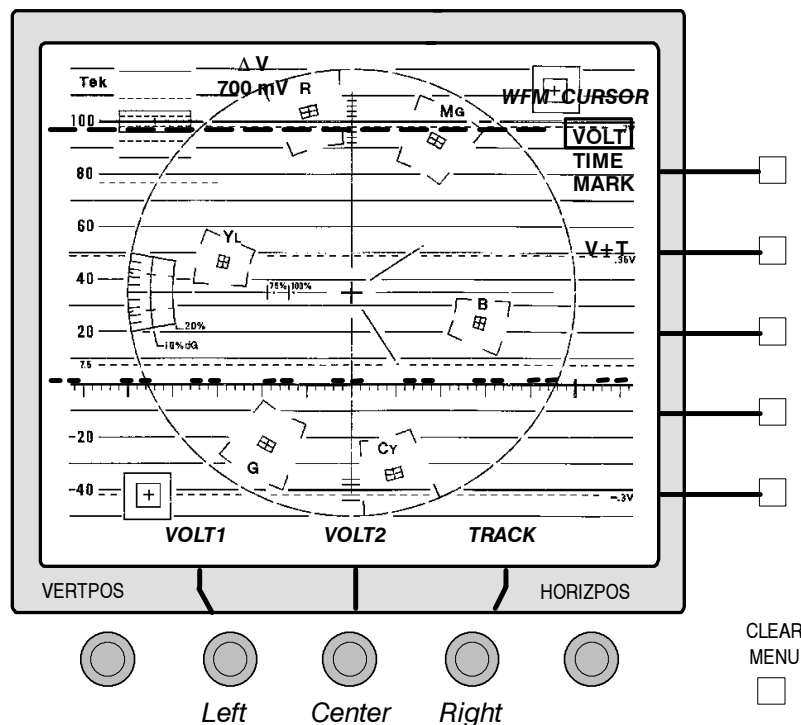

Figure 3-3. The WAVEFORM CURSOR menu.

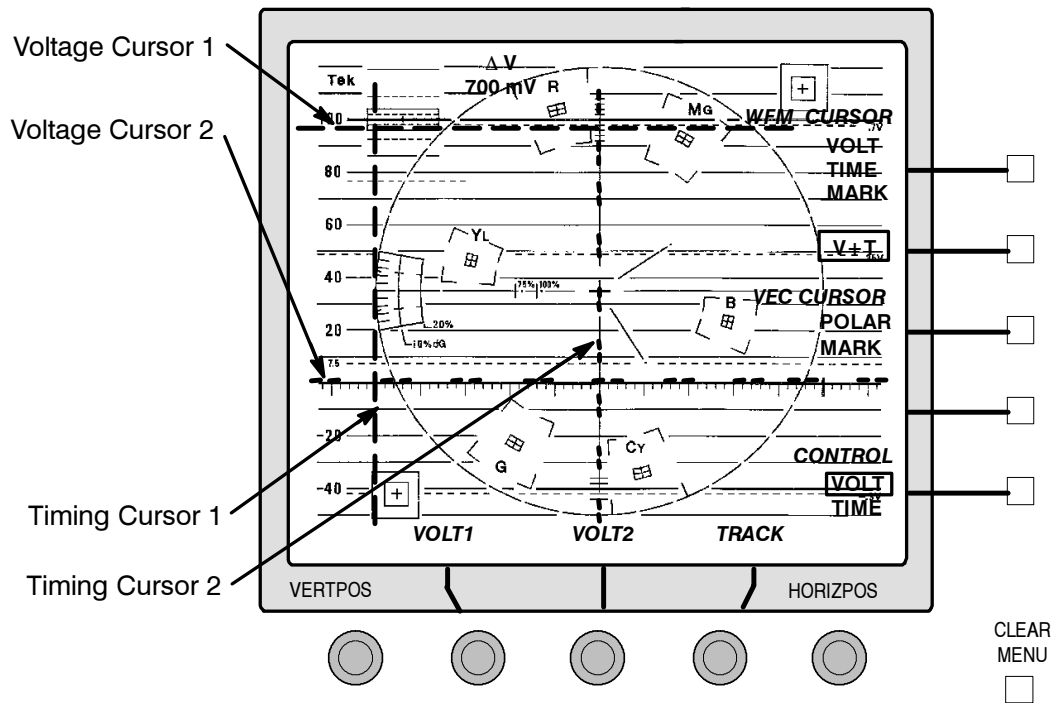

Figure 3-4. The VECTOR+WFM CURSOR menu with V+T selected.

Vector + Waveform (Multiple)

If MULTIPLE is pressed and both VECTOR and WAVEFORM displays are selected, menus for all cursor types will be displayed. See Figure 3-4. All cursor functions are available in this mode (the top three bezel buttons are self-cancelling). Bezel control assignments are the same as for the individual modes.

Using the Cursors

With Vector Display

Vector cursors are available when a composite vector display is selected. To use vector cursors, operate in VECTOR or VECTOR+WAVEFORM mode and press the CURSOR MENU button.

There are two vector cursor displays: POLAR and MARK. (The VECTOR PHASE bezel control continues to adjust the phase of the signal.)

Polar Cursors can be used to measure the amplitude and phase of the chrominance signal. When POLAR is selected, position the cursor (cross hairs) with the AMPLITUDE and PHASE bezel controls, and view the amplitude and phase readouts at the top of the screen. See Figure 3-2. The cursor zero amplitude point is the center point of the graticule. Using the amplitude control to move the cursor out from the center increases the amplitude. Adjusting the cursor phase will rotate the cursor around the center point, with the zero phase point being the B-Y (U) axis. The amplitude readout can be set for mV or IRE values through the CONFIG menu, described on page 3-18.

When the gain or position of the signal is changed, the polar cursors maintain their relationship with the signal.

When CLEAR MENU is pressed, the POLAR / MARK choice on the right side of the screen will be removed, but the bezel controls will still be active and cursor measurements can still be made. When another menu is selected, the bezel controls may be reassigned to the new menu, but will return to cursor control when the new menu is deselected.

Markers can be used to highlight graticule points. When MARK is selected, two additional menu readouts appear. These allow selection of from one to eight markers, and assign the AMPLITUDE and PHASE bezel controls to one of these markers. Markers are designed to be used for reference points; there is no quantitative readout. Markers are positioned with respect to the graticule and are not moved or resized with the signal.

When CLEAR MENU is pressed, all of the marker readout except the boxes will be removed. The readout will be restored when CURSOR menu is selected again. When CURSOR menu is exited and re-entered, the selected cursor quantity and position will be retained. One use of markers is to position them on the vector target boxes. Adjust the signal source until the color bar signal appears in the marker boxes.

If it becomes necessary to compensate for minor shifting of markers due to drift or external magnetic fields (particularly if the instrument is moved after the markers are set), enter the CRT menu and select READOUT. Use the bezel controls to adjust vertical position (VPOS) and horizontal position (HPOS) until the center of the displayed test pattern is at the center of the graticule.

With Waveform Display

Voltage Cursors can be used to make accurate signal amplitude measurements. With VOLT selected, use the left bezel control to position the VOLT1 cursor at the upper excursion of signal to be measured, and the center bezel control to position the VOLT2 cursor at the lower excursion. The on-screen readout gives the voltage difference between the two levels.

When GAIN is changed, the voltage cursors maintain their relationship with the signal. For example, if the VOLT2 cursor were set to the signal sync tip in X1 GAIN, it would also be at sync tip in X5 gain, X10 gain, or with VAR gain on.

Timing Cursors can be used to make accurate time measurements. When TIME is selected, position the TIME1 cursor at the left excursion of the signal to be measured, and the TIME2 cursor on the right. The on-screen readout gives the time difference between the two points.

When MAG is selected, the timing cursors maintain their relationship with the signal. For example, if the VOLT1 cursor were set to the rising edge of sync, it would also be set there with MAG selected.

Markers. When MARK is selected, use the bezel controls to vertically position the markers where desired with respect to the graticule markings. These markers are designed to be used for reference points; there is no amplitude readout. The markers are not affected by GAIN changes; if a marker were set to 100 IRE in X1 GAIN, it would still be set to 100 IRE with the MAG on.

Line Select Menu

Pushing the LIN SEL menu button enables the line select mode and provides the line select menu display. The middle bezel control is assigned to select the line number. The following choices can be made using the bezel buttons.

1740A–Series

- **FIELD — ALL** or **1of 2**
- **1H** or **15H** (one line or 15 lines)
- **NEXT FIELD** — (appears only when **1of 2 FIELD** is selected.) Push the bezel button corresponding to **NEXT FIELD** to sequence through the fields designated by the **FIELD** selection. A box flashes momentarily around the on-screen label to verify that the selection has been made.

1750A–Series

- **FIELD — ALL** or **1of2** or **1of 4** or **1of8**
- **1H** or **15H** (one line or 15 lines)
- **NEXT FIELD** — (appears only when **1of 2**, **1of4**, or **1of 8 FIELD** is selected.) Push the bezel button corresponding to **NEXT FIELD** to sequence through the fields designated by the **FIELD** selection.
- **ALT 2 FIELD** — (appears only when **1of 4 FIELD** is selected.) Push the bezel button corresponding to **ALT 2 FIELD** to toggle between the current field and the second next field; for example, FIELD1 and FIELD3.
- **ALT 4 FIELD** — (appears only when **1of 8 FIELD** is selected.) Push the bezel button corresponding to **ALT 4 FIELD** to toggle between the current field and the fourth next field; for example, FIELD1 and FIELD5.

When bezel buttons corresponding to **NEXT FIELD**, **ALT 2 FIELD**, or **ALT 4 FIELD** are pushed, a box flashes momentarily around the on-screen label to verify that the selection has been made.

Readout

The line select readout (in the upper left of the CRT) consists of field followed by line number. When 15H is selected, the readout also displays the range of line numbers. For example, select FIELD 1 and 15H, and rotate the LINE SEL control to line 34. This provides a readout of field 1, lines 34 through 48:

F1 34

F1 48

Line Select Functions

All of the other menus are functional during line select operation. The line select menu display disappears when another menu is selected, but the selected line and field are displayed until the line select menu is exited. (The field and line readout remains in the upper left of the screen, and the line select LED remains lighted to indicate this state.)

Line select can also be used with MULTIPLE displays of WAVEFORM, VECTOR, and SCH. Selected displays appear on the screen in the following order: WAVEFORM, VECTOR, SCH. The readout indicates the line number of the highest priority display. For example: with waveform and vector displays both selected, a readout of F1:20 would indicate that field 1, line 20 is displayed in waveform mode, and field 1, line 21 is displayed in vector mode.

In a waveform display, the selected line is displayed first in a two-line sweep, and brightened in a field sweep.

When line select is enabled, the rear-panel PIX MON output highlights the selected line on the picture monitor display.

Preset Menu

The 1740A/1750A-Series has 10 presets capable of storing front-panel setups. Nine of the presets are user-programmable and one is factory pre-programmed. The factory programmed setup is as follows: WAVEFORM, CH-A, DC REST ON, 2LINE SWEEP, REF internal, and menus off.

Factory-programmed setup: WAVEFORM DISPLAY, CH-A INPUT, DC REST ON, 10 μ s SWEEP, REF internal, and menus off.

Push the PRESET menu button to access the on-screen menu, illustrated in Figure 3-5. Turn the left bezel control to select the PRESET location to be acted on (presets 1-9 are available through the menu). Next, use the bezel button corresponding to the desired action (RECALL, STORE, RENAME, or RECOVER). When a bezel button is pushed, a box flashes momentarily around the on-screen label to verify that the selection has been made.

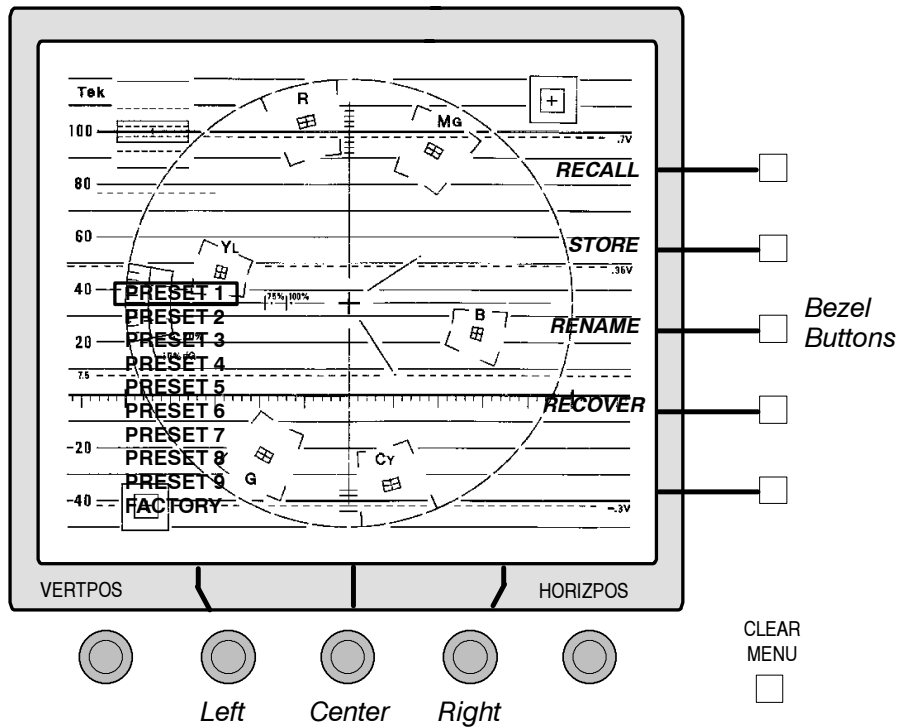

Figure 3-5. The PRESET menu display.

Recall

Use the left bezel control to select (outline) a preset for recall. Push RECALL to recall the stored instrument configuration.

Recover

Push RECOVER to restore the front-panel setup that was in effect before RECALL was pushed.

Store

To begin storing a setup, push STORE. Make sure the front-panel controls are set as desired, and use the left bezel control to select the storage location (shown outlined).

Push STORE IT to store the current front-panel settings at the outlined PRESET location. (Push the bezel button corresponding to RETURN if storing is not desired. This will cancel and exit the STORE operation.)

Rename

Selecting RENAME will provide an on-screen display, assigning the center and right bezel controls to *LOCATION* and *LETTER*. Turn the center control to select the letter that will be changed (move the box to the desired location within the preset name). Turn the right control until the selected letter changes to the desired new letter.

Push RETURN if renaming is not desired. All changes to the name will be cancelled.

When the change has been made satisfactorily, select ACCEPT to store the new name.

Configure Menu

Push the CONFIG button to display the configure menu, shown in Figure 3-6. Turn the left bezel control to select INPUT, VECTOR, FORMAT, STANDARD, OFFSET, CALIBRATE, REMOTE, or REFERENCE (a box appears around the selection). Following are descriptions of each selection.

INPUT

- **COUPLING** — Selects AC or DC coupling for rear-panel inputs.
- **DC RESTORER** — Selects the clamp speed. Slow will clamp while displaying any hum.
- **CLAMP** — Selects the point of the video signal that is clamped to 0. Can be set for **ST** (sync tip) or **BP** (back porch).
- **A123** — and **B123** — When COMPOSITE is selected, the instrument's internal reference is the input channel currently selected for display. For COMPONENT, the internal reference is A1 when A123 is selected, and B1 when B123 is selected (sync is present only on the first channel).

VECTOR

- **BARS** — The instrument can be configured to accept 75% or 100% amplitude color bar signals. Dual-Standard instruments allow color bar signal amplitudes to be set for NTSC and for PAL operation.
- **SETUP** — (**NTSC operation only**) Configures the instrument to accept signals with or without setup.
- **PAL** — (**PAL operation only**) When +V is chosen, the phase reference of the -V lines is inverted, then shown as an overlay on the +V lines to provide a comparison display. +V shows +V and -V on alternate lines.
- **TEST** — Used by service personnel; refer to the service manual.

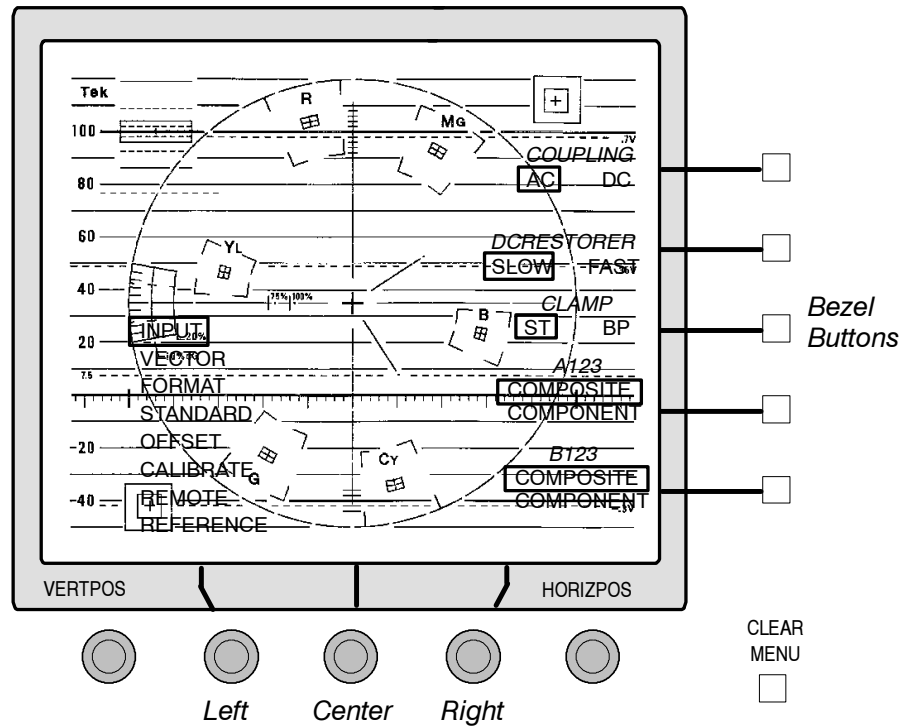

Figure 3-6. The CONFIGURE menu display with INPUT selected.

FORMAT

- CONFIG—FORMAT is used to select the configuration of signals used for interconnection of equipment. Available signal formats are: **GBR**, **SMPTE/EBU**, **BETA**, and **MII**. When viewed as a waveform parade display, GBR signals can be displayed in either GBR sequence or RGB sequence, as selected through the GBR PARADE GBR/RGB menu. Table 3-1 shows valid format selections.
- CONFIG—FORMAT is also used to select **LIGHTNING** or **DIAMOND**. The present selection will be displayed when the front-panel **LIGHTNING** button is pressed.

Table 3-1. Valid FORMAT selections.

FORMAT	BARS ^[1]		SETUP ^[2]	
	75%	100%	Y	N
525/60				
GBR	●	●		●
SMPTE / EBU	●	●		●
BETA	●	●	●	●
MII	●	●	●	
625/50				
GBR	●	●		●
SMPTE / EBU	●	●		●
BETA	●	●		●
MII ^[3]	●	●		●

^[1] 75% or 100% Bars selected through CONFIG—VECTOR menu.

^[2] Setup Yes or No is selected through the CONFIG—VECTOR menu. The setup selection is only relevant with 525/60 BETA, and is ignored in all other formats.

^[3] MII is identical to SMPTE/EBU in 625/50.

STANDARD

- CONFIG—STANDARD allows the user to set the cursor unit of measure to **MV**, **IRE**, or **AUTO**. When **AUTO** is selected, cursor units are automatically changed to IRE when operating in the NTSC standard, and MV when operating in the PAL standard.
- For dual-standard instruments, a menu selection of **NTSC**, **PAL**, or **AUTO** standard is also available. When **AUTO** is selected, the operating standard is changes automatically to match the standard of the displayed input signal. A circled “A” precedes NTSC or PAL on the readout.

OFFSET

- The VERTICAL POSITION control normally positions all channels together. When OFFSET is enabled, the bezel controls can be used to offset input channels 2 (A or B) and 3 (A or B) with respect to channel 1 (A or B).
- While the offsets are enabled, the VERTICAL POSITION control will still position all channels together, with the offset amount remaining constant. When OFFSET is turned off, the input channels will be re-aligned. The selected offset amount will be recalled the next time OFFSET is enabled.
- When A2A3 OFFSET is on, the center and right bezel controls are assigned to CH A2 and CH A3 offsets. On-screen labels appear just above each control. Turning these controls will offset the CH A2 and CH A3 signals with respect to CH A1. When B2B3 offset is on, the same two controls are assigned to CH B2 and CH B3.
- When both A2A3 and B2B3 offsets are on, the user assigns the controls to either A or B offsets. The CONTROL selection only appears when both A and B OFFSETS are selected.
- An offset will remain in effect until the user turns the offset OFF. (Exiting the CONFIG menu will not affect the OFFSET ON / OFF setting.)

CALIBRATE

These choices are offered when CALIBRATE is selected:

- **CAL SIG** — Turns the 1 V internal calibrator signal on/off.
- **GAIN CAL** — Turns on the gain calibration adjustment on/off.

Additional choices appear when CAL SIG or GAIN CAL is turned on:

CAL SIG ON

- In waveform mode, the user can set the calibrator frequency to 100 KHZ or to FSC OSC (*FSC OSC = 3.58 MHz for NTSC/4.43 MHz for PAL*). Dual-standard monitors also have the option of choosing **NTSC FSC (3.58 MHz)** or **PAL FSC (4.43 MHz)**.
- In vector mode, the user can set the calibrator frequency, for dual-standard instruments only, to **NTSC FSC (3.58 MHz)** or **PAL FSC (4.43 MHz)**.
- In both waveform and vector modes, selecting **NTSC FSC** or **PAL FSC** temporarily switches the instrument to the appropriate video standard. The standard is restored when changing the selection or when exiting the CALIBRATE menu.

GAIN CAL ON

- In waveform mode, the left bezel control adjusts instrument vertical gain (**V CAL**) and the center bezel control adjusts instrument horizontal gain (**H CAL**).

Once gain has been adjusted, two reset options appear on screen. If either of these resets is selected, a box flashes momentarily around the on-screen label to acknowledge that reset has occurred. **RESET VCAL** cancels any vertical gain adjustments and **RESET HCAL** cancels any horizontal gain adjustments; the instrument returns to the factory calibrated gain settings.
- In vector mode, the center bezel control adjusts the vector signal gain. Once gain has been adjusted, **RESET VCAL** appears on screen. Selecting **RESET VCAL** cancels any vector gain adjustments and returns the instrument to the factory calibrated gain settings.

REMOTE

- The currently operating software version is displayed in the lower right corner of the screen.
- Three menu choices are available. **REM INPUT** configures rear-panel REMOTE connector pin 3 to accept External Horizontal or Staircase input. **STAIRCASE** configures the staircase input for 3-step (RGB) or 4-step (YRGB) signal. **BAUD** configures the data transmission rate for the rear-panel RS232 connector for 1200, 4800, or 9600 baud.
- The remote input is enabled by a TTL low or switch to ground. See page B-1.

REFERENCE (Dual Standard Only)

- NTSC external reference and PAL external reference can be set to **EXT, A, A1, A2, A3, B, B1, B2,** or **B3**.
- When The front-panel REF EXT is selected (LED lights) the instrument uses the rear-panel EXT REF input. Dual-standard monitors can be configured for two external references; one for NTSC and one for PAL. Any of the input channels can be designated as a second external reference by selecting that input channel as the **NTSC EXT REF** or **PAL EXT REF** through this menu.
- If NTSC and PAL external references are configured the same, the monitor automatically operates in the same television standard as the EXT REF input. When NTSC and PAL external references are configured differently, the monitor's operating standard is determined by the standard of the displayed video instead of the EXT REF input. Once the operating standard is determined, the monitor immediately switches to the appropriate input for reference timing.

Gain Menu

- Any one of three calibrated gain ratios can be selected: **X1**, **X5**, or **X10**. Variable gain is also available, independent of the other gain settings. When variable gain is on, the left bezel control adjusts the signal gain.
- Audio or Time Code gain is set from the **GAIN** menu when **AUDIO** or **TIME CODE** display is selected. Gain choices are 0 dBu, 4 dBu, 8 dBu, or 12 dBu. Select gain relative to the system under test.
- When variable gain is turned off, the instrument returns to the calibrated gain setting. Operator adjustments made with variable gain will be restored when variable gain is selected again.

CRT Menu

- **DISPLAY** is used for signal and etched graticule adjustments. When **DISPLAY** is selected, the left bezel control adjusts the signal focus (**FOCUS**), the center bezel control adjusts the etched graticule illumination (**SCALE**) and the right bezel control adjusts the signal intensity (**INTENSITY**).
- **READOUT** refers to electronic graticules, markers, menu and measurement readouts. When **READOUT** is selected, a test pattern containing a vertical line and a horizontal line is displayed. Use the left bezel control (**VPOS**) and the center bezel control (**HPOS**) until the lines cross at the center of the etched graticule. This will compensate for minor shifting of markers due to drift or external magnetic fields (particularly if the instrument is moved after the markers are set).

The right bezel control adjusts readout intensity (**INTENSITY**). Readout intensity will not go below the calibrated minimum value when menus are displayed.

- **TRACE** adjusts trace rotation

Exiting the menu will return the instrument to normal operation, with the new settings in effect.

Remote Operation

The 25-pin rear-panel REMOTE connector is a subminiature D-type connector. It accepts the input for RGB/YRGB staircase, external horizontal, remote sync external blanking, time code, and Left and Right audio. TTL signal or ground closure to designated pins will enable Staircase, External Horizontal, or Remote Sync displays.

When Remote Sync is enabled, the on-screen TIME/DIV. readout is not present. When Remote Sync or External Horizontal is enabled with timing cursors, “UNCAL” is displayed in place of a quantitative readout.

The REMOTE connector is configured for Staircase (RGB or YRGB) or External Horizontal input through the CONFIGURE menu, shown on page 3-18.

The user can store and recall up to eight front-panel setups through the remote. Remote connector pin assignments and an operational description begin on page B-1.

Using Presets through the Remote

The 1740A/1750A-Series has 10 presets capable of storing front-panel setups. Presets one through eight are accessible through the rear-panel REMOTE connector. A TTL low or ground closure on one of the PRESET pins selects the front-panel setup stored at that preset location.

When STORE (pin 25) is grounded along with one of the preset pins, the current front-panel setup is stored at the selected preset location.

Remote Operation



Making Measurements

Basic Measurements

Basic Measurements contains 1740A/1750A-Series graticule descriptions, followed by specific measurement procedures.

This monitor uses an internal graticule, which combines waveform and vector markings. The internal graticule scales are on the same plane as the CRT phosphor, eliminating parallax errors. Graticule illumination can be adjusted through the CRT menu (page 3-24) to provide optimum brightness for viewing or photographing displays.

Waveform Graticule

There are three versions of the waveform graticule, illustrated in Figure 4-1, Figure 4-2, and Figure 4-3:

- NTSC composite video graticule (1740A and 1750A only)
- CCIR composite graticule (1741A and 1751A only)
- Dual standard graticule (1745A and 1755A only)

Horizontal Scale

The 0 IRE (0.3V) graticule line is divided into 12 major divisions. Each division represents a unit of time determined by the SWEEP and MAG settings. Line sweep rates are as follows:

SWEEP	TIME/DIV	MAG ON
1 LINE SWEEP	5 μ S/DIV	200 nS/DIV
2 LINE SWEEP	10 μ S/DIV	1 μ S/DIV

In 2 FIELD SWEEP with MAG ON, the entire vertical interval can be viewed.

NTSC Vertical Scales

The NTSC graticule is shown in Figure 4-1. The left side of the graticule is scaled in IRE units and extends from -50 to +120 IRE in 10 IRE increments. A mV scale has been added to the right side of the NTSC graticule to facilitate component measurements.

Black level setup is denoted by a dashed line at 7.5 IRE.

There are ± 2 IRE and ± 4 IRE markings at the center of the -40 IRE line to assist in measuring sync amplitude. This scale is designed for use with two line or two field sweep rates.

The graticules are also marked for K-Factor tolerances and linear-distortion measurements. These measurements will be described later in this section.

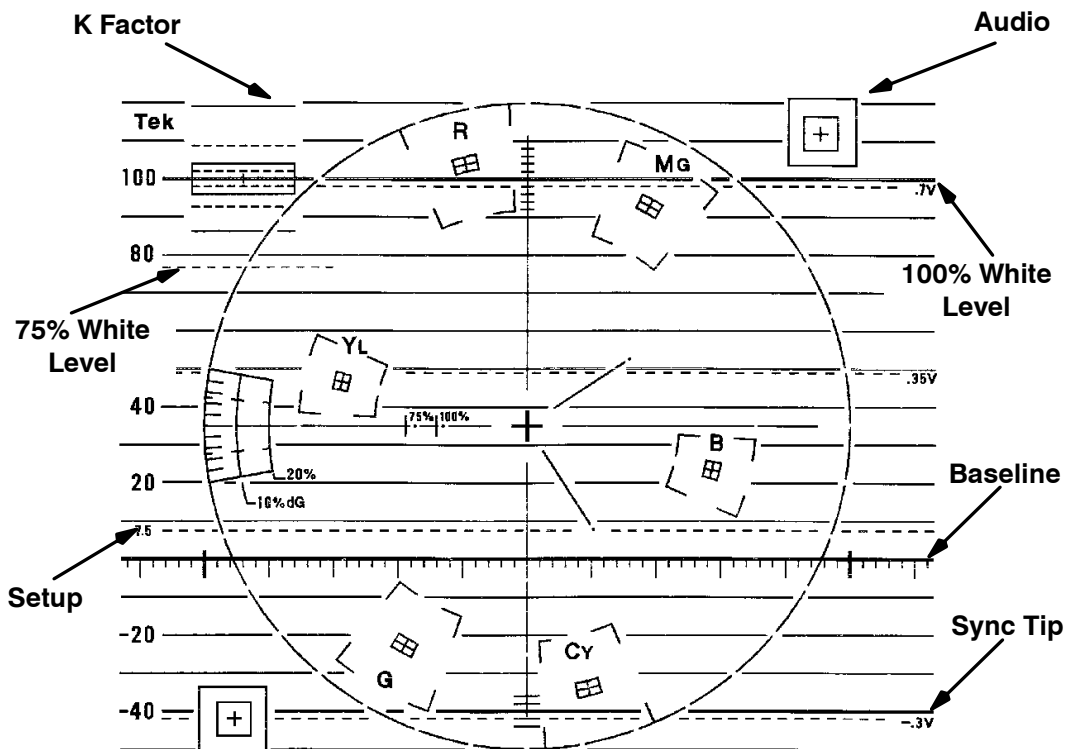

Figure 4-1. NTSC waveform/vector graticule.

PAL Vertical Scale

The PAL graticule is shown in Figure 4-2. On the left side of the PAL graticule is a voltage scale that extends from 0 to 1.2 V. The graticules are also marked for K-Factor tolerances and linear-distortion measurements. These measurements will be described later in this section.

Component signals can be centered on the .35 V line.

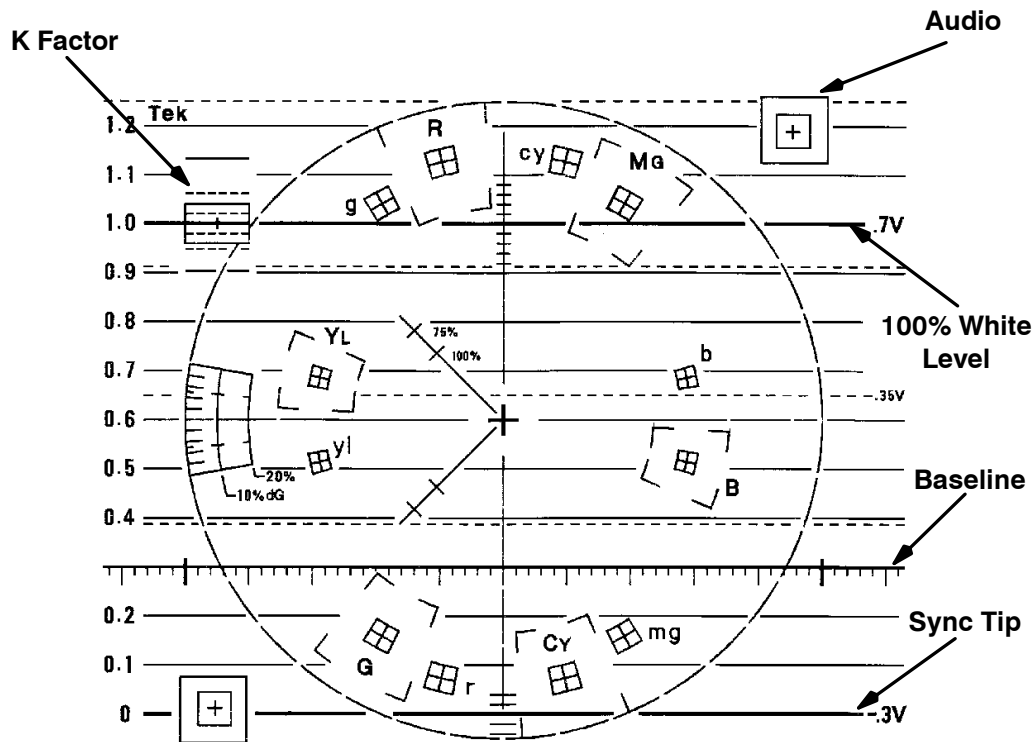

Figure 4-2. PAL waveform/vector graticule.

Dual-Standard Vertical Scale

The dual-standard graticule combines the NTSC and PAL scales. The NTSC scale is on the left side; the PAL scale is on the right. The divisions represent 10 IRE in amplitude (70 mV for PAL). The instrument gain is automatically adjusted for the particular standard used. On-screen arrows point to the graticule scale (left side or right side) that is calibrated for the present operating mode.

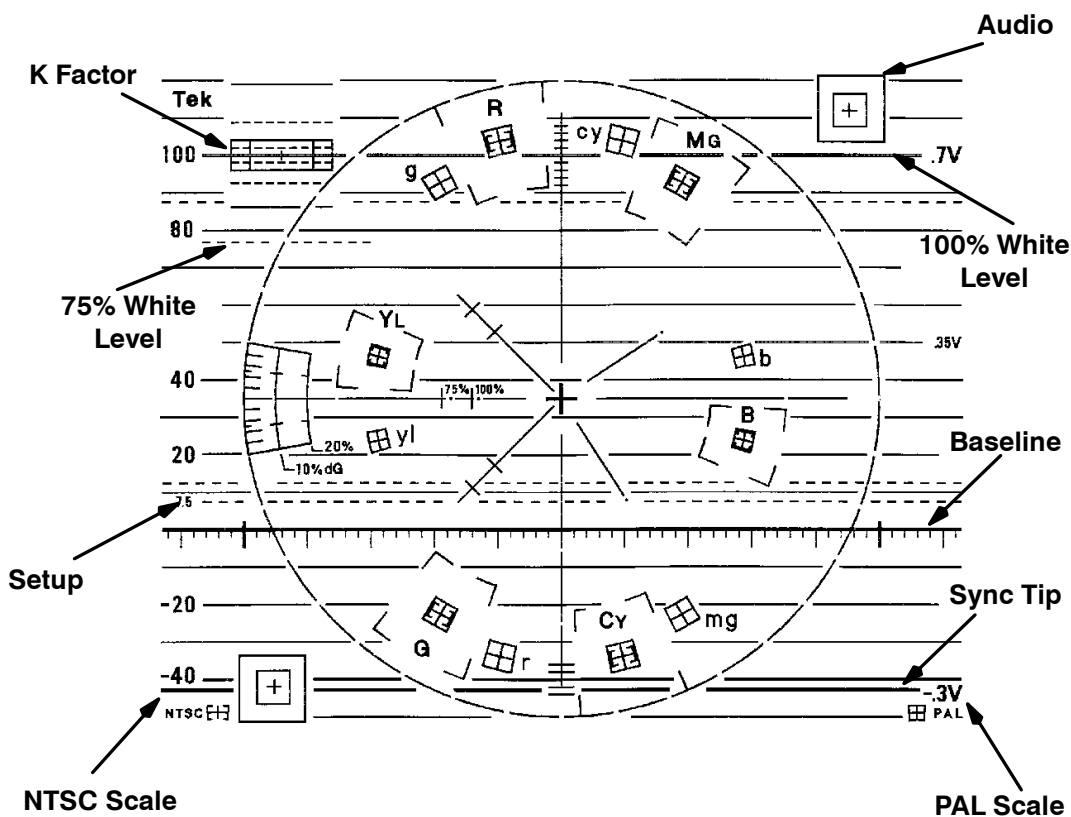

Figure 4-3. Dual Standard waveform/vector graticule.

Making Waveform Measurements

Horizontal Sync Amplitude

The vertical scale at sync tip (40 IRE NTSC or -0.3 V PAL) provides ± 2 and ± 4 IRE (± 2 and ± 4 mV) for measuring sync amplitude. Align the blanking level of a centered two-line waveform display on the graticule baseline to place the sync pulse directly over this structure. Measure sync amplitude directly from the graticule, or use the voltage cursors.

Peak White

With the blanking signal level on the graticule baseline, the amplitude of the 100% white reference of a color bar should be on the 100 IRE (1 V) graticule line. With a 2 LINE sweep rate, use the HORIZ POS control to place the white reference directly over the amplitude scale at graticule center. The vertical markings there correspond to 2 IRE/division (10 mV/division for PAL). Measure peak white directly from the graticule or use the voltage cursors.

K-Factor Measurements

The boxed area in the upper left corner of the graticule is scaled for 2% and 4% K-Factor ratings for precise tilt measurements. This structure is designed to work with an 8 μ s half-amplitude duration (HAD) bar. The bar tilt measurement structure can also be used to measure pulse-to-bar ratio. Calibrated X5 GAIN can be used while making these measurements; it increases resolution to 0.4% and 0.8%.

To use the NTSC vertical scale to make line-time distortion and pulse-to-bar ratio measurements, position the signal blanking level to the graticule baseline. Next, position the center of the composite test signal bar to the center of the 2T bar measurement box and check to see if insertion gain is unity. If it is not, adjust the VARIABLE GAIN (enabled from the GAIN MENU) for exactly 100 IRE (700 mV PAL) of signal amplitude from baseline to the middle of the white bar.

Basic Measurements

To measure the K-Factor line-time distortion, measure the largest deviation of the bar top (tilt or rounding) within the structure. The solid outer box equals a 4% K-Factor, while the dashed line inner box equals a 2% K-Factor. For signals with a bar half-amplitude duration that exceeds 18 μs (8 μs PAL), measure the bar top in increments by positioning the bar to the left or right of the leading or trailing edge. The first and last 1 μs of the bar should be disregarded.

Pulse-to-bar K-Factor measurements are made by normalizing bar amplitude (100 IRE or 1V) and adjusting the HORIZ POS control to position the pulse on the line-time distortion structure. Use the VAR GAIN (see CONFIG—GAIN menu, page 3-24) to adjust signal amplitude.

Make sure that the center of the bar is at 100 IRE (1 Volt PAL) when blanking level is at 0 IRE (use VARIABLE GAIN to adjust gain, if necessary). Use the HORIZ POS control to place the 2T pulse over the center of the boxed measurement area and measure its amplitude. When the top of the pulse falls within the dashed lines, the K-Factor equals 2% or less.

Vector Graticule

The VECTOR display permits measurements of hue in terms of the relative phase of the chrominance signal with respect to the color burst. Relative amplitude of chrominance to burst is expressed in terms of the displacement from center (radial dimension of amplitude).

The vector graticule is combined with the waveform graticule.

The NTSC and PAL vector graticules contain burst and vector targets; the dual-standard graticules contain burst and vector targets for both NTSC and PAL standards. The vector targets can be used with either 75% or 100% amplitude color bar signals. The selection is made through the CONFIG—VECTOR menu, described on page 3-18.

NTSC

The chrominance vectors terminate in a system of graticule targets consisting of two boxes (a small box inside a large box). A sample target is shown in Figure 4-4. The dimensions of the large boxes represent $\pm 10^\circ$ centered on the exact chrominance phase, and $\pm 20\%$ of chrominance amplitude centered around standard amplitude. The dimensions of the smaller boxes represent $\pm 2.5^\circ$ and ± 2.5 IRE.

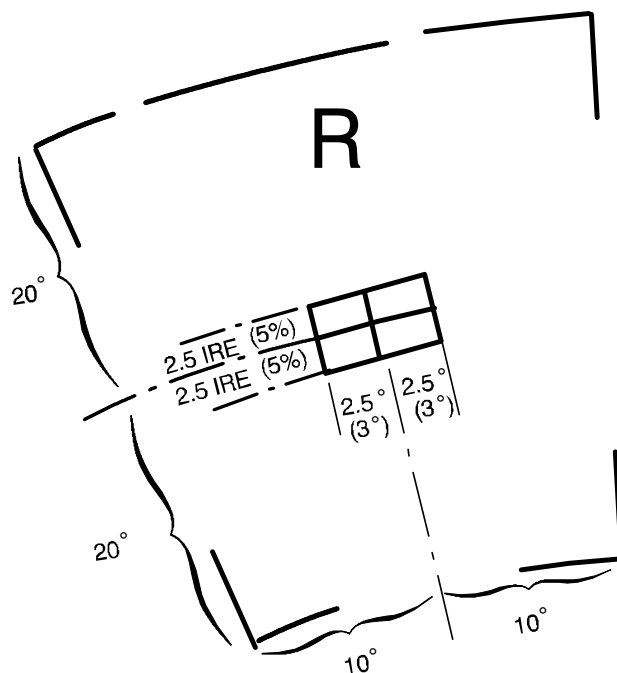

Figure 4-4. Vector targets – NTSC values (PAL values in parentheses).

PAL

For the 1741A and 1751A graticule, each PAL chrominance vector related to the +V burst terminates in targets consisting of two boxes (a small box inside a large box). See Figure 4-4. The large box represents $\pm 10^\circ$ centered on the exact chrominance phase and $\pm 20\%$ of chrominance amplitude centered around 100% standard amplitude. The dimensions of the inner target show $\pm 3^\circ$ and $\pm 5\%$ of chrominance amplitude; the vectors associated with the -V burst terminate in the smaller targets.

Dual-Standard

The 1745 and 1755 graticule is a composite of the PAL and NTSC graticules. There are two inner targets within the larger target; the PAL target, and the NTSC target. The NTSC target is inside the PAL target.

Making Vector Measurements

Chroma Bandwidth

The horizontal and vertical axes of the vector graticule contain markings for checking chroma bandwidth. A subcarrier frequency sine wave (whose amplitude places it on the outer compass rose) is used as a reference. When the frequency is changed, the diameter of the circle should reduce. At a point equal to 70% of full amplitude (-3 dB), there are gaps in the horizontal and vertical axes. This calibration aid makes it possible to check the -3 dB points of the demodulator output amplifiers.

Differential Phase and Gain

Differential gain (dG) and differential phase (d ϕ) measurements use the graticule markings located at the outer edge of the B-Y or U axis. See Figure 4-5.

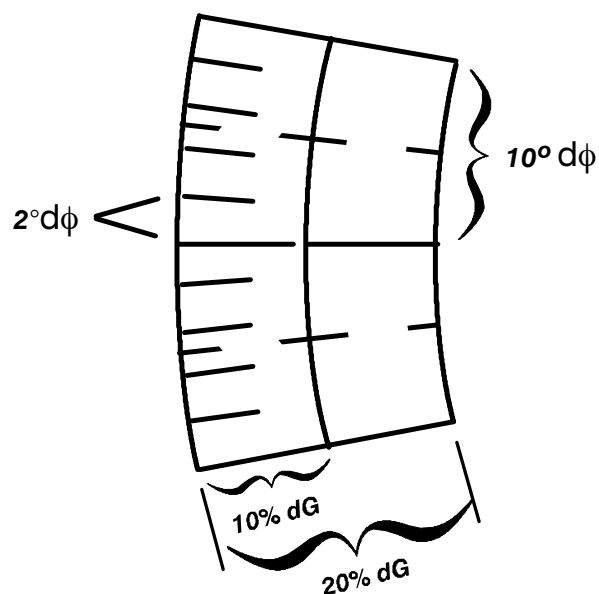

Figure 4-5. Differential Gain and Phase Measurements.

Making SC/H Phase Measurements

(1750A—Series Only)

The SC/H display provides a vector display of the subcarrier-to-horizontal-sync phase relationship. The burst vector and the phase of the 50% point of the leading edge of sync are displayed.

NTSC

Dual-Dot Display

When REF is set to internal, the 1750A has a dual-dot SC/H display (Figure 4-6). The dots represent the 50% points of horizontal sync.

To make a measurement, align the burst vector as shown in Figure 4-6. The location of the horizontal sync dot is the SC/H phase of the signal. With the dual dots, SC/H phase range is limited to 180° , because the SC/H phase of a single signal referenced to itself can only vary $\pm 90^\circ$. At 180° , the video signal again has a + field subcarrier phase sequence, making it “SC/H phased.”

Single-Dot Display

When REF is set to EXT, the 1750A has a single-dot display (Figure 4-7). This relative mode allows the comparison of two signals, the selected INPUT and EXT REF. The phase shift between the two subcarriers can extend from 0° to 360° .

A dot near 0° (relative to burst) indicates the input is perfectly SC/H-phased with the EXT REF input, and that the color frames are properly matched. A phase reading of 180° indicates that the INPUT and EXT REF color frames are not properly matched.

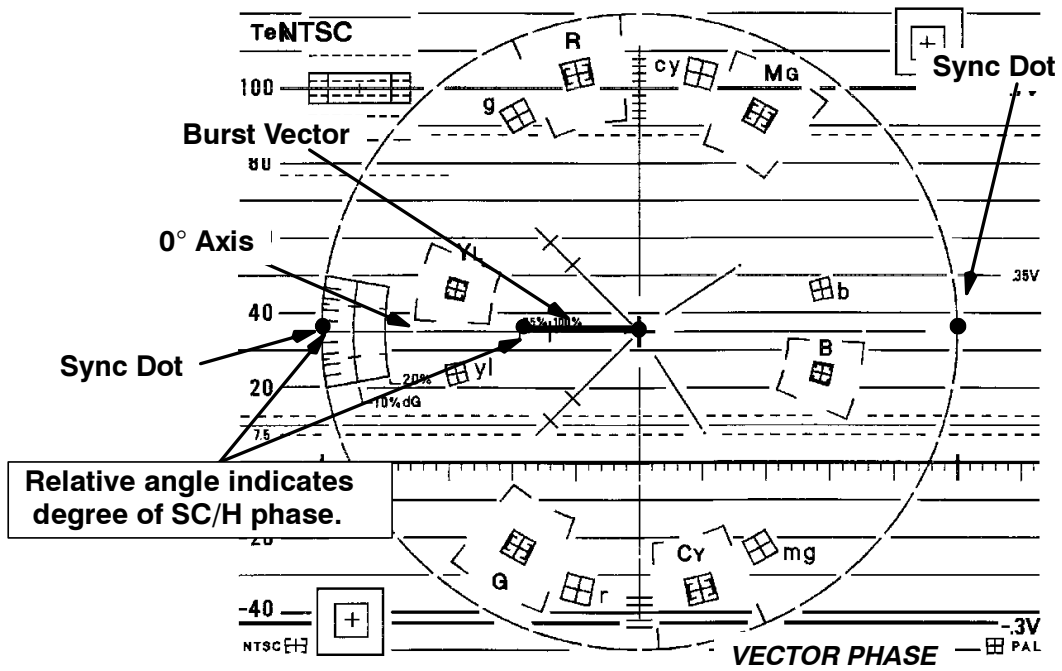

Figure 4-6. NTSC dual-dot SC/H display.

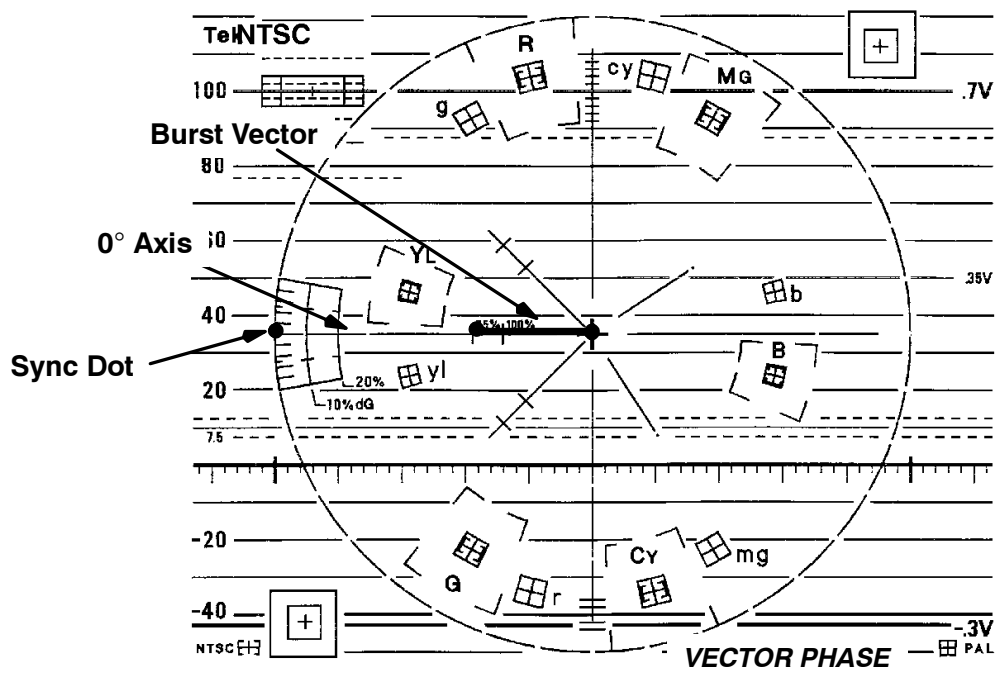

Figure 4-7. NTSC single-dot SC/H display.

PAL

The 1751A uses a series of dots around the compass rose with a single dot in a blanked area to denote sync (see Figure 4-8). Place the burst vector at 0° , align the burst vectors with the graticule markings, and read the SC/H phase error as the amount of sync dot offset from the horizontal axis. The input signal and the EXT REF signal are properly color framed when the sync dot is within 90° of the burst vector.

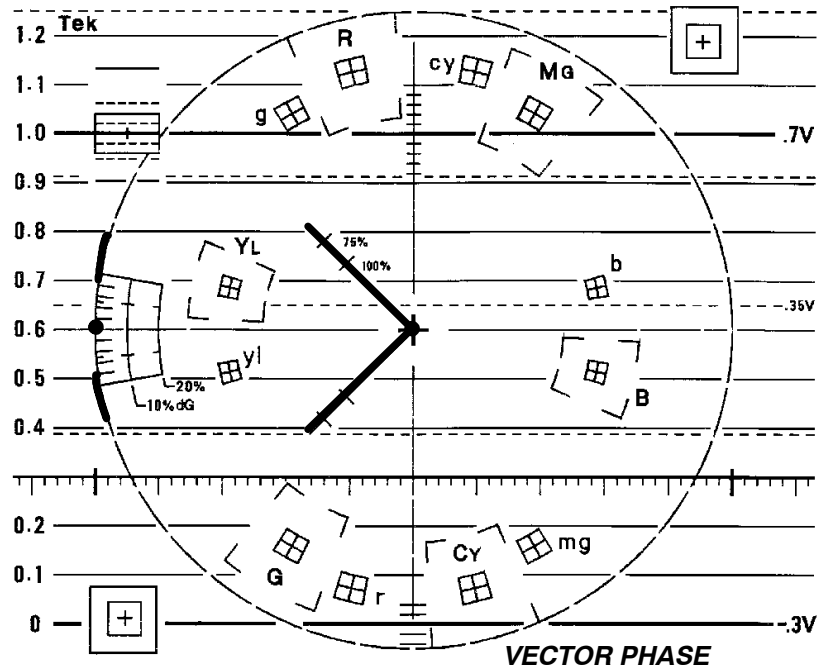

Figure 4-8. PAL SC/H display.

SC/H R-Y

SC/H phase can be viewed over a frame of video. Select WAVEFORM display and FIELD sweep. Enter the FILTER menu and select SC/H R-Y. For NTSC, stable SC/H is a horizontal line as shown in Figure 4-10. (Figure 4-9 shows the same display with a LINE sweep selected.) A sample SC/H phase error is shown in Figure 4-11. The flat lines indicate that SC/H phase is stable over the entire frame. For PAL, SC/H is a sine wave resulting from the 25 Hz offset (Figure 4-12).

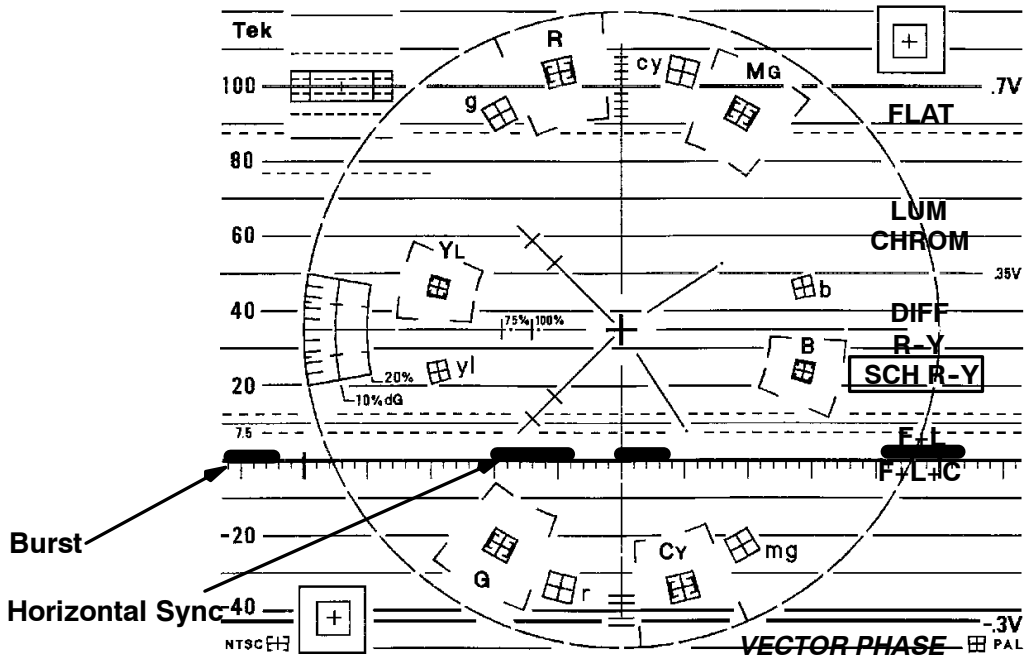

Figure 4-9. Two-Line SC/H R-Y display (NTSC), with proper SC/H phase.

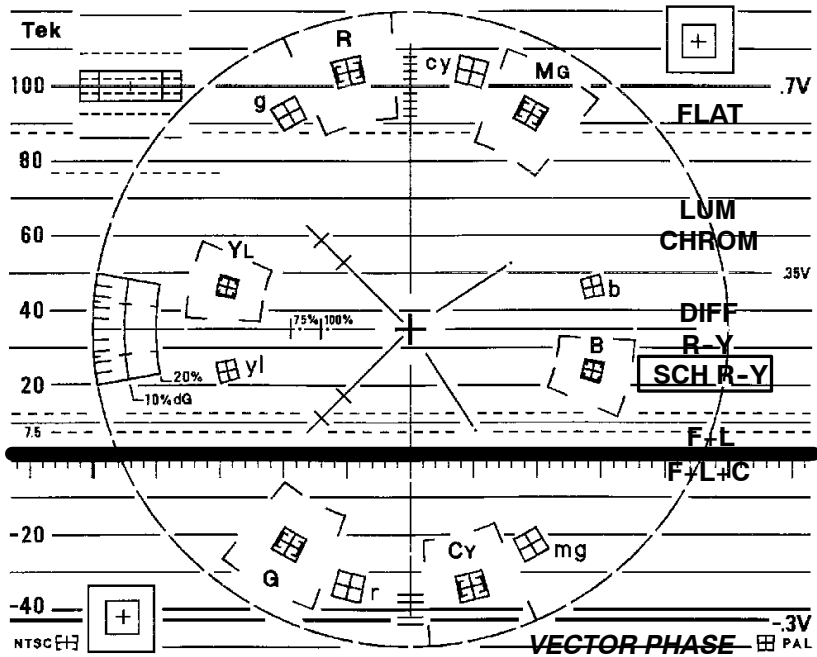

Figure 4-10. Two-Field SC/H R-Y display (NTSC), showing proper SC/H phase.

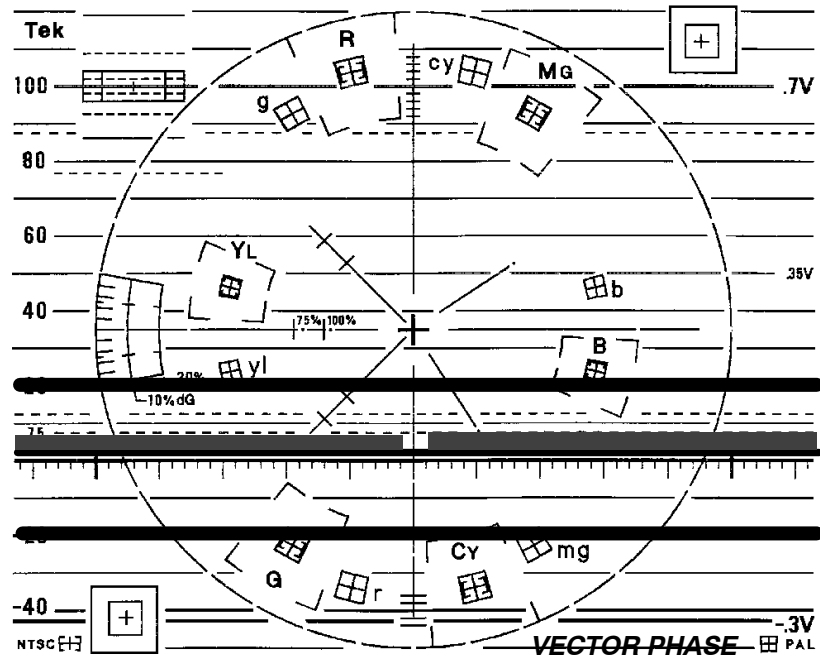

Figure 4-11. Two-Field SC/H R-Y display (NTSC), showing approximate 10° phase error.

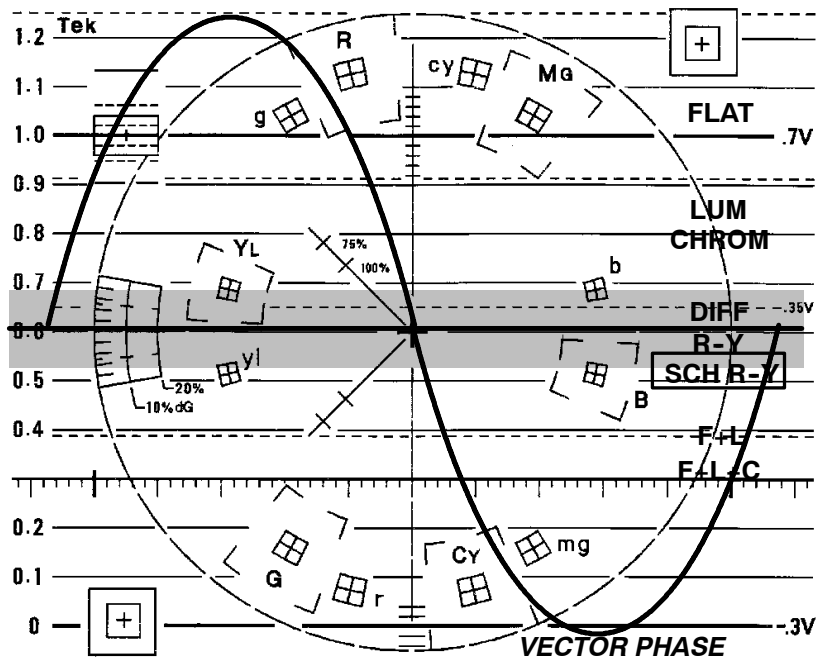

Figure 4-12. Two-Field SC/H R-Y display (PAL), showing proper SC/H phase.

Making Audio Measurements

An audio signal with no phase error appears as a straight line extending from the audio box in the upper right corner of the graticule to the box in the lower left. A signal with phase error appears as an opening in a Lissajous waveform.

Figure 4-13 shows three audio input signals that are equal in amplitude, but have different phase relationships.

Audio gain is set from the GAIN menu when AUDIO display is selected. Gain choices are 0 dBu, 4 dBu, 8 dBu, or 12 dBu. Select gain relative to the system under test.

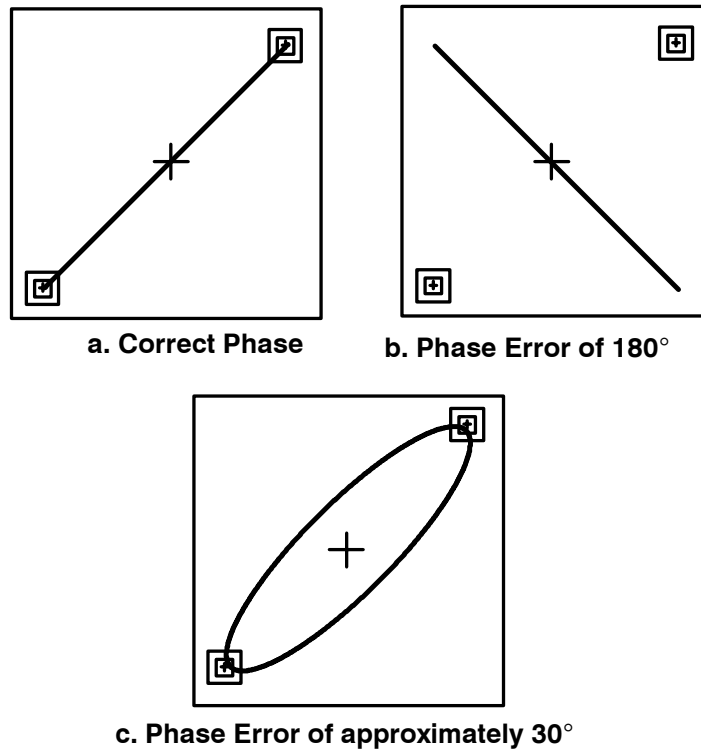

Figure 4-13. Audio displays.

Time Code Display

Linear Time Code, also known as Longitudinal Time Code (LTC), is an 80-bit signal with information which makes it possible to accurately identify an individual frame of recorded video. LTC is typically recorded on an unused audio track. The 1740A/1750A-Series monitor provides a voltage-versus-time display of the Time Code waveform, which can be used to check for the following problems:

- No signal.
- Sync word in the wrong position (improper Time Code-to-Video sync).
- Low amplitude or noisy time code signal.

To display the Time Code signal on the monitor, connect the video signal containing LTC to the rear-panel REMOTE connector as follows: pin 12 (+ input), pin 13 (- input), and pin 14 (ground). Push the front-panel TIME CODE button. The display should be a stable square wave.

Sync Word

The trigger point is FIELD 1 of the applied video waveform—either internal or external reference. When synchronized to video, the display is stable. The sync word should appear on the right. If it is missing, drifting, or in another position, there is a problem with the Time Code-to-Video synchronization.

Amplitude

Time code gain is set from the GAIN MENU when TIME CODE display is selected. Gain choices are 0 dBu, 4 dBu, 8 dBu, or 12 dBu. Select gain relative to the system under test. If the waveform monitor display amplitude is much less than would be expected for the given input, a problem may exist with the Time Code level.

Calibration

Instrument gain may require readjustment for special monitoring applications. To prevent erroneous measurements, gain should be adjusted only by qualified personnel. Normal instrument calibration, performance verification, and service maintenance are covered in the service manual, which will be published as a separate volume.

Adjusting Instrument Gain

Instrument gain can be adjusted through the CONFIG—CALIBRATE menu. CONFIG menu is described on page 3-18.

Set Vertical Gain

1. To adjust vertical gain, select WAVEFORM display mode and push the CONFIG menu button. Select CALIBRATE, then CAL SIG ON and GAIN CAL ON.
 - a. Turn the VERT CAL control until the calibrator signal (or applied reference signal) amplitude is 140.0 IRE (1000 mV for PAL), as read on the graticule.
 - b. Pushing RESET VCAL will cancel any gain adjustment and reinstate the factory gain setting.

Set Horizontal Gain

1. To set horizontal gain, push the CONFIG menu button. Select CALIBRATE, then CAL SIG ON and 100 KHZ. Select GAIN CAL ON.
 - a. In 1 LINE SWEEP, adjust the HORIZ CAL control for one-half cycle per major graticule division; in 2 LINE SWEEP, adjust for one full cycle per major division.
 - b. Pushing RESET HCAL will cancel any gain adjustment and reinstate the factory gain setting.

Set Vector Gain

1. To adjust vector gain, select VECTOR display mode and push the CONFIG menu button. Select CALIBRATE, then CAL SIG ON and GAIN CAL ON.
 - a. Adjust VECT CAL so that the calibration signal circle falls on the compass rose (outer ring).
 - b. Pushing RESET VEC CAL will cancel any gain adjustment and reinstate the factory gain setting.



Appendices

Appendix A

Performance Specification

The specification tables use the following abbreviations:

Performance Requirement (Req). All performance requirements in the specification tables are identified with **Req**, and can be assured by completing the Performance Check Procedure (1740A/1750A/1760-Series Service Manual.) Allow a warm-up time of 20 minutes.

Performance requirements in the electrical specifications are valid over an ambient temperature range of +20° C to +30° C. The Performance Requirement tolerances listed in the Electrical Specification are doubled over the temperature range of 0° C to +50° C, unless otherwise specified. Test equipment used to verify Performance Requirements must be calibrated and working within the limits specified in the Service Manual Equipment Required List.

Reference Information. Information that amplifies a performance requirement or is of special importance is indicated by **RI**. There is no need to check these items to a specific tolerance.

Reliability

Mean Time Between Failure (MTBF)

The demonstrated MTBF goal is 40637 hours MTBF at 25° C ambient, which will be monitored from field failure reports.

Mean Time to Repair (MTTR)

The projected MTTR is 1 hour.

Electrical Specifications

Table A- 1: Waveform Vertical Deflection

CATEGORY	DESCRIPTION
Deflection Factor	<p>Req: 1 V full scale (X1): 1 volt input displayed within 1% of 140 IRE (1.00 V PAL)</p> <p>X5 Gain: 0.2 volt input displayed within 1% of 140 IRE (1.00 V PAL)</p> <p>X10 Gain: 0.1 volt input displayed within 1% of 140 IRE (1.00 V PAL)</p> <p>RI: Any one of the 8 inputs</p>
Variable Gain Range	Req: 0.2X to 1.4X
Overscan	<p>Req: ≤1% variation in baseline of chroma when positioned anywhere between sync tip and 100% white</p> <p>RI: X1, X5, or X10 with any variable gain setting</p>
Video Maximum Operating Input Voltage	RI: -1.8 V to +2.2 V, (all inputs, A - B3) dc+peak ac
Absolute Video Input Voltage	RI: -8.5 V to +8.5 V (dc+peak ac)
Video Input DC Impedance	RI: ≥ 20kΩ
Video Input Return Loss	RI: Typically ≥ 40 dB to 6 MHz
Video Input DC Offset Between Channels	<p>Req: ≤ 1 IRE (7 mV PAL)</p> <p>RI: Typically ≤ 1 mV</p>
Video Input Offset Range	RI: CHA2, A3, B2, & B3 can be offset from CHA1 or CHB1 by ±350 mV
Video Input Loop-Through Isolation	RI: Typically ≥ 70 dB

Table A- 1: Waveform Vertical Deflection (Cont.)

CATEGORY	DESCRIPTION
Video Input Crosstalk Between Channels	RI: Typically ≥ 60 dB
Frequency Response (Flat)	Req: $\pm 2\%$ to 10 MHz (X1 Gain) $\pm 4\%$ to 10 MHz (X5 and X10 Gain), on screen signal (0.2 V or 0.1 V) RI: All inputs ac or dc coupling
Luminance Filter Gain	Req: $1 \pm 1\%$ RI: Reference is FLAT at 50 kHz
Luminance Filter Response	Req: ≤ 3 dB attenuation at 1 MHz ≥ 40 dB attenuation at F_{SC}
Luminance Filter Chrominance Rejection (1745A & 1755A only)	Req: ≤ 34 dB
Chrominance Filter Gain	Req: $1 \pm 1\%$ RI: Ref. is flat at F_{SC} (3.58 or 4.43 MHz)
Chrominance Filter Bandwidth	Req: 1.5 MHz ± 0.3 MHz RI: Centered at F_{SC} . Passband is typically $F_{SC} +$ and $- 750$ kHz
Chrominance Filter Attenuation at 2X F_{SC}	RI: ≥ 25 dB
Differentiated Step Filter Attenuation at 2X F_{SC}	RI: ≥ 40 dB

Table A-1: Waveform Vertical Deflection (Cont.)

CATEGORY	DESCRIPTION
Transient Response	<p>Req: Pulse-to-Bar Ratio 0.99:1 to 1.01:1</p> <p>RI: Preshoot $\leq 1\%$</p> <p>RI: Overshoot $\leq 1\%$</p> <p>RI: Ringing $\leq 1\%$</p> <p>Req: Field-Rate Tilt $\leq 1\%$</p> <p>Req: Line-Rate Tilt $\leq 1\%$</p> <p>RI: Differential Gain $\leq 1\%$</p>
Pix Out Gain	Req: $1 \pm 3\%$
Pix Out Frequency Response	Req: $\pm 3\%$ to 6 MHz
Pix Out Differential Gain	RI: $\leq 1\%$
Pix Out Differential Phase	RI: $\leq 1^\circ$
Pix Out Output Impedance	RI: 75Ω
Pix Out Return Loss	Req: ≥ 30 dB to 6 MHz
Pix Out Line Select Strobe	RI: A dc offset is added to output in line select to bright up the selected line or lines.
DC Restorer 60 Hz (50 Hz) Attenuation	<p>Req: Slow Mode $\leq 10\%$ Fast Mode $\geq 95\%$</p> <p>RI: Back porch or sync tip clamp point is selected through menu.</p>
DC Restorer Offset Error	<p>Req: ≤ 1 IRE (7 mV PAL)</p> <p>RI: Typically 3 mV</p>
Fast Settling Time	RI: ≤ 6 video lines
Blanking Shift with 10 to 90% APL Change	Req: ≤ 1 IRE (7 mV PAL)

Table A- 1: Waveform Vertical Deflection (Cont.)

CATEGORY	DESCRIPTION
Blanking Shift with Presence and Absence of Burst	Req: ≤ 1 IRE (7 mV PAL) RI: Typically 3 mV

Table A- 2: External Reference

CATEGORY	DESCRIPTION
Input	RI: Composite video or black burst
Maximum Operating Input Voltage	RI: -1.8 V to +2.2 V, dc + peak ac
Absolute Maximum Input Voltage	RI: -8.5 V to +8.5 V, dc + peak ac
DC Input Impedance	RI: ≥ 20 k Ω
Return Loss	RI: Typically ≥ 40 dB to 6 MHz

Table A-3: Waveform Horizontal Deflection

CATEGORY	DESCRIPTION
Sweep	<p>Req: Synchronization: Sweep triggered by horizontal and vertical sync pulses</p> <p>RI: Sweep Length: ≈ 12 divisions</p> <p>RI: Sweep freeruns without input</p>
Sweep Timing Accuracy	<p>Req: 1 Line: $5 \mu\text{s/division} \pm 1\%$ 2 Line: $10 \mu\text{s/division} \pm 1\%$</p> <p>RI: 1 Field: displays one full field, including field rate sync</p> <p>2 Field: displays two full fields and the field rate sync between them</p>
Sweep Linearity	<p>Req: 1 line: $\pm 1\%$ 2 line: $\pm 1\%$</p>
Magnified Sweep Accuracy	<p>Req: 1 Line: $0.2 \mu\text{s/division} \pm 1\%$ 2 Line: $1.0 \mu\text{s/division} \pm 1\%$</p>
Magnified Sweep Linearity	<p>Req: 1 line: $\pm 1\%$ 2 line: $\pm 1\%$</p>
Horizontal Position Range	<p>Req: Any portion of the synchronized sweep can be positioned on screen in all sweep modes.</p>
External Horizontal Input	<p>Req: 2 divisions/volt, $\pm 2\%$</p> <p>RI: Menu is selected and enabled by REMOTE connector ground closure.</p>
Remote Sync	<p>RI: Input Amplitude: TTL level</p> <p>RI: Frequency: 25 Hz to 100 Hz positive edge-triggered sweep</p> <p>RI: Enabling Signal: TTL low or ground closure</p>

Table A-4: Measurement Cursors

CATEGORY	DESCRIPTION
Waveform Accuracy	<p>Req: Voltage: 0.5% Timing: 0.5%, for line rate sweeps</p> <p>RI: Typically 0.5% for field rate sweeps</p>
Vector Accuracy	<p>Req: Gain: $\pm 1.5\%$ Phase: $\pm 1^\circ$</p> <p>RI: Measured with respect to the Color Bar signal</p>

Table A-5: RGB/YRGB

CATEGORY	DESCRIPTION
RGB/YRGB	<p>Req: Staircase input gain: 0.8 V/division $\pm 10\%$</p> <p>RI: RGB Sweep Length: 1 Field $\approx 30\%$ of normal 1 Line $\approx 30\%$ of normal</p> <p>RI: YRGB Sweep Length: 1 Field $\approx 25\%$ of normal 1 Line $\approx 25\%$ of normal</p> <p>RI: Maximum staircase operating signal: DC signal plus peakacnotto exceed -12 V to+12 V. Line or field rate sweep.</p> <p>RI: Peak-to-peak acsignal not to exceed 12 V.</p> <p>RI: Sweep Repetition Rate: Field or line rate of displayed video or external sync signal as selected by the front-panel sweep selection.</p>

Table A-6: Calibrator

CATEGORY	DESCRIPTION
Waveform Square Wave	<p>Req: Amplitude: 1.0 V \pm 0.5%</p> <p>Req: Frequency: 100 kHz \pm 0.1%</p> <p>RI: Crystal controlled 10 μs square wave</p>
Waveform Sine Wave	<p>Req: Amplitude: 1.0 V_{p-p}, \pm 1%</p>
Vector Circle	<p>RI: Circle that approximates the graticule compass rose</p>

Table A-7: Vector Mode

CATEGORY	DESCRIPTION
Input Requirements	<p>Req: 1 V_{p-p} \pm 6 dB</p> <p>RI: Instrument freeruns with no input</p> <p>RI: External Reference: Black burst or composite video</p>
Nominal Subcarrier Frequency (F _{SC})	<p>RI: NTSC 3.579545 MHz</p> <p>PAL 4.43361875 MHz</p>
Chrominance Processing Bandwidth (-3 dB)	<p>Req: 1 MHz \pm 200 kHz</p>
PAL +V	<p>RI: V Axis is inverted at 1/2 video line rate.</p>
Display Phase Accuracy Error	<p>Req: \leq 1.25°</p>
Display Gain Accuracy Error	<p>Req: \leq 2.5% with 75% amplitude color bars</p>
Quadrature Phasing Error	<p>Req: \leq 0.5° (Bursts set to targets)</p>
Subcarrier Regenerator Pull-in Range	<p>Req: NTSC: \pm 50 Hz</p> <p>PAL: \pm 10 Hz</p>

Table A-7: Vector Mode (Cont.)

CATEGORY	DESCRIPTION
Subcarrier Regenerator Pull-in Time	RI: ≤ 2 seconds
Phase Shift with F_{SC} Change	Req: NTSC: $\leq 2^\circ$ (F_{SC} to $F_{SC} \pm 50$ Hz) PAL: $\leq 2^\circ$ (F_{SC} to $F_{SC} \pm 10$ Hz)
Phase Shift with Burst Amplitude Change of ± 6 dB	Req: $\leq 2^\circ$
Phase Shift With Video Input Channel Change	Req: $\leq 1^\circ$ RI: With external reference selected. Typically $\leq 0.5^\circ$
Phase Shift With Variable Gain Control +3 dB to -6 dB.	Req: $\leq 0.5^\circ$
Burst Jitter	RI: $\leq 0.5^\circ$ rms
Clamp Stability	Req: $\leq 1/64$ inch (0.4 mm) RI: Center spot movement with rotation of the phase control
Phase Control Range	RI: 360° continuous rotation
Phase Control Quantization	RI: $\leq 0.2^\circ$
Position Control Range	Req: ≥ 0.236 inch (6 mm) from center
Differential Phase	Req: $\leq 1^\circ$
Differential Gain	Req: $\leq 1\%$

Table A-8: Audio Mode

CATEGORY	DESCRIPTION
Input	RI: DC coupled, differential input
Input Impedance	RI: 20 k Ω
Full Scale Selection	RI: 0, 4, 8, & 12 dBm full scale. Menu selected
Full Scale Accuracy	Req: ± 0.5 dB RI: Measured at 1 kHz
Maximum Input Voltage	RI: ± 8 V peak RI: Measured to chassis ground
Bandwidth (-3 dB)	Req: -3 dB ≥ 200.0 kHz
X & Y Input Phase Matching	Req: $\leq 1^\circ$ RI: Measured at 20 kHz

Table A-9: Time Code

CATEGORY	DESCRIPTION
Input	RI: Longitudinal Time Code. DC coupled, differential input
Input Impedance	RI: 20 k Ω .
Input Amplitude	RI: 0, 4, 8, & 12 dBm full scale. Menu selectable for 140 IRE (1.0 V) deflection
Maximum Input Voltage	RI: -10 V to +10 V peak
Bandwidth (-3 dB)	Req: ≥ 200.0 kHz

Table A- 10: SCH Phase Mode (1750-Series Only)

CATEGORY	DESCRIPTION
Absolute Accuracy	<p>Req: $\leq 5^\circ$</p> <p>RI: Applies over a temperature range of 0 - 50° C</p> <p>RI: Calibrated at 25° C. ± 3 dB input amplitude. Typically $\leq 5^\circ$ with ± 6 dB input amplitude</p>
Relative Accuracy	RI: 2°
Acquisition Time	RI: ≤ 1 Second
Displayed Phase Error Caused by CRT Geometry Variations	RI: $\pm 1.25^\circ$
Input Timing	RI: Stable display with Video to External Reference timing
Color Frame Range	RI: $\pm 70^\circ$ (Color frame correctly identified when applied external reference signal is $\leq 70^\circ$ of 0° SCH.)

Table A- 11: CRT Display (PAL Values in Parentheses)

CATEGORY	DESCRIPTION
CRT Viewing Area	<p>RI: 80 X 100 mm</p> <p>Horizontal: 12.5 divisions</p> <p>Vertical: 170 IRE (1.19 V)</p>
Accelerating Potential	RI: Nominally 13.75 kV
Trace Rotation Range	<p>Req: $< +$ and -1° from horizontal</p> <p>RI: Total adjustment range is typically $\geq 8^\circ$.</p>
Graticule	RI: Internal with variable illumination

Table A- 12: Power Source

CATEGORY	DESCRIPTION
Mains Voltage Range	Req: 90-250 V RI: Continuous range from 90 to 250 Vac
Mains Frequency	RI: 50 or 60 Hz.
Power Consumption	RI: 110 VA (67 watts) maximum; 102 VA (60 watts) typical

Table A- 13: Environmental Characteristics

CATEGORY	DESCRIPTION
Operating Temperature	Req: 0° to 50° C (+32° to 122° F)
Storage Temperature	Req: -40° to 75° C (-40° to 158° F)
Operating Altitude	Req: To 15,000 feet (4572 meters)
Storage Altitude	Req: To 50,000 feet (15,240 meters)
Vibration	Req: 5 minutes at 5 - 15 Hz with 0.060 inch displacement 5 minutes at 15 - 25 Hz with 0.040 inch displacement 5 minutes at 25 - 55 Hz with 0.020 inch displacement Military Specification: Mil-T-28800D, Paragraph 1.2.2, Class 3
Mechanical Shock	Req: Non Operating: 50 g 1/2 sine, 11 ms duration 3 shocks per surface (18 total)
Transportation	Req: Qualified under NSTA Test Procedure 1A, Category II (24 inch drop)
Humidity	Req: Will operate at 95% relative humidity for up to five days. Do not operate with visible moisture on the circuit boards.

Table A- 14: Physical Characteristics

CATEGORY	DESCRIPTION
Dimensions	Req: Height: 5 1/4 inches (133.4 millimeters) Width: 8 1/2 inches (215.9 millimeters) Depth: 18 1/8 inches (460.4 millimeters)
Weight	Req: Net: 8 pounds (3.8 kilograms) Shipping: 15.7 pounds (7.2 kilograms) <i>approximate</i>

Certifications and Compliances

Table A- 15: Certifications and compliances

CATEGORY	STANDARDS OR DESCRIPTION
EC Declaration of Conformity - EMC ¹	<p>Meets intent of Directive 89/336/EEC for Electromagnetic Compatibility. Compliance was demonstrated to the following specifications as listed in the Official Journal of the European Union:</p> <p>EN 50081-1 Emissions: EN 55022 Class B Radiated and Conducted Emissions</p> <p>EN 50082-1 Immunity: IEC 801-2 Electrostatic Discharge Immunity IEC 801-3 RF Electromagnetic Field Immunity IEC 801-4 Electrical Fast Transient/Burst Immunity</p> <p>¹ High-quality shielded cables must be used to ensure compliance to the above listed standards. This product complies when installed into any of the following Tektronix instrument enclosures: 1700F00 Standard Cabinet 1700F02 Portable Cabinet 1700F05 Rack Adaptor</p> <p>AS/NZS 3548 Information Technology Equipment: 1995</p>
FCC Compliance	Emissions comply with FCC Code of Federal Regulations 47, Part 15, Subpart B, Class A Limits.

Table A-15: Certifications and compliances (cont.)

CATEGORY	STANDARDS OR DESCRIPTION
<p>Installation (Overvoltage) Category</p>	<p>Terminals on this product may have different installation (overvoltage) category designations. The installation categories are:</p> <p>CAT III Distribution-level mains (usually permanently connected). Equipment at this level is typically in a fixed industrial location.</p> <p>CAT II Local-level mains (wall sockets). Equipment at this level includes appliances, portable tools, and similar products. Equipment is usually cord-connected.</p> <p>CAT I Secondary (signal level) or battery operated circuits of electronic equipment.</p>
<p>Pollution Degree</p>	<p>A measure of the contaminates that could occur in the environment around and within a product. Typically the internal environment inside a product is considered to be the same as the external. Products should be used only in the environment for which they are rated.</p> <p>Pollution Degree 1 No pollution or only dry, nonconductive pollution occurs. Products in this category are generally encapsulated, hermetically sealed, or located in clean rooms.</p> <p>Pollution Degree 2 Normally only dry, nonconductive pollution occurs. Occasionally a temporary conductivity that is caused by condensation must be expected. This location is a typical office/home environment. Temporary condensation occurs only when the product is out of service.</p> <p>Pollution Degree 3 Conductive pollution, or dry, nonconductive pollution that becomes conductive due to condensation. These are sheltered locations where neither temperature nor humidity is controlled. The area is protected from direct sunshine, rain, or direct wind.</p> <p>Pollution Degree 4 Pollution that generates persistent conductivity through conductive dust, rain, or snow. Typical outdoor locations.</p>

Table A-15: Certifications and compliances (cont.)

CATEGORY	STANDARDS OR DESCRIPTION
Safety Standards	
U.S. Nationally Recognized Testing Laboratory Listing	UL1244 Standard for electrical and electronic measuring and test equipment.
Canadian Certification	CAN/CSA C22.2 No. 231 CSA safety requirements for electrical and electronic measuring and test equipment.
European Union Compliance	Low Voltage Directive 73/23/EEC, amended by 93/69/EEC EN 61010-1 Safety requirements for electrical equipment for measurement, control, and laboratory use.
Additional Compliance	IEC61010-1 Safety requirements for electrical equipment for measurement, control, and laboratory use.
Safety Certification Compliance	
Temperature, operating	+5 to +40° C
Altitude (maximum operating)	2000 meters
Equipment Type	Test and measuring
Safety Class	Class 1 (as defined in IEC 1010-1, Annex H) - grounded product
Overvoltage Category	Overvoltage Category II (as defined in IEC 1010-1, Annex J)
Pollution Degree	Pollution Degree 2 (as defined in IEC 1010-1). Note: Rated for indoor use only.

Appendix A: Performance Specification

Appendix B

Remote Connectors

Remote Connector

The rear-panel REMOTE connector (shown in Figure B-1) is a 25-pin sub miniature D-type with female contacts.

Table B-1 shows pin assignments.

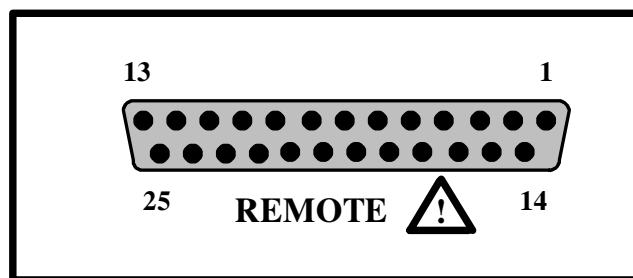

Figure B-1. Rear panel REMOTE connector.

Table B-1. Remote Pin Functions and Signal Requirements

Pin No.	Function	Signal Requirement	Miscellaneous Information
1	RGB/YRGB Staircase Input External Horizontal Input	+10 V for RGB/YRGB 0 - +5 V Sawtooth	≈ 9 div of sweep. (Staircase/external horizontal and RGB/YRGB selections are made through the menu.) 10 div. of horiz. deflection.
2	Ground		
3	Staircase / Ext. Horizontal Enable	Ground (TTL low)	Grounding this pin enables the function. (Staircase or external horizontal selected by menu.)

Appendix B: Remote Connectors

Table B-1. Remote Pin Functions and Signal Requirements (Cont.)

Pin No.	Function	Signal Requirement	Miscellaneous Information
4	External Blanking Input	Negative-going signal	Enabled by menu selection.
5	Remote Sync Input	TTL level square wave triggers a 2-field rate sweep.	30/90 Hz for NTSC 25/100 Hz for PAL
6	Remote Sync Enable	Ground (TTL low)	Grounding this pin enables the function.
7	Ground		
8	+Y Audio Input	Max. Input ± 8 V peak	Measured to Chassis Ground.
9	-Y Audio Input	Max. Input ± 8 V peak	Measured to Chassis Ground.
10	+X Audio Input	Max. Input ± 8 V peak	Measured to Chassis Ground.
11	-X Audio Input	Max. Input ± 8 V peak	Measured to Chassis Ground.
12	+ Time Code Input	-10 - +10 V peak	Longitudinal Time Code, differential.
13	- Time Code Input	-10 - +10 V peak	Longitudinal Time Code, differential.
14	Ground		
15	Not used		
16	Not used		
17	Preset 1	Ground (TTL low)	Grounding pin 17 recalls front-panel setup from preset 1. Grounding pins 17 and 25 stores current front-panel setup at preset 1.
18	Preset 2	Ground (TTL low)	Grounding pin 18 recalls front-panel setup from preset 2. Grounding pins 18 and 25 stores current front-panel setup at preset 2.

Table B-1. Remote Pin Functions and Signal Requirements (Cont.)

Pin No.	Function	Signal Requirement	Miscellaneous Information
19	Preset 3	Ground (TTL low)	Grounding pin 19 recalls setup from preset 3. Grounding pins 19 and 25 stores current setup at preset 3.
20	Preset 4	Ground (TTL low)	Grounding pin 20 recalls setup from preset 4. Grounding pins 20 and 25 stores current setup at preset 4.
21	Preset 5	Ground (TTL low)	Grounding pin 21 recalls setup from preset 5. Grounding pins 21 and 25 stores current setup at preset 5.
22	Preset 6	Ground (TTL low)	
23	Preset 7	Ground (TTL low)	
24	Preset 8	Ground (TTL low)	
25	Store	Ground (TTL low)	Grounding this pin along with one of the Preset pins stores the current front-panel setup at the selected Preset location.

Remote Connector Converter

When the 1740A/1750A-Series is used as a direct replacement for a 1740-Series or 1750-Series instrument, construct an adapter or rewire the remote cable according to Figure B-2.

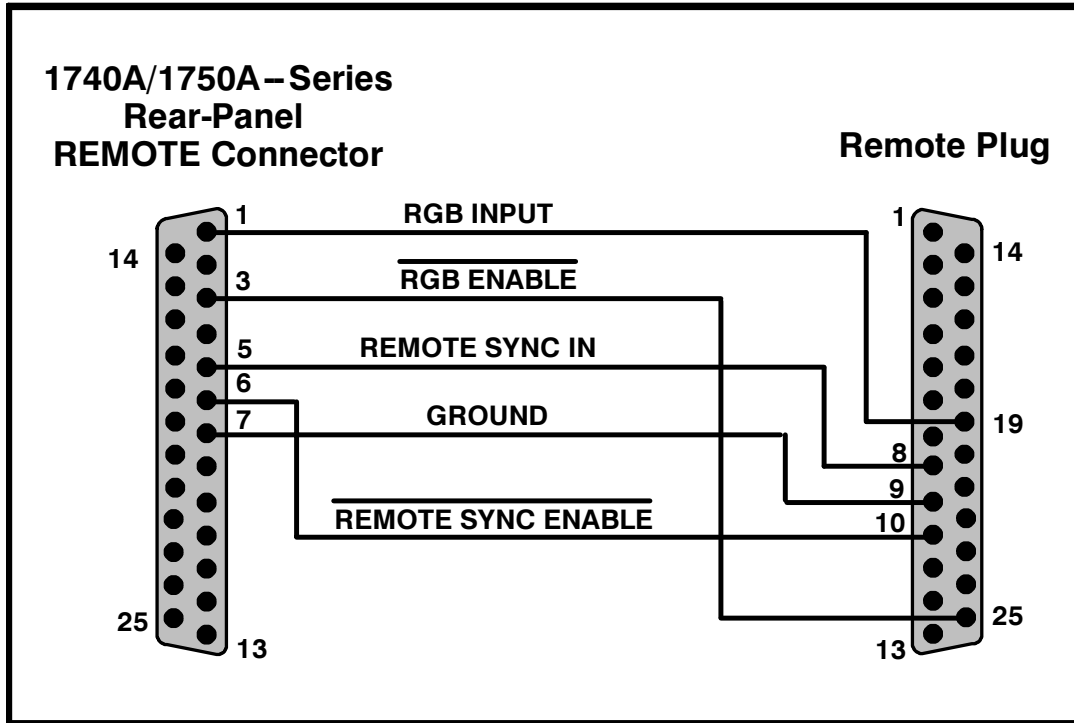

Figure B-2. REMOTE adapter for 1740/1750-Series replacement.

RS232 Connector

The serial interface has a driver built in for RS232 serial binary data interchange. The operational mode is full duplex. The data rate is selectable through the Configure menu for either 1200, 4800, or 9600 baud; data type is asynchronous. Figure B-3 shows the pin assignments.

	PIN NUMBER	DATA CONNECTION
	1.	DCD
	2.	RXD (RECEIVED DATA)
	3.	TXD (TRANSMITTED DATA)
	4.	DTR (DTE READY)
	5.	SIGNAL GROUND
	6.	DCR (DCE READY)
	7.	RTS (REQUEST TO SEND)
	8.	CTS (CLEAR TO SEND)
	9.	NOT CONNECTED

Figure B-3. Rear panel RS232 connector.

NOTE

The function of the RS232 connector may not be supported at the time of this printing. The RS232 interface is used during an upgrade of the instrument software. Contact Tektronix for information on availability of software upgrades and RS232 remote control commands.

Appendix B: Remote Connectors

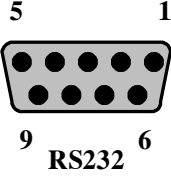
Appendix C

User Service

This section contains instructions for user and preventive maintenance. If the instrument does not function properly, it should be referred to qualified service personnel or returned to Tektronix for service. Packaging directions for shipment are on page 1-9.

Cleaning or Replacing the Fan Filter

To ensure adequate air flow, it is essential to clean or replace the rear-panel fan filter regularly. The interval between filter cleaning or replacement is determined by the operating environment.

To remove the filter, take out the two screws that fasten the housing to the rear panel.

Remove the filter and wash it in a mild detergent and water solution. Place cleaned and dried filter (or new filter) in the housing and replace housing over the fan. Replace and tighten the two screws (8 in lbs).

The filter part number is shown on page 1-7.

Fuse Replacement

Remove the fuse cap from the rear panel and replace the fuse cartridge with a 250V, 2A, F-type fuse as specified on the rear panel.

Graticule Light Replacement

Replacement Bulbs

Replacement bulbs are supplied with this instrument as Standard Accessories. Additional bulbs can be purchased from Tektronix or from local electronics distribution sources. The Tektronix part number and ordering information is given on page 1-7.

Required Equipment

NOTE

For graticule light removal and replacement, tweezers with curved, serrated tips are recommended. For example, Miltex PL312,6-100 (equivalent to PL312) or PL317 (longer than PL312).



Needle-nosed pliers are not recommended.

Procedure

1. Remove the five knobs below the CRT.
2. Insert a small, straight-blade screwdriver into the recessed area on either the right or left side of the panel. Pry gently until the panel snaps out of the front-panel frame. See Figure C-1 for panel and recess location.

3. To remove a bulb, position the tweezer tips on the thin, flat portion of the bulb (close to the plastic socket). Carefully pull the bulb straight out.
4. To install a new bulb, hold it with the tweezers as described in step 3, position it in front of the socket, and push the bulb until it snaps in place.
5. Replace the panel below the CRT, and press on both the right and left sides of the panel until it snaps into place.
6. Replace the five knobs below the CRT and tighten the set screws.

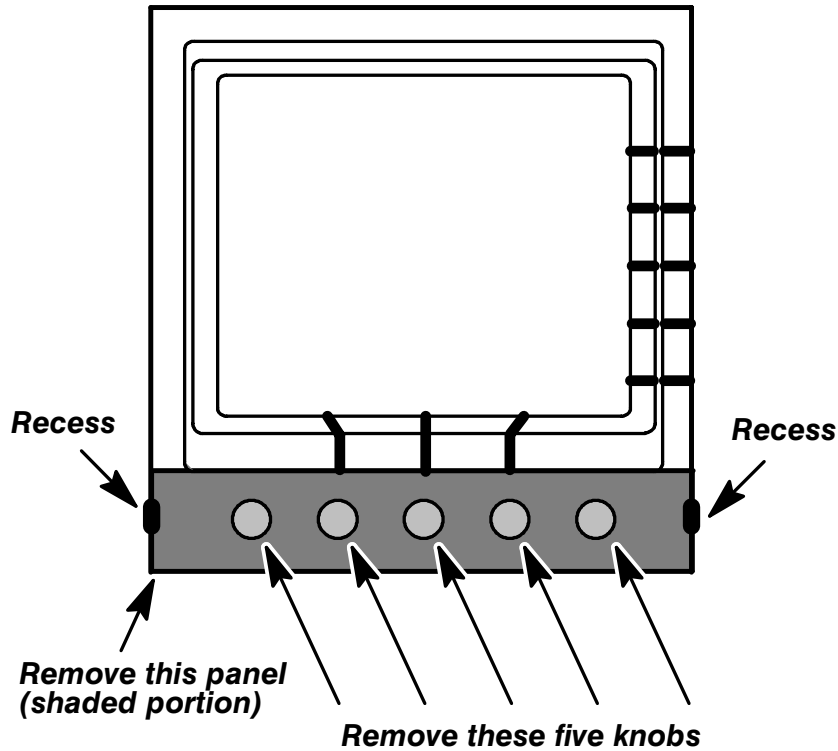

Figure C-1. Graticule light replacement.

Cleaning

The instrument should be cleaned often enough to prevent dust and dirt from accumulating. Dirt acts as a thermal insulator, preventing effective heat dissipation, and can also provide high-resistance electrical leakage paths between conductors or components in a humid environment.



Do not allow water to get inside any enclosed assembly or component. Do not clean any plastic materials with benzene, toluene, xylene, acetone, or similar compounds, because they may damage the plastic.

Exterior

Clean the dust from the outside of the instrument with a soft, clean cloth or small brush. A brush is especially useful for removing dust from around the selector buttons, knobs, and connectors. Hardened dirt can be removed using a soft cloth dampened with a mild detergent and water solution. Abrasive cleaners should not be used.

CRT

Clean the light filter and CRT face with a soft, lint-free cloth dampened in denatured alcohol. Abrasive cleaners should not be used.

Interior

Interior cleaning and maintenance should be performed by qualified service personnel only. Instructions for interior maintenance are provided in the service manual.



A 2% RMA flux content solder is recommended for making repairs in this instrument. Cleaning of rosin residue is not recommended. Most cleaning solvents tend to reactivate the rosin and spread it under components where it may cause corrosion under humid conditions. The rosin residue, if left alone, does not exhibit these corrosive properties.

Replacing the CRT Filter

A smoke-gray filter is installed over the face of the CRT. The filter part number is given on page 1-7. If the filter becomes damaged, it can be replaced in the following manner:

1. Remove the five knobs below the CRT.
2. Insert a small, straight-blade screwdriver into the recessed area on either the right or left side of the panel. Pry gently until the panel snaps out of the front-panel frame. See Figure C-1 for panel and recess location.
3. Remove the two Torx® screws that fasten the bezel to the instrument.
4. Grasping the bottom of the bezel, pull out and upward to remove the bezel from the instrument. (There are two hinges at the top of the bezel that hold it in place; once the bezel is at an approximate 45° angle with the front panel, they will disengage.)
5. Remove the damaged filter and snap the new filter into place on the back side of the bezel. Position the ridged side of the filter towards the CRT to eliminate unwanted visual effects on the CRT face.

Appendix C: User Service

6. Replace the bezel and bezel screws. Tighten screws (8 in lbs).
7. Replace the panel below the CRT, and press on both the right and left sides of the panel until it snaps into place.
8. Replace the five knobs below the CRT and tighten the set screws.

Appendix D

Software Version

Table D-1 details software releases from SNB010100 to present. If a new release occurs after this manual is printed, a revised Table D-1 will be shipped with the manual.

Table D-1. Software Releases

Version	Date	Serial No.	Mod No.	Comments
1.00	SEP 1992	1740A's B010100		Original software.
1.01	NOV 1992	1740A's B010458 1750A's B010100	M7875 0	<p>Installed in new products, not sent for field upgrade.</p> <ul style="list-style-type: none"> • Added AUTO unit of measure selection for CURSORS. • Added flashing on-screen indicator for Gain RESET; Line Select NEXT FIELD, ALT 2 FIELD, and ALT 4 FIELD; and all Preset buttons. • Added SCH R-Y filter to 1750A-Series filter selections. • When Remote Sync is enabled, the on-screen TIME/DIV is not present. When Remote Sync or External Horizontal is enabled with timing cursors, "UNCAL" is displayed in place of a quantitative readout.
1.02	NOV 1992	Custom	N/A	N/A
1.03	DEC 1992	Custom	N/A	N/A

Table D-1. Software Releases (Continued)

Ver- sion	Date	Serial No.	Mod No.	Comments
1.04	JAN 1993	1740/41A, 1750/51A B010729 1745/55A B010100	M7891 4	Product enhancement to coincide with the release of dual-standard monitors. Not sent for field upgrade. <ul style="list-style-type: none"> • Remote sync changed to positive edge trigger. • CONFIG REFERENCE menu now avail. only for dual-standard monitors. A123/B123 Follow selection deleted, replaced with A123/B123 Composite / Component selections in CONFIG INPUT menu. • Dual-standard monitors: When NTSC & PAL ext ref's are set the same, and EXT REF is selected, the ext ref channel is used to determine the video standard. When NTSC & PAL ext ref's differ, the displayed video channel determines the video standard.
2.1	APR 1993	B011760	M7928 3	Added Vector cursors and markers and modified the operation of the A123/B123 INPUT buttons.
2.2	OCT 1993			New features: On-screen field sweep indication. Configure menu selection for RGB Parade display. Audio & Time Code unit of measure changed to dBu. On-screen pointer to left or right side graticule for dual standard. Limited the 1 of 4 and 1 of 8 line select menu entries to instruments with SC/H function only.



Glossary

Glossary

AC Coupled A connection which removes the constant voltage (DC component) on which the signal (AC component) is riding. Usually implemented by passing the signal through a capacitor.

APL (Average Picture Level.) The average signal level (with respect to blanking) during active picture time, expressed as a percentage of the difference between the blanking and reference white levels.

Back Porch The portion of the video signal which lies between the trailing edge of the horizontal sync pulse and the start of the active picture time. Burst is located on back porch.

Bandwidth The range of frequencies over which signal amplitude remains constant (within some limit) as it is passed through a system.

Baseband Refers to the composite video signal as it exists before modulating the picture carrier. Composite video distributed throughout a studio and used for recording is at baseband.

Black Burst (NTSC) Also called "color black," black burst is a composite video signal consisting of all horizontal and vertical synchronization information, burst, and usually setup. Typically used as the house reference synchronization signal in television facilities.

Black Burst (PAL) Also called "color black," black burst is a composite video signal consisting of all horizontal and vertical synchronization information and burst. Typically used as the house reference synchronization signal in television facilities.

Blanking Level Refers to the 0 IRE level for NTSC systems (0.3 volt level, with respect to sync tip, for PAL systems) which exists before and after horizontal sync and during the vertical interval.

Breezeway The portion of the video signal which lies between the trailing edge of the horizontal sync pulse and the start of burst. Breezeway is part of back porch.

Broad Pulses Another name for the vertical synchronizing pulses in the center of the vertical interval. These pulses are long enough to be distinguished from all others, and are the part of the signal actually detected by vertical sync separators.

Bruch Blanking (PAL) A 4-field burst blanking sequence employed in PAL signals to ensure that burst phase is the same at the end of each vertical interval.

Burst (NTSC) A small reference packet of the subcarrier sine wave, typically 8 or 9 cycles, which is sent on every line of video. Since the carrier is suppressed, this phase and frequency reference is required for synchronous demodulation of the color information in the receiver.

Burst (PAL) A small reference packet of the subcarrier sine wave sent during the horizontal blanking interval on every line of video. Since the carrier is suppressed, this phase and frequency reference is required for synchronous demodulation of the color difference signals in the receiver.

B-Y (NTSC) One of the color difference signals used in the NTSC system, obtained by subtracting luminance from the blue camera signal. This is the signal which drives the horizontal axis of a vectorscope.

B-Y (PAL) One of the color difference signals used in the PAL system, obtained by subtracting luminance (Y) from the blue camera signal (B).

Chrominance Chrominance refers to the color information in a television picture. Chrominance can be further broken down into two properties of color: hue and saturation.

Chrominance Signal The high-frequency portion of the video signal which is obtained by quadrature amplitude modulation of a 3.58 MHz (NTSC) or 4.43 MHz (PAL) subcarrier with R-Y and B-Y information.

Color Black See Black Burst.

Color Difference Signals Signals used by color television systems to convey color information in such a way that the signals go to zero when there is no color in the picture. R-Y, B-Y, I, and Q are all color difference signals for the NTSC system; U and V are color difference signals for the PAL system.

Component Video Video which exists in the form of three separate signals, all of which are required in order to completely specify the color picture. For example, R, G, and B; or Y, R-Y, and B-Y.

Composite Video A single video signal containing all of the necessary information to reproduce a color picture. Created by adding quadrature amplitude modulated R-Y and B-Y to the luminance signal for NTSC systems or U and V to the luminance signal for PAL systems.

CW Continuous Wave. Refers to a separate subcarrier sine wave used for synchronization of chrominance information.

dB (Decibel) A decibel is a logarithmic unit used to describe signal ratios. For voltages, $dB = 20 \text{ Log}_{10} (V_1/V_2)$.

DC-Coupled A connection configured so that both the signal (AC component) and the constant voltage on which it is riding (DC component) are passed through.

DC Restorer A circuit used in picture monitors and waveform monitors to clamp one point of the waveform to a fixed DC level.

Demodulator In general, this term refers to any device which recovers the original signal after it has modulated a high-frequency carrier. In television it may refer to:

- (1) An instrument, such as a TEKTRONIX 1450, which takes video in its transmitted form (modulated onto the picture carrier) and converts it to baseband.
- (2) The circuits which recover R-Y and B-Y for NTSC systems or U and V for PAL systems from the composite signal.

Distortion If a sine wave of a single frequency is put into a system, and harmonic content at multiples of that frequency appears at the output, there is harmonic distortion present in the system. Harmonic distortion is caused by non-linearities in the system.

Equalizer The pulses which occur before and after the broad pulses in the vertical interval.

Envelope Detection A demodulation process in which the shape of the RF envelope is sensed. This is the process used by a diode detector.

Field In interlaced scan systems, the information for one picture is divided up into two fields. Each field contains one half of the lines required to produce the entire picture. Adjacent lines in the picture are in alternate fields.

Frequency Modulation (FM) is the process by which the frequency of a carrier signal is varied in proportion to the signal of interest. In both the NTSC and PAL television systems, audio information is transmitted using FM.

Frame A frame (sometimes called a "picture") contains all the information required for a complete picture. For interlaced scan systems, there are two fields in a frame.

Front Porch The portion of the video signal between the end of active picture time and the leading edge of horizontal sync.

Gamma (NTSC) Since picture monitors have a non-linear relationship between the input voltage and brightness, the signal must be correspondingly predistorted. Gamma correction is always done at the source (camera) in television systems: the R, G, and B signals are converted to $R^{1/\gamma}$, $G^{1/\gamma}$, and $B^{1/\gamma}$. Values of about 2.2 are typically used for gamma.

Gamma (PAL) Since picture monitors have a non-linear relationship between the input voltage and brightness, the signal must be correspondingly predistorted. Gamma correction is always done at the source (camera) in television systems: the R, G, and B signals are converted to $R^{1/\gamma}$, $G^{1/\gamma}$, and $B^{1/\gamma}$. Values for gamma range from 2.2 to 2.8.

Gen Lock The process of locking both sync and burst of one signal to sync and burst of another, making the two signals completely synchronous.

Graticule The scale which is used to quantify the information on a waveform monitor or vectorscope display. Graticules may either be screened onto the faceplate of the CRT itself (internal graticule), or onto a piece of glass or plastic which fits in front of the CRT (external graticule). They can also be electronically generated.

Horizontal Blanking Horizontal blanking is the entire time between the end of the active picture time of one line and the beginning of active picture time of the next line. It extends from the start of front porch to the end of back porch.

Horizontal Sync Horizontal sync is the -40 IRE pulse in NTSC systems (-300 mV pulse for PAL systems) occurring at the beginning of each line. This pulse signals the picture monitor to go back to the left side of the screen and trace another horizontal line of picture information.

Hue Hue is the property of color which allows us to distinguish between colors such as red, yellow, purple, etc.

Hum Hum refers to the undesirable coupling of the 60 Hz power sine wave for NTSC systems (50 Hz power sine wave in PAL systems) into other electrical signals.

ITS (PAL) Insertion Test Signal. A test signal which is inserted in one line of the vertical interval to facilitate in-service testing.

IRE (NTSC) A unit equal to 1/140 of the peak-to-peak amplitude of the video signal, which is typically 1 volt. The 0 IRE point is at blanking level, with sync tip at -40 IRE and white extending to +100 IRE. IRE stands for Institute of Radio Engineers, the organization which defined the unit.

Linear Distortion Refers to distortions which are independent of signal amplitude.

Luminance The signal which represents brightness, or the amount of light in the picture. This is the only signal required for black and white pictures, and for color systems it is obtained as a weighted sum ($Y = 0.3R + 0.59G + 0.11B$) of the R, G, and B signals.

Modulated (NTSC) When referring to television test signals, this term implies that chrominance information is present. (For example, a modulated staircase has subcarrier on each step.)

Modulated (PAL) When referring to television test signals, this term implies that chrominance information is present. (For example, a modulated ramp has subcarrier on each step.)

Modulation A process which allows signal information to be moved to other frequencies in order to facilitate transmission or frequency-domain multiplexing. See **AM** and **FM** for details.

Non-Linear Distortion Refers to distortions which are amplitude-dependent.

NTSC National Television System Committee. The organization which developed the television standard currently in use in the United States, Canada, and Japan. Now generally used to refer to that standard.

PAL Phase Alternate Line. Refers to one of the television systems used in Europe and many other parts of the world. The phase of one of the color difference signals alternates from line to line to help cancel out phase errors.

Quadrature AM A process which allows two different signals to modulate a single carrier frequency. The two signals of interest Amplitude Modulate carrier signals which are the same frequency but differ in phase by 90 degrees (hence the Quadrature notation). The two resultant signals can be added together, and both signals recovered at the other end, if they are also demodulated 90 degrees apart.

Quadrature Distortion Distortion resulting from the asymmetry of sidebands used in vestigial sideband television transmission. Quadrature distortion appears when envelope detection is used, but can be eliminated by using a synchronous demodulator.

RF Radio Frequency. In television applications, RF generally refers to the television signal after the picture carrier modulation process

RGB Red, Green, and Blue. Also referred to as GBR. The three primary colors used in color television's additive color reproduction system. These are the three color signals generated by the camera and used by the picture monitor to produce a picture.

R-Y One of the color difference signals is obtained by subtracting luminance (Y) from the red camera signal.

Saturation The property of color which relates to the amount of white light in the color. Highly saturated colors are vivid, while less saturated colors have more white mixed in and, therefore, appear pastel. For example, red is highly saturated, while pink is the same hue, but much less saturated.

In signal terms, saturation is determined by the ratio between luminance level and chrominance amplitude. It should be noted that a vectorscope does not display saturation; the length of the vectors represents chrominance amplitude. In order to verify that the saturation of the colors in a color bar signal is correct, you must check luminance amplitudes with a waveform monitor in addition to observing the vectors.

SCH The timing relationship between the horizontal sync pulses and the zero crossings of the reference subcarrier (burst).

Setup In NTSC systems, video black is typically 7.5 IRE above the blanking level. This 7.5 IRE level is referred to as the black setup level, or simply as setup.

Subcarrier The modulation sidebands of the color subcarrier contain the R-Y (V) and B-Y (U) information. For NTSC, subcarrier frequency is 3.579545 MHz. For PAL, subcarrier frequency is 4,433,618.75 Hz.

Synchronous Detection A demodulation process in which the original signal is recovered by multiplying the modulated signal with the output of a synchronous oscillator locked to the carrier.

Termination In order to accurately send a signal through a transmission line, there must be an impedance at the end which matches the impedance of the source and of the line itself. Amplitude errors and reflections will otherwise result. Video is a 75 Ω system, so a 75 Ω terminator must be put at the end of the signal path.

Time Code, Longitudinal (LTC) LTC is an 80-bit signal with information which makes it possible to accurately identify an individual frame. The LTC signal is typically recorded on an audio channel.

Time Code, Vertical (VITC) VITC is a signal in the vertical interval of video, which makes it possible to accurately identify an individual field.

U The B-Y signal after a weighting factor of 0.493 has been applied. The weighting is necessary to reduce peak modulation in the composite signal.

Unmodulated When used to describe television test signals, this term refers to pulses and pedestals which do not have high-frequency chrominance information added to them.

V The R-Y signal after a weighting factor of 0.877 has been applied. The weighting is necessary to reduce peak modulation in the composite signal.

Vectorscope A specialized oscilloscope which demodulates the video signal and presents a display of R-Y versus B-Y in NTSC systems (or V versus U in PAL systems). The angle and magnitude of the displayed vectors are respectively related to hue and saturation.

Vertical Interval The synchronizing information which appears between fields and signals the picture monitor to go back to the top of the screen to begin another vertical scan.

Waveform Monitor A specialized oscilloscope that plots voltage versus time to evaluate television signals.

Y Abbreviation for luminance.

Zero Carrier Reference A pulse in the vertical interval which is produced by the demodulator to provide a reference for evaluating depth of modulation.

Glossary



Index

Index

A

A123/B123, 2-6, 3-4
Accessories, 1-7

- field upgrade kits, 1-8
- incoming inspection list, 1-9
- optional, 1-7
- standard (included), 1-7

Air filters, replacement, 1-7
Audio display, 2-5, 3-2
Audio measurements, 4-15
Audio Mode, Specification, A-10
Auto

- cursor units, 3-20
- television standard, 3-20

B

Back porch, 3-18
Bezel buttons, 2-2
Bezel controls, 2-2
Blank panel (optional accessory), 1-8
BNC inputs, 2-8

C

Cabinets (optional accessories)

- installation, 1-12
- part numbers, 1-8

Calibrator, Specification, A-8
Calibrator signal frequency, 3-22
Camera (optional accessory), 1-7
Carrying case (optional accessory), 1-8

Certifications, A-13
Compliances, A-13
Chroma bandwidth measurements, 3-7, 4-9
Clamp point, 3-18
Cleaning

- air filter (fan filter), C-1
- the CRT, C-4
- the instrument, C-4

Clear menu, 2-8
Color framing, 3-2
Component signals, 4-3
Configure menu, 3-18

- calibrate, 3-21
- reference, 3-23
- remote, 3-23
- standard (NTSC/PAL), 3-20
- vector, 3-18

Connectors, rear-panel, 2-8
Controls, front-panel, 2-1
Coupling, AC/DC, 3-18
CRT

- filter part number, 1-7
- filter replacement, C-5
- menu, 3-24
- options, 1-6

CRT Display, Specification, A-11
Cursor menu, 3-8

D

DC restorer, 2-5

- slow or fast, 3-18

Differential gain measurements, 4-9
Differential phase measurements, 4-9
Differentiated step filter, 3-7

Index

Dimensions, A-13
Display modes, 2-5, 3-1
Dual-standard graticule, 4-8

E

Electrical installation, 1-10
Electrical specification, A-2
Environmental Characteristics, Specification, A-12
External horizontal, 3-23
External Reference, Specification, A-5
External reference, 2-6, 2-8
 configure, 3-23
 for dual-standard monitors, 3-23

F

Factory preset, 3-16
Fan filter
 cleaning or replacing, C-1
 part number, 1-7
Field sweeps, 2-5
Field upgrade kits, 1-8
Filter, air, see fan filter, 1-7
Filtering, 3-7
Focus, 3-24
Front-panel illustration, 2-3
Front-panel controls, 2-1
Front-panel cover (optional accessory), 1-7
Fuse
 part number, 1-7
 replacing, C-1

G

Gain
 adjustment, 4-17

 menu, 3-24
 reset, 3-22
 X1, X5, X10, 3-24

Graticule

 illumination, 3-24
 vector, 4-7
 waveform, 4-1

Graticule lights

 part number, 1-7
 replacement, C-2

H

HAD bar, 4-5
Horizontal Deflection, Specification, A-6

I

Input channels, 2-6, 3-3
Input connectors, 2-8
Input coupling, 3-18
Installation, 1-9
 electrical, 1-10
 mechanical, 1-12
 remote connector, 1-11
Intensity adjustment, 1-15, 3-24

K

K-factor measurements, 4-5

L

Light bulbs, part number, 1-7
Line select menu, 3-14
Line/Field selection, 2-5
Lissajous waveform, 4-15
Luminance filter, 3-7

M

- Magnifier, 2-5, 3-4
- Mains frequency, 1-11
- Manual, part numbers, 1-7
- Markers, 3-9
- Measurement Cursors, Specification, A-7
- Measurements, 4-1
 - audio, 4-15
 - chroma bandwidth, 4-9
 - differential phase and gain, 4-9
 - horizontal sync amplitude, 4-5
 - k-factor, 4-5
 - peak white, 4-5
 - pulse-to-bar, 4-5
 - SCH phase, 4-10
 - vector, 4-9
- Mechanical installation, 1-12
- Menu
 - clear menu, 2-8, 3-6
 - configure, 2-7, 3-18
 - CRT, 2-7, 3-24
 - cursor, 2-7, 3-8
 - filter, 2-7, 3-7
 - gain, 2-7, 3-24
 - line select, 2-7, 3-14
 - multiple menu displays, 3-5
 - preset, 2-7, 3-16
 - using the menus, 3-5
- Multiple display, 2-5, 3-3
- Multi-use controls, 2-2

O

- Offsets, enable, 3-21
- Operating standard, 1-1, 3-20
- Operating voltage, 1-11
- Optional accessories, 1-7
- Options, 1-5
- Ordering accessories, 1-8

- Overlay mode, 2-7, 3-4

P

- Packaging for shipment, 1-9
- Parade mode, 2-6, 3-4
- Performance specification, A-3
- Physical Characteristics, Specification, A-14
- Picture display, 2-5, 3-2
- Pix out (signal for picture monitor), 2-8
- Polar cursors, 3-8
- Position controls, 2-5
- Power cord, 1-5
- Power Source, Specification, A-12
- Power source, 1-10
- Preset menu, 3-16

R

- R-Y filter, 3-7
- Rack adapter
 - installation, 1-13
 - optional accessory, 1-8
- Readout intensity, 1-15, 3-24
- Rear-panel connectors, 2-8
- Recall preset, 3-17
- Reference (internal/external), 3-23
- Reliability, A-1
- Remote connector
 - configuration, 3-23
 - description, 2-9, B-1
 - pin assignments, B-1
 - wiring converter, B-4
- Remote sync, B-2
- Rename presets, 3-17
- Reset, locked instrument controls, 2-1
- Reset gain, 3-22
- RGB/YRGB, Specification, A-7
- RGB/YRGB staircase input, 3-23

Index

RS232 connector, 2-9, B-5

S

Scale illumination, 3-24
SCH display, 2-5, 3-2
SCH phase measurements, 4-10
SCH Phase Mode, Specification, A-11
SCH R-Y, 3-7
Serial interface, B-5
Servicing, 1-9
Set, instrument gain, 3-22
Setup, graticule, 4-2
Signal intensity, 1-15, 3-24
Software version, 3-23
Specification
 Audio Mode, A-10
 Calibrator, A-8
 Certifications and compliances, A-13
 CRT Display, A-11
 Electrical, A-2
 Environmental Characteristics, A-12
 External Reference, A-5
 Measurement Cursors, A-7
 Physical Characteristics, A-13
 Power Source, A-12
 RGB/YRGB, A-7
 SCH Phase Mode, A-11
 Time Code, A-10
 Vector Mode, A-8
 Waveform Horizontal Deflection, A-6
 Waveform Vertical Deflection, A-2
Staircase, 3-23, B-1
Standard (NTSC/PAL), 1-1, 3-20
Standard accessories, 1-7
Standby mode, 1-10, 2-1
Stereo audio measurements, 4-15
Store presets, 3-17
Subcarrier-to-horizontal phase, 3-2

Sweep rates, 4-1
 selecting, 2-5, 3-4
Sync jitter, 3-2
Sync tip, 3-18

T

Television standard (NTSC/PAL), 1-1, 3-20
Test mode, 3-18
Time Code, Specification, A-10
Time code display, 2-5, 3-3, 4-16
Timing cursors, 3-9
Trace rotation, 3-24

U

Utility drawer (optional accessory), 1-8

V

Vector display, 2-5, 3-1
Vector graticule, 4-7
Vector markers, 3-8
Vector Mode, Specification, A-8
Vertical Deflection, Specification, A-2
Vertical position control, 2-5
Viewing hood (optional accessory), 1-7
Voltage cursors, 3-9

W

Waveform cursors, 3-9
Waveform display, 2-5, 3-1
Waveform graticule, 4-1
Waveform Horizontal Deflection, Specification, A-6
Waveform markers, 3-9
Waveform Vertical Deflection, Specification, A-3

Weight, A-14

White phosphor, 1-6

Index