

Operator's Manual

Tektronix

**1780R-Series
Video Measurement Set**

070-6890-08

This document supports firmware version 1.10 to 1.16.



Copyright © Tektronix, Inc. All rights reserved.

Tektronix products are covered by U.S. and foreign patents, issued and pending. Information in this publication supercedes that in all previously published material. Specifications and price change privileges reserved.

Tektronix, Inc., P.O. Box 1000, Wilsonville, OR 97070-1000

TEKTRONIX and TEK are registered trademarks of Tektronix, Inc.

WARRANTY

Tektronix warrants that the products that it manufactures and sells will be free from defects in materials and workmanship for a period of three (3) years from the date of shipment. If a product proves defective during this warranty period, Tektronix, at its option, either will repair the defective product without charge for parts and labor, or will provide a replacement in exchange for the defective product.

In order to obtain service under this warranty, Customer must notify Tektronix of the defect before the expiration of the warranty period and make suitable arrangements for the performance of service. Customer shall be responsible for packaging and shipping the defective product to the service center designated by Tektronix, with shipping charges prepaid. Tektronix shall pay for the return of the product to Customer if the shipment is to a location within the country in which the Tektronix service center is located. Customer shall be responsible for paying all shipping charges, duties, taxes, and any other charges for products returned to any other locations.

This warranty shall not apply to any defect, failure or damage caused by improper use or improper or inadequate maintenance and care. Tektronix shall not be obligated to furnish service under this warranty a) to repair damage resulting from attempts by personnel other than Tektronix representatives to install, repair or service the product; b) to repair damage resulting from improper use or connection to incompatible equipment; c) to repair any damage or malfunction caused by the use of non-Tektronix supplies; or d) to service a product that has been modified or integrated with other products when the effect of such modification or integration increases the time or difficulty of servicing the product.

THIS WARRANTY IS GIVEN BY TEKTRONIX IN LIEU OF ANY OTHER WARRANTIES, EXPRESS OR IMPLIED. TEKTRONIX AND ITS VENDORS DISCLAIM ANY IMPLIED WARRANTIES OF MERCHANTABILITY OR FITNESS FOR A PARTICULAR PURPOSE. TEKTRONIX' RESPONSIBILITY TO REPAIR OR REPLACE DEFECTIVE PRODUCTS IS THE SOLE AND EXCLUSIVE REMEDY PROVIDED TO THE CUSTOMER FOR BREACH OF THIS WARRANTY. TEKTRONIX AND ITS VENDORS WILL NOT BE LIABLE FOR ANY INDIRECT, SPECIAL, INCIDENTAL, OR CONSEQUENTIAL DAMAGES IRRESPECTIVE OF WHETHER TEKTRONIX OR THE VENDOR HAS ADVANCE NOTICE OF THE POSSIBILITY OF SUCH DAMAGES.

Contacting Tektronix

Product Support	<p>For questions about using Tektronix measurement products, call toll free in North America: 1-800-TEK-WIDE (1-800-835-9433 ext. 2400) 6:00 a.m. – 5:00 p.m. Pacific time</p> <p>Or contact us by e-mail: tm_app_supp@tek.com</p> <p>For product support outside of North America, contact your local Tektronix distributor or sales office.</p>
Service Support	<p>Tektronix offers extended warranty and calibration programs as options on many products. Contact your local Tektronix distributor or sales office.</p> <p>For a listing of worldwide service centers, visit our web site.</p>
For other information	<p>In North America: 1-800-TEK-WIDE (1-800-835-9433) An operator will direct your call.</p>
To write us	<p>Tektronix, Inc. P.O. Box 1000 Wilsonville, OR 97070-1000 USA</p>
Website	<p>Tektronix.com</p>



Table of Contents

General Safety Summary	xi
-------------------------------------	-----------

Getting Started

Documentation Overview	1-1
Operator's Manual	1-1
Service Manual	1-1
Documentation Conventions	1-2
Who Should Use This Operator's Manual	1-2
1780R-Series Product Overview	1-2
New Capabilities	1-3
Touch Screen	1-3
1780R-Series Package	1-4
Mechanical Installation	1-4
Rack-Mounting	1-4
Options	1-9
Standard Accessories	1-9
Optional Accessories	1-10

Connectors, Controls, Indicators

Switches	2-1
Companion Switches	2-1
Controls	2-1
LEDs	2-1
Audio Feedback (Beep)	2-2
A Beep Sounds When:	2-2
Disable the Beep	2-2
A "Click" Occurs When:	2-2
Touch Screen	2-2
Front-Panel Controls	2-3

Power	2-3
CRT Controls	2-3
Precision Measurement (Large Knob)	2-5
Menu Access Switches	2-7
Probe	2-8
Display Mode	2-9
Ref	2-12
Wfm Horizontal	2-12
Magnifier	2-12
Gain	2-13
Filter	2-14
Input	2-15
Rear Panel Connectors	2-16

Operating Instructions

Large Knob And Associated Switches	3-1
Timing Cursors	3-1
Voltage Cursors	3-2
Line Select	3-3
Phase Shift	3-5
Reference Set	3-5
Knob	3-6
< > Switches	3-6
Graticules	3-6
Scale Illumination for Vector and Waveform Graticules ...	3-6
Using The Vector Graticule	3-6
Using The Waveform Graticule	3-12
Remote Operation	3-15
REMOTE Connector	3-15
Remote Operation	3-15
Serial Communications Interface	3-18
Serial Interface Connector	3-18
Building a Wiring Converter	3-18
Serial Remote Information	3-19
SCH Display	3-21
SCH Phase Measurement Procedure	3-22

Parade Operation	3-23
Two Line or Field Parade	3-23
Three Line Display	3-23
Offset Menu	3-23
DC Level Measurements	3-24
DC Level Measurement Procedure	3-25
Overlay Operation	3-26
Overlaid Displays	3-26
Offset Menu	3-26
WFM + CAL	3-27
Enter WFM+CAL Mode	3-27
General WFM+CAL Information	3-27
Menu Information	3-31
Menu Documentation Overview	3-31
Menu Access	3-32
Touch Screen	3-32
Password Menu	3-34
Enable / Disable the Password	3-34
Define the Password	3-34
Change the Password	3-35
Use the Password	3-35
Incorrect Password	3-35
Preset Menu	3-36
Recall	3-36
Recover	3-38
Store	3-39
Name	3-40
Calibrate Menu	3-42
General Calibration Menu Information	3-42
Waveform Calibration Information	3-42
Waveform Calibration Procedure	3-43
Vectorscope Calibration Information	3-46
Vectorscope Calibration Procedure	3-46
Vectorscope Calibration Procedure	3-49
Configure Menu	3-52
Changing Configurations	3-52

Measure Menu	3-56
Using the Measure Menu	3-56
Beep	3-57
Store and Recall Modified Setups	3-57
Making Measurements	3-58

Measurements

Measurement Information	4-1
Differential Phase Measurement	4-2
Enter DIFF PHASE Mode	4-2
Exit DIFF PHASE Mode	4-2
DIFF PHASE Menu Selections	4-2
DIFF PHASE Measurement Information	4-5
Single-Trace DIFF PHASE Measurement Procedure	4-5
Double-Trace DIFF PHASE Measurement Procedure	4-6
Using Line Select in DIFF PHASE	4-6
Differential Gain Measurement	4-7
Enter DIFF GAIN Mode	4-7
Exit DIFF GAIN Mode	4-7
DIFF GAIN Menu Selections	4-7
DIFF GAIN Measurement Information	4-10
Single-Trace DIFF GAIN Measurement Procedure	4-10
Double-Trace DIFF GAIN Measurement Procedure	4-11
Using Line Select in DIFF GAIN	4-11
Simultaneous Diff Phase & Diff Gain Measurements	4-12
Enter DP & DG Mode	4-12
Exit DP & DG Mode	4-12
DP & DG Menu Selections	4-12
DP & DG Measurement Information	4-14
DIFF PHASE & DIFF GAIN Measurement Procedure	4-15
Noise Measurement	4-16
Enter Noise Measurement Mode	4-16
Exit Noise Measurement Mode	4-16
Noise Measurement Procedure	4-16
ICPM Measurement	4-17
Enter ICPM Measurement Mode	4-17
Exit ICPM Measurement Mode	4-17
ICPM Measurement Information	4-17
ICPM Measurement Procedure	4-18

K Factor Measurement	4-20
Enter K Factor Mode	4-20
Making K Factor Measurements	4-20
Chroma / Luma Inequalities Measurement	4-23
Enter Chroma / Luma Mode	4-23
Exit Chroma / Luma Mode	4-23
Cursors in Chroma / Luma	4-23
Making Chroma / Luma Measurements (Using Cursors) ..	4-23
Chroma / Luma Measurements with Lissajous Display ...	4-27
Short-Time Distortion Measurement	4-28
Enter Short-Time Distortion Mode	4-28
Exit Short-Time Distortion Measurement Mode	4-28
Short-Time Distortion Measurement Procedure	4-28
R-Y Sweep Measurement	4-31
Enter R-Y Sweep Mode	4-31
Exit R-Y Sweep Measurement Mode	4-31
R-Y Sweep Mode Information	4-32
Using R-Y Sweep Mode	4-32
Bowtie Measurement	4-33
Enter Bowtie Measurement Mode	4-33
Bowtie Measurement Procedure	4-33
F _{SC} Time Marks Measurement	4-36
Enter F _{SC} Time Marks Measurement Mode	4-36
Exit F _{SC} Time Marks Measurement Mode	4-36
Making SCH Phase Measurements	4-37
Voltage Cursors in F _{SC} Time Marks Mode	4-37
Verifying Burst Position	4-37
Other Measurements	4-38

Specifications

Options and Accessories

Options	6-1
Accessories	6-1
Standard Accessories	6-1
Optional Accessories	6-2

Index

List of Figures

Figure 1–1: Location of the four screws that secure the instrument to rack-mounting cabinet or portable case .	1–5
Figure 1–2: Dimensions used for rack-mounting the 1780R-Series Video Measurement Set	1–6
Figure 1–3: Dimensions of the adjustable rear rack-mounting bracket	1–7
Figure 1–4: Installing rear rack-mounting brackets for rack applications of depths from 18 to 24 inches	1–8
Figure 2–1: Left side of front panel	2–4
Figure 2–2: Right side of front panel	2–10
Figure 2–3: Rear-Panel Connectors	2–17
Figure 3–1: Line Select Menu Screen with <2 OF 4> Fields selected	3–4
Figure 3–2: Line Select Menu Screen with <1 OF 8> Fields selected	3–5
Figure 3–3: 1780R Vector Graticule	3–7
Figure 3–4: 1781R Vector Graticule	3–8
Figure 3–5: Rear-panel X–Y Connector Pin Assignments . .	3–11
Figure 3–6: 1780R Waveform Graticule	3–12
Figure 3–7: 1781R Waveform Graticule	3–13
Figure 3–8: REMOTE Connector Pin Assignments	3–15
Figure 3–9: Serial Interface Connector Pin Assignments . .	3–18
Figure 3–10: Serial Interface Connector Wiring Converter	3–19
Figure 3–11: Portion of the 1780R-Series Front Panel	3–21
Figure 3–12: Offsets Menu Screen	3–24
Figure 3–13: WFM + CAL Readout with ABS selected	3–28
Figure 3–14: WFM + CAL Readout with REL selected . . .	3–28

Figure 3–15: Left Side of Front Panel, showing Menu Buttons and Touch Screen	3–31
Figure 3–16: Touch Screen 4 X 4 Matrix	3–33
Figure 3–17: Password Menu Screen	3–34
Figure 3–18: Preset Menu Screen	3–36
Figure 3–19: Name Menu Screen	3–41
Figure 3–20: Waveform Calibration Menu Display	3–44
Figure 3–21: Vectorscope Calibration Menu Display for 1780R (NTSC), software versions 1.11 & Up, with CAL OSC Off	3–47
Figure 3–22: Vectorscope Calibration Menu Display for 1780R (NTSC), software versions 1.11 & Up, with CAL OSC On	3–48
Figure 3–23: Vectorscope Calibration Menu Display for 1781R (PAL) all software versions, and for 1780R (NTSC) software versions 1.10 & Below	3–50
Figure 3–24: Configure Menu Screen, page 1	3–53
Figure 3–25: Configure Menu Screen, page 2	3–54
Figure 3–26: Configure Menu Screen, page 3	3–55
Figure 3–27: Measure Menu Screen	3–56
Figure 4–1: Measure Menu Access	4–1
Figure 4–2: Differential Phase Measurement	4–3
Figure 4–3: Differential Gain Measurement	4–8
Figure 4–4: DP & DG Measurement	4–13
Figure 4–5: Making ICPM Measurements	4–19
Figure 4–6: K Factor Electronic Graticule	4–21
Figure 4–7: Initial Chroma / Luma Inequalities Measurement Screen	4–24
Figure 4–8: Setting Timing Cursors to Pulse Width	4–26
Figure 4–9: Short-Time Distortion Electronic Graticule ...	4–29
Figure 4–10: Bowtie Measurement Screen	4–34

List of Tables

Table 2–1: Possible Parade and Overlay Configurations ..	2–11
Table 2–2: Waveform Magnification	2–13
Table 2–3: Multiple Filter Displays	2–14
Table 2–4: Possible CH B1, CH B2, CH B3 Switch Settings	2–15
Table 3–1: Plug Jumpers for Vectorscope Board	3–10
Table 3–2: Remote Pin Functions	3–16
Table 3–3: Serial Remote Commands to the 1780R-Series .	3–20
Table 3–4: 1780R-Series Responses	3–20
Table 3–5: Initial Settings	3–37
Table 3–6: Configure Menu Selections, page 1	3–53
Table 3–7: Configure Menu Selections, page 2	3–54
Table 3–8: Configure Menu Selections, page 3	3–55
Table 3–9: Measure Menu Description	3–57
Table 4–1: DIFF PHASE Front-Panel Configuration	4–4
Table 4–2: DIFF GAIN Front-Panel Configuration	4–9
Table 4–3: DP & DG Front-Panel Configuration	4–14
Table 4–4: ICPM Front-Panel Configuration	4–17
Table 4–5: K Factor Front-Panel Configuration	4–22
Table 4–6: Chroma / Luma Front-Panel Configuration ...	4–25
Table 4–7: Short-Time Distortion Mode Front-Panel Configuration	4–30
Table 4–8: R–Y Sweep Mode Front-Panel Configuration .	4–31
Table 4–9: Bowtie Mode Front-Panel Configuration	4–35
Table 4–10: F_{SC} Time Marks Front-Panel Configuration .	4–36
Table 5–1: Input/Output	5–1

Table 5–2: Waveform Monitor Vertical System	5–2
Table 5–3: Waveform Monitor Probe Input	5–7
Table 5–4: Waveform Monitor Horizontal Deflection System	5–7
Table 5–5: Waveform Monitor DG and DP Display	5–11
Table 5–6: Synchronization	5–13
Table 5–7: Vectorscope Vector Display	5–15
Table 5–8: Vectorscope XY Display	5–18
Table 5–9: Vectorscope SCH Phase Display	5–18
Table 5–10: CRTs and High Voltage Supplies	5–19
Table 5–11: Power Requirements	5–20
Table 5–12: Physical Characteristics	5–20
Table 5–13: Certifications	5–21
Table 5–14: Environmental Summary	5–21

General Safety Summary

Review the following safety precautions to avoid injury and prevent damage to this product or any products connected to it. To avoid potential hazards, use this product only as specified.

Only qualified personnel should perform service procedures.

To Avoid Fire or Personal Injury

Use Proper Power Cord. Use only the power cord specified for this product and certified for the country of use.

Use Proper Voltage Setting. Before applying power, ensure that the line selector is in the proper position for the power source being used.

Connect and Disconnect Properly. Do not connect or disconnect probes or test leads while they are connected to a voltage source.

Ground the Product. This product is grounded through the grounding conductor of the power cord. To avoid electric shock, the grounding conductor must be connected to earth ground. Before making connections to the input or output terminals of the product, ensure that the product is properly grounded.

Observe All Terminal Ratings. To avoid fire or shock hazard, observe all ratings and markings on the product. Consult the product manual for further ratings information before making connections to the product.

Do not apply a potential to any terminal, including the common terminal, that exceeds the maximum rating of that terminal.

Do Not Operate Without Covers. Do not operate this product with covers or panels removed.

Use Proper Fuse. Use only the fuse type and rating specified for this product.

Avoid Exposed Circuitry. Do not touch exposed connections and components when power is present.

Wear Eye Protection. Wear eye protection if exposure to high-intensity rays or laser radiation exists.

Do Not Operate With Suspected Failures. If you suspect there is damage to this product, have it inspected by qualified service personnel.

Do Not Operate in Wet/Damp Conditions.

Do Not Operate in an Explosive Atmosphere.

Keep Product Surfaces Clean and Dry.

Provide Proper Ventilation. Refer to the manual's installation instructions for details on installing the product so it has proper ventilation.

Safety Terms and Symbols

Terms in This Manual. These terms may appear in this manual:



WARNING. Warning statements identify conditions or practices that could result in injury or loss of life.



CAUTION. Caution statements identify conditions or practices that could result in damage to this product or other property.

Terms on the Product. These terms may appear on the product:

DANGER indicates an injury hazard immediately accessible as you read the marking.

WARNING indicates an injury hazard not immediately accessible as you read the marking.

CAUTION indicates a hazard to property including the product.

Symbols on the Product. These symbols may appear on the product:



CAUTION
Refer to Manual



WARNING
High Voltage



Double Insulated



Protective Ground (Earth) Terminal



Not suitable for connection to the public telecommunications network



Getting Started

Getting Started

Documentation Overview

This operator's manual is one of a set of two manuals that document the Tektronix 1780R-Series Video Measurement Set. To purchase a service manual, please refer to the "Contacting Tektronix" page located near the front of this manual for address and phone number information.

The topics covered in the two manuals are as follows:

Operator's Manual

Section 1	Document Overview Product Overview Installation
Section 2	Connectors, Controls, Indicators (including front- and rear-panel illustrations)
Section 3	Operating Instructions (including menus)
Section 4	Measurements
Section 5	Specifications
Section 6	Options and Accessories

Service Manual

Installation
Theory of Operation
Performance Check and Adjustment Procedure
Maintenance
Options
Replaceable Electrical and Mechanical Parts Lists (with accessory part numbers)
Schematic Diagrams and Circuit Board Illustrations

Documentation Conventions

Within this manual, front-panel push-button names are shown all in capitals, such as the PRESET menu button. Touch screen words are represented in brackets, such as <DEFAULT>. CRT instructional labels, such as *SELECT MEASUREMENT*, are represented in italics in the manual and on the instrument CRT.

In menu operation, most selections are made by actually touching the desired area on the CRT screen. This is indicated in the manual instructions by the use of the word 'touch' (as opposed to 'push' for front-panel push buttons).

Who Should Use This Operator's Manual:

This operator's manual contains information necessary for daily use, and is appropriate for use by anyone who operates the 1780R-Series Video Measurement Set. (The service manual is intended for use by qualified service personnel only.)

1780R-Series Product Overview

The 1780R-Series Video Measurement Set is a wide bandwidth, multi-input, waveform/vector/SCH measurement package.

The advantages of separate waveform and vector instruments are provided in a single package. Specific measurements take advantage of the 1780R-Series' shared waveform monitor and vectorscope internal processing.

Separate waveform and vectorscope CRTs allow simultaneous monitoring of several video parameters.

Four video inputs may be individually displayed or selected in various combinations on the waveform monitor. Vector presentations may be individually displayed, overlaid for comparison, or compared to an external reference. A fifth video signal may be selected for individual display via the high-impedance front-panel probe input.

Internal video filters provide specialized measurements, with dual or triple filter modes available for simultaneous display.

A selection of internal and external graticules and electronic cursors permit measurements specific to many studio and transmission system applications. An external horizontal input facilitates ICPM measurements.

External staircase from a camera control unit may be selected remotely.

Slow sweep is standard on the 1780R-Series.

New Capabilities

A precision phase control, with on-screen digital phase readout, allows precision phase angle measurements. Differential display resolution is within $.05^\circ$, with an absolute accuracy of 0.1° around the full 360° vector range.

The Tektronix double-trace differential phase measurement technique has been enhanced with a digital recursive vertical filter to permit accurate on-screen readouts in the presence of noise.

The F_{SC} Time Marks feature (NTSC ONLY) allows the operator to verify the accuracy of SCH Phase measurements.

Voltage cursors or Timing cursors can be set to any point, providing accurate on-screen measurement readouts, and are fully operational and accurate at all Gain and Magnifier settings.

In addition to the standard remote interface provided on 1700 Series products, the 1780R-Series provides a serial remote interface, compatible with RS232 and RS422 standards.

Touch Screen

The 1780R-Series has four main menu modes that provide on-screen measurement and calibration selections. Through the Preset menu, the operator can define, name, save, and recall up to 12 front-panel setups.

Many instrument settings can be easily changed through the 1780R-Series touch screen menus. For example, the Configure menu allows the choice of internal or external graticule illumination, and the Calibrate menu allows trace rotation and readout intensity adjustments. The Measurement menu provides entry into specific measurement modes.

1780R-Series Package

The 1780R-Series is supplied as a single 5 1/4-inch high package, ready for rack-mounting. A portable cabinet is available, providing handle, feet, and front and rear covers. The instrument is equipped with a high reliability cooling fan so that no clearance is required above or below the 1780R-Series.

Mechanical Installation

All qualification testing for the 1780R-Series was performed with the rack-mount cabinet installed. To guarantee compliance with specifications, the instrument should be operated in a cabinet, either the rack-mount cabinet or the portable case (1780F02). The 1780F02 case has a handle and front and back covers. The front and back covers provide protection for the instrument during transportation and storage.

NOTE. *Cabinet drawings are provided for installation information only, and are not to scale. All dimensions are in inches.*

The rack-mounting cabinet is a standard accessory; all instruments are factory shipped in this cabinet. Rack-mounting hardware is included and listed in Table 1-1. The portable case (1780F02) is available from Tektronix as an Optional Accessory. It, as does the rack-mounting cabinet, provides the proper electrical environment for the instrument, supplies adequate shielding, minimizes handling damage, and reduces dust collection within the instrument.

Rack-Mounting

The 1780R-Series rack-mounting cabinet is designed for permanent mounting. The instrument slides in and out of the cabinet with relative ease. The instrument is secured in the cabinet with four 6-32 TORX® drive screws. See Figure 1-1.

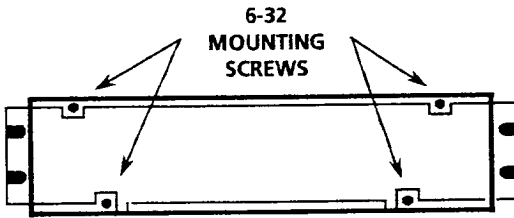

Figure 1-1: Location of the four screws that secure the instrument to rack-mounting cabinet or portable case



WARNING. Do not attempt to carry a cabinetized instrument without installing the rear-panel mounting screws. There is nothing to hold the instrument in the cabinet if it is tipped forward.

Table 1-1: Rack-Mounting Hardware Included

Qty	Description	Part Number
2	Bracket, Extension: 2.5 X 8.06 X 0.06, Steel	407-3752-00
2	Nut Bar: (3) 10-32 X 3.0 X 0.375 X 0.125, Aluminum	381-0251-00
12	Screw, Machine: 10-32 X 0.625, Steel	212-0577-00
4	Washer, Flat: 0.203 ID X 0.625 OD X 0.062, Steel	210-1061-00

A front clearance of at least 18 inches is required for removing the instrument from the rack. BNC connectors on the rear panel extend approximately 0.6 inches, making it necessary to have 1 inch or more of rear clearance to have enough room to cable the instrument. See Figure 1-2 for rack-mounting dimensions.

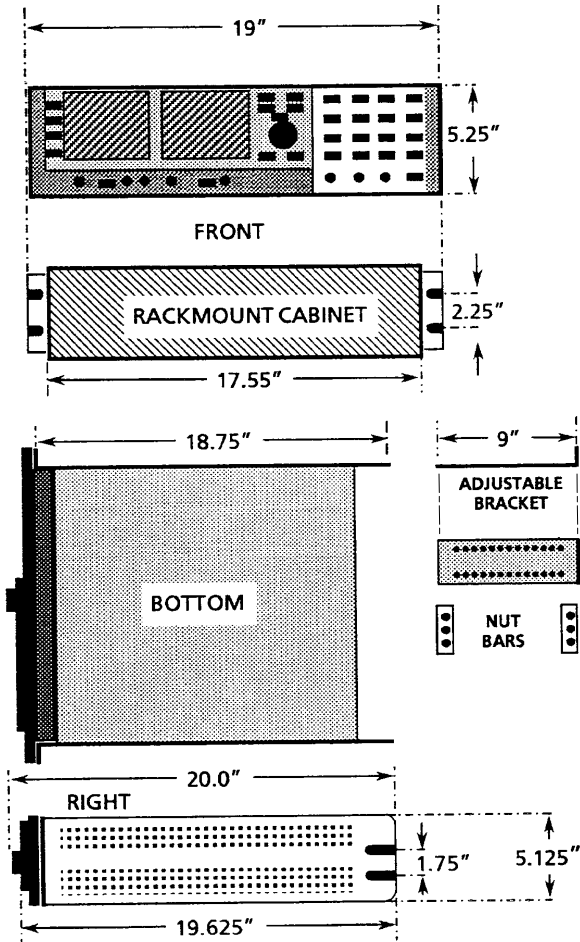

Figure 1-2: Dimensions used for rack-mounting the 1780R-Series Video Measurement Set

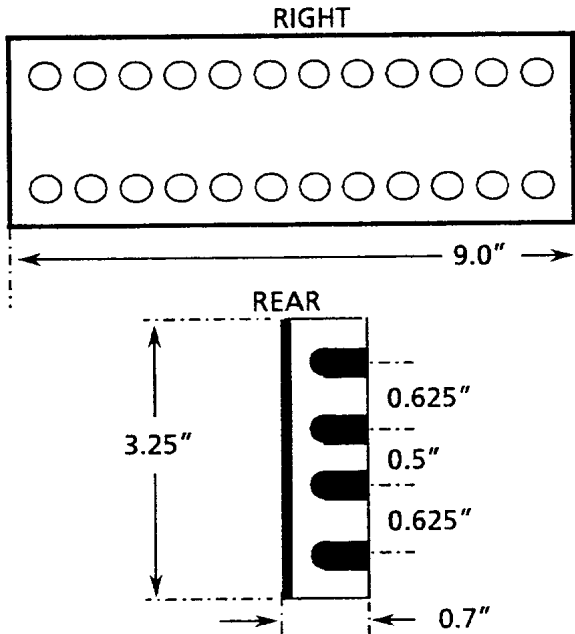

Figure 1-3: Dimensions of the adjustable rear rack-mounting bracket

To install the instrument in the rack: First remove the four securing screws and take the instrument out of the rack-mounting cabinet. (All 1780R-Series instruments are shipped in the rack-mounting cabinet to provide extra shipping protection.) Once the instrument is out of the cabinet, mount the front of the cabinet in the rack, using four 10–32 TORX® screws. Cabinet front slots are spaced, and wide enough, to accommodate standard racks. Next, mount the adjustable brackets to the rear rack section. See Figure 1–3 for bracket dimensions. Then mount the adjustable brackets to the rack-mount cabinet using four 10–32 TORX® screws, four number 10 flat washers, and the nut bars. See Figure 1–4 for more assembly detail. Finally, re-install the four 6–32 screws that secure the instrument to the rack-mounting cabinet. See Figure 1–1.

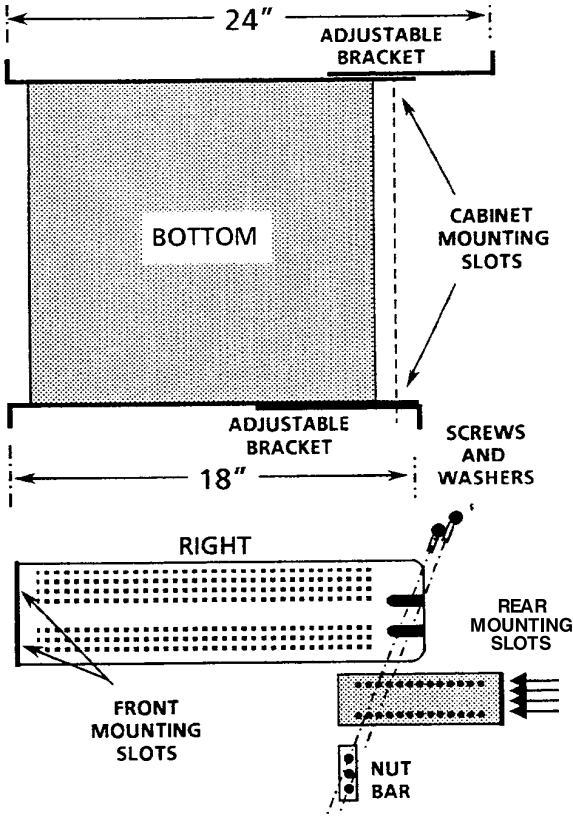

Figure 1-4: Installing rear rack-mounting brackets for rack applications of depths from 18 to 24 inches

NOTE. For ease of installation, place the nut bars to the outside of the adjustable brackets and drive the screws from the center into the nut bars.

For applications where it is necessary to rack-mount the instrument, but have it removable with the instrument case, order the 1780F05 Rack-Mount Shelf.

Options

The 1780R-Series is shipped with a standard U.S. plug, or can be ordered with one of the following options.

Option A1 (220 V, European plug)

Option A2 (240 V, United Kingdom plug)

Option A3 (240 V, Australian plug)

These are the only options currently available for the 1780R-Series. Part numbers are listed in Section 6.

Standard Accessories

The following accessories are shipped with the 1780R-Series. Part numbers are listed in Section 6.

- 1 1780R-Series Operator's Manual
- 1 Cable, Power (Standard, Opt A1, A2, or A3)
- 1 Filter, Air
- 1 Graticule, 511-1979, Visual (1780R ONLY)
- 1 Graticule, 511-1979, Photographic (1780R ONLY)
- 1 Graticule, K-Factor, Visual (1781R ONLY)
- 1 Graticule, K-Factor, Photographic (1781R ONLY)
- 3 Graticule Lamp, Incandescent
- 1 Replacement Cartridge Fuse, 2 A Slow Blow

Optional Accessories

The following is a list of the most common accessory items for the 1780R-Series. Part numbers, if applicable, are listed in Section 6.

1780R-Series Service Manual

Viewing Hood

Portable Cabinet

Extender Kit for Oscillator and Z-Axis Circuit Boards



Connectors, Controls, Indicators

Connectors, Controls, Indicators

This section provides an overview of control and connector functions. To locate more detailed information, please refer to the manual index or table of contents.

Switches

Push and release the front-panel switches to toggle between selections. Push and hold to access outlined selections.

Companion Switches

Some switch functions are paired or grouped so that two or three switches determine one display. These are referred to in this manual as companion switches.

Pushing the same companion switch twice in succession will change its selection (as indicated by the LED).

Pushing first one companion switch and then another will cause the display to alternate between the first switch selection and the second switch selection. Held functions will be forced to the top function of the switch. For example, VECT and SCH together reverts to VECT.

Controls

All front-panel controls are continuous except the Horizontal Position control, which has stops. It also has a spring return which returns it to the center position. The further from center the control is turned, the faster the display moves. This is useful in MAG operation.

The five CRT controls (Focus, Scale, Intens, VPOS, and HPOS) are used to adjust both CRTs. Refer to CRT Controls for details.

LEDs

Green LEDs indicate front-panel switch selections. Some LEDs are located next to the function label, and some are located in the switch itself.

Red LEDs indicate an uncalibrated gain condition.

Audio Feedback (Beep)

A Beep Sounds When:

The limit of a front-panel control range has been reached.

An attempt is made to change a locked setting.

An attempt is made to access an invalid condition, such as a Parade display in 1-line mode.

Disable the Beep

Selecting Beep Off in the Configure menu will disable the beep for all cases except touch screen selection.

A "Click" Occurs When:

A touch screen selection is made. (Click cannot be disabled.)

Touch Screen

Both CRTs are equipped with 4×4 (four vertical and four horizontal divisions) LED matrix touch screens to provide menu access to additional instrument functions.

Selections are made by touching the desired function on the CRT screen.

Instructional labels, such as *SELECT MEASUREMENT*, are shown on the CRT screen in italics.

Touching the CRT screen is indicated in this manual by the use of the word 'touch' (as opposed to 'push' for front-panel switches).

A "click" indicates that a touch screen selection has been made.

If two or more choices are available, the current selection will be outlined on the screen.

If a menu choice is not displayed, nothing will happen when the screen is touched.

A circle around a menu choice indicates the current assignment of the large knob.

Front-Panel Controls

NOTE. Locations for the following controls are shown in Figure 2–1.

Power

1. **POWER.** The Power push-button switch turns the instrument on or to standby status, and displays a colored spot inside the switch when power is on.

CRT Controls

The five CRT controls (Focus, Scale, Intens, VPOS, and HPOS) are used to adjust both CRTs. Assignment of these controls from one CRT to the other is controlled by two illuminated switches, one under the left CRT and one under the right CRT.

When <TIMEOUT> <ON> is selected (Configure menu, described in Section 3), vectorscope assignment of CRT controls will revert to waveform assignment after 30 seconds of no knob activity.

The settings of the five CRT controls are saved and restored when toggling between waveform and vector assignments.

2. **Left switch.** This switch assigns the Focus, Scale, Intensity, and Position controls to operate with the left (vectorscope) CRT.
3. **Right switch.** This switch assigns the Focus, Scale, Intensity, and Position controls to operate with the right (waveform monitor) CRT.
4. **SCALE.** The Scale control adjusts the level of graticule illumination. A beep indicates the limits of the control range.
5. **FOCUS.** The Focus control adjusts the beam for optimum definition. A beep indicates the limits of the control range.
6. **INTENS.** The Intensity control adjusts display brightness. A beep indicates the limits of the control range.

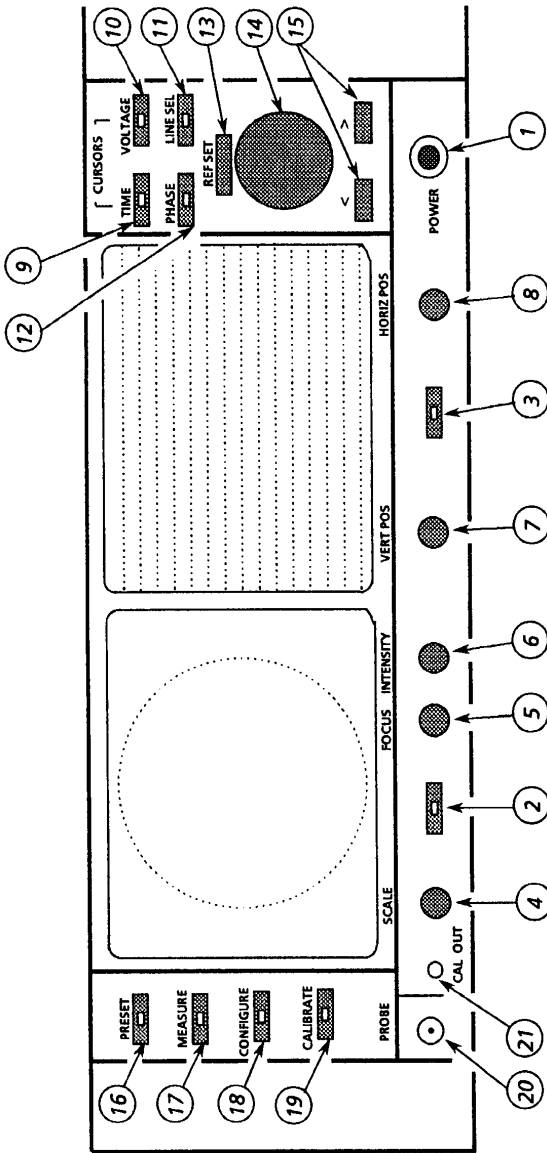

Figure 2-1: Left side of front panel

7. VERT POS. Use the Vertical Position control to move the display up and down. A beep indicates the limits of the control range. (Positioning range is greater for waveform monitor than for vectorscope.)
8. HORIZ POS. Use the Horizontal Position control to move the display left and right. Below SNs B020245 only, this is a spring activated control; turn the control more to move the display faster. A beep indicates the limits of the control range. (Positioning range is greater for waveform monitor than for vectorscope.)

Precision Measurement (Large Knob)

NOTE. Detailed measurement information is located in Section 4.

The TIME and VOLTAGE CURSORS, PHASE SHIFT, and LINE SELECT switches are enabled by pushing the corresponding switch, and exited by pushing that switch again.

While any of these modes is enabled, rotating the large knob provides continuous adjustment, and pushing the < > buttons provides single-step adjustment.

Two, three, or all four of these functions can be enabled at once. Separate readouts are provided for each function. Large knob assignment is determined by the last function button pushed, and can be changed by touching the desired readout area of the CRT screen. Current assignment is circled.

NOTE. Detailed Timing and Voltage Cursor information is located in Section 3.

9. TIME CURSORS. This switch enables the timing cursors. The Timing Cursor menu on the vectorscope CRT provides a choice of cursors that track together or are positioned separately, and a choice between locate and measure.

The readout indicates the time difference between Cursor One and Cursor Two, in increments of 5 nanoseconds. If magnifica-

tion or variable sweep is selected, the cursor interval is magnified correspondingly.

To change the large knob assignment from one cursor to another, touch the quadrant labeled <CURSOR 1 / CURSOR 2>. The current assignment is outlined by a box.

Timing cursors are not valid in Field mode.

For software versions 1.13 and up, installed in instruments SN B020100 and up: Refer to (11) LINE SELECT for information on Timing Cursors in Line Select mode.

NOTE. *Detailed Timing and Voltage Cursor information is located in Section 3.*

10. VOLTAGE CURSORS. This switch enables the voltage cursors. The Voltage Cursor menu on the vectorscope CRT provides a choice of cursors that track together or are positioned separately, and a choice between absolute and relative readout. Cursor One appears as a dashed horizontal line, and Cursor Two as a series of two short dashes on the waveform monitor display. If vertical gain is employed, the cursor interval is magnified accordingly.

To change the large knob assignment from one cursor to another, touch the quadrant labeled <CURSOR 1 / CURSOR 2>. Current assignment is outlined by a box.

11. LINE SELECT This switch enables the line select function, which is available for both waveform and vectorscope. For waveform display, the selected line is displayed first in a multiple line display, and brightened in a field display. Alpha-numeric readout indicates the selected line and field on both CRTs. Additional line select information can be found in Section 3.

Full measurement functions are available in Line Select mode.

Large knob assignment is indicated by a circle, and is selected by touching the line number area on the desired CRT screen.

Different lines can be displayed on the waveform and vector-scope CRTs, when that function is selected via the Line Select menu by touching <WFM = VECT> until <NO> is outlined.

For software versions 1.13 and up, installed in instruments SN B020100 and up: For ease in viewing the Timing Cursors while in Line Select mode, the Timing Cursor dots are positioned on the Voltage Cursors. Upon entering Line Select mode with Timing Cursors on, the Voltage Cursors are automatically enabled.

For software versions 1.13 and up: A dual Line Select mode is available for making ICPM measurements when in Line Select. It is described in Section 4, under *ICPM Measurement*.

12. PHASE SHIFT. This switch enables the precision phase shift measurements. Phase readout appears in the upper left corner of the vectorscope CRT. This readout changes as the phase is shifted. For SCH operation, the phase ranges from 180° to 180° . For Vector, the configure menu offers a choice of two phase displays: 180° to 180° or 0° to 360° .
13. REFERENCE SET. This switch is used in Phase Shift, Voltage Cursor, and Line Select modes. In Phase Shift, it stores the currently displayed phase as a reference and resets the readout to 0.00. In Voltage Cursor mode with <RELATIVE> selected, it stores the currently displayed voltage as a reference and resets the readout to 100% (0 dB). In Line Select mode, it is used to access the vertical interval (line 19).
14. KNOB. The Precision Measurement control (large knob) operates with selected functions to provide continuous adjustment.
15. < > These switches operate with selected functions to provide single-step adjustment. The readout increments are the same as those for the Precision Measurement Control.

Menu Access Switches

NOTE. Detailed menu information is located in Section 3.

16. **PRESET.** This switch provides access to the Preset menu screen, which allows the user to store, recall, and name up to 12 complete instrument setups.
17. **MEASURE.** This switch provides access to the Measurement menu screen. Selections, made by touching the screen, are: DIFF PHASE, DIFF GAIN, DP & DG, NOISE, ICPM, K FACTOR, CHROMA/LUMA, SHORT TIME DISTORTION, RY SWEEP, BOWTIE, and FSC TIME MARKS. Measure menu selections, including user-modified instrument configuration, can be stored and recalled through the Preset menu. When a preset containing a measurement mode is recalled, the instrument will automatically reenter that measurement mode.
18. **CONFIGURE.** This switch provides access to the Configure menu. This is a three-page menu; touch <PAGE> to sequence through the pages. Configure menu settings include units of measure, probe input, DC restorer, int / ext graticules, 75% / 100% color bars, calibrator amplitude, etc.
19. **CALIBRATE.** This switch provides access to the Calibration menu, which toggles between waveform and vectorscope when the buttons under the CRTs are pushed. Specified instrument parameters can be set, using either the internal calibrator signal or an input signal for reference.

Waveform Calibrate menu selections are: CAL SIGNAL ON/OFF, VOLT CURSORS ZERO SET, CAL AMPL ZERO SET, HORIZ POS KNOB CAL, EXT HORIZ CAL, HORIZ CAL, TRACE ROTATION, READOUT INTENSITY, and VERT CAL.

Vectorscope Calibrate menu selections are CAL OSC ON/OFF, TRACE ROTATION, READOUT INTENSITY, and GAIN CAL.

Probe

20. BNC Connector. This is the input connector for a X1 or X10 probe.
21. CAL OUT. This pin jack outputs the calibration signal used to compensate the X10 probe. DC Restorer must be OFF (page 1 of the Configure menu) and EXT REF must be selected.

Display Mode

Companion Switches. Some switch functions are paired or grouped so that two or three switches determine one display. These are referred to in this manual as companion switches.

Pushing the same companion switch twice in succession will change its selection (as indicated by the LED).

A Held mode will be exited when its companion switch is pushed, and then the HELD switch is (momentarily) pushed again. The switch setting will revert to the last selection before the Held mode was entered.

Pushing first one companion switch and then another will cause the display to alternate between the first switch selection and the second switch selection.

***NOTE.** Some switches may be locked out by menu selections.*

Companion Switch Example. VECT / SCH and XY / PIX are used to select vectorscope CRT displays.

Push and release the VECT/SCH switch to select Vector. It will require one or two pushes.

Now push and release the XY / PIX switch to select XY.

Push the VECT / SCH switch. Note that it is restored to Vector.

Push the XY / PIX switch. Note that it is restored to XY.

Push the XY / PIX switch a second time. Now it toggles to PIX.

Push the VECT / SCH switch twice. Now it toggles to SCH.

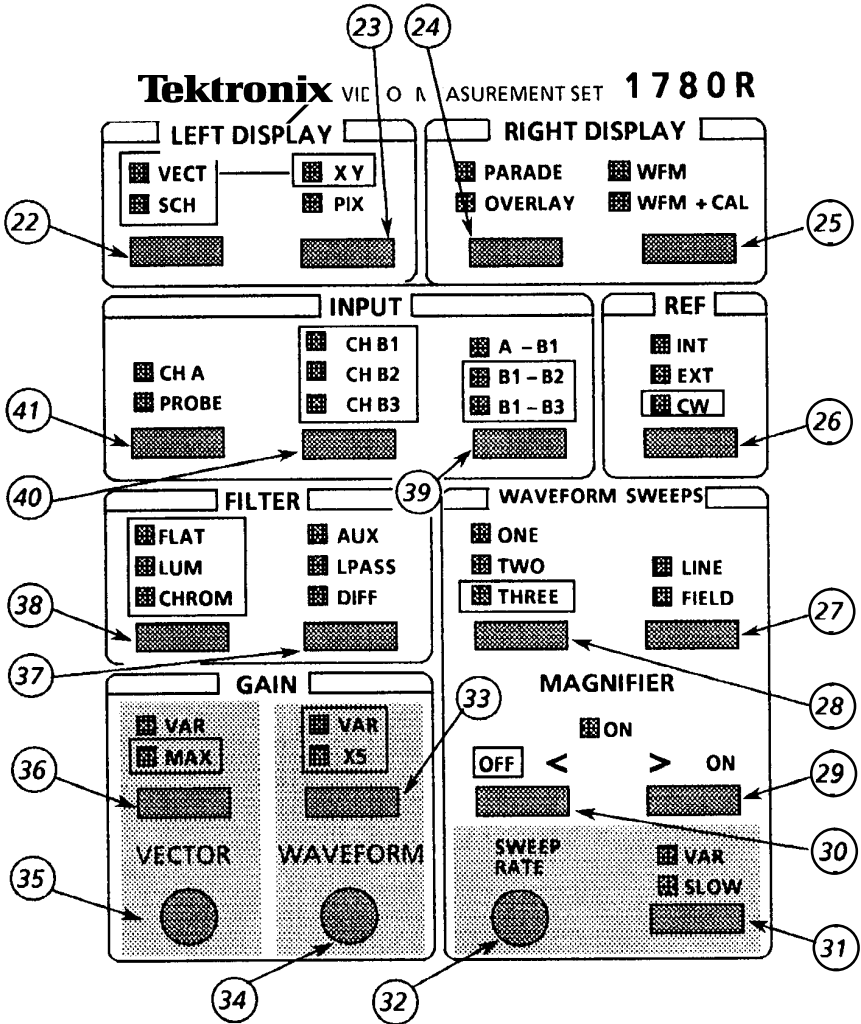

Figure 2-2: Right side of front panel

NOTE. The following switch groups are companion switches: VECT / SCH & XY / PIX, PARADE / OVERLAY & WAVEFORM/ WFM + CAL.

Refer to the preceding instructions entitled Companion Switch Example. Locations of the switches are shown in Figure 2-2.

22. VECT / SCH. Push and release this switch to toggle between Vector and SCH phase display for the vectorscope CRT. Push and hold to access SCH phase and Vector together.
23. XY / PIX. Push and release this switch to toggle between XY and Picture Monitor display for the vectorscope CRT. Push and hold to add XY to the current VECT / SCH selection. Push and release to exit held mode.
24. PARADE / OVERLAY. Push and release this switch to toggle between Parade and Overlay modes. Possible configurations are shown in Table 2-1.

Table 2-1: Possible Parade and Overlay Configurations

Display	Possible Inputs *	Automatic Selections
Parade ONE LINE	No access beep sounds.	If ONE LINE is selected in Overlay or Waveform mode, instrument reverts to TWO LINE or THREE LINE when Parade is selected.
TWO LINE	CH A and Probe, or CH B1 and Probe, or CH A and CH B1, or CH B1 – CH B2 and CH B1 – CH B3 (Bow-tie)	If CH B1, CH B2, and CH B3 are selected, the instrument will revert to THREE LINE mode.
THREE LINE	CH B1 and CH B2 and CH B3	If any combination of two input channels is selected, the instrument will revert to TWO LINE mode.

Table 2-1: Possible Parade and Overlay Configurations (Cont.)

Display	Possible Inputs *	Automatic Selections
Overlay ONE LINE or FIELD	CH B1 and CH B2, or CH B1 and CH B3, or CH B2 and CH B3, or CH A and Probe, or Probe and CH B1, or CH A and CH B1, or CH B1 and CH B2 and CH B3	If TWO LINE or THREE LINE operation is selected, instrument will revert to ONE LINE or FIELD operation when Overlay is selected.

* Other combinations not permitted, and will cause a beep to sound.

25. WFM / WFM+CAL. Push and release this switch to toggle between standard waveform display and waveform plus calibrator signal.

Ref

26. INT / EXT / CW. This switch toggles between an internal signal (incoming video) and an external signal (rear-panel input) for sync and subcarrier reference. Push and hold this switch to select the rear-panel CW input as a subcarrier reference. The LED will indicate whether CW Sync has been set for internal or external (via the Configure menu, page 3).
27. LINE / FIELD. Push and release to toggle between LINE and FIELD. Line and Field combinations are limited only when in Overlay and Parade modes. See Table 2-1.

Wfm Horizontal

28. ONE / TWO / THREE. Push and release to toggle between ONE and TWO. Push and hold to select THREE. The Line and Field combinations are limited only when in Parade or Overlay mode, as shown in Table 2-1.

Magnifier

29. ON >. Push and release to turn on the magnifier, then push again to increase magnification. Push and hold to turn on the magnifier

and continuously increase the magnification factor. Magnification factors are shown in Table 2–2.

Table 2–2: Waveform Magnification

> Button Setting	Magnification Factor	µsec/Div		
		1 Line	2 Line	3 Line
Off	X1	5.0 µs	10.0 µs	15.0 µs
One Push	X5	1.0 µs	2.0 µs	3.0 µs
Two Pushes	X10	0.50 µs	1.0 µs	1.50 µs
Three Pushes	X20	0.25 µs	0.50 µs	0.75 µs
Four Pushes	X25	0.20 µs	0.40 µs	0.60 µs
Five Pushes	X50	0.10 µs	0.20 µs	0.30 µs
Six Pushes	X100	0.05 µs	0.10 µs	0.15 µs

30. OFF <. Push and release to decrease magnification (up to six steps). Turns off the magnifier when pushed enough times, or when held.
31. VAR / SLOW (Switch). This switch toggles between Variable Sweep, Slow Sweep, and Off (calibrated sweep).
32. SWEEP RATE (Control). Use the knob to control the sweep rate when VAR is selected, and sweep duration when SLOW is selected. VAR and SLOW control settings are saved and reinstated each time the mode is entered. To return to calibrated sweep, push the VAR/SLOW button until the red LEDs are off.

Gain

33. VAR / X5 (Switch). This switch controls the waveform monitor vertical gain. Push and release to toggle through variable gain, X5 gain, and off. The waveform knob controls the amount of variable gain when VAR is selected. Push and hold to enable both X5 and Variable Gain.

- 34. **WAVEFORM (Control).** Use this knob to control the amount of variable gain when VAR is selected.
- 35. **VECTOR (Control).** Use this knob to control the amount of variable gain when VAR is selected.
- 36. **VAR / MAX (Switch).** Push and release this switch to turn on the vectorscope variable gain, which is controlled by the Vector knob. Push and hold to disable the variable and set the vectorscope gains to maximum.

Filter

NOTE. *The following switch groups are companion switches: AUX / DIFF / LPASS & FLAT / LUM / CHROM*

Refer to the preceding instructions entitled *Companion Switch Example*.

- 37. **AUX / DIFF / LPASS.** Push and release this switch to toggle through the following selections: Aux Video In (signal is input after the video filters), Differentiated step (linearity steps are translated into spikes for amplitude comparisons), and Low-pass filter (300 kHz bandwidth).
- 38. **FLAT / LUM / CHROM.** Push and release this switch to toggle through the following selections: Flat (unfiltered video signal), Luminance (chrominance filtered out), and Chrominance (luminance filtered out). Push and hold to select a multiple filter display, described in Table 2-3.

Table 2-3: Multiple Filter Displays

Display	Possible Switch Settings
ONE LINE or FIELD	Flat/Lum overlay.
TWO LINE or FIELD	Flat filtered displayed first (left portion of screen), then luminance filtered.
THREE LINE or FIELD	Flat filtered displayed first, followed by luminance filtered and chrominance filtered.

NOTE. The three **INPUT** switches are companion switches. Refer to the preceding *Companion Switch Example*.

Input

- 39.** A–B1 / B1–B2 / B1–B3. This switch selects from the following inputs for display: CH A minus CH B1, CH B1 minus CH B2, or CH B1 minus CH B3. Push and hold this switch to select CH B1 minus CH B2 and CH B1 minus CH B3 together (Bowtie). Instrument will be forced to 2-Line Parade operation.
- 40.** CH B1 / CH B2 / CH B3. In WFM mode, push and release this switch to select the rear-panel Channel B1, Channel B2, or Channel B3 input for display on both CRTs. In Parade mode, all three are forced on. In Overlay, it selects any two or all three input channels on. Refer to Table 2–4 for an outline of possible switch settings.

Table 2–4: Possible CH B1, CH B2, CH B3 Switch Settings

Display	Possible Switch Settings
Overlay ONE LINE or FIELD	Toggles between 2 channels and all 3 channels on.
Waveform TWO LINE or FIELD	Toggles to select any one channel.
Parade THREE LINE or FIELD	CH B1, CH B2, and CH B3 on together
Waveform THREE LINE or FIELD (Push & Hold)	Toggles to select any one channel.

- 41.** CH A / PROBE. This switch selects the rear-panel Channel A input or the front-panel Probe input for display on both CRTs. Upon entering the Probe mode, the following message appears: “PROBE– – 50V DC MAX.”

Rear Panel Connectors

Connectors CH A, CH B1, CH B2, CH B3, EXT REF, and CW are high impedance bridging loop-through inputs. CH A, CH B1, CH B2, and CH B3 have either a grounded or floating shield, depending on the position of the grounding screw, which is located between the BNC connectors.

The following connector locations are shown in Figure 2–3.

1. CH A. CH A accepts composite or component video signals.
2. CH B1. CH B1 accepts composite or component video signals.
3. CH B2. CH B2 accepts composite or component video signals.
4. CH B3. CH B3 accepts composite or component video signals.
5. XY INPUT. XY is a 15-pin D-type connector used as a high impedance input for the 600 Ω balanced audio. XY operation is described in Section 3. The connector pinout is shown in Figure 3–5 on page 3–11.
6. EXT CW REF. CW connector accepts input for continuous subcarrier signal. Provides an external phase reference signal.
7. LINE STRB OUT. LINE STRB OUT is a TTL output that provides a negative-going pulse for the selected line(s) when Line Select is used. When Line Select is off, the output level is low.
8. AUX OUT. AUX OUT provides a 75 Ω video signal output before filtering. AUX OUT can be used with the AUX IN to use custom filters.
9. PIX MON OUT. PIX MON OUT connector provides a 75 Ω output to drive a picture monitor. The signal is output before filtering, and has a bright-up pulse added when Line Select is used.
10. AUX IN. AUX IN provides a 75 Ω input for video signals to the waveform monitor. Signal is inserted after the internal filters.
11. EXT REF. External Reference connector accepts either composite sync or black burst.

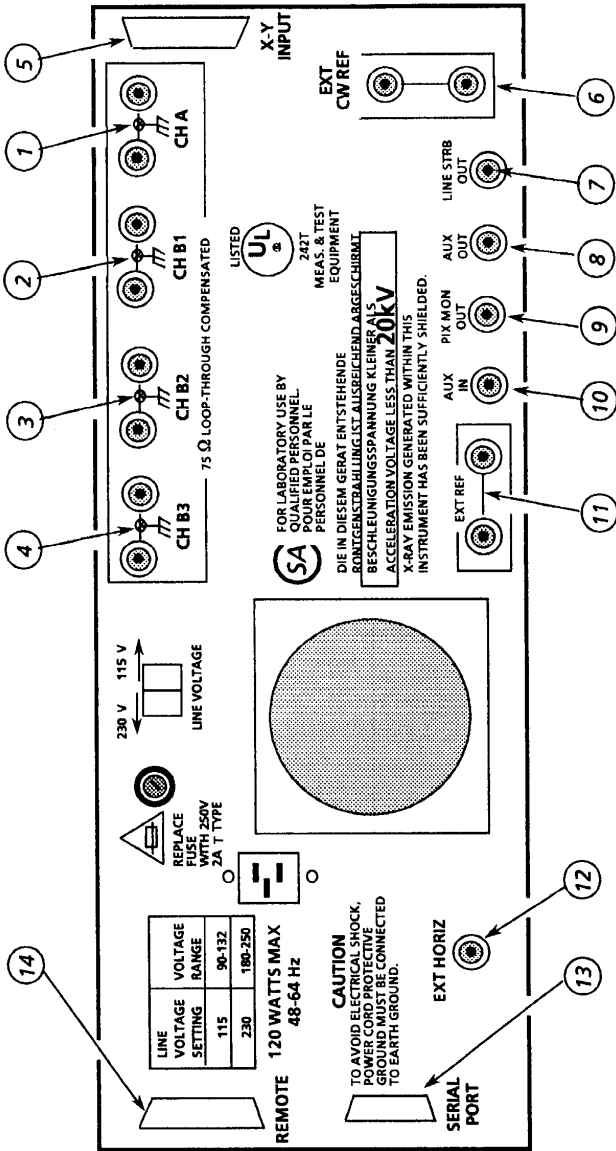

Figure 2-3: Rear-Panel Connectors

12. **EXT HORIZ.** The EXT HORIZ input connector allows external control of waveform monitor sweeps. A positive-going signal deflects the sweep from left to right. A 0 V to +5 V signal is required for full scale deflection (ICPM).
13. **SERIAL PORT.** This 9-pin D-type connector provides a serial remote control interface, compatible with both RS232 and RS422 standards. Serial Port communications are described in Section 3. The connector pinout is shown in Figure 3–9 on page 3–18.
14. **REMOTE.** This 15-pin D-type connector provides a ground closure remote control interface and signal inputs for Remote Sync and RGB/YRGB. Remote operation is described in Section 3. The connector pinout is shown in Figure 3–8 on page 3–15.



Operating Instructions

Operating Instructions

Large Knob And Associated Switches

Timing Cursors

Push the TIME switch to enable the timing cursors and obtain a menu on the vectorscope CRT. Use this menu to choose cursors that track together or are positioned separately, and to choose between locate and measure.

When <SEPARATE> is selected by touching the <SEPARATE/TRACK> area of the screen, the large knob moves Cursor One or Cursor Two, depending on which cursor is selected (outlined). When <TRACK> is selected, the large knob moves both cursors at the same time.

The two cursors appear as bright-up portions of the waveform display when <LOCATE> is selected, or as bright-up dots when <MEASURE> is selected. The readout indicates the time difference between Cursor One and Cursor Two, in five nanosecond intervals.

If magnification or variable sweep is selected, the cursor interval is magnified correspondingly. Time difference between Cursor One and Cursor Two can be determined, even though they may not both be on screen at the same time.

To change the large knob assignment from one cursor to another, touch the quadrant labeled <CURSOR 1 / CURSOR 2>. The current assignment is outlined by a box.

Cursors appear to “wrap around” in One Line and Two Line sweeps because the total cursor range (160 μ s) extends beyond the One or Two Line sweep length. A beep sounds at both ends of the range.

Time difference between Cursor One and Cursor Two can be determined, even though they may not both be on screen at the same time.

Pushing REFERENCE SET has no effect while Timing cursors are enabled.

Timing cursors are not valid in Field modes.

For software versions 1.13 and up, installed in instruments SN B020100 and up: The Timing Cursor dots are positioned on the Voltage Cursors while in Line Select mode, for ease in viewing the Timing Cursors.

Voltage Cursors

Push the VOLTAGE switch to enable the voltage cursors and obtain a menu on the vectorscope CRT. Use this menu to choose cursors that track together or are positioned separately, and to choose between absolute and relative readout.

Cursor One appears as a dashed horizontal line, and Cursor Two as a series of two short dashes on the waveform monitor display.

The large knob provides continuous adjustment of cursors. The <> buttons provide adjustment in discrete steps of 0.1 IRE or 1mV (depending on the Configure menu ABS UNITS selection).

To change the large knob assignment from one cursor to another, touch the quadrant labeled <CURSOR 1 / CURSOR 2>. The current assignment is outlined by a box.

When <SEPARATE> is selected by touching the <SEPARATE / TRACK> area of the screen, the cursors are moved one at a time (currently selected cursor is outlined). When <TRACK> is selected, both cursors move at once.

When <ABSOLUTE> is selected, the readout (in IRE or mV) indicates the voltage difference between the two cursors. The mV / IRE selection is made through page 2 of the Configure menu. The Configure menu instructions appear later in this section. REFERENCE SET has no effect in Absolute mode.

When <RELATIVE> is selected, the readout is shown in percent and dB, relative to the value when REFERENCE SET was last pushed. REFERENCE SET resets the relative value to 100.0% (0 dB).

If vertical gain is employed, the cursor interval is magnified correspondingly. Voltage difference between Cursor One and Cursor Two can be determined, even though they may not both be on screen at the same time.

For software versions 1.13 and up, installed in instruments SN B020100 and up: Voltage cursors are automatically enabled when in Line Select with Timing Cursors.

Line Select

This switch enables the line select function, which is available for both waveform and vectorscope. For waveform display, the selected line is displayed first in a multiple line display, and brightened in a field display. Alpha-numeric readout indicates the selected line and field on both CRTs.

In software versions 1.11 and up, a 1 of 8 Field reference is provided, for use with ghost-cancelling signals. In NTSC, the 8 Field reference is built from two groups of 4 Fields. Touching <ALT FIELD> will toggle between the two groups as a starting point for the 8 Field reference.

When 2 of 4 Field reference is selected, the <FIELD> area in the lower right corner of the screen will toggle between Fields 1 and 3 or Fields 2 and 4; when 1 of 4 is chosen, it will allow selection of Field 1, 2, 3, or 4; and when 1 of 8 (present in software versions 1.11 and up) is chosen, it will allow selection of Field 1, 2, 3, 4, 5, 6, 7, or 8. The selected field or field pair is boxed. When <ALL> Fields is selected, the <FIELD> area is no longer present in the lower right corner of the screen, and all fields are overlaid.

To enable the Line Select menu, first push the LINE SELECT front-panel button, then touch <LSEL MENU> on the vectorscope CRT until <ON> is outlined. To exit the menu, push the same area again until <OFF> is outlined.

Line Select menu choices are shown in Figures 3-1 and 3-2. Touch desired area to toggle between choices. Current selection is outlined by a box.

Touch <VECT 1H/15H> or <WFM 1H/15H> to display the selected line (<1H>) or display the selected line plus the next 14 overlaid (<15 H>).

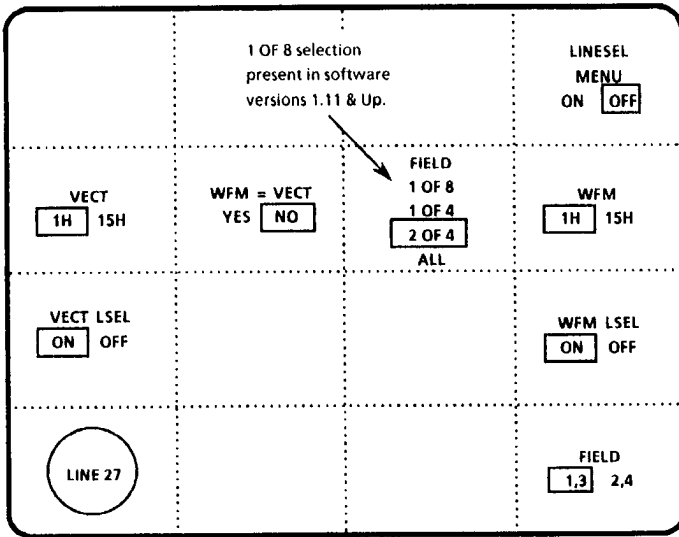

Figure 3-1: Line Select Menu Screen with <2 OF 4> Fields selected

The waveform and vectorscope CRTs can be used to display the same selected line or different lines. To display different lines, enable the Line Select menu, then touch <WFM = VECT> until <NO> is outlined. Be sure that both <VECT LSEL> and <WFM LSEL> show <ON> outlined. Touch <LINESEL MENU> again, so that <OFF> is outlined and the menu is no longer displayed on the vectorscope CRT.

When different lines are displayed on waveform and vectorscope CRTs, touch the line number area on the desired CRT to change the large knob assignment. This assignment is indicated by a circle.

To display the same line on both CRTs, select <WFM = VECT> and <YES>. The line number will be circled on both CRTs.

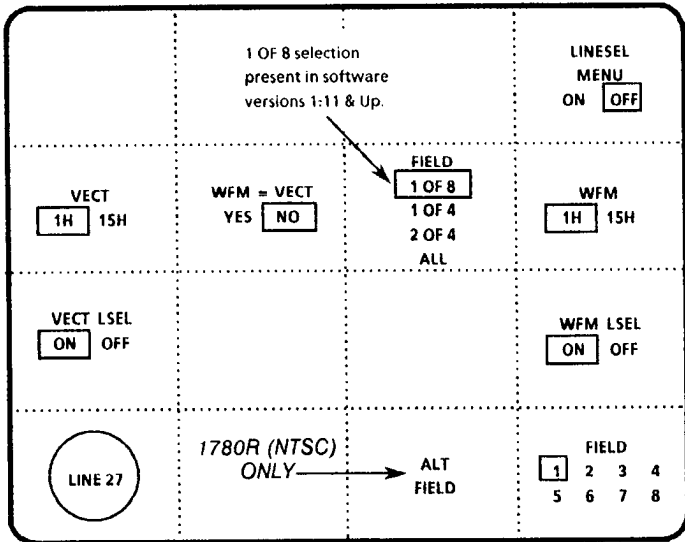

Figure 3-2: Line Select Menu Screen with <1 OF 8> Fields selected

For software versions 1.13 and up: A dual Line Select mode is available for making ICPM measurements when in Line Select. It is described in Section 4, under *ICPM Measurement*.

Phase Shift

This switch enables precision phase shift measurements. Phase readout appears in the upper left-hand corner of the vectorscope CRT.

This readout changes as the phase is shifted, indicating the degrees of change since the phase reference was set.

Reference Set

This switch is used in Phase Shift mode, to store displayed phase as a reference and reset the readout to 0.00; in Voltage Cursor mode with <RELATIVE> selected, to store the displayed voltage as a reference and reset the readout to 100%; and in Line Select mode to access the vertical interval (line 19).

Knob

The Precision Measurement control (large knob) provides analog precision adjustments associated with the REFERENCE SET, LINE SELECT, PHASE, TIMING CURSOR, and VOLTAGE CURSOR switches, or as assigned by menu selections.

The current function of this knob is circled on the CRT screen.

< > Switches

The < > switches provide single-step increments. The readout increments are the same as those for the Precision Measurement Control readout. Push and release for an individual increment, or push and hold to continue increments.

Graticules

This section describes the basic vector and waveform graticule markings for both the 1780R (NTSC), and 1781R (PAL) instruments.

Scale Illumination for Vector and Waveform Graticules

The choice of internal or external graticule illumination is provided on page 2 of the Configure menu. Refer to the Configure menu instructions in this section. To adjust scale illumination, push the button under the vectorscope or waveform CRT (to assign CRT controls to vectorscope or waveform), then adjust the SCALE control as desired.

Using The Vector Graticule

Basic Vector Graticule Markings. The NTSC Vector graticule is shown in Figure 3-3. The polar display permits measurements of hue in terms of the relative phase of the chrominance signal with respect to the color burst. Relative amplitude of chrominance to burst is expressed in terms of the displacement from center (radial dimension of amplitude) towards the color point which corresponds to 75% (or 100%) amplitude for the color being measured.

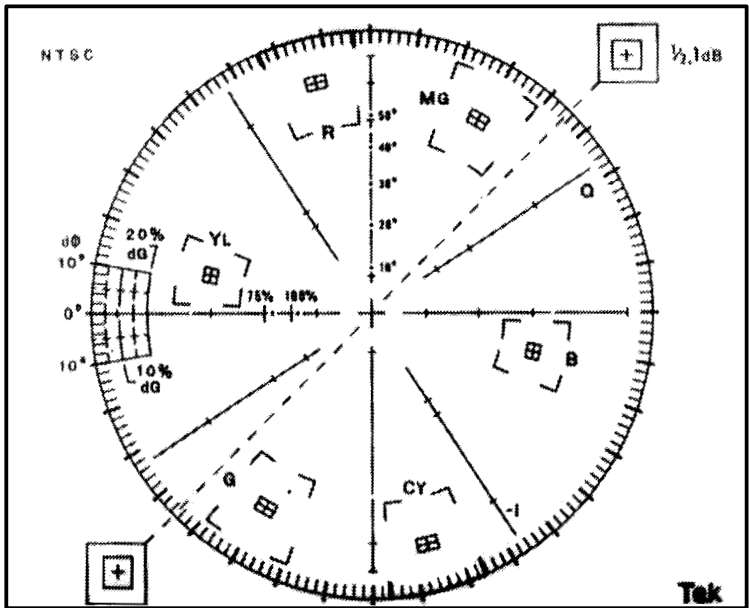

Figure 3-3: 1780R Vector Graticule

The graticule includes four burst amplitude marks: 75% with setup, 75% with no setup, 100% with setup, and 100% with no setup.

On the NTSC graticule, each chrominance vector terminates in a system of graticule targets in the form of two boxes (a small box inside a large box). The dimensions of the large boxes represent $\pm 10^\circ$ centered on the exact chrominance phase, and $\pm 20\%$ of chrominance amplitude centered around 100% of standard amplitude. The dimensions of the smaller boxes represent $\pm 2.5^\circ$ and ± 2.5 IRE.

The PAL Vector graticule is shown in Figure 3-4. On the PAL graticule, each chrominance vector related to the +V burst terminates in targets that are in the shape of two boxes (a small box inside a large box). The dimensions of the large box represent $\pm 10^\circ$ centered on the exact chrominance phase and $\pm 20\%$ of chrominance

amplitude centered around 100% standard amplitude. The dimensions of the smaller inner target represent $\pm 3^\circ$ and $\pm 5\%$ of chrominance amplitude. Note that the chrominance vectors associated with the $-V$ burst are terminated in the smaller targets only.

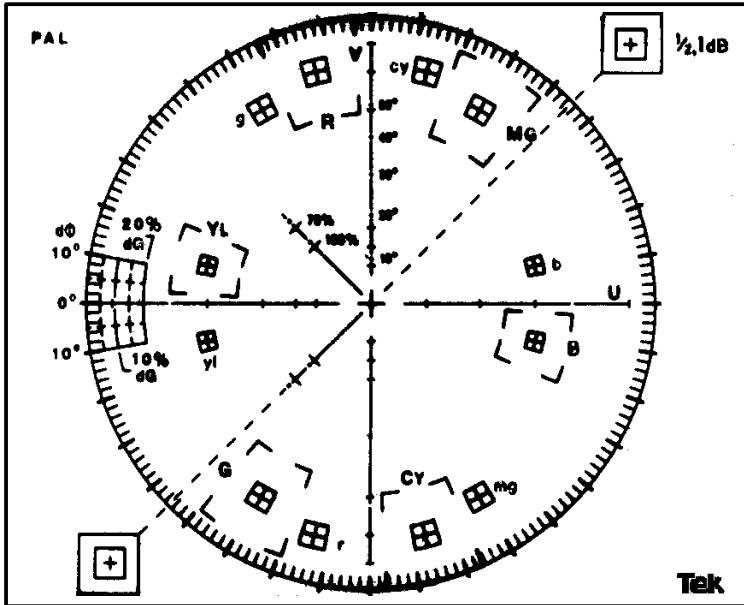

Figure 3-4: 1781R Vector Graticule

On the NTSC graticule, the small marks at intervals along the I and Q axes denote the amplitudes of the chrominance components. On the PAL graticule, the small marks at intervals along the U and V axes denote the amplitudes of the U and V chrominance components.

The horizontal and vertical axes of the vector graticule contain markings for checking Vector mode bandwidth. A subcarrier frequency sine wave whose amplitude places it on the outer compass rose is used as a reference. When the frequency is changed, the diameter of the circle should reduce. At a point equal to 70% of full

amplitude (3 dB), there are gaps in the horizontal and vertical axes. This calibration aid makes it possible to check the -3 dB points of the demodulator output amplifiers.

Differential Gain and Phase Measurements. The 1780R-Series provides differential gain and phase measurements through the Measurement menu, accessed by pushing the front-panel MEASURE button. Instructions are given in Section 4.

The 1780R-Series vector graticule is the same as the 1720-Series vector graticule, and provides differential gain and phase markings, so that approximate 1780R-Series measurements can also be made in the same way as with the 1720. Differential gain (dG) and differential phase (d Φ) measurements can be made using the graticule markings located at the outer edge of the B–Y axis (NTSC) or U axis (PAL).

Differential gain appears as an elongation of the chrominance dot. Measure the horizontal distance from end to end. Minor graticule divisions represent 5% error, and major divisions represent 10%. Differential Phase appears as a vectorial offset of the chrominance dot. Measure angular difference, using the Differential Phase graticule markings along the edge of the compass rose. Measuring from the 0° mark on the B–Y or U axis, each minor division represents 2° of error, the major divisions represent 10° , and the dashed lines half-way in between represent 5° of Differential Phase error.

XY Measurements. The 1780R-Series vectorscope graticule contains markings for measuring stereo audio phase and amplitude. The dashed diagonal line is the measurement axis for errors less than 90° , and is terminated in amplitude targets that correspond to the length of the X and Y axes. These target boxes, in the upper right and lower left of the display, correspond to amplitude errors of 1/2 and 1 dB.

The upper half of the Y axis has markings in 10° increments for measuring the separation of the Lissajous. Both X and Y axes have -3 dB markings, making it easy to check the bandpass of the amplifiers. The 3 dB points are minor breaks in the line about 30% of the distance from the graticule circle to the graticule center.

XY INPUT Connector. The rear-panel XY INPUT connector is a 15-pin, sub-miniature, D-type connector that provides input to the Horizontal and Vertical (X and Y) Amplifiers. They are balanced (differential), DC-coupled, high impedance ($>20\text{ k}\Omega$), un-terminated inputs provided for audio applications. If AC coupling is desired, external capacitors are required. These inputs are factory calibrated for 0 dBm in $600\ \Omega$ but can be adjusted for any $600\ \Omega$ system between 0 and 12 dBm. See Figure 3–5.

0 dBm is equal to 1 mW or 2.19 V peak-to-peak in $600\ \Omega$. 12 dBm is equal to 15.8 mW or 8.72 V peak-to-peak in $600\ \Omega$.

To calibrate the 1780R-Series for a system other than 0 dBm, perform step 38 of the Adjustment Procedure in the 1780R-Series Service Manual, using a 1 kHz sine wave of the appropriate amplitude.

Inputs can be driven single-ended by driving either the + or – X and Y inputs with the opposite polarity inputs grounded.

In addition, a single-ended, high-gain mode can be used for other, primarily non-audio, applications. It can be accessed by installing plug jumpers on J108 and J205 (on the Vectorscope board, see Table 3–1) and inputting the signal on the +X and +Y inputs with the –X and –Y inputs grounded.

Table 3–1: Plug Jumpers for Vectorscope Board

Jumper Number	Name	Plug Position	Purpose
J108	X Input Gain	Removed †	X gain is normal
		Installed	X gain is in High Gain position
J205	Y Input Gain	Removed †	Y gain is normal
		Installed	Y gain is in High Gain position

† Factory installed position.

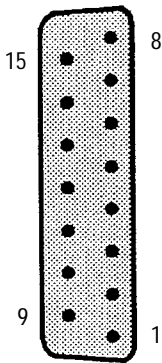

Pin Number	Function
1	-X Input
2	No Connection
3	+X Input
4	No Connection
5	-Y Input
6	No Connection
7	+Y Input
8	No Connection
9	-X Input
10	Ground
11	+X High Gain Input
12	Ground
13	-Y Input
14	No Connection
15	+Y High Gain Input

Figure 3-5: Rear-panel X-Y Connector Pin Assignments

Using The Waveform Graticule

Basic Waveform Graticule Markings. The two basic 1780R-Series internal waveform graticules are the NTSC and PAL graticules. The NTSC graticule is shown in Figure 3-6, and the PAL graticule is shown in Figure 3-7. External graticules (short time distortion for NTSC and CCIR / K-factor for PAL) are also available in full scale and in a 3% reduced photo version.

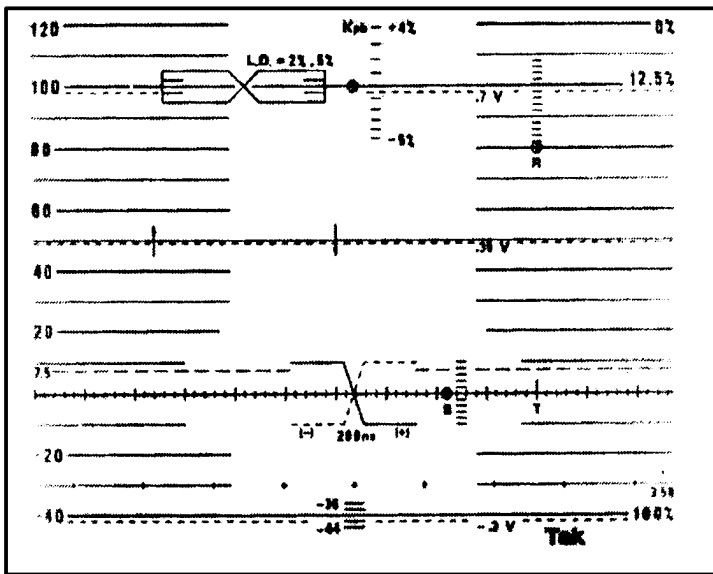

Figure 3-6: 1780R Waveform Graticule

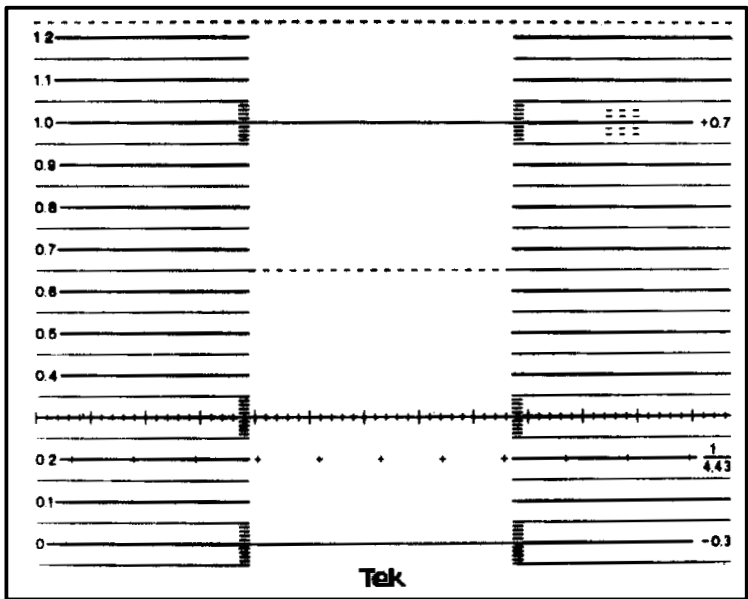

Figure 3-7: 1781R Waveform Graticule

Graticule horizontal scales are divided into 12.7 divisions along the horizontal line at blanking level. The vertical graduations are scaled according to measuring units and ranges unique to each system – mV for the CCIR graticule, and IRE units and percent modulation for NTSC. A mV scale has been added to the NTSC graticule to facilitate component measurements. The graticules are also marked for K-factor tolerances and linear-distortion measurements.

Line-time distortion-NTSC. Line-time distortion is measured using the graticule box labeled L.D. = 2%, 5%. Any test signal that contains an 18 μ s, 100 IRE bar can be used. To make a measurement, select a one-line sweep and use the two arrows on the 50 IRE line to position the bar horizontally. Make sure that the blanking level of the waveform is on the baseline, and that the bar top passes through 100 IRE at its midpoint. (It may be necessary to use the variable gain control to normalize the gain.) The box excludes the first and last μ s

of the bar. Use the $\pm 2\%$ and $\pm 5\%$ graticule marks to quantify the peak-to-peak deviation of the bar top (tilt or rounding) within the structure. The vertical gain can be increased to measure small errors. (When the X5 setting is selected, the graticule marks correspond to $\pm 0.4\%$ and $\pm 1\%$.)

Line-time distortion measurements can also be made using the voltage cursors in the RELATIVE mode. Define the amplitude difference between blanking level and the bar center as 100%. Now move both of the cursors to measure the peak-to-peak tilt. This number is the line-time distortion. Remember to ignore the first and last μs of the bar. The time cursors can be used to locate the appropriate time interval in the center of the bar. Set the time separation to 16 μs , and put the time cursors in the TRACK mode. Move the two cursors together until they are centered on the bar.

Line-time distortion-PAL. Line-time distortion in PAL systems is measured with a signal that contains a 10 ms or 25 ms white bar. The measurement methods given here quote the maximum departure of the bar top from the level at the center of the line bar as the amount of distortion, but they can be adapted for peak-to-peak measurements. To make a measurement, measure the maximum deviation from the center of the bar, and express that number as a percentage of the level at bar center. The variable gain can be used to normalize the center of the bar to 500 or 1000 mV. Deviations in the top of the bar can then be read directly off the graticule in percent. Ignore the first and last ms of the bar.

Line-time distortion measurements can also be made using the voltage cursors in the RELATIVE mode. Define the amplitude difference between blanking level and the bar center as 100%. Leave one cursor at the bar center, and move the other cursor to measure the peak positive and peak negative deviations in the top of the bar. The largest of these numbers (ignore the sign) is the amount of line-time distortion. The time cursors can be used to locate the appropriate time interval in the center of the bar. Set the time separation to the bar time (usually 10 ms or 25 ms) minus 2 ms. Put the time cursors in the TRACK mode, and move the two cursors together until they are centered on the bar.

Remote Operation

REMOTE Connector

The rear-panel REMOTE connector is a subminiature 15-pin D-type receptacle with female contacts. All the active Remote control lines are enabled by remote ground closures or TTL levels (0 V to +0.8 V). Pin assignments for the REMOTE connector are shown in Figure 3–8 and Table 3–2. The REMOTE connector appears in the 1780R-Series Service Manual, Section 11, UART and A/D Schematic Diagram.

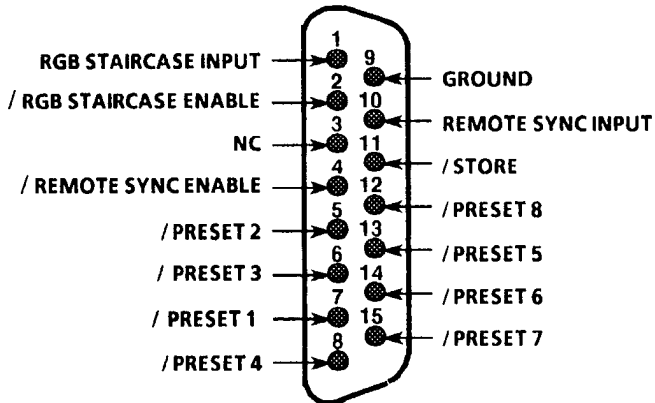

NC = No Connection.

Figure 3–8: REMOTE Connector Pin Assignments

Remote Operation

1. Connect the mating male plug supplied with the instrument to a remote-box cable.
2. Remote lines named Presets 1 through 8 correspond to the front-panel Preset menu Presets 1 through 8. These remote lines allow configurations already stored at Presets 1 through 8 to be recalled, and new configurations to be stored at those preset locations.

- a. To recall a preset, force the corresponding remote line low.
- b. To store a front-panel configuration at a preset location, apply a low first to the Store line (pin 11) and then to the desired preset. Alternately, the Store line and desired preset line may be forced low simultaneously.

Table 3–2: Remote Pin Functions

Pin	Name	Function
1	RGB Staircase Input	1 M Ω input impedance to ground. Requires 10 V staircase signal.
2	/ RGB Enable	Low = RGB Enable. Routes the signal on pin 1 to the Horizontal amplifier, where it is added to the ramps from the Ramp Generator. In RGB mode, the Ramp Generator reduces the ramp to 1/3 or 1/4 size (selected by A2J585).
3	NC	
4	/ Remote Sync Enable	Low = Remote Sync Enable. INT / EXT Reference turned off, and instrument sync provided by the signal on pin 10.
5	/ Preset 2	Low with Pin 11 High = Recall Preset 2. Low with Pin 11 Low = Store current F/P settings at Preset 2 location.
6	/ Preset 3	Low with Pin 11 High = Recall Preset 3. Low with Pin 11 Low = Store current F/P settings at Preset 3 location.
7	/ Preset 1	Low with Pin 11 High = Recall Preset 1. Low with Pin 11 Low = Store current F/P settings at Preset 1 location.
8	/ Preset 4	Low with Pin 11 High = Recall Preset 4. Low with Pin 11 Low = Store current F/P settings at Preset 4 location.

Table 3–2: Remote Pin Functions (Cont.)

Pin	Name	Function
9	Ground	
10	Remote Sync Input	5 k Ω input impedance to ground. Polarity set by jumper A2J192. Factory set for positive polarity.
11	/ Store	Low = Store. Used with pin 5, 6, 7, 8, 12, 13, 14, or 15.
12	/ Preset 8	Low with Pin 11 High = Recall Preset 8. Low with Pin 11 Low = Store current F/P settings at Preset 8 location.
13	/ Preset 5	Low with Pin 11 High = Recall Preset 5. Low with Pin 11 Low = Store current F/P settings at Preset 5 location.
14	/ Preset 6	Low with Pin 11 High = Recall Preset 6. Low with Pin 11 Low = Store current F/P settings at Preset 6 location.
15	/ Preset 7	Low with Pin 11 High = Recall Preset 7. Low with Pin 11 Low = Store current F/P settings at Preset 7 location.

3. All front-panel controls operate in their usual manner during remote operation, so remote selections may be changed with the front-panel controls.
 - a. For a remote selection to be effective once it has been deselected with the front-panel control, it is either selected again with the front-panel control, or the ground closure is removed and reattached.
 - b. Front-panel LED indicators light to show the current selection.

Serial Communications Interface

Serial Interface Connector

The rear-panel SERIAL interface connector is a 9-pin, sub-miniature, D-type connector. It is used as an RS422A or RS232D interface to the 1780R-Series microcontroller. Drivers for both interfaces are resident. RS422A is a balanced voltage digital interface, and RS232D is a serial binary data interchange. Figure 3-9 shows the rear-panel SERIAL connector pin assignments.

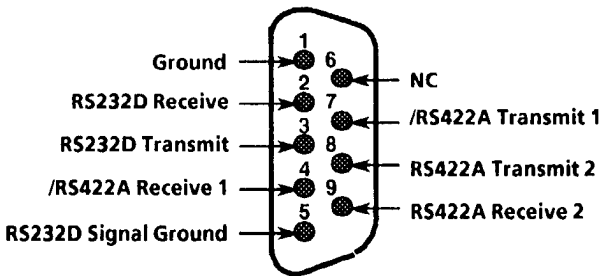

Figure 3-9: Serial Interface Connector Pin Assignments

Building a Wiring Converter

Wiring converters can be built to connect the 1780R-Series 9-pin SERIAL port with another 9-pin connector or with a 25-pin connector. The 25-pin converter uses a 9-pin male connector (Tektronix P/N 131-1007-00) and a 25-pin female connector (Tektronix P/N 131-0971-00), as illustrated in Figure 3-10.

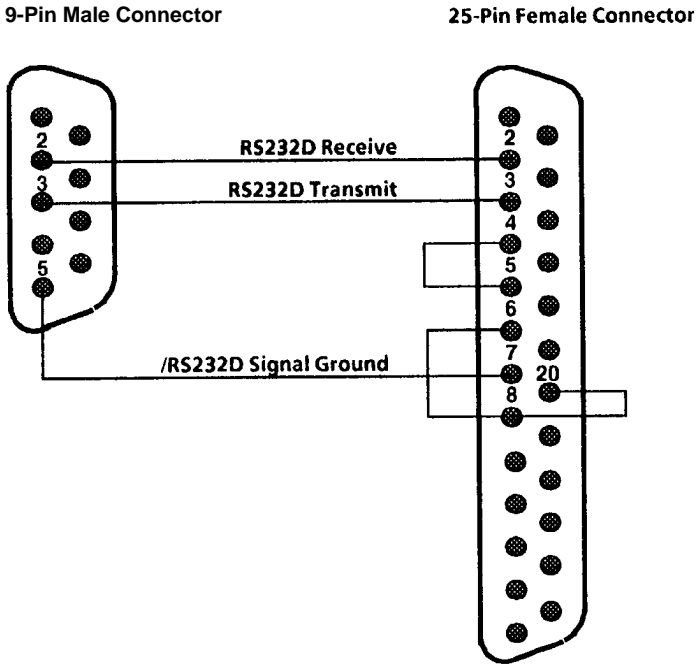

Figure 3-10: Serial Interface Connector Wiring Converter

Serial Remote Information

1780R-Series instrument configurations can be stored at (and retrieved from) a remote location. To accomplish this, the 1780R-Series is connected to a host computer through a serial port that supports RS-232 or RS-422 standards.

All front-panel controls operate in their usual manner during remote operation, so remote selections may be changed with the front-panel controls. Front-panel LED indicators light to show the current selection.

Commands to the 1780R-Series and its responses are listed in Tables 3-3 and 3-4.

Table 3–3: Serial Remote Commands to the 1780R-Series

Command*	Function	Results
#U or #u	UPLOAD	1780R-Series sends a stream of data, representing the current instrument configuration, to the host computer.
#D or #d	DOWNLOAD	1780R-Series expects a stream of data representing an instrument configuration of the same form that was uploaded.
#P or #p	PARTIAL DOWNLOAD	1780R-Series expects a stream of data representing an instrument configuration, with the knob settings (focus, intensity, etc.) not affected.

* **The # character indicates a remote control command. The 1780R-Series ignores all transmissions until this character is received.**

Table 3–4: 1780R-Series Responses

Command	Description
A	The transmission was successful (ACK)
C	Command not known. (The # character was received, but was not followed by a U, u, D, d, P, p, or .)
D	Bad data received (all expected data consists of ASCII printable characters.)
H	Bad internal checksum.
N	Bad transmission checksum (NACK)
T	Timed out (the process took too long to complete).
V	Software version number mismatch.

Serial data format: 8 data bits, 1 stop bit, no parity.

Baud rates supported are: 300, 1200, 9600, 19200. The baud rate selection is made through page 3 of the Configure menu, with further instructions later in this section.

The data stream transmitted to and from the host (representing the current 1780R-Series settings) consists of 512 bytes, followed by a one-byte checksum. All data bytes are in the range of Hex 20 to Hex 7F, so that they are printable ASCII characters.

SCH Display

NOTE. Switch function is further described in Section 2.

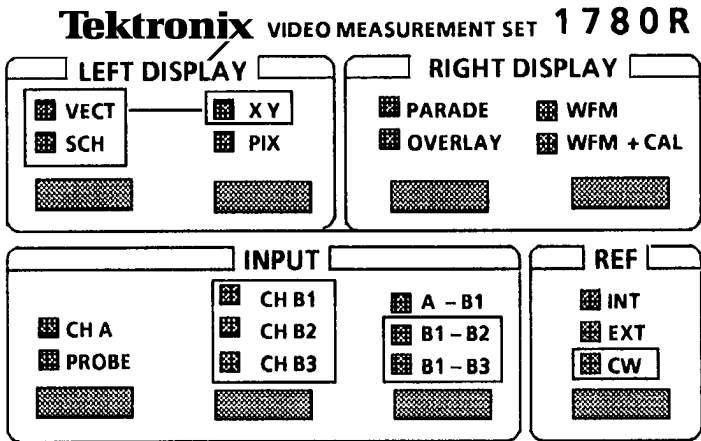

Figure 3-11: Portion of the 1780R-Series Front Panel

With the 1780R-Series, there are two methods of viewing SCH Phase errors; the method outlined here, utilizing the front-panel SCH button, and F_{SC} Time Marks through the Measurement Menu.

INT REF setting: two dots appear on the vectorscope compass rose. The dots represent the 50% points of H Sync.

EXT REF setting: only one dot appears on the vectorscope compass rose. This relative mode allows the comparison of the color framing of two signals. The two signals are color framed when the sync dot is within 90° of the burst vector.

SCH Phase Measurement Procedure

- 1.** Select the SCH mode of operation by pushing the SCH / VECT button, shown in Figure 3–11, until the SCH LED lights. Two pushes may be required, depending on the previous condition.
- 2.** Push the front-panel PHASE button.
- 3.** Apply a signal to a 1780R-Series input channel and select that channel for display.
- 4.** Use the large knob to align the burst vector with the 180° graticule line (normal position). Push the REF SET button to obtain a 0.00° readout (vectorscope CRT).
- 5.** Use the large knob to move the dot (or closest of the two dots in INT REF mode) to the 180° graticule line. Readout now shows SCH Phase error.
- 6.** Push the SCH and PHASE buttons again to exit the mode.

Parade Operation

NOTE. Switch function is further described in Section 2.

Select the Parade mode of operation by pushing the PARADE/OVERLAY button, shown in Figure 3-11, until the Parade LED lights. Two pushes may be required, depending on the previous condition.

If One Line or Field is currently selected, instrument operation will be forced to Two Line or Field.

Two Line or Field Parade

Parade mode simultaneously displays two signals side by side on the CRT.

Pushing the CH A/PROBE switch will select from the following input channel combinations for side-by-side display:

- CH A and CH B1
- CH A and PROBE
- CH B1 and PROBE

Pushing the CH A-CH B1 / CH B1-CH B2 / CH B1-CH B3 switch selects CH B1-CH B2 and CH B1-CH B3.

Pushing the CH B1 / CH B2 / CH B3 switch forces the instrument to Three Line.

Three Line Display

The CH B1 / CH B2 / CH B3 switch provides a side-by-side display of these three inputs.

Pushing a two-channel input switch forces the instrument to Two Line.

Offset Menu

When only B input channels are displayed in Parade or Overlay, an offset readout appears on the waveform CRT, as shown in Figure 3-12.

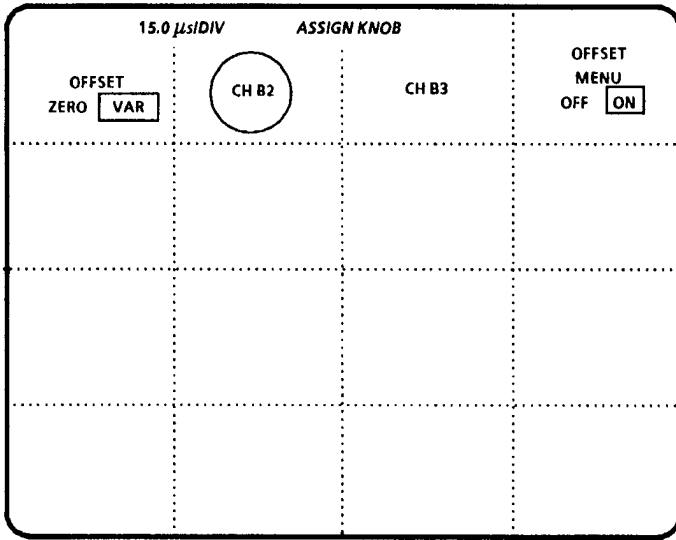

Figure 3-12: Offsets Menu Screen

To obtain Offset menu, touch <OFFSET MENU> until <ON> is outlined.

Touch <OFFSET> until <VAR> is outlined, and touch CHB2 or CHB3 to assign large knob function to desired offset. Large knob assignment will be circled.

Using the large knob, adjust offset of the selected display with respect to the other display or displays.

DC Level Measurements

The 1780R-Series has the capability of indicating the DC levels of the B1, B2, and B3 channels with a high degree of accuracy. This is useful when adjusting the DC levels of RGB signals coming from a CCU, for example. The following procedure details the DC measurement technique for Parade mode.

DC Level Measurement Procedure

1. Enter the Parade mode. Press the CONFIGURE button and then use the vectorscope touch screen to select <GND> under the <COUPLING> area. Press the CH B1 / CH B2 / CH B3 switch to go to Three Line.
2. Ensure that the button under the WFM CRT is selected. Adjust the VERT POS control to set the CH B1 (far left) trace to a convenient reference line on the graticule. Setting the WAVEFORM GAIN to X5 provides increased resolution. Touch <OFFSET> until <ON> is outlined.
3. Touch <OFFSET> until <VAR> is outlined, and touch <CH B2> to assign large knob function to that channel.
4. Use the large knob to align CH B2 with CH B1.
5. Touch <CH B3> and use the large knob to align CH B3 with CH B1.
6. Turn off the OFFSET MENU and change the <COUPLING> from <GND> to <DC>. Press the CONFIGURE button to return to the normal operating mode.
7. The DC levels of all three signals can now be read directly from the graticule. (For NTSC graticules, one IRE = 7.142857 mV.)

Overlay Operation

NOTE. *Switch function is further described in Section 2.*

Select the Overlay mode of operation by pushing the PARADE/OVERLAY button, shown in Figure 3–11, until the Overlay LED lights. Two pushes may be required, depending on the previous condition.

The instrument is forced to One Line operation. Two and Three Line modes are locked out; a beep sounds if the switch is pushed. The LINE/FIELD switch is still operational.

Overlaid Displays

The CH A/PROBE switch will select from the following input channel combinations for overlaid display:

- CH A and CH B1
- CH A and PROBE
- CH B1 and PROBE

Subtract modes (A–B1 / B1–B2 / B1–B3 switch) are unavailable in Overlay mode.

The CH B1 / CH B2 / CH B3 switch provides an overlaid display of any two, or all three of these inputs.

Offset Menu

When only B input channels are displayed, an offset readout appears in the upper right corner of the waveform CRT.

To obtain the Offset menu, touch <OFFSET MENU> until <ON> is outlined.

Touch <OFFSET> until <VAR> is outlined, and touch <CH B2> or <CH B3> to assign large knob function to desired offset. (If only two input channels are selected, the menu will only provide one offset.)

Using the large knob, adjust offset of the selected display with respect to the other two displays.

WFM + CAL

NOTE. Switch function is further described in Section 2.

Enter WFM+CAL Mode

Select the WFM+CAL mode of operation by pushing the WFM / WFM+CAL button, shown in Figure 3–11, until the WFM+CAL LED lights. Two pushes may be required, depending on the previous condition.

The WFM+CAL display appears on the right CRT. Sample readouts are shown in Figures 3–13 and 3–14.

General WFM+CAL Information

The WFM+CAL mode provides an accurate measurement tool, which can be used to measure such things as burst amplitude, sync tip to white bar amplitude, and color bar amplitude.

The WFM+CAL signal consists of a video signal superimposed on a calibrator signal. The video signal is displayed twice, with one display offset from the other by the voltage level of the calibrator.

When operating in the <VAR> mode, the large knob will vary the Calibrator amplitude, allowing accurate amplitude measurement over a continuous range; when operating in <FIX>, it will not. Fixed Calibrator amplitude is selected on page 1 of the Configure menu.

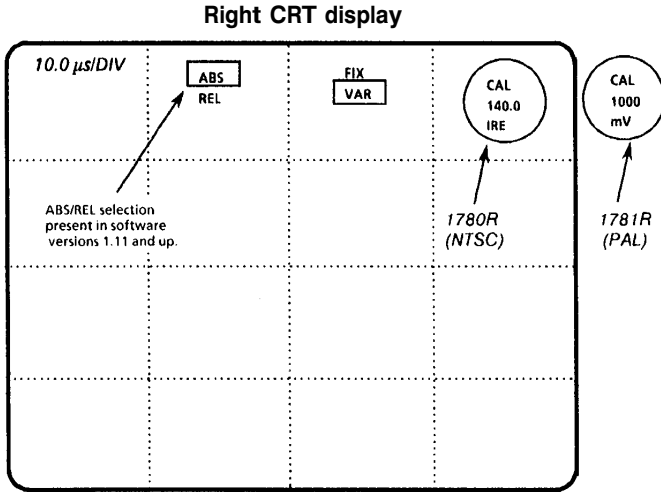

Figure 3-13: WFM + CAL Readout with ABS selected

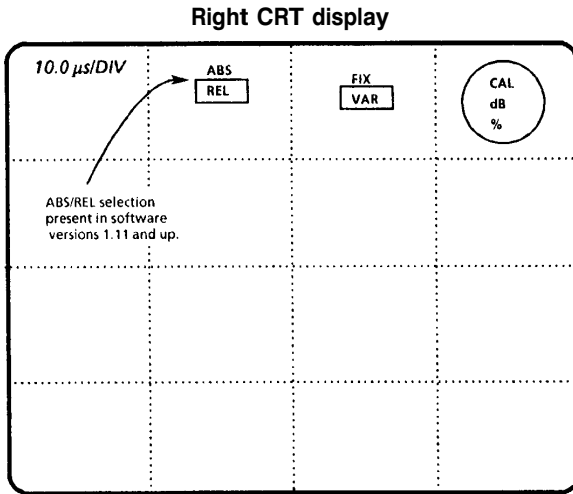

Figure 3-14: WFM + CAL Readout with REL selected

When operating in the <VAR> mode, software versions 1.11 & Up provide a choice of absolute or relative readouts. When <ABS> is selected, the readout appears in IRE or mV. (For an IRE readout, <IRE> must be selected on page 2 of the Configure menu.) When <REL> is selected, the readout is given in both dB and percentage (%) values, relative to a reference that is selected by pushing the REF SET button. (Software versions below 1.11 provide a relative readout only.)

Making Measurements Using VAR and ABS. This mode provides accurate amplitude measurements in IRE or mV values. An example of the readout is shown in Figure 3–13 (calibrator signal not shown).

1. Enter the WFM+CAL mode. Use the touch screen to select <VAR> and <ABS>. Select Two Line sweep and Flat filter. Apply a color bar signal to the 1780R-Series.
2. To measure the signal amplitude (sync tip to white bar), locate the sync tip on the topmost of the two displays. Use the large knob to vertically align the bottom of that sync tip with the white bar of the bottom display. The CAL readout now displays sync tip to white bar amplitude. X5 Gain can be used if desired.
3. To measure burst amplitude, locate the burst on the top display. Use the large knob to vertically align the bottom of that burst with the top of the lower display's burst packet. The CAL readout now displays burst amplitude.
4. Any feature of the waveform can be measured in the same manner; use the large knob to align the bottom of the desired feature with the top of the second appearance of that same feature. This provides a readout of the voltage offset between the two displays.

Making Measurements Using VAR and REL. This mode provides relative measurements in dB and percent. An example of the readout is shown in Figure 3–14 (calibrator signal not shown).

1. Enter the WFM+CAL mode. Use the touch screen to select <VAR> and <REL>. Select Two Line sweep and Flat filter. Apply a color bar signal to the 1780R-Series.

2. Use the large knob to align a horizontal reference point (usually the sync tip) of one display with the white bar of the second display.
3. Push the REF SET button and obtain a CAL readout of 0.00 dB and 100.0%.
4. Relative burst amplitude is measured in the same manner as absolute (see step 3 of the preceding procedure). The CAL readout will display the burst amplitude in dB and % of the total signal amplitude.
5. The relative amplitude of any portion of the signal can be measured in the same manner: use the large knob to align the bottom of the desired feature with the top of the second appearance of that same feature. The relative readouts are provided in dB and percent (%) of total signal amplitude.

Using FIX. The 1780R-Series large knob has no effect in the <FIX> mode.

This mode is used to compare the amplitude of the incoming video signal to several internally calibrated amplitudes.

1. Enter the WFM+CAL mode. Use the touch screen to select <FIX>. Select 2 Line and Flat filter. Apply a color bar signal to the 1780R-Series.
2. For NTSC, if an IRE readout is desired, be sure that <IRE> is selected on page 1 of the Configure menu.
3. Select the calibrator signal amplitude on page 1 of the Calibrate menu.
4. Adjust the amplitude of the incoming video signal until the CAL readout reflects the exact amplitude selected in step 3.
 - a. When using the calibrator setting of 1000 mV (140.0 IRE), the CAL readout should equal that value when the sync tip of one display is aligned with the white bar of the second display.
 - b. When using the calibrator setting of 714 mV (100.0 IRE) for NTSC, or 700 mV for PAL, the CAL readout should

- equal that value when the back porch of one display is aligned with the white bar of the second display.
- c. The 700 mV (98.0 IRE) calibrator amplitude (NTSC and PAL) can be used to adjust component levels for component video.
 - d. The 300 mV (PAL) calibrator amplitude is used for adjusting sync amplitudes.

Menu Information

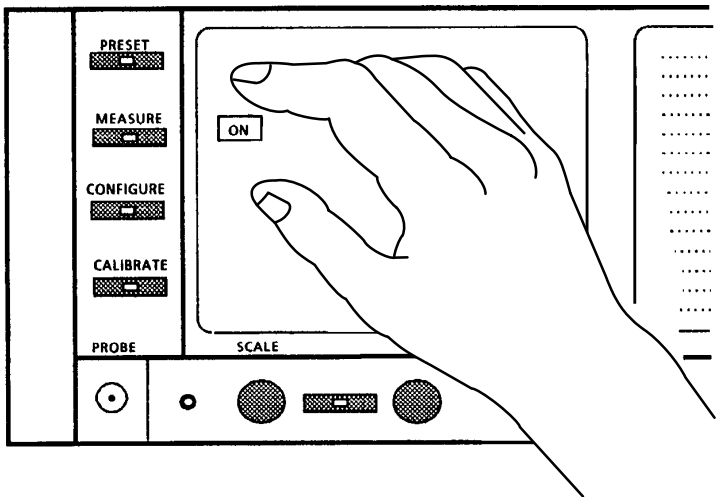

Figure 3-15: Left Side of Front Panel, showing Menu Buttons and Touch Screen

Menu Documentation Overview

This section describes the Password, Preset, Calibrate, Configure, and Measure menus.

Many selections are made by touching the desired word on the CRT screen, as shown in Figure 3–15. This is indicated by the use of the word ‘touch’ (as opposed to ‘push’ for front-panel switches).

The touch screen menu quadrants are illustrated as a documentation tool, and do not actually appear on the CRT screen. If adjustment of quadrants is necessary, refer to the *1780R-Series Service Manual*.

Menu Access

The Preset, Measure, Configure, and Calibrate menus are enabled by four front-panel menu buttons, shown in Figure 3–15.

Access to the Preset and Calibrate menus can be restricted by password.

Password operation is enabled / disabled by a setting of S385 on the MPU board. Instrument is shipped in the not enabled position. Refer to the *1780R-Series Service Manual* for the location of S385.

The Preset, Measure, and Configure menus are shown on the left CRT, with the vectorscope display blanked.

The Calibrate menu is available for both vectorscope and waveform, selected by pushing the button under the desired CRT.

The green LED in the button lights when a menu is enabled.

To exit a menu, push the same menu button again. Menus will also be exited when another menu button is pushed, with the exception that both the Preset and the Measure menu can be active at the same time.

Touch Screen

Both CRTs are equipped with touch screens. Four vertical and four horizontal divisions create 16 quadrants, shown in Figure 3–16.

Touching a quadrant enables the function or toggles between choices displayed in that quadrant.

Current selections / functions are outlined by a box. Current large knob assignment is circled.

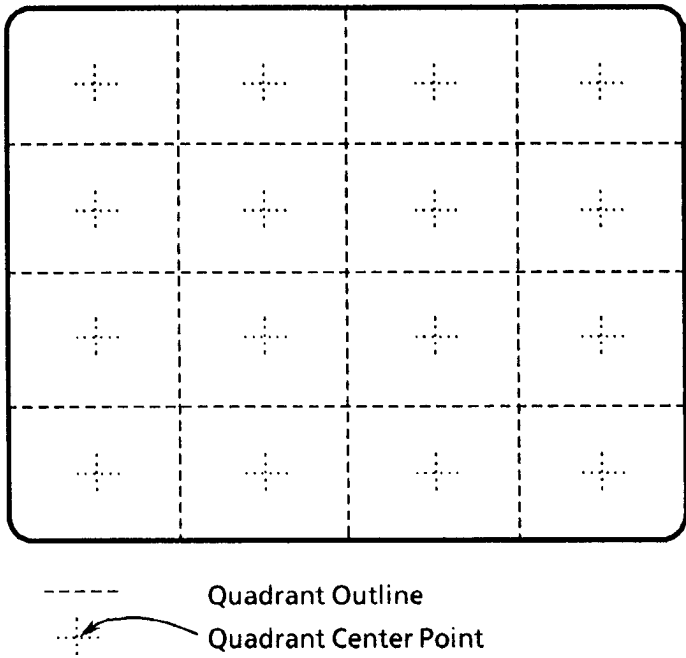

Figure 3-16: Touch Screen 4 X 4 Matrix

The touch screens are light sensitive, so it is not necessary to apply pressure.

If it is necessary to adjust quadrant center points, refer to the *1780R-Series Service Manual*.

Password Menu

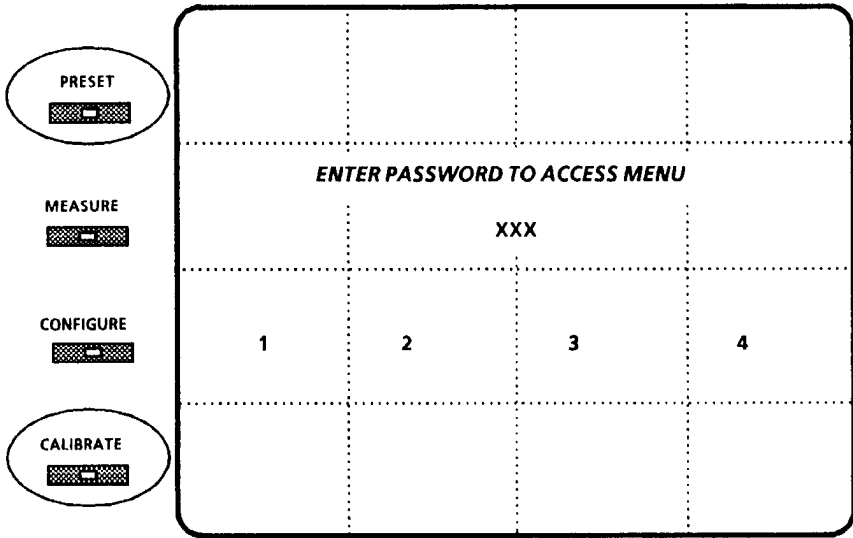

Figure 3-17: Password Menu Screen

Enable / Disable the Password

To enable password operation, place button #2 of S385 (MPU board) in the closed position. Turn the instrument power to standby and back to on for the microprocessor to recognize the new switch setting. Disable in the same manner, placing button #2 in the open position.

Define the Password

The first time a restricted access menu is selected after the jumper has been moved, the words <DEFINE PASSWORD> are displayed on screen.

Select the three-digit password, by touching the desired sequence of numbers on the CRT screen (choose from the displayed numbers 1,

2, 3, and 4). That password is then stored, and remains in memory, even when the instrument power is turned to standby and back to on.

Change the Password

Move button #2 of S385 (MPU board) to the open position to disable password operation.

Apply power to the instrument.

Follow preceding instructions to Enable the Password and Define the Password.

Use the Password

Once password is enabled, it restricts access to the Preset and Calibrate menus, and the Password menu, shown in Figure 3–17, is displayed.

To access Name, Store, or Calibrate menu functions, touch the numbers on the screen in proper sequence to form the password.

Once Name, Store, or Calibrate are selected, entering the correct password will provide access to the desired menu.

Incorrect Password

Entering an incorrect password produces a momentary display informing the user of denied access and exits the Name, Store, or Calibrate menu screen. These menu screens can also be exited by pushing the PRESET or CALIBRATE button again, or by disabling the Password according to the preceding instructions.

NOTE. *If the operator has reduced the Readout Intensity via the Calibrate menu, then attempts to exit and re-enter that menu, the Password menu may not be visible, and instrument functions may appear to be locked up. Temporarily returning the instrument to non-password operation will allow re-entry of the Calibrate menu.*

Preset Menu

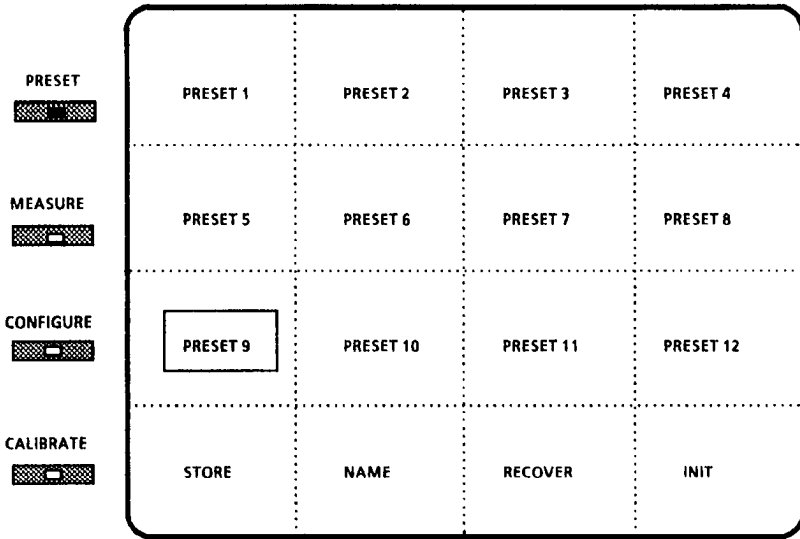

Figure 3–18: Preset Menu Screen

Recall

Recall Preset Settings. Push PRESET button to enter Preset menu, shown in Figure 3–18.

Recall desired preset by touching the preset name.

Example: <PRESET 9>.

Instrument is reset to configuration stored under that preset, menu screen disappears, and selected preset name is displayed in the upper right of the vectorscope CRT.

While the Preset LED is still on, pushing it will cancel the recall. The LED is turned off by any front-panel activity.

If a Measure menu selection (for example, user-modified R–Y SWEEP setup) has been stored at a Preset location, recalling it will cause the instrument to reenter the stored measurement mode (R–Y SWEEP in this example), turning on both Preset and Measure LEDs.

Exit Preset Menu. Use one of these two methods to exit the Preset menu:

1. Exit by pushing the front-panel PRESET menu button, and the instrument returns to its previous settings.
2. Exit by changing any right-side front-panel control, and the instrument continues to operate at the selected preset settings (allowing modifications by the operator). When the preset has been exited in this manner, the word <RECOVER> will be displayed at the bottom of the menu screen the next time the Preset menu is selected, as shown in Figure 3–18. Touch <RECOVER> to return to previous instrument settings.

Presets 1 through 8 can also be accessed by ground closures through the rear-panel REMOTE connector.

Recall Initial Settings. Push PRESET button to enter Preset menu.

Touch <INIT>. Instrument will be reset to the settings shown in Table 3–5.

Table 3–5: Initial Settings

Control	Setting	Control	Setting
LEFT DISPLAY	Vector	REFERENCE	Int
RIGHT DISPLAY	Wfm	CW SYNC	Ext
FOCUS, SCALE, INTENS	Mid range	FILTER	FLAT
VECT / WFM H & V POS	Approximate Center screen	WFM SWEEPS	2H, MAG Off
INPUT	CH A	BARS	75%
GAINS	Calibrated	DC REST	Slow
READOUTS	On	SYNC	DIR
GRATICULE	Int	CAL AMPL	FIX

Table 3-5: Initial Settings (Cont.)

Control	Setting	Control	Setting
COUPLING	AC	BEEP	On
FIELD TRIG	F1	BAUD RATE	9600
SLOW SWEEP TRIG	+	PROBE GAIN	X1
FRONT INPUT	HI Z	CLAMP	BP
VECTOR	PAL (1781R only)	ABS UNITS	IRE (1780R) mV (1781R)

The Preset menu LED will stay on until the menu is exited. <INIT> is displayed in the upper right portion of the CRT.

Exit Initial Settings. Use one of these two methods to exit the Preset menu:

1. Exit by pushing the front-panel PRESET menu button, and the instrument returns to its previous settings.
2. Exit by changing any right-side front-panel control, and the instrument continues to operate at the Initial settings (allowing modifications by the operator).

Recover

<RECOVER> only appears on the CRT after:

1. Preset menu is entered.
2. Initial or Preset setting is recalled.
3. Preset menu is exited by modifying the recalled Initial or Preset setting.
4. Preset menu is re-entered by pushing front-panel PRESET menu button.

Push PRESET button to enter Preset menu.

Touch <INIT> or any of the 12 presets.

As soon as any right-side front-panel control setting is changed, the instrument settings (as configured before that change) are saved, and the Preset menu is exited.

To recover saved configuration, push the PRESET button again, and then touch <RECOVER>.

If the Preset menu is exited by pushing the PRESET button, instrument configuration will not be saved.

Store

Presets can be used to store instrument front-panel configurations and user-modified measurement setups.

Store a new setup:

- Configure items to be stored.
- Push PRESET button to enter Preset menu.
- Touch <STORE>. If password is enabled, enter the password now.
- <WHICH PRESET?> is added to the display. <STORE>, <RECOVER>, <NAME>, and <INIT> are omitted.
- Touch desired preset name.

Example: <PRESET 9> (will now be outlined on touch screen).



CAUTION. When <PRESS HERE TO STORE> is touched, the previous configuration stored under that preset (Preset 9 in this example) will be written over. If this is not desired, push the PRESET menu button now to exit the menu without making changes.

- To store the new setup and return to the Preset menu, touch <PRESS HERE TO STORE>.
- To exit the Preset menu without storing the new setup, push the PRESET menu button.

Name

Renaming a PRESET:

- Push the PRESET button to enter Preset menu.
- Touch <Name>. If password is enabled, enter the password now.
- <RENAME WHICH?> is added to the display. <STORE>, <RECOVER>, <NAME>, and <INIT> are omitted.
- Touch the preset to be renamed.

Example: <PRESET 1>.

- The Name menu screen, shown in Figure 3–19, is displayed.
- Push the buttons marked < > (under large knob) to select the digit to be changed. The selected character is now outlined on the screen.
- Rotate the large knob until the desired character is displayed. The selections include: A through Z, 0 through 9, several punctuation marks, international characters, and a space.
- Use the < > buttons to move to the next character to be changed.
- Select up to 8 digits in this manner.
- To return to the Preset menu without renaming the preset, touch <CANCEL>. To exit the menu without renaming the preset, push the front-panel PRESET button. To store the new preset name and return to the Preset menu, touch <ACCEPT>.
- Up to 12 presets may be named.
- When all desired presets have been renamed, push the front-panel PRESET button to exit the menu.

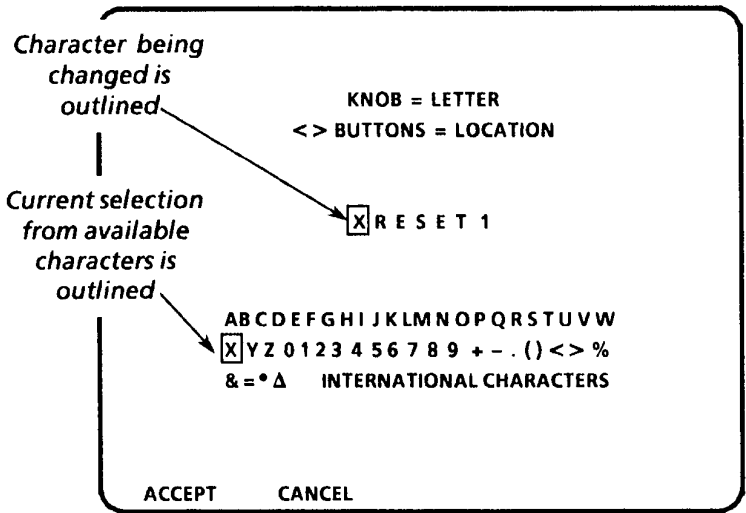

Figure 3-19: Name Menu Screen

Calibrate Menu

General Calibration Menu Information

The Calibrate menu is available for both vector and waveform, and uses both CRTs.

Pushing the front-panel CALIBRATE button provides access to the menu. Several calibration features (such as Readout Intensity) can be selected using the touch screen menu. The settings can then be modified (refer to the following Waveform and Vector calibration procedures, or for more detailed procedures, refer to the *1780R-Series Service Manual*). New settings are stored when the Calibrate menu is exited.

The Calibrate menu can be exited by pushing the CALIBRATE button again, or by pushing another menu button.

To toggle the display between vectorscope and waveform calibration, push the buttons under the CRTs. When waveform is selected, the waveform calibrator is displayed on the right CRT, with waveform menu selections on the left CRT (vectorscope display blanked). When vectorscope is selected, the arrangement is reversed.

Waveform Calibration Information

The internal calibrator signal is selected by touching the <CAL SIGNAL> area of the screen until <ON> is outlined. It automatically reverts to <OFF> when the Calibrate menu is exited and must be reselected (if desired) when the menu is reentered. (CAL signal is not available in <CAL AMPL ZERO SET>.)

HORIZ POSITION KNOB CAL (present in instruments with SN below B020245), VOLT CURSORS ZERO SET, and CAL AMPL ZERO SET provide menu displays on the waveform CRT. The current selection is indicated by a box on the vectorscope CRT, and the large knob function is circled on the waveform CRT.

HORIZ CAL, EXT HORIZ CAL, VERT CAL, READOUT INTENSITY, and TRACE ROTATION are circled when selected, to indicate large knob assignment.

An external 1.0 volt reference signal is required to calibrate the EXTERNAL HORIZONTAL INPUT.

Waveform Calibration Procedure

1. Apply a video signal to a 1780R-Series input channel and select that channel for display.
2. Push the front-panel CONFIGURE button and touch <FIXED CAL AMPL> until 1000 (1.0 volt) is outlined.
3. Push the front-panel CALIBRATE button. If Password operation is enabled, enter the password now. The Waveform Calibration menu will be displayed, as shown in Figure 3–20.
4. <READOUT INTENSITY> will be circled, and a test readout will be displayed. Use the large knob to adjust the readout to the desired intensity. (It is necessary to adjust readout intensity in this manner; the front-panel INTENSITY control is used to adjust signal intensity only.)

Perform Step 5 for SN below B020245 only:

5. Touch <HORIZ POS KNOB CAL> to calibrate the Horizontal Position knob. A menu will be displayed on the waveform CRT. Center the Horizontal Position control by turning the knob and releasing, allowing the spring (not necessarily the signal display) to return to midpoint of its range. Then touch the area labeled <CENTER HORIZONTAL POSITION KNOB, THEN PRESS HERE>. This tells the microprocessor that the knob is now at the midpoint, or zero point, of its range. This zero point is referred to as the Dead Zone, and its tolerance can be varied by touching <INCREASE> or <DECREASE>. The value changes in single step increments from the smallest possible setting of 1 unit up to 16 units, and current value is shown on the readout. A beep sounds when the Dead Zone has been increased or decreased as much as possible. As the Dead Zone is increased, the control must be turned more before it will respond, but will also return to center more readily after it is turned.
6. Touch <TRACE ROTATION> to obtain a test axis, then use the large knob to align the display to the graticule.

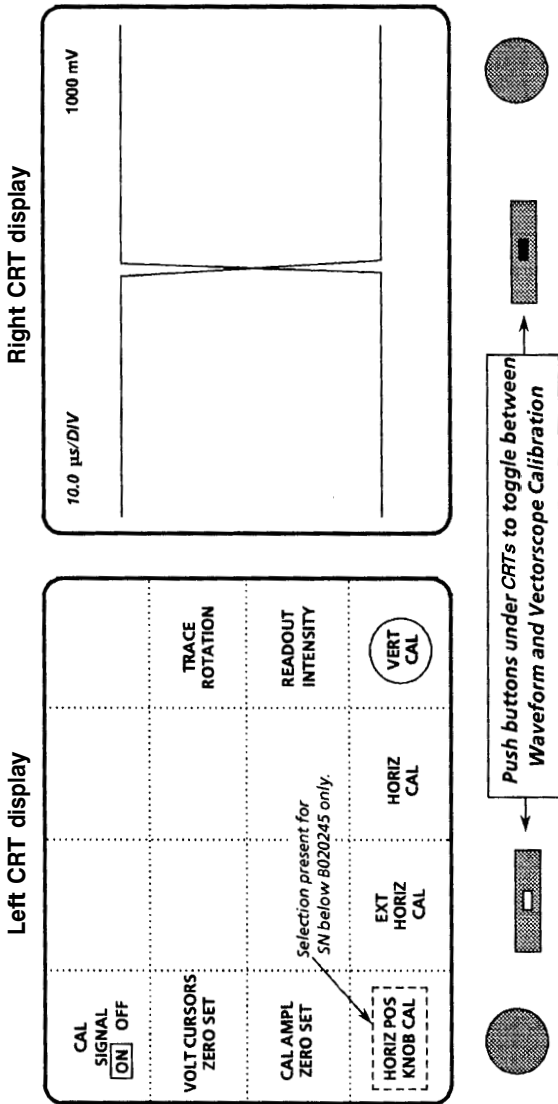

Figure 3-20: Waveform Calibration Menu Display

7. Touch <CAL AMPL ZERO SET> to obtain a menu on the waveform CRT for adjusting the calibrator zero level. Adjust the large knob to overlay the two calibrator waveforms. Press the front-panel REFERENCE SET button to record this zero setting.
8. Touch <VOLT CURSORS ZERO SET> to obtain a Voltage Cursor menu on the waveform CRT. Use the large knob to move cursors, touching the <CURSOR 1 / CURSOR 2> area to toggle between Cursors One and Two. When cursors are aligned, press REFERENCE SET to reset the displayed voltage difference to zero.
9. Touch <CAL SIGNAL ON / OFF> until <ON> is outlined. (CAL signal is not available in <CAL AMP ZERO SET>.)
 - a. Select <VERT CAL>. Use the large knob to adjust the vertical gain for a 1 V calibrator signal display on the waveform CRT.
 - b. Select TWO LINE sweep with VAR sweep off.
 - c. Push the front-panel TIME button to turn on the timing cursors. Reduce the display intensity if necessary to view the timing cursor dots.
 - d. Touch the <CURSOR 1 / CURSOR 2> area of the screen until <CURSOR 1> is outlined. Use the large knob to move Timing Cursor 1 approximately 1 major division in from the left edge of the graticule.
 - e. Select <CURSOR 2> and use the large knob to move it 100 μ sec to the right of Timing Cursor 1, as indicated on the CRT readout.
 - f. Touch <HORIZ CAL>. The large knob will now adjust sweep length (time) with respect to the graticule. Adjust for 10 divisions between cursor dots.
 - g. Push the front-panel TIME button to turn off the timing cursors. Readjust the readout intensity if necessary.
 - h. Apply a 1.0 volt signal to the EXT HORIZ input. Ensure that the signal is properly terminated in 75 Ω .

- i. Touch <EXT HORIZ CAL>. The large knob will now adjust sweep length (time) with respect to the graticule. Do not change the MAG setting (automatically set to 100 mV/div). Adjust the large knob for a horizontal display of 10 divisions.

Vectorscope Calibration Information

READOUT INTENSITY, TRACE ROTATION, and GAIN CAL (GAIN 1 CAL / GAIN 2 CAL for NTSC software versions 1.11 & Up) will be circled when selected, to indicate large knob assignment.

The oscillator signal is selected by touching the <CAL OSC> area of the screen until <ON> is outlined. It automatically reverts to <OFF> when the Calibration menu is exited and must be reselected (if desired) when the menu is reentered.

Vectorscope Calibration Procedure

(for Software Versions 1.11 & Up)

1. Push the front-panel CALIBRATE button to enter the Calibration menu. If Password operation is enabled, enter the password now. Waveform calibration will be displayed.
2. Push the button under the left CRT (LED will light) to select Vectorscope calibration, shown in Figures 3–21, 3–22, and 3–23.
3. <READOUT INTENSITY> will be circled, and a test readout will be displayed. Use the large knob to adjust Readout intensity. (Only Readout intensity is adjusted through the menu; signal intensity is adjusted with the front-panel INTENSITY control.)
4. Touch <TRACE ROTATION> to obtain a test axis, then use the large knob to adjust trace rotation.
5. To adjust Vectorscope Gain, touch <CAL OSC> until <ON> is outlined. While the cal oscillator is on, the V axis switcher is enabled and 75% bars are selected (with 7.5% setup for NTSC).
 - a. For 1780R (NTSC), touch <GAIN 1 CAL> and use the large knob to make the circle match the compass rose. Touch <GAIN 2 CAL> and again use the large knob to make the circle match the compass rose. Touch <GAIN 1 CAL>.

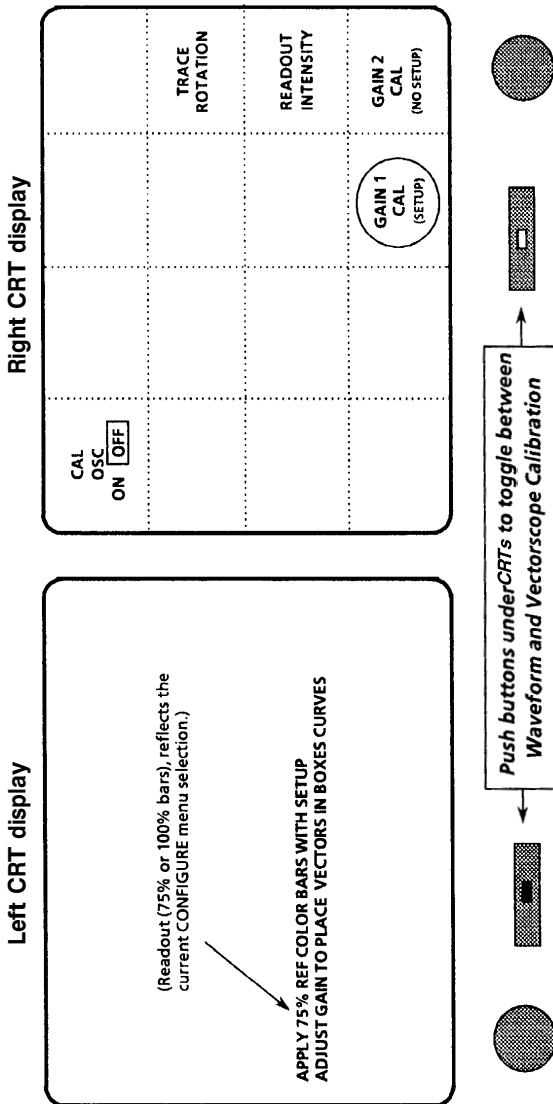

Figure 3-21: Vectorscope Calibration Menu Display for 1780R (NTSC), software versions 1.11 & Up, with CAL OSC Off

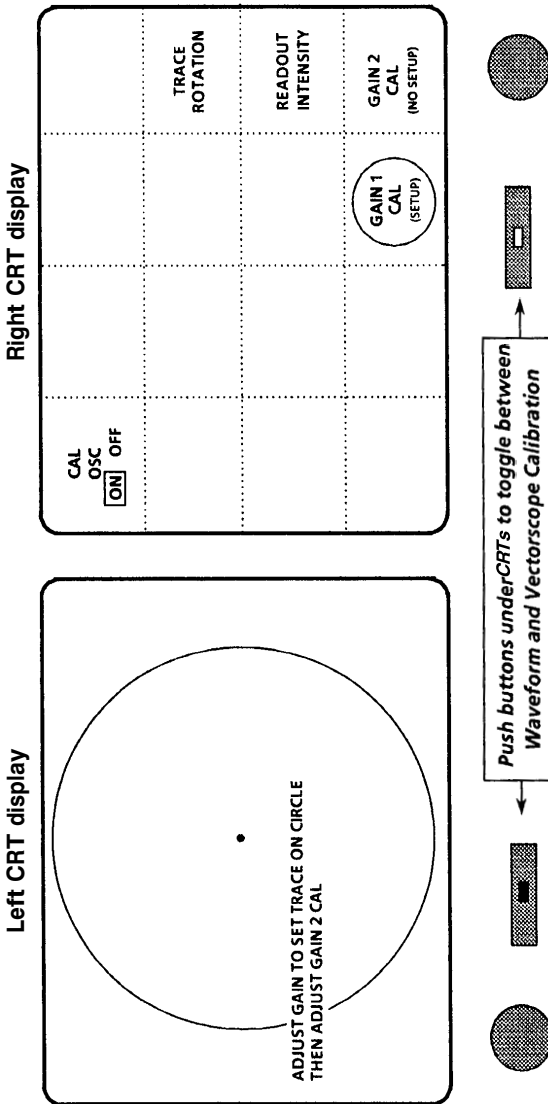

Figure 3-22: Vectorscope Calibration Menu Display for 1780R (NTSC), software versions 1.11 & Up, with CAL OSC On

For 1781R (PAL), touch <GAIN CAL> and use the large knob to make the circle match the compass rose.

- b. Touch <CAL OSC> until <OFF> is outlined.
6. To check the Vectorscope Gain adjustment, push the front-panel CALIBRATE button to enter the Calibration menu, then push the button under the left CRT.
- a. Apply a color bar signal (with 7.5% Setup for NTSC) to a 1780R-Series input channel and select that channel for display. A 100% or 75% color bar signal can be used, depending on the vectorscope readout (derived from the Configure menu setting).
 - b. Push the front-panel PHASE button and adjust the large knob to properly align the phase of the burst and vectors on the graticule. Push the PHASE button again to exit this mode.
 - c. For 1780R (NTSC): Touch <GAIN 1 CAL>. Check that the color bar vectors are in the graticule boxes. Set the generator to 0% Setup, touch <GAIN 2 CAL (NO SETUP)> and check that the color bar vectors are in the graticule boxes. Return the generator to 7.5% Setup if desired.

For 1781R (PAL): Touch <GAIN CAL>. Check that the color bar vectors are in the graticule boxes.

- d. Exit Calibrate menu.

Vectorscope Calibration Procedure

(for Software Versions 1.10 & Below)

Perform Steps 1 through 6 for both 1780R and 1781R (NTSC and PAL).

1. Push the front-panel CALIBRATE button to enter the Calibration menu. If Password operation is enabled, enter the password now. Waveform calibration will be displayed.
2. Push the button under the left CRT (LED will light) to select Vectorscope calibration, shown in Figure 3–23.

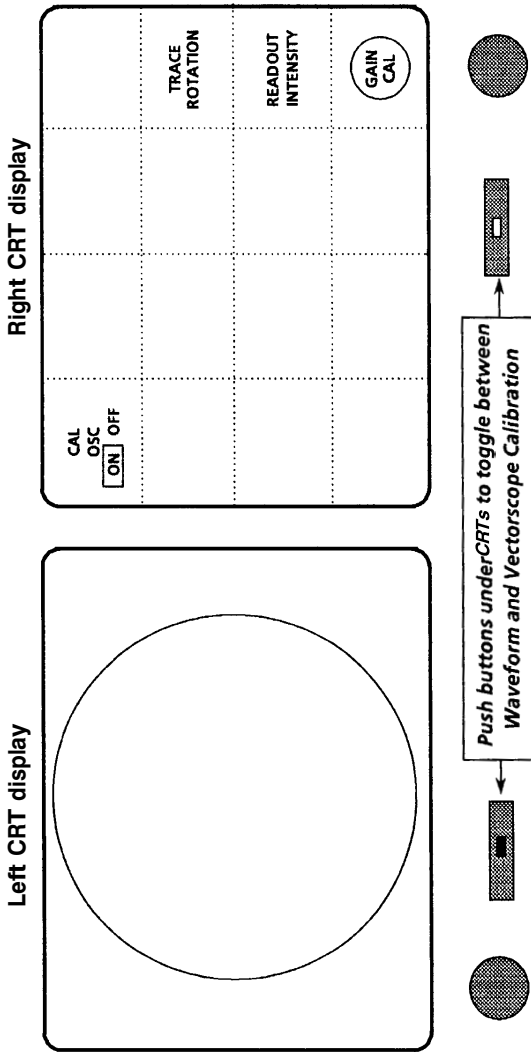

Figure 3-23: Vectorscope Calibration Menu Display for 1781R (PAL) all software versions, and for 1780R (NTSC) software versions 1.10 & Below

3. <READOUT INTENSITY> will be circled, and a test readout will be displayed. Use the large knob to adjust intensity. (The front-panel INTENSITY control adjusts signal intensity only. Readout intensity must be adjusted through the Calibration menu.)
4. Touch <TRACE ROTATION> to obtain a test axis, then use the large knob to adjust trace rotation.
5. Touch <CAL OSC> until <ON> is outlined. While the cal oscillator is on, the V axis switcher is enabled and 75% bars are selected (with setup for NTSC).
 - a. Touch <GAIN CAL>. The large knob will now adjust vectorscope gain. Use the large knob to make the circle match the compass rose.
 - b. Exit Calibrate menu.

Perform Step 6 for 1780R (NTSC) only.

6. Apply a 75% color bar signal with no setup to a 1780R input channel and select that channel for display.
 - a. Push the front-panel CONFIGURE button to enter the Configure menu. Touch the <PAGE> area of the screen until <2> is outlined.
 - b. Touch <SETUP> until <NO> is outlined.
 - c. Touch <BARS> until <75%> is outlined.
 - d. Push the front-panel PHASE button to assign the large knob function to phase shift. Adjust the large knob to properly align the burst and vectors on the graticule.
 - e. Push the front-panel CALIBRATE button to enter the Calibration menu, then push the button under the left CRT.
 - f. Touch <GAIN CAL>. The large knob will now adjust vectorscope gain. Use the large knob to set the color bar vectors to fall on the boxes.
 - g. Exit Calibrate menu.

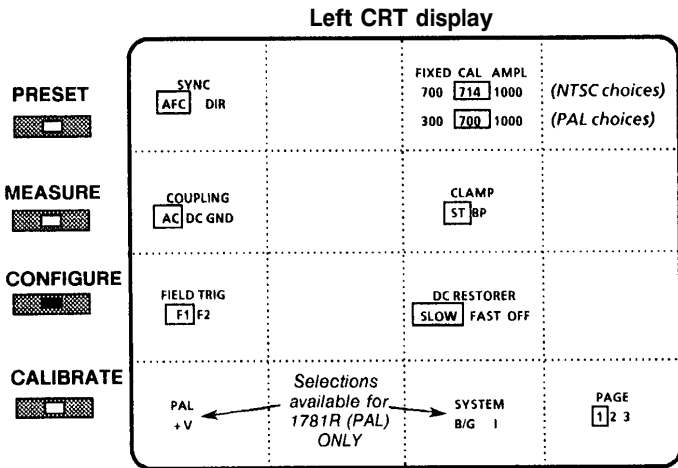

Figure 3–24: Configure Menu Screen, page 1

Table 3–6: Configure Menu Selections, page 1

SYNC	Direct or Auto Frequency Controlled wfm sync.
COUPLING	AC / DC coupling or ground reference, sets all four inputs. (The probe input is always AC coupled.) When GND is selected, the words "INPUTS GROUNDED" are displayed on the CRT.
FIELD TRIG	For two-field sweep only, selects whether field one or field two will be displayed on the left of the CRT.
FIXED CAL AMPL	Selects one of three fixed calibration amplitudes: 700 mV, 714 mV, or 1000 mV.
DC REST	Wfm DC restorer clamps: slow, fast, or off.
CLAMP	Waveform is clamped to sync tip or back porch time.
PAL +V	PAL: +V and –V lines overlaid; appears as though only +V were displayed (similar to NTSC display). +V: The –V lines are demodulated 180° away from the +V lines.
SYSTEM B/G I	Instrument operates in PAL systems B / G or I. ICPM measurements are most affected (0 carrier reference level varies between systems).

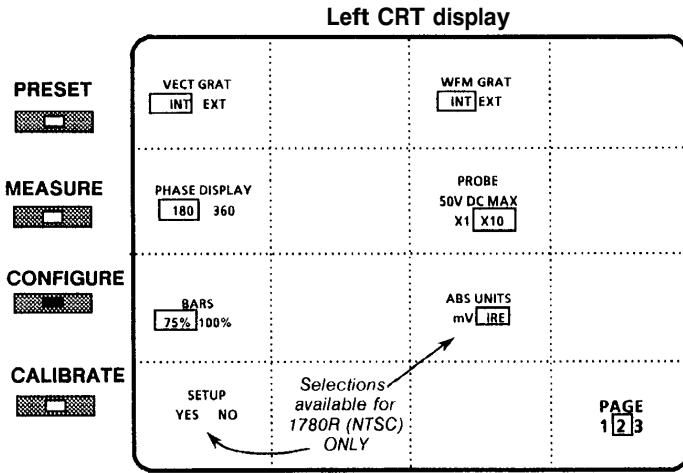

Figure 3–25: Configure Menu Screen, page 2

Table 3–7: Configure Menu Selections, page 2

BARS	Vectorscope can be calibrated to 75% or 100% color bars.
PHASE DISPLAY	360 = Phase reads from 0° to 360°. 180 = Phase reads from +180° to –179.95°.
VECT GRAT	Select internal or external graticule illumination.
WFM GRAT	Select internal or external graticule illumination.
ABS UNITS	NTSC only. Choose millivolts or IRE units to express calibrator and voltage cursor amplitudes.
PROBE	Internal probe gain is X1 or X10.
X10	With 10X probe, 1 V signal at probe tip = 1 V on screen. Works like probe input on 1480.
X1	With X1 probe, 1 V signal at probe tip = 1 V on screen. With X10 probe, 5 V signal at probe tip = 0.5 V on screen. For use with TTL, etc.
SETUP	NTSC only. Select <YES> when there is 7.5% setup on the incoming signal.

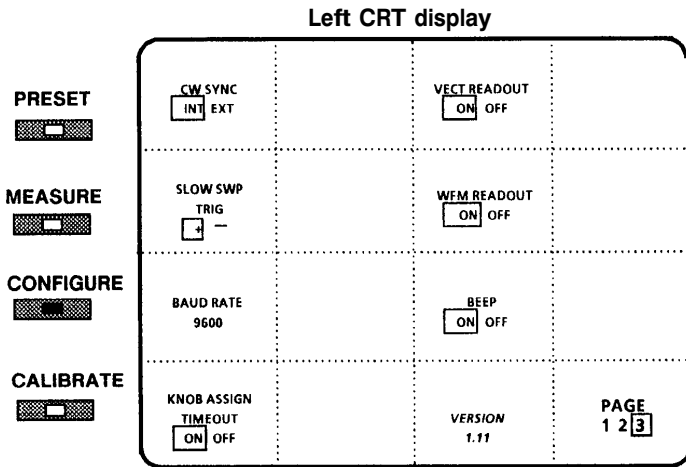

Figure 3–26: Configure Menu Screen, page 3

Table 3–8: Configure Menu Selections, page 3

CW SYNC	When CW subcarrier is used for vectorscope reference, wfm sync source can be INT or EXT.
SLOW SWP TRIG	Select positive or negative transition of the input signal to trigger slow sweep.
BAUD RATE	Select the baud rate for the serial interface.
VECT READOUT	<ON> enables on-screen readouts of data during vectorscope operation. <OFF> disables the readout. Full-screen menus are not affected.
WFM READOUT	<ON> enables on-screen readouts of data during waveform monitor operation. <OFF> disables the readout. Full-screen menus are not affected.
BEEP	Beep is either on or off. When on, audio indicates when touch screen selections have been made.
KNOB ASSIGN TIMEOUT	When <ON>, with vectorscope CRT selected, will revert to waveform CRT selection after 30 seconds of no knob activity.
VERSION	The version of software currently installed.

Measure Menu

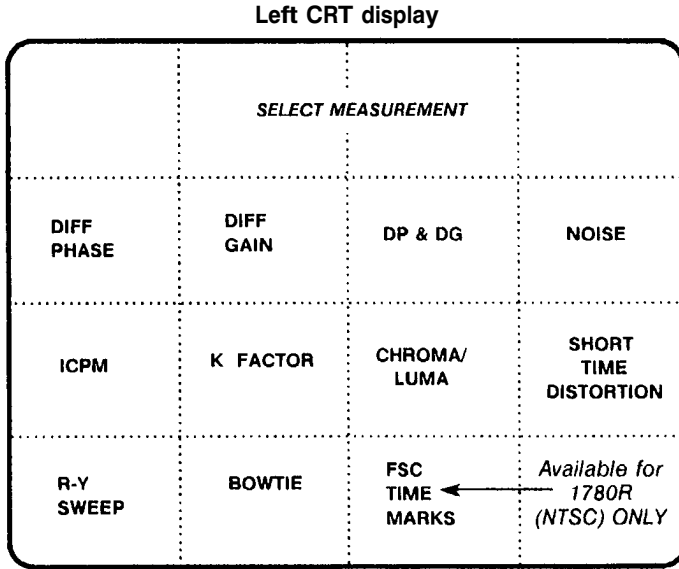

Figure 3-27: Measure Menu Screen

Using the Measure Menu

Push the front-panel MEASURE button to enter the Measurement menu, illustrated in Figure 3-27.

To select a measurement type, touch the desired measurement on the screen. (Selections are described in Table 3-9.)

Example: touch <DP & DG> to access simultaneous Differential Phase and Differential Gain measurements.

The menu display is replaced by vector and waveform displays, with the selected measurement indicated in the upper left corner of the vectorscope CRT.

Front-panel and menu settings are automatically adjusted to accommodate the selected measurement.

To exit a measurement mode, push the front-panel MEASURE button. In the case of DIFF PHASE and DIFF GAIN measurements, touch <GO TO DIFF GAIN> and <GO TO DIFF PHASE> areas of the screen to alternate between those two measurements.

Table 3–9: Measure Menu Description

DIFF PHASE	Differential Phase
DIFF GAIN	Differential Gain
DP & DG	Simultaneous Differential Phase / Differential Gain
NOISE	Signal-to-Noise ratio
ICPM	Incidental Carrier Phase Modulation
K FACTOR	K_{2T} measurement
CHROMA/LUMA	Chrominance-to-Luminance Gain & Delay
SHORT TIME DISTORTION	Short Time Distortion
R-Y SWEEP	Demodulator output
BOWTIE	Instrument set to B1–B2 and B1–B3 in Parade mode
FSC TIME MARKS	NTSC only. Bright-up dots on waveform at subcarrier frequency

Beep

Although most front-panel buttons remain operational in Measurement modes, some are locked. If an attempt is made to change a locked setting, a beep sounds.

Store and Recall Modified Setups

Enter the Measure menu, select a measurement, and modify the front-panel setup as desired.

Push the PRESET button. Following Preset menu instructions, store the modified measurement information at any preset location.

After both Preset and Measure menus have been exited, push the PRESET button and touch the appropriate preset. The stored measurement mode, including the user modifications, will be recalled. Both Preset and Measure LEDs will be on.

Making Measurements

Detailed instructions for each measurement are given in Section 4.



Measurements

Measurements

Measurement Information

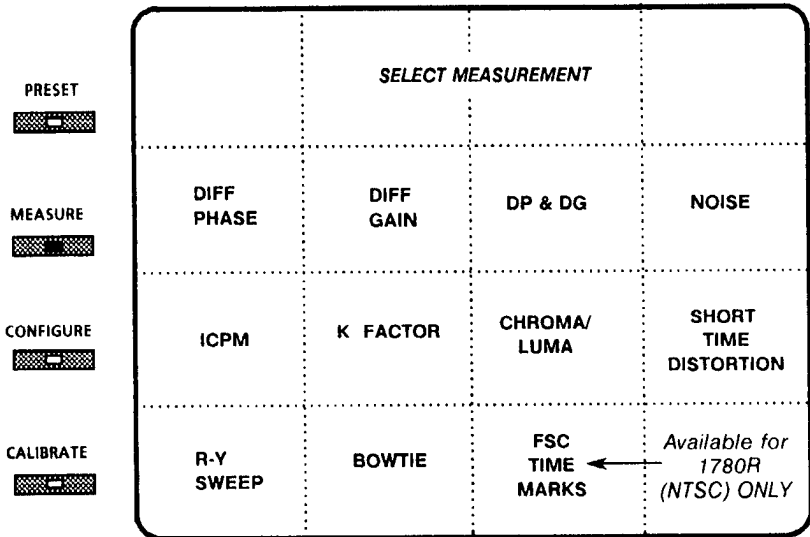

Figure 4-1: Measure Menu Access

NOTE. The measurements described in this section are accessed through the Measurement menu, shown in Figure 4-1.

Push the front-panel MEASURE button to enable the Measurement menu.

To access a desired measurement mode, touch the corresponding area on the Measurement menu screen.

To exit a measurement mode, push the front-panel MEASURE button again. In the case of DIFF GAIN and DIFF PHASE

measurements, touch the <GO TO DIFF PHASE> and <GO TO DIFF GAIN> areas of the screen to alternate between those two measurement modes.

To perform additional measurements, push the MEASURE button and touch the next desired measurement.

Differential Phase Measurement

Enter DIFF PHASE Mode

Push the MEASURE button to enable the Measurement menu, shown in Figure 4–1.

Touch <DIFF PHASE> on the screen.

The DIFF PHASE menu is displayed on the left CRT, with demodulator output displayed on the right CRT, as shown in Figure 4–2.

The instrument is now configured as specified in Table 4–1.

Large knob function is phase shift, and PHASE SHIFT LED lights.

Exit DIFF PHASE Mode

To exit DIFF PHASE mode, push the MEASURE button again. All instrument settings return to previous state.

To move from DIFF PHASE mode to DIFF GAIN, touch the <GO TO DIFF GAIN> area of the screen.

Horizontal positions, Vertical positions, and gain settings defined while in DIFF PHASE mode will be stored when exiting, and reinstated when this mode is selected again.

DIFF PHASE Menu Selections

***NOTE.** While operating in Line Select mode, noise reduction operates only with full field test signals.*

Right CRT display

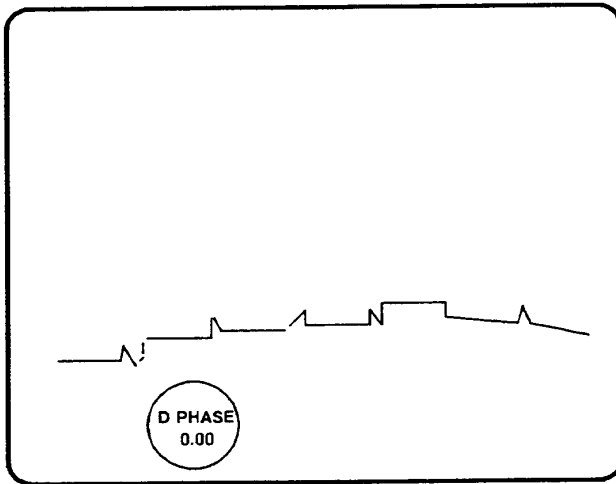

Left CRT display

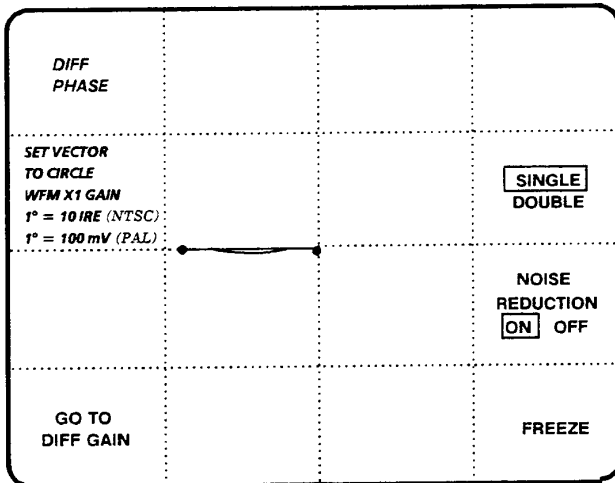

Figure 4-2: Differential Phase Measurement

Table 4-1: DIFF PHASE Front-Panel Configuration

VECTORSCOPE	Vector display enabled, other choices locked out.
WAVEFORM	R-Y sweep displayed, all front-panel choices locked out. (There is no LED to indicate R-Y sweep.)
INPUT	Status does not change. All differential modes locked out; if a differential mode was enabled, input is forced to CH A.
REFERENCE	Status does not change.
FILTER	Locked out.
WFM SWEEPS	Set to One Line when DIFF PHASE is selected. If <SINGLE> mode is selected, any of the other sweeps can be selected, using front-panel controls. If <DOUBLE> is selected, the instrument is set to One Line. The Field, Two Line and Three Line Sweeps are locked out.
GAINS	Vectorscope and Waveform gains can be adjusted while in DIFF PHASE mode; the new settings will be saved when the Measurement menu is exited, and reinstated when DIFF PHASE mode is again enabled.
WAVEFORM POSITION	The Horizontal and Vertical Position controls can be adjusted while in DIFF PHASE mode; the new settings will be saved when the Measurement menu is exited, and reinstated when DIFF PHASE mode is again enabled. The Vertical Position Control range is limited in order to keep the signal on screen.
VOLT / TIME CURSOR	Not available in DIFF PHASE mode.

Noise Reduction. Touch <NOISE REDUCTION> to toggle between <ON> and <OFF>. When noise reduction is off, the demodulator output (500 kHz BW) is directly displayed. When noise reduction is on, noise reduction of about 10–12 dB is accomplished without any reduction in bandwidth.

Noise reduction can be used in both <SINGLE> and <DOUBLE> modes.

NOTE. Freeze only available with Noise Reduction ON.

Freeze. To capture the display (right CRT only), touch <NOISE REDUCTION> so that <ON> is outlined, then touch <FREEZE>. <FREEZE> will be outlined.

The captured display remains on the screen even if the input signal is removed. The display is lost when the DIFF PHASE menu is exited by any method, including touching <GO TO DIFF GAIN>, pushing any of the four front-panel menu buttons, pushing the front-panel LINE SELECT button to enter Line Select mode, changing the selected line if already in Line Select mode, or turning instrument power off.

To exit Freeze mode, touch <FREEZE> again.

DIFF PHASE Measurement Information

The 1780R-Series provides two methods of making differential phase measurements: single- and double-trace.

The single-trace method of differential phase measurement resembles the single-trace differential phase mode on the 520A-Series. This method requires the operator to normalize the gains, but those settings will be stored and recalled at next entry to DIFF PHASE mode. The amount of distortion is read from the graticule scale.

The double-trace method of differential phase measurement resembles the double-trace differential phase in the R520A-Series. This method requires the operator to null the space between the ends and individual steps of the two traces. This provides greater accuracy than the single-trace method, and gives an on-screen readout of the distortion measurement.

Single-Trace DIFF PHASE Measurement Procedure

1. Apply a staircase signal or a ramp signal with subcarrier to the 1780R-Series.
2. Touch <SINGLE>.

3. Use the vectorscope variable gain control to set the amplitude of the chroma to be measured to the edge of the compass rose.
4. Use the large knob to set the phase of the chroma to be measured to the nine o'clock position. See Figure 4–3.
5. Use the Waveform Vertical Position control to place the beginning of the trace on a reference graticule mark.
6. Differential phase is that amount of signal that lies above or below the reference graticule mark. Read the amount directly off the graticule scale (waveform CRT); 1 major division = 1° (10 IRE NTSC or 100 mV PAL).

Double-Trace DIFF PHASE Measurement Procedure

1. Apply a staircase signal or a ramp signal with subcarrier to the 1780R-Series.
2. Touch <DOUBLE>.
3. Use the vectorscope variable gain control to set the amplitude of the chroma to be measured as desired, usually to the compass rose. In Double DIFF PHASE mode only, this setting may be altered to improve vertical resolution without affecting the accuracy of the readout.
4. Use the large knob to bring the left ends of the two traces (waveform CRT) together.
5. Push the REFERENCE SET front-panel button. Phase readout should be 0.00° .
6. Locate the point of largest deviation between the two traces, and use the large knob to bring the two traces together at that point.
7. Phase readout now gives the total amount of differential phase. To measure the differential phase of each step in the signal, repeat the process, bringing each individual step together.

Using Line Select in DIFF PHASE

1. Push the front-panel LINE SELECT button to enable Line Select mode. Both the waveform monitor and vectorscope will be in Line Select, and display the same line.

2. Line Select readout is provided on the waveform CRT. Make sure the Line number is circled. If it is not, touch the screen in that area.
3. Touch <MENU> to outline <ON> for Line Select menu display on the vectorscope CRT. Make Line select menu choices as desired.
4. Use large knob or <> buttons to change selected line.

Differential Gain Measurement

Enter DIFF GAIN Mode

Push the MEASURE button to enable the Measurement menu, as shown in Figure 4-1.

Touch <DIFF GAIN> on the screen.

The DIFF GAIN menu is displayed on the left CRT, and the demodulator sweep is displayed on the right CRT, as shown in Figure 4-3. The instrument is now configured as specified in Table 4-2.

Exit DIFF GAIN Mode

To exit DIFF GAIN mode, push the MEASURE button again. All instrument settings return to previous state.

To move from DIFF GAIN mode to DIFF PHASE, touch the <GO TO DIFF PHASE> area of the screen.

Horizontal positions, vertical positions, and gain settings defined while in DIFF GAIN mode will be stored when exiting, and reinstated when this mode is selected again.

DIFF GAIN Menu Selections

Noise Reduction. Touch <NOISE REDUCTION> to toggle between <ON> and <OFF>. When noise reduction is off, the demodulator output (500 kHz BW) is directly displayed. When noise reduction is on, noise reduction of about 10–12 dB is accomplished without any reduction in bandwidth.

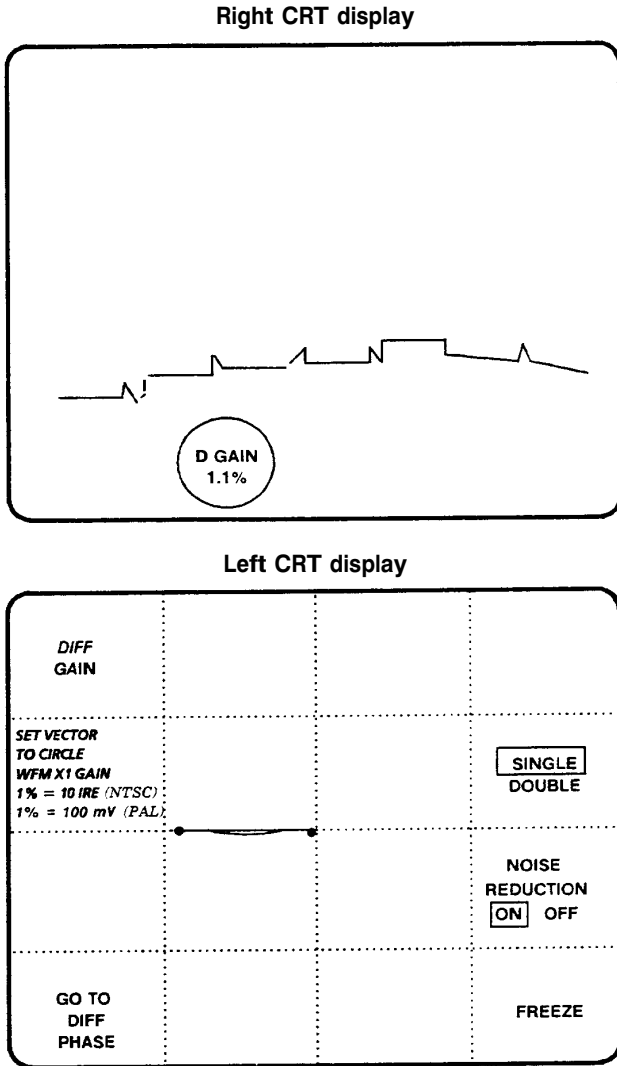

Figure 4-3: Differential Gain Measurement

Table 4-2: DIFF GAIN Front-Panel Configuration

VECTORSCOPE	Vector display enabled, other choices locked out.
WAVEFORM	Demodulated sweep displayed, all front-panel choices locked out. (There is no LED to indicate demodulated sweep.)
INPUT	Status does not change. All differential modes locked out; if a differential mode was enabled, input is forced to CH A.
REFERENCE	Status does not change.
FILTER	Locked out.
WFM SWEEPS	Set to One Line when DIFF GAIN is selected. If <SINGLE> mode is selected, any of the other sweeps can be selected, using front-panel controls. If <DOUBLE> is selected, the instrument is set to One Line. The Field, Two Line, and Three Line Sweeps are locked out.
GAINS	Vectorscope and Waveform gains can be adjusted while in DIFF GAIN mode; the new settings will be saved when the Measurement menu is exited, and reinstated when DIFF GAIN mode is again enabled.
WAVEFORM POSITION	The Horizontal and Vertical Position controls can be adjusted while in DIFF GAIN mode; the new settings will be saved when the Measurement menu is exited, and reinstated when DIFF GAIN mode is again enabled. The Vertical Position Control range is limited in order to keep the signal on screen.
VOLTAGE & TIMING CURSORS	Not available in DIFF GAIN mode.

Noise reduction can be used in both <SINGLE> and <DOUBLE> modes.

NOTE. Freeze available only with Noise Reduction ON.

Freeze. To capture the display (right CRT only), touch <NOISE REDUCTION ON>, then touch <FREEZE>.

The captured display remains on the screen even if the input signal is removed. The display is lost when the DIFF GAIN menu is exited by any method, including touching <GO TO DIFF PHASE>, pushing any of the four front-panel menu buttons, pushing the front-panel LINE SELECT button to enter Line Select mode, changing the selected line if already in Line Select mode, or turning instrument power off.

To exit Freeze mode, touch <FREEZE> again.

DIFF GAIN Measurement Information

The 1780R-Series provides two methods of making differential gain measurements: single- and double-trace.

The single-trace method of differential gain measurement resembles differential gain on the 520A-Series. This method requires the operator to normalize the gains, but those settings will be stored and recalled at next entry to DIFF GAIN mode. The amount of distortion is read from the graticule scale.

The double-trace method of differential gain measurement resembles double-trace differential phase in both 1780R-Series and R520A-Series. This method requires the operator to null the space between the ends and individual steps of the two traces. This provides greater accuracy than the single-trace method, and gives an on-screen readout of the distortion measurement.

Single-Trace DIFF GAIN Measurement Procedure

1. Touch <SINGLE>.
2. Apply a staircase signal or a ramp signal with subcarrier to the 1780R-Series.
3. Use the vectorscope variable gain control to set the amplitude of the chroma to be measured to the edge of the compass rose.
4. Use the large knob to set the phase of the chroma to be measured to the nine o'clock position. See Figure 4-3.
5. Use the Waveform Vertical Position control to place the beginning of the trace (waveform CRT) on a graticule reference mark.

6. Differential gain is the amount of signal that is above or below the graticule reference mark. Read the amount directly off the graticule scale (waveform CRT); 1 major division = 1% (10 IRE NTSC or 100 mV PAL).

Double-Trace DIFF GAIN Measurement Procedure

1. Apply a staircase signal or a ramp signal with subcarrier to the 1780R-Series.
2. Touch <DOUBLE>.
3. Use the vectorscope variable gain control to set the amplitude of the chroma to be measured to the compass rose.
4. Locate the point of largest deviation between the two traces (waveform CRT), and use the large knob to bring the traces together at this point.
5. Push the REFERENCE SET front-panel button. Diff gain readout should be 0.0%.
6. Locate the point of largest deviation between the two traces, and use the large knob to bring the traces together at this point.
7. Diff gain readout (waveform CRT) now gives the total amount of differential gain.
8. To measure the differential phase of each step in the signal, repeat the process, bringing each individual step together.

Using Line Select in DIFF GAIN

1. Push the front-panel LINE SELECT button to enable Line Select mode. Both the waveform monitor and vectorscope will be in Line Select, and display the same line.
2. Line Select readout is provided on the waveform CRT.
3. Touch <MENU> to outline <ON> for Line Select menu display on the vectorscope CRT.

Simultaneous Diff Phase & Diff Gain Measurements

Enter DP & DG Mode

Push the MEASURE button to enable the Measurement menu, shown in Figure 4–1.

Touch <DP & DG> on the screen to enable simultaneous differential phase and differential gain measurements.

The DP & DG menu is displayed on the left CRT, and the demodulated sweep is displayed on the right CRT. See Figure 4–4.

The instrument is now configured as specified in Table 4–3.

Exit DP & DG Mode

To exit DP & DG mode, push the MEASURE button again. All instrument settings return to previous state.

Horizontal positions, vertical positions, and gain settings defined while in DP & DG mode will be stored when exiting, and reinstated when this mode is selected again.

DP & DG Menu Selections

Noise Reduction. Touch <NOISE REDUCTION> to toggle between <ON> and <OFF>. When noise reduction is off, the demodulator output (500 kHz BW) is directly displayed. When noise reduction is on, noise reduction of about 10–12 dB is accomplished without any reduction in bandwidth.

Freeze. To capture the display (right CRT only), touch <NOISE REDUCTION> so that <ON> is outlined, then touch <FREEZE>. <FREEZE> will be outlined.

The captured display remains on the screen even if the input signal is removed. The display is lost when the DP & DG menu is exited by any method, including pushing any of the four front-panel menu buttons, pushing the front-panel LINE SELECT button to enter Line Select mode, changing the selected line if already in Line Select mode, or turning instrument power off.

To exit Freeze mode, touch <FREEZE> again.

Right CRT display

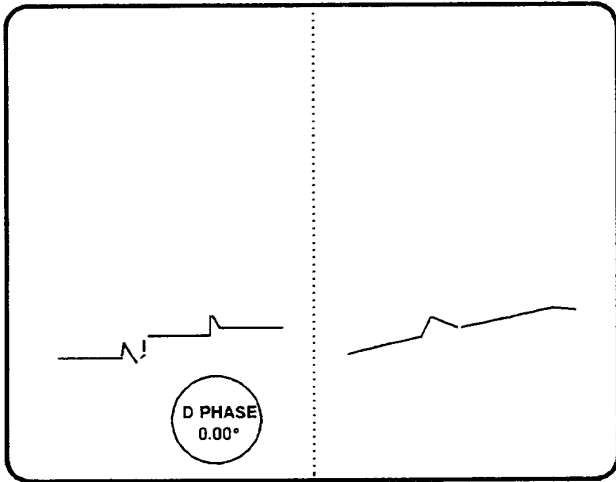

Left CRT display

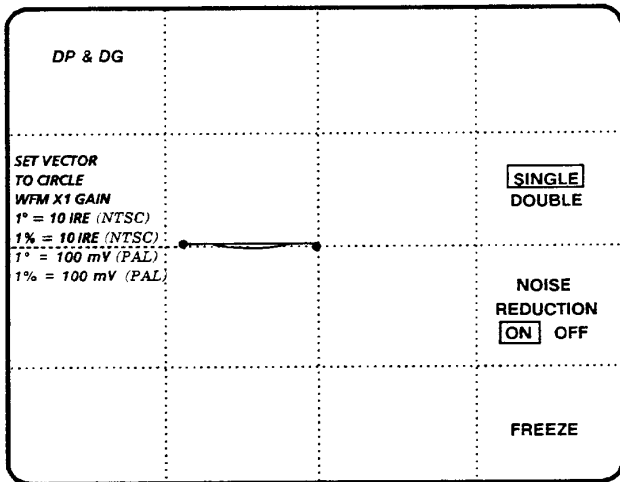

Figure 4-4: DP & DG Measurement

Table 4-3: DP & DG Front-Panel Configuration

VECTORSCOPE	Vector display enabled, other choices locked out.
WAVEFORM	Demodulated sweep displayed, all front-panel choices locked out. (There is no LED to indicate demodulated sweep.)
INPUT	Status does not change. All differential modes locked out; if a differential mode was enabled, input is forced to CH A.
REFERENCE	Status does not change.
FILTER	Locked out.
WFM SWEEPS	Set to Two Line when DP & DG is selected. Field, One Line, and Two Line Sweeps are locked out.
GAINS	Vectorscope and Waveform gains can be adjusted while in DP & DG mode; the new settings will be stored and recalled at next entry to DP & DG mode.
WAVEFORM POSITION	The Horizontal and Vertical Position controls can be adjusted while in DP & DG mode; the new settings will be stored and recalled at next entry to DP & DG mode. The Vertical Position control range is limited to keep the signal on screen. The Vertical Position control range is limited in order to keep the signal on screen.
VOLT / TIME CURSOR	Not available in DP & DG mode.

DP & DG Measurement Information

Single-Trace DP & DG. While the 1780R-Series provides two methods of making differential phase and differential gain measurements, only the single-trace method is available for simultaneous differential phase and gain measurements. A two-line display is used to display the two measurements simultaneously on one CRT (waveform monitor), with single-trace diff phase on the left portion of the CRT and single-trace diff gain on the right portion of the CRT.

The single-trace method of differential phase and gain measurement resembles differential phase on the TEKTRONIX R520A-Series. This method requires the operator to normalize the gains, but those

settings will be stored and recalled at next entry to DP & DG mode. The amount of distortion is read from the graticule scale.

DIFF PHASE & DIFF GAIN Measurement Procedure

1. Apply a staircase signal or a ramp signal with subcarrier to the 1780R-Series.
2. Touch <DP & DG>.
3. Use the vectorscope variable gain control to set the amplitude of the chroma to be measured to the edge of the compass rose.
4. Use the large knob to set the phase of the chroma to be measured to the nine o'clock position on the vectorscope display.
5. Use the Waveform Vertical Position control to place the beginning of the trace on a convenient graticule reference line.
6. Using the two-line display, differential phase and gain are displayed simultaneously on the left and right portions of the waveform monitor CRT. If necessary, adjust the vectorscope Variable Gain to vertically align the two displays.
7. Differential phase is the amount of the left signal that is above or below the graticule reference line. Read the amount directly off the graticule scale; 1 major division (10 IRE or 100 mV) = 1° .
8. Differential gain is the amount of the right signal that is above or below the graticule reference line. Read the amount directly off the graticule scale; 1 major division (10 IRE or 100 mV) = 1%.

Noise Measurement

Enter Noise Measurement Mode

Push the MEASURE button to enable the Measurement menu, shown in Figure 4–1.

Touch <NOISE> on the screen.

Exit Noise Measurement Mode

To exit Noise mode, push the MEASURE button again. All instrument settings return to their previous state.

Noise Measurement Procedure

Input the signal to be measured to the 1780R-Series and display on screen.

Noise can best be evaluated on a constant-luminance portion of the signal, such as back and front porch, sync tip, or color bars' white bar.

Adjust the large knob so that the gap between the waveforms just disappears. VAR GAIN is automatically set to maximum for lowest internal noise; Waveform X5 Gain can be selected for better accuracy with low noise.

Read the signal / noise ratio directly from the on-screen readout.

ICPM Measurement

Enter ICPM Measurement Mode

(Incidental Carrier Phase Modulation)

Push the MEASURE button to enable the Measurement menu, shown in Figure 4–1.

Touch <ICPM> on the screen.

The instrument is now configured as specified in Table 4–4.

Table 4–4: ICPM Front-Panel Configuration

VECTORSCOPE	Selected by operator
WAVEFORM	Waveform display enabled, other choices locked out
INPUT	Selected by operator
REFERENCE	Locked
FILTER	Low pass
WFM SWEEPS	Locked
MAGNIFIER	Automatically set to X25, other choices may be selected by operator.
GAINS	Calibrated gains
WAVEFORM POSITION	Horizontal and Vertical Position control settings selected by operator are saved and reinstated each time the ICPM mode is enabled.

Exit ICPM Measurement Mode

To exit ICPM mode, push the MEASURE button again. All instrument settings return to their previous state.

ICPM Measurement Information

ICPM is measured by observing an XY display of quadrature output of a 1450 demodulator versus the video signal itself.

The 1780R-Series ICPM measurement method is similar to the Tektronix 1480-Series method. Refer to the 1450 manual for details on configuring the demodulator for this measurement. The external low-pass filters (Tektronix P/N 015-0352-00) can be used to improve the display.

ICPM Measurement Procedure

1. Connect the Quadrature Out of the 1450 or TV1350 Demodulator to the 1780R-Series EXT HORIZ Input and the Video Out to the selected 1780R-Series input channel.
2. Push the MEASURE button to enable the Measurement menu. For in-service ICPM measurements, LINE SELECT can be used to select the desired line (zero reference pulse, then modulated staircase signal.) For software versions 1.13 and up: LINE SELECT can be used to select two lines for an overlaid display. Push the front-panel LINE SELECT button, then touch the circle in the lower left portion of the vectorscope CRT to assign large knob function. Select the line and field where the zero reference pulse is located. To select the second line, touch the circle in the lower left portion of the waveform touch screen, and select the line and field where the modulated staircase signal is located. Touch the ICPM error readout area of the waveform CRT to return the large knob assignment to the graticule, then proceed to step 3.
3. Turn intensity to maximum, to locate the position of the trace off screen. Use the 1780R-Series Horizontal Position control to center the signal horizontally, and the Vertical Position control to set the zero carrier reference point to the center of the electronic graticule plus mark (+). See Figure 4–5. Turn down intensity for normal viewing.
4. If no ICPM is present on the carrier, the display between blanking and zero carrier will line up on the vertical axis. If ICPM is present, the display will tilt. Use the precision control (large knob) to adjust the electronic graticule until it just touches the portion of the signal with the greatest error. Adjust the Magnification factor as needed to best view the error.

- The 1780R-Series on-screen readout shows the ICPM phase error in degrees.

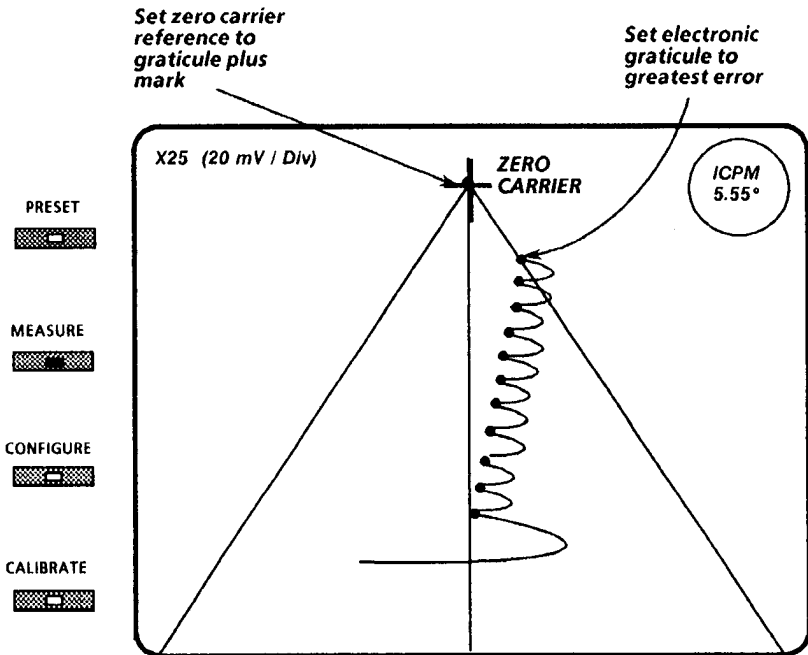

Figure 4-5: Making ICPM Measurements

K Factor Measurement

Enter K Factor Mode

Push the MEASURE button to enable the Measurement menu, shown in Figure 4–1.

Touch <K FACTOR> on the screen.

K FACTOR is displayed on the left CRT. The input signal and electronic graticule are displayed on the right CRT.

The instrument is now configured as specified in Table 4–5

Making K Factor Measurements

1. Use the Horizontal Position and the Waveform Var Gain as needed to position the signal baseline on the dotted electronic graticule line and position the top of the pulse at the center of the electronic graticule plus sign (+). See Figure 4–6.
2. Use the large knob to adjust the electronic K Factor graticule outline to just touch the point of greatest signal error.
 - a. Use X5 Gain as needed to view the signal. To ensure a calibrated graticule, if the Var Gain was employed while in X1 Gain, it must remain on while in X5 Gain.
3. Read the K_{2T} Factor error in percent on the CRT readout.

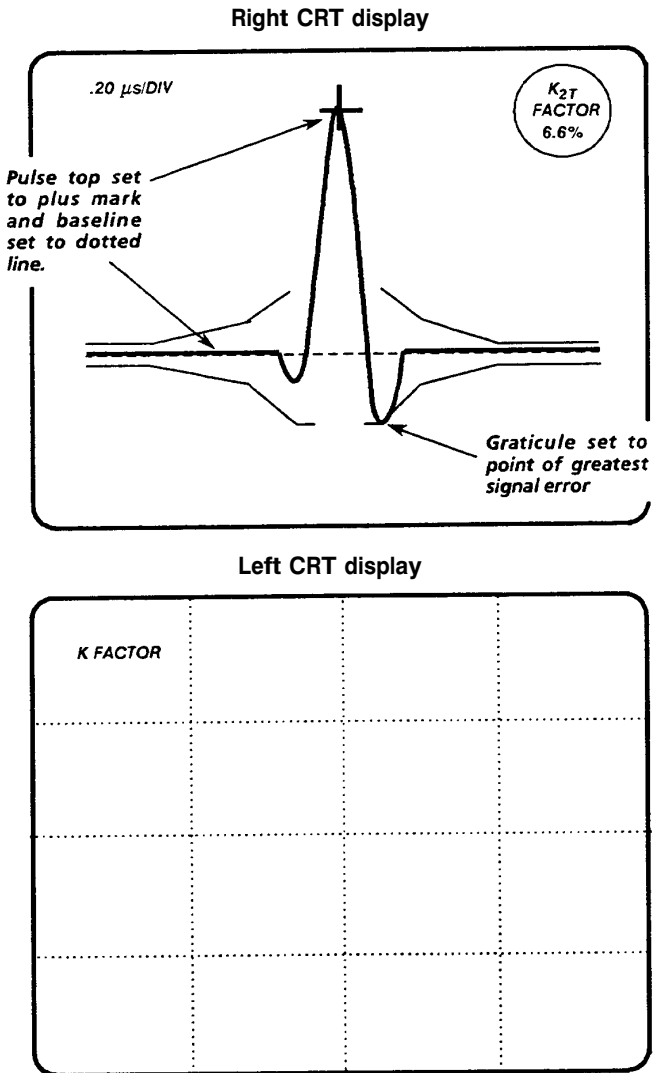

Figure 4-6: K Factor Electronic Graticule

Table 4-5: K Factor Front-Panel Configuration

VECTORSCOPE	Selected by operator
WAVEFORM	Waveform display enabled, choices locked out
INPUT	Selected by operator
REFERENCE	Status does not change
FILTER	Status does not change
WFM SWEEPS	One Line sweep selected, other choices may be selected by operator.
GAINS	VAR Waveform gain selected
WAVEFORM POSITION	Horizontal and Vertical Position control settings selected by operator are saved and reinstated each time the ICPM mode is enabled.
VOLTAGE & TIMING CURSORS	Both voltage and timing cursors are available in K Factor measurement mode.

Chroma / Luma Inequalities Measurement

Enter Chroma / Luma Mode

Push the MEASURE button to enable the Measurement menu, shown in Figure 4-1.

Touch <CHROMA / LUMA> on the screen.

Vectorscope and waveform displays are enabled and the instrument is now configured as shown in Figure 4-7 and Table 4-6.

Exit Chroma / Luma Mode

To exit Chroma / Luma mode, push the MEASURE button again. All instrument settings return to their previous state.

Horizontal positions, vertical positions, and gain settings defined while in Chroma / Luma mode will be stored and reinstated when this mode is selected again.

Cursors in Chroma / Luma

Ensure that <C/Y> is selected.

The cursors may be used to extract nomograph data from the 1780R-Series instrument. Five cursor settings must be entered by the operator, using the waveform monitor CRT. Readout in the upper right corner of CRT guides operator through the five settings, which are described in the following procedure.

Making Chroma / Luma Measurements (Using Cursors)

1. Select Pulse Width
 - a. Touch <12.5T>, <25T>, or <OTHER> for NTSC. Touch <10>, <20>, or <OTHER> for PAL. Chroma / Luma gain error readings are not affected by pulse width.
2. Set Pulse Amplitude
 - a. Adjust Horizontal Position and Magnification to place the modulated sine-squared pulse on screen.
 - b. Set Cursor 1 to the pulse top. Set Cursor 2 to the baseline.
 - c. Touch <ENTER>.

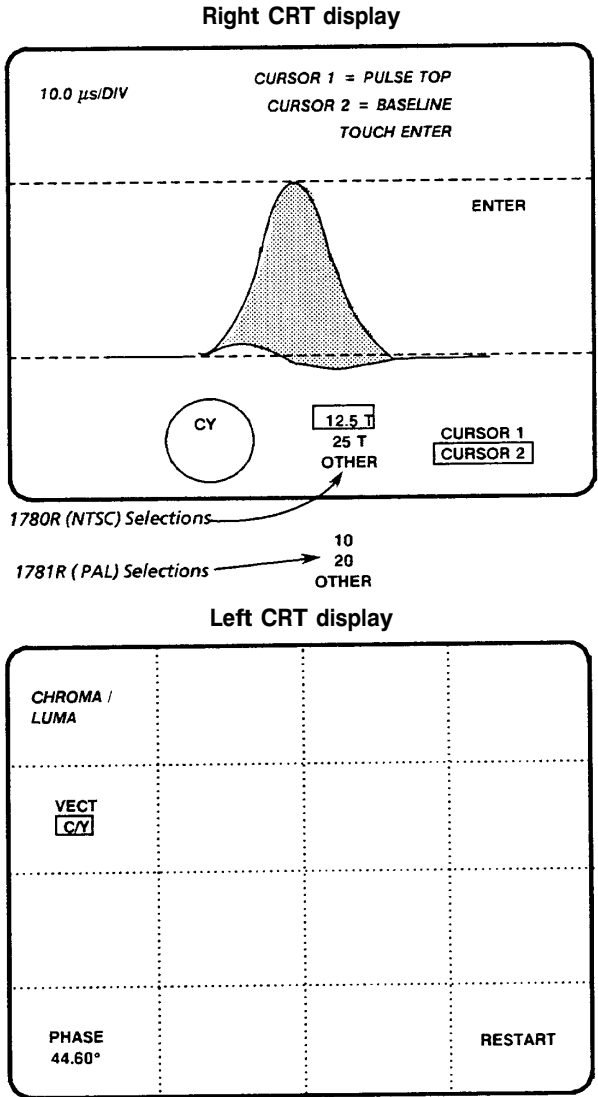

Figure 4-7: Initial Chroma / Luma Inequalities Measurement Screen

Table 4–6: Chroma / Luma Front-Panel Configuration

VECTORSCOPE	Vector display initially enabled, other choices locked out. Chroma-to-Luma Lissajous display selected by touching <VECTOR / C/Y> area of screen.
WAVEFORM	Waveform display enabled, other choices locked out.
INPUT	Status does not change. All differential modes locked out; if a differential mode was enabled, input is forced to CH A.
REFERENCE	Status does not change.
FILTER	Flat filter automatically selected. Other choices locked out.
WFM SWEEPS	Sweep settings (typically X10 or X20 Mag) selected by operator are saved and re instated each time the Chroma / Luma mode is enabled.
GAINS	Vectorscope and Waveform gain settings selected by operator are saved and reinstated each time the Chroma / Luma mode is enabled.
WAVEFORM POSITION	Horizontal and Vertical Position control settings selected by operator are saved and reinstated each time the Chroma / Luma mode is enabled.
VOLTAGE & TIMING CURSORS	Voltage cursors are automatically enabled. Cursors can be used to extract stored nomograph data.

3. Set Left Lobe Amplitude

- a. Position Cursor 1 on the point of the left lobe that is furthest from the baseline. Leave Cursor 2 on the baseline.
- b. Touch <ENTER>.

4. Set Right Lobe Amplitude

- a. Position Cursor 1 on the point of the right lobe that is furthest from the baseline. If no right lobe is present (indicating no delay error), set Cursor 1 to the baseline. Leave Cursor 2 on the baseline.
- b. Touch <ENTER>.

5. Set Modulated Sine-squared Pulse H.A.D.

If OTHER was selected on Step 1, this step allows the 1780R-Series instrument to determine the pulse width and adjust the readout accordingly.

- a. Voltage cursors are automatically set to 50% of the amplitude entered in step 2.
- b. Timing cursors are enabled and appear as bright-up dots on the display. Large knob now controls timing cursor position.
- c. Adjust Timing Cursor 1 to the point where the pulse signal intersects the approximate 50% amplitude level identified by the Voltage Cursor.
- d. Adjust Timing Cursor 2 to the point where the opposite side of the pulse signal intersects the Voltage Cursor. See Figure 4-8.

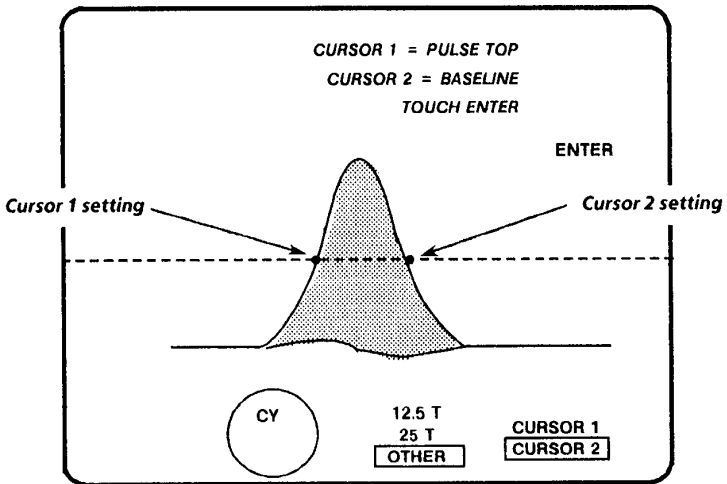

Figure 4-8: Setting Timing Cursors to Pulse Width

Chroma / Luma Measurements with Lissajous Display

The Lissajous display is an X/Y plot of the sine-squared luminance pulse versus the sine-squared envelope of the demodulated chrominance. This display is useful when signals have previously been transcoded into a component format, so that R-Y and B-Y may be unequally delayed with respect to luminance.

While still in the Chroma / Luma measurement mode, touch <VECT / C/Y> to outline <VECT>.

Set large knob function to phase control by touching the <PHASE> area of the vectorscope CRT.

Using the large knob to set phase, set the burst vector to the 9 o'clock position for an R-Y versus luminance display, or to the 6 o'clock position for a B-Y versus luminance display.

If there are no chrominance-to-luminance errors, the Lissajous display will show a straight line at 45° .

Phase delay causes separation of the display.

Gain inequalities cause displacement of the display end points.

Short-Time Distortion Measurement

Enter Short-Time Distortion Mode

Push the MEASURE button to enable the Measurement menu, shown in Figure 4-1.

Touch <SHORT-TIME DISTORTION> on the screen.

Vectorscope and waveform displays are enabled and the instrument is now configured as shown in Figure 4-9 and Table 4-7.

Exit Short-Time Distortion Measurement Mode

To exit the Short-Time Distortion mode, push the MEASURE button again. All instrument settings return to their previous state.

Short-Time Distortion Measurement Procedure

Use the Vertical and Horizontal Position controls and the Waveform VAR gain to position the signal as follows: The signal baseline goes through the graticule “+” at the lower left of the CRT, the rising edge goes through the “+” at center screen, and the top of the signal goes through the “+” in the upper right of the screen. See Figure 4-9.

Use the large knob to adjust the electronic graticule to just touch the signal at the point of greatest error.

Obtain the Short-Time Distortion error from the on-screen readout, which is given in percent of the overall bar signal amplitude.

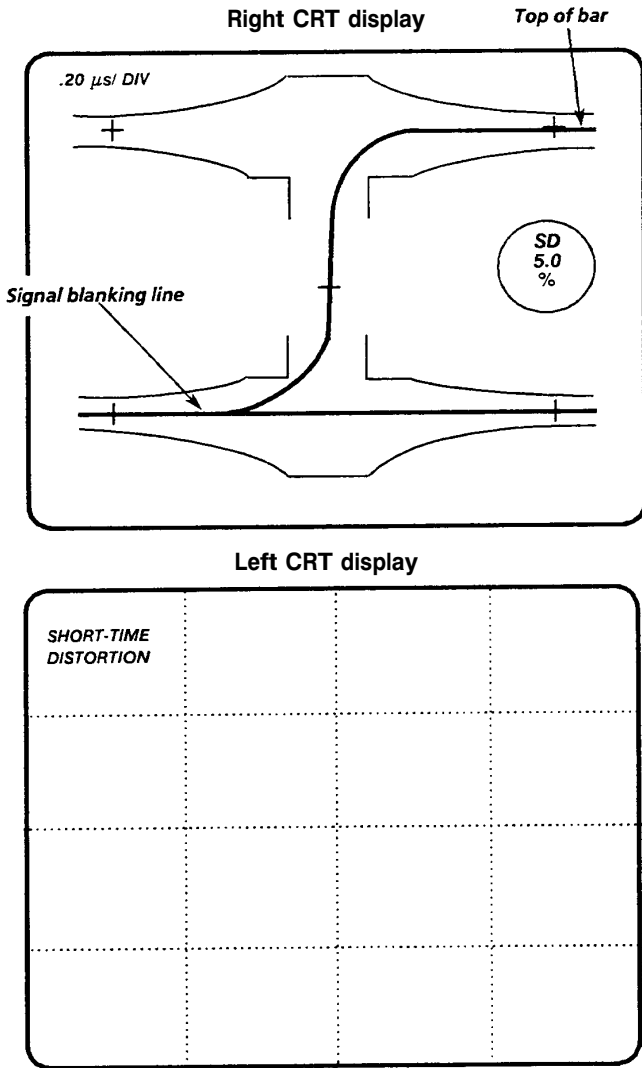

Figure 4-9: Short-Time Distortion Electronic Graticule

Table 4-7: Short-Time Distortion Mode Front-Panel Configuration

VECTORSCOPE	Selected by operator
WAVEFORM	Waveform display enabled, other choices may be selected by operator
INPUT	Status does not change
REFERENCE	Status does not change
FILTER	Flat is selected, other choices are locked up
WFM SWEEPS	One Line selected
GAINS	Waveform VAR is selected
WAVEFORM POSITION	Horizontal and Vertical Position control settings selected by operator are saved and reinstated each time the Short-Time Distortion mode is enabled
VOLTAGE & TIMING CURSORS	Both Voltage and Timing cursors are available

R–Y Sweep Measurement

Enter R–Y Sweep Mode

Push the MEASURE button to enable the Measurement menu, shown in Figure 4–1.

Touch <R–Y SWEEP> on the screen.

Vectorscope and waveform displays are enabled and the instrument is now configured as shown in Table 4–8.

Table 4–8: R–Y Sweep Mode Front-Panel Configuration

VECTORSCOPE	Vector or SCH Selected by operator. Other choices locked.
WAVEFORM	Waveform display enabled, other choices locked.
INPUT	Status does not change
REFERENCE	Status does not change
FILTER	Locked
WFM SWEEPS	Two Field is selected. Other choices may be made by operator.
GAINS	Gain control settings selected by operator are saved and reinstated each time the R–Y Sweep mode is enabled.
WAVEFORM POSITION	Horizontal and Vertical Position control settings selected by operator are saved and reinstated each time the R–Y Sweep mode is enabled.
VOLTAGE & TIMING CURSORS	Both Voltage and Timing cursors are available

Exit R–Y Sweep Measurement Mode

To exit the R–Y Sweep mode, push the MEASURE button again. All instrument settings return to their previous state.

R–Y Sweep Mode Information

The 1780R-Series R–Y Sweep mode provides a voltage-versus-time display (on the waveform monitor CRT) of the vectorscope R–Y demodulator output.

Using R–Y Sweep Mode

1. Set the burst to 180° on the vector graticule. The R–Y component of the input signal is viewed on the waveform CRT.
2. Set the front-panel VECT / SCH INPUT selection to SCH, and the SCH Phase component is added to the R–Y display. The SCH Phase display is proportional to the amplitude of the R–Y display, and has a rise time of approximately 70 horizontal lines.
3. With a Field rate sweep selected, the location and relative magnitude of the field rate SCH Phase errors are viewed. If no SCH Phase errors are present, the display will be flat for NTSC. For PAL, the display consists of a perfect 25 Hz sine wave, with SCH Phase errors seen as deviations from the sine wave.

Bowtie Measurement

Use the following information to perform bowtie measurements.

Enter Bowtie Measurement Mode

Push the MEASURE button to enable the Measurement menu, shown in Figure 4–1.

Touch <BOWTIE> on the screen.

BOWTIE is displayed on the left CRT. The CH B1–B2 and CH B1–B3 signals are displayed on the right CRT. The instrument is now configured as specified in Table 4–9 and Figure 4–10.

The large knob has no function in Bowtie mode.

Bowtie Measurement Procedure

1. To check for timing and relative amplitude errors in a three-wire signal path, route a Bowtie test signal from a generator, through the signal path, to the 1780R-Series CH B1, CH B2, and CH B3 Inputs.
2. Push the MEASURE button, then touch <BOWTIE> on screen.
3. Check for a sharp null in the center of each half of the two-line signal display. The timing marker details in the waveform are an electronic graticule for calibration of the timing offsets. The center (taller) pulse is the 0 time error mark. Each mark away from center indicates 20 ns of relative timing error. The left half compares CH B1 with CH B2, and the right half compares CH B1 with CH B3.
4. A broad null indicates unequal amplitudes between signals.

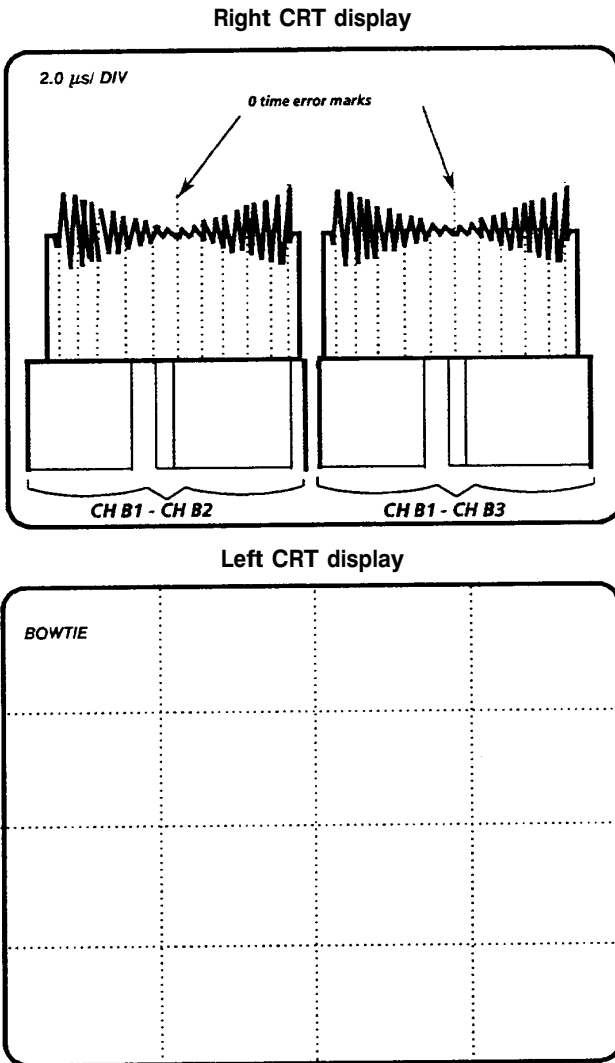

Figure 4-10: Bowtie Measurement Screen

Table 4-9: Bowtie Mode Front-Panel Configuration

VECTORSCOPE	Selected by operator
WAVEFORM	Parade selected, other choices locked
INPUT	B1-B2 & B1-B3 selected, other choices locked
REFERENCE	Status does not change
FILTER	Status does not change
WFM SWEEPS	Two Line selected, other choices locked
GAINS	Gain setting selected by operator are saved and reinstated each time the Bowtie measurement mode is enabled
WAVEFORM POSITION	Horizontal and Vertical Position control settings selected by operator are saved and reinstated each time the Bowtie measurement mode is enabled
TIMING CURSORS	Timing cursors are available

F_{SC} Time Marks Measurement

Enter F_{SC} Time Marks Measurement Mode

Push the MEASURE button to enable the Measurement menu, shown in Figure 4–1.

Touch <FSC TIME MARKS> on the screen.

The large knob function is assigned to phase shift.

The instrument is now configured as specified in Table 4–10.

Table 4–10: F_{SC} Time Marks Front-Panel Configuration

VECTORSCOPE	SCH display automatically enabled; other choices may be selected by operator.
WAVEFORM	Waveform display enabled, other choices may be selected by operator.
INPUT	Status does not change.
REFERENCE	Status does not change.
FILTER	Status does not change.
WFM SWEEPS	Sweep and Mag settings selected by operator are saved and reinstated each time the F _{SC} time marks mode is enabled.
GAINS	Gain settings selected by operator are saved and reinstated each time the F _{SC} time marks mode is enabled.
WAVEFORM POSITION	Horizontal and Vertical Position control settings selected by operator are saved and reinstated each time the F _{SC} time marks mode is enabled.
TIMING CURSORS	Timing Cursors are not available.

Exit F_{SC} Time Marks Measurement Mode

To exit F_{SC} Time Marks mode, push the MEASURE button again. All instrument settings return to their previous state.

Phase set while in Time Marks mode is stored and reinstated each time this mode is selected.

Making SCH Phase Measurements

The 1780R-Series offers two methods of measuring SCH phase errors: The polar SCH display, and this F_{SC} Time Marks (voltage-vs-time) method. The F_{SC} time marks display is more direct than the polar display, and affords the operator more manual control, but may provide a less precise measurement. To ensure an accurate measurement, both methods can be used.

1. Adjust the waveform monitor controls for a high resolution display of sync.
2. Adjust the large knob until one of the bright-up dots is at the 50% point of the leading edge of sync on the waveform display.
3. Push the front-panel REFERENCE SET button. The phase readout is now 0.00° .
4. Adjust the large knob until the dots are on the zero crossing (or 50% point) of burst on the waveform display.
5. The vectorscope CRT readout now gives SCH phase error in degrees.

Voltage Cursors in F_{SC} Time Marks Mode

While in Time Marks mode, push the front-panel VOLTAGE CURSOR button. A voltage cursor menu appears on the right side of the vectorscope CRT. Touch <ABSOLUTE / RELATIVE> or <SEPARATE / TRACK> to toggle between those voltage cursor functions. Refer to the section on Voltage Cursors in Section 3 of this manual for more details.

Verifying Burst Position

The F_{SC} time marks display can be used to verify that burst is located 19 subcarrier cycles from the 50% point of the leading edge of sync.

Position one of the dots on the 50% point of sync, and count the number of dots between that dot and the dot on the zero crossing of the first full cycle of burst.

Other Measurements

The 1780R-Series instruments are capable of other measurements not described in this manual, such as Group Delay and Chrominance Non-Linear Phase and Gain. These measurements and others are covered in the book, *Television Measurements*, available through Tektronix Customer Support.



Specifications

Specifications

Table 5–1: Input/Output

Characteristics	Performance Requirements	Supplemental Information
Vertical Ranges		
Volts Full Scale 1.0	Accuracy – 1.0 V \pm 0.007 V.	P-to-P Amplitude for Full Graticule. 1.0 volt / 140 IRE.
Var		\leq 0.5:1 to \geq 1.5:1 (0.67 V to 2.0 V input signal can be made full scale).
Input Gain Ratios		
A to B	1:1 \pm 0.002 (0.998 – 1.002)	
AUX VIDEO IN to A Input	1.5 dB \pm 0.3 dB	
Input A to AUX VIDEO OUT	1:1 \pm 0.005 (0.995 – 1.005)	
Input A to PIX MON OUT	1:1 \pm 0.02 (0.98 – 1.02)	
Vertical Magnifier		
X5 Accuracy		0.2 V \pm 0.007 V.
P-to-P Amplitude for Full Graticule		0.2 volt / 28 IRE.
Maximum Input Signal		
AC Couple All Inputs	2.0 V, p-to-p, 10% – 90% APL.	Aux Video Out and Pix Mon (terminated), 1.0 V p-to-p, 10% – 90% APL.
DC Couple All Inputs	\pm 1.5 V (DC + peak AC).	

Table 5-1: Input/Output (Cont.)

Characteristics	Performance Requirements	Supplemental Information
Max volts from Loop-Through common terminal to chassis	2 V rms at mains frequency.	Rejection ratio of common-to-chassis in floating ground mode, ≥ 34 dB at mains frequency.
Max DC Output Voltage		
Aux Video Out		± 0.5 V into 75 Ω
Pix Mon Out		± 0.5 V into 75 Ω Line strobe; no input signal.
Remote Control		
Interface Standard		RS232 / RS422.
Control Enable		Ground Closures and Pre-sets.

Table 5-2: Waveform Monitor Vertical System

Characteristics	Performance Requirements	Supplemental Information
Return Loss		
CH A, B1, B2, or B3	>40 dB DC to 5 MHz.	(Terminated in 75 Ω)
Aux Video In, Aux Video Out, & Pix Mon Out	>34 dB DC to 5 MHz.	Instrument On only.
Ext. Sync Input	>46 dB to 5 MHz.	
Loop-Through Isolation		>80 dB at F_{SC} , between channels and between each channel and EXT REF. Measured externally.

Table 5–2: Waveform Monitor Vertical System (Cont.)

Characteristics	Performance Requirements	Supplemental Information
Crosstalk		Typically 70 dB isolation between channels. Measured at F_{SC} between channels and each channel and EXT REF.
Frequency Response		
Flat (X1)	From 50 kHz Reference:	
50 kHz – 5 MHz Input Ch A, B1, B2, & B3	$\pm 1\%$.	1 Volt Full Scale, Variable Gain off. Adjusted for minimal Luminance/Chrominance gain error. Typically <0.5%.
AUX IN, AUX OUT	$\pm 2\%$.	
5 MHz – 10 MHz Input Ch A	+1%.	1 Volt Full Scale, Variable Gain off.
Input Ch B1, B2, and B3	$\pm 2\%$.	
AUX IN, AUX OUT	$\pm 2\%$.	
10 MHz – 15 MHz Input Ch A, B1, B2, & B3	+2%, -5%.	1 Volt Full Scale, Variable Gain off.
15 MHz – 20 MHz Input Ch A, B1, B2, & B3	+2%, -15%.	1 Volt Full Scale, Variable Gain off. -3 dB at >20 MHz.
Lum/Chroma Gain	$\pm 0.5\%$	X5 Gain, Modulated Sin^2 Pulse (12.5T NTSC, 10T PAL).
Voltage Cursor		
Accuracy	0.2%.	
Resolution	1 mV.	

Table 5-2: Waveform Monitor Vertical System (Cont.)

Characteristics	Performance Requirements	Supplemental Information
Cal Amplitude		
Accuracy	1.00 V \pm 0.2%.	NTSC 0.714 V \pm 0.5%.
Resolution	1 mV at 1.00 V.	PAL 0.700 V \pm 0.5%.
DC Restorer		
Clamp Point		Back porch or Sync Tip.
Mains Hum Atten.		Attenuation 10%.
Slow Clamp	\leq 0.9 dB.	
Fast Clamp	\geq 26 dB.	
Shift caused by presence or absence of burst		NTSC = 1 IRE. PAL = \leq 7 mV.
Lum/Chroma Gain Ratio		
NTSC (50 kHz – 3.58 MHz)	1:1 \pm 1%.	Adjust to minimize luminance-to-chrominance gain error at 1 V Full Scale, typically \leq 0.5%.
PAL (50 kHz – 4.43 MHz)	1:1 \pm 1%.	
Noise Measurements		
Accuracy	To 56 dB within 1 dB. To 60 dB within 2 dB.	Relative to 700 mV _{RMS} . VAR GAIN adjusted to maximum.
Offset Accuracy	To 56 dB within 0.5 dB. To 60 dB within 1 dB.	

Table 5–2: Waveform Monitor Vertical System (Cont.)

Characteristics	Performance Requirements		Supplemental Information
Vertical Overscan			
Baseline Distortion	<7 mV variation in baseline of chroma when positioned anywhere between sync tip and 100% white.		1 V p-to-p PAL or NTSC Modulated Sin ² composite video signal (12.5T NTSC, 10T PAL). 1.0 or X5, Variable Gain off. Typically <0.5%.
DC Channel Matching			Typically within 30 mV.
Common Mode Rejection	<i>A – B1</i>	<i>B1 – B2 / B1 – B3</i>	1 V p-to-p common mode signal.
60 Hz	≥46 dB	≥46 dB	
15 kHz (Lum)	≥46 dB	≥46 dB	
1 MHz	≥40 dB	≥34 dB	A – B1 typically >46 dB to 6 MHz and >40 dB to 10 MHz.
3.58 or 4.43 MHz (Chroma)	≥34 dB	≥34 dB	
Filters			
Luminance	<3 dB down at 1 MHz; ≥40 dB down at 3.58 or 4.43 MHz.		
Low Pass	≥14 dB down at 500 kHz.		Typically –3 dB at 300 kHz.
Chrominance			±1% of flat at 3.58 MHz. –3 dB points: Lower: 2.83 ±0.15 MHz. Upper: 4.33 ±0.15 MHz.
3.58 MHz			
4.43 MHz			±1% of flat at 4.43 MHz. –3 dB points: Lower: 3.68 ±0.15 MHz. Upper: 5.18 ±0.15 MHz.

Table 5-2: Waveform Monitor Vertical System (Cont.)

Characteristics	Performance Requirements	Supplemental Information
Diff Steps (Differentiated Steps Attenuation)	>40 dB at 3.58 MHz (4.43 MHz PAL)	5 step, 20 IRE staircase within 2% of flat display. Vertical Gain increase approximately 5X to compare staircase risers.

Linear Waveform Distortion

Pulse Preshoot, Overshoot, & Ringing	≤1% of applied pulse amplitude.	Typically: <0.5% on T Pulse. <1.0% on T/2 Pulse.
Pulse and Bar	≤1% of applied pulse amplitude.	Typically: <0.5% on T Pulse. <1.0% on T/2 Pulse.
25 μs Bar Tilt	≤1% of applied bar amplitude.	
Field Square Wave Tilt	≤1% of applied square wave amplitude.	Typically <0.5%.
2T Sin ² Pulse-to-Bar Ratio	1:1 ±1%.	

Non-Linear Waveform Distortion

Differential Gain		
Aux Video Out	≤0.25% at 10% – 90% APL.	Waveform Modes.
Pix Mon Out	≤0.25% at 10% – 90% APL.	
Differential Phase		
Aux Video Out	≤0.25° at 10% – 90% APL.	
Pix Mon Out	≤0.25° at 10% – 90% APL.	

Table 5-3: Waveform Monitor Probe Input

Characteristics	Performance Requirements	Supplemental Information
Input Resistance		1 M Ω
Input RC Product		20 μ s (20 pF).
Gain	Unity 3%.	With gain adjusted for equivalent 1 V p-to-p display.
Frequency Response		
25 Hz to 5 MHz	\pm 2%.	From 50 kHz Reference.
5 MHz to 10 MHz	+3% to -5%.	
Tilt	Less than 5% on 50 Hz square wave.	Fast DC restorer eliminates low frequency tilt on a composite video signal.
Probe Calibrator		
Waveform		50% Duty Cycle square wave.
Period		4 horizontal lines.
Output Voltage	1.0 V \pm 0.5% (0.995 V to 1.005 V).	
Impedance Out		\approx 950 Ω .

Table 5-4: Waveform Monitor Horizontal Deflection System

Characteristics	Performance Requirements	Supplemental Information
Sweep Rates & Timing Accuracy	Accuracy over center 10 divisions:	
1 Line (5 μ s/Div.)	\pm 2%.	
2 Line (10 μ s/Div.)	\pm 2%.	
3 Line (15 μ s/Div.)	\pm 2%.	

Table 5-4: Waveform Monitor Horizontal Deflection System (Cont.)

Characteristics	Performance Requirements	Supplemental Information
1 Field Sweep		Displays 1 full field including vertical interval.
2 Field Sweep		Displays 2 full fields and the vertical interval between them. First sweep (left side of CRT) is selectable between odd or even fields.
3 Field Sweep		Displays 3 full fields and the 2 vertical intervals between them. First sweep is selectable between even or odd fields, and third field polarity is the same as that of the first field.
Sweep Linearity		
1 Line (5 μ s/Div.)	$\pm 1\%$.	
2 Line (10 μ s/Div.)	$\pm 1\%$.	
3 Line (15 μ s/Div.)	$\pm 1\%$.	
1 Field Sweep	± 0.5 Division.	
2 Field Sweep	± 0.5 Division.	
3 Field Sweep	± 0.5 Division.	
Slow Sweep	$\pm 5\%$ of full screen over the length of the sweep.	

Table 5-4: Waveform Monitor Horizontal Deflection System (Cont.)

Characteristics	Performance Requirements	Supplemental Information
Magnified Sweep Accuracy		
X5 (1 $\mu\text{s}/\text{Div.}$)	$\pm 1\%$.	Applies to the center 10 divisions of unmagnified sweep. Excludes the first 2 divisions of the magnified display.
X10 (0.5 $\mu\text{s}/\text{Div.}$)	$\pm 2\%$.	
X20 (0.25 $\mu\text{s}/\text{Div.}$)	$\pm 3\%$.	
X25 (0.2 $\mu\text{s}/\text{Div.}$)	$\pm 3\%$.	
X50 (0.1 $\mu\text{s}/\text{Div.}$)	$\pm 3\%$.	
X100 (50 ns/Div.)	$\pm 5\%$.	
Magnified Sweep Linearity		
X5 (1 $\mu\text{s}/\text{Div.}$)	± 1 minor division ($\leq 2\%$).	Applies to the center 10 divisions of unmagnified sweep. Excludes the first 2 divisions of the magnified display.
X10 (0.5 $\mu\text{s}/\text{Div.}$)	± 1 minor division ($\leq 2\%$).	
X20 (0.25 $\mu\text{s}/\text{Div.}$)	± 1 minor division ($\leq 2\%$).	
X25 (0.2 $\mu\text{s}/\text{Div.}$)	± 1 minor division ($\leq 2\%$).	
X50 (0.1 $\mu\text{s}/\text{Div.}$)	± 1 minor division ($\leq 2\%$).	
X100 (50 ns/Div.)	± 1 minor division ($\leq 2\%$).	
Variable Sweep Range	$>20\%$.	Expands sweep around center of sweep.
Slow Sweep Duration		4 to 12 seconds. Front-panel variable control.
Timing Cursor Accuracy	Within 5 ns, any delay within one line (64 μs).	
Line Select		
Range	Full Field.	Waveform monitor and vectorscope may select different lines. CRT alphanumeric identification.
Field Selection	1 of 4 for NTSC or 1 of 8 for PAL. Even or Odd and All Fields.	

Table 5-4: Waveform Monitor Horizontal Deflection System (Cont.)

Characteristics	Performance Requirements	Supplemental Information
RGB/YRGB		
Staircase Input Amplitude	A +10 V input will result in a horizontal display of 9 divisions ± 1.4 major divisions.	Ground to +10 V. +10 V corresponds to left side of the CRT.
Staircase Operating Signal	DC Signal levels plus peak AC, not to exceed -12 to +12 volts.	
Max AC signal volts	12 V peak-to-peak.	Field or line rate sweeps.
Sweep Length RGB		2 Field = 27 – 33% of normal. 1 Line = 27 – 33% of normal. 2 Line = 27 – 33% of normal.
YRGB		2 Field = 20 – 25% of normal. 1 Line = 20 – 25% of normal. 2 Line = 20 – 25% of normal.
Sweep Repetition Rate	Field or line rate of displayed video or external sync signal as selected by front-panel HORIZONTAL controls.	Requires 1H or 1Fld sweep selection.
External Horizontal Input		Used for ICPM measurements.
Sensitivity		Direct coupled 0 – 5 V. Sawtooth input of up to 5 V is nominally a 10 division horizontal sweep.
Input Impedance		$\approx 10 \text{ k}\Omega$.

Table 5-5: Waveform Monitor DG and DP Display

Characteristics	Performance Requirements	Supplemental Information
Differential Gain		
Deflection Factor	5% dG deflects the trace 50 IRE (NTSC) or 500 mV (PAL) $\pm 5\%$.	Waveform gain X1, Var. gain off. Vector gain adjusted to place chroma at compass rose.
Residual dG (10 – 90% APL)	$\leq 0.2\%$, last 90% of trace.	
Calibrated dG		CRT readout.
Resolution	0.1%.	
Accuracy	0.1% $\pm 10\%$ of reading.	
Range	$\pm 5\%$.	
Differential Phase		
Deflection Factor	5° dP deflects the trace 50 IRE (NTSC) or 500 mV (PAL) $\pm 5\%$.	Waveform gain X1, Var. gain off. Vector gain adjusted to place chroma at compass rose.
Residual dP (10 – 90% APL)	$\leq 0.1^\circ$, last 90% of trace.	
Calibrated dP		CRT readout.
Resolution	0.05°.	
Accuracy	$\pm 0.1^\circ$ over any 10° increment. $\pm 0.1^\circ$ over full 360°, Ext. Ref. $\pm 0.2^\circ$ burst lock.	
Range	360°.	

Table 5-5: Waveform Monitor DG and DP Display (Cont.)

Characteristics	Performance Requirements	Supplemental Information
Recursive Filter		
Noise Reduction		≈15 dB signal-to-noise reduction with filter selected. Assumes white noise source.
Cross-Luminance Rejection		≈30 dB with filter selected. 0 dB in dual dP/dG mode.
Unit Sample Response		Settles to within 1 dB in <50 lines with a step in APL. Settles to within 1 dB in <50 frames in line select.
Chrominance Bandwidth		500 kHz ±100 kHz base-band.

Table 5–6: Synchronization

Characteristics	Performance Requirements	Supplemental Information
Sync Input		
Internal		
Ref. Sync Separator	0.2 to 2.0 V peak-to-peak composite video.	Composite video applied to Inputs A, B1, B2, or B3 or probe.
Int. Sync Separator	0.5 to 2.0 V peak-to-peak composite video.	
External		
Black Burst	-14 dB to +6 dB.	Black Burst signal of 0.2 to 5 times amplitude applied to EXT SYNC input.
Composite Sync	0.2 to 8.0 V peak-to-peak.	Composite sync applied to EXT SYNC input locks waveform monitor; vector-scope also requires CW signal.
SCH Modes	286 mV (300 mV PAL) Sync and Burst ± 3 dB.	Composite Video or Black Burst.
Direct Sync		
Horiz. Freq. Range	15.75 kHz ± 1 kHz.	Frequencies much below 15.75 kHz will not permit a normal TV display.
Sync Jitter		
Comp sync or video		≤ 12 ns with respect to input sync.
Variable APL (10–90%)		≤ 20 ns; with the addition of 36 dB white noise ≤ 90 ns.
Noise Immunity		<250 ns jitter, 1 V composite video with -26 dB white noise.

Table 5-6: Synchronization (Cont.)

Characteristics	Performance Requirements	Supplemental Information
AFC Sync		
Horiz. Freq. Range	15.75 kHz \pm 200 Hz.	
Lock-In Time	<1 second.	
Sync Jitter		\leq 10 ns; with the addition of 36 dB white noise, \leq 12 ns.
Comp sync or video		
Variable APL (10-90%)		
Jitter with respect to white noise	\leq 30 ns.	Doubles with each 6 dB increase in white noise.
Noise Immunity		<90 ns jitter, 1 V composite video with -26 dB white noise.
Jitter from missing line sync pulses		<15 ns per missing sync pulse. Maximum of 10 consecutive line sync pulses.
Slow Sweep Triggering		
Signal	APL change from \leq 10% - 90%.	Front panel selectable for either + or - level change.
Sensitivity	0.4 V to 2.0 V peak-to-peak composite video with APL change.	
Rate	\geq 0.2 Hz.	Free runs at rates less than 0.2 Hz or with no triggering signal.

Table 5–6: Synchronization (Cont.)

Characteristics	Performance Requirements	Supplemental Information
Remote Sync		
Amplitude	2.0 to 5.0 V square wave, or 4.0 V composite sync.	Input enabled through rear-panel REMOTE connector.
Input Impedance		1 M Ω .
Frequency		30/60 Hz (NTSC), 25/50 Hz (PAL) square wave will synchronize a 2-field sweep. Remote sync bypasses the sync stripper and field ID circuits.

Table 5–7: Vectorscope Vector Display

Characteristics	Performance Requirements	Supplemental Information
Phase Control		
Digital Phase Shifter Phase Accuracy	$\pm 0.1^\circ$.	(External CW signal.) 0.25 $^\circ$ Burst Lock.
Resolution		0.05 $^\circ$.
Chrominance Bandwidth		F _{SC} (Subcarrier Frequency)
Upper –3 dB Point	F _{SC} +500 kHz, ± 100 kHz.	NTSC – 3.579545 MHz.
Lower –3 dB Point	F _{SC} –500 kHz, ± 100 kHz.	PAL – 4.43361875 MHz.
Chrominance Transient Response		Modulated Sin ² pulse in R–Y Mode.

Table 5-7: Vectorscope Vector Display (Cont.)

Characteristics	Performance Requirements	Supplemental Information
Display		
Vector Phase Accuracy	$\pm 1.25^\circ$.	Measured with color bar signal.
Vector Gain Accuracy		$\pm 2.5\%$ (1.25 IRE).
Quadrature Phasing	$\pm 0.5^\circ$.	
Subcarrier Regenerator		
Pull-In Range (NTSC)	± 50 Hz of F_{SC} .	PAL instruments are tested to 10 Hz, but typically lock to within 50 Hz.
(PAL)	± 10 Hz of F_{SC} .	
Pull-In Time		Within 1 second, with subcarrier frequency within 50 Hz (10 Hz for PAL instruments) of F_{SC} .
Phase Shift with Subcarrier Frequency Change (NTSC)		$\pm 0.5^\circ$ from F_{SC} to ($F_{SC} + 50$ Hz), or F_{SC} to ($F_{SC} - 50$ Hz).
(PAL)		$\pm 0.5^\circ$ from F_{SC} to ($F_{SC} + 10$ Hz), or F_{SC} to ($F_{SC} - 10$ Hz).
Phase Shift with Burst Amplitude Change	$\pm 2^\circ$ from nominal burst amplitude to ± 3 dB.	Internal or External burst reference.
Phase Shift with Input Channel Change	$\pm 2^\circ$.	With EXT REF selected: Channel A to CH B; Channels B1, B2, B3 to one another
Phase Control Range		360° continuous rotation.

Table 5-7: Vectorscope Vector Display (Cont.)

Characteristics	Performance Requirements	Supplemental Information
Vector Display		
Differential Phase		$\leq 1^\circ$.
Differential Gain		$\leq 1\%$. Measured with 140 IRE (1 V) linearity signal with 40 IRE (300 mV) of subcarrier.
Position Control Range		
Horizontal		$\geq 1/4''$ (6 mm) from center.
Vertical		$\geq 1/4''$ (6 mm) from center.
Clamp Stability	1/64'' (0.4 mm) or less.	Center Spot movement with Rotation of PHASE control.
Variable GAIN Range	+14 dB to -6 dB of 75% color bar preset gain.	Unterminated color bar signal can be brought to appropriate targets. Burst from a triple-terminated signal can be moved to the compass rose.
Max Gain		>X5.
Variable GAIN Phase Shift	$\pm 1^\circ$ as gain is varied from +3 dB to -6 dB.	

Table 5–8: Vectorscope XY Display

Characteristics	Performance Requirements	Supplemental Information
Input		DC coupled differential inputs through rear-panel connector.
Input Amplitude	2 to 9 V peak-to-peak.	Adjustable full scale deflection 0 dBm to +12 dBm for 600 Ω system. Factory set to 0 dBm.
Maximum Input Voltage	15 V combined peak signal and DC.	
Frequency Response	DC to >500 kHz.	3 dB point.
X and Y Input Phase Matching	< a trace width of separation at 20 kHz.	Single-ended. Phase matching above 20 kHz may be improved by adjusting Vertical Deflection Amplifier VHF Compensation.

Table 5–9: Vectorscope SCH Phase Display

Characteristics	Performance Requirements	Supplemental Information
Accuracy		
Absolute	$\pm 5^\circ$ phase at 25° C.	
Relative		$\pm 2^\circ$.
Temperature Stability		$\pm 0.1^\circ$ phase/°C.
Acquisition Time	≤ 1 sec.	
Display Phase Error Caused by CRT Geometry Variations		$\pm 1.25^\circ$ calibrated for zero display phase error at zero SCH phase.

Table 5–9: Vectorscope SCH Phase Display (Cont.)

Characteristics	Performance Requirements	Supplemental Information
Input Timing		Stable display with any time relationship between signals on CH A, CH B, and EXT.
Display Range		
Ext Reference	360°.	
Int Reference	±70°.	Typically >80°.

Table 5–10: CRTs and High Voltage Supplies

Characteristics	Performance Requirements	Supplemental Information
Waveform Monitor		
Viewing Area		80 × 100 mm. Horizontal Scale 12.5 Divisions. Vertical Scale 170 IRE (NTSC), 1.19 volts (PAL).
Accelerating Potential		Nominally 20 kV.
Orthogonality		±1°.
Trace Rotation Range	≥±1° from horizontal.	Typical adjustment range is ≈8°.
Vectorscope		
Viewing Area		80 × 100 mm.
Accelerating Potential		Nominally 13.75 kV.
Orthogonality		±1°.

Table 5–11: Power Requirements

Characteristics	Performance Requirements	Supplemental Information
Mains Voltage Ranges		
110 VAC	90 – 132 V.	Selected by rear-panel switch.
220 VAC	200 – 250 V.	
Mains Frequency Range	48 – 66 Hz.	
Crest Factor		≥1.3.
Power Consumption	120 Watts maximum.	

Table 5–12: Physical Characteristics

Characteristics	Supplemental Information
Dimensions	
Height	5 1/4 inches (133.4 mm).
Width	19 inches (483 mm).
Length	18 inches (460 mm).
Net Weight	Approximately 28 lbs (approximately 12.7 kg).
Shipping Weight	Approximately 45 lbs (approximately 20.1 kg).

Table 5-13: Environmental Summary

Characteristics	Supplemental Information
Temperature	
Operating	0° C to +50° C.
Non-Operating	-55° C to +75° C.
Altitude	
Operating	To 2 km maximum.
Vibration	
Operating	0.015 inch (0.38 mm) peak-to-peak 10 –55 Hz, 75 minutes total.
Shock	
Non-Operating	30 g acceleration 3 times each major axis. 11 ms halfsine.
Bench Handling	4 inch drop to table top on each of the four bottom corners.
Transportation	
Vibration	Qualified under National Safe Transit Association (NSTA) Test Procedure 1A-B-1.
Drop Test	Qualified under NSTA Test Procedure 1A-B-2.
Humidity	90 to 95% Noncondensing.
Equipment Type	Test and measurement
Safety Class	Class I (as defined in IEC 1010-1, Annex H) – grounded product
Overvoltage Category	Overvoltage Category II (as defined in IEC 1010-1, Annex J).
Pollution Degree	Pollution Degree 2 (as defined in IEC 1010-1). Note: rated for indoor use only.

Table 5–14: Certifications and compliances

<p>EC Declaration of Conformity – EMC ¹</p>	<p>Meets intent of Directive 89/336/EEC for Electromagnetic Compatibility. Compliance was demonstrated to the following specifications as listed in the Official Journal of the European Communities:</p> <p>EN 50081-1 Emissions: EN 55022 Class B Radiated and Conducted Emissions</p> <p>EN 50082-1 Immunity: IEC 801-2 Electrostatic Discharge Immunity IEC 801-3 RF Electromagnetic Field Immunity IEC 801-4 Electrical Fast Transient/Burst Immunity</p> <p>¹ High-quality shielded cables must be used to ensure compliance to the above listed standards. This product complies when installed into any of the following Tektronix instrument enclosures: 1700F00 Standard Cabinet 1700F02 Portable Cabinet 1700F05 Rack Adapter</p>
<p>FCC Compliance</p>	<p>Emissions comply with FCC Code of Federal Regulations 47, Part 15, Subpart B, Class A Limits</p>
<p>Installation (Overvoltage) Category</p>	<p>Terminals on this product may have different installation (overvoltage) category designations. The installation categories are:</p> <p>CAT III Distribution-level mains (usually permanently connected). Equipment at this level is typically in a fixed industrial location.</p> <p>CAT II Local-level mains (wall sockets). Equipment at this level includes appliances, portable tools, and similar products. Equipment is usually cord-connected.</p> <p>CAT I Secondary (signal level) or battery operated circuits of electronic equipment.</p>
<p>Pollution Degree</p>	<p>A measure of the contaminates that could occur in the environment around and within a product. Typically the internal environment inside a product is considered to be the same as the external. Products should be used only in the environment for which they are rated.</p>

Table 5–14: Certifications and compliances (Cont.)

	<p>Pollution Degree 1 No pollution or only dry, nonconductive pollution occurs. Products in this category are generally encapsulated, hermetically sealed, or located in clean rooms.</p> <p>Pollution Degree 2 Normally only dry, nonconductive pollution occurs. Occasionally a temporary conductivity that is caused by condensation must be expected. This location is a typical office/home environment. Temporary condensation occurs only when the product is out of service.</p> <p>Pollution Degree 3 Conductive pollution, or dry, nonconductive pollution that becomes conductive due to condensation. These are sheltered locations where neither temperature nor humidity is controlled. The area is protected from direct sunshine, rain, or direct wind.</p> <p>Pollution Degree 4 Pollution that generates persistent conductivity through conductive dust, rain, or snow. Typical outdoor locations.</p>
Safety Standards	
U.S.Nationally Recognized Testing Laboratory Listing	UL1244 Standard for electrical and electronic measuring and test equipment.
Canadian Certification	CAN/CSA C22.2 No. 231 CSA safety requirements for electrical and electronic measuring and test equipment.
European Union Compliance	Low Voltage Directive 73/23/EEC, amended by 93/69/EEC EN 61010-1 Safety requirements for electrical equipment for measurement, control, and laboratory use.
Additional Compliance	IEC61010-1 Safety requirements for electrical equipment for measurement, control, and laboratory use.
Safety Certification Compliance	
Temperature, operating	+5 to +40° C

Table 5–14: Certifications and compliances (Cont.)

Altitude (maximum operating)	2000 meters
Equipment Type	Test and measuring
Safety Class	Class 1 (as defined in IEC 1010-1, Annex H) – grounded product
Overvoltage Category	Overvoltage Category II (as defined in IEC 1010-1, Annex J)
Pollution Degree	Pollution Degree 2 (as defined in IEC 1010-1). Note: Rated for indoor use only.



Options and Accessories

Options and Accessories

Options

The Power Cord options are the only currently available options for purchase with the 1780R-Series. Part numbers are listed below.

Accessories

Standard Accessories

The following accessories are shipped with the 1780R-Series.

Qty	Tek Part Number	Description
1	070-6890-XX	1780R-Series Operator's Manual
3	150-1136-00	Graticule Lamp, Incandescent
1	159-0023-00	Replacement Cartridge Fuse, 2 A Slow, 250V
1	331-0519-00	Graticule, 511-1979, Visual 102 (1780R ONLY)
1	331-0520-00	Graticule, 511-1979, Photographic (1780R ONLY)
1	331-0523-00	Graticule, K-Factor, Visual (1781R ONLY)
1	331-0524-00	Graticule, K-Factor, Photographic (1781R ONLY)
1	378-0337-00	Filter, Air
1	390-1039-00	Cabinet, Wraparound

One of the following cables is shipped with each instrument:

Qty	Tek Part Number	Description
1	161-0216-00	Cable, Power
1	161-0066-09	Cable, Power (Option A1, 220 V Euro)
1	161-0066-10	Cable, Power (Option A2, 240 V, UK)
1	161-0066-11	Cable, Power (Option A3, 240 V, Aust)

Optional Accessories

The following is a list of the most common accessory items for the 1780R-Series.

Description	Tek Part Number
1780R-Series Service Manual	070-8030-XX
Extender Kit for Oscillator & Z-Axis Circuit Boards	016-1011-00
Viewing Hood	016-0475-00
Portable Cabinet	1780F02
Rack-Mount Shelf	1780F05



Index

Index

A

- Absolute units (mV / IRE), 3–54
- Accessories, 6–1
- Adjustments
 - Calibrator amplitude (zero set), 3–45
 - External horizontal gain (waveform), 3–46
 - Gain (vector), 3–46, 3–49
 - Horizontal gain (waveform), 3–45
 - Horizontal position control calibration, 3–43
 - Readout intensity (vector), 3–46, 3–51
 - Readout intensity (waveform), 3–43
 - Scale illumination, 2–3, 3–6
 - Trace rotation (waveform), 3–43
 - Vertical gain (waveform), 3–45
 - Voltage cursors (zero set), 3–45
- Air filter (fan), 6–1
- Audio feedback, 2–2
- Audio input (XY INPUT) connector, 3–10
- AUX filter, 2–14
- AUX IN connector, 2–16
- AUX OUT connector, 2–16
- Auxiliary input, 2–14, 2–16

B

- Baud rates, 3–20, 3–55
- Beep, 2–2, 3–55, 3–57
- Bowtie measurement, 4–33

C

- Cabinet, portable (optional accessory), 6–2
- CAL OUT, probe, 2–9
- Calibrate menu, 2–8, 3–42
 - Password access, 3–43, 3–46, 3–49
 - Selecting vectorscope / waveform calibration, 3–42
 - Vectorscope calibration procedure, 3–46
 - Waveform calibration procedure, 3–43
- Calibrator amplitude
 - Fixed, 3–30, 3–53
 - Variable, 3–29
 - Zero set, 3–45
- Calibrator signal, vector (on / off), 3–46, 3–51
- Calibrator signal, waveform (on / off), 3–42
- Chroma-to-Luma inequalities, 4–23
 - Lissajous display, 3–9, 4–27
- Chrominance filter, 2–14
- Clamp (sync tip / back porch), 3–53
- Color bar amplitude (75% / 100%), 3–54
- Color framing, 3–22
- Communication, serial remote (RS232D, RS422A), 3–18
- Companion switches, 2–1, 2–9
- Configure menu, 2–8, 3–52
 - Toggleing between pages, 3–52

Coupling (AC / DC / GND), 3–53

CRT controls, 2–1, 2–3

Cursors

Time, 2–5, 3–1

Set interval, 3–45

Voltage, 2–6, 3–2

Units (mV / IRE), 3–54

Zero set, 3–45

CW connector, 2–16

CW reference, 2–12, 3–55

D

DC level measurements, 3–24

DC restorer (slow / fast / off), 3–53

Dead zone, 3–43

Differential gain measurement,
3–9, 4–7

Differential phase and gain mea-
surement, 4–12

Differential phase measurement,
3–9, 4–2

Differentiated step filter, 2–14

Disable the beep, 2–2

Disable the password, 3–34

E

Enable the password, 3–34

Extender board kit for Oscillator
and Z–Axis circuit boards, 6–2

External horizontal

Connector, 2–18

Gain, 3–45

Input, 3–42

External reference, 2–12, 2–16,
3–55

F

F_{SC} time marks measurement, 4–36

Fan filter (standard accessory), 6–1

Field trigger (F1 / F2), 3–53

Filter, 2–14

Air, 6–1

AUX, 2–14

Chrominance, 2–14

Differentiated step, 2–14

Flat, 2–14

Low–pass, 2–14

Luminance, 2–14

Flat filter, 2–14

Focus control, 2–3

Front panel controls, 2–3

Knob assignment timeout (ON /
OFF), 3–55

Fuse, replacement, 6–1

G

Gain

External horizontal (waveform),
3–42

Horizontal (waveform), 3–45

Vector, 3–46

Vertical (waveform), 3–45

Gain control (vector), 2–14

Gain control (waveform), 2–14

Ghost–cancelling, 3–3

Graticules, 3–6

Diff gain and diff phase graticule
scales, 3–9

Part numbers, 6–1

Replacement lamps, 6–1

Vector

NTSC, 3–6
 PAL, 3–7
 Waveform
 NTSC, 3–12
 PAL, 3–12
 XY graticule scale, 3–9

H

Hold for function switches, 2–1
 Horizontal gain adjustment
 (waveform), 3–45
 Horizontal position control, 2–5
 Horizontal position control calibration, 3–43
 How to...
 Adjust calibrator amplitude (zero set), 3–45
 Adjust external horizontal gain (waveform), 3–45
 Adjust horizontal gain (waveform), 3–45
 Adjust readout intensity (vector), 3–46
 Adjust readout intensity (waveform), 3–43
 Adjust scale illumination, 3–6
 Adjust trace rotation (vector), 3–46
 Adjust trace rotation (waveform), 3–43
 Calibrate the horizontal position control, 3–43
 Change the password, 3–35
 Enable /disable the password, 3–34
 Enter / exit a menu, 4–1
 Recall initial settings, 3–37
 Recall preset settings, 3–36
 Recover a saved instrument configuration, 3–37

Store a new preset, 3–15, 3–39
 Use the password, 3–35
 Zero set voltage cursors, 3–45

I

Incidental Carrier Phase Modulation (ICPM), 4–17
 System (B/G or I), 3–53
 Zero carrier, 4–18
 Incorrect password, 3–35
 Input channel connectors, 2–16
 Input channel switches, 2–15
 Inputs (AC /DC coupled), 3–53
 Intensity control, 2–3
 Internal reference, 2–12, 3–55

K

K Factor measurement, 4–20

L

Large knob (precision measurement control), 2–5, 2–7, 3–6
 Associated switches
 buttons, 2–5, 2–7, 3–6
 Line select, 3–3
 Phase shift, 2–7, 3–5
 Reference set, 2–7, 3–1, 3–5
 Time cursors, 2–5, 3–1, 3–45
 Voltage cursors, 2–6, 3–2, 3–45, 3–54
 LINE / FIELD switch, 2–12
 Line select, 3–3
 In diff gain, 4–10
 In diff phase, 4–6
 Timing cursors in, 2–5
 Line-select, 2–6
 Line-time distortion, 3–13

Low-pass filter, 2-14
Luminance filter, 2-14

M

Magnifier, 2-12
Measurement menu
 Bowtie, 4-33
 Chrominance-to-luminance
 inequalities, 4-23
 Diff phase and diff gain, 4-12
 Differential gain, 4-7
 Differential phase, 4-2
 FSC time marks, 4-36
 General measurement informa-
 tion, 2-8, 3-56, 4-1
 Incidental Carrier Phase Modula-
 tion (ICPM), 2-7, 3-5, 4-17
 K Factor, 4-20
 Noise, 4-16
 R-Y sweep, 4-31
 Short-Time Distortion, 4-28
Menu access, 2-8, 3-32
Menus
 Calibrate, 2-8, 3-42
 Configure, 2-8, 3-52
 Toggling between pages, 3-52
 General menu information, 3-31
 Measure, 2-8, 3-31, 3-56, 4-1
 Preset, 2-8, 3-31, 3-36

N

Noise measurement, 4-16
Noise reduction, 4-4, 4-7, 4-12

O

OFF < switch, 2-13
Offsets (overlay mode), 3-26
Offsets (parade mode), 3-23
ON > switch, 2-12
ONE / TWO / THREE switch,
 2-12
Options, 6-1
Oscillator, 3-46, 3-51
Overlaid, 4-18
Overlay mode, 2-11, 3-26

P

Parade mode, 2-11, 3-23
PARADE/OVERLAY switch, 2-11
Password, 3-34
 Change, 3-35
 Define, 3-34
 Enable / disable, 3-34
 Incorrect, 3-35
Phase display (180 / 360), 3-54
Phase shift, 2-5, 3-5
Picture monitor output
 Bright-up pulse, 2-16
 Front-panel switch, 2-11
 Rear panel connector, 2-16
Power cord options, 6-2
Power switch, 2-3
Precision measurement control
 (large knob), 2-5
Preset menu, 2-8, 3-36
 Recall, 3-15, 3-36
 Recover, 3-38
 Rename, 3-40
 Store, 3-39
Probe, 2-9
Probe (X1 / X10), 3-54
Push and hold switches, 2-1

R

- Readout (ON / OFF), 3–55
- Readout intensity adjustment (vectorscope), 3–46
- Readout intensity adjustment (waveform), 3–43
- Rear panel connectors, 2–16
- Recall a preset, 3–36
- Recall initial settings, 3–37
- Recover function, 3–37
- Reference switch (INT / EXT / CW), 2–12
- Remote connector, 2–18, 3–15
- Remote control, 3–15
- Rename a preset, 3–40
- RS232, 3–18
- RS422, 3–18
- RY sweep measurement, 4–31

S

- Scale illumination adjustment, 2–3, 3–6
- Scale illumination control, 2–3, 3–6
- SCH phase measurement, 3–22
- Serial communications, 3–18
- Serial port, 2–18, 3–18
- Serial Remote Information, 3–19
- Service, Extender board kit, 6–2
- Setup (YES/NO), 3–54
- Short–Time Distortion measurement (SD), 4–28
- Slow sweep trigger, 3–55
- Software version (displayed), 3–55
- Sweep rate control, 2–13
- Sync (AFC or direct), 3–53
- System (B/G or I), 3–53

T

- Time cursors, 2–5, 3–1
 - In line select, 2–6
 - Set interval, 3–45
- Touch screen, 2–2, 3–32
 - Quadrants, 3–32
- Trace rotation adjustment (vectorscope), 3–46
- Trace rotation adjustment (waveform), 3–43

V

- VAR / MAX switch, 2–14
- VAR / SLOW switch, 2–13
- VAR / X5 switch, 2–13
- Variable gain, 2–13
- VECT / SCH switch, 2–11
- Vector display (PAL / +V), 3–53
- Vector graticule scale, 3–6
- Version, 3–55
- Vertical gain adjustment (waveform), 3–45
- Vertical position control, 2–5
- Viewing hood (optional accessory), 6–2
- Voltage cursors, 2–6, 3–2
 - Units (mV / IRE), 3–54
 - Zero set, 3–45

W

- Waveform graticule scale, 3–12
- WFM / WFM+CAL switch, 2–12
- WFM+CAL mode, 2–12, 3–27

X

- X–Y input, 2–16
- XY / PIX switch, 2–11
- XY graticule scale, 3–9

Z

- Zero carrier (ICPM), 4–18
- Zero set
 - Calibrator amplitude, 3–45
 - Phase shift (reference set), 2–7
 - Voltage cursors, 3–45