



**Tektronix
National Marketing Center**
for Product Order Information, contact
your local Tektronix sales representative
or, in the U.S., call

1-800-426-2200 ext 41

In Oregon call collect (503)627-9000 ext 41
Tektronix National Marketing Center
P.O. Box 500 D/S Y6-088, Beaverton, OR 97077

**PLEASE CHECK FOR CHANGE INFORMATION
AT THE REAR OF THIS MANUAL.**

2215A OSCILLOSCOPE OPERATORS

INSTRUCTION MANUAL

**Tektronix, Inc.
P.O. Box 500
Beaverton, Oregon 97077**


070-4732-00
Product Group 46

Serial Number _____

First Printing SEP 1983
Revised JAN 1985

Copyright © 1983 Tektronix, Inc. All rights reserved.
Contents of this publication may not be reproduced in any
form without the written permission of Tektronix, Inc.

Products of Tektronix, Inc. and its subsidiaries are covered
by U.S. and foreign patents and/or pending patents.

TEKTRONIX, TEK, SCOPE-MOBILE, and  are
registered trademarks of Tektronix, Inc. TELEQUIPMENT
is a registered trademark of Tektronix U.K. Limited.

Printed in U.S.A. Specification and price change privileges
are reserved.

INSTRUMENT SERIAL NUMBERS

Each instrument has a serial number on a panel insert, tag,
or stamped on the chassis. The first number or letter
designates the country of manufacture. The last five digits
of the serial number are assigned sequentially and are
unique to each instrument. Those manufactured in the
United States have six unique digits. The country of
manufacture is identified as follows:

B000000	Tektronix, Inc., Beaverton, Oregon, USA
100000	Tektronix Guernsey, Ltd., Channel Islands
200000	Tektronix United Kingdom, Ltd., London
300000	Sony/Tektronix, Japan
700000	Tektronix Holland, NV, Heerenveen, The Netherlands

TABLE OF CONTENTS

	Page		Page
LIST OF ILLUSTRATIONS	ii	Section 3 OPERATORS FAMILIARIZATION (cont)	
LIST OF TABLES	ii	OPERATOR'S ADJUSTMENTS	3-3
OPERATORS SAFETY SUMMARY	iii	INTRODUCTION	3-3
Section 1 GENERAL INFORMATION		BASELINE TRACE	3-3
INTRODUCTION	1-1	TRACE ROTATION	3-3
SPECIFICATION	1-1	PROBE COMPENSATION	3-4
CALIBRATION	1-9		
REPACKAGING FOR SHIPMENT	1-9	Section 4 OPERATING PROCEDURES	
		BASIC APPLICATIONS	4-1
Section 2 PREPARATION FOR USE		INTRODUCTION	4-1
FIRST-TIME START UP	2-1	INDEX TO BASIC APPLICATION	
SAFETY	2-1	PROCEDURES	4-1
LINE VOLTAGE	2-1	VOLTAGE MEASUREMENTS	4-1
POWER CORD	2-1	NONDELAYED TIME	
LINE FUSE	2-1	MEASUREMENTS	4-4
INSTRUMENT COOLING	2-2	TELEVISION DISPLAYS	4-8
CONTROLS, CONNECTORS, AND		DELAYED-SWEEP	
INDICATORS	2-3	MAGNIFICATION	4-8
DISPLAY, POWER, AND PROBE		DELAYED-SWEEP TIME	
ADJUST	2-3	MEASUREMENTS	4-10
VERTICAL	2-4		
HORIZONTAL	2-5	Section 5 OPTIONS AND ACCESSORIES	
TRIGGER	2-6	INTRODUCTION	5-1
REAR PANEL	2-8	OPTIONS	5-1
		INTERNATIONAL POWER CORDS	5-1
Section 3 OPERATORS FAMILIARIZATION		STANDARD ACCESSORIES	5-1
GENERAL OPERATING		OPTIONAL ACCESSORIES	5-1
INFORMATION	3-1		
GRATICULE	3-1	FRONT PANEL ILLUSTRATION	
GROUNDING	3-1		
SIGNAL CONNECTIONS	3-1	CHANGE INFORMATION	
INPUT COUPLING CAPACITOR			
PRECHARGING	3-1		

LIST OF ILLUSTRATIONS

Figure		Page
	The 2215A Oscilloscope	iv
1-1	Maximum input voltage vs frequency derating curve for CH 1 OR X, CH 2 OR Y, and EXT INPUT connectors ..	1-7
1-2	Physical dimensions of the 2215A Oscilloscope	1-8
2-1	Optional power cords	2-1
2-2	Fuse holder and power cord connector	2-2
2-3	Power and display controls and indicators and PROBE ADJUST output	2-3
2-4	Vertical controls and connectors	2-4
2-5	Horizontal controls	2-5
2-6	Trigger controls, connector, and indicator	2-6
2-7	Rear panel connector	2-7
3-1	Graticule measurement markings	3-1
3-2	Probe compensation	3-4
4-1	Peak-to-peak waveform voltage	4-2
4-2	Instantaneous voltage measurement	4-3
4-3	Common-mode rejection	4-4
4-4	Voltage ratios	4-4
4-5	Time Duration	4-5
4-6	Rise Time	4-6
4-7	Time difference between pulses on time-related signals	4-6
4-8	Phase difference	4-7
4-9	High-resolution phase difference	4-8
4-10	Delayed-sweep magnification	4-9
4-11	Pulse jitter	4-10
4-12	Time difference on single waveform	4-11
4-13	B DELAY TIME POSITION control settings	4-11
4-14	Rise time, differential time method	4-12
4-15	Time difference between two pulses on two time-related signals	4-13

LIST OF TABLES

Table		Page
1-1	Electrical Characteristics	1-2
1-2	Environmental Characteristics	1-6
1-3	Physical Characteristics	1-7
2-1	VERT MODE Trigger Source	2-7

OPERATORS SAFETY SUMMARY

The general safety information in this part of the summary is for both operating and servicing personnel. Specific warnings and cautions will be found throughout the manual where they apply and do not appear in this summary.

Terms in This Manual

CAUTION statements identify conditions or practices that could result in damage to the equipment or other property.

WARNING statements identify conditions or practices that could result in personal injury or loss of life.

Terms as Marked on Equipment

CAUTION indicates a personal injury hazard not immediately accessible as one reads the markings, or a hazard to property, including the equipment itself.

DANGER indicates a personal injury hazard immediately accessible as one reads the marking.

Symbols in This Manual



This symbol indicates where applicable cautionary or other information is to be found. For maximum input voltage see Table 1-1.

Symbols As Marked on Equipment



DANGER — High voltage.



Protective ground (earth) terminal.



ATTENTION — Refer to manual.

Power Source

This product is intended to operate from a power source that does not apply more than 250 volts rms between the supply conductors or between either supply conductor and ground. A protective ground connection by way of the grounding conductor in the power cord is essential for safe operation.

Grounding the Product

This product is grounded through the grounding conductor of the power cord. To avoid electrical shock, plug the power cord into a properly wired receptacle before connecting to the product input or output terminals. A protective ground connection by way of the grounding conductor in the power cord is essential for safe operation.

Danger Arising From Loss of Ground

Upon loss of the protective-ground connection, all accessible conductive parts (including knobs and controls that may appear to be insulating) can render an electric shock.

Use the Proper Power Cord

Use only the power cord and connector specified for your product.

Use only a power cord that is in good condition.

For detailed information on power cords and connectors see Figure 2-1.

Use the Proper Fuse

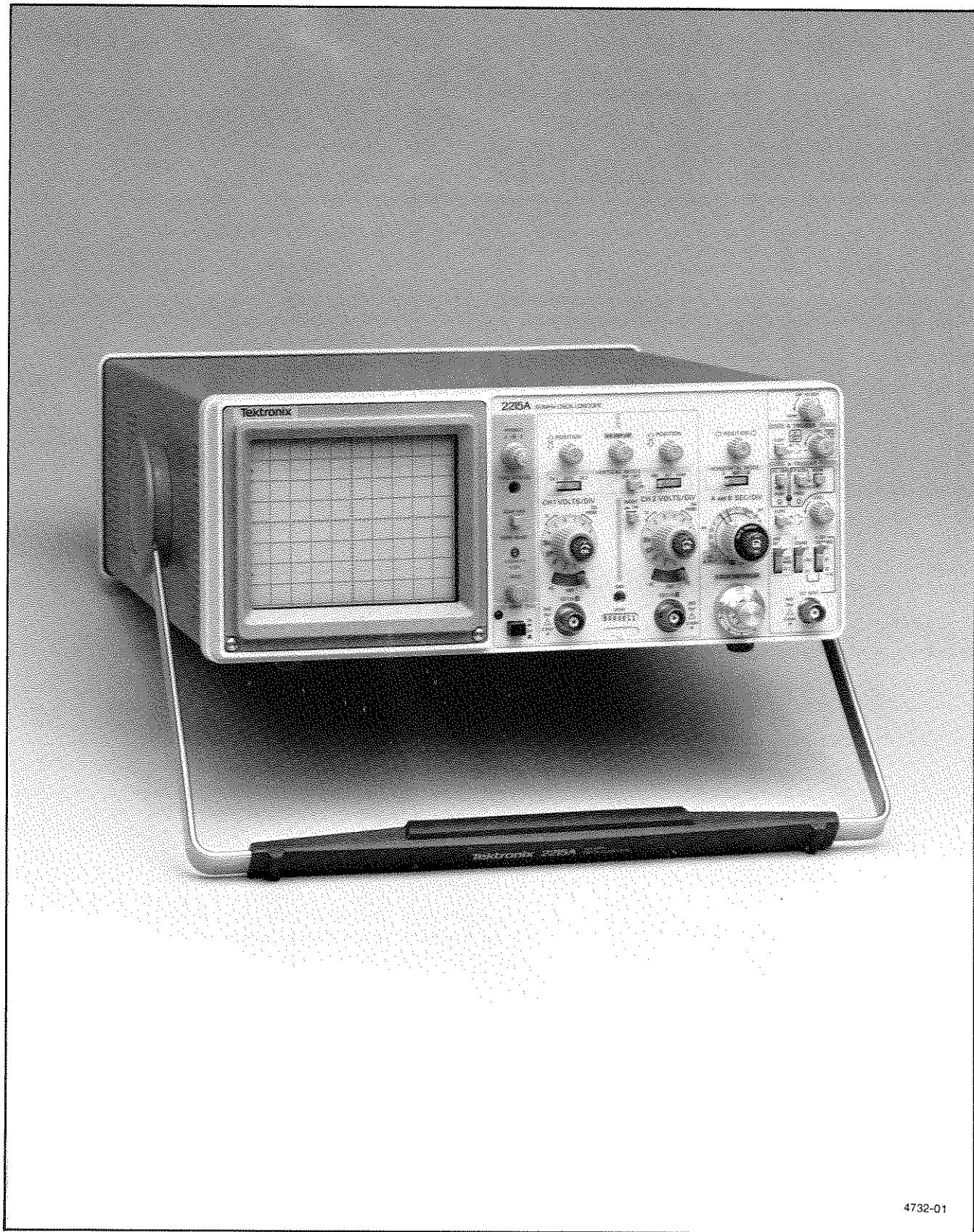
To avoid fire hazard, use only a fuse of the correct type, voltage rating and current rating as specified in the parts list for your product.

Do Not Operate in Explosive Atmospheres

To avoid explosion, do not operate this product in an explosive atmosphere unless it has been specifically certified for such operation.

Do Not Remove Covers or Panels

To avoid personal injury, do not remove the product covers or panels. Do not operate the product without the covers and panels properly installed.



4732-01

The 2215A Oscilloscope.

GENERAL INFORMATION

INTRODUCTION

The TEKTRONIX 2215A Oscilloscope is a rugged, lightweight, dual-channel 60-MHz instrument that features a bright, sharply defined trace on an 80- by 100-mm cathode-ray tube (crt). Its vertical system supplies calibrated deflection factors from 2 mV per division to 5 V per division. Trigger circuits enable stable triggering over the full bandwidth of the vertical system. The horizontal system provides calibrated sweep speeds from 0.5 s per division to 50 ns per division, along with delayed-sweep features. A X10 magnifier circuit extends the maximum sweep speed to 5 ns per division when the A and B SEC/DIV switch is set to 0.05 μ s per division.

The instrument is shipped with the following standard accessories:

1 Operators manual	2 Probe packages
1 Power cord	

For part numbers and information about instrument accessories, refer to the "Options and Accessories" section of this manual.

The service manual and all other optional accessories are orderable from Tektronix, Inc. A local Tektronix Field Office, representative, or the Tektronix product catalog can provide ordering and product information.

SPECIFICATION

The following electrical characteristics (Table 1-1) are valid for the 2215A when it has been adjusted at an ambient temperature between +20°C and +30°C, has had a warm-up period of at least 20 minutes, and is operating at an ambient temperature between 0°C and +50°C (unless otherwise noted).

Items listed in the "Performance Requirements" column are verifiable qualitative or quantitative limits, while items listed in the "Supplemental Information" column are either

explanatory notes, calibration setup descriptions, performance characteristics for which no absolute limits are specified, or characteristics that are impractical to check.

Environmental characteristics are given in Table 1-2. The 2215A meets the requirements of MIL-T-28800C, paragraphs 4.5.5.1.3, 4.5.5.1.4, and 4.5.5.1.2.2 for type III, Class 5 equipment, except where otherwise noted.

Physical characteristics of the instrument are listed in Table 1-3.

Table 1-1
Electrical Characteristics


Characteristics	Performance Requirements	Supplemental Information
VERTICAL DEFLECTION SYSTEM		
Deflection Factor		5 mV per division to 5 V per division gain is adjusted with VOLTS/DIV switch set to 10 mV per division. 2 mV per division gain is adjusted with VOLTS/DIV switch set to 2 mV per division.
Range	2 mV per division to 5 V per division in a 1-2-5 sequence.	
Accuracy	±3%	
Range of VOLTS/DIV Variable Control	Continuously variable between settings. Increases deflection factor by at least 2.5 to 1.	
Step Response Rise Time		Rise time is calculated from the formula: $\frac{0.35}{\text{Bandwidth } (-3 \text{ dB})}$
Rise Time		
0°C to +35°C		
5 mV per Division to 5 V per Division	5.8 ns or less.	
0°C to +50°C		
2 mV per Division to 5 V per Division	7.0 ns or less.	
Bandwidth (-3 dB)		Measured with a vertically centered 6-division reference signal from a 50 Ω source driving a 50 Ω coaxial cable that is terminated in 50 Ω, both at the input connector and at the probe input, with the VOLTS/DIV Variable control in the CAL detent.
0°C to +35°C		
2 mV per Division	Dc to at least 50 MHz.	
5 mV per Division to 5 V per Division	Dc to at least 60 MHz.	
0°C to +50°C		
2 mV per Division to 5 V per Division	Dc to at least 50 MHz.	
AC Coupled Lower Limit	10 Hz or less at -3 dB.	
Bandwidth Limiter	Upper limits (-3 dB) bandpass at 10 MHz ±15%.	
Chop Mode Switching Rate	500 kHz ±30%.	
Input Characteristics		
Resistance	1 MΩ ±2%.	
Capacitance	20 pF ±2 pF.	
Maximum Safe Input Voltage 		See Figure 1-1 for derating curve.
DC Coupled	400 V (dc + peak ac) or 800 V ac p-p to 10 kHz or less.	
AC Coupled	400 V (dc + peak ac) or 800 V ac p-p to 10 kHz or less.	

Table 1-1 (cont)


Characteristics	Performance Requirements	Supplemental Information		
VERTICAL DEFLECTION SYSTEM				
Common-Mode Rejection Ratio (CMRR)	At least 10 to 1 at 25 MHz.	Checked at 10 mV per division for common-mode signals of 6 divisions or less with VOLTS/DIV Variable control adjusted for best CMRR at 50 kHz.		
Trace Shift with Attenuator Rotation	0.75 division or less.	VOLTS/DIV Variable control in CAL detent.		
Trace Shift as VOLTS/DIV Variable Control is Rotated	1.0 division or less.			
Trace Shift with Invert	1.5 division or less.			
Channel Isolation	Greater than 100 to 1 at 25 MHz.			
TRIGGER SYSTEM				
A TRIGGER Sensitivity P-P AUTO and NORM/TV LINE Modes		External trigger signal from a 50 Ω source driving a 50 Ω coaxial cable terminated in 50 Ω at the input connector.		
			5 MHz	60 MHz
	Internal		0.3 div	1.0 div
	External		40 mV	150 mV
Lowest Useable Frequency in P-P AUTO Mode	20 Hz with 1.0 division internal or 100 mV external.			
TV FIELD Mode	1.0 division of composite sync.			
B TRIGGER Sensitivity (Internal Only)	10 MHz	60 MHz		
	0.4 div	1.5 div		
EXT INPUT				
Maximum Input Voltage 	400 V (dc + peak ac) or 800 V ac p-p at 10 kHz or less.			
Input Resistance	1 M Ω \pm 2%.			
Input Capacitance	20 pF \pm 2.5 pF.			
AC Coupled	10 Hz or less at lower -3 dB point.			
LEVEL Control Range				
A TRIGGER (NORM)				
INT	Can be set to any point of the trace that can be displayed.			
EXT, DC	At least \pm 1.6 V, 3.2 V p-p.			
EXT, DC \div 10	At least \pm 16 V, 32 V p-p.			
B TRIGGER				
Internal	Can be set to any point of the trace that can be displayed.			
VAR HOLDOFF Control	Increases A Sweep holdoff time by at least a factor of 10.			

Table 1-1 (cont)

Characteristics	Performance Requirements		Supplemental Information
HORIZONTAL DEFLECTION SYSTEM			
Sweep Rate			
Calibrated Range			
A Sweep	0.5 s per division to 0.05 μ s per division in a 1-2-5 sequence. X10 magnifier extends maximum sweep speed to 5 ns per division.		
B Sweep	50 ms per division to 0.05 μ s per division in a 1-2-5 sequence. X10 magnifier extends maximum sweep speed to 5 ns per division.		
Accuracy	Unmagnified	Magnified	Sweep accuracy applies over the center 8 divisions. Exclude the first 25 ns of the sweep for magnified sweep speeds and anything beyond the 100th magnified division.
+15°C to +35°C	±3%	±4%	
0°C to +50°C	±4%	±5%	
POSITION Control Range	Start of sweep to 10th division in X1 or 100th divisions in X10 will position past the center vertical graticule line.		
Sweep Linearity	±7%.		Linearity measured over any 2 of the center 8 divisions. With magnifier in X10, exclude the first 25 ns and anything past the 100th division.
Variable Control Range	Continuously variable between calibrated settings. Extends the A and B sweep speeds by at least a factor of 2.5.		
Delay Time	Applies to 0.5 μ s per division and slower.		Delay time is functional but not calibrated at sweep settings above 0.5 μ s per division.
Dial Control Range	<0.5 + 300 ns to >10 divisions.		
Jitter	One part or less in 20,000 (0.005%) of the maximum available delay time.		
Differential Time Measurement Accuracy			Exclude delayed operation when A and B SEC/DIV knobs are locked together at any sweep speed or when A SEC/DIV switch is at 0.5 μ s per division or faster. Accuracy applies over the B DELAY TIME POSITION control range.
+15°C to +35°C	±1% +0.015 major dial division		
0°C to +50°C	±2% +0.015 major dial division.		

Table 1-1 (cont)

Characteristics	Performance Requirements	Supplemental Information
X-Y OPERATION (X1 MAGNIFICATION)		
Deflection Factors	Same as Vertical Deflection System (with VOLTS/DIV Variable controls in CAL detent).	
Accuracy		Measured with a dc-coupled, 5-division reference signal.
X-Axis	$\pm 4\%$.	
Y-Axis	Same as Vertical Deflection System.	
Bandwidth (-3 dB)		Measured with a 5-division reference signal.
X-Axis	Dc to at least 2 MHz.	
Y-Axis	Same as Vertical Deflection System.	
Phase Difference Between X- and Y-Axis Amplifiers	$\pm 3^\circ$ from dc to 100 kHz.	With dc-coupled inputs.
PROBE ADJUST		
Output Voltage of PROBE ADJUST Jack	0.5 V $\pm 5\%$.	
Repetition Rate	1 kHz $\pm 20\%$.	
Z-AXIS INPUT		
Sensitivity	5 V causes noticeable modulation. Positive-going input decreases intensity.	Useable frequency range is dc to 10 MHz.
Maximum Safe Input Voltage	30 V (dc + peak ac) or 30 V p-p ac at 1 kHz or less.	
Input Resistance	10 k Ω $\pm 10\%$.	
POWER SOURCE		
Line Voltage Ranges	90 V to 250 V.	
Line Frequency	48 Hz to 440 Hz.	
Maximum Power Consumption	40 W (70 VA).	
Line Fuse	1.0 A, 250 V, slow-blow.	
CATHODE-RAY TUBE		
Display Area	80 by 100 mm.	
Standard Phosphor	P31.	
Nominal Accelerating Voltage	14 kV.	

**Table 1-2
Environmental Characteristics**

Characteristics	Description
	NOTE <i>The instrument meets the requirements of MIL-T-28800C, paragraphs 4.5.5.1.3, 4.5.5.1.4, and 4.5.5.1.2.2 for Type III, Class 5 equipment, except where otherwise noted.</i>
Temperature	
Operating	0°C to +50°C (+32°F to +122°F).
Nonoperating	–55°C to +75°C (–67°F to +167°F). Tested to MIL-T-28800C paragraphs 4.5.5.1.3 and 4.5.5.1.4, except in 4.5.5.1.3 steps 4 and 5 (0°C operating test) are performed ahead of step 2 (–55°C nonoperating test). Equipment shall remain off upon return to room ambient during step 6. Excessive condensation shall be removed before operating during step 7.
Altitude	
Operating	To 4,500 m (15,000 ft). Maximum operating temperature decreased 1°C per 1,000 ft above 5,000 ft.
Nonoperating	To 15,000 m (50,000 ft).
Humidity (Operating and Nonoperating)	5 cycles (120 hours) referenced to MIL-T-28800C paragraph 4.5.5.1.2.2 for Type III, Class 5 instruments. Operating and non-operating at 95% +0% to –5% relative humidity. Operating at +50°C and +30°C. Non-operating at +30°C to +60°C.
Vibration (Operating)	15 minutes along each of 3 major axes at a total displacement of 0.015 inch p-p (2.4 g's at 55 Hz) with frequency varied from 10 Hz to 55 Hz to 10 Hz in 1-minute sweeps. Hold for 10 minutes at 55 Hz in each of the 3 major axes. All major resonances must be above 55 Hz.
Shock (Operating and Nonoperating)	30 g's, half-sine, 11-ms duration, 3 shocks per axis each direction, for a total of 18 shocks.
EMI	Meets radiated and conducted emission requirements per VDE 0871 Class B.

Table 1-3
Physical Characteristics

Characteristics	Description
Weight With Power Cord	
With Cover, Probes, and Pouch	6.2 kg (13.7 lb).
Without Cover, Probes, and Pouch	5.2 kg (11.5 lb).
Domestic Shipping Weight	7.3 kg (16.0 lb).
Height	
With Feet and Handles	138 mm (5.4 in).
Width	
With Handle	360 mm (14.2 in).
Without Handle	327 mm (12.9 in).
Depth	
With Front Cover	445 mm (17.5 in).
Without Front Cover	440 mm (17.3 in).
With Handle Extended	511 mm (20.1 in).

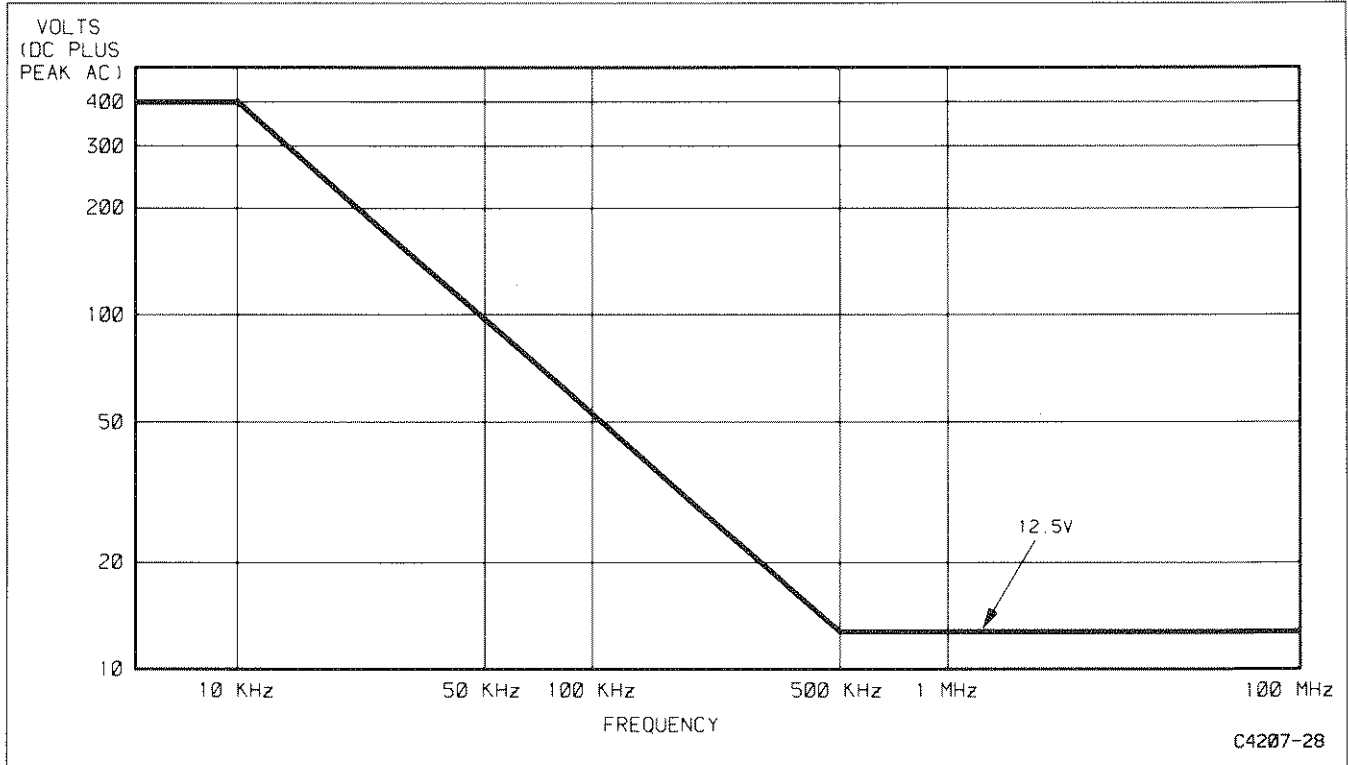


Figure 1-1. Maximum input voltage vs. frequency derating curve for CH 1 OR X, CH 2 OR Y, and EXT INPUT connectors.

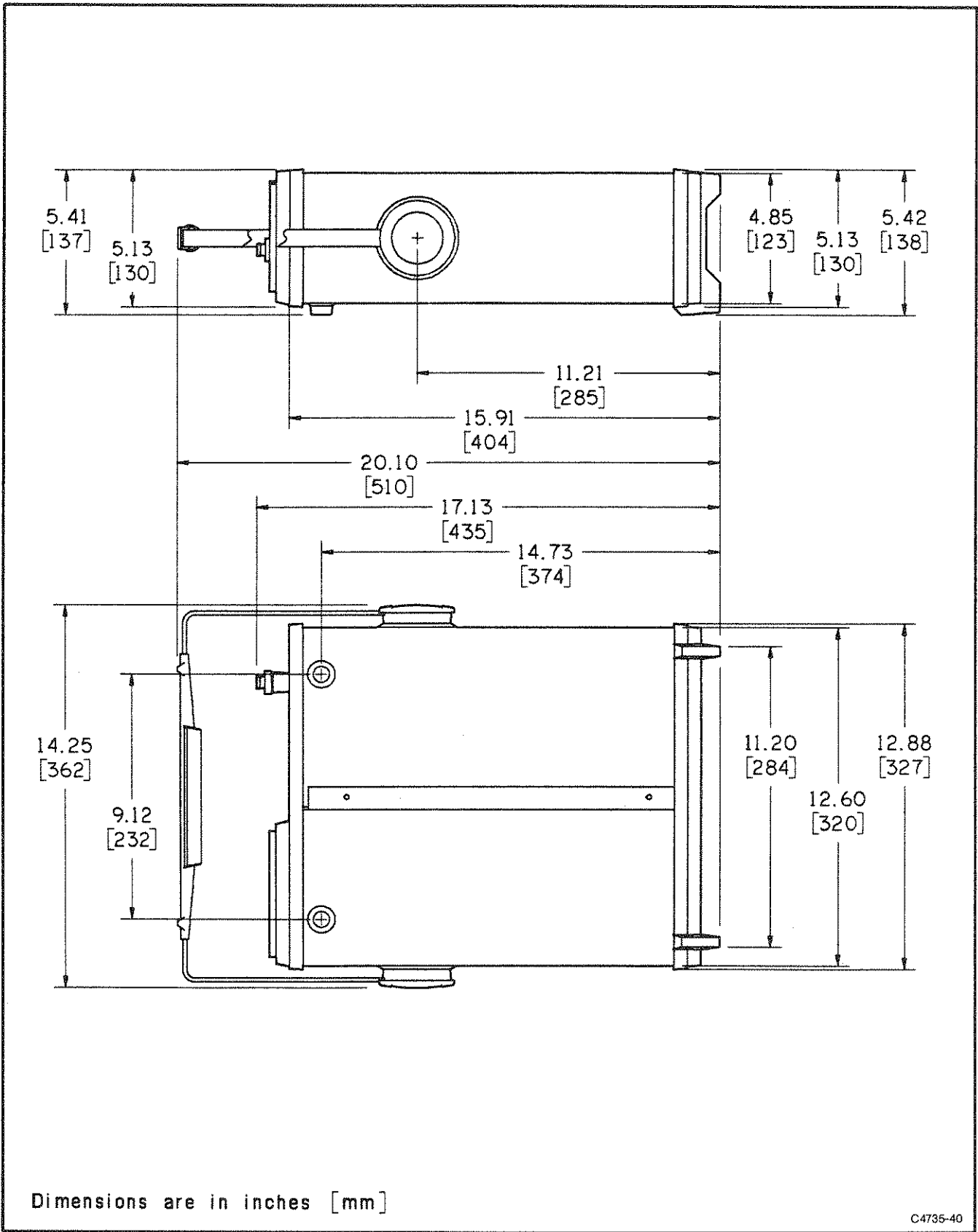


Figure 1-2. Physical dimensions of the 2215A Oscilloscope.

CALIBRATION

Instrument performance should be checked after every 2000 hours of operation or once each year if used infrequently. A more frequent interval may be necessary if your

instrument is subjected to harsh environments or severe usage.

REPACKAGING FOR SHIPMENT

If the instrument is to be shipped to a Tektronix Service Center for service or repair, attach a tag showing; owner (with address) and the name of an individual at your firm that can be contacted. Include complete instrument serial number and a description of the service required.

Save and reuse the package in which your instrument was shipped. If the original packaging is unfit for use or not available, repackage the instrument as follows:

Surround the instrument with polyethylene sheeting to protect its finish. Obtain a carton of corrugated cardboard having a carton test strength of 275 pounds and having inside dimensions of no less than six inches more than the instrument dimensions. Cushion the instrument by tightly packing three inches of dunnage or urethane foam between carton and instrument, on all sides. Seal carton with shipping tape or industrial stapler.

PREPARATION FOR USE

FIRST-TIME START UP

SAFETY

Refer to the "Operators Safety Summary" at the front of this manual for power source, grounding, and other safety considerations pertaining to the use of the 2215A. Before connecting the instrument to a power source, carefully read the following about line voltages, power cords, and fuses.

LINE VOLTAGE

The instrument is capable of continuous operation using input voltages that range from 90 V to 250 V nominal at frequencies from 48 Hz to 440 Hz.

POWER CORD

A detachable three-wire power cord with a three-contact plug is provided with each instrument to permit connection to both the power source and protective ground. The plug protective-ground contact connects (through the protective-ground conductor) to the accessible metal parts of the instrument. For electrical-shock protection, insert this plug only into a power outlet that has a securely grounded protective-ground contact.

This instrument is shipped with the required power cord as ordered by the customer. Available power-cord information are illustrated in Figure 2-1, and part numbers are listed in Section 5 at the back of this manual. Contact your Tektronix representative or local Tektronix Field Office for additional power-cord information.

LINE FUSE

The instrument fuse holder is located on the rear panel (see Figure 2-2) and contains the line fuse. The following procedure can be used to verify that the proper fuse is installed or to install a replacement fuse.

1. Unplug the power cord from the power-input source (if applicable).

2. Press in and slightly rotate the fuse-holder cap counterclockwise to release it.

3. Pull the cap (with the attached fuse inside) out of the fuse holder.

4. Verify proper fuse value (1.0A, 250 V, slow blow).

5. Reinstall the fuse (or replacement fuse) and the fuse-holder cap.

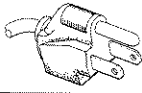
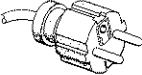
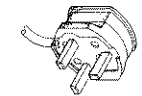
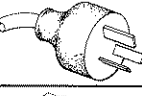

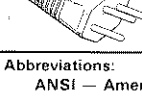
Plug Configuration	Usage	Line Voltage	Reference Standards
	North American 120V/ 15A	120V	ANSI C73.11 NEMA 5-15-P IEC 83
	Universal Euro 240V/ 10-16A	240V	CEE (7), II, IV, VII IEC 83
	UK 240V/ 13A	240V	BS 1363 IEC 83
	Australian 240V/ 10A	240V	AS C112
	North American 240V/ 15A	240V	ANSI C73.20 NEMA 6-15-P IEC 83
	Switzerland 220V/ 10A	220V	SEV
Abbreviations: ANSI — American National Standards Institute AS — Standards Association of Australia BS — British Standards Institution CEE — International Commission on Rules for the Approval of Electrical Equipment IEC — International Electrotechnical Commission NEMA — National Electrical Manufacturer's Association SEV — Schweizerischer Elektrotechnischer Verein			

Figure 2-1. Optional power cords.

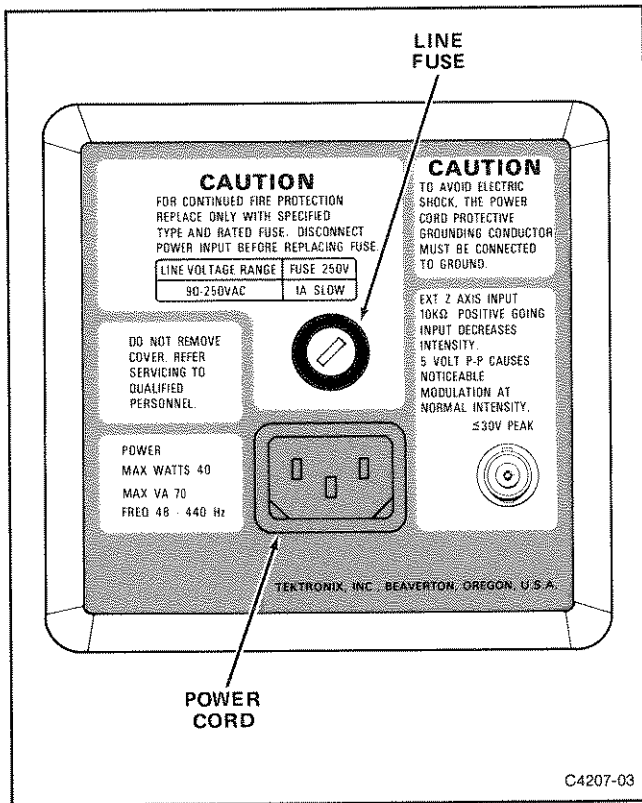


Figure 2-2. Fuse holder and power cord connector.

INSTRUMENT COOLING

Always maintain adequate instrument cooling. The ventilation holes on both sides of the instrument cabinet and on the rear panel must remain free of obstruction.

CONTROLS, CONNECTORS, AND INDICATORS

The following descriptions are intended to familiarize the operator with the location, operation, and function of the instrument's controls, connectors, and indicators.

DISPLAY, POWER, AND PROBE ADJUST

Refer to Figure 2-3 for location of items 1 through 8.

- 1 **Internal Graticule**—Eliminates parallax viewing error between the trace and graticule lines. Rise-time amplitude and measurement points are indicated at the left edge of the graticule.
- 2 **POWER Switch**—Turns instrument power on and off. Press in for ON; press again for OFF.
- 3 **Power Indicator**—An LED that illuminates when the instrument is operating.
- 4 **FOCUS Control**—Adjusts for optimum display definition.
- 5 **PROBE ADJUST Connector**—Provides an approximately 0.5 V, negative-going, square-wave voltage (at approximately 1 kHz) that permits an operator to compensate voltage probes and to check operation of the oscilloscope vertical system. It is not intended for verifying the accuracy of the vertical gain or time-base circuitry.
- 6 **BEAM FIND Switch**—When held in, compresses the display to within the graticule area and provides a visible viewing intensity to aid in locating off-screen displays.
- 7 **TRACE ROTATION Control**—Screwdriver adjustment used to align the crt trace with the horizontal graticule lines.
- 8 **A and B INTENSITY Controls**—Determines the brightness of the A and B Sweep traces.

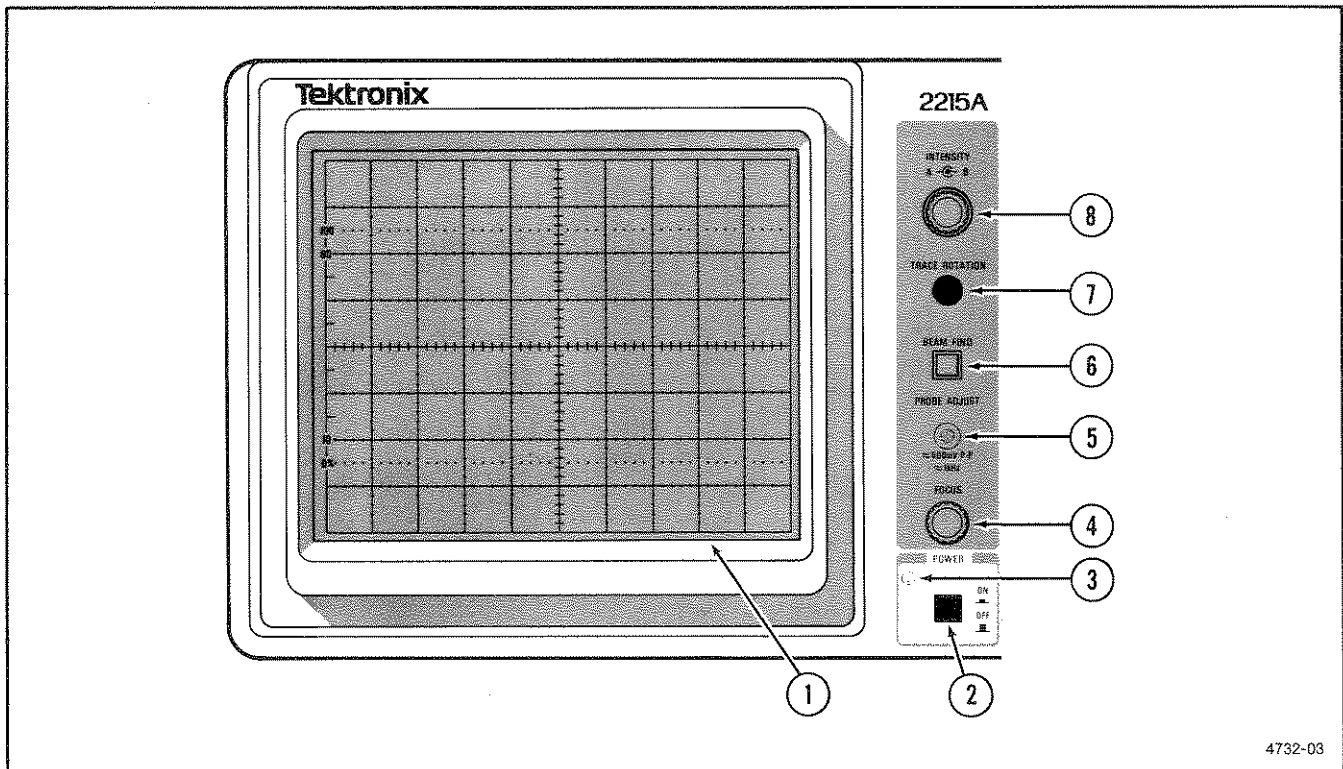


Figure 2-3. Power and display controls and indicators and PROBE ADJUST output.

VERTICAL

Refer to Figure 2-4 for location of items 9 through 17.

- 9 CH 1 VOLTS/DIV and CH 2 VOLTS/DIV Switches**—Used to select the vertical deflection factor in a 1-2-5 sequence. To obtain a calibrated deflection factor, the VOLTS/DIV variable control must be in the calibrated (CAL) detent (fully clockwise).

1X—Indicates the deflection factor selected when using either a 1X probe or a coaxial cable.

10X PROBE—Indicates the deflection factor selected when using a 10X probe.

- 10 VOLTS/DIV Variable Controls**—When rotated counterclockwise out of their calibrated detent positions, these controls provide continuously variable, uncalibrated deflection factors between the calibrated settings of the VOLTS/DIV switches.

- 11 POSITION Controls**—Used to vertically position the display on the crt. When the SEC/DIV switch is set to X-Y, the Channel 2 POSITION control moves the display vertically (Y-axis), and the Horizontal POSITION control moves the display horizontally (X-axis).

- 12 Input Coupling (AC-GND-DC) Switches**—Three-position switches that select the method of coupling the input signals to the instrument deflection system.

AC—Input signal is capacitively coupled to the vertical amplifier. The dc component of the input signal is blocked. Low-frequency limit (-3 dB point) is approximately 10 Hz.

GND—The input of the vertical amplifier is grounded to provide a zero (ground) reference-voltage display (does not ground the input signal). This switch position allows precharging the input coupling capacitor.

DC—All frequency components of the input signal are coupled to the vertical deflection systems.

- 13 CH 1 OR X and CH 2 OR Y Input Connectors**—Provide for application of external signals to the vertical deflection system or for an X-Y display. In the X-Y mode (SEC/DIV switch set to X-Y), the signal connected to the CH 1 OR X input connector provides horizontal deflection (X-axis) and the signal connected to the CH 2 OR Y input connector provides vertical deflection (Y-axis).

- 14 VERTICAL MODE Switches**—Two three-position switches and one button switch are used to select the mode of operation for the vertical amplifier system.

CH 1—Selects only the Channel 1 input signal for display.

BOTH—Selects both Channel 1 and Channel 2 input signals for display. The CH 1-BOTH-CH 2 switch must be in the BOTH position for either ADD, ALT, or CHOP operation.

CH 2—Selects only the Channel 2 input signal for display.

ADD—Displays the algebraic sum of the Channel 1 and Channel 2 input signals.

ALT—Alternately displays Channel 1 and Channel 2 input signals. The alternation occurs during retrace at the end of each sweep. This mode is useful for viewing both input signals at sweep speeds from $0.05 \mu\text{s}$ per division to 0.2 ms per division.

CHOP—The display switches between the Channel 1 and Channel 2 input signals during the sweep. The switching rate is approximately 500 kHz. This mode is useful for viewing both Channel 1 and Channel 2 input signals at sweep speeds from 0.5 ms per division to $0.5 \mu\text{s}$ per division.

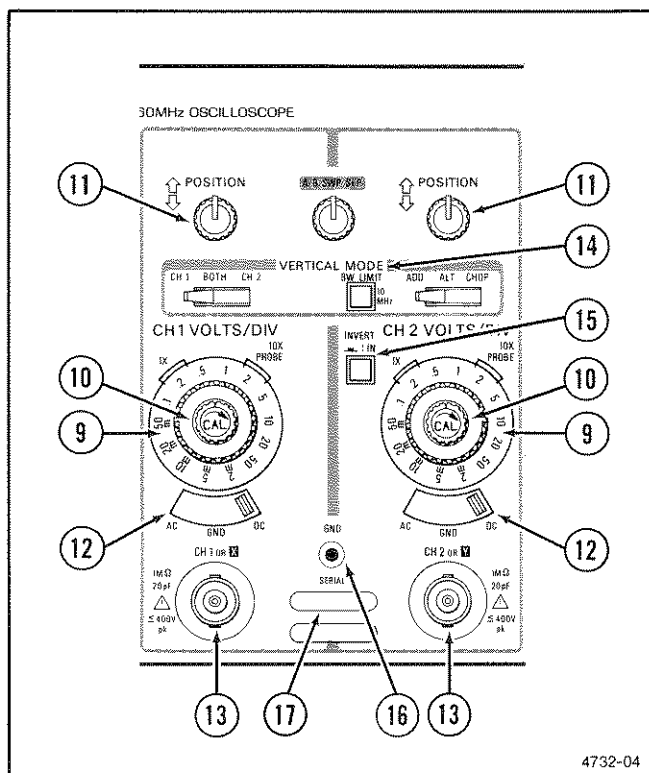


Figure 2-4. Vertical controls and connectors.

BW LIMIT—When pressed in, this button switch limits the bandwidth of the vertical amplifier and the A Trigger system to approximately 10 MHz. Button must be pressed a second time to release it and regain full 60 MHz bandwidth operation. Provides a method for reducing interference from high-frequency signals when viewing low-frequency signals.

15 INVERT Switch—Inverts the Channel 2 display when button is pressed in. Button must be pressed in a second time to release it and regain a noninverted display.

16 GND Connector—Provides direct connection to the instrument chassis ground.

17 SERIAL and Mod Slots—The SERIAL slot is imprinted with the instrument's serial number. The Mod slot contains the option number that is installed in the instrument.

18 A and B SEC/DIV Switches—Used to select the sweep speeds for the A and B Sweep generators in a 1-2-5 sequence. To obtain calibrated sweep speeds, the A and B SEC/DIV Variable control must be in the calibrated detent (fully clockwise).

A SEC/DIV—The calibrated sweep speed is shown between the two black lines on the clear plastic skirt. This switch also selects the delay time for delayed-sweep operation when used in conjunction with the B DELAY TIME POSITION control.

B SEC/DIV—The B Sweep speed is set by pulling out the DLY'D SWEEP knob and rotating it clockwise to a setting opposite the white line scribed on the knob. The B Sweep circuit is used only for delayed-sweep operation.

19 SEC/DIV Variable Control—Provides continuously variable, uncalibrated A Sweep speeds to at least 2.5 times slower than the calibrated setting. It extends the slowest sweep speed to at least 1.25 s per division.

20 X10 Magnifier Switch—To increase displayed sweep speed by a factor of 10, pull out the SEC/DIV Variable knob. The fastest sweep speed can be extended to 5 ns per division. Push in the SEC/DIV Variable knob to regain the X1 sweep speed.

HORIZONTAL

Refer to Figure 2-5 for location of items 18 through 24.

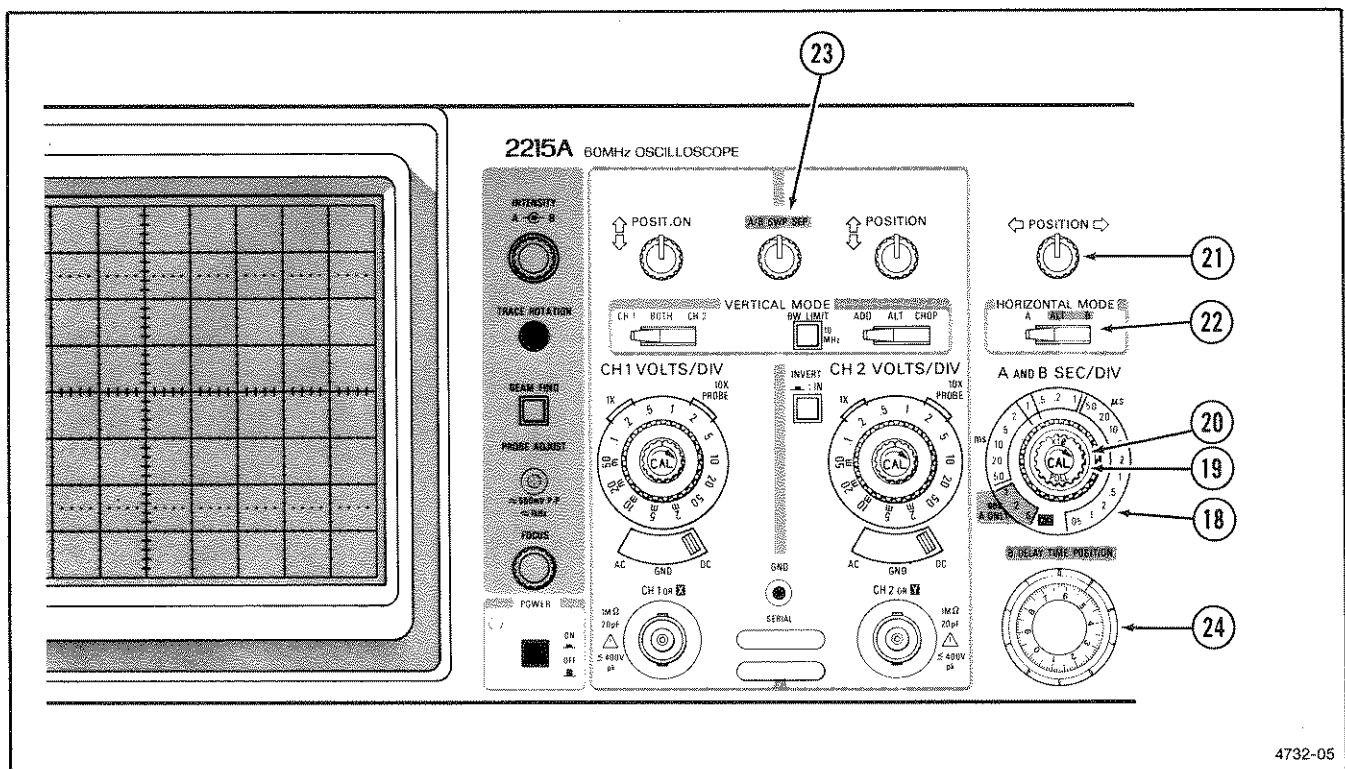


Figure 2-5. Horizontal controls.

4732-05

21 **POSITION Control**—Horizontally positions both the A Sweep and the B Sweep displays and horizontally positions X-axis in the X-Y mode.

22 **HORIZONTAL MODE Switch**—Three-position switch determines the mode of operation for the horizontal deflection system.

A—Horizontal deflection is provided by the A Sweep generator at a sweep speed determined by the A SEC/DIV switch setting.

ALT—Alternates the horizontal displays between the A Sweep (with an intensified zone) and the B Delayed Sweep. The A Sweep speed is determined by the setting of the A SEC/DIV switch. The B Sweep speed and the length of the intensified zone on the A Sweep are both determined by the B SEC/DIV switch setting.

B—Horizontal deflection is provided by the B Sweep generator at a sweep speed determined by the B SEC/DIV switch setting. The start of the B Sweep is delayed from the start of the A Sweep by a time determined by the settings of both the A SEC/DIV switch and the B DELAY TIME POSITION control.

23 **A/B SWP SEP Control**—Vertically positions the B Sweep trace with respect to the A Sweep trace when ALT HORIZONTAL MODE is selected.

24 **B DELAY TIME POSITION Control**—Selects the amount of delay time between the start of the A Sweep and the start of the B Sweep. Delay time is variable from 0.5 times to 10 times the A SEC/DIV switch setting.

TRIGGER

Refer to 2-6 for location of items 25 through 34.

25 **A TRIGGER Mode Switches**—Three section switch that determines the trigger mode for the A Sweep.

P-P AUTO-TV LINE—Permits triggering on waveforms and division lines having repetition rates of at least 20 Hz. Sweep free-runs in the absence of an adequate trigger signal or when the repetition rate is below 20 Hz. The range of the A TRIGGER LEVEL control is restricted to the peak-to-peak range of the trigger signal.

NORM—Sweep is initiated when an adequate trigger signal is applied. In the absence of a trigger signal, no baseline trace will be present.

TV FIELD—Press in both P-P AUTO and NORM buttons. Permits triggering on television field signals. TRIGGER LEVEL control should be rotated fully counterclockwise when triggering on TV signals with negative going sync and clockwise for positive going sync.

SGL SWP RESET—Press in the spring-return button momentarily to arm the A Trigger circuit for a single-sweep display. In this mode, the trigger system operates the same as NORM, except only one sweep is displayed for each trigger signal. Another sweep cannot be displayed until the SGL SWP RESET button is momentarily pressed in again to reset the A Trigger circuit. This mode is useful for displaying and photographing either nonrepetitive signals or signals that cause unstable conventional displays (e.g., signals that vary in amplitude, shape, or time).

26 **TRIG'D-READY Indicator**—LED illuminates when either P-P AUTO or NORM Trigger Mode is selected and the A Sweep has been triggered (TRIG'D). In single-sweep display, the LED illuminates to indicate that the A Trigger circuit is armed (READY).

27 **A TRIGGER LEVEL Control**—Selects the amplitude point on the trigger signal at which the sweep is triggered.

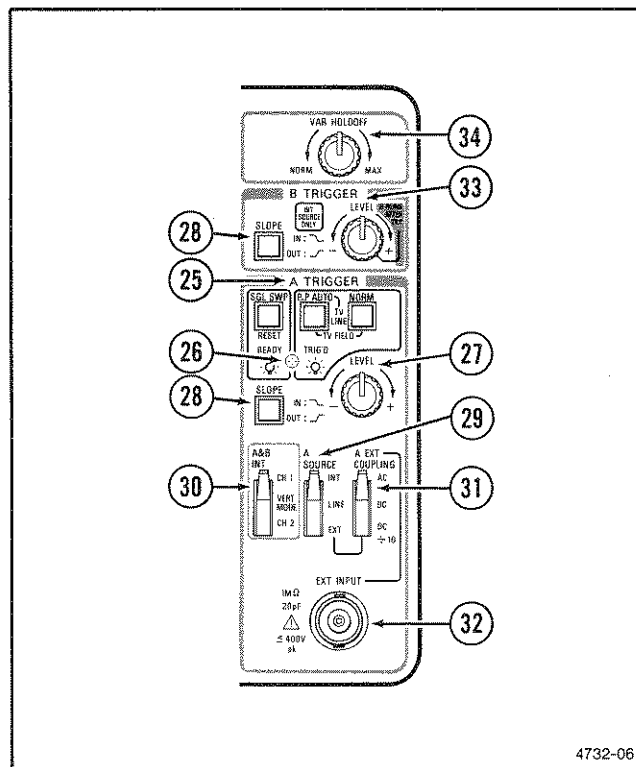


Figure 2-6. Trigger controls, connector, and indicator.

- 28 **SLOPE Switches**—Selects the slope of the signal that triggers the sweep.

OUT—When button is released out, sweep is triggered from the positive-going slope of the trigger signal.

IN—When button is pressed in, sweep is triggered from the negative-going slope of the trigger signal.

- 29 **A SOURCE Switch**—Determines the source of the trigger signal that coupled to the input of the A Trigger circuit.

INT—Permits triggering on signals that are applied to the CH 1 OR X and CH 2 OR Y input connectors. The source of the internal signal is selected by the A & B INT switch.

LINE—The power-source waveform is the source of the trigger signal. This trigger source is useful when vertical input signals are time related (multiple or submultiple) to the frequency of the power-input source voltage.

EXT—Permits triggering on signals applied to the EXT INPUT connector.

- 30 **A&B INT Switch**—Selects the source of the internal triggering signal when the A SOURCE switch is set to INT.

CH 1—The signal applied to the CH 1 OR X input connector is the source of the trigger signal.

VERT MODE—The internal trigger source is determined by the signals selected for display by the VERTICAL MODE switches. See Table 2-1 for VERT MODE trigger source.

CH 2—The signal applied to the CH 2 OR Y input connector is the source of the trigger signal.

- 31 **A EXT COUPLING Switch**—Determines the method used to couple external signals to the A TRIGGER circuit from the EXT INPUT connector.

AC—Signals above 60 Hz are capacitively coupled to the input of the A Trigger circuit. Any dc components are blocked, and signals below 60 Hz are attenuated.

Table 2-1
VERT MODE Trigger Source

VERT MODE	Trigger Source
CH 1	CH 1 OR X input signal.
CH 2	CH 2 OR Y input signal.
BOTH and ADD	Algebraic sum of CH 1 OR X and CH 2 OR Y input signals.
BOTH and CHOP	Algebraic sum of CH 1 OR and CH 2 OR Y input signals.
BOTH and ALT	Alternates between Channel 1 and Channel 2 on every other sweep (i.e. CH 1 OR X input signal triggers the sweep that displays Channel 1, and CH 2 OR Y input signal triggers the sweep that displays Channel 2).

DC—All frequency components of the signal are coupled to the input of the A Trigger circuitry. This position is useful for displaying low-frequency or low-repetition-rate signals.

DC ÷ 10—10—External trigger signals are attenuated by a factor of 10. All frequency components of the signal are coupled to the input of the A Trigger circuit.

- 32 **EXT INPUT Connector**—Provides a means of introducing external signals into the A Trigger circuit through the A EXT COUPLING switch.

- 33 **B TRIGGER LEVEL Control**—Selects the amplitude point on the trigger signals at which the sweep is triggered. When fully clockwise (B RUNS AFTER DLY), the B Sweep circuit runs immediately following the delay time selected by the A SEC/DIV and the B DELAY TIME POSITION control.

- 34 **VAR HOLDOFF Control**—Provides continuous control of holdoff time between sweeps. Increases the holdoff time by at least a factor of 10. This control improves the ability to trigger on aperiodic signals (such as complex digital waveforms).

REAR PANEL

Refer to Figure 2-7 for location of item 35.

- 35 **EXT Z-AXIS Connector**—Provides a means of connecting external signals to the Z-Axis amplifier to intensity modulate the crt. Applied signals do not affect display waveshape. Signals with fast rise times and fall times provide the most abrupt intensity change, and a 5 V p-p signal will produce noticeable modulation. The Z-Axis signals must be time-related to the display to obtain a stable presentation on the crt.

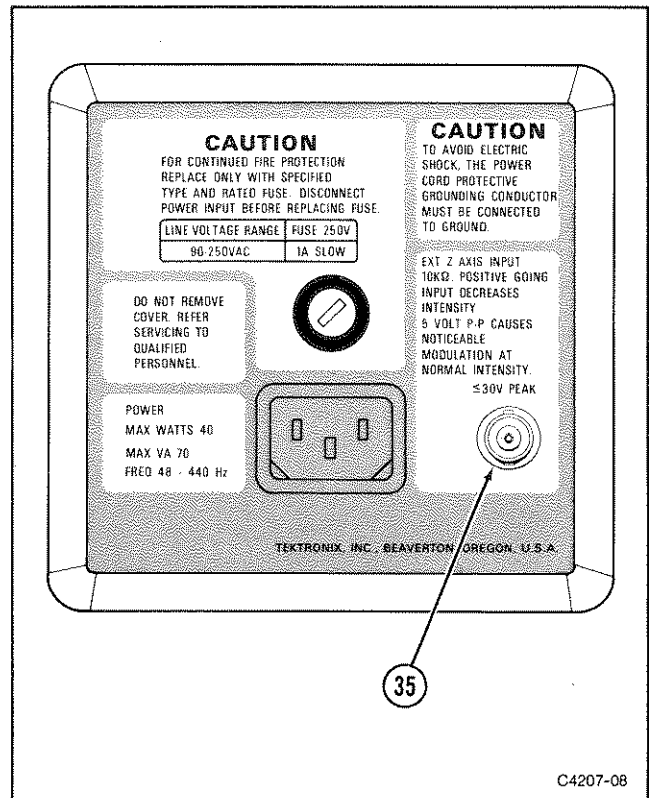


Figure 2-7. Rear-panel connector.

OPERATORS FAMILIARIZATION

GENERAL OPERATING INFORMATION

GRATICULE

The graticule is internally marked on the faceplate of the crt to enable accurate measurements without parallax error (see Figure 3-1). It is marked with eight vertical and ten horizontal major divisions. Each major division is divided into five subdivisions. The vertical deflection factors and horizontal timing are calibrated to the graticule so that accurate measurements can be made directly from the crt. Also, percentage markers for the measurement of rise and fall times are located on the left side of the graticule.

GROUNDING

The most reliable signal measurements are made when the 2215A and the unit under test are connected by a common reference (ground lead), in addition to the signal lead or probe. The probe's ground lead provides the best grounding method for signal interconnection and ensures the maximum amount of signal-lead shielding in the probe cable. A separate ground lead can also be connected from the unit under test to the oscilloscope GND connector located on the front panel.

SIGNAL CONNECTIONS

Generally, probes offer the most convenient means of connecting an input signal to the instrument. They are shielded to prevent pickup of electromagnetic interference, and the supplied 10X probe offers a high input impedance that minimizes circuit loading. This allows the circuit under test to operate with a minimum of change from its normal condition as measurements are being made.

Coaxial cables may also be used to connect signals to the input connectors, but they may have considerable effect on the accuracy of a displayed waveform. To maintain the original frequency characteristics of an applied signal, only high-quality, low-loss coaxial cables should be used. Coaxial cables should be terminated at both ends in their characteristic impedance. If this is not possible, use suitable impedance-matching devices.

INPUT COUPLING CAPACITOR PRECHARGING

When the Input Coupling switch is set to GND, the input signal is connected to ground through the input coupling capacitor in series with a 1 M Ω resistor to form a precharging network. This network allows the input coupling capacitor to charge to the average dc-voltage level of the signal applied to the probe. Thus any large voltage transients that may accidentally be generated will not be applied to the amplifier input when the Input Coupling switch is moved from GND to AC. The precharging network also provides a measure of protection to the external circuitry by reducing the current levels that can be drawn from the external circuitry during capacitor charging.

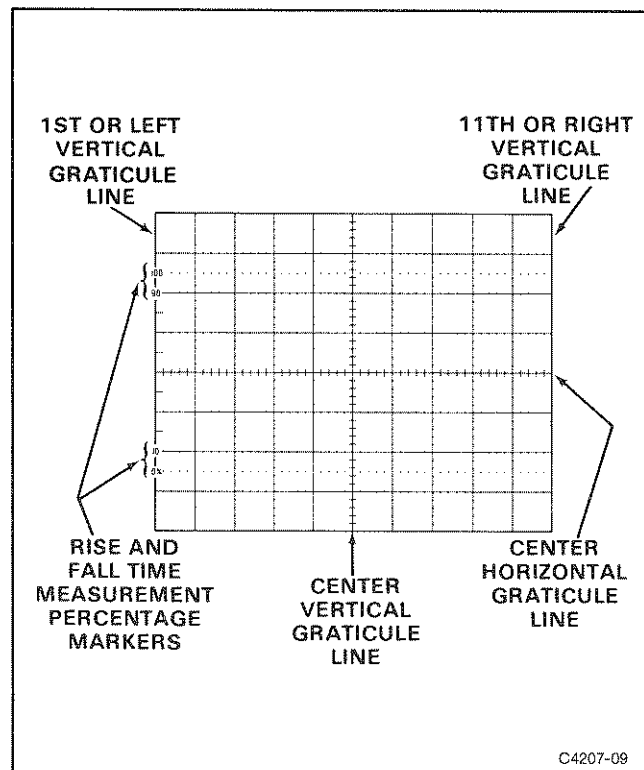


Figure 3-1. Graticule measurement markings.

The following procedure should be used whenever the probe tip is connected to a signal source having a different dc level than that previously applied, especially if the dc-level difference is more than 10 times the VOLTS/DIV switch setting:

1. Set the Input Coupling switch to GND.
2. Insert the probe tip into the oscilloscope GND connector and wait several seconds for the input coupling capacitor to discharge.

3. Connect the probe tip to the signal source and wait several seconds for the input coupling capacitor to charge.

4. Set the Input Coupling switch to AC. The display will remain on the screen, and the ac component of the signal can be measured in the normal manner.

OPERATOR'S ADJUSTMENTS

INTRODUCTION

To verify the operation and accuracy of your instrument before making measurements, perform the following adjustment procedures. If adjustments are required beyond the scope of the operators's adjustments, refer the instrument to a qualified service technician.

Before proceeding with these instructions, refer to "Preparation for Use" (Section 2).

Verify that the POWER switch is OFF (button out), then plug the power cord into the power-source outlet.

If indications specified in these procedures cannot be obtained, refer the instrument to a qualified service technician.

BASELINE TRACE

First obtain a baseline trace, using the following procedure.

1. Preset the instrument front-panel controls as follows:

Display

A and B INTENSITY	Fully counterclockwise
FOCUS	Midrange

Vertical (Both Channels)

POSITION	Midrange
VERTICAL MODE	CH 1
BW LIMIT	Off (button out)
VOLTS/DIV	50 mV
VOLTS/DIV Variable	CAL detent
INVERT	Off (button out)
Input Coupling	AC

Horizontal

A/B SWP SEP	Off midrange
POSITION	Midrange
HORIZONTAL MODE	A
A and B SEC/DIV	0.5 ms
SEC/DIV Variable	CAL detent
X10 Magnifier	Off (knob in)
B DELAY TIME	
POSITION	Fully counterclockwise

B TRIGGER

SLOPE	OUT
LEVEL	Fully clockwise

A TRIGGER

VAR HOLDOFF	NORM
Mode	P-P AUTO
SLOPE	OUT
LEVEL	Midrange
A&B INT	VERT MODE
A SOURCE	INT
A EXT COUPLING	AC

2. Press in the POWER switch button (ON) and allow the instrument to warm up (20 minutes is recommended for maximum accuracy).

3. Adjust the A INTENSITY control for desired display brightness.

4. Adjust the Vertical and Horizontal POSITION controls as needed to center the trace on the screen.

TRACE ROTATION

Normally, the resulting trace will be parallel to the center horizontal graticule line, and the Trace Rotation adjustment should not be required. If adjustment is needed, perform the following procedure:

1. Preset instrument controls and obtain a baseline trace.

2. Use the Channel 1 POSITION control to move the baseline trace to the center horizontal graticule line.

3. If the resulting trace is not parallel to the center horizontal graticule line, use small flat-bit screwdriver to adjust the TRACE ROTATION control and align the trace with the center horizontal graticule line.

PROBE COMPENSATION

Misadjustment of probe compensation is a common source of measurement error. Most attenuator probes are equipped with a compensation adjustment. To ensure optimum measurement accuracy, always compensate the oscilloscope probes before making measurements. Probe compensation is accomplished as follows:

1. Preset instrument controls and obtain a baseline trace.

2. Connect the two 10X probes (supplied with the instrument) to the CH 1 and CH 2 input connectors.

3. Set both VOLTS/DIV switches to 10 mV and set both Input Coupling switches to DC.

4. Select CH 1 VERTICAL MODE and insert the tip of the Channel 1 probe into the PROBE ADJUST output jack.

5. Using the approximately 1 kHz PROBE ADJUST square-wave signal as the input, obtain a 5-division display of the signal.

6. Set the A SEC/DIV switch to display several cycles of the PROBE ADJUST signal. Use the Channel 1 POSITION control to vertically center the display.

7. Check the waveform presentation for overshoot and rolloff (see Figure 3-2). If necessary, adjust the probe com-

pensation for flat tops on the waveforms. Refer to the instructions supplied with the probe for details of compensation adjustment.

8. Select CH 2 VERTICAL MODE and connect the Channel 2 probe tip to the PROBE ADJUST output jack.

9. Use the Channel 2 POSITION to vertically center the display and repeat step 7 for the Channel 2 probe.

10. Disconnect the probes from the instrument.

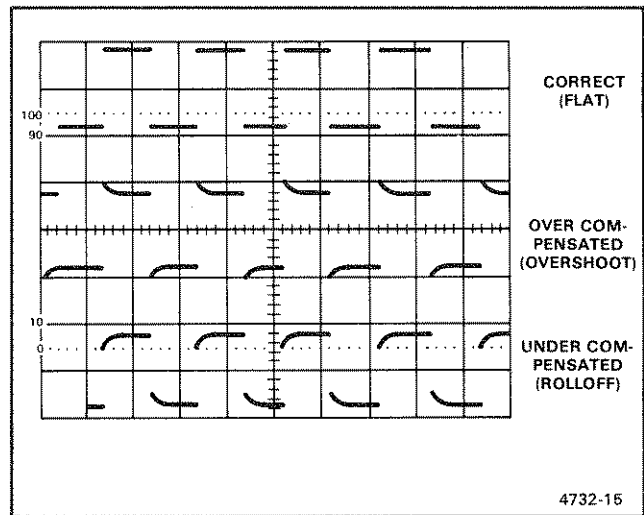


Figure 3-2. Probe compensation.

OPERATING PROCEDURES

BASIC APPLICATIONS

INTRODUCTION

After becoming familiar with the capabilities of the 2215A Oscilloscope an operator can then easily develop convenient methods for making particular measurements. The information in this section is designed to enhance operator understanding and to assist in developing efficient techniques for making specific measurements. Recommended methods for making basic measurements with your instrument are described in the procedures contained in this section.

When a procedure first calls for presetting instrument controls and obtaining a baseline trace, refer to the "Operator's Adjustments" part in Section 3 and perform steps 1 through 4 under "Baseline Trace".

INDEX TO BASIC APPLICATION PROCEDURES

VOLTAGE MEASUREMENTS	4-1
AC Peak-to-Peak Voltage	4-1
Instantaneous Voltage	4-2
Algebraic Addition	4-3
Common-Mode Rejection	4-3
Amplitude Comparison	4-4
NONDELAYED TIME MEASUREMENTS	4-4
Time Duration	4-4
Frequency	4-5
Rise Time	4-5
Time Difference Between Pulses On Time Related Signals	4-6
Phase Difference	4-6
TELEVISION DISPLAYS	4-8
TV Line Signal	4-8
TV Field Signal	4-8
DELAYED-SWEEP MAGNIFICATION	4-8
Magnified Sweep Runs After Delay	4-9
Pulse Jitter Time Measurement	4-10
Triggered Magnified Sweep	4-10

DELAYED-SWEEP TIME MEASUREMENTS	4-10
Time Difference On Single Waveform	4-10
Rise Time	4-11
Time Difference Between Two Pulses On Two Time-Related Signals	4-12

VOLTAGE MEASUREMENTS

AC Peak-to-Peak Voltage

To make a peak-to-peak voltage measurement, use the following procedure:

NOTE

This procedure may also be used to make voltage measurements between any two points on the waveform.

1. Preset instrument controls and obtain a baseline trace.
2. Apply the ac signal to either vertical-channel input connector and set the VERTICAL MODE switch to display the channel used.
3. Set the appropriate VOLTS/DIV switch to display about five divisions of the waveform, ensuring that the VOLTS/DIV Variable control is in the CAL detent.
4. Adjust the A TRIGGER LEVEL control to obtain a stable display.
5. Set the A SEC/DIV switch to a position that displays several cycles of the waveform.
6. Vertically position the display so that the negative peak of the waveform coincides with one of the horizontal graticule lines (see Figure 4-1, Point A).

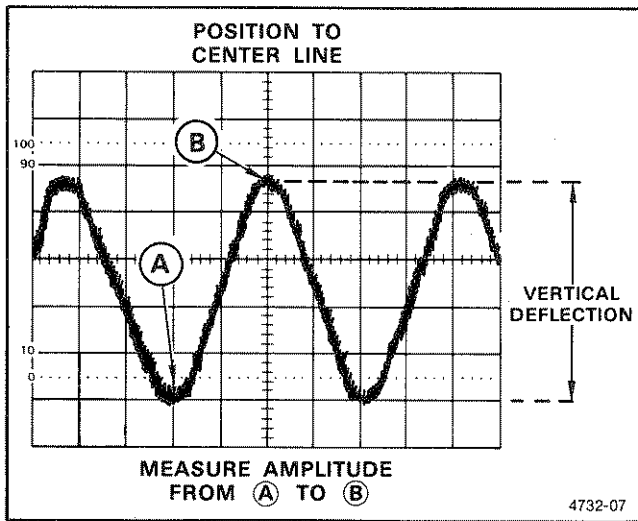


Figure 4-1. Peak-to-Peak waveform voltage.

7. Horizontally position the display so that one of the positive peaks coincides with the center vertical graticule line (see Figure 4-1, Point B).

8. Measure the vertical deflection from peak-to-peak (see Figure 4-1, Point A to Point B).

NOTE

If the amplitude measurement is critical or if the trace is thick (as a result of hum or noise on the signal), a more accurate value can be obtained by measuring from the top of a peak to the top of a valley. This will eliminate trace thickness from the measurement.

9. Calculate the peak-to-peak voltage, using the following formula:

$$\text{Volts (p-p)} = \text{vertical deflection (divisions)} \times \text{VOLTS/DIV switch setting indicated by 1X (or 10X PROBE when 10X probe is used)}$$

EXAMPLE: The measured peak-to-peak vertical deflection is 4.6 divisions (see Figure 4-1) using a 10X attenuator probe with the VOLTS/DIV switch set to 5 V (at 10X PROBE setting).

Substituting the given values:

$$\text{Volts (p-p)} = 4.6 \text{ div} \times 5 \text{ V/div} = 23 \text{ V.}$$

Instantaneous Voltage

To measure instantaneous level at a given point on a waveform, referred to ground, use the following procedure:

1. Preset instrument controls and obtain a baseline trace.

2. Apply the signal to either vertical-channel input connector and set the VERTICAL MODE switch to display the channel used.

3. Verify that the VOLTS/DIV Variable control is in the CAL detent and set the Coupling switch to GND.

4. Vertically position the baseline trace to the center horizontal graticule line. This establishes the ground reference location.

NOTE

If measurements are to be made relative to a voltage level other than ground, set the Input Coupling switch to DC instead, and apply the reference voltage to the input connector. Then position the trace to the reference (horizontal graticule) line.

5. Set the COUPLING switch to DC. Points on the waveform above the ground reference location are positive. Those points below are negative.

NOTE

If using Channel 2, ensure that the Channel 2 INVERT switch is in its noninverting mode (button out).

6. If necessary, repeat Step 4 using a different reference line which allows the waveform in Step 5 to be displayed on screen.

7. Adjust the A TRIGGER LEVEL control to obtain a stable display.

8. Set the A SEC/DIV switch to a position that displays several cycles of the signal.

9. Measure the divisions of vertical deflection between the ground reference line and the point on the waveform at which the level is to be determined (see Figure 4-2).

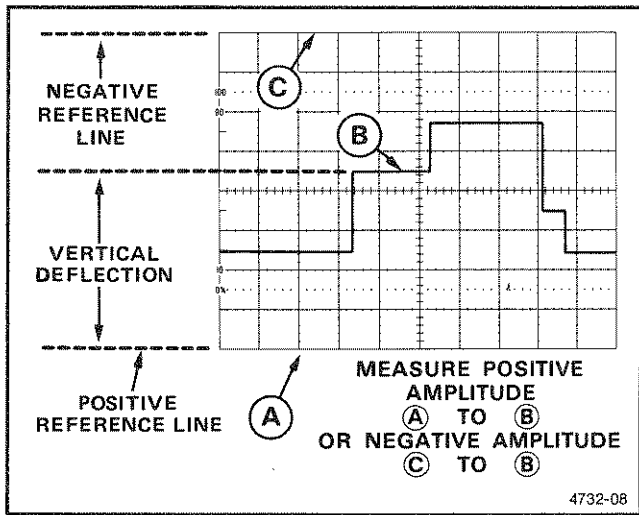


Figure 4-2. Instantaneous voltage measurement.

10. Calculate the instantaneous voltage, using the following formula:

$$\text{Instantaneous Voltage} = \text{vertical deflection (divisions)} \times \text{polarity (+ or -)} \times \text{VOLTS/DIV switch setting indicated by 1X (or 10X when 10X probe is used)}$$

EXAMPLE: The measured vertical deflection from the reference line is 4.6 divisions (see Figure 4-2), the waveform point is above the reference line, a 10X attenuator probe is being used, and the VOLTS/DIV switch is set to 2 V (at 10X PROBE setting).

Substituting the given values:

$$\text{Instantaneous Voltage} = 4.6 \text{ div} \times (+1) \times 2 \text{ V/div} = 9.2 \text{ V.}$$

Algebraic Addition

With the VERTICAL MODE switches set to BOTH and ADD, the waveform displayed is the algebraic sum of the signals applied to the Channel 1 and Channel 2 inputs (CH 1 + CH 2). If the Channel 2 INVERT button is pressed in, the waveform displayed is the difference between the signals applied to the Channel 1 and Channel 2 inputs (CH 1 - CH 2). When both VOLTS/DIV switches are set to the same deflection factor, the deflection factor in the ADD mode is equal to the deflection factor indicated by either VOLTS/DIV switch.

The following general precautions should be observed when using the ADD mode.

- a. Do not exceed the input voltage rating of the oscilloscope.
- b. Do not apply signals that exceed the equivalent of about eight times the VOLTS/DIV switch settings, since large voltages may distort the display. For example, with a VOLTS/DIV switch setting of 0.5 V, the voltage applied to that channel should not exceed approximately 4 volts.
- c. Use Channel 1 and Channel 2 POSITION control settings which most nearly position the signal on each channel to midscreen, when viewed in either CH 1 or CH 2 VERTICAL MODE. This ensures the greatest dynamic range for ADD mode operation.
- d. To attain similar response from each channel, set both the Channel 1 and Channel 2 Input Coupling switches to the same position.

Common-Mode Rejection

The following procedure shows how to eliminate unwanted ac input-power frequency components. Similar methods could be used either to eliminate other unwanted frequency components or to provide a dc offset.

1. Preset instrument controls and obtain a baseline trace.
2. Apply the signal containing the unwanted line-frequency components to the CH 1 input connector.
3. Apply a line-frequency signal to the CH 2 input connector. To maximize cancellation, the signal applied to Channel 2 must be in phase with the unwanted line-frequency component on the Channel 1 input.
4. Select BOTH and ALT VERTICAL MODE and set both VOLTS/DIV switches to produce displays of approximately 4- or 5-divisions in amplitude.
5. Adjust either VOLTS/DIV switch and VOLTS/DIV Variable control so that both display signals are the same amplitude.
6. Adjust the CH 2 VOLTS/DIV switch and CH 2 VOLTS/DIV Variable control so that the Channel 2 display is approximately the same amplitude as the undesired portion of the Channel 1 display (see Figure 4-3A).

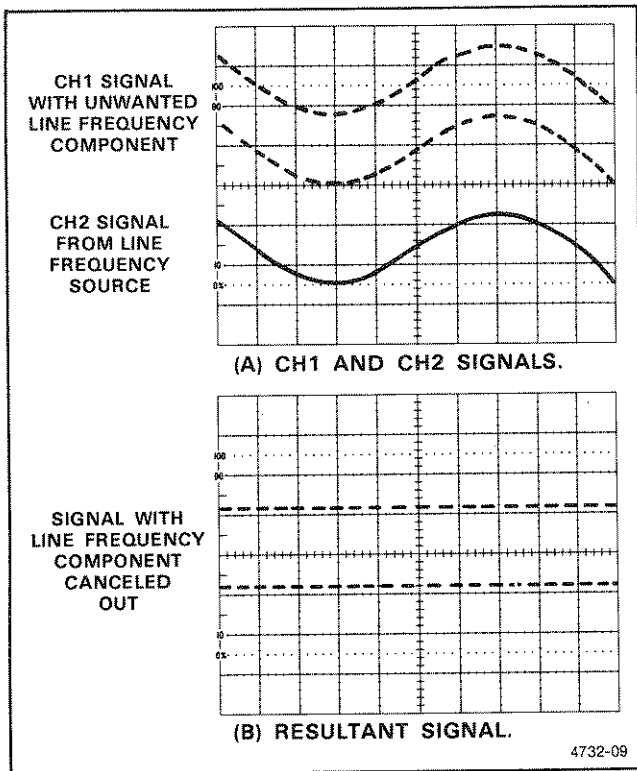


Figure 4-3. Common-mode rejection.

7. Select ADD VERTICAL MODE and press in the INVERT button, and slightly readjust the CH 2 VOLTS/DIV Variable control for maximum cancellation of the undesired signal component (see Figure 4-3B).

Amplitude Comparison (Ratio)

In some applications it may be necessary to establish a set of deflection factors other than those indicated by the VOLTS/DIV switch settings. This is useful for comparing unknown signals to a reference signal of known amplitude. To accomplish this, a reference signal of known amplitude is first set to an exact number of vertical divisions by adjusting the VOLTS/DIV switch and Variable control. Unknown signals can then be quickly and accurately compared with the reference signal without disturbing the setting of the VOLTS/DIV Variable control. This procedure is as follows:

1. Preset instrument controls and obtain a baseline trace.
2. Apply the reference signal to either vertical channel input and set the VERTICAL MODE switch to display the channel used.
3. Set the amplitude of the reference signal to five vertical divisions by adjusting the VOLTS/DIV switch and VOLTS/DIV Variable control.

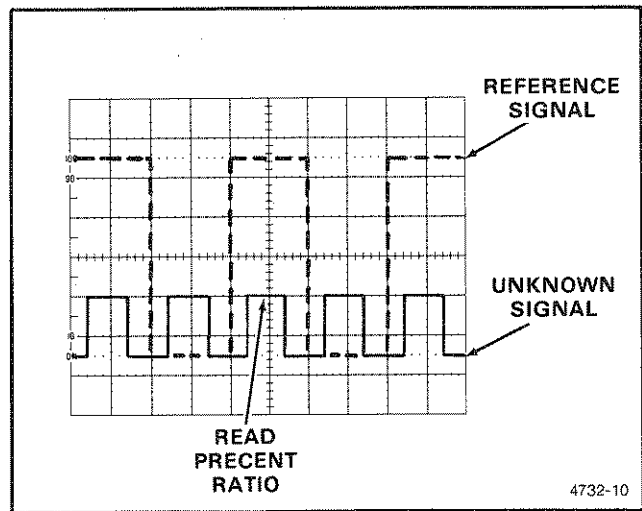


Figure 4-4. Voltage ratios.

4. Disconnect the reference signal and apply the unknown signal to be measured to the same channel input. Adjust the vertical position of the waveform so that its bottom edge just touches the 0% line on the crt.

5. Horizontally position the waveform so that its top most features cross the center vertical graticule line (see Figure 4-4).

6. Read the percent ratio directly from the graduations of the center line, referring to the 0% and 100% percentage marks on the left edge of the graticule (1 minor division equals 4% for a 5-division display).

NONDELAYED TIME MEASUREMENTS

Time Duration

To measure time between two points on a waveform, use the following procedure:

1. Preset instrument controls and obtain a baseline trace.
2. Apply the signal to either vertical-channel input connector and set the VERTICAL MODE switch to display the channel used.
3. Adjust the A TRIGGER LEVEL control to obtain a stable display.
4. Set the A SEC/DIV switch to display one complete period of the waveform. Ensure that the SEC/DIV Variable control is in the CAL detent.

5. Position the display to place the time-measurement points on the center horizontal graticule line (see Figure 4-5).

6. Measure the Horizontal distance between the time-measurement points.

7. Calculate time duration using the following formula:

$$\text{Time Duration} = \frac{\text{horizontal distance (division)} \times \text{A SEC/DIV switch setting}}{\text{magnification factor}}$$

EXAMPLE: The distance between the time measurement points is 8.3 divisions (see Figure 4-5), and the A SEC/DIV switch is set to 2 ms per division. The X10 Magnifier is off (knob in).

Substituting the given values:

$$\text{Time Duration} = 8.3 \text{ div} \times 2 \text{ ms/div} = 16.6 \text{ ms.}$$

Frequency

The frequency of a recurrent signal can be determined from its time-duration measurement as follows:

1. Measure the time duration of one waveform cycle using the preceding "Time Duration" measurement procedure.

2. Calculate the reciprocal of the time-duration value to determine the frequency of the waveform.

EXAMPLE: The signal in Figure 4-5 has a time duration of 16.6 ms.

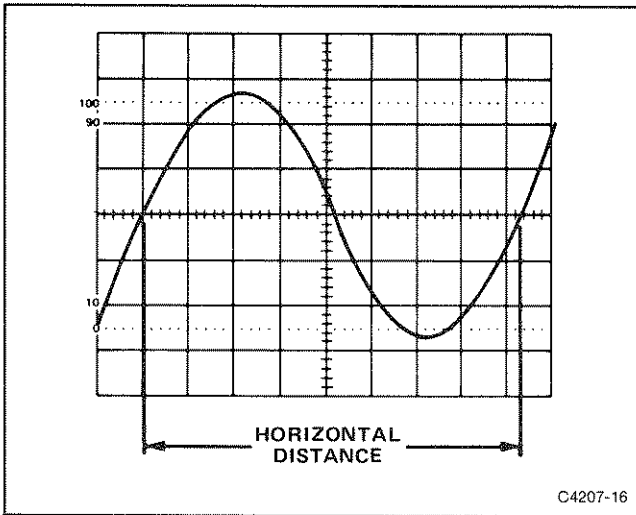


Figure 4-5. Time duration.

Calculating the reciprocal of time duration:

$$\text{Frequency} = \frac{1}{\text{time duration}} = \frac{1}{16.6 \text{ ms}} = 60 \text{ Hz}$$

Rise Time

Rise-time measurements use the same methods as time duration, except that the measurements are made between the 10% and 90% points of the low to high transition of the selected waveform (see Figure 4-6). Fall time is measured between the 90% and 10% points of the high to low transition of the waveform.

1. Preset instrument controls and obtain a baseline trace.

2. Apply an exact 5-division signal to either vertical-channel input connector and set the VERTICAL MODE switch to display the channel used.

3. Set the appropriate VOLTS/DIV switch and variable control for an exact 5-division display.

4. Vertically position the trace so that the zero reference of the waveform touches the 0% graticule line and the top of the waveform touches the 100% graticule line.

5. Horizontally position the display so the 10% point on the waveform intersects the second vertical graticule line.

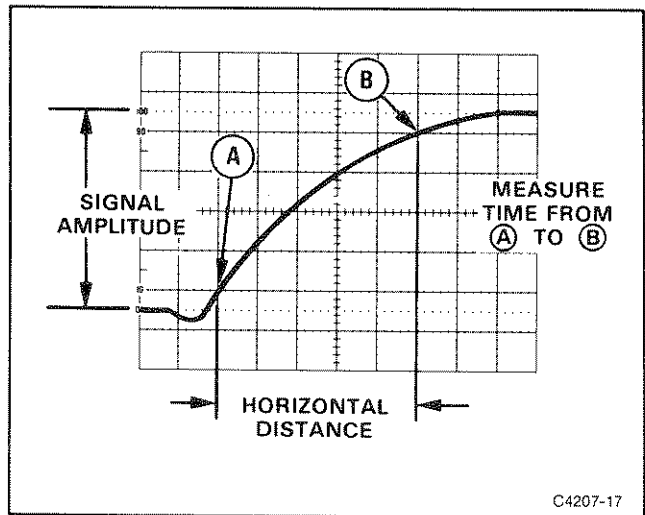


Figure 4-6. Rise time.

6. Measure the horizontal distance between the 10% and 90% points (between Points A and B of Figure 4-6) and calculate the time duration using the following formula:

$$\text{Rise Time} = \frac{\text{horizontal distance (divisions)} \times \text{A SEC/DIV switch setting}}{\text{magnification factor}}$$

Example: The horizontal distance between the 10% and 90% points is 5 divisions, and the A SEC/DIV switch is set to 1 μs per division. The X10 magnifier knob is off (knob in).

Substituting the given values in the formula:

$$\text{Rise Time} = \frac{5 \text{ div} \times 1 \mu\text{s/div}}{1} = 5 \mu\text{s}$$

Time Difference Between Pulses On Time-Related Signals

The calibrated sweep speed and dual-trace features of the 2215A allow measurement of the time difference between two separate events. To measure time difference, use the following procedure:

1. Preset instrument controls and obtain a baseline trace, then set the A TRIGGER SOURCE switch to CH 1.

2. Set both Input Coupling switches to the same position, depending on the type of input coupling desired.

3. Using either probes or cables with equal time delays, connect a known reference signal to the Channel 1 input and the comparison signal to the Channel 2 input.

4. Set both VOLTS/DIV switches for 4- or 5-division displays.

5. Select BOTH VERTICAL MODE; then select either ALT or CHOP, depending on the frequency of input signals.

6. If the two signals are of opposite polarity, press in the Channel 2 INVERT button to invert the Channel 2 display (signals may be of opposite polarity due to 180° phase difference).

7. Adjust the A TRIGGER LEVEL control for a stable display.

8. Set the A SEC/DIV switch to a sweep speed which provides three or more divisions of horizontal separation between the reference points on the two displays. Center each of the displays vertically (see Figure 4-7).

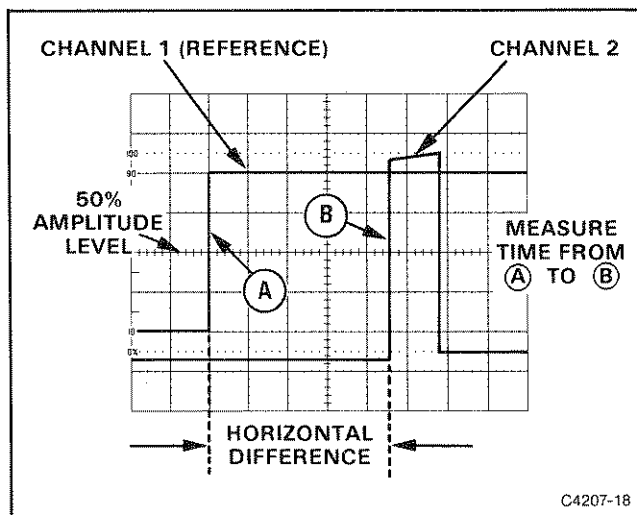


Figure 4-7. Time difference between pulses on time-related signals.

9. Measure the horizontal difference between the two signal reference points and calculate the time difference using the following formula:

$$\text{Time Difference} = \frac{\text{A SEC/DIV switch setting} \times \text{horizontal difference (divisions)}}{\text{magnification factor}}$$

EXAMPLE: The A SEC/DIV switch is set to 50 μs per division, the X10 Magnifier is on (button out) and the horizontal difference between waveform measurement points is 4.5 divisions.

Substituting the given values in the formula:

$$\text{Time Difference} = \frac{50 \mu\text{s/div} \times 4.5 \text{ div}}{10} = 22.5 \mu\text{s}$$

Phase Difference

In a similar manner to "Time Difference Between Two Time-Related Pulses" phase comparison between two signals of the same frequency can be made using the dual-trace feature of the 2215A. This method of phase difference measurement can be used up to the frequency limit of the vertical deflection system. To make a phase comparison, use the following procedure:

1. Preset instrument controls and obtain a baseline trace, then set the INT switch to CH 1.

2. Set both Input Coupling switches to the same position, depending on the type of input coupling desired.

3. Using either probes or cables with equal time delays, connect a known reference signal to the Channel 1 input and the unknown signal to the Channel 2 input.

4. Select BOTH VERTICAL MODE; then select either ALT or CHOP, depending on the frequency of input signals. The reference signal should precede the comparison signal in time.

5. If the two signals are of opposite polarity, press in the Channel 2 INVERT button to invert the Channel 2 display.

6. Set both VOLTS/DIV switches and both Variable controls so the displays are equal in amplitude.

7. Adjust the A TRIGGER LEVEL control for a stable display.

8. Set the A SEC/DIV switch to a sweep speed which displays about one full cycle on the waveforms.

9. Position the displays and adjust the SEC/DIV Variable control so that one reference-signal cycle occupies exactly 8 horizontal graticule divisions at the 50% rise-time points (see Figure 4-8). Each division of the graticule now represents 45° of the cycle ($360^\circ \div 8$ divisions), and the horizontal graticule calibration can be stated as 45° per division.

10. Measure the horizontal difference between corresponding points on the waveforms at a common horizontal graticule line (50% of rise time) and calculate the phase difference using the following formula:

$$\text{Phase Difference} = \frac{\text{horizontal difference (divisions)}}{\text{horizontal graticule calibration (deg/div)}}$$

Example: The horizontal difference is 0.6 division with a graticule calibration of 45° per division as shown in Figure 4-8.

Substituting the given values into the phase difference formula:

$$\text{Phase difference} = 0.6 \text{ div} \times 45^\circ/\text{div} = 27^\circ$$

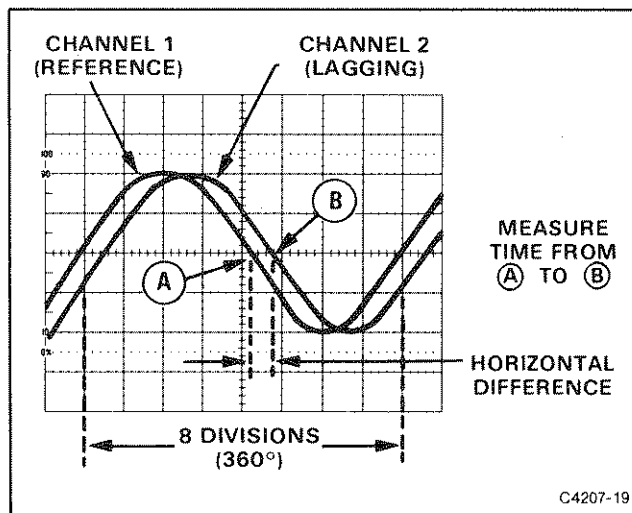


Figure 4-8. Phase difference.

More accurate phase measurements can be made by using the X10 Magnifier function to increase the sweep speed without changing the SEC/DIV Variable control setting.

EXAMPLE: If the sweep speed were increased 10 times with the magnifier (X10 Magnifier button out), the magnified horizontal graticule calibration would be 45°/division divided by 10 (or 4.5°/division). Figure 4-9 shows the same signals illustrated in Figure 4-8, but magnifying the displays results in a horizontal difference of 6 divisions between the two signals.

Substituting the given values in the phase difference formula:

$$\text{Phase difference} = 6 \text{ div} \times 4.5^\circ/\text{div} = 27^\circ$$

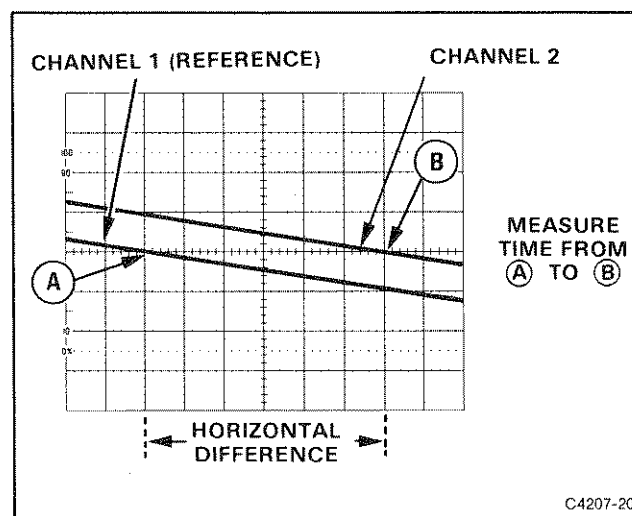


Figure 4-9. High-resolution phase difference.

TELEVISION DISPLAYS

TV Line Signal

The following procedure is used to display a TV Line signal.

1. Preset instrument controls and select P-P AUTO/TV LINE A TRIGGER Mode.

2. Apply the TV signal to either vertical-channel input connector and set the VERTICAL MODE switch to display the channel used.

3. Set the appropriate VOLTS/DIV switch to display 0.3 division or more of composite sync signal.

4. Set the A SEC/DIV switch to 10 μ s.

5. For positive-going TV signal sync pulses, set the A TRIGGER SLOPE switch to OUT and adjust the A TRIGGER LEVEL control to its fully clockwise position; for negative-going TV signal sync pulses, set the A TRIGGER SLOPE switch to IN and adjust the A TRIGGER LEVEL control to its fully counterclockwise position.

NOTE

To examine a TV Line signal in more detail, either the X10 Magnifier or the Delayed-Sweep Magnification feature may be used.

TV Field Signal

The television feature of the 2215A can also be used to display TV Field signals.

1. Preset instrument controls and obtain a baseline trace.

2. Select TV FIELD A TRIGGER mode (push both P-P AUTO and NORM buttons in) and set the A SEC/DIV switch to 2 ms.

3. To display a signal field, connect the TV signal to either vertical-channel input connector and set the VERTICAL MODE switch to display the channel used.

4. Set the appropriate VOLTS/DIV switch to display 1-division or more of composite sync signal.

5. For positive-going TV signal sync pulses, set the A TRIGGER SLOPE switch to OUT and adjust the A TRIGGER LEVEL control to its fully clockwise position; for negative-going TV signal sync pulses, set the A TRIGGER SLOPE switch to IN and adjust the A TRIGGER LEVEL control to its fully counterclockwise position.

6. To change the TV field that is displayed, momentarily interrupt the trigger signal by setting the Input Coupling switch to GND and then back to DC or AC until the desired field is displayed.

NOTE

To examine a TV Field signal in more detail, either the X10 Magnifier or the Delayed-Sweep Magnification feature may be used.

7. To display a selected horizontal line, first trigger the sweep on a vertical (field) sync pulse, then use the "Magnified Sweep Runs After Delay" procedure in this part (steps 5 through 7) to magnify the selected horizontal line for a closer examination. This procedure is useful for examining Vertical Interval Test Signals (VITS).

8. To display either Field 1 or Field 2 individually, connect the TV signal to both CH 1 and CH 2 input connectors and select BOTH and ALT VERTICAL MODE. Set the A SEC/DIV switch to 0.5 ms or faster sweep speed (displays less than one full field). This will synchronize Channel 1 display to one field and Channel 2 to the other field.

DELAYED-SWEEP MAGNIFICATION

The delayed-sweep feature of the 2215A can be used to provide higher apparent magnification than is provided by the X10 Magnifier switch. Apparent magnification occurs as a result of displaying a selected portion of the A trace at a faster sweep speed (B Sweep speed). The A SEC/DIV switch setting determines how often the B trace will be displayed. Since the B Sweep can occur only once for each A Sweep, the A Sweep time duration sets the amount of time elapse between succeeding B Sweeps.

The intensified zone is an indication of both the location and length of the B Sweep interval within the A Sweep interval. Positioning of the intensified zone (i.e., setting the

amount of time between start of the A Sweep and start of the B Sweep) is accomplished with the B DELAY TIME POSITION control. With either ALT or B HORIZONTAL MODE selected and B TRIGGER LEVEL control set fully clockwise (B RUNS AFTER DLY), the B DELAY TIME POSITION control provides continuously variable positioning of the start of the B Sweep. The range of this control is sufficient to place the B Sweep interval at most any location within the A Sweep interval. When ALT HORIZONTAL MODE is selected, the B SEC/DIV switch setting determines the B Sweep speed and concurrently sets the length of the intensified zone on the A trace.

Using delayed-sweep magnification may produce a display with some slight horizontal movement (pulse jitter). Pulse jitter includes not only the inherent uncertainty of triggering the delayed sweep at exactly the same trigger point each time, but also jitter that may be present in the input signal. If pulse jitter needs to be measured, use the "Pulse Jitter Time Measurement" procedure which follows the discussion of "Magnified Sweep Runs After Delay."

Magnified Sweep Runs After Delay

The following procedure explains how to operate the B Sweep in a nontriggered mode and to determine the resulting apparent magnification factor.

1. Preset instrument controls and obtain a baseline trace.
2. Apply the signal to either vertical channel input connector and set the VERTICAL MODE switch to display the channel used.
3. Set the appropriate VOLTS/DIV switch to produce a display of approximately 2- or 3-divisions in amplitude and center the display.
4. Set the A SEC/DIV switch to a sweep speed which displays at least one complete waveform cycle.
5. Select ALT HORIZONTAL MODE. Adjust both the appropriate channel POSITION control and the A/B SWP SEP control to display the A trace above the B trace.
6. Adjust the B DELAY TIME POSITION control to position the start of the intensified zone to the portion of the display to be magnified (see Figure 4-10).

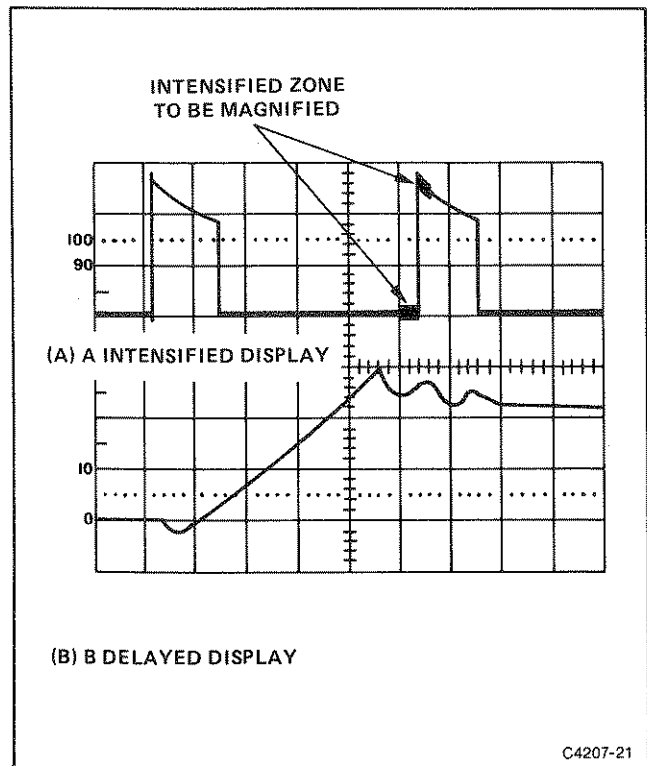


Figure 4-10. Delayed-sweep magnification.

7. Set the B SEC/DIV switch to a setting which intensifies the full portion of the A trace to be magnified. The intensified zone will be displayed as the B trace (see Figure 4-10). The B HORIZONTAL MODE may also be used to magnify the intensified portion of the A Sweep.

8. The apparent sweep magnification can be calculated from the following formula:

$$\text{Apparent Delayed Sweep Magnification} = \frac{\text{A SEC/DIV switch setting}}{\text{B SEC/DIV switch setting}}$$

EXAMPLE: Determine the apparent magnification of a display with an A SEC/DIV switch setting of 0.1 ms per division and a B SEC/DIV switch setting of 1 μs per division.

Substituting the given values:

$$\text{Apparent Magnification} = \frac{1 \times 10^{-4}}{1 \times 10^{-6}} = 10^2 = 100$$

Pulse Jitter Time Measurement

To measure pulse jitter time:

1. Perform steps 1 through 7 of the preceding "Magnified Sweep Runs After Delay" procedure.

2. Referring to Figure 4-11, measure the difference between Point C and Point D in divisions and calculate the pulse jitter time using the following formula:

$$\text{Pulse Jitter Time} = \frac{\text{Horizontal difference (divisions)}}{\text{B SEC/DIV switch setting}}$$

Triggered Magnified Sweep

The following procedure explains how to operate the B Sweep in a triggered mode and to determine the resulting apparent magnification factor. Operating the B Sweep in a triggered mode provides a more stable display, since the delayed display is triggered at the same point each time.

1. Perform steps 1 through 7 of the preceding "Magnified Sweep Runs After Delay" procedure.

2. Adjust the B TRIGGER LEVEL control so the intensified zone on the A trace is stable.

NOTE

The intensified zone seen in the ALT HORIZONTAL MODE display will move from trigger point to trigger point as the B DELAY TIME POSITION control is rotated.

3. The apparent magnification factor can be calculated from the formula shown in step 8 of the "Magnified Sweep Runs After Delay" procedure.

DELAYED-SWEEP TIME MEASUREMENTS

Operating the 2215A Oscilloscope with HORIZONTAL MODE set to either ALT or B will permit time measurements to be made with a greater degree of accuracy than attained with HORIZONTAL MODE set to A. The following procedures describe how these measurements are accomplished.

Time Difference On Single Waveform

To measure time between two points on a waveform, use the following procedure:

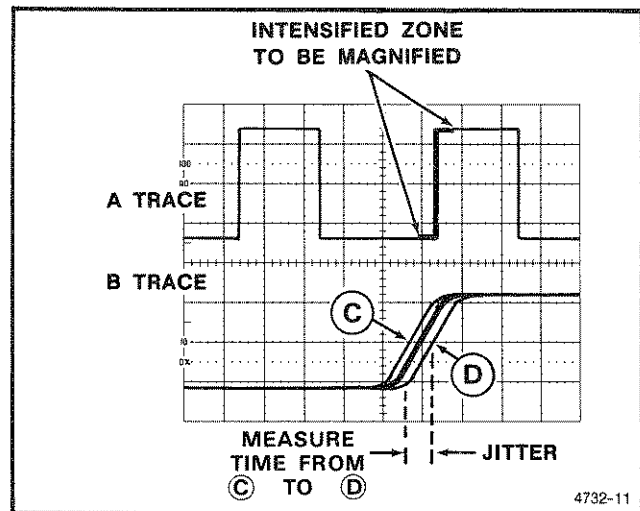


Figure 4-11. Pulse jitter.

1. Preset instrument controls and obtain a baseline trace.

2. Apply the signal to either vertical-channel input connector and set the VERTICAL MODE switch to display the channel used.

3. Set the appropriate VOLTS/DIV switch to produce a display of approximately 2- or 3- divisions in amplitude.

4. Set the A SEC/DIV switch to display the measurement points of interest on the waveform. Ensure that the SEC/DIV Variable control is in the CAL detent.

5. Select ALT HORIZONTAL MODE and adjust both the appropriate vertical POSITION control and A/B SWP SEP control to display the A trace above the B trace (see Figure 4-12).

6. Set the B SEC/DIV switch to the fastest sweep speed that provides a useable (visible) intensified zone.

7. Adjust the B DELAY TIME POSITION control to move the intensified zone to the leading edge on the first point of interest (on the A trace); then fine adjust until the selected portion (on the B trace) is centered at any convenient vertical graticule line (see Figure 4-12).

8. Record the B DELAY POSITION dial setting.

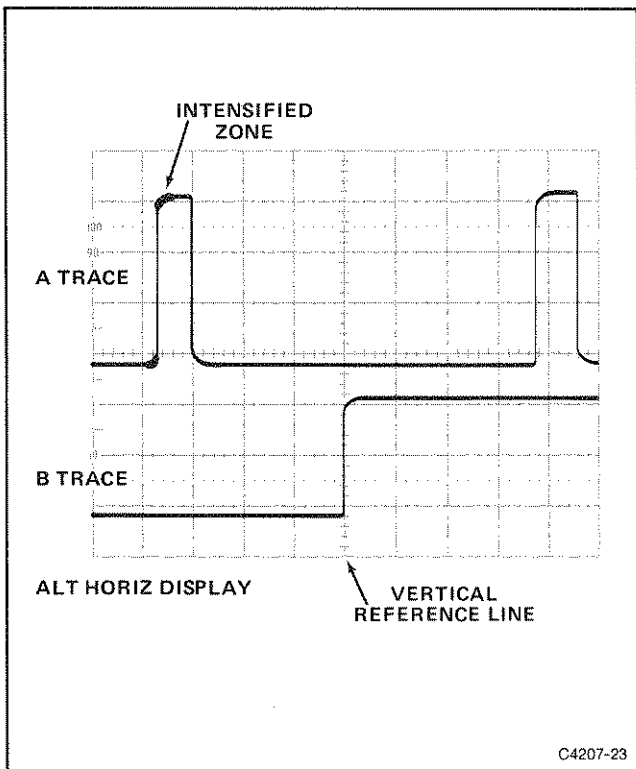


Figure 4-12. Time difference on single waveform.

9. Adjust the B DELAY POSITION control clockwise to move the intensified zone to the leading edge of the second point of interest (on the A trace); then fine adjust until the rising portion (on the B trace) is centered at the same convenient vertical graticule used in preceding step 7.

10. Record the B DELAY TIME POSITION control dial setting.

11. Calculate the time difference between repetitive pulses using the following formula.

$$\text{Time Difference (Duration)} = \left(\begin{array}{c} \text{second} \\ \text{dial} \\ \text{setting} \end{array} - \begin{array}{c} \text{first} \\ \text{dial} \\ \text{setting} \end{array} \right) \left(\begin{array}{c} \text{A SEC/DIV} \\ \text{switch} \\ \text{setting} \end{array} \right)$$

EXAMPLE: With the A SEC/DIV switch set to 0.02 ms per divisions the first B DELAY TIME POSITION dial setting is 1.20 and the second B DELAY TIME POSITION dial setting is 9.53 (see Figure 4-13).

Substituting the given values in the time difference formula:

$$\text{Time Difference} = (9.53 - 1.20) (0.2 \text{ ms/div}) = 1.666 \text{ ms}$$

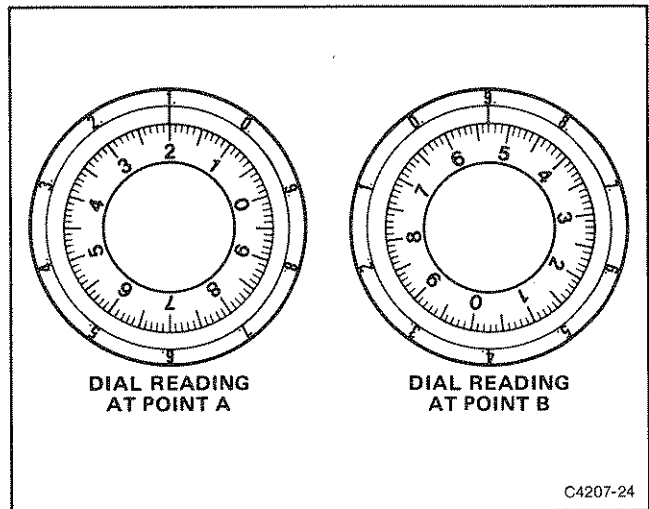


Figure 4-13. B DELAY TIME POSITION control settings.

Rise Time

Rise-time measurements use the same methods as time interval on single waveform, except that the measurements are made between the 10% and 90% points of the low to high transition of the selected waveform. Fall time is measured between the 90% and 10% points of the high to low transition of the waveform.

1. Preset instrument controls and obtain a baseline trace.

2. Apply an exact 5-division signal to either vertical-channel input connector and set the VERTICAL MODE switch to display the channel used.

3. Set the appropriate VOLTS/DIV switch and variable control for an exact 5-division display.

4. Vertically position the trace so that the zero reference of the waveform touches the 0% graticule line and the top of the waveform touches the 100% graticule line.

5. Set the A SEC/DIV switch for a single-waveform display. Ensure that the SEC/DIV Variable control is in the CAL detent.

6. Select ALT HORIZONTAL MODE and set the B SEC/DIV switch to spread the rise-time-measurement portion of the display as much as possible.

7. Select the B HORIZONTAL MODE. Adjust the B DELAY TIME POSITION control until the display intersects the 10% point at the center vertical graticule line (see Figure 4-14, Point A).

8. Record the B DELAY TIME POSITION control dial setting.

9. Adjust the B DELAY TIME POSITION control until the display intersects the 90% point at the center vertical graticule line (see Figure 4-14, Point B).

10. Record the B DELAY TIME POSITION control dial setting.

11. Calculate rise time using the same formula listed in the "Time Difference On Single Waveforms" measurement procedure.

EXAMPLE: With the A SEC/DIV switch set to 1 μ s per division, the first B DELAY TIME POSITION dial setting (Point A) is 2.50 and the second B DELAY TIME POSITION dial setting (Point B) is 7.50.

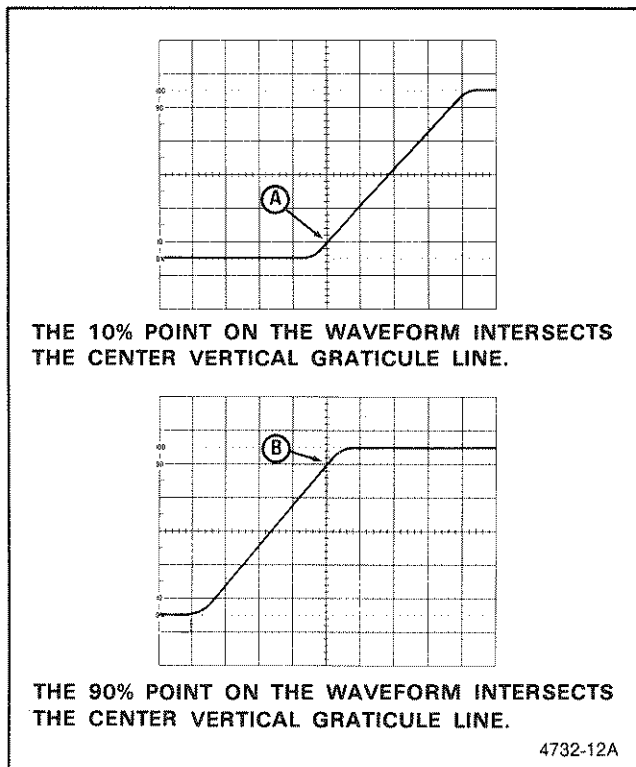


Figure 4-14. Rise time, differential time method.

Substituting the given values in the time difference formula:

$$\text{Rise Time} = (7.50 - 2.50) (1 \mu\text{s}/\text{div}) = 5 \mu\text{s}$$

Time Difference Between Two Pulses On Two Time-Related Signals

1. Preset instrument controls and obtain a baseline trace, then set the VERTICAL MODE to BOTH and ALT.

2. Using probes or cables having equal time delays, apply the reference signal to the Channel 1 input and apply the comparison signal to the Channel 2 input.

3. Set the appropriate VOLTS/DIV switch to produce a display of approximately 2- or 3-divisions in amplitude.

4. Set the A SEC/DIV switch to display the measurement points of interest within the graticule area.

5. Select ALT HORIZONTAL MODE and CH 1 VERTICAL MODE. Adjust both the Channel 1 POSITION control and the A/B SWP SEP control so that the A trace is displayed above the B trace.

6. Rotate the B DELAY TIME POSITION control to move the intensified zone to the appropriate edge of the reference signal (on the A trace); then fine adjust until the edge of the reference signal (on the B trace) is centered at any convenient vertical graticule line (see Figure 4-15 Point A).

7. Record the B DELAY TIME POSITION control dial setting.

8. Select CH 2 VERTICAL MODE and adjust both the Channel 2 POSITION control and the A/B SWP SEP control as necessary to display the A trace above the B trace.

9. Rotate the B DELAY TIME POSITION control to set the appropriate edge of the of the Channel 2 pulse (on the B trace) to the same vertical reference point as used in preceding step 6 (see Figure 4-15, Point B). Observe the A trace to position the intensified zone to the correct pulse (if more than one pulse is displayed). Do not change the setting of the Horizontal POSITION control.

10. Record the B DELAY TIME POSITION control dial setting.

11. Calculate the time difference between the Channel 1 and Channel 2 pulses as in the preceding "Time Difference On Single Waveforms" measurement procedure.

EXAMPLE: With the A SEC/DIV switch set to 50 μ s per division, the dial reading for the reference pulse (Channel 1) is 2.60 and the dial reading for the comparison pulse (Channel 2) is 7.10.

Substituting the given values into the time-difference formula:

$$\text{Time Difference} = (7.10 - 2.60) (50 \mu\text{s}/\text{div}) = 225 \mu\text{s}$$

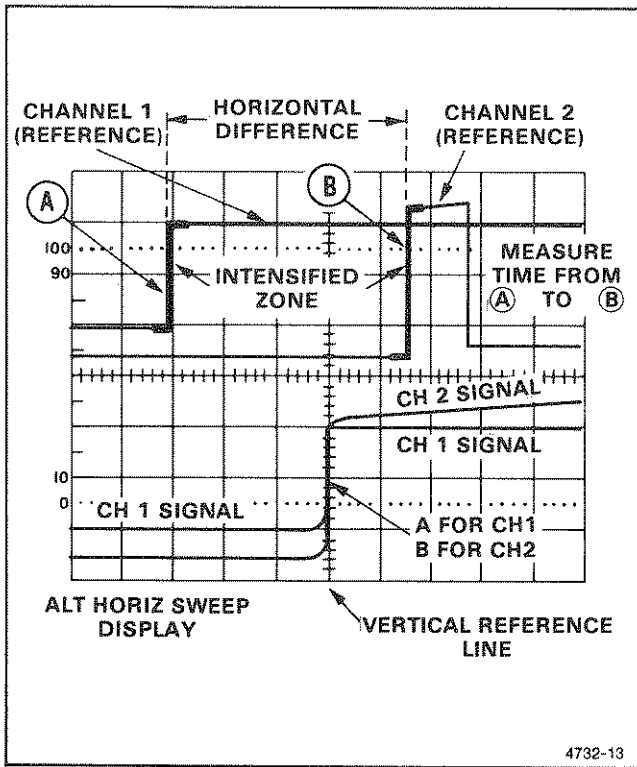


Figure 4-15. Time difference between two pulses on two time-related signals.

OPTIONS AND ACCESSORIES

INTRODUCTION

This section contains a general description of instrument options available at the time of publication of this manual. Also included is a complete list (with Tektronix part number) of standard accessories included with each instrument and a partial list of optional accessories. Additional information about instrument options, option availability, and other accessories can be obtained either by consulting the current Tektronix Product Catalog or by contacting your Tektronix Field Office or representative.

OPTIONS

There are currently no options available for the 2215A.

INTERNATIONAL POWER CORDS

Instruments are shipped with the detachable power-cord configuration ordered by the customer. Descriptive information about the international power-cords is provided in Section 2, "Preparation for Use". The following list identifies the Tektronix part numbers for the available power cords.

Description	Order
Universal Euro 10-16A, 50 Hz	020-0859-00
UK 240 V/13A, 50 Hz	020-0860-00
Australian 240 V/10A, 50 Hz	020-0861-00
North American 240 V/15A, 60 Hz	020-0862-00
Switzerland 220 V/10A, 50 Hz	020-0863-00

STANDARD ACCESSORIES

The following standard accessories are provided with each instrument.

Qty	Description	Order
2	Probes, 10X 1.5-meter length with accessories	010-6122-01
1	Power Cord	161-0104-00
1	Operators Manual	070-4732-00

OPTIONAL ACCESSORIES

The following optional accessories are recommended for use with the 2215A Oscilloscope.

Description	Order
Service Manual	070-4735-00
Protective Front Panel Cover	200-2520-00
Cord Wrap and Storage Pouch	016-0677-00
Protective Front Panel Cover, Cord Wrap, and Storage Pouch	020-0672-00
Carrying Strap	346-0199-00
Low-Cost, General-Purpose Camera ...	C-5C Option 04
Rackmount Adapter Kit	016-0466-00
SCOPE-MOBILE CART-Occupies less than 18 inches of aisle space, with storage area in base	Model 200C

