



**PLEASE CHECK FOR CHANGE INFORMATION  
AT THE REAR OF THIS MANUAL.**

**496/496P  
SPECTRUM ANALYZER**

**OPERATORS**

**INSTRUCTION MANUAL**

**Tektronix, Inc.  
P.O. Box 500  
Beaverton, Oregon 97077**

Serial Number \_\_\_\_\_

070-3480-00

First Printing APR 1981  
Revised JUN 1982

Copyright © 1981 Tektronix, Inc. All rights reserved.  
Contents of this publication may not be reproduced in  
any form without the written permission of Tektronix, Inc.

Products of Tektronix, Inc. and its subsidiaries are  
covered by U.S. and foreign patents and/or pending  
patents.

TEKTRONIX, TEK, SCOPE-MOBILE, and  are  
registered trademarks of Tektronix, Inc. TELEQUIP-  
MENT is a registered trademark of Tektronix U.K.  
Limited.

Printed in U.S.A. Specification and price change  
privileges are reserved.

# TABLE OF CONTENTS

	Page		Page
LIST OF ILLUSTRATIONS .....	iii	<b>Section 3</b>	<b>OPERATION (cont)</b>
LIST OF TABLES .....	iii		
OPERATORS SAFETY SUMMARY .....	v		3. Calibrate Reference Level and Dynamic Range ..... 3-8
SERVICE SAFETY SUMMARY .....	vii		Functional or Operational Check. .... 3-8
<b>Section 1</b>			1. Check Operation of Front-Panel Push Buttons and Controls ... 3-9
<b>GENERAL INFORMATION AND SPECIFICATION</b>			2. Check Frequency Readout Accuracy ..... 3-11
General Information .....	1-1		3. Check Frequency Span/Div Range and Accuracy ..... 3-11
Introduction .....	1-1		4. Check Resolution Bandwidth and Shape Factor ..... 3-11
Standards, Documents, and References Used .....	1-1		5. Check Reference Level Gain and RF Attenuation Steps. .... 3-12
Change and History Information ..	1-1		6. Check Sensitivity ..... 3-13
Product Description .....	1-1		7. Frequency Drift ..... 3-14
Specification .....	1-2		8. Check Residual FM ..... 3-14
Electrical Characteristics .....	1-2		9. Digital Storage ..... 3-15
Frequency Related .....	1-2		General Operating Information ..... 3-16
Amplitude Related .....	1-4		Firmware Version and Error
Input Signal Characteristics ...	1-7		Message Readout ..... 3-16
Output Signal Characteristics ..	1-7		Crt Light Filters ..... 3-16
General Characteristics .....	1-8		Intensity Level, Focus, and
Power Requirements .....	1-8		Beam Alignment ..... 3-16
Environmental Characteristics ...	1-9		Signal Application ..... 3-16
Physical Characteristics .....	1-11		RF INPUT Connector ..... 3-16
Accessories .....	1-12		Amplitude Conversion ..... 3-17
Options .....	1-12		Connecting to 75 $\Omega$ Source ... 3-17
Options for Power Cord Configuration	1-13		Resolution Bandwidth, Frequency Span, and Sweep Time ..... 3-18
<b>Section 2</b>			Phaselock Operation ..... 3-18
<b>INSTALLATION AND REPACKAGING</b>			Using the Video Filter ..... 3-19
Introduction .....	2-1		Zero Span Operation ..... 3-19
Unpacking and Initial Inspection ...	2-1		Triggering the Display ..... 3-19
Preparation For Use .....	2-1		Sweeping the Display ..... 3-19
Power Source and Power Require- ments .....	2-1		Manual Scan of the Spectrum ... 3-20
Repackaging for Shipment .....	2-2		Reference Level, RF Attenuation, and Vertical Display ..... 3-20
<b>Section 3</b>			Delta A Mode ..... 3-20
<b>OPERATION</b>			MIN NOISE/MIN DISTORTION .. 3-21
Controls, Indicators, and Connectors	3-1		Digital Storage ..... 3-21
Firmware Version and Error			496P GPIB Controls, Indicators, and Connectors ..... 3-22
Message Readout .....	3-6		Reset to Local (REMOTE).... 3-22
Turn-on Procedure and Preparation For Use .....	3-6		496P TALK/LISTEN-Only Operation ..... 3-25
1. Initial Turn On .....	3-6		
2. Calibrate Center Frequency Readout .....	3-7		

# TABLE OF CONTENTS (cont)

Section 3	OPERATION (cont)	Page
	Data Logging . . . . .	3-26
	Restoring Control Settings and Display . . . . .	3-27
	Connecting to a System . . . . .	3-27
	Operational Precautions . . . . .	3-27
	1. Signal FM . . . . .	3-27
	2. Correct Trigger Mode . . . . .	3-27
	3. Level of Pulsed Signals . . . . .	3-27
	4. Level of Continuous Wave Signals . . . . .	3-28
	5. Excessive Input Signal Level . . . . .	3-28
	6. No Crt Trace . . . . .	3-28
	7. Digital Storage Effects on Signal Analyses . . . . .	3-28
	8. Stored Display Averaged in Wide Spans . . . . .	3-28
	9. Cold Storage or Power-Interrupt Initialization . . . . .	3-28
	Service Manual . . . . .	3-28
	Product Service . . . . .	3-28
<b>Section 4</b>	<b>OPTION INFORMATION . . . . .</b>	<b>4-1</b>
<b>Appendix A</b>	<b>GLOSSARY . . . . .</b>	<b>A-1</b>
	<b>CHANGE INFORMATION</b>	

# LIST OF ILLUSTRATIONS

Fig. No.		Page	Fig. No.		Page
1-1	Probe Power Connector .....	1-9	3-9	Volts-dBm-Watts conversion chart for 50 $\Omega$ impedance .....	3-17
1-2	Dimensions .....	1-11	3-10	Circuit of a 75 $\Omega$ to 50 $\Omega$ matching pad (ac coupled) .....	3-18
1-3	International power and plug configuration for the 496 .....	1-13	3-11	Graph to illustrate the relationship between dBm, dBmV, and dB $\mu$ V (matching attenuator included where necessary) .....	3-18
3-1	Front panel selectors, controls, and connectors .....	3-1	3-12	Integrating the display with the Video Filter .....	3-12
302	Rear panel connectors .....	3-5	3-13	GPIB control and indicators on the front panel .....	3-22
3-3	Crt readout for power-up state .....	3-6	3-14	Status of GPIB functions indicated when active .....	3-23
3-4	Typical display of calibrator markers in MAX SPAN position .....	3-7	3-15	The 496P GPIB port and switches .....	3-24
3-5	Display that illustrates how bandwidth and shape factor are determined .....	3-12	3-16	GPIB address, LF, DOI, TALK-ONLY and LISTEN-ONLY switches .....	3-25
3-6	Typical display using digital storage with MAX HOLD activated, to measure drift ...	3-14	3-17	The TEKTRONIX 4924 Digital Cartridge ..	3-25
3-7	Display to illustrate how residual FM is measured .....	3-15	3-18	Controls on the 4924 and 496P used for the TALK/LISTEN only data transfers .....	3-26
3-8	Using digital storage to measure the differential between two events .....	3-16			

# LIST OF TABLES

Table		Page
1-1	Electrical Characteristics .....	1-2
1-2	Environmental Characteristics .....	1-9
1-3	Physical Characteristics .....	1-11
2-1	Shipping Carton Test Strength .....	2-2

1  
2  
3  
4  
5  
6  
7  
8  
9  
10  
11  
12  
13  
14  
15  
16  
17  
18  
19  
20  
21  
22  
23  
24  
25  
26  
27  
28  
29  
30  
31  
32  
33  
34  
35  
36  
37  
38  
39  
40  
41  
42  
43  
44  
45  
46  
47  
48  
49  
50  
51  
52  
53  
54  
55  
56  
57  
58  
59  
60  
61  
62  
63  
64  
65  
66  
67  
68  
69  
70  
71  
72  
73  
74  
75  
76  
77  
78  
79  
80  
81  
82  
83  
84  
85  
86  
87  
88  
89  
90  
91  
92  
93  
94  
95  
96  
97  
98  
99  
100

## OPERATORS SAFETY SUMMARY

The general safety information in this part of the summary is for both operating and servicing personnel. Specific warnings and cautions will be found throughout the manual where they apply, but may not appear in this summary.

### TERMS

#### In This Manual

CAUTION statements identify conditions or practices that could result in damage to the equipment or other property.

WARNING statements identify conditions or practices that could result in personal injury or loss of life.

#### As Marked on Equipment

CAUTION indicates a personal injury hazard not immediately accessible as one reads the marking, or a hazard to property including the equipment itself.

DANGER Indicates a personal injury hazard immediately accessible as one reads the marking.

### SYMBOLS

#### In This Manual



This symbol indicates where applicable cautionary or other information is to be found.

#### As Marked on Equipment



DANGER — High voltage.



Protective ground (earth) terminal.



ATTENTION — refer to manual

#### Power Source

This product is intended to operate from a power source that will not apply more than 250 volts rms between the supply conductors or between either supply conductor and ground. A protective ground connection by way of the grounding conductor in the power cord is essential for safe operation.

### **Grounding the Product**

This product is grounded through the grounding conductor of the power cord. To avoid electrical shock, plug the power cord into a properly wired receptacle before connecting to the product input or output terminals. A protective ground connection by way of the grounding conductor in the power cord is essential for safe operation.

### **Danger From Loss of Ground**

Upon loss of the protective-ground connection, all accessible conductive parts (including knobs and controls that may appear to be insulating) can render an electric shock.

### **Use the Proper Power Cord**

Use only the power cord and connector specified for your product.

Use only a power cord that is in good condition.

For detailed information on power cords and connectors, see Fig. 1-3.

Refer cord and connector changes to qualified service personnel.

### **Use the Proper Fuse**

To avoid fire hazard, use only the fuse of correct type, voltage rating and current rating as specified in the parts list for your product.

Refer fuse replacement to qualified service personnel.

### **Do Not Operate in Explosive Atmospheres**

To avoid explosion, do not operate this product in an explosive atmosphere unless it has been specifically certified for such operation.

### **Do Not Remove Covers or Panels**

To avoid personal injury, do not remove the product covers or panels. Do not operate the product without the covers and panels properly installed.



# **SERVICE SAFETY SUMMARY**

## **FOR QUALIFIED SERVICE PERSONNEL ONLY**

*Refer also to the preceding Operators Safety Summary.*

### **Do Not Service Alone**

Do not perform internal service or adjustment of this product unless another person capable of rendering first aid and resuscitation is present.

### **Use Care When Servicing With Power On**

Dangerous voltages exist at several points in this product. To avoid personal injury, do not touch exposed connections and components while power is on.

Disconnect power before removing protective panels, soldering, or replacing components.

### **Power Source**

This product is intended to operate from a power source that will not apply more than 250 volts rms between the supply conductors or between either supply conductor and ground. A protective ground connection by way of the grounding conductor in the power cord is essential for safe operation.

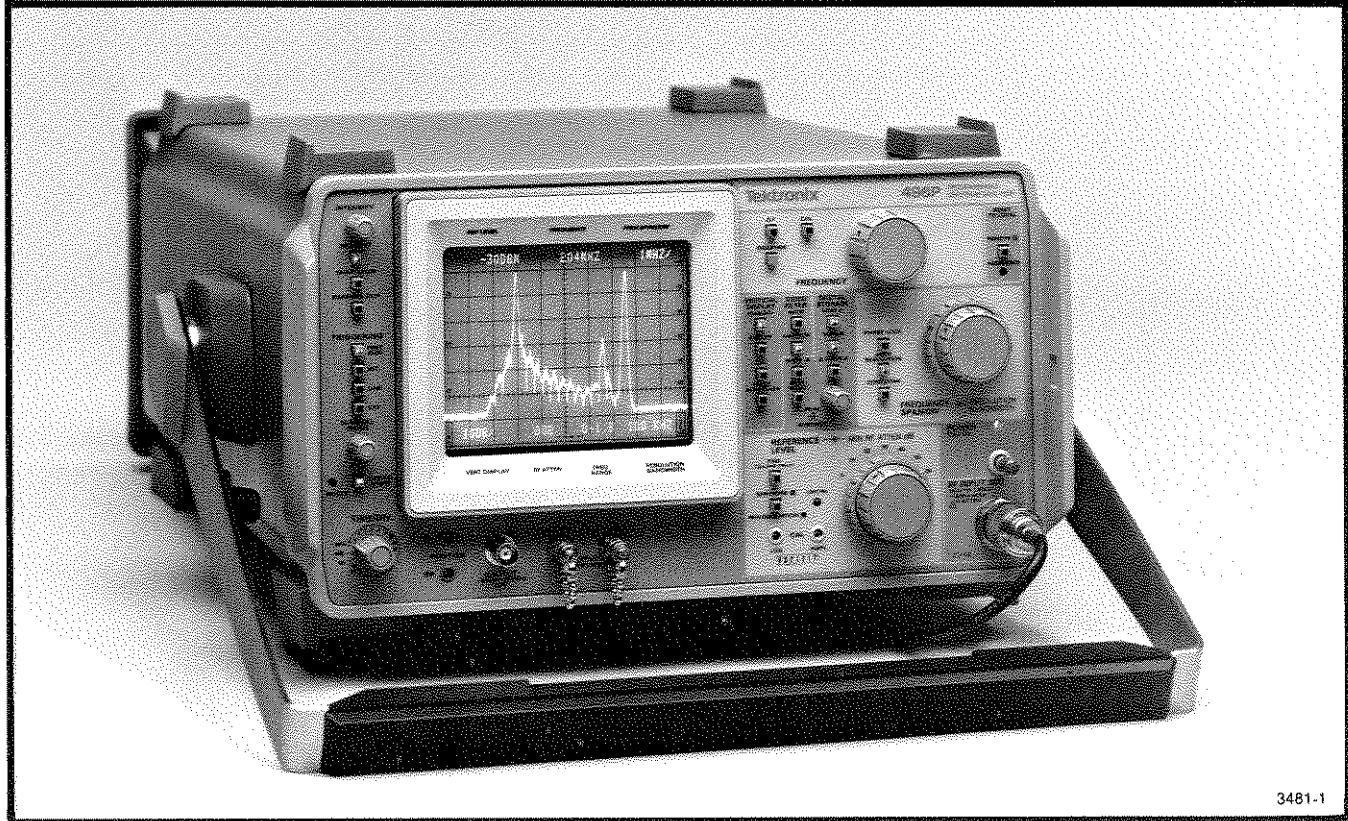
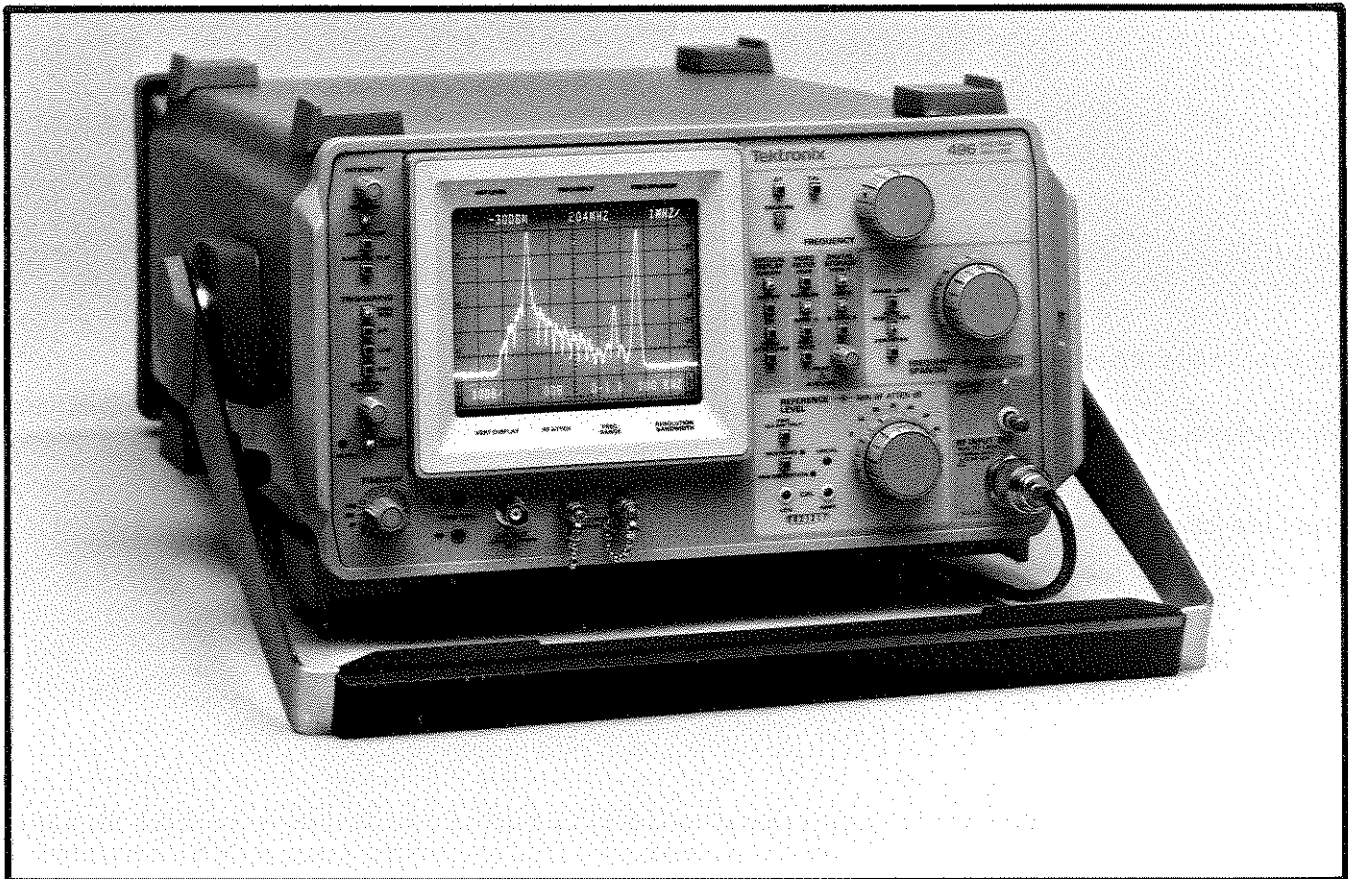

3481-1

The 496/496P Spectrum Analyzer.

# GENERAL INFORMATION AND SPECIFICATION

## GENERAL INFORMATION

### Introduction

This manual contains information pertinent to the installation and operation of the 496/496P Spectrum Analyzer. Contents and organization of the manual are described in the Table of Contents preceding this section. These instructions assume the user is knowledgeable in the frequency domain analysis. The intent is to provide information necessary to effectively operate the 496/496P. Service information is in two separate service manuals.

### Standards, Documents, and References Used

Terminology used in the manual is in accordance with industry practice. Abbreviations are in accordance with ANSI Y1.1-1972, with exceptions and additions explained in parentheses after the abbreviation. Graphic symbology is based on ANSI Y32.2-1975. Logic symbology is based on ANSI Y32.14-1973 and the manufacturer's data books or sheets. A copy of ANSI standards may be obtained from the Institute of Electrical and Electronic Engineers, 345 47th Street, New York, NY 10017.

### Change and History Information

Change information that involves manual corrections and/or additional data is located at the back of the manual in the CHANGE INFORMATION section.

History information with the updated data is integrated into the text or diagrams when a page or diagram is updated.

### Product Description

The 496/496P Spectrum Analyzer is a high performance, compact, portable spectrum analyzer that displays absolute amplitude and frequency information of signals within the frequency spectrum of 1 kHz to 1.8 GHz.

Here are the highlights of the 496 Spectrum Analyzer. Operation is simplified through the use of an internal microcomputer. Display dynamic range is 80 dB with calibrated reference level readout from  $-123$  dBm to  $+40$  dBm, in 10 dB and 1 dB steps. When using the  $\Delta A$  mode, to measure the amplitude difference between two signals, the steps are 0.25 dB. Resolution bandwidths are from 30 Hz to 1 MHz, using decade steps above 100 Hz. Shape factor is 15:1 or less for 30 Hz and 7.5:1 or less for greater bandwidths. Intermodulation products are: 70 dB or more down, harmonic distortion is  $-60$  dBc or better. Sensitivity is  $-127$  dBm to 1.8 GHz, at the 30 Hz resolution bandwidth. Frequency response is  $\pm 1.5$  dB. Digital storage features peak detection and digital signal averaging.

The 496P adds remote control capability to the features of the 496. The front-panel controls (except those intended for local use, such as INTENSITY and POSITION controls) can be remotely operated through the GPIB port allowing the 496P to be used with a variety of systems and controllers. This operation is described in detail in the Programmer's manual.

# SPECIFICATION

The following list of instrument characteristics and features apply to the basic 496/496P Spectrum Analyzer after a 30 minute warmup, except as noted.

Service Instructions. The Performance Check procedures require sophisticated equipment as well as technical expertise to perform.

The Performance Requirement column describes the limits of the characteristic, and the Supplemental column describes features and typical values or information that may be useful to the user. Procedures to verify performance requirements are provided in the Calibration section of the

The Operators manual contains a procedure that checks all functions of the 496/496P. This check is recommended for incoming inspections to verify that the instrument is performing properly.

**Table 1-1  
ELECTRICAL CHARACTERISTICS**

Characteristic	Performance Requirement	Supplemental Information
<b>FREQUENCY RELATED</b>		
Center Frequency Range		0 MHz to 1800 MHz
Accuracy after 1 hour warm up over CF range	$\pm(5 \text{ MHz} + 20\% \text{ of span/div})$	
TUNE command accuracy (after 2 hour warmup—applies only to 496P under remote control)		
Span/Div > 50 kHz	$\pm 7\%$ of frequency or $\pm 75 \text{ kHz}$ whichever is greater	
Span/Div $\leq 50 \text{ kHz}$	$\pm 7\%$ of frequency or $\pm 100 \text{ Hz}$ , whichever is greater	
Repeatability of frequency setting (ambient temperature change must be $10^\circ\text{C}$ —applies only to 496P under remote control)		$\pm(2 \text{ MHz} + 10\% \text{ of span/div})$ or $\pm(0.1\% \text{ of frequency} + 10\% \text{ of span/div})$ of previous settings to the same frequency, whichever is greater
Delta Frequency readout accuracy after 2 hour warmup, span/div $\leq 50 \text{ kHz}$	$\pm 5\%$ of the Delta Frequency readout	For span/div > 50 kHz, readout is in MHz; for span/div < 50 kHz, readout is in kHz
Readout Resolution		Within 1 MHz
Residual FM (short term)		
Phase Lock On	$\leq 10 \text{ Hz p-p over } 20 \text{ ms}$	Video Filter Off
Phase Lock Off	$\leq 1 \text{ kHz p-p over } 20 \text{ ms}$	Video Filter Off

Table 1-1 (cont)

Characteristic	Performance Requirement	Supplemental Information
FREQUENCY RELATED (cont)		
Frequency Drift Excursion (at constant temperature and fixed center frequency)		
Phaselock On		
After 30 minute warmup	≤3.3 kHz in 10 min	≤20 kHz in 1 hour
After 1 hour warmup	≤330 Hz in 10 min	≤2 kHz in 1 hour
Phaselock Off		
After 1 hour warmup	≤33 kHz in 10 min	≤200 kHz in 1 hour
"Static" Resolution Bandwidth (−6 dB)	30 Hz, then 100 Hz to 1 MHz in decade steps, plus an AUTO position Resolution bandwidth is within 20% of selected bandwidth	In AUTO position the bandwidth is selected by an internal computer, depending on the settings of the FREQUENCY SPAN/DIV, TIME/DIV, VERTICAL DISPLAY, and VIDEO FILTER controls. The FREQUENCY SPAN/DIV controls the bandwidth when both TIME/DIV and RESOLUTION BANDWIDTH are set to AUTO
Shape Factor (60 dB/6 dB)	7.5:1 or less 15:1 or less for 30 Hz resolution bandwidth	
Phaselock Noise Sidebands	At least 75 dBc at 30 times the resolution bandwidth offset from the center frequency (70 dBc for 100 Hz resolution bandwidth or less)	
Video Filter		
Narrow		Reduces video bandwidth to approximately 1/300th of selected resolution bandwidth and 1/100th for 30 Hz bandwidth
Wide		Reduces video bandwidth to approximately 1/30th of selected resolution bandwidth and 1/10th for 30 Hz bandwidth

Table 1-1 (cont)

Characteristic	Performance Requirement	Supplemental Information
FREQUENCY RELATED (cont)		
Frequency Span/Div Range		From 50 Hz/div to 100 MHz/div in a 1-2-5 sequence
MAX Span		When selected, the entire effective frequency range is scanned and displayed
Zero Span		When selected, the horizontal axis of the crt is calibrated in time (instead of frequency). The span/div readout is changed to time/div
Accuracy	Within 5% of the selected span/div over the center eight divisions of the ten-division crt display	
Frequency Response and Display Flatness 1 kHz to 1.8 GHz	$\pm 1.5$ dB	Frequency response is measured with RF attenuation $\geq 10$ dB. The response figure includes the effects of input vswr, mixer, and gain variations. Variations in display flatness contribute about 1 dB to the response figure
AMPLITUDE RELATED		
Vertical Display Modes		10 dB/div, 2 dB/div Linear, and $\Delta A$
Reference Level (full screen, top of graticule) Range		- 123 dBm to +40 dBm (+40 dBm includes a maximum safe input of +30 dBm and 10 dB of IF gain reduction for 10 dBV/div and 2 dB/div log modes 20 nV/div to 2 V/div (1 W maximum safe input) in LIN mode
Steps		10 dB, 1 dB, and 0.25 dB for relative ( $\Delta$ ) measurements in log mode 1-2-5 sequence and 1 dB equivalent increments in LIN mode

Table 1-1 (cont)

Characteristic	Performance Requirement	Supplemental Information
AMPLITUDE RELATED (cont)		
Reference Level (full screen, top of graticule) (cont.)  Accuracy		Accuracy is a function of changes in RF attenuation, resolution bandwidth, display mode, and reference level  See amplitude accuracies of these functions  The RF attenuator steps 10 dB for reference level changes above $-30$ dBm ( $-20$ dBm when MIN NOISE is active) unless MIN RF ATTENUATION is greater than normal  The IF gain increases 10 dB for each 10 dB reference level change below $-30$ dBm ( $-20$ dBm when MIN NOISE is active)
Display Dynamic Range		80 dB at 10 dB/div, 16 dB at 2 dB/div, and 8 divisions in LIN mode
Accuracy	$\pm 1.0$ dB/10 dB to a maximum cumulative error of $\pm 2.0$ dB over the 80 dB window and $\pm 0.4$ dB/2 dB to a maximum cumulative error of $\pm 1.0$ dB over the 16 dB window	
	LIN mode is 5% of full scale	
RF Attenuator		
Range		0 to 60 dB in 10 dB steps
Accuracy 1 kHz to 1.8 GHz	Within 0.3 dB/10 dB to maximum of 0.7 dB over the 60 dB range	
IF Gain		
Range		83 dB of gain increase, 10 dB of gain decrease (with MIN NOISE activated) in 10 dB and 1 dB steps
Accuracy	Within 0.2 dB/1 dB except at the 10 dB reference level transition from $-29$ to $-30$ dBm, $-39$ to $-40$ dBm, $-49$ to $-50$ dBm, $-59$ to $-60$ dBm, and $-69$ to $-70$ dBm, where the accuracy is 0.5 dB; and within 0.5 dB/10 dB to a maximum of $\pm 2$ dB over the 90 dB range	

Table 1-1 (cont)

Characteristic	Performance Requirement	Supplemental Information		
AMPLITUDE RELATED (cont)				
Gain Variation between Resolution Bandwidths	<0.5 dB	Measured at -20 dB REF LEVEL and 10 dB RF ATTEN		
Differential Amplitude		ΔA mode provides differential measurement in 0.25 dB increments		
Accuracy		dB difference	Steps	Error
		0.2 dB	1	0.05 dB
		2.0 dB	8	0.4 dB
		10.0 dB	40	1.0 dB
		50.0 dB	200	2.0 dB
		Within the reference level range of -123 dBm to +30 dBm		
Range	From 10 dB above to 40 dB below the reference level established when the ΔA mode was activated	Do not use the ΔA mode outside the +30 dBm to -123 dBm reference level range. Total range is at least 50 dB		
Equivalent Input Noise Sensitivity				
Resolution Bandwidth				
30 Hz	-127 dBm			
100 Hz	-123 dBm			
1 kHz	-115 dBm			
10 kHz	-105 dBm			
100 kHz	-95 dBm			
1 MHz	-85 dBm			
Spurious Response				
Residual (no input signal, referenced to mixer input)	-100 dBm or less			
Third-order Intermodulation Distortion (MIN DISTORTION mode)	At least -70 dBc below any two on-screen signals within any frequency span			
Harmonic Distortion (cw signal, MIN DISTORTION mode)	At least -60 dBc for a full-screen signal			
Zero Frequency Spur (referenced to input mixer)	-20 dBm or less			



Table 1-1 (cont)

Characteristic	Performance Requirement	Supplemental Information
INPUT SIGNAL CHARACTERISTICS		
RF INPUT		Type N female connector
Input Impedance		50 ohm; vswr 1:45 maximum with 10 dB or more RF attenuation
Input Level		
Optimum level for linear operation		−30 dBm referred to input mixer. Full screen not exceeded and MIN DISTORTION control setting
1 dB compression point	−18 dBm, no RF attenuation	
Maximum Input level		
RF attenuation at 0 dB		+30 dBm typical, (limited by mixer burnout)
With 20 dB or more RF attenuation		+30 dBm (1 W) continuous, 75 W peak, pulse width 1 $\mu$ s or less with a maximum duty factor of 0.001 (attenuation limit) <b>NEVER apply dc to the RF INPUT.</b>
LO Emissions (referenced to input mixer)	Less than −70 dBm to 18 GHz	
EXT IN HORIZ/TRIG		Dc coupled input for horizontal drive; Ac coupled for trigger signal
Input voltage range		
Sweep		0 to 10 V $\pm$ 10% (dc + peak ac) for full screen deflection
Trigger	1.0 V peak (minimum) Frequency range 15 Hz to 1 MHz	Maximum input: 50 V (dc + peak ac) Maximum ac input: 30 V rms to 10 kHz, then derate linearity to 3–5 V rms at 100 kHz and above. Pulse width is 0.1 $\mu$ s minimum
ACCESSORY (J104)		This connector is for future applications
OUTPUT SIGNAL CHARACTERISTICS		
Calibrator (CAL OUT)	−20 dBm $\pm$ 0.3 dB at 100 MHz $\pm$ 1.7 kHz	Comb markers are provided for frequency and span calibration
1st and 2nd LO		Provides access to the output of the respective local oscillators (1st LO +7.5 dBm minimum to a maximum of +15 dBm, 2nd LO −16 dBm minimum to a maximum of +15 dBm)  These ports must be terminated in 50 $\Omega$ at all times

Table 1-1 (cont)

Characteristic	Performance Requirement	Supplemental Information
OUTPUT SIGNAL CHARACTERISTICS (cont)		
Vertical	Provides 0.5 V, $\pm 5\%$ of signal per division of video above and below the centerline	Source impedance approximately 1 k $\Omega$
Horiz Out	Provides 0.5 V either side of center Full range -2.5 V to +2.5 V, $\pm 10\%$	Source impedance approximately 1 k $\Omega$
Pen Lift		TTL compatible, nominal +5 V to lift pen
IF Out		Output of the 10 MHz IF level is approximately -16 dBm for a full screen signal at -30 dBm input reference level Nominal impedance 50 $\Omega$
IEEE Std 488-1978 Port (GPIB) 496P Only		In accordance with IEEE 488 standard
Probe Power		Provides operating voltages (+5 V, +15 V, -15 V, and Ground) for active probes (see Fig. 1-1)

GENERAL CHARACTERISTICS

Sweep		
Sweep Time	20 $\mu$ s/div to 5 s/div in 1-2-5 sequence (10 s/div in Auto)	Triggered, auto, manual, and external
Accuracy	$\pm 5\%$	
Triggering	$\geq 2.0$ division of signal for internal  Lowest external trigger level is 1 V peak	Internal, external, free run, and single sweep  External is ac coupled (15 Hz to 1 MHz)  Largest allowable external trigger is 50 V (dc + peak ac)
Crt Readout		Displays: reference level, frequency, frequency span/div, vertical display, RF attenuation, and resolution bandwidth

POWER REQUIREMENTS

Characteristic	Description
Input Voltage	90 to 132 Vac or 180 to 250 Vac, 48 to 440 Hz
Power	210 Watts maximum, 3.2 amperes, at 115 V and 60 Hz
Leakage Current	5 mA peak

NOTE

*If power to this instrument is interrupted, it may be necessary to re-initialize the microcomputer; when power is restored, turn the POWER switch Off for 5 seconds then back On.*

**PROBE POWER.** The PROBE POWER connector on the rear panel of this instrument provides operating power for active probe systems. It is not recommended that these connectors be used as a power source for applications other than the compatible probes or other accessories which are specifically designed for use with this source.

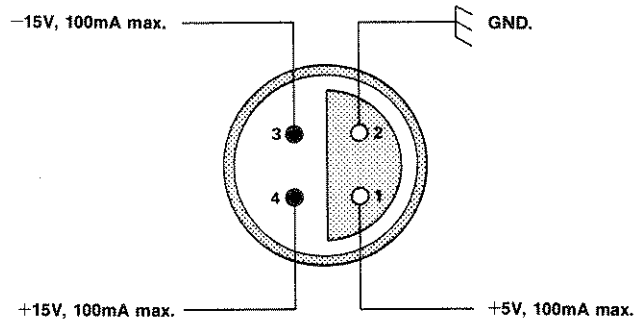

2726-21

Fig. 1-1. Probe Power Connector.

Table 1-2  
ENVIRONMENTAL CHARACTERISTICS

Meets MIL T-28800B, Type III, Class 3, style C specifications as follows:

Characteristic	Description
Temperature	
Operating and Humidity	-15°C to +55°C/95% (+5%, -0%) relative humidity
Non-operating	-62°C to +75°C

NOTE

After storage at temperatures below the operating range, the microcomputer may not initialize on power-up. If so, allow the instrument to warm up for 15 minutes and re-initialize the microcomputer by turning the POWER Off for 5 seconds then back On.

Table 1-2 (cont)

Characteristic	Description	
Altitude Operating Non-operating	4,500 m (15,000 feet) 12,000 m (40,000 feet)	
Humidity (Non-operating)	Five cycles (120 hours) of MIL-Std-810	
Vibration Operating	Method 507, Procedure 4 (modified)  Resonant searches along all three axes at 0.025 inch p-p, frequency varied from 10—55 Hz for 15 minutes  All resonances must be minimum per axis plus dwell at resonant frequency, or 55 Hz, for 10 minutes minimum per axis  Instrument is secured to vibration platform during test  Total vibration time is 75 minutes	
Shock (Operating and Non-operating)	Three shocks of 30 G, one-half sine, 11 ms duration each direction along each major axis (total of 18 guillotine-type shocks)	
Transit drop (free fall)	12 inch, one per each of the six faces and eight corners	
Electromagnetic Interference (EMI)	Within limits described in MIL-Std-461	
Conducted emissions	<b>Test Method</b>	<b>Remarks</b>
	CE01 CE03 20 kHz to 50 MHz on power leads	10 kHz to 20 kHz only Except 30 to 35 kHz, relaxed by 15 dB
Conducted susceptibility	CS01 30 Hz to 50 kHz on power leads	Full limits
	CS02 50 kHz to 400 kHz on power leads	Full limits
	CS06 Spikes on power leads	Full limits
Radiated emissions	RE01 30 Hz to 30 kHz magnetic field	Relaxed by 10 dB for fundamental, 2nd, and 3rd harmonic of power line
	RE02 14 ± 3 kHz to 10 GHz	Full limit
Radiated susceptibility	RS01 30 Hz to 30 kHz magnetic field	Full limit
	RS03 Up to 10 GHz	Full limit

Table 1-3  
PHYSICAL CHARACTERISTICS

Characteristics	Description
Weight (standard accessories and cover except manuals)	42 pounds (20.5 kg) maximum
Dimensions (Fig. 1-2)	
Without front cover and handle or feet	6.9 X 12.87 X 19.65 inches (17.5 cm X 32.69 X 49.91 cm)
With front cover, feet and handle	9.15 X 15.03 X 23.1 inches (handle folded back over instrument), 25.85 inches (handle fully extended)

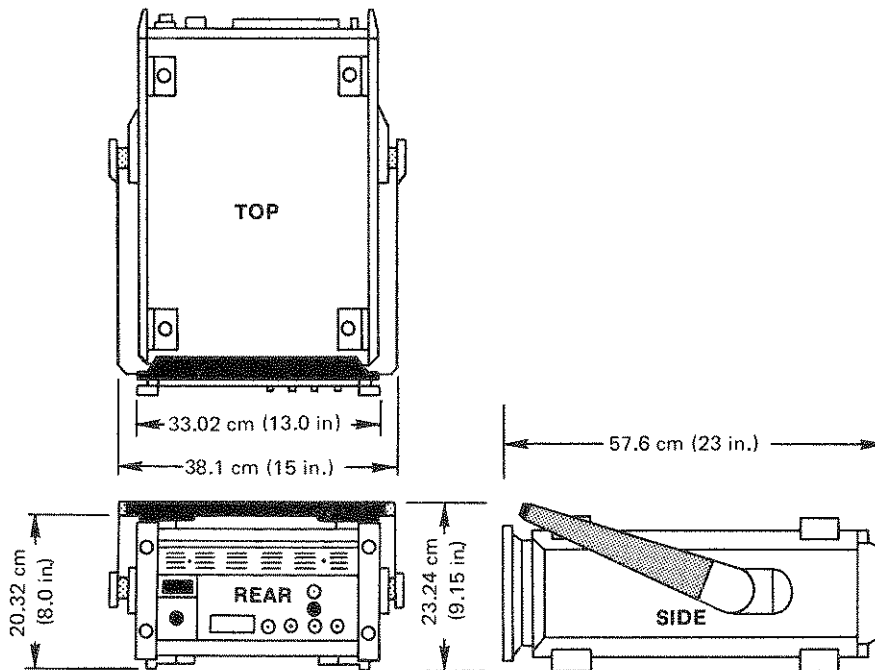

2726-10B

Fig. 1-2. Dimensions.

## ACCESSORIES

Refer to the Accessories page following the Replaceable Mechanical Parts list in the 496/496P Service manual Vol. 2.

## OPTIONS

Options available for the 496/496P and their resultant changes to the specifications are listed below. Options are factory installed at the time of the initial order. Contact your local Tektronix Field Office for additional information.

### OPTION 30

Rackmount version of 496/496P Spectrum Analyzer.

### OPTION 31

Rackmount version of 496/496P with cables from front panel connectors to connectors at the back of the cabinet.

### OPTION 32

Benchtop version of 496/496P Spectrum Analyzer.

# OPTIONS FOR POWER CORD CONFIGURATION

Tektronix has implemented options that provide internationally-approved power cord and plug configurations. These are illustrated in Fig. 1-3.

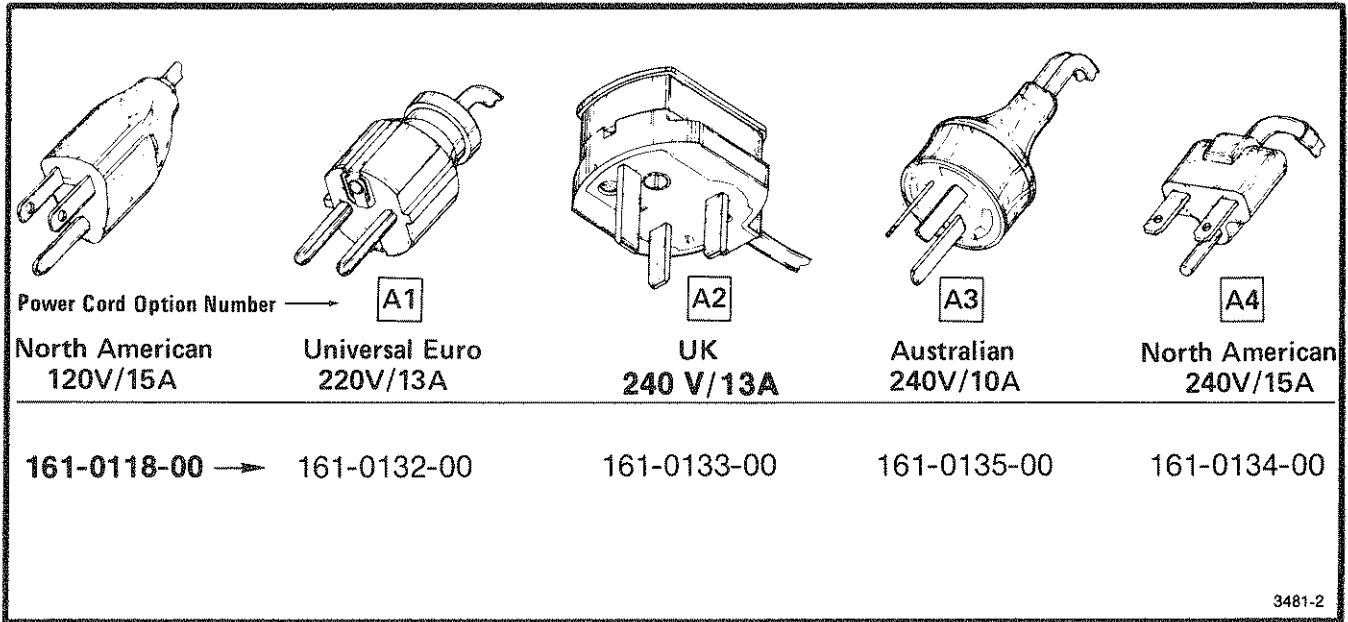

Fig. 1-3. International power cord and plug configuration for the 496/496P.

1  
2  
3  
4  
5  
6  
7  
8  
9  
10  
11  
12  
13  
14  
15  
16  
17  
18  
19  
20  
21  
22  
23  
24  
25  
26  
27  
28  
29  
30  
31  
32  
33  
34  
35  
36  
37  
38  
39  
40  
41  
42  
43  
44  
45  
46  
47  
48  
49  
50  
51  
52  
53  
54  
55  
56  
57  
58  
59  
60  
61  
62  
63  
64  
65  
66  
67  
68  
69  
70  
71  
72  
73  
74  
75  
76  
77  
78  
79  
80  
81  
82  
83  
84  
85  
86  
87  
88  
89  
90  
91  
92  
93  
94  
95  
96  
97  
98  
99  
100



# INSTALLATION AND REPACKAGING

## Introduction

This section describes unpacking, installation, power requirements, and repackaging information for the 496/496P Spectrum Analyzer.

## Unpacking and Initial Inspection

Before unpacking the 496/496P from its shipping container or carton, inspect for signs of external damage. If the carton is damaged, notify the carrier. The shipping carton contains the basic instrument and its standard accessories. Optional accessories are shipped in separate containers. Refer to the Accessories page following the Replaceable Mechanical Parts list in the 496/496P Service manual Vol. 2 for a complete listing.

If the contents of the shipping container are incomplete, if there is mechanical damage or defect, or if the instrument does not meet operational check requirements, contact your local Tektronix Field Office or representative. If the shipping container is damaged, notify the carrier as well as Tektronix, Inc.

The instrument was inspected both mechanically and electrically before shipment. It should be free of mechanical damage and meet or exceed all electrical specifications. Procedures to check functional or operational performance are in the Operation section. The functional check procedure verifies proper instrument operation. This check should satisfy the requirements for most receiving or incoming inspections. The electrical performance check procedure is part of the Service instructions.

## Preparation for Use

The 496/496P can be installed in any position that allows air flow in the bottom and out the rear of the instrument. Feet on the four corners allow ample clearance even if the instrument is stacked with other instruments. A fan draws air in through the bottom and expels air out the back. Avoid locating the 496/496P where paper, plastic, or like material might block the air intake.

The front-panel cover for the 496/496P provides a dust-tight seal. Use the cover to protect the front panel when storing or transporting the instrument. The cover is also used to store some accessories. The cover is removed by

first pulling up and in on the two release latches, then pulling up on the cover. The door to the accessories compartment is unlatched by pressing the latch to the side and lifting the cover.

The handle of the 496/496P can be positioned at several angles to serve as a tilt stand, or it can be positioned at the top rear of the instrument between the feet and the rear panel so 496/496P instruments can be stacked. To position the handle, press in at both pivot points and rotate the handle to the desired position.

### WARNING

*Removing or replacing the cabinet on the instrument can be hazardous. The cabinet should only be removed by qualified service personnel.*

## Power Source and Power Requirements

### WARNING

*Only qualified service personnel should attempt to change the power input requirements. Unfamiliarity with safety procedures can result in personal injury. Refer to the Safety Summary at the front of this manual.*

The 496/496P is designed to operate from a single-phase power source that has one of its current-carrying conductors (neutral) at ground (earth) potential. Operating from power sources where both current-carrying conductors are isolated or above ground potential (such as phase-to-phase on a multi-phase system or across the legs of a 110-220 volt single-phase, three-wire system) is not recommended, since only the line conductor has over-current (fuse) protection within the unit. Refer to the Safety Summary at the front of this manual.

The ac power connector is a three-wire polarized plug with the ground (earth) lead connected directly to the instrument frame to provide electrical shock protection. If the unit is connected to any other power source, the unit frame must be connected to an earth ground.

## Installation and Repackaging—496/496P Operators

Power and voltage requirements are printed on a back-panel plate mounted below the power input jack. The 496/496P can be operated from either 115 Vac or 230 Vac nominal line voltage with a range of 90 to 132 or 180 to 250 Vac, at 48 to 440 Hz. A multipin (harmonica) type connector on the power supply etched circuit board can be positioned to accommodate either voltage range. When the power supply circuitry is changed to accommodate a different power source, the information plate on the back panel must also be changed to reflect the new power requirements. Refer power input changes to qualified service personnel. Instructions are contained in the Service Information section.

### Repackaging for Shipment

When the 496/496P is to be shipped to a Tektronix Service Center for service or repair, attach a tag showing: owner and address, name of individual at your firm that can be contacted, complete serial number, and a description of the service required. If the original packaging is unfit for use or not available, repackage the equipment as follows:

a) obtain a carton of corrugated cardboard having inside dimensions that are at least six inches more than the equipment dimensions, to allow for cushioning. Table 2-1 lists instrument weights and carton strength requirements;

b) install the front cover on the 496/496P and surround the equipment with polyethylene sheeting to protect the finish;

c) cushion the equipment on all sides with packing material or urethane foam between the carton and the sides of the equipment;

d) seal with shipping tape or industrial stapler.

Table 2-1  
SHIPPING CARTON TEST STRENGTH

Gross Weight		Carton Test Strength	
Pounds	Kilograms	Pounds	Kilograms
0—1	0—3.73	200	74.6
10—30	3.73—11.19	275	102.5
<b>30—120<sup>a</sup></b>	<b>11.19—44.76</b>	<b>375</b>	<b>140.0</b>
120—140	44.76—52.22	500	186.5
140—160	52.22—59.68	600	223.8

<sup>a</sup> This information applies to the 496/496P.

If you have any questions, contact your local Tektronix Field Office or representative.

# OPERATION

This section describes the function of the controls, indicators, and connectors for the 496/496P operational checkout of the instrument, and a detailed description of some functions.

The controls, indicators, and connectors unique to the 496P and its functions are described later in this section.

## CONTROLS, INDICATORS, AND CONNECTORS

Because most operational functions of the 496/496P are microprocessor controlled, they are switch selected rather than vernier adjusted.

The following describes the function of the controls, indicators, and connectors on the front and rear panels of the

496/496P (see Figs. 3-1 and 3-2 locations). Some functions are described in greater depth under Operating Information.

### Front Panel (Fig. 3-1)

- ① **INTENSITY.** Controls brightness of the crt trace and crt readout. (Focus is automatically adjusted electronically.)
- ② **READOUT.** Switches crt readout on or off. All spectrum analyzer parameters are read out except Time/Div. Brightness is proportional to the trace brightness and the ratio can be readjusted by service personnel.
- ③ **GRAT ILLUM.** Switches graticule light on or off.

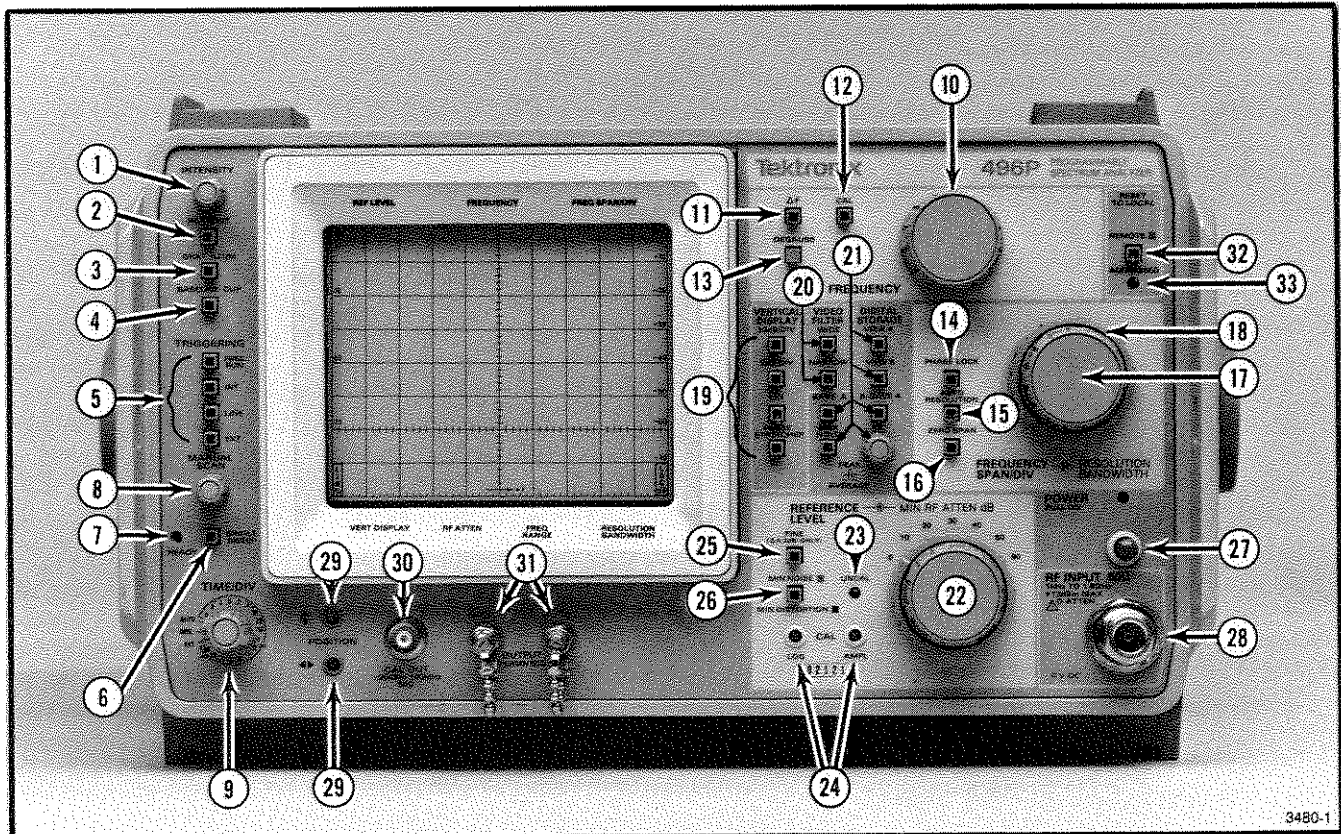

Fig. 3-1. Front-panel selectors, controls and connectors.

④ **BASLINE CLIP.** When activated, the baseline of the display is clipped or subdued to increase the contrast between the display and the baseline.

⑤ **TRIGGERING.** One of four triggering modes can be selected by push buttons that illuminate when activated. A SINGLE SWEEP push button plus a READY indicator provide single-sweep operation.

**FREE RUN**—When activated, the sweep is free running without regard to trigger signals. When selected, all other triggering modes are canceled.

**INT**—When activated, the sweep is triggered by any signal at the left edge of the display with an amplitude of 1.0 division or more. Other trigger modes are canceled.

**LINE**—When activated, a sample of the ac power line voltage is used to trigger the sweep. All other modes are canceled when selected.

**EXT**—When selected, the sweep is triggered by signals between 0.5 volt peak (minimum) to 50 volts peak (maximum) that are applied through the back-panel EXT IN HORIZ/TRIG connector. When EXT is selected, the other modes are canceled.

⑥ **SINGLE SWEEP.** When selected, one sweep is initiated after the sweep circuit has been triggered. Pushing this button does not cancel the trigger modes. The button must be pressed to rearm the sweep circuit after the sweep has run. When single sweep mode is first selected, the present sweep is aborted and the sweep circuit is not armed. To cancel single sweep, press one of the trigger mode push buttons.

⑦ **READY.** When SINGLE SWEEP is selected, this indicator lights while the sweep circuit is armed and ready for a trigger signal. The indicator stays lit until the sweep ends.

⑧ **MANUAL SCAN.** When the TIME/DIV selector is in the MNL position, this control will manually scan the spectrum.

⑨ **TIME/DIV.** Selects sweep rates from the 5 s/div to 20  $\mu$ s/div in 5-2-1 sequence. This switch also selects AUTO, EXT, and MNL modes.

**AUTO** (automatic)—In this position the sweep rate is selected by the microcomputer to maintain a calibrated display for any FREQ SPAN/DIV, RESOLUTION BANDWIDTH, and VIDEO FILTER combination.

**EXT** (external input)—This position connects the rear-panel EXT IN HORIZ/TRIG connector to the horizontal sweep circuit. A voltage ramp of 0 to +10 volts will sweep 10 divisions of the horizontal (x) axis.

**MNL** (manual)—In this position the horizontal axis can be swept with the MANUAL SCAN control.

⑩ **FREQUENCY.** Tunes the center frequency. Tune rate is proportional to the selected FREQ SPAN/DIV. Any given signal moves across the display at a constant rate for all spans.

⑪  **$\Delta$ F.** A convenience for measuring frequency difference between signals (see Operational Procedure). When selected, the frequency readout goes to zero. It will then read out the deviation from this reference as the FREQUENCY is tuned. This display reads out in kHz when FREQ SPAN/DIV is  $\leq$  50 kHz.

⑫ **CAL.** When activated, the frequency readout can be calibrated to center frequency by adjusting the FREQUENCY control for the correct reading. When calibrated, deactivate the CAL mode.

⑬ **DEGAUSS.** When the DEGAUSS button is pressed, current through the tuning coils of the YIG oscillator (1st LO) is reduced to zero to minimize hysteresis effects. This enhances center frequency and display amplitude accuracy. DEGAUSS does not function when the FREQ SPAN/DIV is less than 1 MHz/Div. Degauss the tuning coils after a significant frequency change and before calibrating the center frequency readout.

⑭ **PHASELOCK.** The 1st LO is locked to a stable internal reference and the 2nd LO swept to reduce residual FM in narrow spans; the button lights when phaselock is active. In narrow spans phaselock can be turned off or back on by pressing the button. Spans for which the microcomputer automatically selects phaselock are 50 kHz and below.

Switching PHASELOCK off may cause the signal to shift position. In narrow spans the signal could shift off screen. The signal will usually return to its phaselocked position after a few moments.

- 15** **AUTO RESOLUTION.** This is a push button that activates automatic bandwidth selection for the selected **FREQ SPAN/DIV**, **TIME/DIV** and **VIDEO FILTER**. An internal microcomputer selects bandwidth to maintain a calibrated display. When the **TIME/DIV** is in **AUTO** mode, resolution bandwidth becomes a function of the **FREQ SPAN/DIV** selection.
- 16** **ZERO SPAN.** This converts the 496/496P to a tunable receiver by defeating the sweep. The display reads out **Time/Div** instead of **Span/Div**.
- 17** **FREQUENCY SPAN/DIV.** This is a continuous detented control that selects frequency span/div. Span/div is indicated by the crt readout. Selection is a 1-2-5 sequence plus **MAX** span and 0 Hz span positions. Spans range from 50 Hz/Div to 100 MHz/Div.

When **MAX** span is selected, the span displays the full band. Sweep beyond the band is clamped to the baseline. A dot marker near the top of the screen indicates the position on the span of the crt frequency readout. This dot and frequency point will be center screen when the **FREQ SPAN/DIV** is reduced below **MAX** span position. When zero span is selected **Time/Div** is read out instead of **Span/Div**.

- 18** **RESOLUTION BANDWIDTH.** This is also a continuous detented control that selects resolution bandwidth. Bandwidth is indicated by crt readout. Range of selection is 30 Hz to 1 MHz, with bandwidths above 100 Hz in decade steps. Changing the resolution bandwidth with this control deactivates **AUTO RESOLUTION**.
- 19** **VERTICAL DISPLAY.** These four push buttons select the display mode. The crt readout indicates scale factor.
- 10 dB/DIV**—When activated, the dynamic range of the display is a calibrated 80 dB with each major graticule representing 10 dB.
- 2 dB/DIV**—Increases resolution so that each major graticule division represents 2 dB.

**LIN**—Selects a linear display between zero volts (bottom graticule line) and the reference level (top graticule line) scaled in volts/division. See **REFERENCE LEVEL**.

- PULSE STRETCHER**—Increases the fall time of pulse signals so very narrow pulses in a line spectrum display can be seen. The effect is most apparent for discrete signals analyzed at resolution bandwidths that are narrow compared to the span; **PULSE STRETCHER** may be necessary for digital storage of such signals, especially if they are averaged.
- 20** **VIDEO FILTER**—One of two (**NARROW** and **WIDE**) filters can be activated to reduce the video bandwidth and reduce high-frequency components for display noise averaging. The **NARROW** filter is approximately 1/300th of the selected resolution bandwidth; the **WIDE** filter is about 1/30th the bandwidth. Activating either filter cancels or deactivates the other filter. Press the push button to switch the filters off.
- 21** **DIGITAL STORAGE.** Five push buttons and one control operate the digital storage functions. With none of the push buttons activated, the 496/496P display is not stored.

**VIEW A, VIEW B**—When either or both of these push buttons are selected, the push button illuminates and the contents of memory A and/or memory B are displayed. With **SAVE A** mode off, all memory locations are displayed and updated continuously. Data in A memory is interlaced with data from B memory.

**SAVE A**—When activated, this mode holds data in A memory and inhibits further updating. With **SAVE A** and **VIEW A** active, data in A memory is displayed but not updated, serving as a reference to compare contents of B memory.

**B-SAVE A**—When activated, the differential (arithmetic difference) of data in B memory and the saved data in memory A is displayed. **SAVE A** mode is activated and **SAVE A** button illuminated. The zero difference point is nominally set at the middle graticule line with positive differences displayed above this line and negative differences below. (The zero difference position on screen is internally switch selectable.)

**MAX HOLD**—When activated, the digital storage memory retains the maximum signal amplitude at each memory location. This permits visual monitoring of signal frequency and amplitude at each memory location over an indefinite period of time. This feature is used to measure drift, stability, and record peak amplitudes.

**PEAK/AVERAGE**—This control selects the amplitude at which the vertical display is either peak detected or averaged. Video signals above the level set by the control (shown by a horizontal line or cursor) are peak detected and stored; video signals below the cursor are digitally averaged and stored. See Peak/Average Control (Digital Storage) under General Operating Information later in this section.

**22 MIN RF ATTEN.** Sets the minimum amount of RF attenuation. Changing REF LEVEL will not decrease RF attenuation below that set by the MIN RF ATTEN selector.

**REFERENCE LEVEL.** Continuous control that requests the microcomputer to change the reference level one step for each detent. In the 10 dB/DIV Vertical Display mode, the steps are 10 dB. When FINE is activated, the steps are 1 dB. In the 2 dB/DIV mode, the steps are 1 dB or 0.25 dB for the FINE mode, the  $\Delta A$  mode is operational. The REF LEVEL goes to 0.00 dB then steps in 0.25 dB increments from an initial 0.00 dB reference level.

**MIN RF ATTEN dB** selects the lowest value of attenuation allowed; actual RF attenuation is set by the microcomputer according to the algorithm selected by the MIN NOISE/MIN DISTORTION button. If RF attenuation is increased by changing MIN RF ATTEN, the microcomputer automatically changes IF gain to maintain the current reference level.

**23 UNCAL.** This indicator lights when the display amplitude is no longer calibrated (e.g., selecting a sweep rate that is not compatible with the frequency span/div and resolution bandwidth).

**24 LOG and AMPL CAL.** These adjustments calibrate the dynamic range of the display. The LOG calibrates the logarithmic gain in dB/div, the AMPL calibrates the reference level of the top graticule line at the top of the screen.

**25 FINE.** When activated, REF LEVEL switches in 1 dB increments for 10 dB/DIV display mode, and 0.25 dB for 2 dB/DIV display mode. In the 2 dB/DIV display mode, FINE activates  $\Delta A$  mode.

Vertical Display Mode	FINE Increment
10 dB/DIV	1 dB
2 dB/DIV	0.25 dB ( $\Delta A$ mode) <sup>a</sup>
LIN	Voltage equivalent to 1 dB

<sup>a</sup>For  $\Delta A$  mode description see Delta A Mode under General Operating Information later in this section.

**26 MIN NOISE/MIN DISTORTION.** One of two algorithms is selected to control attenuator and IF gain. MIN NOISE (button illuminated) reduces the noise level by reducing attenuation 10 dB and reducing IF gain 10 dB. MIN DISTORTION reduces IM distortion due to input mixer overload. To observe any change, the RF ATTEN, displayed by the crt redout, must be 10 dB higher than that set by the MIN RF ATTEN selector.

In MIN DISTORTION mode (button not illuminated) distortion is minimum.

**27 POWER.** Pull-type switch that switches the main power supply on.

**28**  **RF INPUT.** A 50  $\Omega$  coaxial input connector for signals 1.8 GHz or below. The maximum, non-destructive input signal level to the input mixer is +13 dBm or 30 mW. Signals above -18 dBm may cause signal compression.



*The maximum rating of the RF attenuator is +30 dBm (1 watt average, 75 watts peak, pulse width  $\leq 1 \mu s$ , with a duty cycle that does not exceed 0.001). Burn-out occurs above 1 watt.*

*If MIN NOISE is activated and RF ATTEN is 60 dB, the +30 dBm rating could be exceeded. If the input signal level is increased for a full-screen display, the input level will be +40 dBm. Reduce high-level signals with external attenuators. Use external attenuators and the MIN RF ATTEN to reduce the level into the 1st mixer to -10 dBm or less. Input voltage to the input mixer must not contain any dc component. Refer to Signal Application (under General Operating Instructions) discussed later in this section.*

**29**  **POSITION**. These controls position the display on the horizontal and vertical axes.

30 **CAL OUT** (Calibrator output). The source of a calibrated  $-20$  dBm ( $\pm 0.3$  dB) 100 MHz ( $\pm 1.7$  kHz) signal, and a comb of frequency markers 100 MHz apart. The calibrated 100 MHz marker is used as a reference for calibrating reference level and log scale. The comb of 100 MHz markers is used to check span and frequency readout accuracy.

31 **OUTPUT 1st and 2nd LO**. These connectors provide access to the output of the respective local oscillators. The connectors must be terminated into  $50 \Omega$  when they are not connected to some external device.

32 **RESET TO LOCAL—(496P Only)**. This button is lit when the 496P is under the remote control of a GPIB controller. Pressing this button restores local control and updates the GPIB primary address. In TALK ONLY mode, this button sends a waveform and the control settings onto the GPIB bus.

33 **ADDRESSED—(496P Only)**. Lights when the 496P is addressed to listen or talk.

Refer to the GPIB Controls, Indicators, and Connectors after General Operating Information for more detailed information.

**Rear Panel (Fig. 3-2)**

1 **PROBE POWER**. The PROBE POWER connector on the rear panel of this instrument provides operating power for active probe systems. It is not recommended that this or the other rear-panel connectors be used as a power source for applications other than the compatible probes or other accessories specifically designed for use with this source.

2 **EXT IN HORIZ/TRIG**. Dc coupled input for horizontal drive voltages and ac coupled for trigger signal. A 0 to +10 volt ramp produces full sweep. 1.0 to 50 volt peak signals are required for trigger ( $0.1 \mu\text{s}$  minimum pulse width), 15 Hz to 1 MHz. Selection as to HORIZ or TRIG mode depends on front-panel TRIGGERING and TIME/DIV selections.

3 **DISPLAY MARKER INPUT**. This interfaces the 496/496P with the 1405 TV Sideband Adapter.

4 **HORIZ (output)**. Source of a signal that is 0.5 V for each division of display.

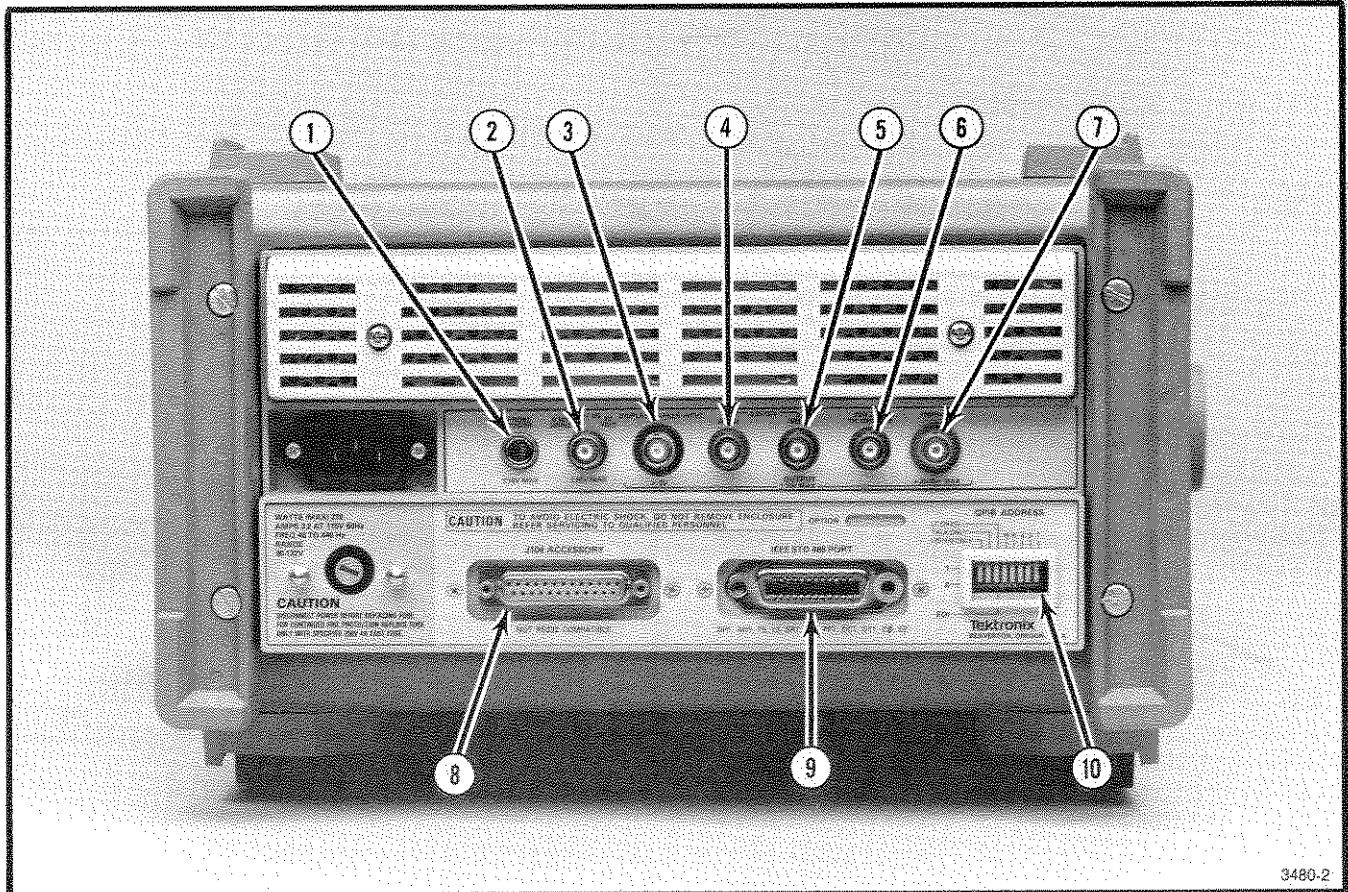

Fig. 3-2. Rear panel connectors.



## Operation—496/496P Operators

- ⑤ **VERT** (output). Source of a signal that is 0.5 V for each division of display. If signal is used to drive a chart recorder, digital storage should be off. If signal drives a slave monitor and PEN LIFT is used for blanking, the screen will blank during retrace time.
- ⑥ **PEN LIFT**. TTL compatible, nominal +5 V provided to lift the pen of a chart recorder.
- ⑦ **10 MHz IF** (+20 dBm max). Access to the 10 MHz IF signal. Output level is about -10 dBm with a full-screen signal at -30 dBm reference level, maximum output is +20 dBm.
- ⑧ **J104 ACCESSORY**. Possible future applications for the 496/496P may use this connector.
- ⑨ **GPIB Connector—(496P Only)**. This interfaces the 496P with a GPIB bus. Connect the GPIB cable after the instrument is switched on to avoid interference on the bus.
- ⑩ **GPIB ADDRESS—(496P Only)**. These switches set the primary GPIB address of the 496P and select the TALK or LISTEN operating mode. Address 31 (11111) logically disconnects the 496P from the bus; address 0 (00000) is reserved for 4050-Series controllers.

## 496P Controls and Connectors

Refer to GPIB Controls, Indicators and Connectors after General Operating Information for more detailed information.

## FIRMWARE VERSION AND ERROR MESSAGE READOUT

### Firmware Version

During initial turn-on or power-up cycle, the firmware version in the instrument will flash on screen for approximately two seconds. The Replaceable Parts list in the 496/496P Service manual Vol. 2 lists the ROMs used for each version.

### Error Message Readout

The 496/496P features error message readout. These messages (numbers) flash on screen when the address and data from the microcomputer fails to complete an operational routine. These error numbers and their meaning are as follows:

Error #	Meaning
57	Tune routine failed
58	Failed to phaselock
59	Lost phaselock
60	Failed to recenter frequency when phaselock canceled or when switching to an unlocked span/div setting. (Phaselock occurs for 50 kHz or less.)

## TURN ON PROCEDURE AND PREPARATION FOR USE

The following procedure initiates a display and calibrates center frequency readout, display reference level, and dynamic range.

### 1. Initial Turn On

- a. Connect the 496/496P power cord to an appropriate power source (see Power Requirements under Installation Instructions) and switch POWER on. Allow three to four minutes for the instrument to warm up and stabilize before proceeding. Note that the crt readout is functioning (see Fig. 3-3).

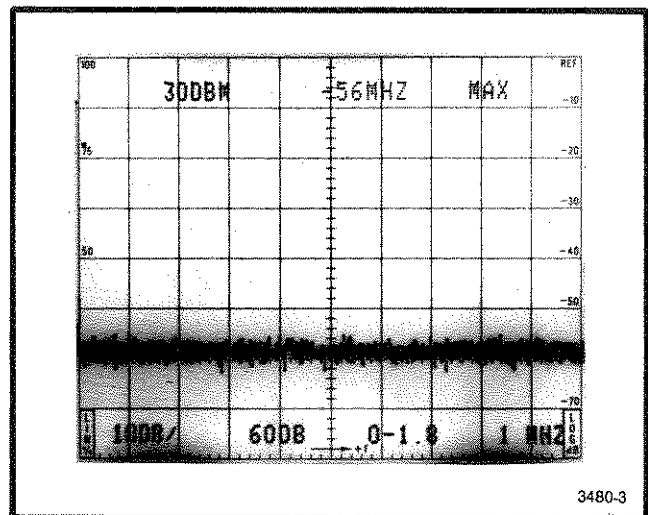

Fig. 3-3. Crt readout for power-up state.



When POWER is switched on (power up), the operating functions and modes of the 496/496P initialize to the following "power up" state.

FREQUENCY	—56 MHz
FREQ SPAN/DIV	MAX
REF LEVEL	30 dBm
MIN RF ATTEN	0 dB
AUTO RESOLUTION	On
TIME/DIV	AUTO
Vertical Display	10 dB/DIV
Video Filter	Off
Digital Storage	VIEW A/VIEW B
TRIGGERING	FREE RUN
READOUT	On
All other push buttons	Inactive or off

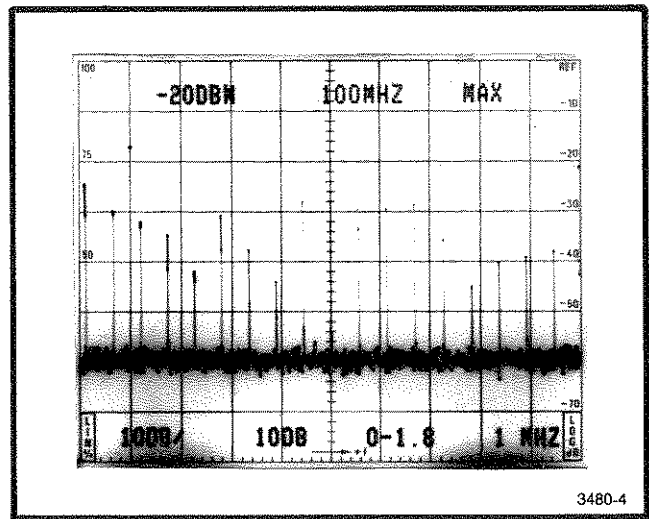

Fig. 3-4. Typical display of calibrator markers in MAX Span position.

b. Apply the CAL OUT to the RF INPUT by connecting a 50 Ω coaxial cable between the CAL OUT connector and the RF INPUT.

c. Set MIN RF ATTEN to 0 dB and PEAK/AVERAGE control fully counterclockwise. Set the TIME/DIV to AUTO, the REF LEVEL to -20 dBm, and adjust the INTENSITY for a display with the desired brightness. Note that the RF ATTEN readout is now 10 dB.

d. In the MAX frequency span mode, a dot marker in the upper portion of the screen indicates the location on the display to which the 496/496P center frequency is tuned. With a frequency readout of -56 MHz, it will be in the upper left portion of the screen. Adjust the center FREQUENCY control and note the dot marker move across the display.

e. Note the comb of 100 MHz markers at the left side of the display (see Fig. 3-4). Tune the dot marker to a position above the first 100 MHz marker.

f. Change the FREQ SPAN/DIV to 100 MHz. Note that the dot marker is now centered horizontally and the 100 MHz signal is at or near center screen.

g. Position the dot marker to the graticule centerline with the horizontal (◀▶) POSITION control. Adjust the center Frequency control to tune the signal over the dot marker.

h. Press the 2 dB/DIV Vertical Display button; then position the baseline of the display to the bottom graticule line with the vertical (⬆) POSITION control.

## 2. Calibrate Center Frequency Readout

a. Change the Vertical Display to 10 dB/DIV. If the instrument has phaselock, ensure that PHASELOCK is deactivated or the FREQ SPAN/DIV is above 50 kHz (recommend setting of 10 MHz).

b. Tune the FREQUENCY to place the 100 MHz calibrator signal over the center-span dot marker. Reduce FREQ SPAN/DIV to 1 MHz, press the DEGAUSS button, and fine-tune center frequency.

### NOTE

*Degauss function is inoperative when the FREQ SPAN/DIV is less than 1 MHz.*

c. Press the CAL button to activate the calibration function (button illuminated); then, adjust the FREQUENCY tuning control for a readout of 100 MHz. Press the CAL button to deactivate the CAL mode and increase FREQ SPAN/DIV to 20 MHz.

d. CHECK—center frequency accuracy at other multiples of the 100 MHz calibrator signal. Approach each check point from the low-frequency side and degauss the tuning coils of the oscillator as each check point is approached. Readout should be within  $\pm(5 \text{ MHz} + 20\% \text{ span/div})$ .

e. Return the frequency to 100 MHz.

### 3. Calibrate Reference Level and Dynamic Range

a. With the 100 MHz calibrator signal tuned to center screen and the REF LEVEL at  $-20$  dBm, set the FREQ SPAN/DIV to 20 kHz, as indicated by the crt readout.

b. Alternately switch Vertical Display from 10 dB/DIV to 2 dB/DIV and adjust AMPL CAL so the peak amplitude of the signal is the same for each logarithmic display mode.

c. With the Vertical Display mode at 10 dB/DIV, set the top of the calibrator signal to the top graticule line with the LOG CAL adjustment so the top graticule line is a calibrated  $-20$  dBm.

d. CHECK—the display log scale over 50 dB of dynamic range by switching REF LEVEL in 10 dB steps from  $-20$  dBm to  $+30$  dBm and noting that the display amplitude decreases 10 dB or one division per step.

e. Set the REF LEVEL to  $-20$  dBm and the Vertical Display to 2 dB/DIV.

f. With the REF LEVEL selection in coarse mode, change the REF LEVEL to  $-10$  dBm in 1 dB steps. Check that the amplitude and REF LEVEL readout reduces 1 dB/step for a total of 10 dB,  $\pm 1.3$  dB.

g. Return the REF LEVEL to  $-20$  dBm and activate FINE for the  $\Delta A$  mode. Note signal amplitude.

h. Change the REF LEVEL  $+2$  dB. Check that the REF LEVEL readout changes in 0.25 dB steps and the display amplitude decreases 2 dB,  $\pm 0.4$  dB (1 division,  $\pm 1$  minor division) to match the 2 dB change in readout. Return the REF LEVEL to 0.00 dB.

i. Change the Vertical Display mode to 10 dB/DIV, switch the REF LEVEL from  $-20$  dBm to  $-10$  dBm. Check that the REF LEVEL changes in 1 dB increments and the total change in display amplitude is 10 dB,  $\pm 1.0$  dB (1 division,  $\pm 0.5$  minor division).

j. Return the REF LEVEL to  $-20$  dBm and cancel FINE for coarse steps.

## FUNCTIONAL OR OPERATIONAL CHECK

This procedure uses minimum test equipment to check instrument operating modes, functions, and basic performance. The procedure serves to check for instrument malfunctions and should satisfy most incoming inspection or pre-operational check-out requirements. A detailed Performance Check, which requires extensive test equipment, is part of the Calibration Procedure in the 496/496P Service manual Vol. 1. This operational check also familiarizes the user with instrument operation.

### Equipment Required

The internal calibrator for the 496/496P is an accurate amplitude and frequency reference source. It, along with a very accurate internal attenuator, is used as the reference source for checks in this procedure. The following fixtures, which are part of the standard accessories, are also required.

1. Adapter: N male to bnc female.
2. 50  $\Omega$  coaxial cable: 18 inch, bnc to bnc connectors.

### Preliminary Preparation

a. Perform the initial calibration described under Turn On Procedure.

b. Set the front-panel controls as follows:

FREQUENCY	100 MHz
FREQ SPAN/DIV	1 MHz
REF LEVEL	$-20$ dBm
MIN RF ATTEN	0 dB
AUTO RESOLUTION	On
TIME/DIV	AUTO
Vertical Display	10 dB/DIV
Video Filter	Off
Digital Storage	VIEW A/VIEW B
PEAK/AVERAGE	Fully ccw

c. Allow the instrument to warm up for at least 30 minutes before proceeding with this check.

## 1. Check Operation of Front-Panel Push Buttons and Controls

The following procedure checks functions activated by front-panel push buttons and that the buttons illuminate when the function is active. Operation of the front-panel controls is also checked.

With the CAL OUT signal applied to the RF INPUT, tune the 100 MHz, -20 dBm signal to center screen. Reduce the FREQ SPAN/DIV to 100 kHz keeping the signal centered on screen. Press or change the following push buttons and controls and note their effect.

**INTENSITY.** Rotate the control through its range and note crt beam brightness change.

**READOUT.** Inactive state, no crt readout. Active state, crt readout of REF LEVEL, FREQUENCY, FREQ SPAN/DIV, VERT DISPLAY, RF ATTEN, FREQ RANGE, and RESOLUTION BANDWIDTH. The INTENSITY control changes brightness.

**GRAT ILLUM.** Inactive state, no graticule lights. Active state, graticule lighted.

**BASELINE CLIP.** Inactive, no clipping of the display baseline. Active, display intensity at the baseline is clipped (subdued).

**TRIGGERING.** Triggering mode is activated by pressing one of four push buttons. Pressing any one of the buttons cancels or deactivates the other mode.

**FREE RUN.** Active, trace free runs.

**INT.** Active, trace displayed when signal or noise level at left edge is  $\geq 2.0$  division.

**LINE.** Active, trace triggered at power line frequency.

**EXT.** Active, trace runs only when an external signal  $\geq 1.0$  volt peak is applied to the back-panel EXT IN connector.

**SINGLE SWEEP.** Pressing this button to activate single sweep aborts the current sweep; pressing the button again arms the sweep generator and lights READY, which remains lighted until the sweep completes. The analyzer

makes a single sweep of the selected spectrum when the conditions determined by TRIGGERING are met. SINGLE SWEEP mode is canceled when any TRIGGERING button is pressed. The effect of SINGLE SWEEP may be more apparent if VIEW A, VIEW B, and B—SAVE A are off.

**TIME/DIV.** Selects sweep rate and manual scan operation. In MNL position, MANUAL SCAN control should vary the crt beam across the full horizontal axis of the crt graticule.

**VERTICAL DISPLAY.** Display modes are activated by three push buttons. Pressing any of these buttons cancels the other mode.

**10 dB/DIV.** Active, display is calibrated 10 dB/division, 80 dB dynamic range. Calibration is checked later in this procedure.

**2 dB/DIV.** Active, display is calibrated 2 dB/division, 16 dB dynamic range. Calibration is checked later in this procedure.

**LIN.** Active, display is linear between the reference level (top of graticule) and zero volt (bottom of graticule); the crt VERT DISPLAY reads out in volts/division.

**PULSE STRETCHER.** Active, increases the fall time of video signals to make narrow pulses on the display easier to see. With FREQ SPAN/DIV at MAX, TIME/DIV at 5 ms and Digital Storage off, the markers should increase in brightness when PULSE STRETCHER is active.

**VIDEO FILTER.** Two filters, independently selected to provide WIDE (1/30th) or NARROW (1/300th) of the resolution bandwidth for noise reduction.

**DIGITAL STORAGE.** Either or both sections of memory can be selected to provide digital storage. When either or both are activated, signal amplitude should remain constant. Vary the PEAK/AVERAGE control and note that noise level below the PEAK/AVERAGE cursor is averaged.

**VIEW A.** Active, half of digital storage memory is displayed.

**VIEW B.** Active, the B section or other half of memory is displayed.

When both VIEW A and VIEW B are active, contents of A and B memory are interlaced and displayed. Both sections are updated each sweep. Update of A memory depends on the state of SAVE A

**SAVE A.** Active, contents in A memory are saved and not updated. Verify operation by changing REF LEVEL and observe that the VIEW A display does not change when VIEW B is inactive.

**MAX HOLD.** Active, stores maximum signal amplitude at each memory location. Verify operation by changing FREQUENCY or REF LEVEL and note that the maximum level at each location is retained.

**B—SAVE A.** Active, the difference between updated data in B section of memory and that saved in A is displayed. Verify by saving data in A, then changing the REF LEVEL and pressing B—SAVE A; only the difference can be observed by canceling VIEW A and VIEW B. The reference (zero difference) level is normally set at graticule center, but can be internally adjusted by service personnel.

**PEAK/AVERAGE.** When Digital Storage is activated with VIEW A or VIEW B, this control positions a horizontal line or cursor on the display. Signals above the cursor are peak detected; signals below the cursor are averaged. The cursor should position anywhere within the graticule window.

**PHASELOCK.** Active to reduce residual FM when narrow spans are selected. The button lights when active; pressing the button turns phaselock off. The microcomputer automatically selects phaselock for a span/division of 50 kHz or below.

**AUTO RESOLUTION.** When activated, RESOLUTION BANDWIDTH changes so bandwidth is compatible with FREQ SPAN/DIV selection. Check by changing FREQ SPAN/DIV and noting that RESOLUTION BANDWIDTH changes. UNCAL indicator should not light over the FREQ SPAN/DIV range if TIME/DIV selector is in AUTO position.

**ZERO SPAN.** When activated, sweep is defeated. The display reads out TIME/DIV instead of FREQ SPAN/DIV. The 496/496P operates as a tunable receiver in this mode.

**FREQUENCY SPAN/DIV.** As this control is rotated clockwise or counterclockwise, FREQ SPAN/DIV should change from 0 to MAX in 5-2-1 sequence. Display should indicate this change.

**RESOLUTION BANDWIDTH.** As this control is rotated, resolution bandwidth should range from 1 MHz to 100 Hz in decade steps, with 30 Hz as the last step.

**$\Delta$ F.** When activated, center frequency readout initializes to 0 MHz. The frequency difference, to a desired signal or point on the display, can now be determined by tuning that point to center screen and noting the readout. Check by measuring the difference between calibrator markers. Deactivate and note that the readout returns to center frequency. If the frequency is tuned below "0", the readout will indicate (–) sign. When FREQ SPAN/DIV is set 50 kHz or lower, the readout is in kHz.

**DEGAUSS.** When pressed, hysteresis in the local oscillator tuning system is reduced. Switch FREQ SPAN/DIV to 1 MHz and tune the calibrator marker to center screen. Note the signal position, then press the DEGAUSS button. The signal should shift horizontally and then return to a new location. Press again and the signal should return to the same new location. Return FREQ SPAN/DIV to 100 MHz.

**CAL.** Checked when performing Turn On Procedure.

**REFERENCE LEVEL.** Stepped control that requests the microcomputer to change the reference level one step for each detent. In the 10 dB/DIV Vertical Display mode, the steps are 10 dB. When FINE is activated, the steps are 1 dB. In the 2 dB/DIV mode, the steps are 1 dB or 0.25 dB for the FINE mode. When FINE is activated in the 2 dB/DIV mode, the  $\Delta$ A mode is operational. The REF LEVEL goes to 0.00 dB then steps in 0.25 dB increments from an initial 0.00 dB reference level.

Set the MIN RF ATTEN to 0 dB, Vertical Display to 10 dB/DIV, and rotate the REF LEVEL control counterclockwise to +30 dBm then clockwise to –120 dBm. Note the change in the display. Return the REF LEVEL to –20 dBm and note that 10 dB of RF ATTEN is switched in at –20 dBm.

**MIN RF ATTEN.** Sets the minimum amount of RF attenuation. Changing REF LEVEL will not decrease RF attenuation below that set by the MIN RF ATTEN selector.

**FINE.** When activated, REF LEVEL switches in 1 dB increments for 10 dB/DIV display mode, and 0.25 dB for 2 dB/DIV display mode. In the 2 dB/DIV display mode, FINE actuates  $\Delta$ A mode. See Delta A Mode description under General Operating Information.

**MIN NOISE/MIN DISTORTION.** One of two algorithms is selected to control attenuator and IF gain. MIN NOISE (button illuminated) reduces the noise level by reducing attenu-

ation 10 dB and decreasing IF gain 10 dB. MIN DISTORTION reduces IM distortion due to input mixer overload. To observe any change, the RF ATTEN, displayed by the crt readout, must be 10 dB higher than that set by the MIN RF ATTEN selector.

**UNCAL.** This light comes on when the display is uncalibrated. Set the TIME/DIV to 50 ms, deactivate the AUTO RESOLUTION, and set the RESOLUTION BANDWIDTH to 10 kHz. UNCAL should light and remain lit until the FREQ SPAN/DIV is reduced to 200 kHz or the RESOLUTION BANDWIDTH is increased to 1 MHz. Return the TIME/DIV to AUTO and activate the AUTO RESOLUTION. Set the FREQ SPAN/DIV to 100 MHz.

This completes the functional check of the front-panel controls and push buttons.

## 2. Check Frequency Readout Accuracy $\pm(5 \text{ MHz} + 20\%$ of span/division)

### NOTE

*Due to hysteresis in the 1st (YIG) oscillator, accuracy of the frequency readout should be checked after the tuning coil has been degaussed by pressing the DEGAUSS button when the FREQ SPAN/DIV is either 2 MHz or 1 MHz, before reducing the FREQ SPAN/DIV to narrower span settings.*

Calibrate the frequency readout as described under Initial Operation. Now check frequency readout accuracy by tuning to successive 100 MHz calibrator markers. As a given marker is tuned toward center screen, degauss the oscillator tuning coils by pressing the DEGAUSS button with the FREQ SPAN/DIV either at 2 MHz or 1 MHz. Reduce the FREQ SPAN/DIV to 500 kHz and center the marker under the frequency dot before noting the readout for center frequency. Readout should be within  $\pm(5 \text{ MHz} + 20\%$  of span/division) of the calibrator marker; for example, the 10th marker should represent 1 GHz.

## 3. Check Frequency Span/Div Range and Accuracy

Range is in a 1-2-5 sequence and covers the range from 50 Hz/Div to 200 MHz/Div.

Span accuracy specifies the maximum displacement error of calibrator markers from the center screen reference over the center 8 divisions of span. Linearity is the displacement error between successive markers with respect to the FREQ SPAN/DIV setting over the center 8 divisions of span.

a. Tune the center FREQUENCY to the 900 MHz calibrator harmonic signal and set the REF LEVEL at  $-30 \text{ dBm}$ . Set the FREQ SPAN/DIV to 200 MHz and activate AUTO RESOLUTION.

b. CHECK—for 1.8 GHz of span. Check span/div accuracy by noting marker displacement from the respective graticule line. Deviation should not exceed 5% or  $<2$  minor divisions.

c. CHECK—the range and accuracy for FREQ SPAN/DIV selections to 10 MHz using the calibrator 100 MHz comb of markers as the reference.

## 4. Check Resolution Bandwidth and Shape Factor (bandwidth, 30 Hz, then 100 Hz to 1 MHz $\pm 20\%$ in decade steps; shape factor, 7.5:1 or less, 15:1 or less for 30 Hz bandwidth)

a. Tune the center FREQUENCY to 100 MHz and center the 100 MHz calibrator signal. Set the REF LEVEL to  $-20 \text{ dBm}$ , FREQ SPAN/DIV to 500 kHz, RESOLUTION BANDWIDTH to 1 MHz, TIME/DIV to AUTO, Vertical Display mode to 2 dB/DIV, and MIN NOISE on.

b. Measure the 6 dB bandwidth (see Fig. 3-5A). Bandwidth should equal 1 MHz,  $\pm 200 \text{ kHz}$ .

c. Change the Vertical Display mode to 10 dB/DIV.

d. Measure the  $-60 \text{ dB}$  bandwidth (see Fig. 3-5B). Calculate the shape factor by dividing the  $-60 \text{ dB}$  bandwidth by the  $-6 \text{ dB}$  bandwidth. The shape factor should equal 7.5:1 or less.

e. Switch RESOLUTION BANDWIDTH to 100 kHz and the FREQ SPAN/DIV to 100 kHz.

f. Check the bandwidth and shape factor of the 100 kHz filter by repeating the foregoing procedure.

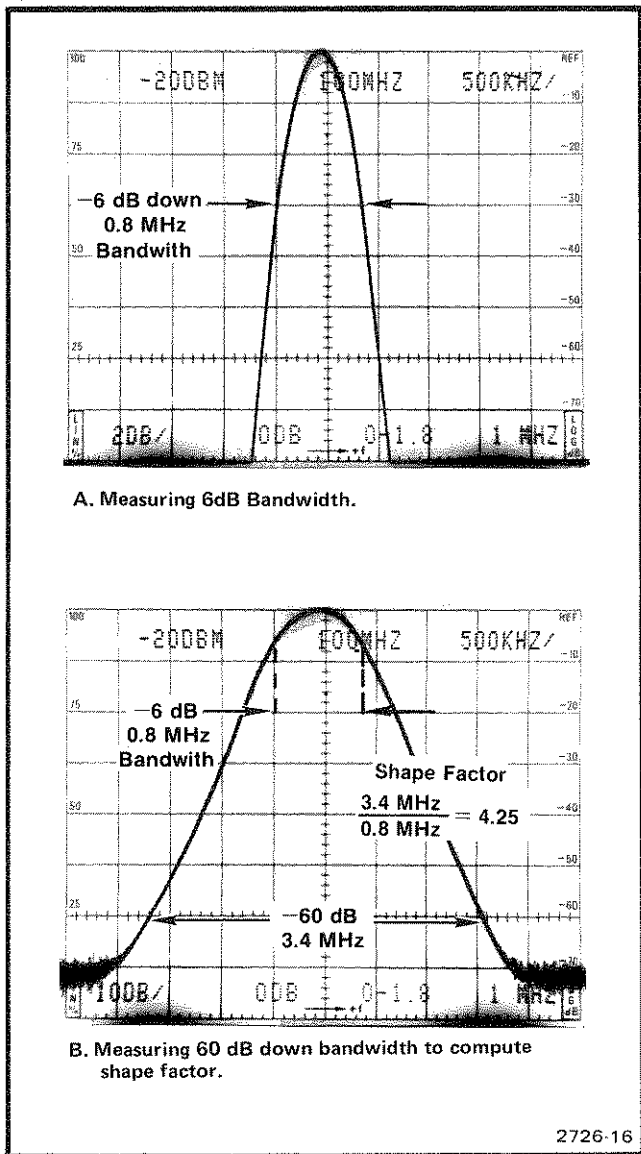

Fig. 3-5. Display to illustrate how bandwidth and shape factors are determined.

g. Switch the RESOLUTION BANDWIDTH to the remaining selections, adjusting the FREQ SPAN/DIV as necessary to check the bandwidth and shape factor of each selection. Bandwidth should be within 20% of that selected and the shape factor 7.5:1 or better.

h. When 30 Hz is reached, shape factor should be 15:1 or better.

### 5. Check Reference Level Gain and RF Attenuation Steps

**NOTE**

*This procedure checks functional operation but does not verify accuracy. If deviation seems significant, refer to qualified service personnel for a performance check.*

a. With the calibrator signal applied to the RF INPUT, set the front-panel controls as follows:

- FREQUENCY 200 MHz
- FREQ SPAN/DIV 10 MHz
- REF LEVEL -30 dBm
- MIN RF ATTEN 0 dB
- RESOLUTION BANDWIDTH 1 MHz
- TIME/DIV AUTO
- Vertical Display 10 dB/DIV
- Video Filter NARROW
- Digital Storage VIEW A/VIEW B
- MIN NOISE On

b. Tune FREQUENCY to the 200 MHz marker, then decrease FREQ SPAN/DIV and RESOLUTION BANDWIDTH to 100 kHz, keeping the marker centered.

c. Check the attenuator by increasing REF LEVEL to 40 dBm in 10 dB steps, noting that the signal peak drops 1 division per step and RF ATTEN increases to 60 dB in 10 dB steps.

d. Return REF LEVEL to -20 dBm and increase MIN RF ATTEN to 60 dB, noting that the noise level rises about 1 division per step.

e. Check IF gain steps by switching REF LEVEL from -20 dBm to +40 dBm; observe that the signal peak and noise level decreases 1 division per step.

f. Activate FINE; then check that the trace rises in 1 dB (0.1 division) steps as REF LEVEL is changed to +30 dBm.

g. Switch FINE off and reduce MIN RF ATTEN to 0. Deactivate MIN NOISE and note that the noise level rises about 1 division as the RF ATTEN changes 10 dB (50 dB to 60 dB) when MIN NOISE is switched off (REF LEVEL should not change and the trace peak should remain relatively constant).

h. Adjust REF LEVEL to position the signal peak near the top of the graticule. Change Vertical Display mode to 2 dB/DIV.

i. Check that REF LEVEL and signal amplitude changes in 1 dB steps as the REFERENCE LEVEL control is rotated.

j. Turn on FINE and note that the REF LEVEL readout changes to \*0.00 dB. This denotes the ΔA mode. Check that REF LEVEL and signal amplitude changes in 0.25 dB steps as the REFERENCE LEVEL is rotated.

k. Switch FINE off and set REF LEVEL to a multiple of 10 dBm. Change Vertical Display mode to 10 dB/DIV.

b. Disconnect the calibrator signal from the RF INPUT.

c. CHECK—noise level below the -30 dBm reference level. Noise floor (level) should not be above that specified below:

Average Noise Level dBm (max) over the frequency range; 1 kHz—1.8 GHz for the following resolution bandwidths:

Resolution Bandwidth

1 MHz	-85
100 kHz	-95
10 kHz	-105
1 kHz	-115
100 Hz	-123
30 Hz	-127

d. Change REF LEVEL to -40 dBm and FREQ SPAN/DIV to 1 MHz.

e. CHECK—noise level of 10 kHz and 100 kHz resolution bandwidths. Compare these levels with those listed in part c.

f. Change the REF LEVEL to -60 dBm, FREQ SPAN/DIV to 10 kHz, Video Filter to NARROW, and TIME/DIV to AUTO.

g. CHECK—average noise level to 1 kHz resolution bandwidth against that listed in part c.

h. Change RESOLUTION BANDWIDTH to 100 Hz and FREQ SPAN/DIV to 500 Hz.

i. CHECK—average noise level to 100 Hz resolution bandwidth against that listed in part c.

j. Change RESOLUTION BANDWIDTH to 30 Hz and FREQ SPAN/DIV to 100 Hz.

k. CHECK—average noise to 30 Hz resolution bandwidth against that listed in part c.

l. Return PEAK/AVERAGE control to the fully counter-clockwise position and switch Video Filter off.

## 6. Check Sensitivity

**NOTE**

*Sensitivity is specified according to the input mixer average noise level. The 496/496P calibrator signal is the reference used to calibrate the display. Accuracy of the calibrator output level can be verified using a 100 MHz bandpass filter with known loss and an accurate power meter.*

a. Set the front-panel controls as follows:

FREQUENCY	100 MHz
FREQ SPAN/DIV	5 MHz
REF LEVEL	-30 dBm
MIN RF ATTEN	0 dB
RESOLUTION BANDWIDTH	1 MHz
TIME/DIV	0.5 s
Vertical Display	10 dB/DIV
Video Filter	WIDE
Digital Storage	VIEW A/VIEW B
PEAK/AVERAGE Cursor	Fully cw

**7. Frequency Drift** (PHASELOCK On: within 3.3 kHz over 10 minutes after 30 minute warmup, within 330 Hz over 10 minutes after 2 hour warmup. PHASELOCK Off: within 33 kHz over 10 minutes after 2 hour warmup)

**NOTE**

*This measurement and residual FM are dependent on oscillator stability. The instrument must therefore have a 30 minute warmup period and a settling time of 10 minutes after retuning more than 50 kHz.*

a. Set the front-panel controls as follows:

FREQUENCY	100 MHz
FREQ SPAN/DIV	10 MHz
REF LEVEL	-20 dBm
MIN RF ATTEN	0 dB
MIN NOISE	Off
AUTO RESOLUTION	On
TIME/DIV	AUTO

b. Connect the CAL OUT signal to the RF INPUT. Tune the calibrator mark to center screen. Reduce the FREQ SPAN/DIV to 1 MHz and press DEGAUSS to remove any residual magnetism as the signal is centered.

c. Adjust the REF LEVEL for a signal amplitude of 7 divisions. Decrease the FREQ SPAN/DIV to 1 kHz keeping the signal centered as necessary with the FREQUENCY control. Confirm that the Phaselock light is on.

d. Activate VIEW A, VIEW B, and MAX HOLD.

e. Check the signal stability or drift over the specified time period. Drift will appear as the width of the response less the resolution bandwidth (see Fig. 3-6) after the specified time period.

f. Deactivate MAX HOLD.

g. Repeat this procedure after two hours of operation. When part c is repeated, decrease the FREQ SPAN/DIV to 100 Hz. Check that the drift does not exceed 330 Hz over 10 minutes.

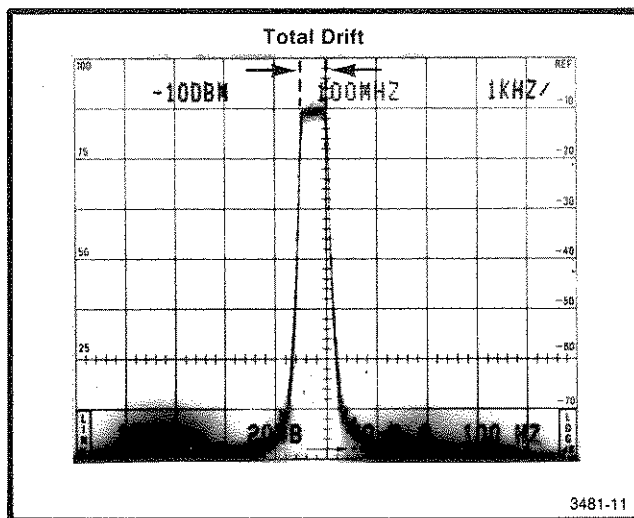

**Fig. 3-6. Typical display using Digital Storage with MAX HOLD activated to display drift.**

h. Repeat the procedure again. When doing part c, increase the FREQ SPAN/DIV to 10 kHz and cancel Phaselock. Check that the drift does not exceed 33 kHz over 10 minutes.

**8. Check Residual FM** (within 1 kHz peak-to-peak over 20 milliseconds without phaselock, within 10 Hz peak-to-peak over 20 milliseconds with phaselock)

a. Set the front-panel controls as follows:

FREQUENCY	100 MHz
FREQ SPAN/DIV	10 MHz
REF LEVEL	-20 dBm
MIN RF ATTEN	0 dB
MIN NOISE	Off
AUTO RESOLUTION	On
TIME/DIV	AUTO

b. Center the calibrator signal with the FREQUENCY control and decrease the FREQ SPAN/DIV to 10 kHz. Cancel the PHASELOCK and recenter the calibrator signal with the FREQUENCY control.

c. Set the RESOLUTION BANDWIDTH to 10 kHz and the Vertical Display to LIN. Activate FINE and adjust REF LEVEL for a full-screen display.



d. Position the calibrator signal with the FREQUENCY control so the slope (horizontal versus vertical excursion) can be measured as illustrated in Fig. 3-7A. SINGLE SWEEP is a useful way of freezing the display for measurement. Press FREE RUN to cancel SINGLE SWEEP.

e. Press ZERO SPAN (time domain operation), rotate TIME/DIV to 20 milliseconds, and adjust FREQUENCY to position the display near center screen as shown in Fig. 3-7B. Note the peak-to-peak deviation within any given horizontal division. Scale the vertical deflections according to the slope calculated in the previous step. Residual FM must not exceed 1 kHz for 20 milliseconds. Cancel ZERO SPAN.

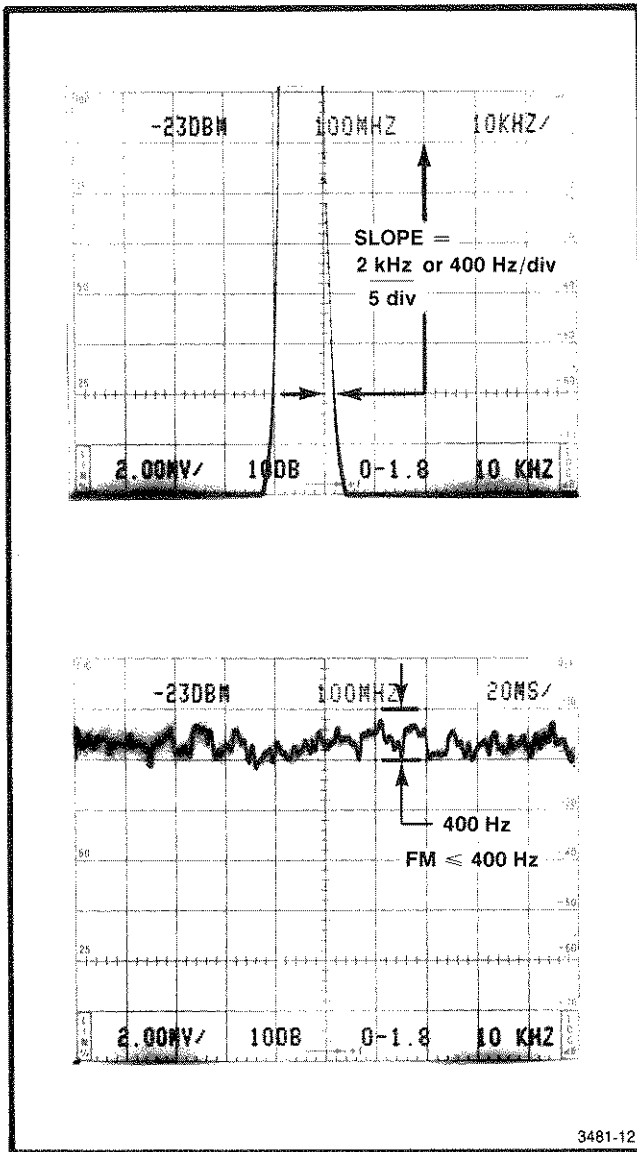

Fig. 3-7. Display that illustrates how to measure residual (incidental) FM.

any given horizontal division. Scale the vertical deflections according to the slope calculated in the previous step. Residual FM must not exceed 1 kHz for 20 milliseconds. Cancel ZERO SPAN.

f. Switch TIME/DIV to AUTO and activate PHASELOCK. Increase FREQ SPAN/DIV to bring the signal on screen, then reduce the span to 100 Hz/div and the RESOLUTION BANDWIDTH to 100 Hz. Keep the signal centered with the FREQUENCY control.

g. Calculate the slope as described in part d.

h. Press ZERO SPAN, rotate TIME/DIV to 20 milliseconds, and adjust FREQUENCY to position the display near center screen. Note the peak-to-peak deviation within any given horizontal division. Scale the vertical deflections according to the slope calculated in the previous step. Residual FM must not exceed 10 Hz/div for 20 milliseconds. Cancel ZERO SPAN.

## 9. Digital Storage

a. Set the front-panel controls as follows:

FREQUENCY	100 MHz
FREQ SPAN/DIV	200 kHz
REF LEVEL	-10 dBm
MIN RF ATTEN	0 dB
RESOLUTION BANDWIDTH	1 MHz
TIME/DIV	AUTO
Vertical Display	10 dB/DIV
Video Filter	Off
Digital Storage	VIEW A

b. With the calibrator signal applied to the RF INPUT, tune the signal to center screen. Change the VERTICAL DISPLAY to 2 dB/DIV, then activate SAVE A.

c. Change the REF LEVEL to -8 dBm and activate VIEW B. Display B of the calibrator signal should be 2 dB less than display A.

d. Activate B—SAVE A and check display. Display should show the difference between display B and display A (see Fig. 3-8).

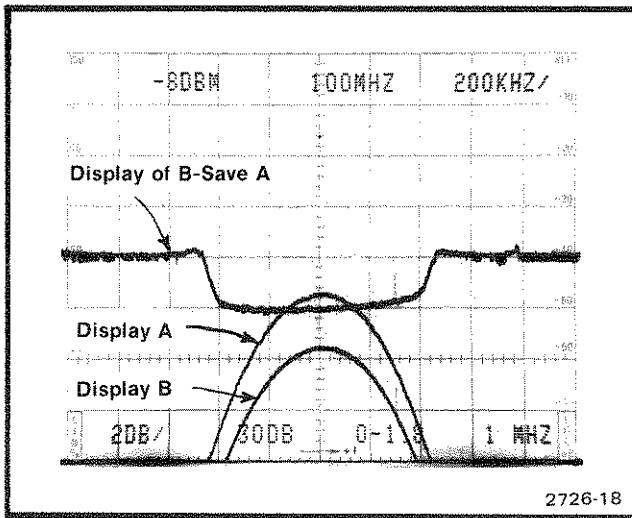

Fig. 3-8. Using Digital Storage to measure differential between two displays.

- e. Deactivate both SAVE A and B—SAVE A functions and activate MAX HOLD.
- f. Change both FREQUENCY and REF LEVEL and note that MAX HOLD function retains and holds the maximum signal amplitude and frequency excursion.
- g. Deactivate MAX HOLD and select VIEW A and AUTO BANDWIDTH. Reduce the FREQ SPAN/DIV to 100 kHz and change the Vertical Display to 10 dB/DIV.
- h. Vary the PEAK/AVERAGE control to shift the cursor over the screen height and note that signal and noise are averaged below the cursor.

This completes the operational check of the 496/496P.

## GENERAL OPERATING INFORMATION

### Firmware Version and Error Message Readout

For information, refer to subsection following Controls, Indicators, and Connectors.

### Crt Light Filters

Three light filters are supplied with the 496/496P accessories: amber, grey, and blue. Filter selection depends on

ambient light conditions, light reflections, and operator's viewing needs. The filter is installed by pulling the top of the plastic mask out and placing the filter behind the crt bezel. It is best to remove the light filter when taking display photographs.

### Intensity Level, Focus, and Beam Alignment

Operate the instrument with the intensity level no higher than that required to clearly observe the display. Trace alignment and beam focus are internal adjustments that must be performed by qualified service personnel.

Intensity level for some displays, such as pulsed spectra, must be higher, which may produce a display with a very bright baseline. This bright baseline can be clipped or subdued by activating the BASELINE CLIP.

### Signal Application

Signal frequencies up to 1.8 GHz are applied through a short, high quality, 50  $\Omega$  coaxial cable, to the RF INPUT connector. These signals pass through an internal RF attenuator, then a low-pass filter, to the first (1st) mixer.

**RF INPUT Connector.** The nominal input impedance of the coaxial RF INPUT is 50  $\Omega$ . Because cable losses can be significant at microwave frequencies, it is important to keep the cables as short as possible. Impedance mismatch between the signal source and the RF INPUT will produce reflections and degrade flatness, frequency response, sensitivity, and increase spurious responses. Impedance mismatch can be caused by poor connections, incorrect signal source impedance, long or low-quality coaxial cable, etc. When optimum flatness or frequency response is desired and signal strength is adequate, set the MIN RF ATTEN for 10 dB or more. The addition of the attenuator helps minimize reflections to improve the input characteristics.



*With MIN NOISE activated and 60 dB of MIN RF ATTEN, the REF LEVEL can be set to +40 dBm. The front end of the 496/496P is specified at +30 dBm maximum. Do not increase input signal level to full screen with a REF LEVEL of +40 dBm because this will exceed the attenuator rating. Dc input is limited to zero (0) volt.*

As stated in the preceding CAUTION, too much power can cause signal compression, or if excessive, can destroy the 1st mixer. Signals greater than  $-30$  dBm or  $-20$  dBm

in MIN NOISE mode, should be attenuated by the MIN RF ATTEN. Signals above the safe input level (+30 dBm) must be attenuated by external attenuators. Ensure that the frequency range of external attenuators is adequate.

Line stabilizing networks used for conducting EMI/RF measurements, will often have several volts of 60 Hz signal at the output. A dc block, such as Tektronix Part 015-0221-00, will protect the input mixer and prevent destruction.

Signal levels of -18 dBm or more may be compressed. This may degrade signal reference level measurements and generate spurious responses.

Spurious responses can be minimized if the signal amplitude is kept within the graticule window. A recommended procedure is to select a REF LEVEL that places stronger signals just within the graticule window. In some cases, as previously described, it may be best to add RF ATTENUATION.

**Amplitude Conversion.** The 496/496P reads out signal levels in dBm. A conversion chart shown in Fig. 3-9 provides a way to determine input signal levels from a voltage or power source.

**Connecting to 75 Ω Source:** The 496/496P can be used with a 75 Ω signal source at the lower frequencies (100 kHz—1 GHz) by using a 75 Ω to 50 Ω minimum loss attenuator. This attenuator is available as an optional accessory (refer to the accessories list in the Tektronix TV Products catalog for ordering information).

Sensitivity and power levels are often rated in dBm (dB with reference to 1 mW regardless of impedance). Sensitivity and power levels for 75 Ω systems are usually rated in dBmV (dB with reference to 1 mV across 75 Ω). Figure 3-10 is a circuit diagram of a suitable matching pad for this purpose. Figure 3-11 shows the relationship between 50 Ω and 75 Ω units, with matching attenuators included; the conversion is described as follows:

- 1)  $\text{dBmV (75 } \Omega) = \text{dBm (50 } \Omega) + 54.47 \text{ dB}$ .  
For example,  $-60 \text{ dBm (50 } \Omega) + 54.47 \text{ dB} = -5.5 \text{ dBmV (75 } \Omega)$ ;
- 2)  $\text{dBm (75 } \Omega) = \text{dBm (50 } \Omega) + 5.72 \text{ dB}$ .  
For example,  $-60 \text{ dBm (50 } \Omega) + 5.72 \text{ dB} = -54.3 \text{ dBm (75 } \Omega)$ ;
- 3) for some applications you may wish to know the relationship between dBm and dB $\mu$ V.  
For 50 Ω systems,  $\text{dB}\mu\text{V} = \text{dBm} + 107 \text{ dB}$ .

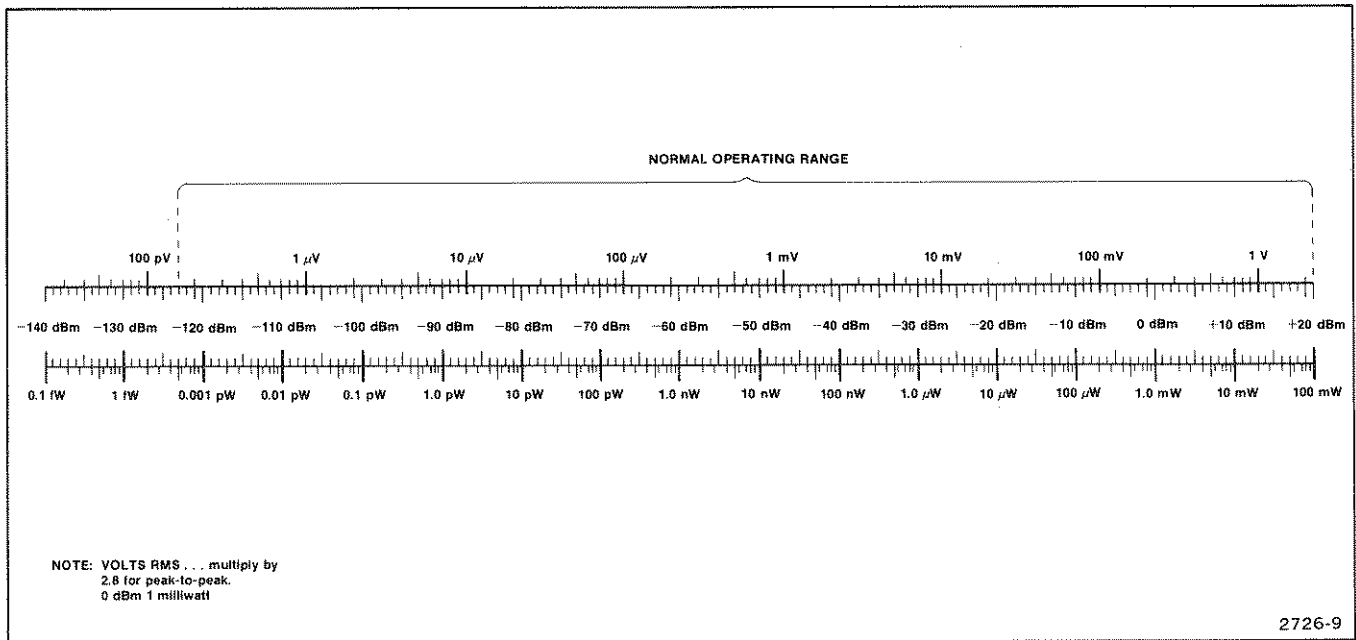

Fig. 3-9. Volts—dBm—watts conversion chart for 50 Ω impedance.

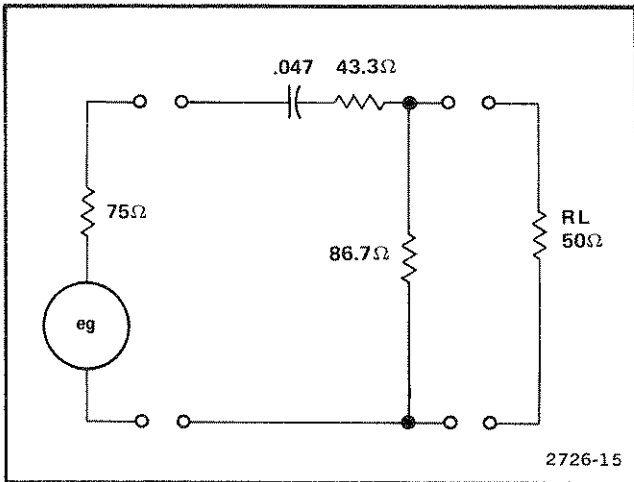

Fig. 3-10. Circuit of a 75 Ω to 50 Ω matching pad.

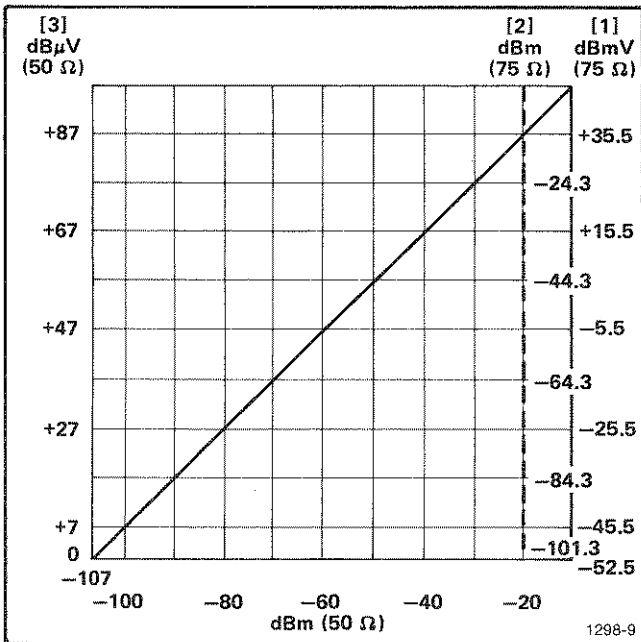

Fig. 3-11. Graph to illustrate relationship between dBm, dBmV, and dBμV (matching attenuator included where necessary).

### Resolution Bandwidth, Frequency Span, and Sweep Time

Resolution is the ability of a spectrum analyzer to display discrete frequency components within a frequency span. This ability is a function of the analyzer bandwidth, sweep time, frequency span, and incidental FM. Frequency span and sweep time are normally selected to provide the minimum resolution bandwidth setting for a particular cw signal. Bandwidth also has an effect on noise level. As the

bandwidth decreases, signal-to-noise ratio or sensitivity increases. Maximum sensitivity is therefore attained at the narrow resolution bandwidth settings.

As the analyzer sweep rate is increased, a critical rate is reached where both sensitivity and resolution are degraded. Therefore, sweep time for a calibrated display is dependent on resolution bandwidth and the frequency span.

In spans other than MAX SPAN, frequency span is symmetrical about the center frequency. In MAX SPAN the display represents the full frequency range of the selected band. A frequency dot above the display indicates the location on the spectrum of the FREQUENCY readout. The frequency span used depends on the application. Wide spans are normally used to monitor a frequency spectrum for spurious signals, check harmonic content, etc. Narrow spans are used to identify the characteristics around a particular signal, such as modulation side bands, bandwidth, power line related distortion, etc. When wide spans are used, sweep rate on non-store displays is usually increased to eliminate flicker. This requires wider resolution bandwidths. Narrow spans, used to observe signal phenomena, usually call for narrow resolution bandwidths and therefore slow sweep speeds.

The 496/496P features microcomputer circuitry that selects sweep rate and resolution bandwidth to correlate with the selected frequency span. When both TIME/DIV and RESOLUTION BANDWIDTH are in the AUTO mode, the display is calibrated for each FREQ SPAN/DIV selection. The AUTO position of the TIME/DIV selector ties the sweep speed to the analyzer span/div and resolution bandwidth. The AUTO mode of the RESOLUTION BANDWIDTH optimizes bandwidth for the selected FREQ SPAN/DIV and TIME/DIV settings unless either is outside the range of correction. When this occurs, the UNCAL indicator lights and a ">" symbol prefixes the REF LEVEL readout on the crt display.

When analyzing pulse signals, a wider bandwidth than that provided by AUTO is usually desired. The resolution bandwidth should be on the order of 1/10 the side lobe frequency width, or the reciprocal of the pulse width, in order to ensure adequate resolution. The RESOLUTION BANDWIDTH is usually set for optimum main lobe detail after the sweep rate has been selected.

### Phaselock Operation

Phaselock is activated for the narrower spans (see description under Controls, Indicators, and Connectors) to lock the 1st LO to a stable reference. If phaselock mode is

active and PHASELOCK button is pressed to deactivate phaselock, the signal may shift position and in narrow spans it may shift off screen.

### Using the Video Filter

The video filter restricts the video bandwidth so that noise or beat signals are reduced (see Fig. 3-12). When signals are closely spaced, the filter may be useful to reduce modulation between two signals so they can be more easily analyzed. The filters can also be used to average the envelope of pulsed RF spectra that has a relatively high prf (pulse repetition frequency); however, because the filter is basically an integrating circuit, selecting a Video Filter when measuring low prf spectra produces poor results.

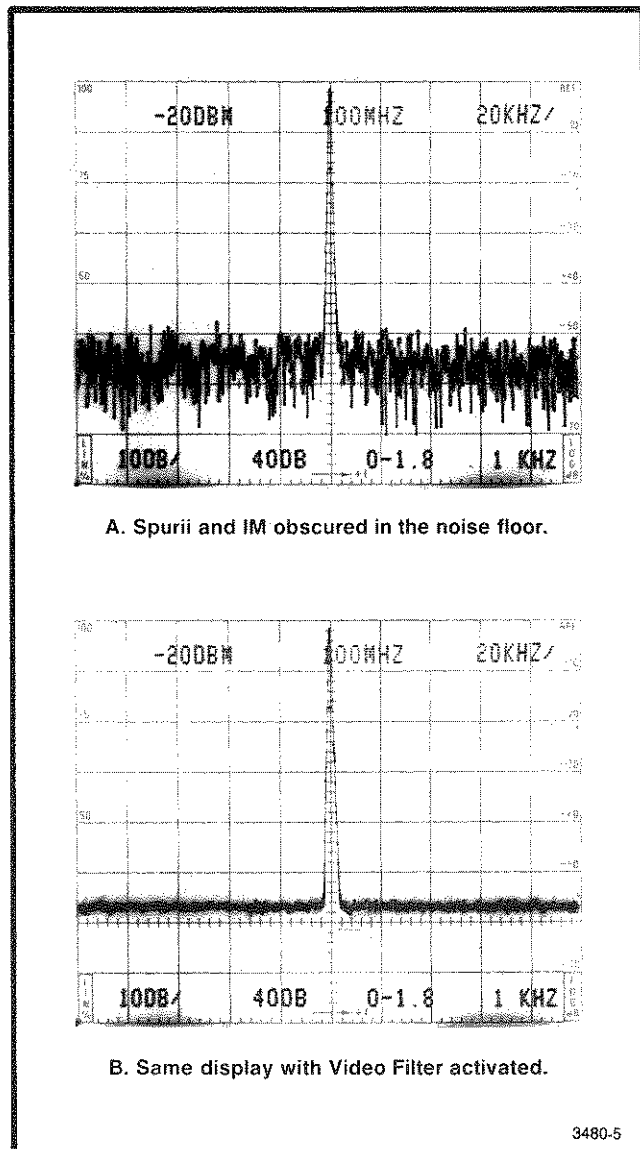

A. Spurii and IM obscured in the noise floor.

B. Same display with Video Filter activated.

Fig. 3-12. Integrating the display with the Video Filter.

The WIDE filter reduces the bandwidth to approximately 1/30th the selected resolution bandwidth; the NARROW filter about 1/300th. Using the filter may require a reduction in the sweep rate to maintain a calibrated display. The UNCAL indicator will light if the sweep speed is too fast for video filtering.

### Zero Span Operation

When the ZERO SPAN button is pressed, the 496/496P functions as a tunable receiver to display time domain characteristics within the capabilities of the selected resolution bandwidth. The TIME/DIV selector can now be used to analyze such characteristics as modulation pattern, pulse repetition rates, etc.

### Triggering the Display

Triggering is usually FREE RUN for spectrum displays; however, it may be desirable or necessary to trigger the display when the event is time related to some source or when the frequency span has been reduced to zero for time domain analysis. In the FREE RUN mode, the sweep will not synchronize with any input signal.

The sweep can be triggered internally from the vertical or video signal, at the line frequency rate of the power supply, or from an external signal applied to the EXT IN HORIZ/TRIG jack on the back panel. The amplitude of trigger signal required to trigger the sweep is two (2.0) division or more, for internal triggering, and 1.0 volt to a maximum of 50 volts (dc + peak ac) for external triggering.

Trigger source is selected by activating one of the triggering push buttons. In addition to the four trigger source selections, SINGLE SWEEP mode can be selected. The sweep will run once after the circuit has been armed and trigger signal arrives. The READY indicator lights when the circuit is armed and waiting for a trigger signal, and remains lit until the sweep has run. Pushing the SINGLE SWEEP button once activates SINGLE SWEEP mode; pushing it again arms the trigger circuit so it is ready for a trigger signal.

### Sweeping the Display

Horizontal sweep for the display is either internal or from an external sweep source. Sweep rate and source are selected by the TIME/DIV switch. When the TIME/DIV switch is in the AUTO position, the sweep rate is controlled by the internal microcomputer.

When the TIME/DIV switch is in the EXT position, a signal source of 0 to +10 volts, applied to the EXT IN HORIZ/TRIG connector, will sweep the crt beam the full 10 division graticule span. The input is dc coupled, sensitivity is 1 V/div. External input impedance is about 10 k $\Omega$ .

The beam can be positioned by the MANUAL SCAN control when the TIME/DIV is in the MNL position (see Manual Scan of the Spectrum that follows).

### Manual Scan of the Spectrum

Manual scan is used to examine a particular point or portion of a display such as one of the null points of a frequency modulation spectrum or where a slow sweep of the full span would take unnecessarily long. When the TIME/DIV control is set in the MNL position, the display may be swept with the MANUAL SCAN control. The sweep scan is usually first calibrated in one of the timed sweep positions. Note that with a wide span/div and/or a narrow resolution bandwidth setting, it is possible to scan too rapidly to achieve an accurate display. Also, digital storage can give unpredictable results when used with the MNL SCAN mode. Digital storage is updated only when scanning toward the right.

### Reference Level, RF Attenuation, and Vertical Display

A change in the REF LEVEL control requests the microcomputer to change the display reference level—the amplitude represented by the top of the crt graticule. The microcomputer selects the gain distribution (IF gain and input RF attenuation) for the new reference level according to the setting of the FINE, Vertical Display mode, MIN RF ATTEN, and MIN NOISE/MIN DISTORTION selectors.

The amount of attenuation between the RF INPUT and the first mixer, set by the microcomputer, is based on the reference level requested and the mode of the MIN RF ATTEN and MIN NOISE/MIN DISTORTION selectors. The microcomputer assumes the MIN RF ATTEN selection is the minimum attenuation required for the expected signal levels. It does not reduce RF attenuation below this value. It also selects the best ratio of RF attenuation and IF gain according to the MIN NOISE/MIN DISTORTION mode (see description that follows). As MIN RF ATTEN is increased, the lower limit reference level is raised an equal amount. At 0 dB minimum attenuation, the lower limit reference level is -123 dBm. At 10 dB minimum attenuation, the reference level goes to -113 dBm, etc.

The reference level increments depend on the Vertical Display mode and FINE selector mode. Reference level steps for the log displays are 10 dB and 1 dB with FINE off,

and 1 dB and 0.25 dB with FINE activated (0.25 dB steps apply to the  $\Delta A$  mode). For LIN displays with FINE off, the microcomputer selects the reference level, which is the equivalent of an 8-division signal, where the bottom of the crt graticule is zero volt and the top of the crt graticule is eight times the vertical display factor. The display factor changes in a 1-2-5 volts/division sequence. For LIN displays with FINE on, the reference level changes in 1 dB steps and the scale factor is 1/8 the voltage equivalent of the reference level.

### Delta A Mode

To select this mode, activate 2 dB/DIV and FINE; the REF LEVEL readout becomes \*0.00 dB and the REFERENCE LEVEL steps in 0.25 dB increments.

The  $\Delta A$  mode is useful for measuring relative amplitude differences of signals more accurately. This is because the gain distribution (IF gain and RF attenuation) is not changed when  $\Delta A$  mode is activated. The REF LEVEL is changed by shifting the log amplifier offset. The measurement range of the  $\Delta A$  mode is at least from 10 dB above to 40 dB below the reference level established when the mode was activated; however, the overall instrument display characteristic of -123 dBm to +30 dBm cannot be exceeded. The asterisk in the REF LEVEL readout remains until the  $\Delta A$  mode gain distribution is changed.

The  $\Delta A$  mode is canceled when either FINE or 2 dB/DIV are deactivated, or a selector that could change gain distribution (MIN RF ATTEN or MIN NOISE) is changed.

Signals with large differences in amplitude that are within the  $\Delta A$  range can be compared without the distortion usually introduced when signals are driven off-screen. Signals shifted off-screen by changes in the  $\Delta A$  reference level are not overdriving the input because the attenuator and IF gain are not changed; thus the mixers do not see any change in signal levels due to the  $\Delta A$  reference level changes.

To measure amplitude level differences of two signals:

- 1) select  $\Delta A$  mode by activating 2 dB/DIV and FINE;
- 2) using the REF LEVEL control, set the larger amplitude signal to a graticule line;
- 3) press the FINE push button twice to deactivate and re-activate the  $\Delta A$  mode;

- 4) using the REF LEVEL control, set the lower amplitude signal to the same graticule line established in part 2;
- 5) the REF LEVEL readout displays amplitude level difference in dB.

### MIN NOISE/MIN DISTORTION

This push button selects one of two algorithms that control attenuator and IF gain settings. MIN NOISE minimizes noise level while MIN DISTORTION minimizes input mixer overload. To observe any change when MIN NOISE is activated, the RF ATTEN crt readout must be 10 dB higher than that set by the MIN RF ATTEN selector.

#### CAUTION

*With MIN NOISE activated and 60 dB of MIN RF ATTEN, the REF LEVEL can be set to +40 dBm. The front end of the 496/496P is specified at +30 dBm maximum. Do not increase input signal level to full screen with a REF LEVEL of +40 dBm because this will exceed the attenuator rating. Dc input is limited to zero (0) volt.*

### Digital Storage

Digital storage provides a smooth (flicker free) display. Two complete sweeps can be stored. One of these can be saved and then compared to subsequent updated information. A MAX HOLD feature updates the stored data in memory when the new input is of higher amplitude, thus allowing monitoring and graphic plotting of display changes with time. Vertical information can be divided by a cursor, or horizontal line, that is positioned with the PEAK/AVERAGE control. Above the cursor, video information is peak detected and displayed; below the cursor, signal averaging occurs. The average (number of samples) is a function of sweep speed. The slower the sweep, the greater the number of samples averaged. This feature suppresses noise in that portion below the cursor and allows full peak detection of vertical data above the cursor. An intensified spot on the cursor indicates the horizontal position at which memory is being updated.

When digital storage is used, an additional quantization error of 0.5% of full screen must be added to the amplitude performance characteristics (i.e., frequency response, sensitivity, etc.).

Digital storage memory is functionally divided into two sections—A and B. Data can be stored in A or B or in both. There are 512 horizontal locations in A and 512 horizontal locations in B. When both are displayed, the origin of B is shifted such that the A and B coordinates are interlaced to provide 1024 display increments. Data in memory is continually updated with each sweep so the display, when viewing A or B, is always current.

When SAVE A function is activated, data in A memory is held in storage and only B memory is updated. This inhibition takes place whether A is displayed or not. This mode captures an event or waveform for comparison with a subsequent event displayed by VIEW B mode. In this mode all of A memory is displayed, then all of B, each by a separate sweep.

When B—SAVE A is activated, the contents of data in B memory minus the contents saved in A are displayed. This provides the comparison of the two events by presenting the algebraic difference of the two displays. This convenient mode can be used to align filters or other devices when tuning for a null. The reference waveform is stored in A and the unknown in B. If the device under test is active, the B waveform may be larger than the reference which results in a shift in the zero reference line. The position of the zero reference can be selected with an 8-bit digital switch. The reference level is normally set mid-screen so positive and negative quantities can be observed. Qualified service personnel can position the reference anywhere within the graticule window.

MAX HOLD causes the digital memory to be updated only if the new input is of higher magnitude than the former (B memory only if SAVE A is active). This allows monitoring of signals that may change with time and provides a graphic record of amplitude/frequency excursions.

Signal averaging is useful for suppressing noise. The number of samples averaged per digitized slot (increment) is a function of the spectrum analyzer sweep rate. The slower the sweep speed, the more samples averaged per resolution bandwidth. Resolution bandwidth also affects the amplitude difference between peak detected and average levels of cw signals. When the resolution bandwidth is less than 1/30th the span/division (e.g., 100 kHz or less with 5 MHz span/div) there will be significant difference between peak and average amplitude levels of cw signals. The peak value will be the true value, the average value will be in error, especially if only A or B is displayed. It is best to run digital storage with both A and B interlaced when using narrow resolution bandwidth with wide frequency spans.

To analyze signal amplitude level, set the cursor at least 1/4 division below the signal peak. To average noise, set the cursor at least 1/4 division above the noise level.

### 496P GPIB CONTROLS, INDICATORS, AND CONNECTORS

The 496P adds remote control to the features of the 496. Remote control is accomplished by a controller connected to the 496P through the General Purpose Interface Bus (GPIB—IEEE Std 488). The following is a description of the controls, indicators, and connectors that are unique to the 496P.

For a description of programming techniques for the 496P, refer to the 496P Programmer's manual.

### Front Panel (Figs. 3-13 and 3-14)

**RESET TO LOCAL (REMOTE).** This button is lighted when the GPIB controller takes remote control of the analyzer. While the 496P is under remote control, its other front-panel controls are not active, but indicators still reflect the current state of front-panel functions.

This button is not lighted when the operator has local control. While the analyzer is under local control, it does not execute GPIB messages that would conflict with front-panel controls or change the waveforms in digital storage.

Pressing this button restores local control unless the controller prevents this with the local lockout message. Programmable functions do not change when switching from remote to local control except as necessary to match the settings of the front-panel controls for TIME/DIV, MIN RF ATTEN, and PEAK/AVERGE.

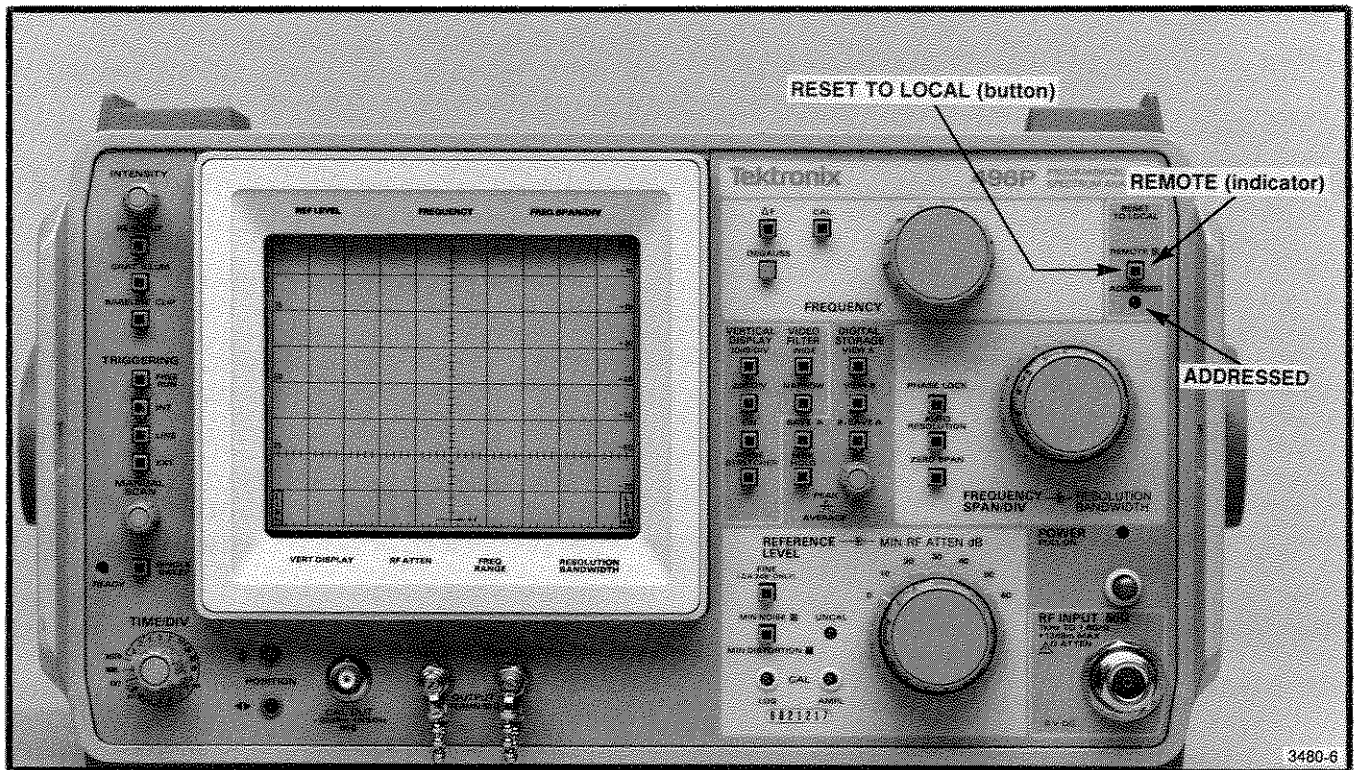

Fig. 3-13. GPIB control and indicators on the front panel.



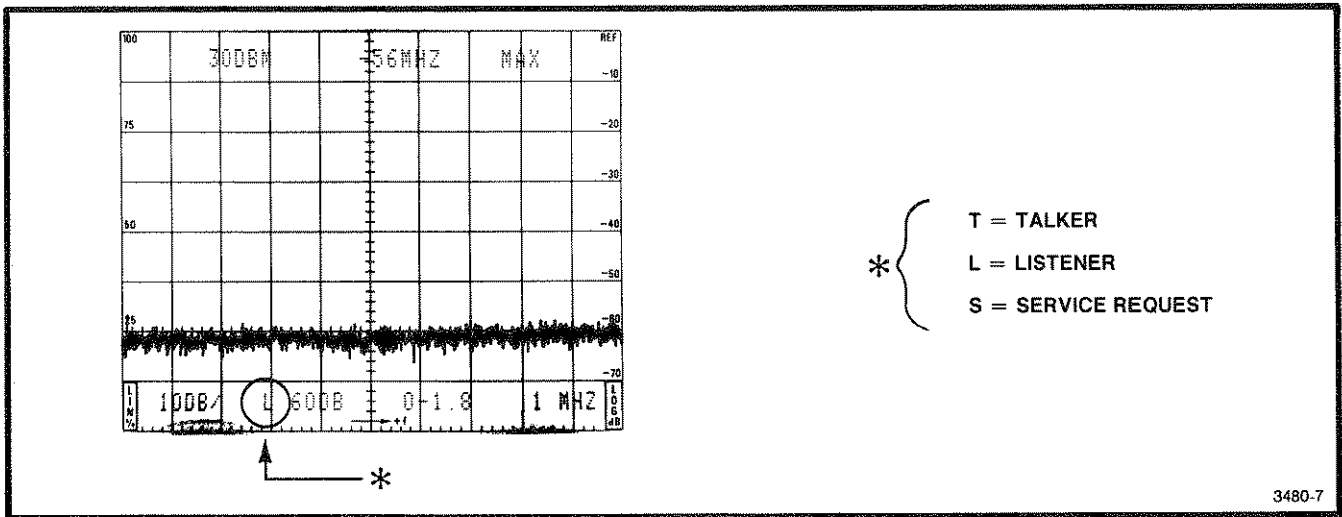

Fig. 3-14. Status of GPIB functions indicated when active.

The internal 496P microcomputer flashes the firmware version number and GPIB address on the crt when the button is pressed. This also causes the microcomputer to update the GPIB primary address if the GPIB ADDRESS switches have been changed.

This button has another function in talk-only mode. See the following Talk/Listen Only Operation information.

When the 496P is executing a message that includes the REPEAT command, the REPEAT loop can only be aborted by DCL and then only if the loop contains a WAIT command. Pressing RESET TO LOCAL does not abort the loop, but only causes execution errors to be reported if the loop contains front-panel commands.

Beginning with version 1.2 firmware, pressing RESET TO LOCAL while a message including the REPEAT command is executing, limits message execution to 256 times if the message contains WAIT. A SIGSWP command preceding WAIT in the message is ignored after the RESET TO LOCAL button is pressed, so the REPEAT loop completes quickly.

**ADDRESSED.** Lights when analyzer is addressed to listen or talk.

**GPIB Function Readout.** A single character appears in the crt readout when the 496P is talking, listening, or requesting service. The character appears in the position shown in Fig. 3-14, but only while the 496P is addressed to talk or listen or is asserting SRQ.

Rear Panel (Figs. 3-15 and 3-16)

**Setting the GPIB ADDRESS Switches.** Switches on the rear panel set the value of the lower five bits of the instrument's GPIB addresses. The value of these switches is called the instrument's primary address. Details of how the switches are used in remote control are found in the Programmer's manual.

Set the switches as desired, but don't use 0 with 4050-Series controllers—they reserve this address for themselves. Selecting a primary address of 31 logically removes the 496P from the bus; it does not respond to any GPIB address, but remains both unlistened and untalked. Remember, if you change these switches after the 496P is already powered-up, you must press RESET TO LOCAL to cause the microcomputer to update the primary address.

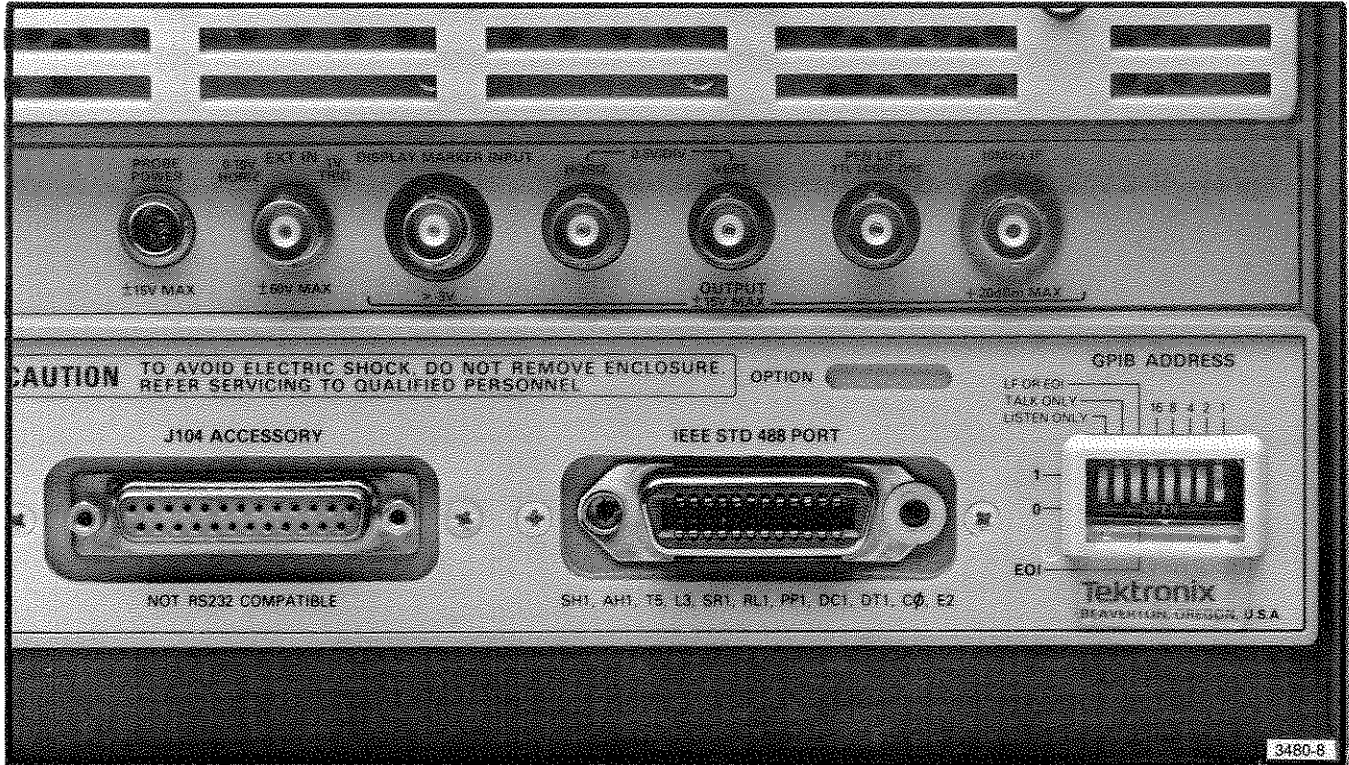

Fig. 3-15. The 496P GPIB port and switches.

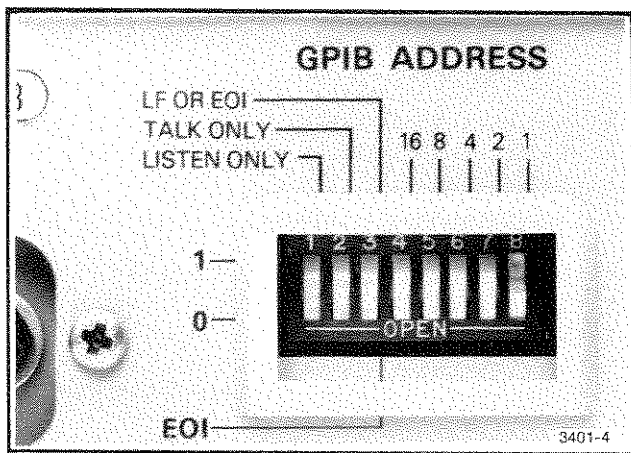

Fig. 3-16. GPIB address, LF, EOI, TALK-ONLY, and LISTEN-ONLY switches.

### 496P TALK/LISTEN-ONLY Operation

The 496P can be operated as a talker only or a listener only on the GPIB under local control. A simple system requires only the 496P and a talker or listener. Such a system using the 4924 Digital Cartridge Tape Drive is shown in Fig. 3-17.

This system can be used to save spectrum measurements for later display on the 496P or analysis by a controller. This system can also be used to save and restore analyzer control settings.

**TALK ONLY, LISTEN ONLY Switches.** The 496P switches for talk-only and listen-only operation are part of the GPIB ADDRESS switch bank (Figs.

3-15 and 3-16). Set either or both switches—an extension of the IEEE 488 standard allows you to enable both talk-only and listen-only operation. If 496P power is already on, press RESET TO LOCAL to cause a change in these switches to take effect.

Set the LF OR EOI switch to EOI for use with Tektronix equipment. The switches marked 1, 2, 4, 8, and 16 may be set to any combination except all ones (decimal 31), which logically disconnects the 496P from the bus.

The MODE CONTROL switches on the 4924 rear panel must be set as a pair to operate with the 496P. Set SW1 to On and SW2 to Off (same as for operating with the 4051) or set both switches to the same position (both SW1 and SW2 On or Off).

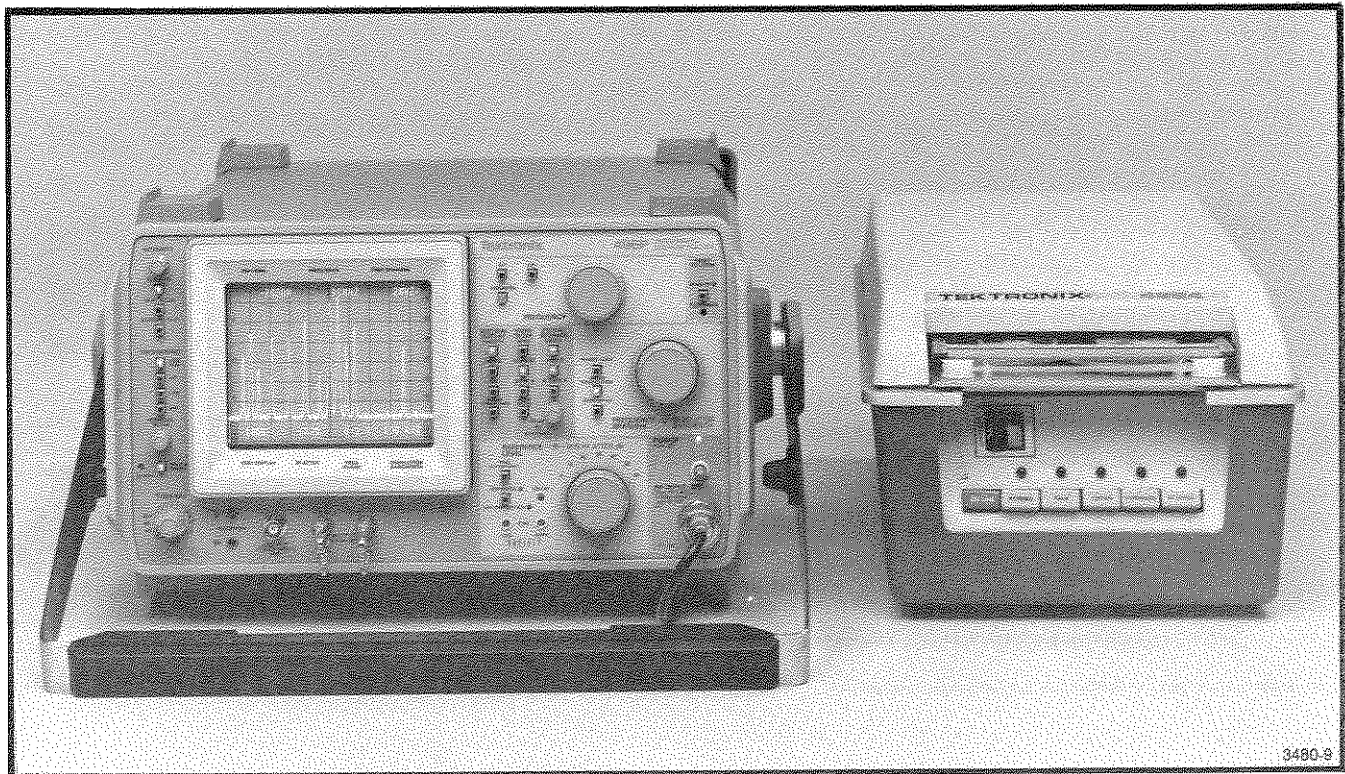

Fig. 3-17. The TEKTRONIX 4924 Digital Cartridge.

### Data Logging

With the TALK ONLY switch set, you can write spectrum data onto a tape in the 4924 using the controls shown in Fig. 3-18.

1. Insert a marked tape into the 4924. The tape must be previously marked for the size and number of files you expect to record (see the Programmer's manual for tape marking).

2. Connect the 4924 and 496P with a GPIB cable after both are powered up.

3. Set the 4924 ON LINE switch out (off line).

4. Rewind the tape.

5. Press FORWARD to advance to file 1. Press FORWARD again, as desired, to reach a file further into the tape.

6. To save the current control settings and waveform in digital storage, press LISTEN on the 4924 and RESET TO LOCAL on the 496P.

Pressing the RESET TO LOCAL button causes the analyzer to transmit instrument settings and a waveform. The message is formatted so that when it is played back to the analyzer, it restores the settings and display. The message is a combination of the responses to the SET and CURVE queries.

If SAVE A is Off, A and B are transmitted as a full waveform (A and B memories are merged for 1000 points).

If SAVE A is On, A and B are transmitted as separate waveforms (500 points each).

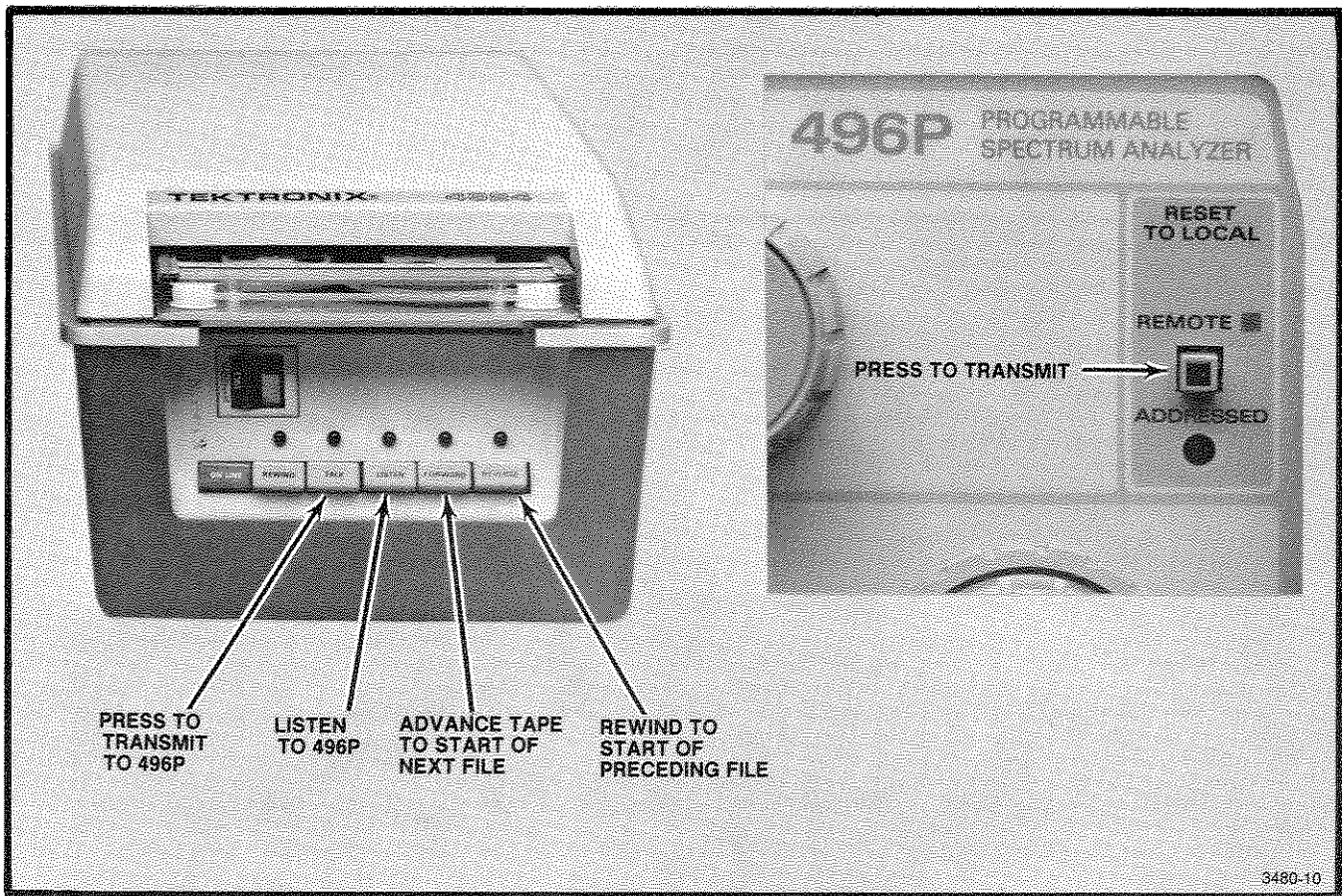

Fig. 3-18. Controls on the 4924 and 496P used for TALK/LISTEN-only data transfers.

The analyzer transmits waveform data as ASCII-coded decimal numbers unless changed by the ENCDG argument in a WMPRE command. You'll find the full CURVE? response syntax diagram in Section 5 of the Programmer's manual. See Section 7 of the Programmer's manual for the full SET? response syntax program.

#### NOTE

*If an internal switch is changed, the analyzer reports only control settings when RESET TO LOCAL is pressed. Refer questions about setting this internal switch to qualified service personnel.*

The 4924 keeps listening (or talking if TALK is pressed) until the message transfers ends—there is no reset switch except for POWER. The 496P, once it starts talking, keeps talking until finished. It also cannot be interrupted except by turning off the power. (This is true only if the 496P begins transmitting—if there is no listener, it flashes a message to the operator and returns to local control.)

7. To move to the next file, press FORWARD. To move to the previous file, press REVERSE. To move to the beginning of the same file, press REVERSE, then FORWARD.

### Restoring Control Settings and Display

With the LISTEN ONLY switch set, the 496P buffers and executes device-dependent messages (except for interrupt control commands EOS and RQS). Since the remote-local state diagram in the IEEE 488 standard does not cover the listen-only mode, we have chosen to implement this mode so the 496P goes to remote state after buffering a message. This makes listen-only mode consistent with the nonlisten-only mode, which requires that the 496P be under remote control to execute commands that change front-panel settings or waveform data in digital storage.

To restore control settings and a display previously recorded:

- a) find the file on the tape using FORWARD or REVERSE on the 4924;
- b) press TALK. The 496P goes to remote to execute the message and then returns to local control.

Listen-only mode can be used for a comparison test. Settings and a waveform previously recorded with SAVE A on can be played back to the analyzer. The analyzer automatically sets up to make the same measurement (turning on SAVE A), and saves the comparison waveform in A

memory. If B—SAVE A is selected, the operator can compare the current spectrum data being acquired in B memory to the saved waveform in A memory.

### Connecting to a System

The 496P can be connected directly to a GPIB system with the cable supplied with the instrument. The port is shown in Fig. 3-15. To avoid interference on the bus, connect the 496P after turning on power or while the controller on the bus is turned off.

## 496/496P OPERATIONAL PRECAUTIONS

**1. Signal FM.** Check to see if the PHASELOCK switch is activated before deciding that the displayed signal is FM'ing or the spectrum analyzer is malfunctioning.

**2. Correct Trigger Mode.** The triggering mode is usually in FREE RUN. In pulsed RF applications, a triggered display is required to measure between pulse repetition lines for determining the pulse repetition rate.

Since INTERNAL triggering needs more than two divisions of signal amplitude, tune the center frequency so that an adequate signal is located at the sweep start before changing the trigger source from FREE RUN to INT.

**3. Level of Pulsed Signals.** The spectrum for a pulsed signal is spread out. Consequently, the height of the crt response is less for a pulsed signal than for a cw signal of the same peak amplitude. This loss in display height means, in effect, a loss in sensitivity. The amount of loss can be computed from:

$$\text{voltage loss} = (t_0 B)^{-1} \text{ where}$$

$$t_0 = \text{pulse duty cycle}$$

$$B = \text{resolution bandwidth}$$

The spectrum analyzer self-generated noise power increase is proportional to bandwidth. Pulsed RF voltage level is also proportional to bandwidth. Since power is proportional to voltage squared, a wider bandwidth gives better sensitivity and greater dynamic range for pulsed RF inputs.

When in doubt about signal level overdrive problems, reduce the signal level by inserting RF attenuation, then repeat the measurement. If the two agree, the measurement is correct; if not, the input mixer state is probably overdriven.



## Operation—496/496P Operators

An important consideration for pulsed RF measurements is the peak signal level at the mixer. It is greater by  $(t_0 B)^{-1}$  than the peak level displayed on the crt. Taking the sensitivity loss into account is the only sure way of ascertaining that the mixer peak power input for linear operation is not exceeded.

**4. Level of Continuous Wave Signals.** Similar problems can occur when analyzing cw signals at relatively narrow span widths. The large cw signal may not appear on screen because its frequency is outside the set span width. The mixer nevertheless is saturated and will compress signals.

**5. Excessive Input Signal Level.** Too much input power will destroy the front end mixer or attenuator. Replacement mixers and attenuators are costly. When working with high power signals, use couplers or other devices to reduce the signal down to acceptable levels. Once the signal is down below the rating of the RF attenuator, prevent possible mixer damage by starting with the MIN RF ATTEN fully in, then reduce attenuation if needed.

**6. No Crt Trace.** The BASELINE CLIP is used to reduce the intensity of the baseline. If Triggering, Intensity, Vertical Position, etc., all seem to be in order and there is no crt trace, check the BASELINE CLIP state.

**7. Digital Storage Effects on Signal Analyses.** When operating with digital storage, the frequency base is divided into storage slots. For peak displays (above the PEAK/AVERAGE cursor) the display point in each slot corresponds to the maximum sampled value of the signal. Samples are taken at about  $9 \mu s$  intervals. When sweeping at one second per division, this is about 1000 samples per slot. For average displays (below the cursor) the values of all samples per slot are summed and divided by the number of samples to compute the display point for each slot. Each display point is interconnected to create a smooth display. When A or B are displayed independently, only half of the slots are interconnected. The following are a few pitfalls that can occur.

For wide spans and relatively narrow resolution bandwidth (50 or more resolutions per division), the resolution bandwidth equals a digital storage slot. If that slot is in A memory and only B memory is displayed, that point of the signal is not displayed and an erroneous level results. SAVE A will display the correct value because an algorithm chooses the larger of adjacent display points to store in A memory.

If the PEAK/AVERAGE cursor is set above the signal level, the average value for each digital slot will be displayed. With narrow resolution bandwidths compared to the slot width, the average value of the resolution response shape will be displayed, which has nothing to do with signal amplitude.

To avoid the above pitfalls, it is best to run digital storage with A and B interlaced. Do not set the PEAK/AVERAGE cursor to average a cw signal. It is best to set the cursor about 1/4 division above the signal to be averaged and about 1/2 division below the signal to be analyzed.

None of these restrictions apply when the resolution bandwidth is wide compared to a digital storage slot (e.g., 50 MHz/div with 1 MHz resolution).

**8. Stored Display Averaged in Wide Spans.** When operating in wide spans, with digital storage, low level signals will be averaged with the noise and lost if the PEAK/AVERAGE cursor is above the display. Turn the control fully counterclockwise for peak detection when operating with wide spans.

**9. Cold Storage or Power-Interrupt Initialization.** After storage below the operating temperature range (see Table 1-2, Environmental Characteristics), the microcomputer may not power up correctly. If so, allow the instrument to warm up for at least 15 minutes and reinitialize the microcomputer; turn power off for five seconds, then turn it back on. Repeat, if necessary. It may also be necessary to reinitialize the microcomputer after a power interruption.

## Service Manual

The 496/496P Service instruction manuals are separate publications that include circuit description, troubleshooting information, calibration procedures, schematic diagrams, and other maintenance information. Service manuals are intended for use by QUALIFIED SERVICE PERSONNEL ONLY. To avoid electrical shock, DO NOT perform any servicing unless qualified to do so.

## Product Service

To assure adequate product service and maintenance for our instruments, Tektronix, Inc., has established Field Offices and Service Centers at strategic points throughout the United States and outside the United States in all countries where our products are sold. Contact your local Service Center, representative, or sales engineer for details regard-

ing: Warranty, Calibration, Emergency Repair, Repair Parts, Scheduled Maintenance, Maintenance Agreements, Pickup and Delivery, On-Site Service for fixed installations, and other services available through these centers.

**Emergency Repair.** This service provides immediate attention to instrument malfunction if you are in an emergency situation such as a field trip. Again, contact any Tektronix Service Center for assistance.

**Maintenance Agreements.** Several types of maintenance or repair agreements are available. For example: for a fixed fee, a maintenance agreement program provides maintenance on a regular basis. Any Service Center can furnish complete information on costs and types of maintenance programs.

1  
2  
3  
4  
5  
6  
7  
8  
9  
10  
11  
12  
13  
14  
15  
16  
17  
18  
19  
20  
21  
22  
23  
24  
25  
26  
27  
28  
29  
30  
31  
32  
33  
34  
35  
36  
37  
38  
39  
40  
41  
42  
43  
44  
45  
46  
47  
48  
49  
50  
51  
52  
53  
54  
55  
56  
57  
58  
59  
60  
61  
62  
63  
64  
65  
66  
67  
68  
69  
70  
71  
72  
73  
74  
75  
76  
77  
78  
79  
80  
81  
82  
83  
84  
85  
86  
87  
88  
89  
90  
91  
92  
93  
94  
95  
96  
97  
98  
99  
100



# OPTION INFORMATION

## **Option 30**

Rackmount version of 496/496P Spectrum Analyzer.

## **Option 31**

Rackmount version of 496/496P with cables from front panel connectors to connectors at the back of the cabinet.

## **Option 32**

Benchtop version of 496/496P Spectrum Analyzer.

1  
2  
3  
4  
5  
6  
7  
8  
9  
10  
11  
12  
13  
14  
15  
16  
17  
18  
19  
20  
21  
22  
23  
24  
25  
26  
27  
28  
29  
30  
31  
32  
33  
34  
35  
36  
37  
38  
39  
40  
41  
42  
43  
44  
45  
46  
47  
48  
49  
50  
51  
52  
53  
54  
55  
56  
57  
58  
59  
60  
61  
62  
63  
64  
65  
66  
67  
68  
69  
70  
71  
72  
73  
74  
75  
76  
77  
78  
79  
80  
81  
82  
83  
84  
85  
86  
87  
88  
89  
90  
91  
92  
93  
94  
95  
96  
97  
98  
99  
100

# APPENDIX A

## GLOSSARY

The following glossary is presented as an aid to better understand the terms as they are used in this document.

### General Terms

**Baseline Clipper (Intensifier).** Increasing the brightness of the signal relative to the baseline portion of the display.

**Center Frequency.** The frequency that corresponds to the center of a frequency span, expressed in hertz.

**dBc.** dB below carrier level.

**Effective Frequency Range.** That range of frequency over which the instrument performance is specified. The lower and upper limits are expressed in hertz.

**Envelope Display.** The display produced on a spectrum analyzer when the resolution bandwidth is greater than the spacing of the individual frequency components.

**Full Span (Maximum Span).** A mode of operation in which the spectrum analyzer scans an entire frequency band.

**Intermodulation Spurious Response (Intermodulation Distortion).** An unwanted spectrum analyzer response resulting from the mixing of the  $n$ th order frequencies. This is caused by non-linear elements of the spectrum analyzer, resulting in a spurious response being displayed.

**Line Display.** The display produced on a spectrum analyzer when the resolution bandwidth is less than the spacing of the signal amplitudes of the individual frequency components.

**Line Spectrum.** A spectrum composed of signal amplitudes of the discrete frequency components.

### Maximum Safe Input Power

**WITHOUT DAMAGE.** The maximum power applied at the input that will not cause degradation of the instrument characteristics

**WITH DAMAGE.** The minimum power applied at the input that will damage the instrument.

**Pulse Stretcher.** A pulse shaper that produces an output pulse, whose duration is greater than that of the input pulse, and whose amplitude is proportional to that of the peak amplitude of the input pulse.

**Scanning Velocity.** Frequency span divided by sweep time and expressed in hertz per second.

**Spectrum Analyzer.** An apparatus that is generally used to display the power distribution of an incoming signal as a function of frequency.

### NOTE

*It is useful in analyzing the characteristics of repetitive electrical waveforms in general, since repetitively sweeping through the frequency range of interest will display all components of the signal.*

**Video Filter.** A post detection low-pass filter.

**Zero Span.** A mode of operation in which the frequency span is reduced to zero.

## Terms Related to Frequency

**Display Frequency.** The input frequency as indicated by the spectrum analyzer and expressed in hertz.

**Frequency Drift.** Gradual shift or change in displayed frequency over the specified time due to internal changes in the spectrum analyzer, and expressed in hertz per second, where other conditions remain constant.

**Frequency Linearity Error.** The error of the relationship between the frequency of the input signal and the frequency displayed (expressed as a ratio).

**Frequency Span (Dispersion).** The magnitude of the frequency band displayed, expressed in hertz or hertz per division.

**Impulse Bandwidth.** The displayed spectral level of an applied pulse divided by its spectral voltage density level assumed to be flat within the pass-band.

**Residual FM (Incidental FM).** Short term displayed frequency instability or jitter due to instability in the spectrum analyzer local oscillators, given in terms of peak-to-peak frequency deviation and expressed in hertz, or percent of the displayed frequency.

**Shape Factor (Skirt Selectivity).** The ratio of the frequency separation of the two (60 dB/6 dB) down points on the response curve to the static resolution bandwidth.

**Static (Amplifier) Resolution Bandwidth.** The specified bandwidth of the spectrum analyzer's response to a cw signal, if sweep time is kept substantially long.

### NOTE

*This bandwidth is the frequency separation of two down points, usually 6 dB, on the response curve, if it is measured either by manual scan (true static method) or by using a very low speed sweep (quasi-static method).*

**Zero Frequency Span.** A spurious display at zero input frequency.

## Terms Related to Amplitude

**Deflection Coefficient.** The ratio of the input signal magnitude to the resultant output indication.

### NOTE

*The ratio may be expressed in terms of volts (rms) per division, decibels per division, watts per division, or any other specified factor.*

**Display Dynamic Range.** The maximum ratio of the levels of two non-harmonically related sinusoidal signals, each of which can be simultaneously measured on the screen to a specified accuracy.

**Display Flatness.** The unwanted variation of the displayed amplitude over a specified frequency span, expressed in decibels.

**Display Law.** The mathematical law that defines the input-output function of the instrument.

### NOTE

*1) Linear—A display in which the scale divisions are a linear function of the input signal voltage;*

*2) Square law (power)—A display in which the scale divisions are a linear function of the input signal power;*

*3) Logarithmic—A display in which the scale divisions are a logarithmic function of the input signal voltage.*

**Display Reference Level.** A designated vertical position representing a specified input level.

### NOTE

*The level may be expressed in decibels (e.g., 1 mW), volts, or any other units.*

**Dynamic Range.** The maximum ratio of the levels of two signals simultaneously present at the input that can be measured to a specified accuracy.

**Equivalent Input Noise Sensitivity.** The average level of a spectrum analyzer's internally generated noise referenced to the input.

**Frequency Response.** The unwanted variation of the displayed amplitude over a specified center frequency range, measured at the center frequency, expressed in decibels.

**Gain Compression.** Maximum input level where the scale linearity error is below that specified.

**Hum Sidebands.** Undesired responses created within the spectrum analyzer that are separated from the desired response by the fundamental or harmonic of the power line frequency.

**Input Impedance.** The impedance at the desired input terminal.

**NOTE**

*Usually expressed in terms of VSWR, return loss, or other related terms for low impedance devices and resistance-capacitance parameters for high impedance devices.*

**Noise Sidebands.** Undesired response caused by noise internal to the spectrum analyzer appearing on the display around a desired response.

**Relative Display Flatness.** The display flatness measured relative to the display amplitude at a fixed frequency within the frequency span, expressed in decibels.

**NOTE**

*Display flatness is closely related to frequency response. The main difference is that the spectrum display is not recentered.*

**Residual Response.** A spurious response in the absence of an input signal. (Noise and zero frequency are excluded.)

**Sensitivity.** Measure of a spectrum analyzer's ability to display minimum level signals, at a given IF bandwidth, display mode, and any other influencing factors, and expressed in decibels (e.g., 1 mW).

**Spurious Response.** A response of a spectrum analyzer wherein the displayed frequency does not conform to the input frequency.

**Terms Related to Digital Storage for Spectrum Analyzers**

**Clear (Erase).** Presets memory to a prescribed state, usually that denoting zero.

**Digitally Averaged Display.** A display method whereby the displayed function is held in a digital memory. The display is generated by reading the data out of memory.

**Max Hold (Peak Mode).** Digitally stored display mode that, at each frequency address, compares the incoming signal level to the stored level and retains the greater. In this mode, the display indicates the peak level at each frequency after several successive sweeps.

**Multiple Display Memory.** A digitally stored display having multiple memory sections that can be displayed separately or simultaneously.

**Save.** A function that inhibits storage update, saving existing data in a section of a multiple memory (e.g., Save A).

**Scan Address.** A number representing each horizontal data position increment on a directed beam type display. An address in a memory is associated with each scan address.

**View (Display).** Enables viewing of contents of the chosen memory section (e.g., "View A" displays contents of memory A; "View B" displays the contents of memory B).



## **MANUAL CHANGE INFORMATION**

At Tektronix, we continually strive to keep up with latest electronic developments by adding circuit and component improvements to our instruments as soon as they are developed and tested.

Sometimes, due to printing and shipping requirements, we can't get these changes immediately into printed manuals. Hence, your manual may contain new change information on following pages.

A single change may affect several sections. Since the change information sheets are carried in the manual until all changes are permanently entered, some duplication may occur. If no such change pages appear following this page, your manual is correct as printed.

