

**528A
TELEVISION
WAVEFORM
MONITOR**

*Please Check for
CHANGE INFORMATION
at the Rear of This Manual*

Copyright © 1981 Tektronix, Inc. All rights reserved.
Contents of this publication may not be reproduced in
any form without the written permission of Tektronix, Inc.

Products of Tektronix, Inc. and its subsidiaries are
covered by U.S. and foreign patents and/or pending
patents.
TEKTRONIX, TEK, SCOPE-MOBILE, and  are
registered trademarks of Tektronix, Inc. TELEQUIP-
MENT is a registered trademark of Tektronix U.K.
Limited.

Printed in U.S.A. Specification and price change
privileges are reserved.

OPERATORS SAFETY SUMMARY

The general safety information in this part of the summary is for both operating and servicing personnel. Specific warnings and cautions will be found throughout the manual where they apply, but may not appear in this summary.

TERMS

In This Manual

CAUTION statements identify conditions or practices that could result in damage to the equipment or other property.

WARNING statements identify conditions or practices that could result in personal injury or loss of life.

As Marked on Equipment

CAUTION indicates a personal injury hazard not immediately accessible as one reads the marking, or a hazard to property including the equipment itself.

DANGER indicates a personal injury hazard immediately accessible as one reads the marking.

SYMBOLS

In This Manual



This symbol indicates where applicable cautionary or other information is to be found.

As Marked on Equipment



DANGER — High voltage.



Protective ground (earth) terminal.



ATTENTION — refer to manual.

Power Source

This product is intended to operate from a power module connected to a power source that will not apply more than 250 volts rms between the supply conductors or between either supply conductor and ground. A protective ground connection by way of the grounding conductor in the power cord is essential for safe operation.

Grounding the Product

This product is grounded through the grounding conductor of the power module power cord. To avoid electrical shock, plug the power cord into a properly wired receptacle before connecting to the product input or output terminals. A protective ground connection by way of the grounding conductor in the power module power cord is essential for safe operation.

Danger Arising From Loss of Ground

Upon loss of the protective-ground connection, all accessible conductive parts (including knobs and controls that may appear to be insulating) can render an electric shock.

Use the Proper Fuse

To avoid fire hazard, use only the fuse of correct type, voltage rating and current rating as specified in the parts list for your product.

Refer fuse replacement to qualified service personnel.

Do Not Operate in Explosive Atmospheres

To avoid explosion, do not operate this product in an explosive atmosphere unless it has been specifically certified for such operation.

Do Not Operate Without Covers

To avoid personal injury, do not operate this product without covers or panels installed. Do not apply power to the plug-in via a plug-in extender.

SERVICE SAFETY SUMMARY

FOR QUALIFIED SERVICE PERSONNEL ONLY

Refer also to the preceding Operators Safety Summary.

Do Not Service Alone

Do not perform internal service or adjustment of this product unless another person capable of rendering first aid and resuscitation is present.

Use Care When Servicing With Power On

Dangerous voltages may exist at several points in this product. To avoid personal injury, do not touch exposed connections and components while power is on.

Disconnect power before removing protective panels, soldering, or replacing components.

Power Source

This product is intended to operate from a power source that will not apply more than 250 volts rms between the supply conductors or between either supply conductor and ground. A protective ground connection by way of the grounding conductor in the power cord is essential for safe operation.

528A Television Waveform Monitor

3892-1

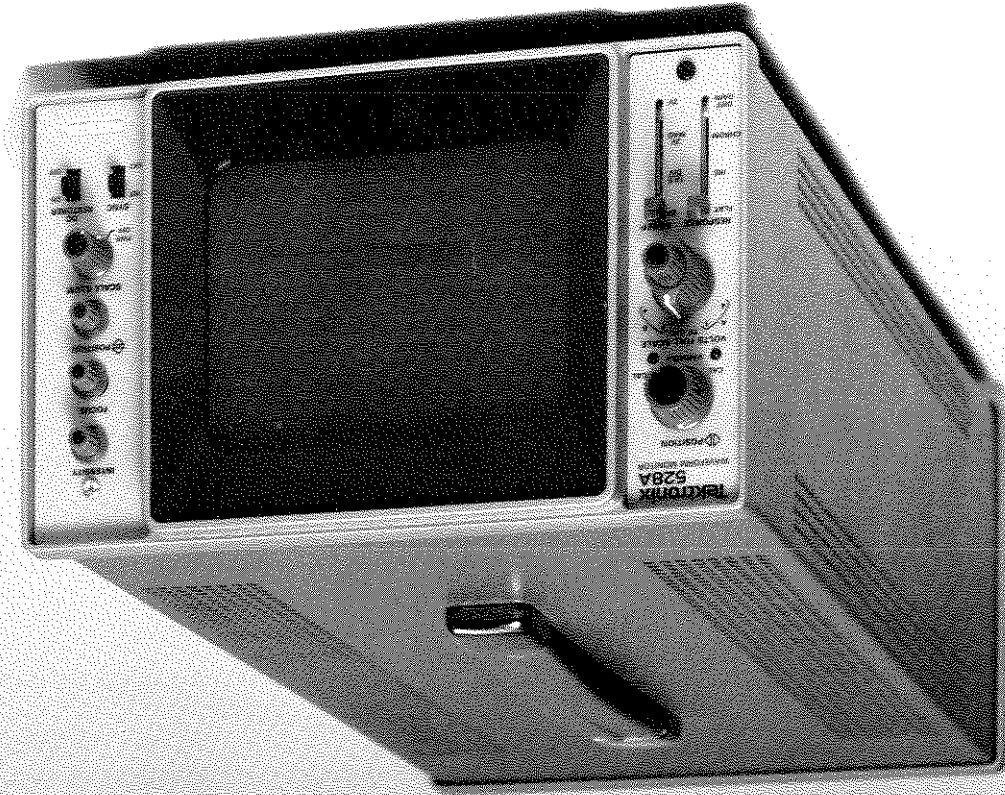

PART I

OPERATOR'S INFORMATION

SPECIFICATION

INTRODUCTION

The TEKTRONIX 528A solid-state Television Waveform Monitor is designed for use in displaying and monitoring waveforms from camera outputs, video system output lines, transmitter video input lines, closed-circuit TV systems, and educational TV systems utilizing 525 line, 30 frame (60 Hz field rate) scan. The instrument can be easily modified to work with 625 line, 25 frame (50 Hz field rate) scan. Low power consumption and 1/2 rack-width size without sacrifice in display area are featured.

The 528A provides bright, easy-to-read video waveform displays on a 5-inch crt, yet requires only 5-1/4 inches vertical height and 1/2 rack width mounting space. This permits mounting the 528A side-by-side with another 528A or other monitors, such as the TEKTRONIX 602 or 604A Display Units, etc. The 528A also features an internal, illuminated graticule.

Either of two loop-through 75 Ω inputs, selectable from the front panel, may be displayed. The displayed video signal is also provided at a video output connector (on the rear panel) for viewing on a picture monitor. Calibrated 1 volt and 4 volt full scale (140 IRE units) sensitivities are provided for displaying common video and sync signal levels. A VARIABLE (VOLTS FULL SCALE) control permits uncalibrated displays from 0.25 V to 4.0 V full scale. A built-in 1 V calibration signal may be switched on to check vertical sensitivity calibration.

FLAT, IRE, CHROMA, and DIFF GAIN frequency-response positions on the front-panel RESPONSE switch permit observation of various signal characteristics. A DC Restorer, which may be turned off when not required, maintains the back porch at an essentially constant level regardless of changes in signal amplitude, average picture level (APL), and color burst.

A horizontal SWEEP selector switch provides 2H (two line), 1 μ s/DIV (expanded two line), 2 V (two field), and 2 V MAG (expanded two field) displays. Displays of RGB and YRGB waveforms from color camera processing amplifiers are provided by interconnection through a rear-panel 9-pin receptacle.

A TEKTRONIX C-59P Camera is recommended for display photography with the 528A. The TEKTRONIX C-5C Opt. 01, C-28, or C-30BP Opt. 01 may also be used, with appropriate adapters.

SPECIFICATION

The performance requirements listed here apply over an ambient temperature range of 0°C to +50°C. The rated accuracies are valid when this instrument is calibrated at +20°C to +30°C, after a warm-up time of three minutes. (A twenty minute warm-up time is required for rated accuracies at 0°C ambient temperature.) Test equipment used in verifying performance requirements must be calibrated and working within the limits specified under the Equipment Required list.

Items listed in the Performance Requirements column of the Electrical Characteristics tables are verified by completing the Performance Check in Section 4 (Calibration) of this manual unless specifically stated otherwise. Items listed in the Supplemental Information column may not be verified in this manual; they are either explanatory notes or performance characteristics for which no limits are specified. The Perf. Ch. Step No. column identifies the individual steps in the Performance Check procedure that apply to each Performance Requirement item.

Table 1-1
ELECTRICAL CHARACTERISTICS
VERTICAL DEFLECTION SYSTEM

Perf. Ch. Step No.	Supplemental Information	Performance Requirement	Characteristics
19 & 19A		response at 50 kHz.	Frequency Response 1 V FULL SCALE or 4 V FULL SCALE FLAT
		3.6 MHz to 5 MHz, +1%, -3% of response at 50 kHz, and +1%, -3% of response at 3.58 MHz.	
20		Response per 1958 IRE STD 23 S-1 (Fig. 1-1). Attenuation at 4.43 MHz greater than 22 dB.	IRE
		-3 dB between 3.1 MHz and 3.4 MHz.	CHROMA NTSC
		4.1 MHz.	
		Response at 3.58 MHz does not vary between FLAT and CHROMA by more than 1%.	
		Attenuation at 7.2 MHz is greater than 25 dB.	
		-3 dB between 3.8 MHz and 4.1 MHz.	PAL
		4.23 MHz.	
		-3 dB between 4.59 MHz and 5.07 MHz.	
		Response at 4.43 MHz does not vary between FLAT and CHROMA by more than 1%.	
20		Frequency response requirements are the same as for CHROMA, except that gain is increased by 3 to 5.5 times.	DIFF GAIN

Table 1-1 (cont)

Characteristics	Performance Requirements	Supplemental Information	Perf. Ch. Step No.
Transient Response 1 V FULL SCALE FLAT (using 125 ns H.A.D. \sin^2 pulse and bar)			
Preshoot	1 IRE unit or less.		18
Pulse-to-Bar Ratio	0.99:1 to 1.01:1.		
Overshoot	2 IRE units or less.		
Ringing	2 IRE units or less.		
Tilt			
Field Rate Square Wave or Vertical Window	1% or less.		
25 μ s Pulse	1% or less.		
Differential Gain	When baseline is at 50 IRE and signal is adjusted to 100 IRE: Displayed differential gain is 1% or less with 20% — 90% APL changes.		21
Deflection Factor			
1 V FULL SCALE	140 IRE units within 1% with 1 V input.		11
4 V FULL SCALE	140 IRE units within 3% with 4 V input.		
VARIABLE (VOLTS FULL SCALE) Range			
1 V FULL SCALE	0.25 V or less to 1.0 V for 140 IRE unit display.		12
4 V FULL SCALE	1.0 V or less to 4.0 V for 140 IRE unit display.		
CAL - UNCAL Indicators			
VARIABLE in calibrated position	Green (CAL) LED must light.		13
VARIABLE in uncalibrated position	Red (UNCAL) LED must light.		
Maximum Input Level			
Ac Coupled			
1 V FULL SCALE		± 5 V dc.	
4 V FULL SCALE		± 5 V dc.	
Dc Coupled			
1 V FULL SCALE		Input signal must be with- in ± 1.1 V for on-screen positioning.	
4 V FULL SCALE		Input signal must be with- in ± 4.4 V for on-screen positioning.	

Table 1-1 (cont)

Perf. Ch. Step No.	Supplemental Information	Performance Requirements	Characteristics
			Maximum Amplitude FLAT and IRE
			CHROMA
			DIFF GAIN
25			Input Impedance (not terminated) 1 V FULL SCALE 4 V FULL SCALE
			Maximum Return Loss VIDEO INPUT (A & B terminated in 75 Ω, all deflection factor settings, inputs in use or not, instrument on or off)
17			VIDEO OUTPUT
			Frequency Response
			Differential Gain (50% APL)
			Differential Phase (50% APL)
			Dc Level on Output
19 & 19A			Output Signal Amplitude
			Output Impedance (nominal)
			or any VARIABLE setting
21		Within 2% with 140 IRE unit display.	Differential Gain (50% APL)
21		Within 3° with 140 IRE unit display.	Differential Phase (50% APL)
16	75 Ω.	2 V or less into 75 Ω load.	Output Impedance (nominal)
15		1 V within 15% for 140 IRE unit display with RESPONSE switch set to FLAT.	1 V FULL SCALE, 4 V FULL SCALE, or any VARIABLE setting

**Table 1-2
DC RESTORATION**

Characteristics	Performance Requirement	Supplemental Information	Perf. Ch. Step No.
Clamp Time	Back porch.		22
Low-Frequency Response at 60 Hz Attenuation of 60 Hz added to Input Signal	20% or less, DC RESTORER switch set from OFF to ON.		22
Blanking Level Shift due to Presence or Absence of Burst	1 IRE unit or less shift from no color burst to presence of color burst.		22
Blanking Level Shift with 10% to 90% APL Change	APL changes from 50% to either 10% or 90% will cause blanking level shift of 1 IRE unit or less.		22
Vertical POSITION Cw		Moves trace up.	14
Ccw		Moves trace down.	
POSITION Range, DC Coupled		+1.0 V dc can be positioned to +90 IRE line or below.	
		-1.0 V dc can be positioned to -30 IRE line or above.	

**Table 1-3
CALIBRATOR**

Characteristics	Performance Requirement	Supplemental Information	Perf. Ch. Step No.
Calibrator Frequency	At least 2 cycles will be displayed at 2H. Must synchronize 2H sweep.		1
Amplitude	1.0 V within 1%.	Adjustable with R575 (-15 V Adj. on Power Bd.), measured at TP400 (Main Bd.) when in 1 V CAL.	1
Position		Top of calibrator waveform must be between 50 IRE units and 100 IRE units on graticule when Back Porch of video signal is positioned to 0 IRE line, with DC RESTORER switch set to ON.	1

Table 1-4
HORIZONTAL DEFLECTION SYSTEM

Perf. Ch. Step No.	Supplemental Information	Performance Requirement	Characteristics
4		Visible at all settings of the SWEEP switch with no video or external sync inputs.	Sweep Base Line
9		Equal to frame rate of applied video or external sync.	2V Sweep Repetition Rate
7	Adjust to equal 2H sweep length with R258.	12.1 major div within 0.5 div.	Length (when sync'd to Video Signal)
8	EIA vertical blanking interval must be 8 to 12 div in width.	Approximately X20.	2V MAG Sweep Magnification
8	Some portion of vertical blanking interval is visible when 2V sweep is centered.		Mag Registration
9		Equal to half line-rate of applied video or external sync.	2H Sweep Repetition Rate
5		1 μ s/div within 3%, excluding first and last div.	1 μ s/DIV Sweep Accuracy
6		No more than 3% non-linearity throughout horizontal POSITION range, excluding first and last div.	Linearity
8	Some portion of horizontal blanking interval is visible when 2H sweep is centered.		Mag Registration
	Complete synchronized sweep can be displayed with horizontal POSITION in all SWEEP positions.		POSITION Range

Table 1-5
EXTERNAL SYNC

Characteristics	Performance Requirement	Supplemental Information	Perf. Ch. Step No.
Input Signal Requirements	1.5 V to 4.5 V composite sync will synchronize sweeps.		23
Input Impedance (Unterminated)		Approximately 15 k Ω paralleled by approximately 5 pF.	
Maximum Return Loss when Terminated in 75 Ω Loop-Through Connector	At least 46 dB from 25 Hz to 5 MHz.		17
Maximum Input Voltage		± 20 V.	

Table 1-6
RGB/YRGB

Perf. Ch.	Step No.	Characteristics	Performance Requirement	Supplemental Information
		RGB/YRGB		Factory wired for RGB (3 step) input. Connect a jumper between TP265 and TP266 for YRGB and operation.
	24	Staircase Amplitude RGB (3 step) YRGB (4 step)	10 V within 15% for 9 div displacement. 10 V within 15% for 9 div displacement.	
		Maximum Input Staircase		± 12 V (dc plus peak ac). p-p ac component: 12 V.
		Sweep Repetition Rate in RGB/YRGB 2V 2H	Field rate of applied video or external sync signal. Line rate of applied video or external sync signal.	
	24	Sweep Length RGB (3 step) YRGB (4 step)	27% to 33% of normal sweep (2V or 2H). 20% to 25% of normal sweep (2V or 2H).	
	24	Staircase Transient Response	Designed for either line or field rate commutation of input.	Check for less than 2% overshoot.
		Overshoot or Tilt		
		Control Signal (External Power)	12 V to 15 V between pin 4 (pos) and pin 5 (neg), 5 V between pin 8 (pos) and pin 5 (neg) of J370.	
	24	Control Signal (Internal Power)	For -15 V operation, jumper pin 5 to pin 6 on J370. Ground pin 4 to actuate RGB/YRGB circuit.	
	a		For +5 V operation, jumper TP373 and TP374 (rear of Main circuit board. Ground pin 5 on J370 to actuate RGB/YRGB circuit.	
	a	Control Circuit Internal Resistance (25°C)	12 V — 15 V operation: 260 Ω within 20%. 5 V operation: 520 Ω within 20%	

**Table 1-7
CRT DISPLAY**

Characteristics	Performance Requirement	Supplemental Information	Perf. Ch Step No.
Crt Viewing Area		8 x 10 cm. (Horizontal, 12.5 div; Vertical, 170 IRE units.)	
Configuration		Flat-faced 5-inch rectangular.	
Graticule		Internal, variable illumination.	
Accelerating Potential		Approximately 4 kV.	
Trace Rotation Range		6° total range. Turning control cw rotates trace ccw.	

**Table 1-8
POWER SUPPLIES**

Characteristics	Performance Requirement	Supplemental Information	Perf. Ch. Step No.
Accuracy			2
-15 V		Within 2%.	
+10 V		Within 5%.	
+100 V		Within 5%.	
+300 V		Within 5%.	
-3850 V		Within 5%.	
Ripple			
-15 V		10 mV or less.	
+10 V		20 mV or less in 2H mode.	
+100 V		20 mV or less in 2H mode.	
+300 V		2 V or less.	

Table 1-9
POWER SOURCE

Characteristics		Performance Requirement		Supplemental Information	
Line Voltage Ranges	99 V ac to 132 V ac.	Minimum crest factor, 1.3.	2	a	
	198 V ac to 250 V ac.				
Line Frequency Ranges	48 Hz to 66 Hz.			a	
	From 66 Hz to 440 Hz - Line Voltage Ranges are: 115 V ac \pm 10%. 230 V ac \pm 10%.				
Power Consumption at 115 V ac, 60 Hz		Approximately 48 watts.			
Maximum Power Consumption	60 watts			a	

^a Not checked in Performance Check.

Table 1-10
PHYSICAL CHARACTERISTICS

Characteristics		Information	
Finish	0.010-inch sheet polycarbonate front panel; vinyl-painted cabinet.		
Dimensions	5 1/4 in. high, 8 1/2 in. wide, and 18 1/2 in. long.		
Weight	Approximately 15 lbs.		

Table 1-11
ENVIRONMENTAL CHARACTERISTICS

Characteristics		Information	
Temperature	Non-operating	-40°C to +65°C.	
	Operating	0°C to +50°C.	
Altitude	Non-operating	To 50,000 feet.	
	Operating	To 15,000 feet.	
Vibration	Operating	15 minutes each axis at 0.015 in., frequency varied from 10-50-10 c/s in 1-minute cycles with instrument secured to vibration platform. Three minutes each axis at any resonant point or at 50 c/s.	
	Non-operating	30 g's, 1/2 sine, 11 ms duration, 2 guillotine-type shocks per axis.	
Shock	Non-operating		Transportation
			Qualified under NTS-C test procedure 1A, Category II (24" drop).

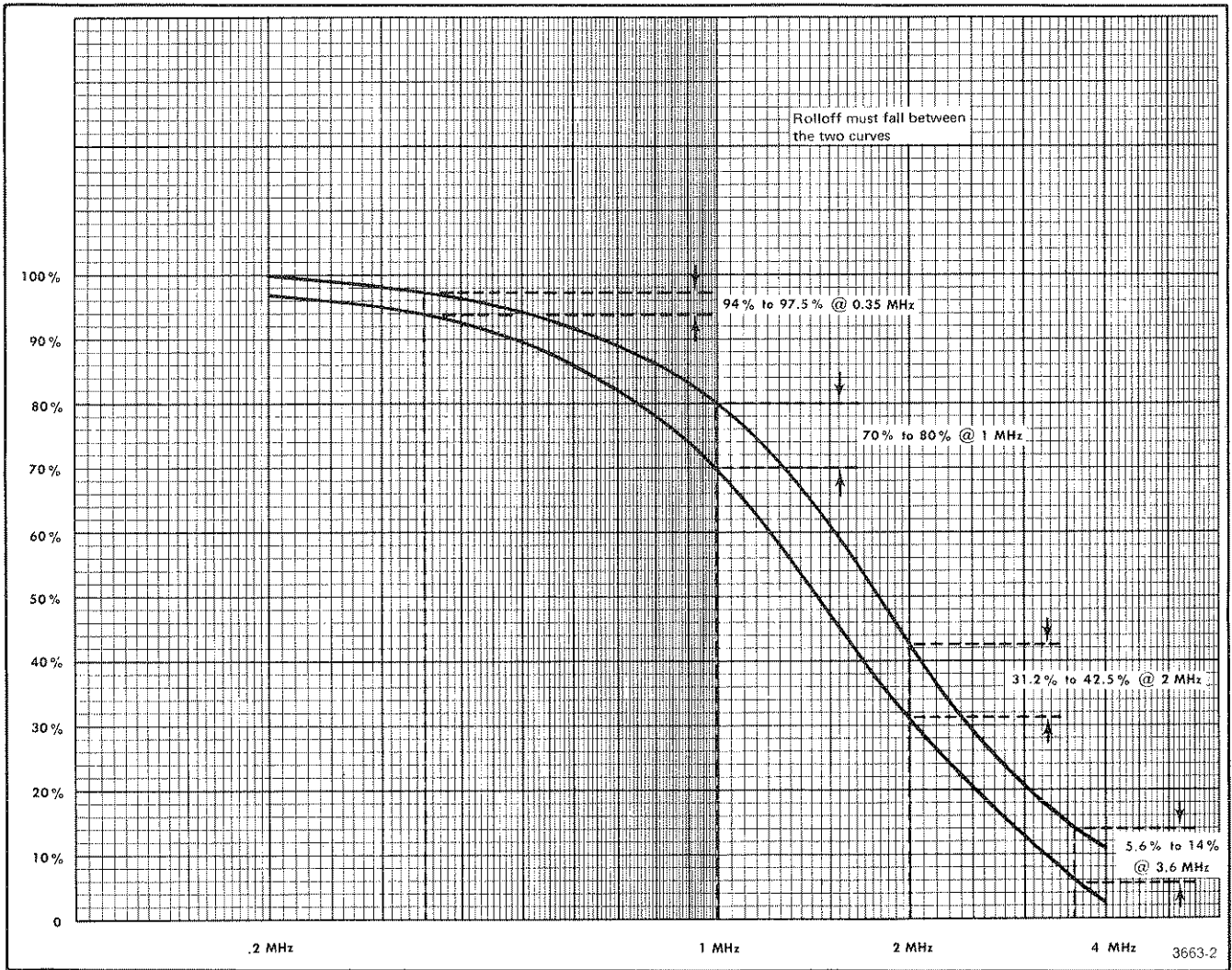

Fig. 1-1. IRE 1958 standard 23S-1.

OPERATING INSTRUCTIONS

INTRODUCTION

This section of the manual will help familiarize the user with the 528A Television Waveform Monitor. Included in this section is an explanation of the front-and rear-panel controls and connectors, and an Operator's Checkout Procedure that provides "hands-on" familiarization and a check of basic instrument operation.

CONTROLS, CONNECTORS, and INDICATORS

Introduction

The following describes the functions or operations of the various controls, connectors, and indicators found on the front-and rear-panel of the 528A Television Waveform Monitor (see Fig. 2-1).

Front-Panel Controls and Indicators

- ① **POSITION (Horizontal Control):** A ten-turn control to position the display horizontally on the viewing screen. This has sufficient range to display any portion of the display at any setting of the SWEEP switch.
- ② **CAL and UNCAL Indicators:** CAL LED (green) indicates when the VARIABLE (VOLTS FULL SCALE) control is set to the calibrated detent position (fully counterclockwise). UNCAL LED (red) indicates that the VARIABLE (VOLTS FULL SCALE) control is not in the calibrated position. The indicators also function as a pilot light to indicate when power is applied and the instrument is on.
- ③ **VOLTS FULL SCALE Switch:** Five-position rotary switch that allows the user to select signal information to be displayed from either the rear-panel VIDEO INPUT A or VIDEO INPUT B connectors, at a deflection factor of either 1 V (full scale) or 4 V (full scale). The center position selects the internal 1 V CAL (1 volt) calibrator signal for checking calibration of the vertical deflection factor.
- ④ **VARIABLE (VOLTS FULL SCALE) Control:** Continuously variable control with a minimum range of 1 to 4 to permit variable adjustment of gain (deflection factor) for each VOLTS FULL SCALE switch position. Used in conjunction with the VOLTS FULL SCALE switch to accommodate input signals from 0.25 V to 4 V.
- ⑤ **RESPONSE switch:** Four-position lever switch selects either FLAT, IRE, or CHROMA frequency response characteristics.

A fourth position, DIFF GAIN, provides the same frequency response characteristics as the CHROMA position, but with an additional gain of 3 to 5.5 times.
- ⑥ **SWEEP Switch:** Four-position lever switch selects 2H, 1 μ s/DIV, 2V MAG, or 2V sweep rate.

2H: Sweep repetition rate is half line rate to display two television lines.

1 μ s/DIV: Expands the two-line display to provide 10 times magnification of the horizontal blanking interval or any other portion of the two-line display.

2V MAG: Expands the two-field display (2V) to provide 20 times magnification of the vertical blanking interval or any other portion of the two-field display.

2V: Sweep repetition rate is half field rate to display two television fields (one frame).
- ⑦ **INTENSITY Control:** Controls brightness of the display.
- ⑧ **FOCUS Control:** Permits adjustment of the crt beam for optimum definition.
- ⑨ **POSITION (Vertical Control):** Vertically positions the display on the viewing screen.

Fig. 2-1. Front- and rear-panel views of the 528A, showing controls, lights, adjustments, and connectors.

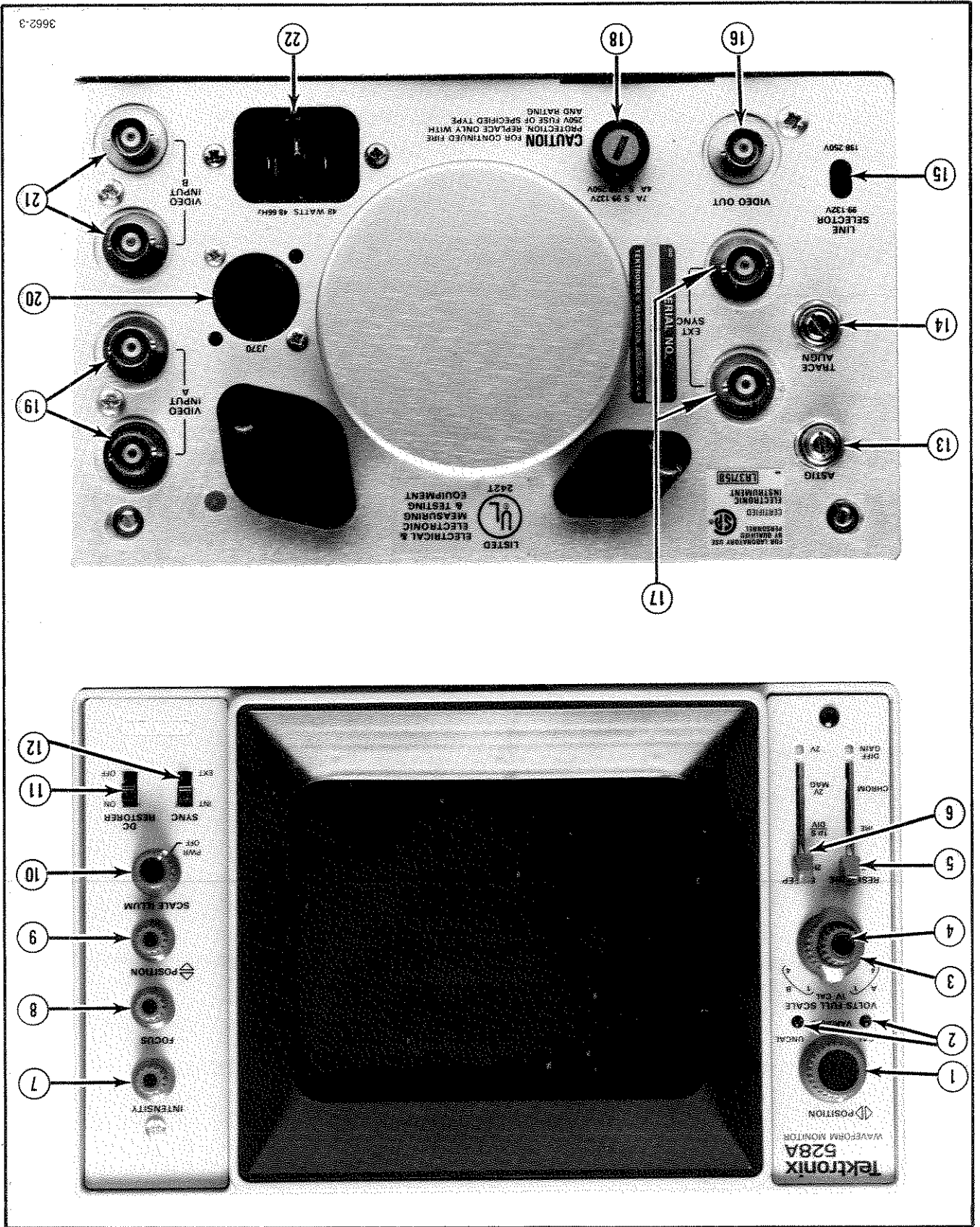

- ⑩ **PWR-SCALE ILLUM Control:** PWR (POWER) switch turns the instrument on or off.

SCALE ILLUM: control sets the light level of the internal graticule markings.

- ⑪ **DC RESTORER Switch:** Two-position slide switch to turn the DC RESTORER ON or OFF.

- ⑫ **SYNC Switch:** Two-position slide switch to select either INT (internal) or EXT (external) sync source.

Rear-Panel Controls and Connectors

- ⑬ **ASTIGMATISM Adjustment:** Screwdriver adjustment permits adjustment of the crt beam for optimum definition.

- ⑭ **TRACE ALIGN Adjustment:** Screwdriver adjustment to align the trace or the display with the horizontal graticule lines.

- ⑮ **LINE VOLTS Switch:** Two-position slide switch for selecting a line-voltage range of either 99-132 V or 198-250 V.

CAUTION

Check for correct setting of the LINE VOLTS switch before applying power to avoid damaging the instrument.

- ⑯ **VIDEO OUT Connector:** Bnc connector for monitoring the displayed signal on a picture monitor. Output amplitude is approximately 1 volt when the 528A display is 140 IRE units. Output impedance is 75 Ω . External connections from the output should be terminated in 75 Ω .

- ⑰ **EXT SYNC Connectors:** Bnc connectors for accepting external sync signals. Input requirements are 1.5 V to 4.5 V composite sync for stable sweep synchronization. The inputs are loop-through and compensated for 75 Ω , so that the instrument may be connected into any part of a properly terminated 75 Ω system.

When an EXT SYNC connector is connected to the output of a system where loop-through connections are not required, a 75 Ω termination

should be connected to the unused input connector to properly terminate the system.

- ⑱ **Fuse Holder:** Holds the ac-line fuse that provides over-current protection for the instrument. Check that the proper fuse is installed for the center line voltage that is selected before applying power.

CAUTION

Disconnect the ac power cord before checking or replacing the line fuse.

- ⑲ **VIDEO INPUT A Connectors:** Bnc connectors for applying an external video signal to VIDEO INPUT A. The inputs are high impedance loop-through, compensated for 75 Ω , not internally terminated. Input amplitude for full scale deflection may be from 0.25 V or less to 4.0 V, depending on the settings of the VOLTS FULL SCALE switch and VARIABLE (VOLTS FULL SCALE) control.

When a VIDEO INPUT A connector is connected to the output of a system where loop-through connections are not required, a 75 Ω termination should be connected to the unused input connector to properly terminate the system.

- ⑳ **J370 RGB/YRGB connector:** Nine-pin socket for accepting an external staircase and control signals. Staircase input signal requirement is approximately 10 V for a 9-division displacement. See Section 3 Installation and Section 1 Specification in this manual for other details.

- ㉑ **VIDEO INPUT B Connectors:** Bnc connectors for applying an external video signal to VIDEO INPUT B. See 19 VIDEO INPUT A Connectors for details.

- ㉒ **International-Type Connector Receptacle:** 3-terminal connector to receive the ac power cord.

OPERATOR'S CHECKOUT PROCEDURE

The following procedure is provided as an aid in obtaining a display on the 528A, and may be used for operator familiarization and as a check of basic instrument operation.

Only instrument functions, not measurement quantities or specifications, are checked in this procedure. Therefore, a minimum amount of test equipment is required. All checks are made with the cabinet on.

If performing the Operator's Checkout Procedure reveals improper operation or instrument malfunction, first check the operation of associated equipment. Then, refer to qualified service personnel for repair or adjustment of the instrument.

When a complete check of the instrument performance to specification is desired, refer qualified service personnel to the Performance Check in Section 4 of this manual.

This procedure requires a source of composite video and composite sync signals. A TEKTRONIX 1410 Television Test Signal Generator mainframe equipped with an SPG1 Sync Generator, a TSG1 Color Bars Generator, and a TSG3 Linearity Generator modules was used in preparing this procedure.

1. Setup

Video Signal Generator

- Test Signals
 - 1 V Modulated Staircase
 - (Flat Field, 10 Step)
 - 1 V EIA Standard Color Bars
 - 4 V Composite Sync

528A

- | | | |
|----------------------|-----------------------|-----------------|
| Front-Panel Controls | POSITION (Horizontal) | Midrange |
| | VOLTS FULL SCALE | A 1 |
| | VARIABLE (VOLTS) | |
| | FULL SCALE) | |
| | RESPONSE | FLAT |
| | SWEEP | 2H |
| | PWR-SCALE ILLUM | OFF (fully ccw) |
| | INTENSITY | Fully ccw |
| | FOCUS | As is |
| | POSITION (Vertical) | Midrange |
| | DC RESTORER | ON |
| Rear-Panel Controls | ASTIGMATISM | As is |
| | TRACE ALIGN | As is |

2. Check that the LINE VOLTS switch on the rear panel is set to the proper line-voltage operating range.

3. Connect the instrument to a suitable ac power source and turn on the PWR-SCALE ILLUM control. Set the SCALE ILLUM control to the desired graticule illumination.

4. Allow the instrument to warm up at least 3 minutes.

5. Rotate the INTENSITY control clockwise until the trace is at the desired brightness.

6. Use the vertical POSITION control to position the trace to the 0 IRE graticule line. Use the horizontal POSITION control to position the start (left end) of the trace to the first major division mark on the 0 IRE graticule line.

7. Adjust the FOCUS control to obtain a well-defined trace.

8. Check that the trace aligns with the 0 IRE graticule line. If not, adjust the TRACE ALIGN control on the rear panel to obtain proper alignment.

9. Set the VOLTS FULL SCALE switch to the 1 V CAL position. With the vertical POSITION control, center the display in the -40 to 100 IRE unit area of the graticule. Adjust the ASTIGMATISM (rear panel) and FOCUS controls to obtain a well-defined waveform. The calibrator waveform should be 140 IRE units (within 1.4 units) in amplitude (see Fig. 2-2).

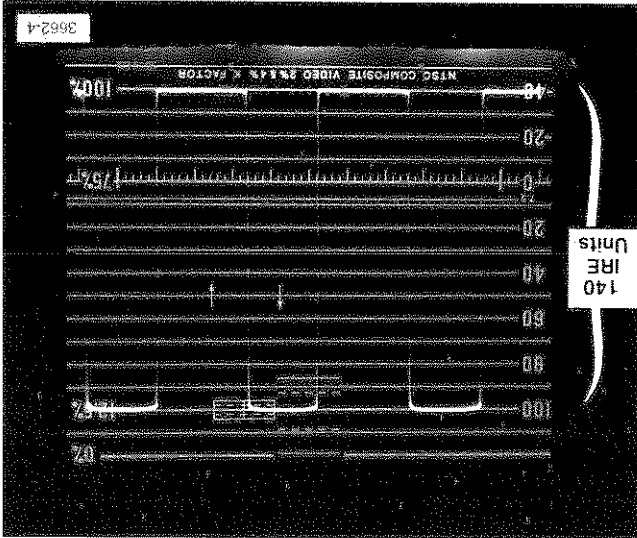

Fig. 2-2. Typical calibrator waveform display obtained when the VOLTS FULL SCALE switch is set to 1 V CAL, the VARIABLE (VOLTS FULL SCALE) control is set to CAL, RESPONSE is set to FLAT, SWEEP is set to 2H, and the display is properly focused.

10. Connect a 1-volt modulated staircase signal to the VIDEO INPUT A connector. Connect a $75\ \Omega$ termination to the other unused VIDEO INPUT A connector.

11. Connect a color bars signal (EIA Standard Color Bars with 75% amplitude and 7.5% setup) to the VIDEO INPUT B connector. Connect a $75\ \Omega$ termination to the other unused VIDEO INPUT B connector.

12. Set the VOLTS FULL SCALE switch to A 1. Use the vertical POSITION control to align the blanking level of the waveform with the 0 IRE graticule line. A modulated staircase waveform similar to the one shown in Fig. 2-3 should be displayed. The FLAT position of the RESPONSE switch provides a flat frequency response from 25 Hz to approximately 5 MHz.

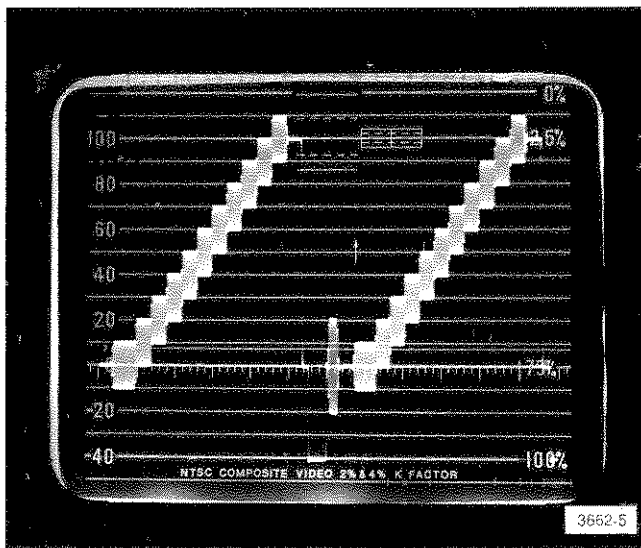

Fig. 2-3. Displays of a 10-step modulated staircase signal with the RESPONSE switch set to FLAT and the SWEEP switch set to 2H.

13. Set the RESPONSE switch to IRE. This position of the switch provides a frequency response with a rolloff per 1958 IRE STD 23 S-1 as illustrated in Fig. 1-1 (refer to Section 1 Specification in this manual). Figure 2-4 shows the waveform monitor display with this response.

14. Set the RESPONSE switch to CHROMA. A chrominance waveform similar to the one shown in Fig. 2-5 should be displayed. In this position of the switch, only the components of the signal within the 3.2 MHz to 4.0 MHz frequency range are displayed, with no luminance components.

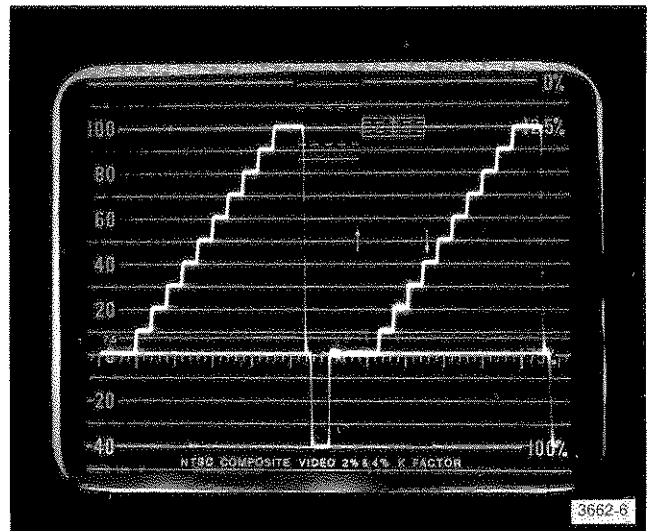

Fig. 2-4. Display of a 10-step modulated staircase signal with the RESPONSE switch set to IRE and the SWEEP switch set to 2H. Note the absence of chrominance components.

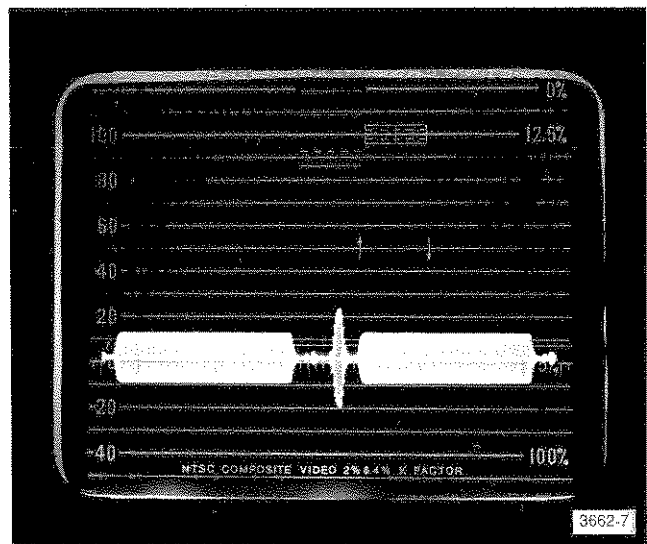

Fig. 2-5. Display of a 10-step modulated staircase signal with the RESPONSE switch set to CHROMA and the SWEEP switch set to 2H. Note absence of luminance components.

15. Set the RESPONSE switch to DIFF GAIN. The display should be similar to the one shown in Fig. 2-5, except the amplitude of the DIFF GAIN display will be 3 to 5.5 times greater.

The DIFF GAIN switch position is used when checking equipment for differential gain, using a test signal such as a modulated staircase or ramp. To perform this check, a suggested procedure is as follows:

17. Set the SWEEP switch to 2V. A two-field display similar to the one shown in Fig. 2-9 should be obtained.

shown in Fig. 2-8.

16. Set the VARIABLE (VOLTS FULL SCALE) control as necessary for best viewing. A typical display is shown in Fig. 2-8.

For example, Fig. 2-7 illustrates a waveform containing 10% differential gain, that is, there is a total variation of 10 IRE units with respect to the 100 IRE unit reference amplitude. For this illustration, the POSITION controls were used to move the waveform to a location where the graticule lines can be utilized for the differential gain measurement.

Fig. 2-6. Display of a 10-step modulated staircase signal with the RESPONSE switch set to DIFF GAIN, the SWEEP switch set to 2H, and the VARIABLE (VOLTS FULL SCALE) control set for exactly 100 IRE units. Note absence of luminance.

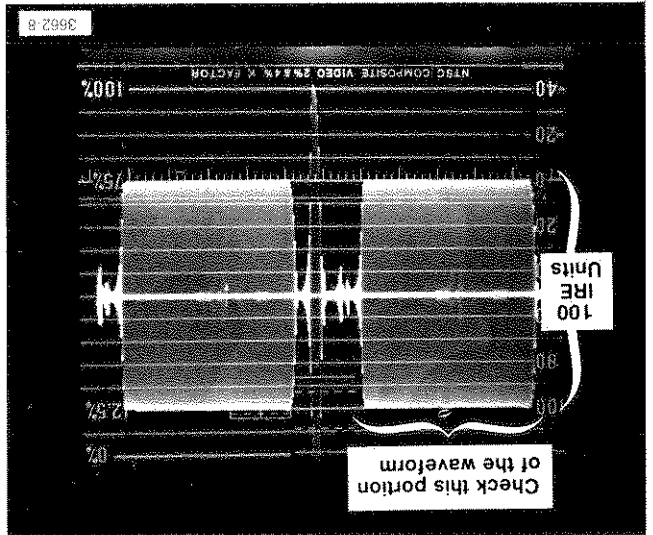

a. Adjust the VARIABLE (VOLTS FULL SCALE) control until the display is exactly 100 IRE units peak-to-peak in amplitude. Use the vertical POSITION control to center the display about the 50 IRE unit graticule line. Figure 2-6 shows the display to be obtained.

b. Check the waveform for uniform amplitude. The departure of any portion of the staircase modulation from the 100 IRE units of amplitude chosen as a reference represents differential gain. Each IRE unit variation represents 1% differential gain.

19. Set the VOLTS FULL SCALE switch to A 4 and the SWEEP switch to 2V. Note that the vertical amplitude of the display is one-fourth of the display amplitude obtained in step 15. (One-fourth amplitude is 35 IRE units peak-to-peak.

18. Set the SWEEP switch to 2V MAG. A magnified display of the vertical blanking interval should be obtained. Set the POSITION controls as necessary for best viewing. A typical display is shown in Fig. 2-10.

Fig. 2-8. Display of a 10-step modulated staircase signal with the RESPONSE switch set to FLAT and the SWEEP switch set to 1 μ s/DIV.

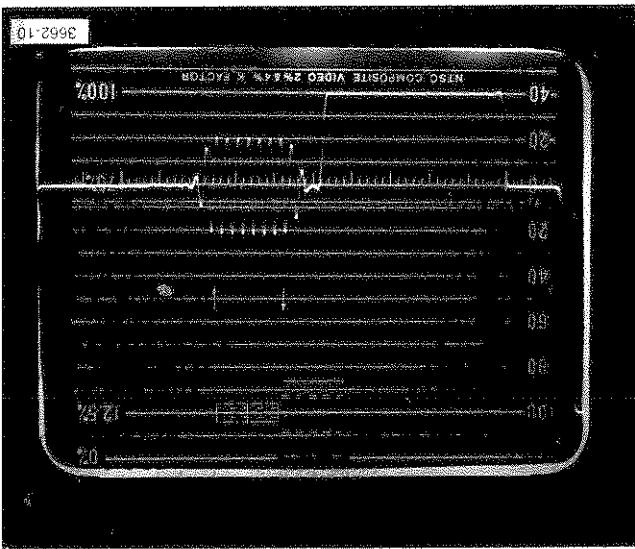
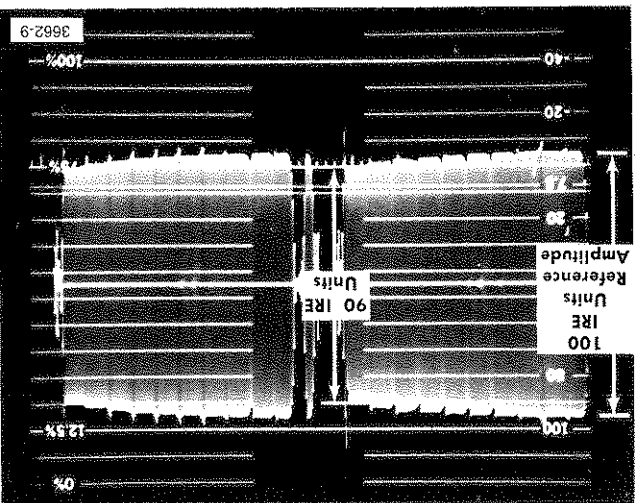

Fig. 2-7. Display of a 10-step modulated staircase signal with the RESPONSE switch set to DIFF GAIN. This waveform illustrates the presence of approximately 10% differential gain.



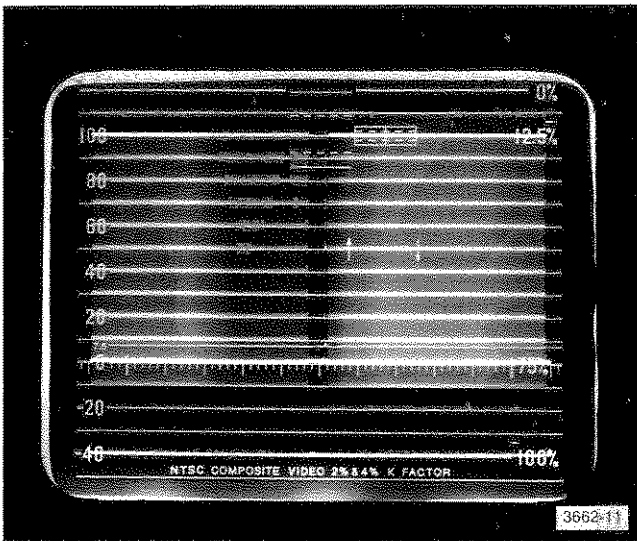

Fig. 2-9. Display of a 10-step modulated staircase signal with the RESPONSE switch set to FLAT and the SWEEP switch set to 2 V.

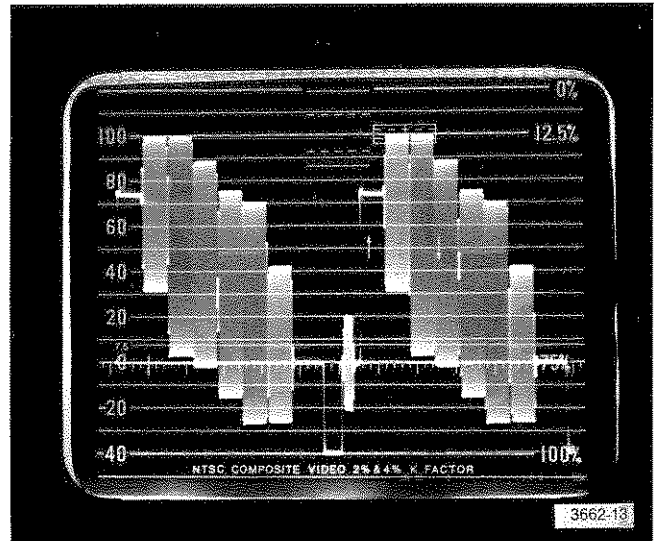

Fig. 2-11. Typical display of a color bars signal. The RESPONSE switch is set to FLAT and the SWEEP switch is set to 2H.

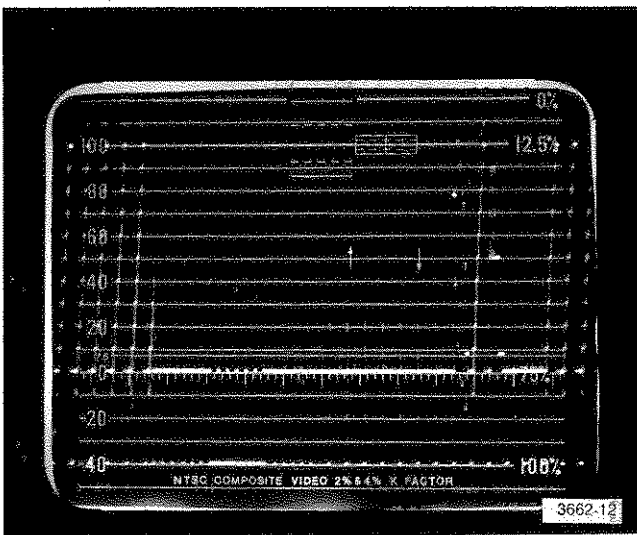

Fig. 2-10. Display of a 10-step modulated staircase signal with the RESPONSE switch set to FLAT and the SWEEP switch set to 2 V MAG.

The A 4 (and B 4) positions of the VOLTS FULL SCALE switch are primarily used to observe composite sync signals that are 4 volts in amplitude, but these switch positions may also be used in conjunction with the VARIABLE (VOLTS FULL SCALE) control to observe composite video signals with amplitudes between 1 and 4 volts.

20. Set the VOLTS FULL SCALE switch to B 1, and the SWEEP switch to 2H. A color bars display similar to the one shown in Fig. 2-11 should be obtained.

21. Set the SWEEP switch to 2V MAG. Use the horizontal POSITION control to scan across one entire field. If a standard EIA color bars signal is coupled to VIDEO INPUT B (such as is provided by the TSG1 Color Bars Generator), note that the first 75% of the field consists of color bars, and the remaining 25% of the field consists of -I, W, Q, B signals, similar to that shown in Fig. 2-12.

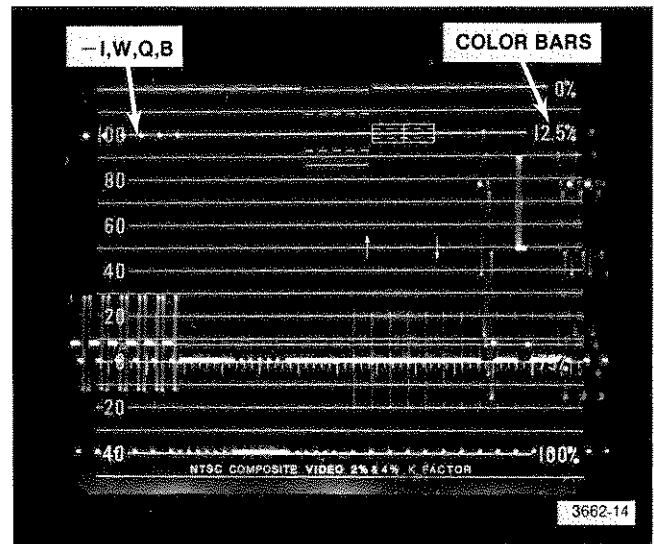

Fig. 2-12. Display obtained of the color bars signal and the -I, W, Q, B signal of the EIA Standard Color Bars signal, with the SWEEP switch set to 2 V MAG, the RESPONSE set to FLAT, and the horizontal POSITION control set to center the switching point.

22. Set the 528A SYNC switch to EXT. Note that synchronization of the display has been lost.

23. Connect a 4-volt composite sync signal from the same signal source as the color bars generator (for example, the Comp Sync output on the front panel of the SPG1 Sync Generator) to the 528A EXT SYNC connector. Terminate the other unused EXT SYNC connector with a 75 Ω termination.

24. Note that the display remains synchronized with the SYNC switch in either EXT or INT positions. Set the SYNC switch to INT.

25. Disconnect the standard EIA color bars signal from the 528A VIDEO INPUT B connector. Disconnect the 4-volt composite sync signal from the EXT SYNC connector, and connect it to the VIDEO INPUT B connector. Leave the 75 Ω termination on the other unused VIDEO INPUT B connector.

26. Set the SWEEP switch to 2H, and the VOLTS FULL SCALE switch to B4. Note that the 4 V composite sync signal gives full scale deflection within approximately 5%.

27. With the VARIABLE (VOLTS FULL SCALE) control set fully counter-clockwise, note that the CAL indicator (LED) is illuminated. Then, turn the VARIABLE (VOLTS FULL SCALE) control slowly clockwise and note that the UNCAL LED lights and the display increases in amplitude.

This completes the Operator's Checkout Procedure. All indicators, controls, and connectors, except the DC RESTORER switch, the VIDEO OUT connector, and J370 (RGB/YRGB input connector) have been functionally checked.

The DC RESTORER switch, the VIDEO OUT connector, and J370 connector require more extensive test equipment for checking. These are checked during the Performance Check in Section 4 of this manual. A brief description of these items follows:

DC RESTORER

DC restoration to the displayed composite video signals is provided when the front-panel DC RESTORER switch is set to ON. Clamp time for dc restoration is the back porch of the input composite video signal. The OFF position of the DC RESTORER switch is useful when viewing signals containing a significant dc level (the input to the first stage in the 528A vertical amplifier is ac coupled).

VIDEO OUT Connector

The VIDEO OUT connector is provided to drive other associated equipment, such as a picture monitor. With a full-scale display on the 528A, the amplitude of the output signal is 1 volt \pm 15% with the VOLTS FULL SCALE switch set to either 1 V FULL SCALE or 4 V FULL SCALE, and at any setting of the VARIABLE (VOLTS FULL SCALE) control. The RESPONSE switch should be set to FLAT, and the VIDEO OUT connector should be connected to a properly-terminated system. Output impedance is 75 Ω .

J370 (RGB/YRGB input) Connector

J370, a 9-pin socket connector on the rear panel of the 528A, provides a means of connecting an external staircase signal and control voltages for RGB or YRGB operation. A signal amplitude of 10 V will provide approximately 9 divisions of horizontal beam displacement. An external control voltage of either 12 V to 15 V, or 5 V may be applied to switch the horizontal circuitry of the 528A to RGB/YRGB operation. Internal supplies of -15 V and 5 V may also be used for the control voltage. Details for plug connections and internal jumper arrangements are provided in Section 3 and installation in this manual.

GRATICULES

Internal Graticules

Two basic patterns are provided as internal graticules for the 528A Waveform Monitor. They are the 525 line/60 Hz NTSC Composite Video graticule, shown in Fig. 2-13A, and the 625 line/50 Hz CIR graticule for PAL systems, shown in Fig. 2-13B.

The internal graticules are on the same plane as the crt phosphor, thus eliminating parallax errors for viewing and photographing of displays. Both graticules are illuminated, with brightness of the scales adjustable by a front-panel SCALE ILLUM control.

NTSC Composite Video Graticule

The NTSC graticule has two main vertical scales to facilitate typical measurements. The left-side scale is marked in IRE units, extending from -50 to +120 IRE units in 10 IRE increments. A line at 7.5 IRE units is provided for use as a black level setup reference. In addition, a boxed area scaled in \pm 2% and \pm 4% increments is strategically located for rapid, precise bar tilt measurements in conjunction with a \sin^2 pulse and bar signal.

The right-hand scale, for measuring transmitter % of modulation, extends from 0%, at the +120 IRE unit line, to 100%, at the -40 IRE unit line.

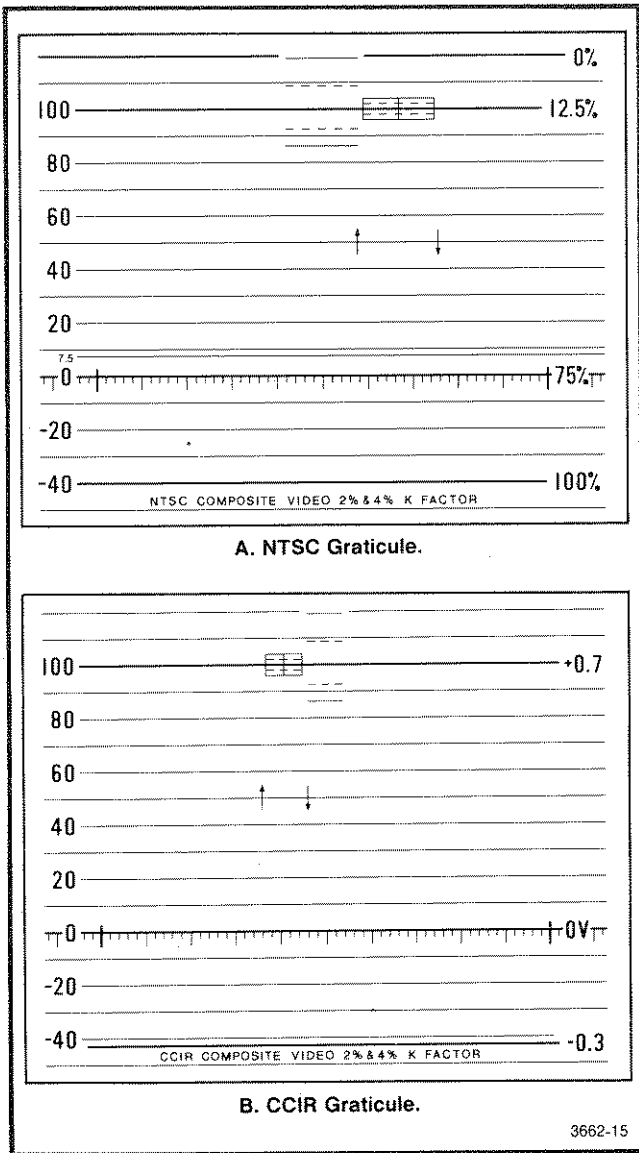

Fig. 2-13. Internal NTSC graticule for the 528A.

To the left of the boxed area, short dashed and solid lines are placed for convenient measurement of pulse amplitudes including K-factor tolerances.

To use the vertical scale in measuring line time distortion (L.D.), position the leading edge of the composite test signal bar (sine² pulse and 18 μs bar signal) to the ascending arrow (located just to the right of horizontal center). Set the blanking level on the 0 IRE line. If insertion gain is off, set the VARIABLE (VOLTS FULL SCALE) control so that the bar top passes through 100 IRE at its midpoint within the small boxed area. The trailing edge of the bar should fall on the descending arrow.

To measure line time distortion, check the largest deviation of the bar top (tilt or rounding) within the box. This box ignores the first and last 1 μs of the bar, where short time distortions may be observed. The box provides 2% (dashed lines) and 4% (solid lines) L.D. (line time distortion) scales.

For signals with a bar width other than 18 μs (for example, 25 μs), accurate line time distortion measurements can also be made by a slight modification in the procedure, as follows:

Set the blanking level on the 0 IRE line. If insertion gain is not correct, set the VARIABLE (VOLTS FULL SCALE) control so that the bar top passes through the 100 IRE line. At the midpoint of the bar signal (i.e., 12.5 μs after the rise, in our example). Set the leading edge of the bar on the ascending arrow, and check the largest deviation of the bar top within the box. Then, position the trailing edge of the bar to the descending arrow, and check the largest deviation of the bar top within the box.

Television organizations sometimes use and are familiar with (2T) pulse-to-bar amplitude ratio measurements. The short dashed and solid lines to the left of the boxed area facilitate this measurement. These lines are scaled per the factors:

$$\frac{1}{(1-4K)} \% \text{ and } \frac{1}{(1+4K)} \%$$

as described in CCIR STD Vol. V 1966, Page 104, relating pulse peak amplitude versus K factor.

To measure K_{pb} , set the 18 μs bar on the rising and falling arrows as in measuring line time distortion, adjusting the VARIABLE (VOLTS FULL SCALE) control so that the bar top passes through 100 IRE at its midpoint. Then, set the horizontal POSITION control so that the pulse peak is located in the special scaled area.

NTSC and CCIR Graticules

Horizontal Scale. The horizontal reference line at 0 IRE (NTSC) or 0 V (CCIR) is 12.7 divisions long. With the SWEEP switch set to 2H, the time base line (display) is two television lines in length. At 2V, the line duration is two television fields. When the SWEEP switch is set to 1 μs/DIV, each major division represents 1 μs, and serves as a convenient time calibration check.

CCIR Graticule

Vertical Scales. The CCIR graticule has two main vertical scales to facilitate typical measurements. The left-side scale is marked in percentage of picture level, as described in EBU Tech. 3221-E 1978, Page 12, extending from -50% to +120% in 10% increments (on this scale, tip of sync occurs at approximately -43%). The base lines at 0% and +100% are scribed heavier than other lines for easy reference.

The boxed area is scaled in 2% and 4% increments vertically, and the box width is 8 μ s. The rising and falling arrows are spaced 10 μ s apart, and centered to each side of the boxed area. The box ignores the first and last 1 μ s of the bar, where short time distortions may be observed. Measurements of line time distortion using the arrows and boxed area are performed in the same manner as described for the NTSC graticule.

The short dashed and solid lines in the upper center area of the graticule are scaled in the same manner as the NTSC graticule, for measurements relating pulse peak amplitude versus k factor.

The right-hand scale is marked in volts, extending from -0.3 V (tip of sync) to +0.7 V. The line at -0.3 V is heavier than other lines for easy reference to tip of sync level.

Modifications

Some operating functions of the 528A can be easily modified to meet certain application areas. A brief description of the more common modifications follows:

1. Dc Coupling of the Vertical Amplifier

- Option 01. Standard 525/60 instrument, without cover.
- Option 02. Standard 525/60 instrument for portable use, with a blue-vinyl aluminum field case equipped with a carrying handle and rubber feet.
- Option 03. 528A modified for use with 625/50 standards, with CCIR graticule.

Options

There are three options currently available for the 528A. They are briefly described here, and in more detail in Section 7 instrument Options in this manual.

3. Eliminating Crt Blanking for RGB/YRGB Modes

In order to observe the entire RGB/YRGB display, including retrace, the blanking circuitry must be disabled. This is accomplished by the addition of a wire strap. See Section 3 installation for details.

Section 3 installation in this manual includes details for changing to YRGB mode. The change requires only the addition of a jumper wire.

2. Changing from 3-Step RGB Mode to 4-Step YRGB Mode

The 528A can easily be changed to provide dc-coupled operation of the vertical amplifier, making the instrument useful for some applications that would normally require a dc-coupled test oscilloscope. Section 3 installation in this manual includes details for making the change.



WARNING

THE FOLLOWING SERVICING INSTRUCTIONS ARE FOR USE BY QUALIFIED PERSONNEL ONLY. TO AVOID PERSONAL INJURY, DO NOT PERFORM ANY SERVICING OTHER THAN THAT CONTAINED IN OPERATING INSTRUCTIONS UNLESS YOU ARE QUALIFIED TO DO SO. REFER TO OPERATORS SAFETY SUMMARY AND SERVICE SAFETY SUMMARY PRIOR TO PERFORMING ANY SERVICE.



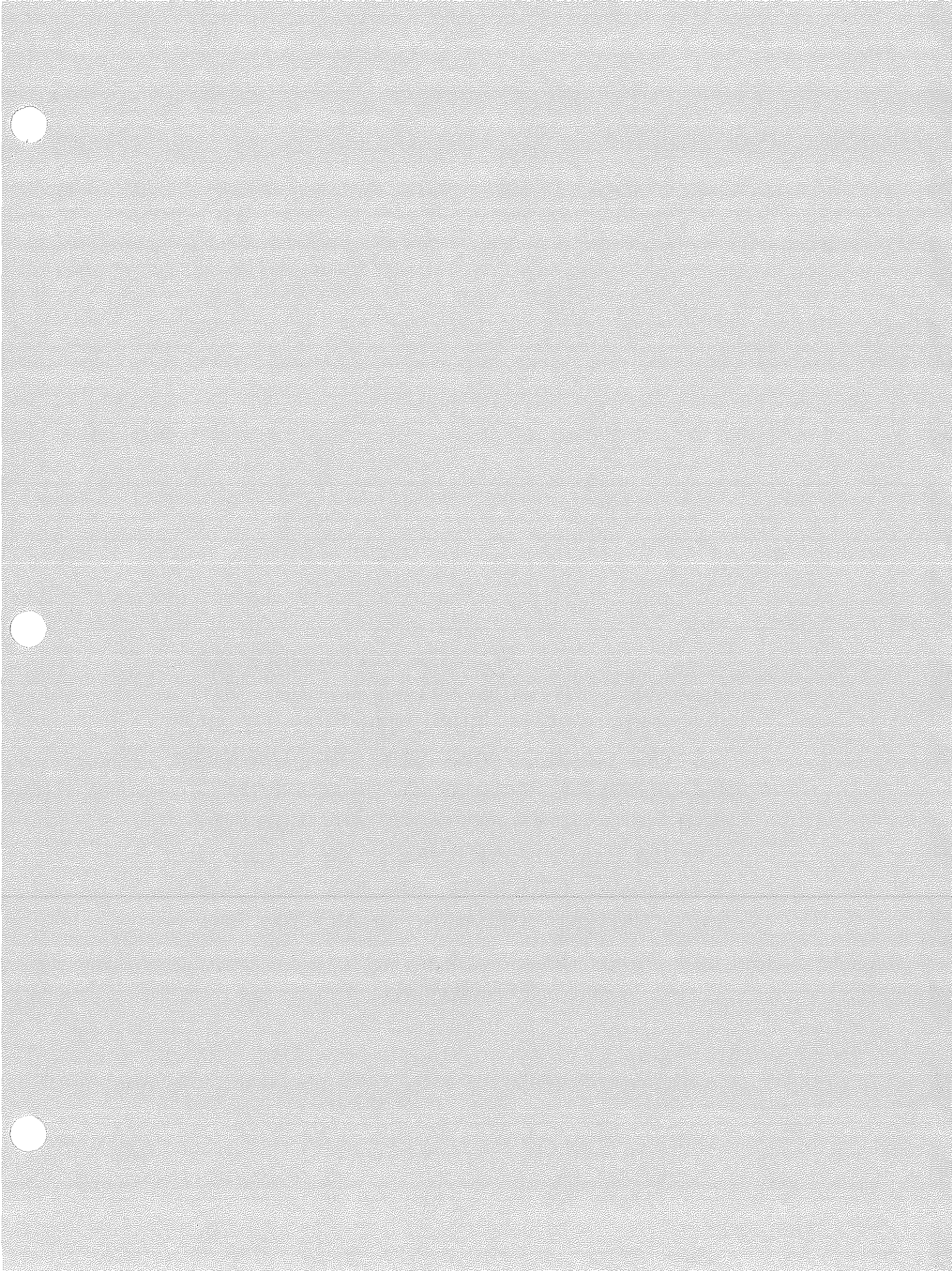

PART II

SERVICE INFORMATION

INSTALLATION

PACKAGING

At installation time, save the shipping carton and packing materials for repackaging in case shipment becomes necessary. See Repackaging for Shipment in Section 6, Maintenance, in this manual for detailed repackaging instructions.

ELECTRICAL INSTALLATION

Power Requirements

This instrument is intended to operate from a power source that will not apply more than 250 V rms between the supply conductors or between either supply conductor and ground. A protective ground connection by way of the grounding conductor in the power cord is essential for safe operation. Only the Line Conductor is fused for over-current protection.

The 528A operates over a line-frequency range of 48 Hz to 440 Hz, and at line voltages of 99 V ac to 132 V ac or 198 V ac to 250 V ac. A rear-panel LINE VOLTS selector switch makes selection of the nominal center line voltage easy. Power consumption of the 528A is approximately 48 watts at 115 V ac, 60 Hz line.

Line-Voltage Conversion

WARNING

Disconnect the ac power cord before removing the protective metal cabinet.

Check the setting of the LINE VOLTS selector switch (see Fig. 3-1). For a center (nominal) line voltage of 115 V

ac, the switch should be in the 'up' position. For a center (nominal) line voltage of 230 V ac, set the switch in the 'down' position.

Check that the proper fuse is installed for the center line voltage that is selected. For a center line voltage of 115 V ac, the line fuse should be a 0.7 A Slow-Blow type. For a center line voltage of 230 V ac, the line fuse should be a 0.4 A Slow-Blow type.

For maximum dependability and long life, the line voltage applied to the 528A should be within the line-voltage operating range for the LINE VOLTS switch position used. If the line voltage exceeds the operating limits, or has a poor waveform (distorted sine waves), unstable power-supply operation may result. Check for proper line voltage and waveform before checking for other causes of unstable operation. Use of an external line-voltage regulator is not generally recommended, since many available line-voltage regulators supply a distorted sine-wave output voltage.

Power Plug Options

A choice of power-plug configurations is available to adapt the 528A for use with a variety of ac power sockets. Figure 3-2 shows the various types available currently as options.

Cooling

The 528A is cooled by convection air flow through the instrument. For information concerning minimum clearance needed around the instrument for proper air circulation, refer to Fig. 3-13.

RGB/YRGB J370 Wiring Connections

A 9-pin socket connector, designated J370, is provided on the 528A rear panel to connect an external staircase signal and control voltages to the 528A. The input impedance between pin 3 (staircase signal input) and ground is

(D) Staircase signal is applied and the RGB/YRGB circuit is enabled by an external 5 V voltage source when the plug is inserted.

(E) Staircase signal is applied and the RGB/YRGB circuit is enabled by an external -12 V to -15 V source when the plug is inserted and the remote switch is closed to ground.

(F) Staircase signal is applied and the RGB/YRGB circuit is enabled by an external +5 V source when the plug is inserted and the remote switch is closed to ground.

(G) Staircase signal is applied and the RGB/YRGB circuit is enabled by internal -15 V when the plug is inserted and the remote switch is closed to coax ground.

(H) Staircase signal is applied and the RGB/YRGB circuit is enabled by internal +5 V when the plug is inserted, TP373 and TP374 are jumpered together, and the connection at pin 8 is actually made at the female plug.

(A) Staircase signal is applied and the RGB/YRGB circuit is enabled by internal -15 V when the male plug is inserted into the socket (J370).

(B) Staircase signal is applied and the RGB/YRGB circuit is enabled by internal +5 V when the male plug is inserted and TP373 & TP374 are jumpered together. In this illustration, the connections to pin 8 are actually made within the instrument at the female plug, J370. No connection is necessary to pin 8 of the male plug.

(C) Staircase signal is applied and the RGB/YRGB circuit is enabled by an external 12 V to 15 V voltage source when the plug is inserted.

The following information describes the operation for each wiring configuration shown in Fig. 3-3 and Fig. 3-5.

1.1 M Ω paralleled by approximately 50 pF. Figure 3-3 shows how to wire the male plug connector (supplied as a Standard Accessory with the 528A) so the staircase signal can be applied to the instrument. In addition, the illustrations show several ways to connect for directly or remotely using internal or external power for control.

Fig. 3-1. Locations of the Line Volts selector switch and the fuse holder on the rear panel of the 528A.

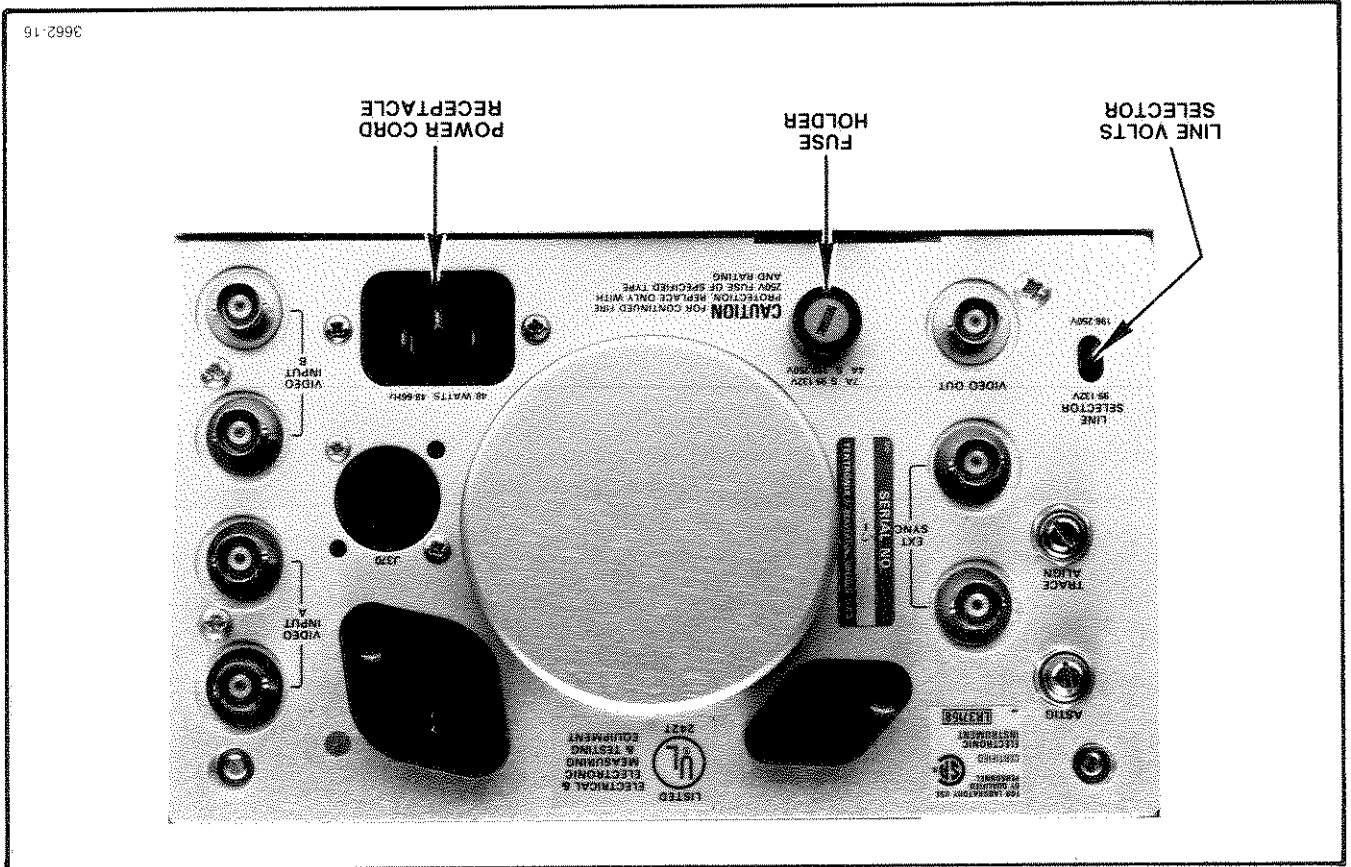

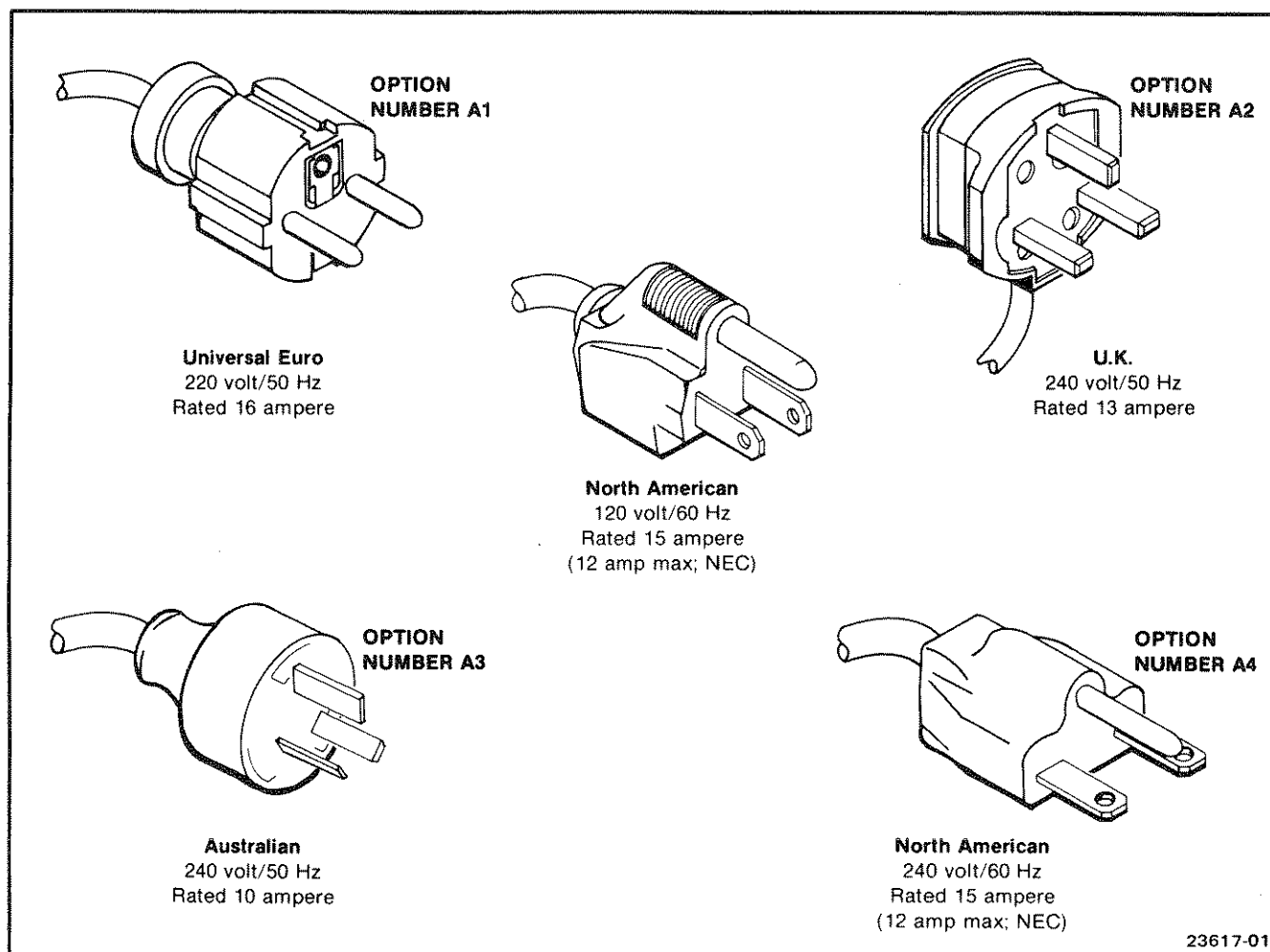

Fig. 3-2. Power cord options.

Figure 3-4 shows wiring connections for the female socket when using the alternate lettered-pin Amphenol socket (see Alternative Socket and Connectors in Section 1, Specification).

When control voltage is applied and the SWEEP switch is set to 2V or 2H, the sweep length is 27% to 33% of the normal sweep length for RGB (3 step) operation.

For externally-applied control signal power, apply 12 V to 15 V between pin 4 (positive) and pin 5 (negative), or 5 V between pin 8 (positive) and pin 5 (negative) of J370.

For internal power-control signal, jumper pin 5 to pin 6 on J370 for 15 V operation. Ground pin 4 to actuate RGB/YRGB circuit. For 5 V operation, jumper TP373 and TP374 (rear of Main circuit board inside of instrument. See Fig. 3-6). Ground pin 5 of J370 to actuate RGB/YRGB circuit.

The instrument is factory wired for RGB (3 step) operation. To convert to YRGB operation, connect a jumper between TP265 and TP266. See Fig. 3-7.

See Section 1, Specification, RGB/YRGB Electrical Specification, for control circuit internal resistances.

With the control voltage properly applied and J370 connected as described, when a 20 Hz 3-step RGB staircase signal of correct amplitude (10 V within 15%) is applied through pin 3 of J370, the display will be properly positioned if the DC Level control R304 (described later) is properly adjusted. The total length of the three stepped sweeps will be approximately equal to a normal sweep-trace length in accordance with the staircase output from a color processor (see Fig. 3-8).

To obtain the displays shown in Fig. 3-8, red, green, and blue non-composite outputs from a color bar generator were

Fig. 3-3. Rear (wiring) view of the 9-pin male plug supplied as part of the standard accessories to provide access to J370 (RGB/YRGB mode). See text under RGB/YRGB J370 Wiring Connections for operation with each configuration.

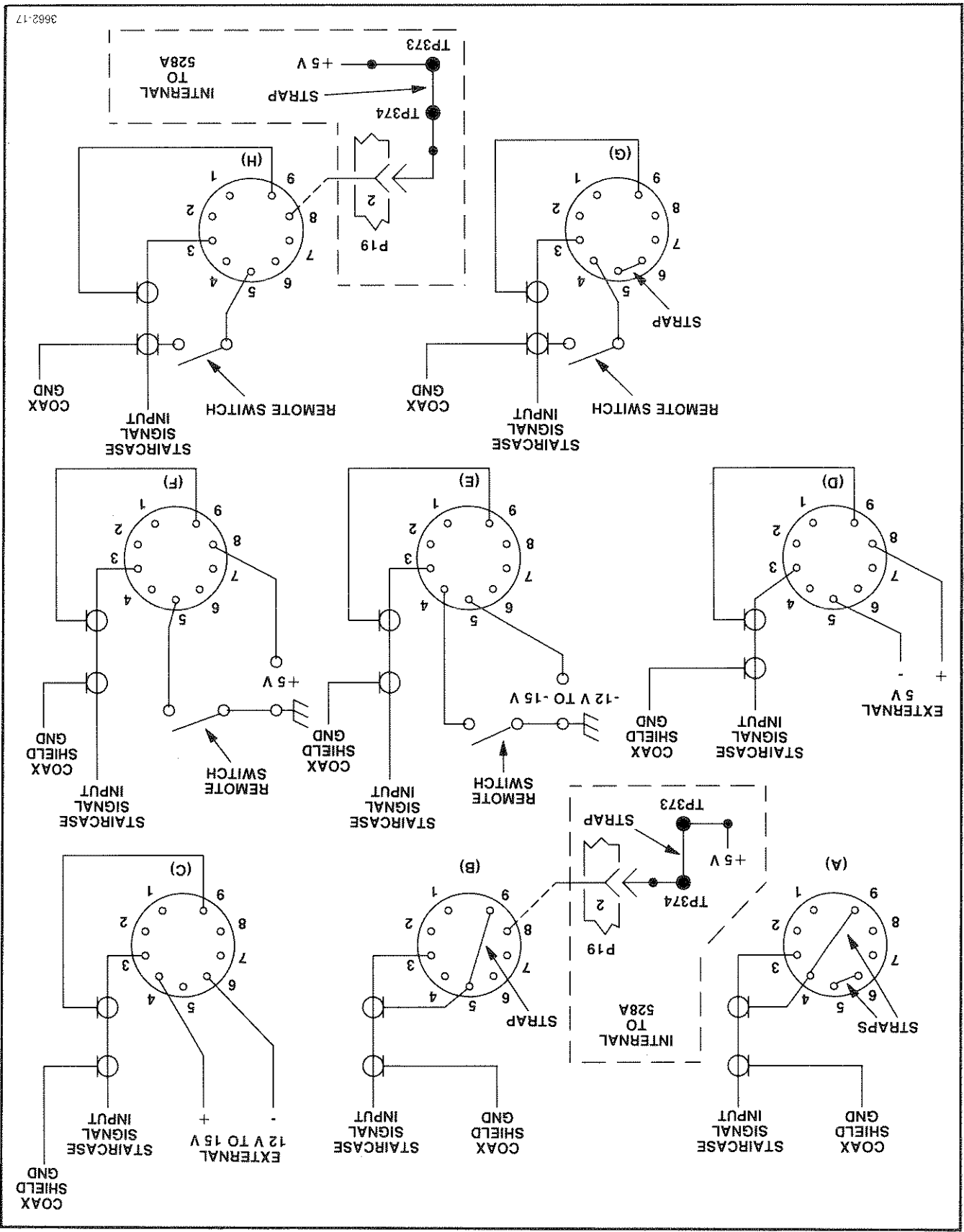

3962-17

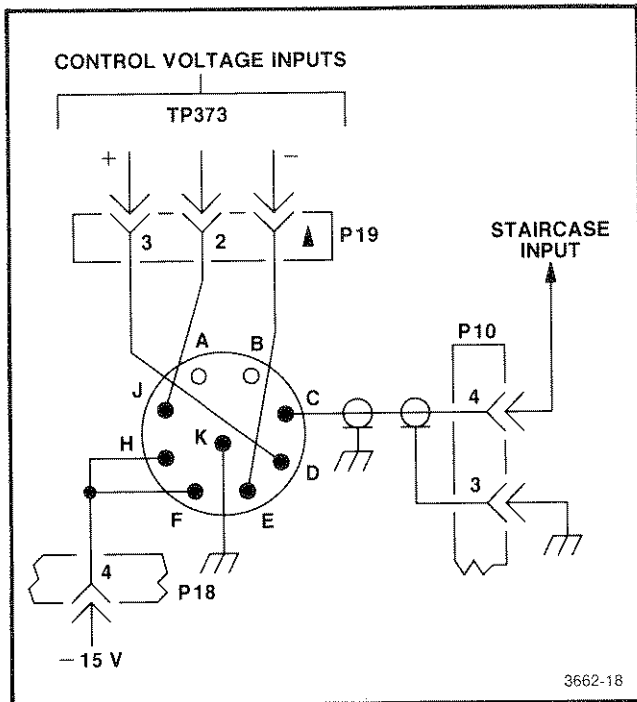

Fig. 3-4. Rear (wiring) view of alternate lettered-pin socket. Description: Socket, 9-pin, chassis mounting with female insert, Amphenol 165-13. Matching male plug, Amphenol 165-16.

coupled to a line-rate video switcher and to the 528A VIDEO INPUT A connector. The staircase output from the video switcher was applied to pin 3 of J370 to step the sweep sideways so that the red, blue, and green signals are displayed from left to right, respectively. This illustration is intended to simulate the display that could be obtained from a color television camera equipped with a RGB video switcher.

When using YRGB operation (4 step), the sweep length is 20% to 25% of normal sweep length. When the YRGB signal is applied to pin 3 of J370, the signal will step the sweep so the total length of the four stepped sweeps will be approximately equal to a normal sweep-trace length.

Some RGB and YRGB systems have a staircase signal output with a positive dc component, and some with a negative dc component. The dc component positions the display to the left or right on the crt, depending on the polarity. To properly position the display, proceed as follows:

1. Remove the control voltage and set the SWEEP switch to 2V or 2H. Check that the sweep starts at the first left major graticule division mark.

2. Apply the control voltage.

3. Adjust the DC Level control R304 (see Fig. 3-9) so the display starts at the same point as the normal (2V or 2H) sweep.

Modifications

The 528A can be modified to satisfy certain studio conditions. Some possible modifications are as follows:

1. Changing to dc input coupling.

Sometimes it is necessary to observe the demodulated output from a television transmitter, using a dc oscilloscope. The 528A vertical amplifier can be dc coupled and used for this purpose. The information that follows describes how to make the modification.

- a. Solder a jumper wire between TP2 and TP8 as shown in Fig. 3-10. The jumper shorts out the coupling capacitor, and all signals selected by the VOLTS FULL SCALE switch are now dc coupled from the input through the vertical amplifier to the crt vertical deflection plates with the RESPONSE switch set to FLAT or IRE.

2. Changing 3-step RGB Mode of Operation to 4-step YRGB Mode.

Refer to RGB/YRGB J370 Wiring Connections, previously described in this section.

3. Eliminating Crt Blanking During RGB/YRGB Mode of Operation.

- a. To observe the entire RGB/YRGB display (including retrace), connect a short jumper wire between TP230 and TP235 as shown in Fig. 3-11. The jumper applies +10 V to the emitter of Q230, which holds Q230 at cutoff. With Q230 cut off, the crt will be unblanked at all times.

4. Changing to 625-Line 25-Frame Scan.

The 528A can be easily modified to work with a 625-line, 25-frame (50-Hz field rate) scan system. Refer to Option 3 in Section 7, Instrument Options in this manual for details.

MECHANICAL INSTALLATION

Rackmounting Installation

The metal cabinet for the 528A provides the proper electrical environment for the instrument, minimizes handling damage, and reduces dust collection within the instrument. The four 0.156-inch diameter holes in the bottom of the cabinet depressions provide a means for mounting the instrument solidly to a surface such as a metal shelf (rack adapter) in a cabinet rack or console.

3662-19

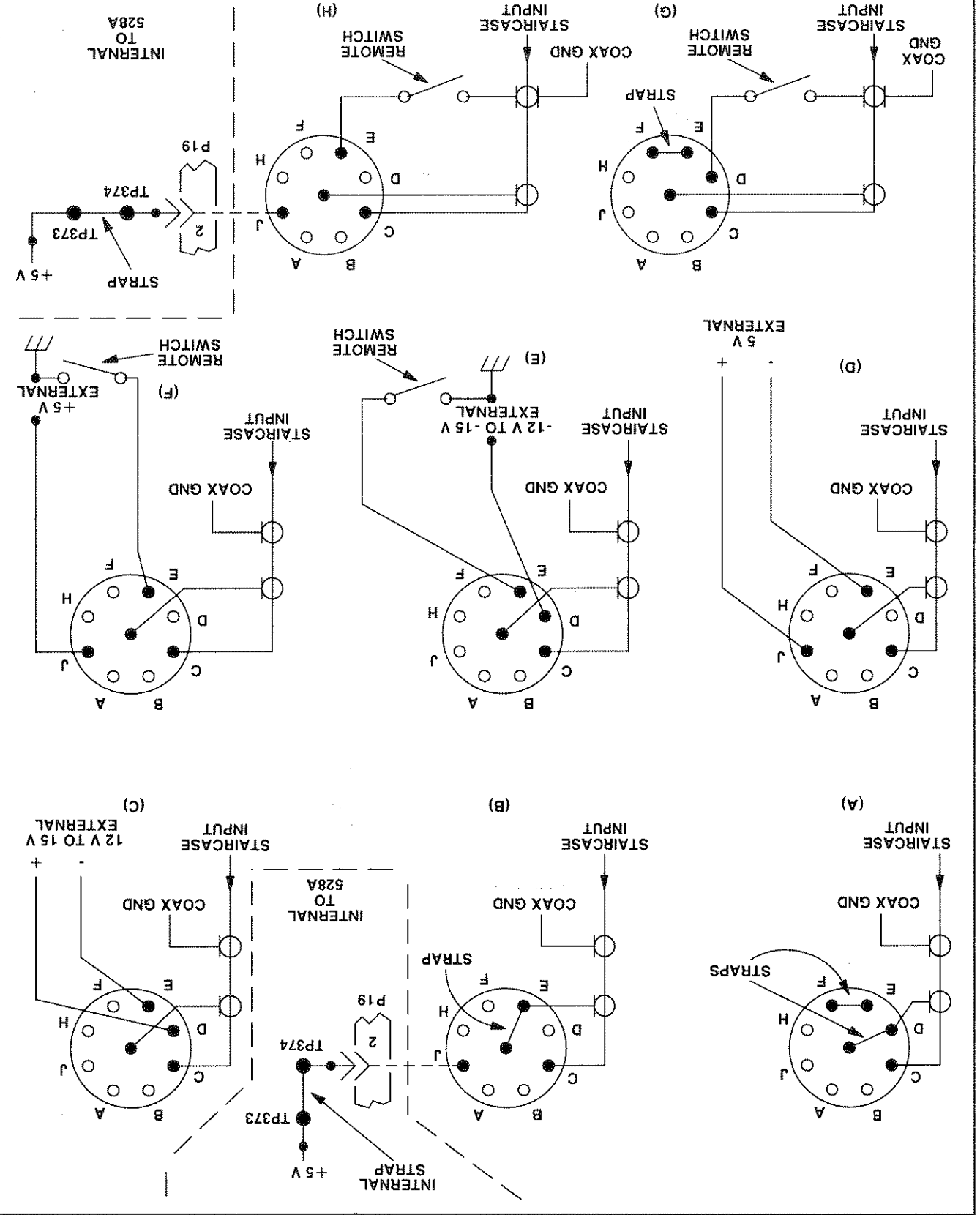

Fig. 3-5. Rear (wiring) view of alternate Amphenol male plug if used with the socket shown in Fig. 3-4. See text (RGB/YRGB J370 Wiring Connections).

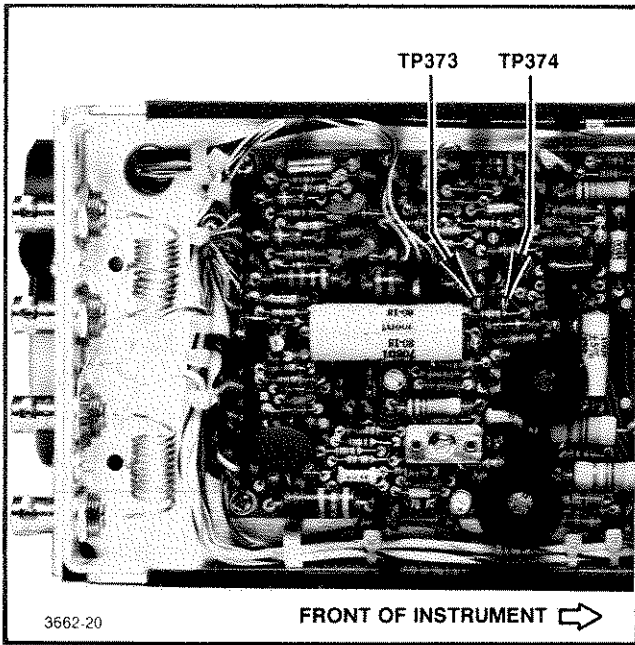

Fig. 3-6. Partial view of the Main board, showing locations of TP373 and TP374 near the rear of the board.

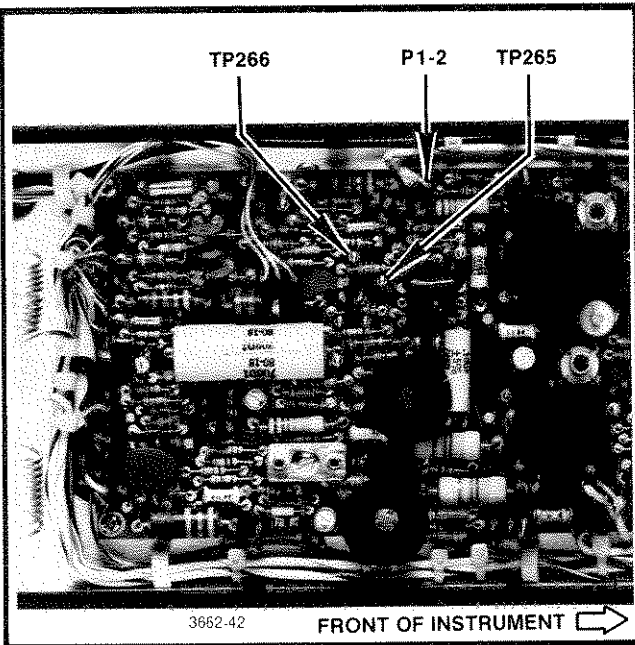

Fig. 3-7. Partial view of the Main board, showing locations of TP265 and TP266 near the rear of the board. These test points should be jumpered together for YRGB operation.

The 528A is designed to be cradle-mounted in a standard 19-inch rack or console side-by-side with another 528A or other instrument, such as the TEKTRONIX 1420 Vectorscope or the TEKTRONIX 602 or 604A Display Moni-

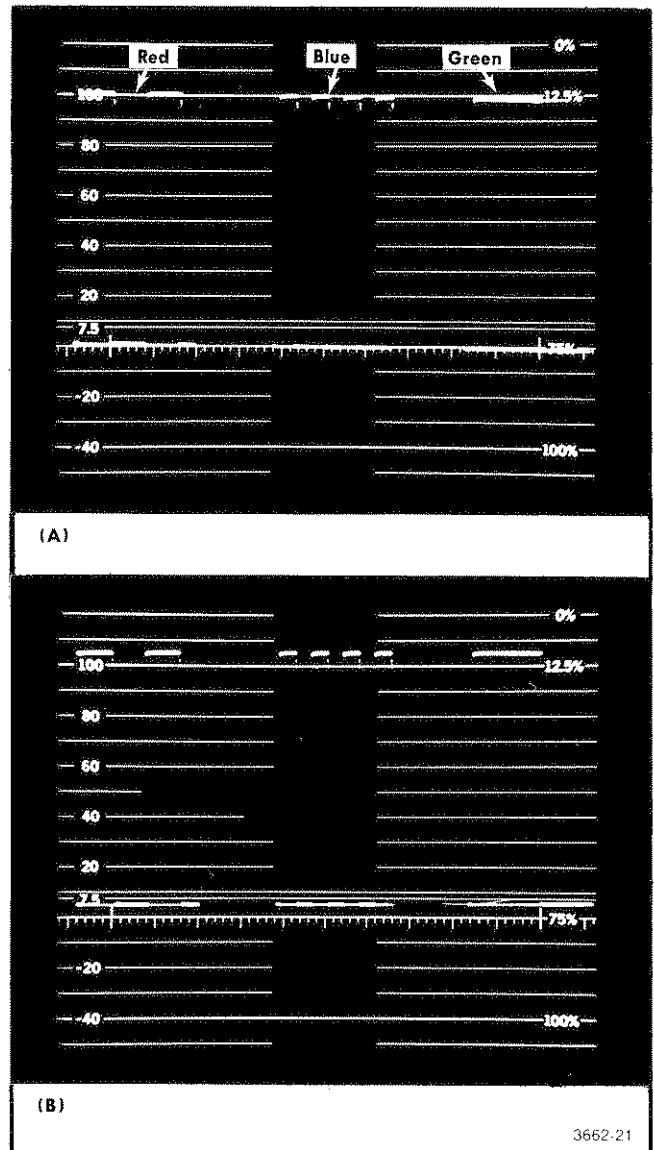

Fig. 3-8. Display obtained with the 528A set for RGB mode, using one type of RGB switcher. With the DC RESTORER switch set to ON, the vertical POSITION control was used to position the black level of display (A) at 0 IRE, and display (B) slightly above the 0 IRE graticule line (for a clearer view of the waveform).

tor. See the listing at the rear of this section for Tektronix part numbers for rack adapters and other mounting hardware. If only one 528A is mounted on the rack adapter, a panel assembly that goes around the 528A cabinet front dimension and covers the space for the other half of the rack width can be obtained through your local Tektronix Field Office or representative. See the rear of this section for Tektronix part numbers. Fig. 3-12 shows details of the rack installation. Figure 3-13 shows dimensions of the 528A in the metal cabinet and locations of the holes in the bottom of the cabinet depressions.

The dimensional drawings in Fig. 3-13 can be used as a reference for planning a custom installation. There are two possible ways to install the 528A: (1) Use the front dimen-

Custom Installation

Fig. 3-10. Partial view of the Main board, showing locations of TP2 and TP8 near the front of the board. When a jumper is connected between these test points, the 528A is dc-coupled from the input through the vertical amplifier to the crt deflection plates.

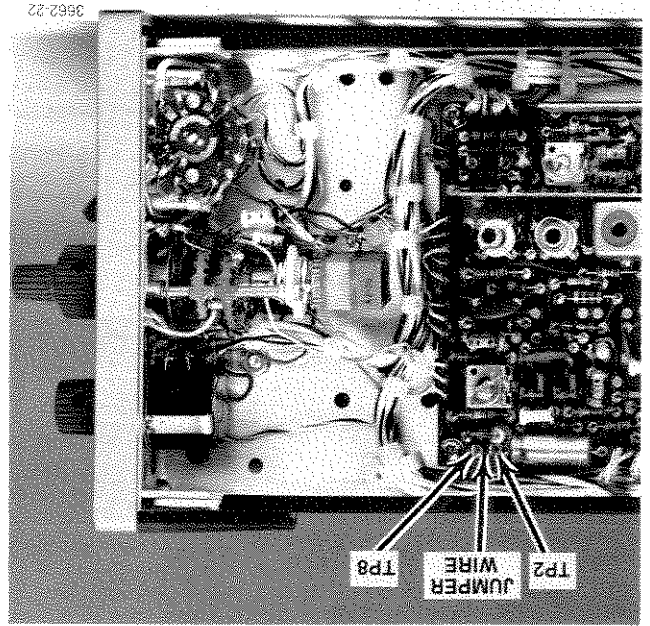
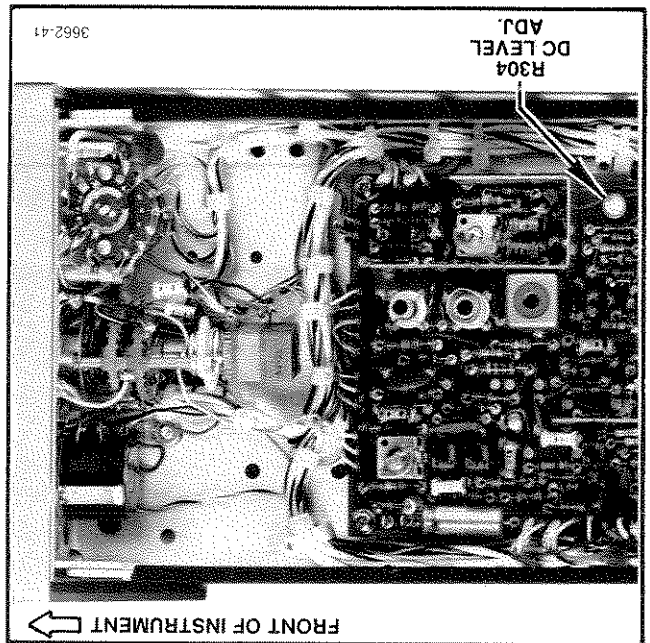

Fig. 3-9. Partial view of the Main board, showing location of the DC Level control (R304) near the front of the board.



3. Slide the cabinet through the rear side of the custom panel opening. Let the cabinet protrude through the front panel about 0.125 inch. (The front sub-panel casting on the

2. Cut the hole in the custom panel. Use the front dimensional view of the cabinet or the cabinet itself to determine the size of the opening.

1. Remove the two screws shown in the rear-view drawing of the 528A and slide the instrument out through the front of the cabinet.

To install the instrument using the first method, the following procedure is suggested (refer to Fig. 3-13 and Fig. 3-14):

The first installation method allows the Waveform Monitor front sub-panel casting to cover the opening made in the custom panel. The second installation method requires a larger opening to allow the instrument to be positioned about 0.45 inch further back on the shelf to make the Waveform Monitor front-panel surface align with the custom-panel surface.

Personal view of the cabinet to cut an opening the same size as the outside dimension of the front sub-panel casting.

Fig. 3-11. Partial view of the Main board, showing locations of TP230 and TP235 near the rear of the board. With a jump wire connected as shown and the 528A in the RGB/YRGB mode of operation, the crt will be unblanked at all times.

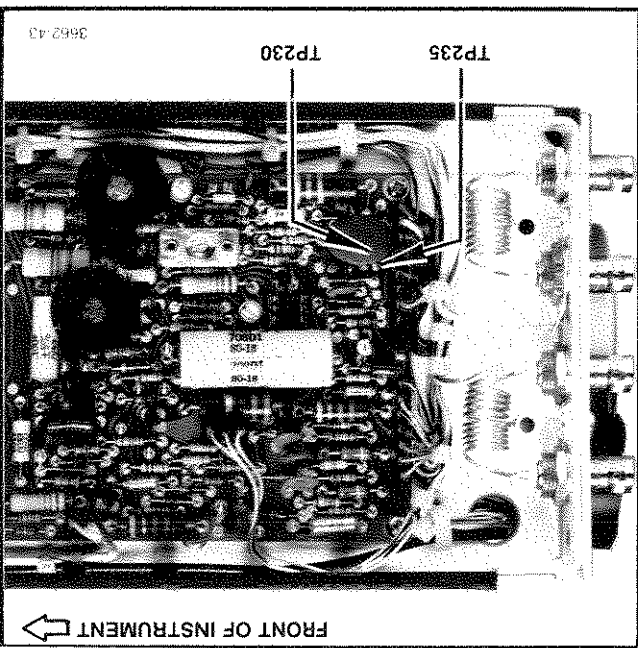

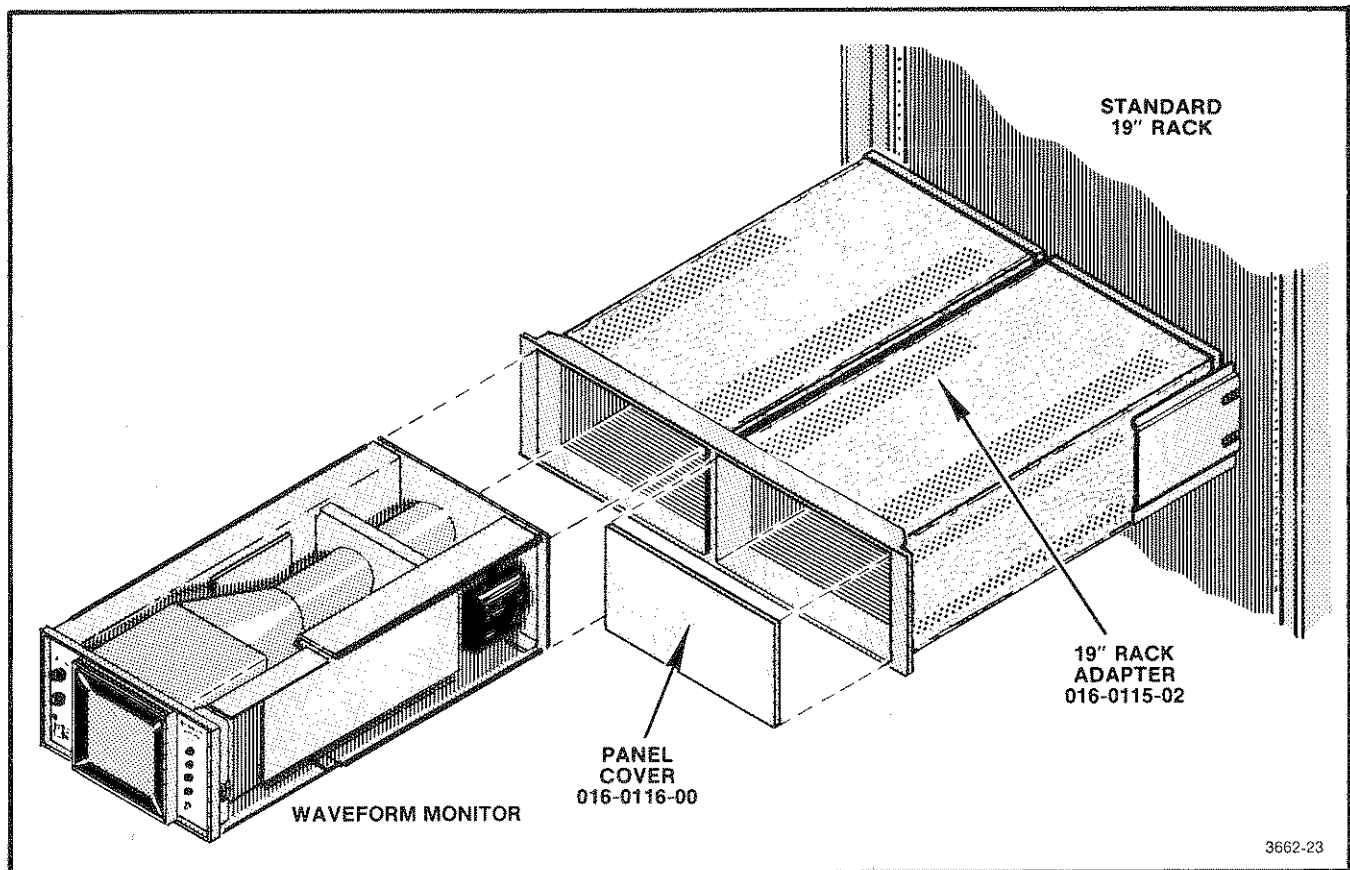

Fig. 3-12. Rack installation in the rack adapter (cradle mount).

Waveform Monitor has a groove to accept this amount of protrusion.)

4. Mark locations where the cabinet will be fastened to the shelf. (The bottom dimensional view drawing shows the 0.156-inch diameter hole locations in the cabinet.) Temporarily remove the cabinet; drill holes in the shelf.

5. Reinsert the cabinet through the custom panel opening. Fasten the cabinet to the shelf.

6. Insert the Waveform Monitor into the front of the cabinet. Secure the instrument to the cabinet by installing the two rear-panel screws removed earlier (in step 1).

To install the instrument using the second method, the following procedure is suggested:

1. Measure the distance from the front edge of the Waveform Monitor front sub-panel casting to the center of the front mounting holes in the bottom of the cabinet. (This dimension should be approximately 2.19 inches.)

2. Remove the two screws shown in the rear-view drawing of the 528A and slide the instrument out through the front of the cabinet.

3. Cut the hole in the custom panel. Use the front dimensional view of the Waveform Monitor or use the rear casting on the cabinet to determine the size of the opening.

4. Mark locations of front mounting holes for the cabinet. Then, use the cabinet to mark rear hole locations for the cabinet or use the dimensional drawing as a guide in marking hole locations. Temporarily remove the cabinet; drill holes in the shelf.

TO REMOVE S28A
REMOVE THESE TWO
SCREWS AND
INSTALLMENT OUT THRU
FRONT OF CABINET.

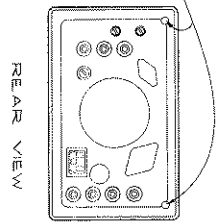

REAR VIEW

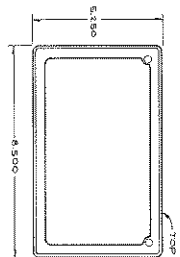

REAR VIEW

CABLES AND REQUIRED
WIRING MUST BE
CONNECTED TO THE
FRONT OF CABINET

(CABLES AND WIRING MUST
BE CONNECTED TO THE
FRONT OF CABINET ON
THE INSIDE OF THE
FRONT PANEL)

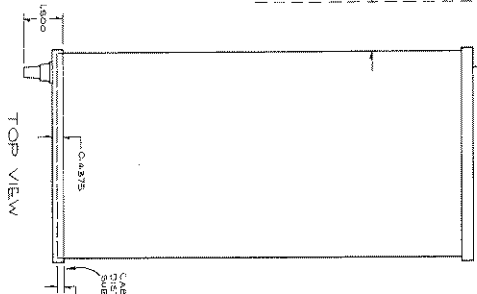

TOP VIEW

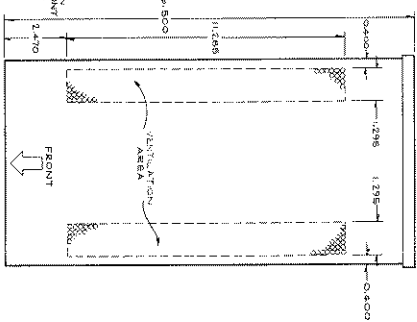

TOP VIEW

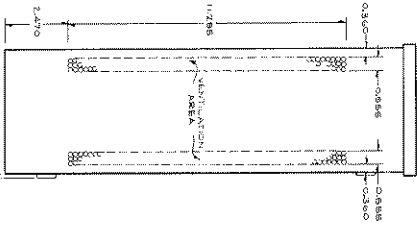

RIGHT SIDE VIEW

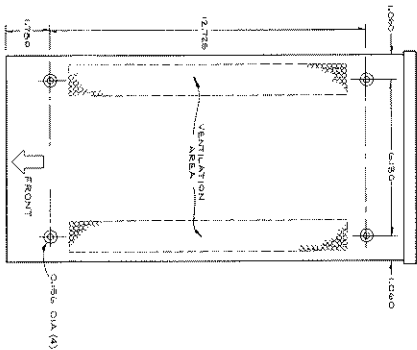

BOTTOM VIEW

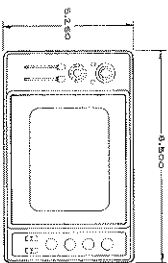

FRONT VIEW

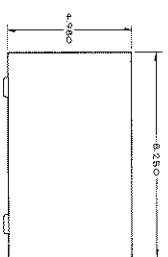

FRONT VIEW

S28A

NET WEIGHT: 1.5 LBS (0.68 KG)
GROSS WEIGHT: 2.5 LBS (1.13 KG)

DIMENSION DRAWING

Fig. 3-13. Dimensional drawings of the S28A with cabinet.

3662-83

- NOTES:
1. VENTILATION AREAS ARE THE BOTTOM VIEWS.
 2. VENTILATION AREAS ARE IDENTICAL FOR RIGHT & LEFT HAND UNITS.
 3. ALL DIMENSIONS ARE IN INCHES UNLESS OTHERWISE SPECIFIED.

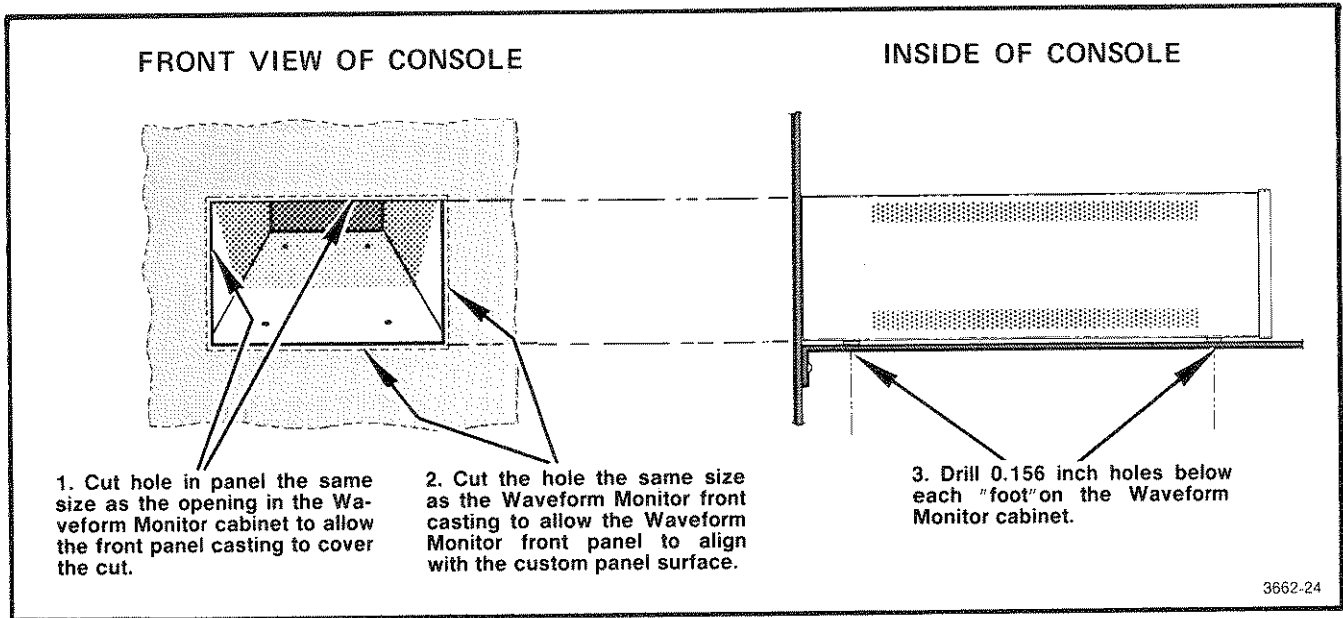

Fig. 3-14. Custom installation details.

5. Use steps 5 and 6 of the first method as a guide for completing the installation.

Portable Usage (Option 02)

For portable use, the Waveform Monitor can be removed from the rack or custom installation and slipped into a blue-vinyl aluminum field case. The field case has a latch to hold the instrument in the case. In addition, the field case is equipped with a carrying handle and rubber feet.

Tektronix Part Numbers for Cradle Mounts, Cabinets, Blank Panels, and Field Cases

Description	Tektronix Part No.
Metal Cabinet	437-0100-01
Rack Adapter (Cradle Mount)	016-0115-02
Panel Assembly (Blank Panel)	016-0116-00
Carrying Case (Field Case)	390-0018-01

These items can be ordered through your local Tektronix Field Office or representative.

