

## CAUTION

*The S-6 Sampling Head is sensitive to electrostatic and overload damage. The maximum input voltage must never exceed  $\pm 5$  volts. The maximum operating voltage is 1 V p-p.*

*The S-6 should be used in an electrostatically safe environment, including the use of a properly terminated operator's wrist strap. The operator must be careful to discharge any electrostatic charge that may be on cables that are to be connected to the S-6.*

*When the S-6 is not in use or is being transported, one input must be kept terminated into a 50  $\Omega$  load.*

**PLEASE CHECK FOR CHANGE INFORMATION  
AT THE REAR OF THIS MANUAL.**

# S-6 SAMPLING HEAD

## INSTRUCTION MANUAL

Tektronix, Inc.  
P.O. Box 500  
Beaverton, Oregon 97077  
070-1128-01  
Product Group 42

Serial Number \_\_\_\_\_

First Printing SEP 1982  
Revised APR 1987

Copyright ©1971 , 1982 Tektronix, Inc. All rights reserved.  
Contents of this publication may not be reproduced in any  
form without the written permission of Tektronix, Inc.

Products of Tektronix, Inc. and its subsidiaries are covered  
by U.S. and foreign patents and/or pending patents.

TEKTRONIX, TEK, SCOPE-MOBILE, and  are  
registered trademarks of Tektronix, Inc. TELEQUIPMENT  
is a registered trademark of Tektronix U.K. Limited.

Printed in U.S.A. Specification and price change privileges  
are reserved.

#### INSTRUMENT SERIAL NUMBERS

Each instrument has a serial number on a panel insert, tag,  
or stamped on the chassis. The first number or letter  
designates the country of manufacture. The last five digits  
of the serial number are assigned sequentially and are  
unique to each instrument. Those manufactured in the  
United States have six unique digits. The country of  
manufacture is identified as follows:

B000000	Tektronix, Inc., Beaverton, Oregon, USA
100000	Tektronix Guernsey, Ltd., Channel Islands
200000	Tektronix United Kingdom, Ltd., London
300000	Sony/Tektronix, Japan
700000	Tektronix Holland, NV, Heerenveen, The Netherlands

# TABLE OF CONTENTS

<b>Section 1 SPECIFICATION</b>	<b>Page</b>	<b>Section 4 PERFORMANCE CHECK AND ADJUSTMENT PROCEDURES</b>	<b>Page</b>
General Information . . . . .	1-1	Introduction . . . . .	4-1
Electrical Characteristics . . . . .	1-1	Equipment Required . . . . .	4-1
Environmental Characteristics . . . . .	1-2	Performance Check Procedure . . . . .	4-2
Mechanical Characteristics . . . . .	1-2	Adjustment Procedure . . . . .	4-5
<b>Section 2 OPERATING INSTRUCTIONS</b>		<b>Section 5 MAINTENANCE</b>	
General Information . . . . .	2-1	Introduction . . . . .	5-1
Head Installation . . . . .	2-1	Obtaining Replacement Parts . . . . .	5-1
Extender Cable Installation . . . . .	2-1	Parts Removal and Replacement . . . . .	5-1
First Time Operation . . . . .	2-2	Troubleshooting . . . . .	5-1
Input Connections . . . . .	2-4		
<b>WARNING</b>			
<i>THE FOLLOWING SERVICING INSTRUCTIONS ARE FOR USE BY QUALIFIED PERSONNEL ONLY. TO AVOID PERSONAL INJURY, DO NOT PERFORM ANY SERVICING OTHER THAN THAT CONTAINED IN OPERATING INSTRUCTIONS UNLESS YOU ARE QUALIFIED TO DO SO.</i>			
<b>Section 3 THEORY OF OPERATION</b>		<b>Section 6 OPTIONS</b>	
General . . . . .	3-1	<b>Section 7 ELECTRICAL PARTS LIST</b>	
Block Diagram . . . . .	3-1	<b>Section 8 DIAGRAM</b>	
Circuit Description . . . . .	3-2	<b>Section 9 MECHANICAL PARTS LIST</b>	

# LIST OF ILLUSTRATIONS

<b>Fig. No.</b>		<b>Page</b>	<b>Fig. No.</b>		<b>Page</b>
2-1	S-6 Installation Information. . . . .	2-3	4-3	Incident pulse risetime of the S-6, S-52 and 7S12 system. . . . .	4-4
2-2	S-52 Waveform with 7S12 X 10 Multiplier setting. . . . .	2-4	4-4	Reflected pulse risetime of the S-6, S-52 and 7S12 system. . . . .	4-4
2-3	Preferred connections to the S-6 Sampling Head. . . . .	2-4	4-5	Double Strobings example. . . . .	4-5
2-4	S-6 used with 7S12 TDR/Sampler and S-52 Pulse Generator in Loop Thru TDR application. . . . .	2-4	4-6	Triple exposure to show correct adjustment of Snap-off Current control R50. . . . .	4-6
2-5	S-6 High Frequency Signal Applications. . . . .	2-5	4-7	Typical pulse waveform showing correct adjustment of LF Transient Response control, C20 and Dot Transient Response control, R45. . . . .	4-6
3-1	S-6 Block Diagram . . . . .	3-1			
4-1	Waveforms used to check displayed noise. . . . .	4-2			
4-2	Pulse aberrations of the S-6, S-52, and 7S12 system. . . . .	4-3			

# OPERATORS SAFETY SUMMARY

The general safety information in this part of the summary is for both operating and servicing personnel. Specific warnings and cautions will be found throughout the manual where they apply, but may not appear in this summary.

## TERMS

### In This Manual

CAUTION statements identify conditions or practices that could result in damage to the equipment or other property.

WARNING statements identify conditions or practices that could result in personal injury or loss of life.

### As Marked on Equipment

CAUTION indicates a personal injury hazard not immediately accessible as one reads the marking, or a hazard to property including the equipment itself.

DANGER indicates a personal injury hazard immediately accessible as one reads the marking.

## SYMBOLS

### In This Manual



This symbol indicates where applicable cautionary or other information is to be found.

### As Marked on Equipment



DANGER—High voltage.



Protective ground (earth) terminal.



ATTENTION—refer to manual.

### Power Source

This product is intended to operate from a power module connected to a power source that will not apply more than 250 volts rms between the supply conductors or between either supply conductor and ground. A protective ground connection by way of the grounding conductor in the power cord is essential for safe operation.

### Grounding the Product

This product is grounded through the grounding conductor of the power module power cord. To avoid electrical shock, plug the power cord into a properly wired receptacle before connecting to the product input or output terminals. A protective ground connection by way of the grounding conductor in the power module cord is essential for safe operation.

### Danger Arising From Loss of Ground

Upon loss of the protective-ground connection, all accessible conductive parts (including knobs and controls that may appear to be insulating) can render an electric shock.

### Use the Proper Fuse

To avoid fire hazard, use only the fuse of correct type, voltage rating and current rating as specified in the parts list for your product.

Refer fuse replacement to qualified service personnel.

### Do Not Operate in Explosive Atmospheres

To avoid explosion, do not operate this product in an explosive atmosphere unless it has been specifically certified for such operation.

### Do Not Operate Without Covers

To avoid personal injury, do not operate this product with out covers or panels installed. Do not apply power to the plug-in via a plug-in extender.

# SERVICE SAFETY SUMMARY

## FOR QUALIFIED SERVICE PERSONNEL ONLY

*Refer also to the preceding Operators Safety Summary.*

### **Do Not Service Alone**

Do not perform internal service or adjustment of this product unless another person capable of rendering first aid and resuscitation is present.

### **Use Care When Servicing With Power On**

Dangerous voltages may exist at several points in this product. To avoid personal injury, do not touch exposed connections and components while power is on.

Disconnect power before removing protective panels, soldering, or replacing components.

### **Power Source**

This product is intended to operate in a power module connected to a power source that will not apply more than 250 volts rms between the supply conductors or between either supply conductor and ground. A protective ground connection way of the grounding conductor in the power cord is essential for safe operation.

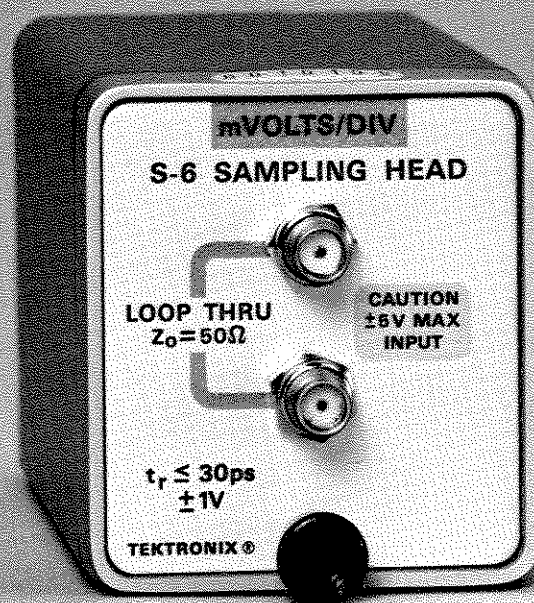

1128-01

S-6 Sampling Head.

# SPECIFICATION

## General Information

The S-6 Sampling Head is a 50  $\Omega$  loop-through input sampling unit for use with Tektronix sampling instruments. The S-6 is designed for use with the 7S12 TDR Sampling Unit. For general purpose sampling applications, the S-6 may be used with the 7S11.

The operating power for the S-6 is obtained from the unit in which the S-6 is installed.

Vertical deflection factor of the sampling system is labeled at the top of the S-6 as mVOLTS/DIV. The label refers to the sampling unit Units/Div switch of the corresponding channel.

The following electrical characteristics apply over an ambient temperature range of +10°C to +40°C and after a five minute warmup, provided that the S-6 has been calibrated and properly mated to the associated sampling unit and indicator oscilloscope at a temperature between +20°C and +30°C.

Table 1-1  
ELECTRICAL CHARACTERISTICS

Characteristics	Performance Requirements	Supplemental Information
STEP RESPONSE		Conditions for test: 750 ps coaxial, sma (13 mm) line, between S-6 (lower LOOP THRU connector) and S-52; 1 ns coaxial, sma (3 mm) line between S-6 (upper LOOP THRU connector) and termination.
Risetime		
S-6 Incident	30 ps or less	
S-6, S-52 System		
Incident	35 ps or less	
Reflected	45 ps or less	From short circuit termination
Aberration	+7%, -7%, total of 10% p-p within the first 1.8 ns of the step edge with the reference level at 1.8 ns from the step edge; +2%, -2%, total of 4% p-p after 2.5 ns from the step edge with the reference level at 0.3 $\mu$ s from the step edge.	50 $\Omega$ termination and checked with an S-52 Pulse Generator.
Displayed Noise	5 mV or less, measured tangentially.	
Dot Transient Response	Within 5% for input signals up to 250 mV p-p.	Plug-in unit (7S11) may require adjustment of Dot Response control when Units/Div is changed. Does not apply for other plug-in samplers.
Signal Voltage		
Maximum Operating		1 V p-p
Safe Overload		Do not exceed + or -5 V dc limit
Input Resistance		10 k $\Omega$ within 10%
Baseline shift with repetition rate change		10 mV or less from 30 Hz to 50 kHz

**Table 1-2  
ENVIRONMENTAL CHARACTERISTICS**

<b>Characteristic</b>	<b>Description</b>
Temperature	
Non-operating	−40°C to +65°C
Operating	+10°C to +40°C
Altitude	
Non-operating	To 50,000 feet
Operating	To 15,000 feet
Vibration (Non-operating)	15 minutes along each axis at 0.015 inch. Vary the frequency from 10 to 55 to 10 Hz in 1 minute sweeps. Three minutes at any resonant point or at 55 Hz.
Shock (Non-operating)	Two shocks each of 500 g's (2 ms duration), 750 g's (1 ms duration) and 1000 g's (0.5 ms duration), in each direction and along each major axis for a total of 36 shocks.
Transportation	Meets National Safe Transit Committee type of test when packaged as shipped by factory.

**Table 1-3  
CHARACTERISTICS**

<b>Characteristic</b>	<b>Description</b>
Finish	Anodized aluminum front panel, extruded aluminum blue-vinyl painted cabinet with aluminum castings front and rear.
Weight	Approximately 8 oz. (0.23 kg)
Dimensions	
Height	About 2 inches (508 mm)
Width	About 1 3/4 inches (445 mm)
Length	About 4 inches (1047 mm)
Accessories	An illustrated list of the accessories supplied with the S-6 is at the end of the Replaceable Mechanical Parts list pullout pages.



# OPERATING INSTRUCTIONS

## General Information

This section of the manual provides the basic information required for operation of the S-6 Sampling Head, and includes, installation and First Time Operating instructions.

The S-6 may be used on an extender cable without compromising the response of the measurement system. Signals are applied to the 50  $\Omega$  "LOOP THRU" sampling head input through two sma (3 mm) coaxial connectors located on the front panel. The 50  $\Omega$  loop enables the operator to continue the signals in a 50  $\Omega$  cable after the sampling point, or to terminate the signal at the front-panel sma (3 mm) connector.

### CAUTION

*When the S-6 is not in use, the 50  $\Omega$  termination should be put on one input to protect it from static discharge. When the S-6 is used for TDR operation, be careful to discharge any electrostatic charge that may be on the cable before connecting it to the S-6 input.*

### NOTE

*Attenuators, with threaded sma (3 mm) connectors, are available as optional accessories. These attenuators are useful in reducing the amplitude of large signals. Other optional accessories with sma (3 mm) connectors include coaxial cables, a 50  $\Omega$  termination, and adapters for interconnecting various types of connectors. Refer to your Tektronix catalog or contact your local Tektronix Field Office or representative for further information about optional accessories.*

## Head Installation

To insert the S-6 into a compartment of the sampling unit, proceed as follow: (older models).

1. Pull the latch knob outward from the front panel (the latch knob will push out normally when the unit is inserted if the knob is left free to move).
2. Insert the unit slowly into the compartment, so the two plastic guides enter the rear connector opening.

3. Push the S-6 completely into the compartment.

4. Push the latch knob to lock the unit in place.

5. To remove the S-6 from the compartment, pull the latch knob away from the front panel, then pull the unit from the compartment.

Later models of the S-6 head use a screw-type latch. The directions are on the latch button.

## Extender Cable Installation

To use the S-6 on an extender cable, install as follows:

1. Pull the latch knob located on the head end of the extender cable outward from its panel (the latch knob will push out normally when the extender is inserted if the knob is free to move).

2. Insert the extender cable head end slowly into the desired compartment in the sampling unit so the two plastic guides engage the unit.

3. Push the head completely into the compartment.

4. Push the latch knob to lock the extender cable head end in place.

5. Connect the S-6 to the other end of the extender cable in a similar manner, and set the latch knob to hold it in place.

6. To remove the S-6 from the extender cable, pull the latch knob on the front panel of the S-6 and remove the unit from the extender cable.

7. To remove the extender cable head from the sampling unit compartment, pull the latch knob outward from the front of the panel, then pull the extender cable free.

**Mating**

The S-6 may usually be changed from one sampling unit to another with little or no change in its operation. For precise offset measurements, the Gate Balance adjustment in the S-6 should be adjusted when a relocation of the S-6 is made. Adjustment information is given under the heading Gate Balance Adjustment.

**NOTE**

*Connectors at both ends of the coaxial cable should be firmly connected to mating connectors or accessories. Tighten slightly more than finger tight using a 5/16 inch wrench. A good connection is necessary to minimize reflections at the junction of connectors.*

**FIRST TIME OPERATION**

**Equipment**

This First Time Operation is set up for TDR (Time Domain Reflectometry) sampling. Other equipment includes a TEKTRONIX 7000-series oscilloscope with a 7S11 Sampling Unit and a 7T11 Sampling Sweep Unit.

First Time Operation uses a TEKTRONIX 7000-Series indicator oscilloscope, 7S12 TDR/Sampler, S-52 Pulse Generator Head, and S-6 installed as shown in Fig. 2-1(A).

3. Install a sma 1 ns coaxial cable (supplied with the S-52) with a male-to-male adapter and a 50 Ω termination connector to the S-6 LOOP THRU (upper) connector.

4. Set the instrument controls as follows:

**7000-series Oscilloscope**

A Intensity	ccw
B Intensity	ccw
Vertical Mode	Right
Horizontal Mode	A

**INSTALLATION**

**General**

The S-6 can be plugged into the sampling head compartments of Tektronix sampling instruments. Two general methods of installation are shown in Fig. 2-1 Part (A) shows the S-6 installed in the sampling compartment of the TEKTRONIX 7S12 TDR Sampling Unit. The 7S12 can be used in any 7000-series oscilloscope. Part (B) shows the S-6 installed in the TEKTRONIX 7S11 Sampling unit with a 7T11 Sampling Sweep Unit and a 7000 series oscilloscope.

**7S12 with S-6 and S-52**

**(Two center compartments, the right vertical and the A horizontal compartments)**

With (A) or (B) method of installation, the S-6 can be plugged into a sampling unit as shown, or used remotely on a special extender cable. Three and six foot extender cables are available. Order the three foot extender cable by Tektronix Part No. 012-0124-00, or the six foot extender cable by Tektronix Part No. 012-0125-00. Contact your local Tektronix Field Office or representative for price and availability of these optional accessories.

Time Distance dial	0
Multiplier	X10
Time/Div	1 μs
Variable	Cal in
Fine (Zero Set)	Fully clockwise
Rep	Pushed in
Scan	Midrange
Locate	Pushed in
mV	Pushed in
mV/Div	100
Variable	Cal in
DC Offset (& Fine)	Midrange

**Procedure**

1. Install the 7S12, S-6, and S-52 as shown in Fig. 2-1(A).

5. Advance the A intensity until a trace is observed. Use the DC Offset control to position the display on the crt.

2. Use the U-shaped 50 Ω semi-rigid cable (supplied with the 7S12), to connect the S-52 Pulse Output signal to the lower LOOP THRU connector on the S-6.

6. Observe the S-52 waveform shown in Fig. 2-2. The positive pulse in the center of the screen is used in the S-52 to automatically reset the tunnel diode bias for the next pulse trigger from the 7S12. The S-52 output pulse is not visible on the screen.

S-6

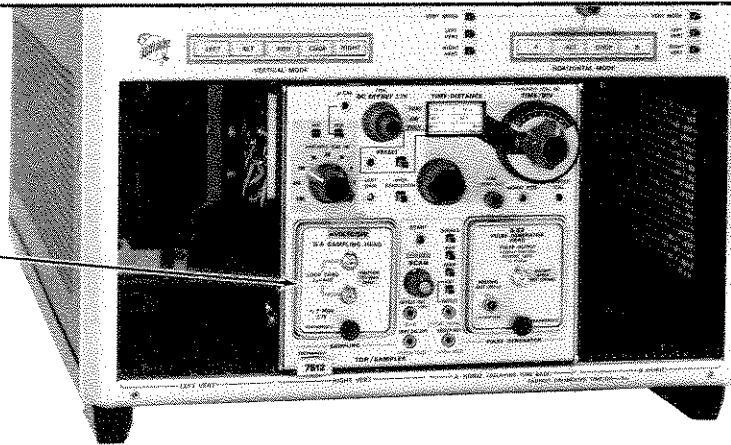

(A) Installed in Sampling compartment of 7S12

S-6

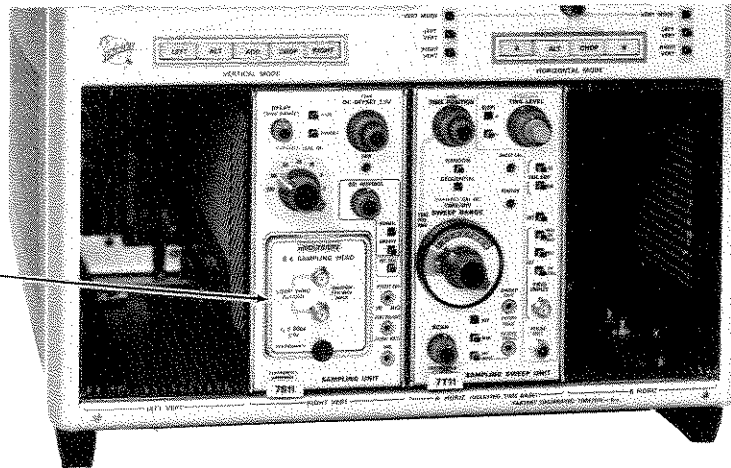

(B) Installed in 7S11

S-6

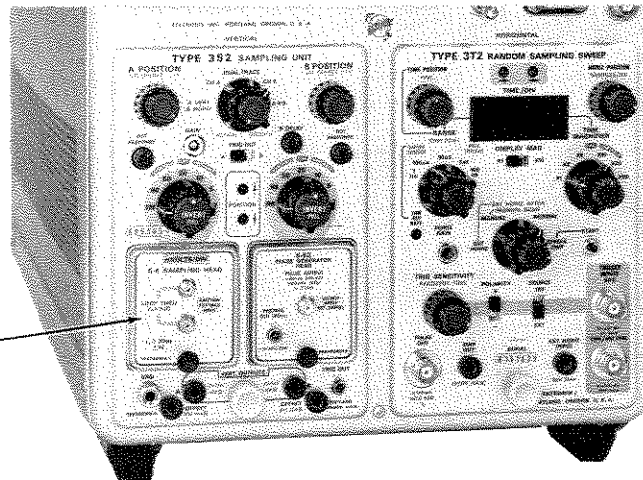

(C) Installed in a sampling head compartment of Type 3S2

112B-02

Fig. 2-1. S-6 Installation Information.

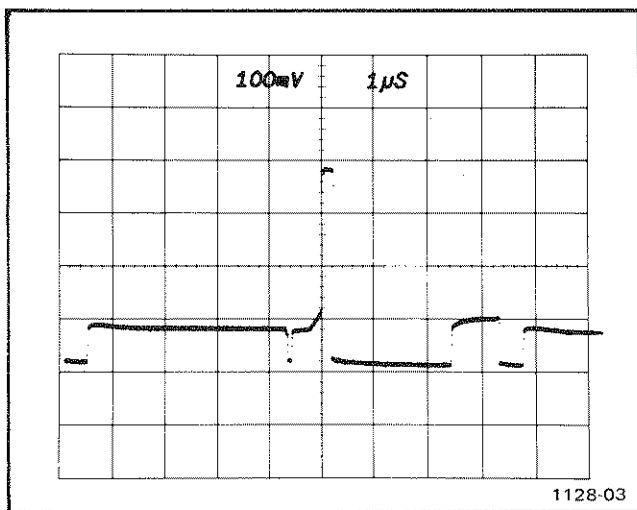

Fig. 2-2. S-52 Waveform with 7S12 X 10 Multiplier setting.

Change the 7S12 Multiplier setting to X1, and observe the S-52 output pulse. The width of the pulse top will determine the maximum time (round trip time) of the reflection that can be observed with X1.

7. To observe the leading edge of the S-52 output pulse, set the Time Distance Multiplier to X.1, and the Time/Div to any desired sweep rate up to 20 ps. Use the Time Distance knob to position the leading edge of the pulse to the center of the graticule. See Fig. 5-4 for a similar waveform.

## INPUT CONNECTIONS

### Preferred Connections

Although the LOOP THRU connectors on the S-6 front panel provide a choice of input connections, the preferred use of the connectors is shown in Fig. 2-3.

### Application Connections

Since the S-6 can be used in several sampling units, many general purpose sampling applications are possible. Fig. 2-4 shows the "Loop Thru" TDR connections with the 7S12 TDR/Sampler unit. High frequency application connections in Fig. 2-5 show the advantage of the "Loop Thru" sampling to provide a trigger signal. Use external attenuators for signals above 1 V peak to peak in general purpose sampling.

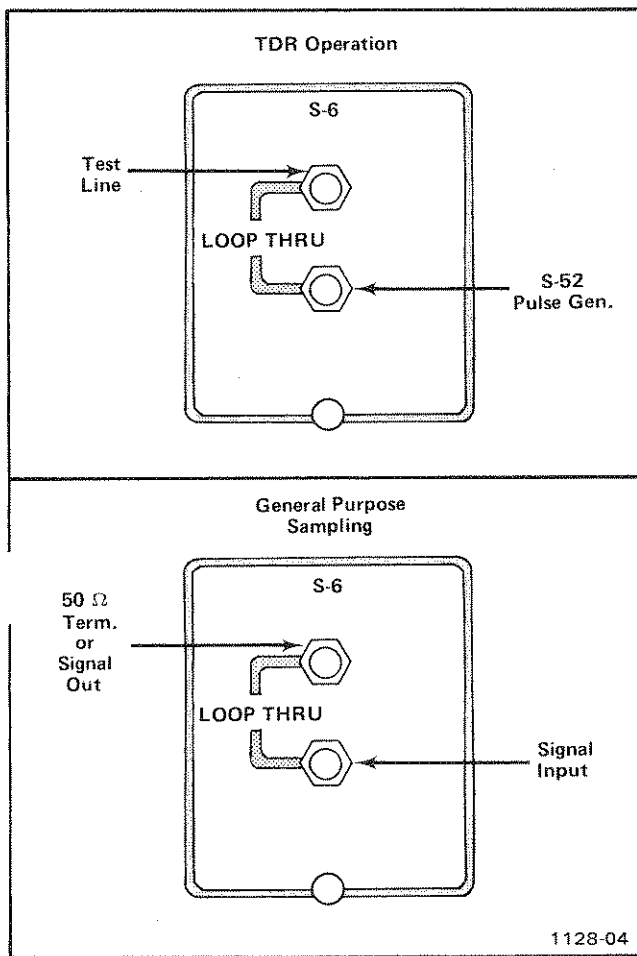

Fig. 2-3. Preferred connections to the S-6 Sampling Head.

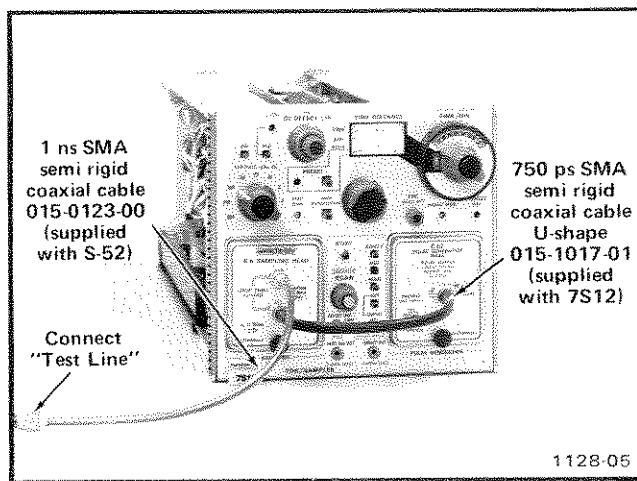

Fig. 2-4. S-6 used with 7S12 TDR/Sampler and S-52 Pulse Generation in Loop Thru TDR application.

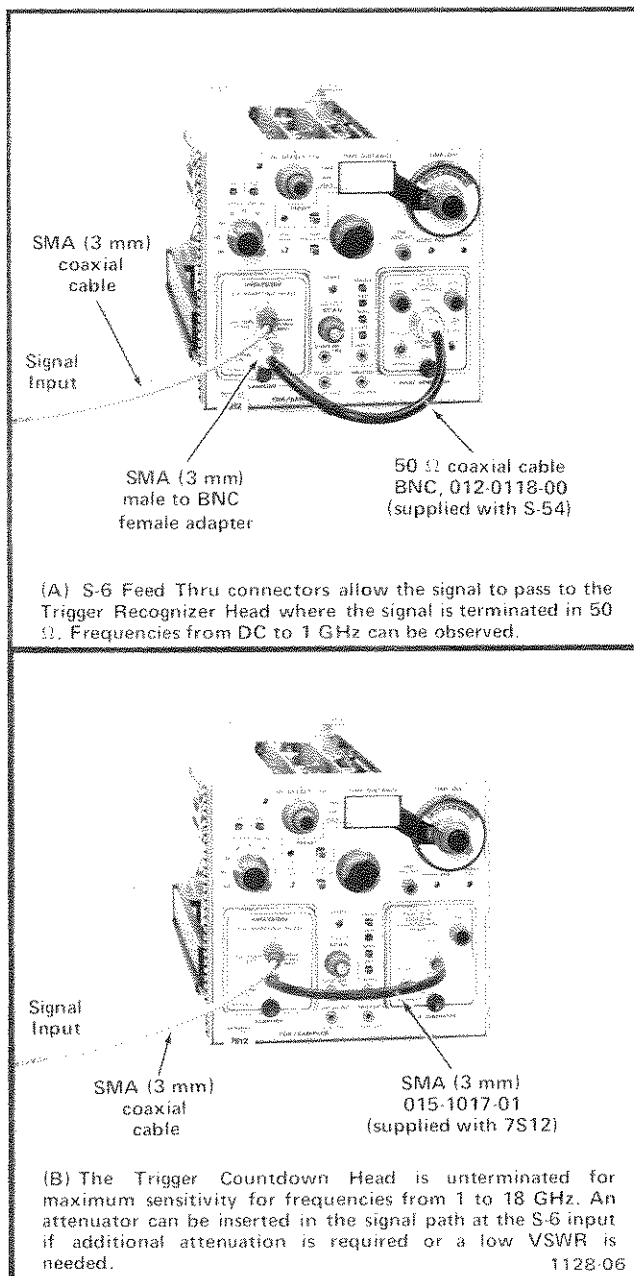
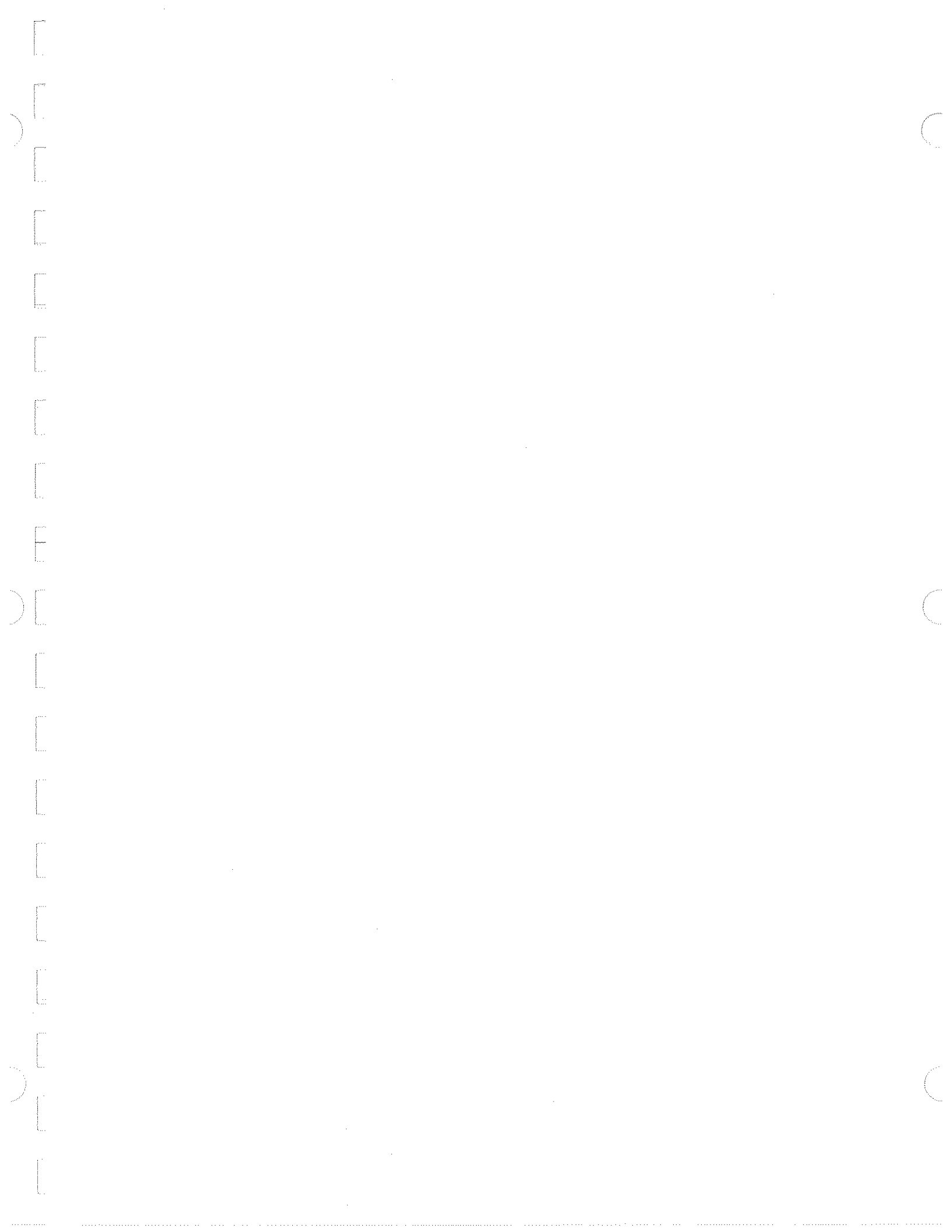

Fig. 2-5. S-6 High Frequency Signal Applications.



# THEORY OF OPERATION

## General

This section of the manual contains a block analysis of the S-6 Sampling Head followed by a detailed circuit description. The S-6 is the input signal section of the sampling system and determine the system's input characteristics. Refer to the associated sampling unit manual for interconnections and circuits referred to in this section. Refer to the schematic diagram in Section 7 as necessary.

## BLOCK DIAGRAM

The Block diagram, Fig. 3-1, shows the major circuit blocks of the S-6. A brief description of each block follows, starting with the Strobe Generator Block.

The Strobe Generator, driven by a pulse from the Strobe driver in the sampling unit, develops short-duration pulses that drive the Sampling Gate into conduction, overcoming the reverse bias applied to the gate diodes by the Gate Bias circuit.

The Gate Bias circuit applies a reverse bias to the sampling Gate diodes. The average gate bias voltage is controlled by the Gate Balance circuit and the associated sampling unit dc Offset and Feedback signals.

The Sampling Gate connects the input signal to the Pre-amplifier only during the short time when each sample is taken. The six diodes, CR10A through CR10F, form a trav-

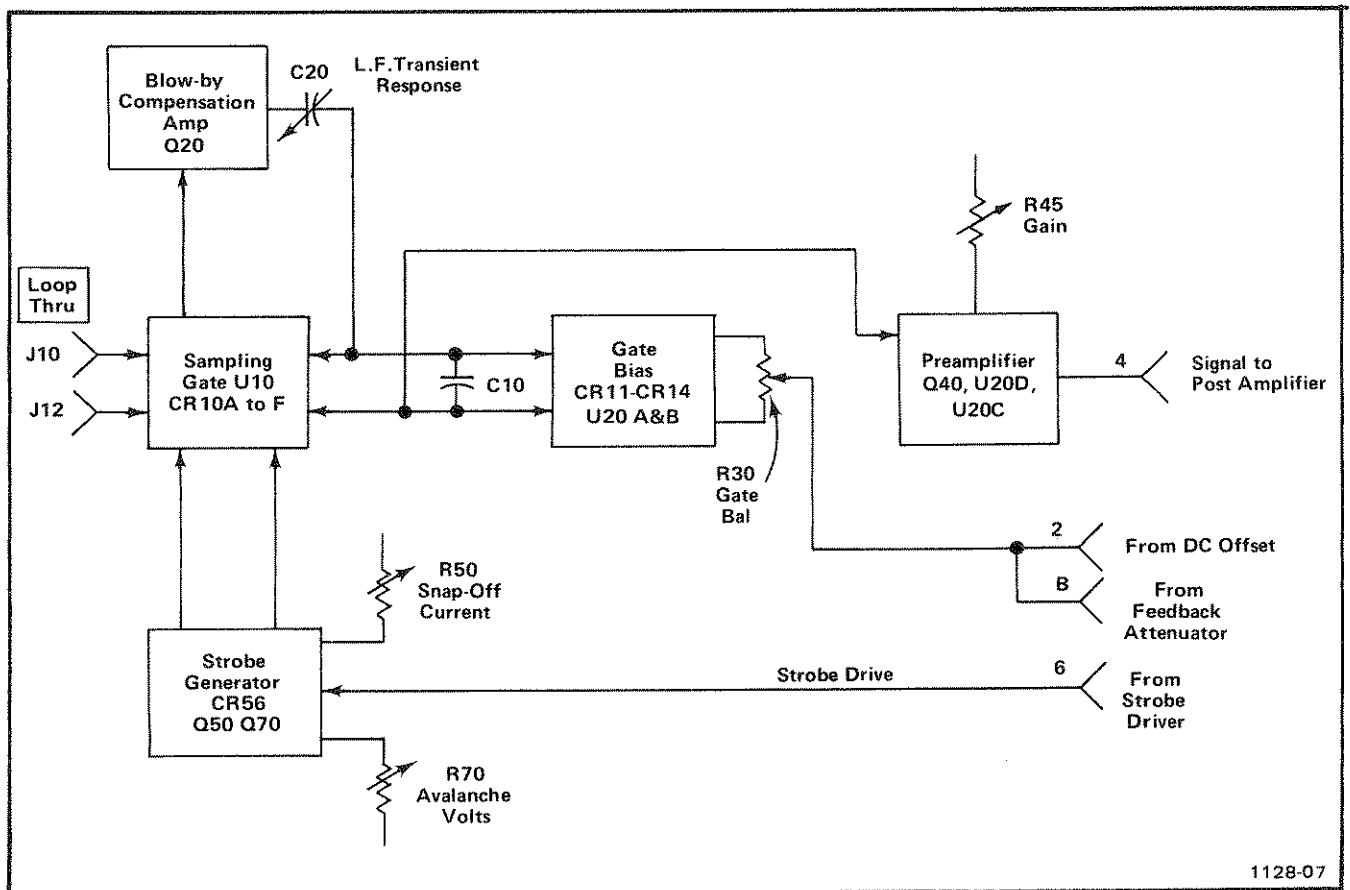

Fig. 3-1. S-6 Block Diagram.

## Theory of Operation S—6

eling wave gate. The end of the strobe drive pulse travels through the gate and determines the step response of the S-6. The step response risetime is controlled by the time taken for the strobe pulse to travel through part of the Sampling Gate.

At the end of each Strobe pulse, part of the input signal is stored temporarily between Sampling Gate diodes, and is then fed to the Preamplifier input at a rate much slower than the step response risetime.

Part of the input signal is continuously fed to the Blow-by compensating circuit, which amplifies and inverts the signal and applies it through capacitor C20 to the output side of the Sampling Gate. Magnitude of the correction signal is adjusted by C20, the LF (low frequency) Transient Response Adjustment control.

The Preamplifier circuit amplifies and slows down the signal it receives from the Sampling Gate. The signal received represents part of the difference between the input signal and the combination of feedback and dc Offset voltage. This difference signal is amplified and ac coupled to the Post Amplifier in the sampling unit. The Preamplifier gain is adjustable to aid in setting the overall sampling head and sampling unit "loop" gain to unity for proper dot response.

## CIRCUIT DESCRIPTION

### Strobe Generator

The Strobe generator contains two basic circuits; an Avalanche circuit that delivers fast pulses, and the Snap-off diode and clipping lines circuit. Both circuits work together to produce the simultaneous, opposite-polarity strobe pulses that drive the Sampling Gate through two equal transmission lines.

The Avalanche circuit converts the Strobe Drive pulses from the sampling unit to very fast pulses that drive the Snap-off diode to non-conduction.

The Strobe Drive pulse is transformer-coupled by T70 to the base and emitter of Avalanche transistor Q70. Two outputs are ac-coupled through T50 from Q70; one from the collector, and the other from the emitter. The Avalanche Volts control R70 adjusts the collector voltage of avalanche transistor Q70. The typical quiescent voltage at Q70 collector is approximately +15 V. This voltage sets the amplitude of the signals that drive the Snap-off diode circuit through T50, and assures the normal avalanche action of Q70 when it is driven by the Strobe Drive signal. Before avalanche conditions, there is a potential of approximately 60 V between Q70 collector and emitter.

The negative Strobe Drive pulse is transformer-coupled to the emitter and the base of Q70, forward biasing Q70. Normal avalanche action follows, with the collector going negative and the emitter going positive. This fast-rise, push-pull signal is transformer and capacitor coupled to the Snap-off circuit.

The Snap-off circuit operates as a current switching circuit to apply some of the push-pull, avalanche current signal at snap-off time to the Sampling Gate. The circuit consists of Snap-off Current control R50, Q50, Snap-off diode CR56, two clipping lines, and associated components. Between drive pulses from the Avalanche circuit, Snap-off diode CR56 is forward-biased by the current in Q50. The current value is set by Snap-off Current control R50. The current in CR56 is typically 20 mA.

The push-pull signals from the Avalanche circuit cause a reverse current in CR56 until the diode "snaps" open, suddenly stopping the current. At this point, the push-pull, avalanche signals are suddenly coupled into the clipping lines by C53 and C56, and toward the Sampling Gate by R57—C57 and R58—C58. The fast-rise step that appears at each clipping line input is propagated down the line. Approximately 100 ps later, the steps reach the short-circuited ends of each clipping line. The step is then reflected, equal in amplitude and opposite in polarity, back to the input end of each clipping line. This cancels the signals moving toward the Sampling Gate. This action results in a positive Strobe pulse being delivered to J16, and a negative Strobe pulse being delivered to J15. R57 and R58 act as back terminations for the strobe transmission lines and can be positioned on their respective clip lines for strobe drive balance.

### Gate Bias

Quiescent condition of the Sampling Gate diodes is controlled by the Gate Bias circuit. Sampling Gate diodes CR10A, CR10B, CR10E, and CR10F are each reverse biased approximately 0.6 V by CR11, CR13, CR14, and CR12, CR10C and CR10D are reverse biased approximately 1.2 V each. A total of 2.8 V is developed across R11 in the Gate Bias circuit. These dc bias potentials are connected to the Sampling Gate diodes by R61, R62, R10A, R10B, R10E, R10F, R13, and R14. These resistors isolate the travelling wave gate segments from the Preamplifier and the Gate Bias circuits; R13 and R14 also allow the sampled error signal to be conducted to the Preamplifier input at Q40 gate.

### Blow-by

The Blow-by Compensation circuit consists of Q20 and associated components. The capacitively-coupled signals that bypass the Sampling Gate are canceled by this circuit. A portion of the signal from the LOOP THRU input connects



through R10G to the base of Q20 and is inverted at Q20 collector. The collector signal is coupled to the output side of the Sampling Gate by C20. The signal amplitude is adjusted by C20, the LF Transient Response adjustment.

### Sampling Gate

Strobe pulses from the Strobe Generator cause the six Sampling Gate diodes to conduct for approximately 200 ps. While the diodes are conducting, the signal at the input LOOP THRU connector travels down the diode transmission paths. As the fast-falling strobe pulse edge moves into the diode transmission paths, the diodes are quickly switched off (into reverse bias), one set after another. First, diodes CR10A and CR10F turn off, then CR10B and CR10E, and finally CR10C and CR10D. The trapped charge between diodes sets CR10A and CR10F, and CR10C and CR10E is conducted through R10A, C10, and R10F to the Preamplifier circuit, Q40, gate.

### Preamplifier

The Preamplifier consists of Q40, operational amplifiers U20D and U20C, and associated components. The circuit amplifies and slows the difference signal pulse from the Sampling Bridge, and ac couples it to the Post Amplifier in the associated plug-in unit.

Input transistor Q40 operates as a very high input impedance inverting amplifier. Temperature compensation for Q40 is accomplished by thermistor RT40. A total of 4.4 mA current passes from the +50 V supply through R41, Q40, RT40, and R42 to the -50 V supply. C40 assures that Q40 ac gain is high, while its dc gain is less than 1.

Q40 output is ac coupled to operational amplifier U20D, CR40 and CR41 at the input of U20 limit the input voltage when the instrument is first turned on. The gain of U20D is set by feedback resistor R45, which adjusts the overall gain of the preamplifier. U20D is direct coupled to U20C.

The gain of U20C is set by feedback resistor R49 and input resistor R47. The low impedance output of U20C is ac coupled by C48 to the associated plug-in unit.

The Feedback Limiting circuit consists of CR94, CR97, and associated resistors. The limiting prevents excessive feedback voltage from reaching the Sampling Gate as the associated sampling Units/Div switch is changed between positions. The maximum feedback is limited to approximately  $\pm 1.2$  V by two resistive dividers and CR94 and CR97.



# PERFORMANCE CHECK & ADJUSTMENT PROCEDURES

## Introduction

This section of the manual contains the Performance Check and the Adjustment Procedures. When the Performance Check Procedure is completed, the instrument is checked to the "Performance" information given in Section 1. The tolerance and waveforms given in the Adjustment Procedure should be considered only as adjustment guides and not as instrument specifications.

The Performance Check Procedure provides a means of rapidly checking the S-6 Sampling Head without adjusting any internal controls. Failure to meet any of the require-

ments given in the procedure indicates a need for adjustment. The S-6 Sampling Head performance should be checked every 6 months or 1000 hours (whichever comes first).

## Equipment Required

The following test equipment (Table 4-1) or its equivalent is required for both the Performance Check and the Adjustment Procedure of the S-6. All test equipment must be calibrated. If other equipment is substituted, it must meet or exceed the limits in the equipment list.

**Table 4-1**  
**EQUIPMENT REQUIRED**

Description	Performance Requirements	Example
Oscilloscope		TEKTRONIX 7000-Series for component mainframe
TDR Sampler		TEKTRONIX 7S12 with S-52 Pulse Generator
Vertical Plug-in Unit		TEKTRONIX 7A16A
Time Base Plug-in Unit		TEKTRONIX 7B50A
Pulse Generator	100 mV and 1 V with 1 $\mu$ s period squarewaves	TEKTRONIX 284
Adapter (2)	SMA (3 mm) male-to-bnc female	Tektronix Part No. 015-1018-00
2X Attenuator	GR Connectors	Tektronix Part No. 017-0080-00
5X Attenuator	GR Connectors	Tektronix Part No. 017-0079-00
Adapter	GR-to-bnc female	Tektronix Part No. 017-0063-00
Coaxial Cable (2)	50 $\Omega$ bnc, 42 inches	Tektronix Part No. 012-0057-01
Attenuator	Special	Tektronix Part No. 067-0511-00
Coaxial Cable	Sma (3 mm) 1 ns Semi-rigid	Tektronix Part No. 015-1023-00
Coaxial Cable	Sma (3 mm) 3.75 ns, Semi-rigid	Tektronix Part No. 015-1017-00
Coaxial Cable	Sma (3 mm) 750 ps (U shaped)	Tektronix Part No. 015-1017-01
Adapter	Sma (3 mm) female-to-female	Tektronix Part No. 015-1012-00
Termination	Sma (3 mm), 50 $\Omega$ , male	Tektronix Part No. 015-1022-00
Termination	Short Circuit, female	Tektronix Part No. 015-1021-00

# PERFORMANCE CHECK PROCEDURES

## Check Displayed Noise

a. Install the 7S12 TDR/Sampler in the center two compartments of the oscilloscope. (Four Compartment Mainframe).

b. Install the S-6 Sampling Head in the 7S12 Sampling compartment and the S-52 in the Pulse Generator compartment.

c. Connect a 50  $\Omega$  termination to the S-6 upper LOOP THRU connector.

d. Set the controls as follows.

### 700-Series Oscilloscope

A Intensity	ccw
B Intensity	ccw
Vertical Mode	Right
Horizontal	A

### 7S12

mV	Pushed in
mV/Div	10
DC Offset	Midrange
Scan	cw
Rep	Pushed in
Time-Distance Multiplier	X10
Time/Div	1 $\mu$ s

e. Turn the oscilloscope power on. After a five minute warm up, advance the A Intensity control to display the free-running trace. Center the trace on the crt.

f. Connect a 3 mm-to-bnc female adapter to the S-6 lower LOOP THRU connector.

g. Connect, from the Type 284 Square Wave Output connector, a GR 5X attenuator, a variable attenuator, a bnc coaxial cable, and a 3 mm-to-bnc female adapter to the S-6 lower LOOP THRU connector.

h. Set the Type 284 controls as follows:

Square Wave Amplitude	100 mV
Period	1 $\mu$ s Square Wave
Mode	Square Wave

i. Obtain a display of two traces similar to Fig. 4-1A.

j. Adjust the variable attenuator to eliminate the separation between the traces and to have a maximum combined single trace width. See Fig. 4-1B.

k. Set the Type 284 Square Wave Amplitude control at 1 V. The display, similar to Fig. 4-1A, now has the equivalent of a tangential deflection factor of 1.5 mV/div.

l. Check that the bottom edges of the two traces are not more than 3.3 divisions apart (or  $E_{\text{tangential}}$  of less than 5 mV).

### NOTE

The procedure permits a noise deflection factor to be determined by dividing the input mV/div deflection factor by 2 (trace separation is 2X the RMS noise), multiplying by 3 (tangential noise is 3X the RMS noise) and then dividing by 10 (the signal amplitude change complement).

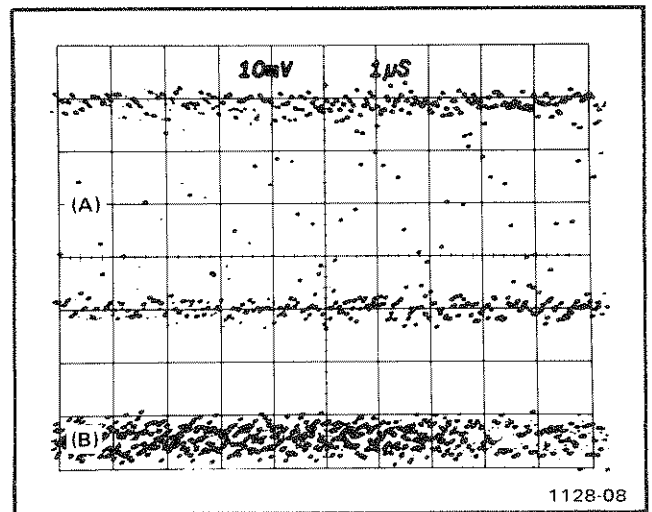

Fig. 4-1. Waveforms used to check displayed noise.

m. Remove the coaxial cable and adapter from the S-6 lower LOOP THRU connector.

## 2. Check Pulse Aberrations

a. Remove the 50  $\Omega$  termination from the Sampling Head upper connector and install a 3 mm, 1 ns, 50  $\Omega$  coaxial line

with the 50  $\Omega$  termination attached. Use a 3 mm female-to-female adapter to connect the 50  $\Omega$  termination to the coaxial line.

b. Connect a U-shaped 3 mm coaxial line from the S-52 Pulse Output to the S-6 lower LOOP THRU connector.

c. Set the 7S12 control as follows.

Time-Distance Multiplier	X.1
Time/Div	.5 ns
Time-Distance Dial	0
Fine (Zero Set)	Display pulse step
DC Offset	Display pulse top
m $\rho$ /Div	200
m $\rho$ /Div Variable	5 div pulse

d. Set the m $\rho$ /Div switch at 50 and place the pulse step edge near the left edge of the graticule. Adjust the DC offset control to set the top of the pulse (at the 1.8 ns point from the pulse leading edge) on the graticule centerline. See Fig. 4-2.

e. Check that the aberrations are within +7%, -7%, total of 10% within 1.8 ns of the step edge.

f. Set the Time-Distance Multiplier at X1, set the Time/Div switch at 50 ns, and turn the Time-Distance and Fine (Zero Set) controls fully clockwise.

g. Place the top of the pulse on the graticule centerline. Use the portion of the pulse that is 300 ns (6 div) from the start of the pulse for the reference level.

h. Set the Time-Distance Multiplier at X.1 and the Time/Div switch at 500 ps. Adjust the Time-Distance control to position the point that is 2.5 ns from the start of the pulse at the graticule center.

i. Check that the aberrations are within +2%, -2%, total of 4% after 2.5 ns of the pulse edge. See Fig. 4-2.

### 3. Check Pulse Risetime

a. Remove the 50  $\Omega$  termination with the adapter and install a 3 mm female short-circuit termination on the end of the coaxial line.

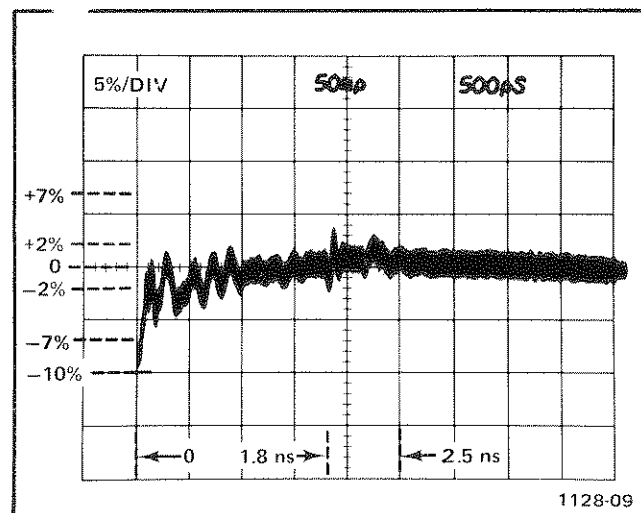

Fig. 4-2. Pulse aberrations of the S-6, S-52 and 7S12 system.

b. Set the 7S12 control as follows.

m $\rho$ /Div	200
Time/Div	20 ps
Time/Distance Dial	Display incident pulse

c. Adjust the m $\rho$ /Div Variable control so that the 0% and the 100% levels of the incident pulse are 5 div apart. Use the following procedure to locate the 0% (100% is in parenthesis) level for the incident or reflected pulse. This procedure is necessary whenever a level is not clearly defined.

1. Find the knee reference point at the start (end) of the step where the rate of change of the slope is maximum (the radius of curvature is least). See Fig. 4-3 for this waveform.

2. At a distance of one risetime before (after) the knee reference point in part 1, place the center of a zone that is one risetime in width. The S-6, S-52 and 7S12 system risetime is 35 ps.

3. Determine the average level of the waveform within the zone and use it for the 0% (100%) reference level.

d. Check that the incident pulse risetime from the 10% level to the 90% level is 35 ps or less.

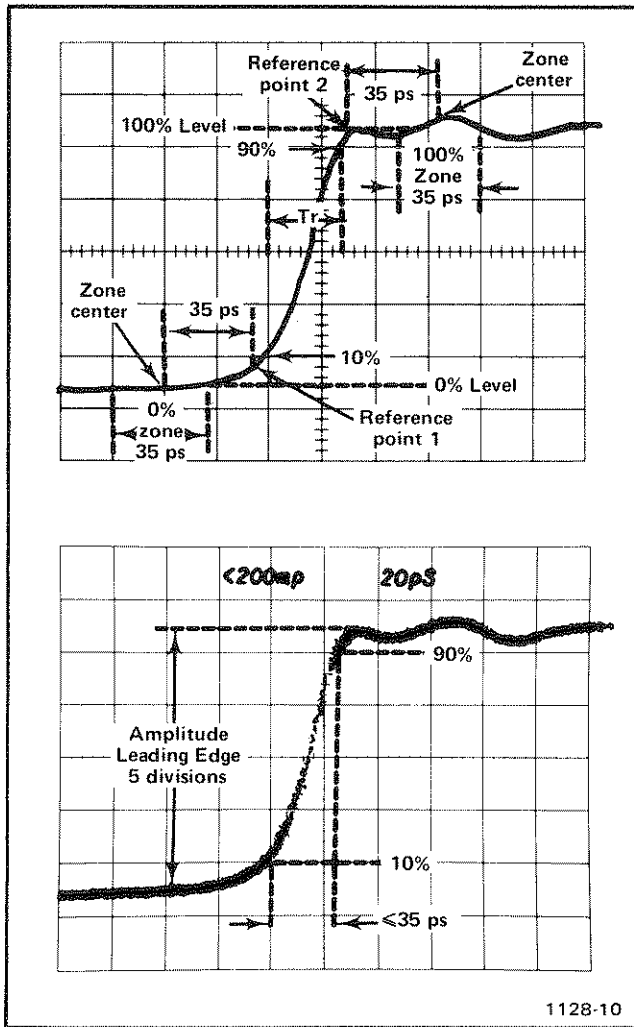

Fig. 4-3. Incident pulse risetime of the S-6, S-52 and 7S12 system.

e. Display the reflected pulse and adjust the  $m\rho/\text{Div}$  Variable control so that the 100% level and the 0% level are 5 div apart. Use the part c procedure to establish the two levels. The 100% level is the start (top) and the 0% level is the end (bottom) of the pulse. The system reflected pulse risetime (actually a falltime) of 45 ps is to be used for the zone widths to establish the 0% and 100% levels.

f. Check that the reflected pulse risetime from the 90% level to the 10% level is 45 ps or less. See Fig. 4-4 for this waveform.

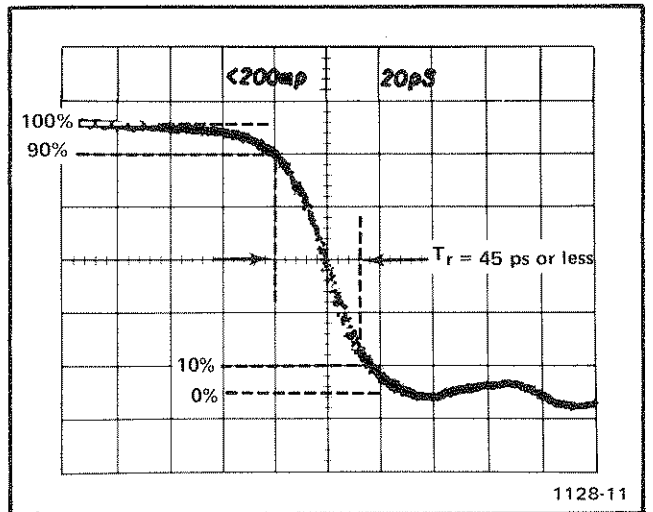

Fig. 4-4. Reflected pulse risetime of the S-6, S-52 and 7S12 system.

# ADJUSTMENT PROCEDURE

## Preliminary Procedure

1. Assemble the equipment as follows. Install the 7S12 in the center compartments of the 7000-Series indicator oscilloscope. Install the Sampling Head Extender into the 7S12 Sampling compartment, and the S-52 in the Pulse Generator compartment. Install the 7A16A with P6053 10X probe into the oscilloscope Left Vertical compartment and the 7B50A into the B Horiz compartment.

2. Remove the S-6 from its housing and install it on the Sampling Head Extender.

3. Set the controls as follows.

### 7S12

Time Distance Dial	0
Time Distance Multiplier	X.1
Time/Div	500 ps
Fine (Zero Set)	Fully clockwise
Rep	Pushed in
Scan	Midrange
mp/div	200
DC Offset	Midrange

### 7A16A

Bandwidth	20 MHz
Polarity	+Up
Position	Midrange
Volts/Div	1 V (10 V with probe)
Coupling	DC

### 7B50A

Display Mode	Time Base
Time/Div	10 $\mu$ s
Time/Div Magnifier	X1
Level/Slope	3 o'clock
Triggering	
Mode	p-p Auto
Coupling	AC
Source	Internal
Position	Midrange

4. Turn the oscilloscope Power on. After about a 20 minute warmup time, advance the B Intensity until a free-running trace is observed. Center the trace on the crt with the 7A16A and the 7B50A Position controls.

## 1. Adjust Avalanche Volts (R70) and Snap-off Current (R50).

a. Connect a 750 ps, 3 mm, Semi-rigid coaxial cable from the S-52 Pulse Output to the lower S-6 connector.

b. Connect a 1 ns, 3 mm, semi-rigid coaxial cable with a 3 mm, 50  $\Omega$  terminator at the far end, to the upper S-6 connector.

c. Position the leading edge of the pulse on screen with the 7S12 Time Distance Control. Adjust for a 5 div signal.

d. Adjust R70 (Avalanche Volts) for the best front corner, as shown in Fig. 4-6.

e. Adjust R50 (Snap-off Current) for no double strobing, lowest noise, and minimum aberrations. There will be some interaction with the adjustment of R50. See Fig. 4-5.

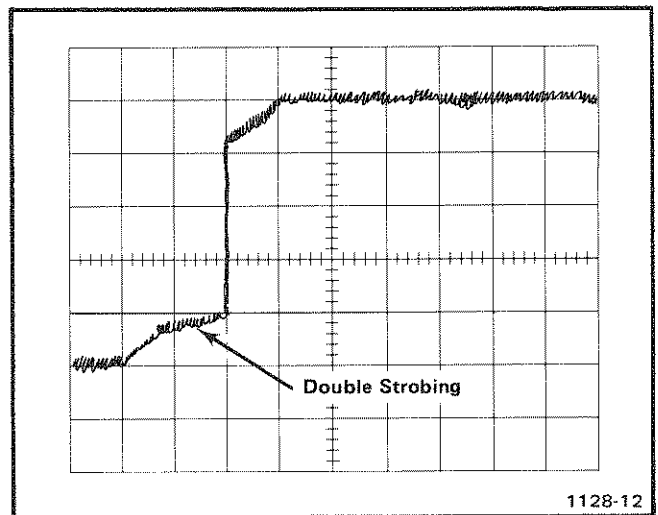

Fig. 4-5. Double Strobing example.

## 2. Adjust LF Transient Response (C20)

a. Set the following controls.

### 7S12

mV/Div	100
Time Distance Multiplier	X.10
Time/Div	100 ns

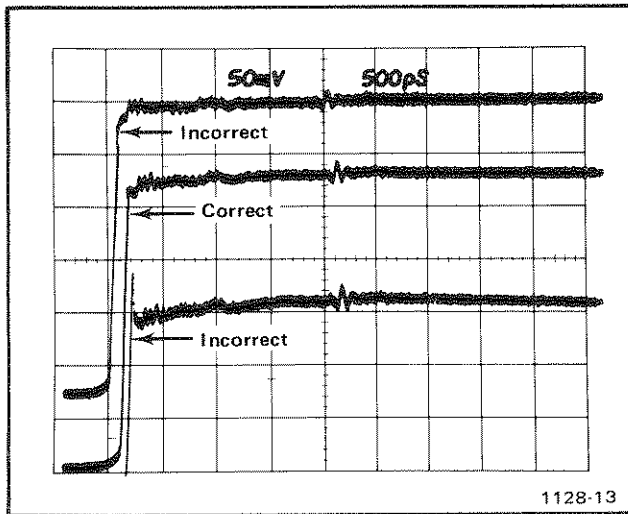

Fig. 4-6. Triple exposure to show correct adjustment of Snap-off Current control R50.

b. Adjust LF Transient Response control C20 for a flat top pulse. See Fig. 4-7.

### 3. Adjust Dot Transient Response (R45)

a. Adjust Dot Transient Response control R45 so that the first dots on the leading edge of the pulse top do not appear above or below the pulse top. See Fig. 4-7.

### 4. Adjust Gate Bal (R300)

a. Disconnect the semi-rigid coaxial cable from the S-52 Pulse Output connector.

b. Pull the 7S12 from the oscilloscope to expose the Correction Memory On-Normal-Off switch (S901) and push the switch to its Off (rear) position. The switch is located near the top rear edge of the Horizontal (right) card.

c. Install the 7S12 in the oscilloscope, but do not reconnect the coaxial line to the S-52 Pulse Output connector.

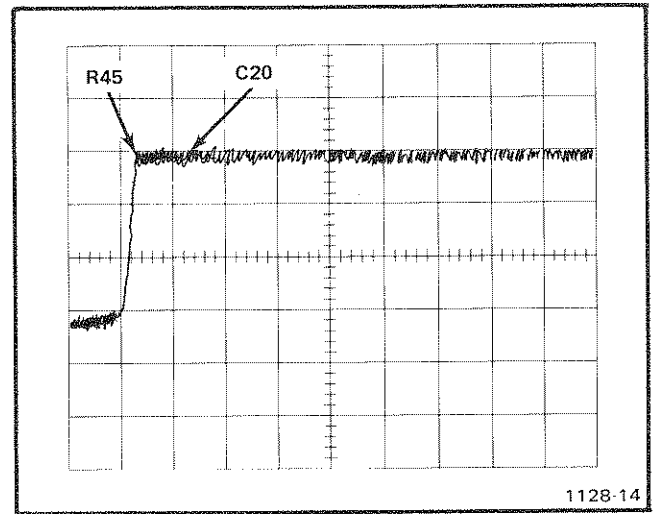

Fig. 4-7. Typical pulse waveform showing correct adjustment of LF Transient Response control C20 and Dot Transient Response control R45.

d. Push the oscilloscope Left Vert Mode switch and set the 7A16A controls as follows.

20 mV/Div	200 with 10X probe
DC	Pushed in

e. Adjust the 7S12 DC Offset control for 0 V at the DC Offset jack, as measured with the probe.

f. Push the oscilloscope Right Vert Mode switch.

g. Adjust the Gate Bal control (R30) for no trace shift when the 7S12 mv/Div switch is rotated from 500 to 10.

h. Reset the 7S12 Correction Memory switch (S901) to the Normal (middle) position.

This completes the Adjustment Procedure of the S-6 Sampling Head.



# MAINTENANCE

## Introduction

This section of the manual is a maintenance guide for the S-6 Sampling Head. Information is included for parts ordering, parts removal and replacement, disassembly, and assembly.

## Obtaining Replacement Parts

All parts used in the S-6 may be purchased directly through your local Tektronix Field Office or representative. However, replacements for standard electronic items may be obtained locally. Consult the Electrical or Mechanical Parts list to determine the value, tolerance, and rating required.

### NOTE

*When selecting replacement parts, it is important to remember that the physical size and shape of a component may affect its performance at high frequencies. After repair, the S-6 Sampling Head may require readjustment.*

## Parts Removal and Replacement

**Housing and Rear Panel.** To remove the S-6 from its housing, loosen the three retaining screws on the rear panel. Slide the rear panel off, and remove the housing by sliding it on the rear. With the housing and rear panel removed, the unit may be connected to an extender cable for access to adjustment controls and circuit test points for adjustment. Two lengths of extender cables are available from your local Tektronix Field Office or representative. Order by Tektronix Part No. 012-0124-00 for the three-foot length and Tektronix Part No. 012-0125-00 for the six-foot length extender cable.

To install the S-6 in its housing, align the body so that the hole in the side will appear over the Bridge Bal control at the rear of the Preamp board.

Check that the upper and lower corners of the Timing board are aligned with the channels in the housing that contain the zigzag springs. Push the S-6 gently into the housing until it contacts the front panel. Be sure that the white plastic pawl in the locking knob is properly aligned as the S-6 is slid into the housing. In attaching the rear casting, be sure that the hole at one side of the casting is at the bottom of the S-6. Insert the three long mounting bolts and tighten them securely. To ensure that the mounting bolts align with

the front panel hold the S-6 in its normal horizontal position; start the lower bolts, then turn the S-6 over and start the remaining two bolts.

**Circuit Boards and Hybrid Gate Assembly.** For reference in disassembly or assembly of the S-6, refer as necessary to the circuit board component location photos in Section 8, and the Exploded mechanical drawing in Section 9.

The Preamp board may be removed by pulling it directly away from the center Sampler board and hybrid gate assembly.

To remove the Sampler board, A-3, use a philips screwdriver to remove the three bolts holding the board to the Sampler Hybrid Gate Assembly, A-2, then pull the board outward from the Strobe board, A-1.

To remove the Strobe board, A-1, from the Sampler Hybrid Gate Assembly, A-2, use a 5/16-inch end wrench to disconnect both coaxial connectors, then remove the board. (To avoid strain on the circuit board and the connectors, loosen the connectors in equal increments.)

To remove the Sampler Hybrid Gate Assembly, A-2, from the front panel, use a 5/16-inch wrench to remove the two nuts on the front-panel connectors, then remove the assembly. The assembly female 3 mm coaxial connectors may be replaced by using a small wrench on the flat portion of the connector to remove and replace a connector from the assembly.

To install, reverse the procedure, being careful to align the interconnecting pins to their mating connectors when installing the board assemblies.

## Troubleshooting

As an aid to troubleshooting, use the troubleshooting conditions listed on the schematic diagram page in Section 8. A preliminary condition is to determine if the sampling unit is providing proper power and strobe pulse to the S-6. Use the waveforms to help isolate the defective circuit. For information on the circuit Operation in the S-6, refer to the Theory of Operation, Section 3. It is recommended that U20 be replaced first, before attempting to replace the hybrid gate assembly.

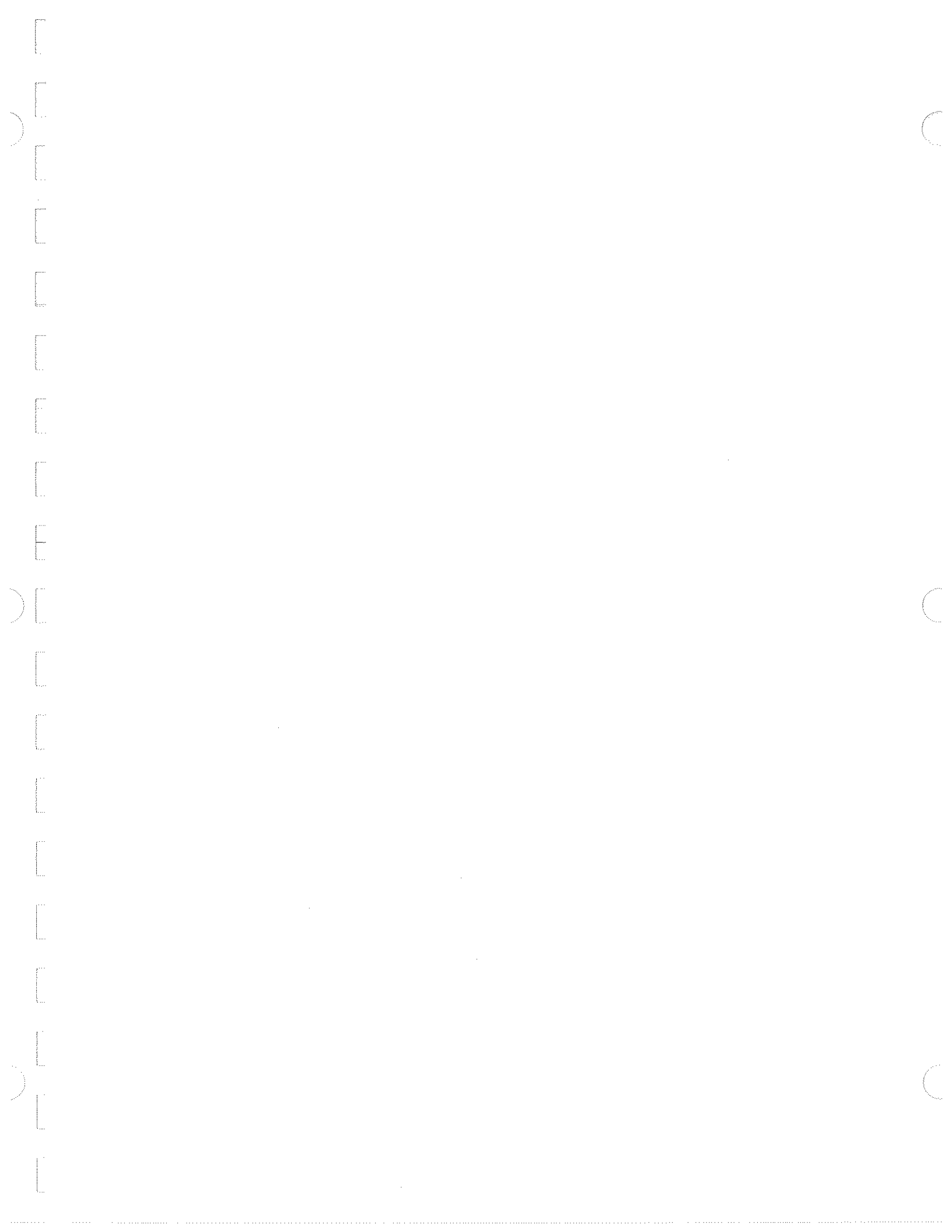

# OPTIONS

There are no options for the S-6 at this time.

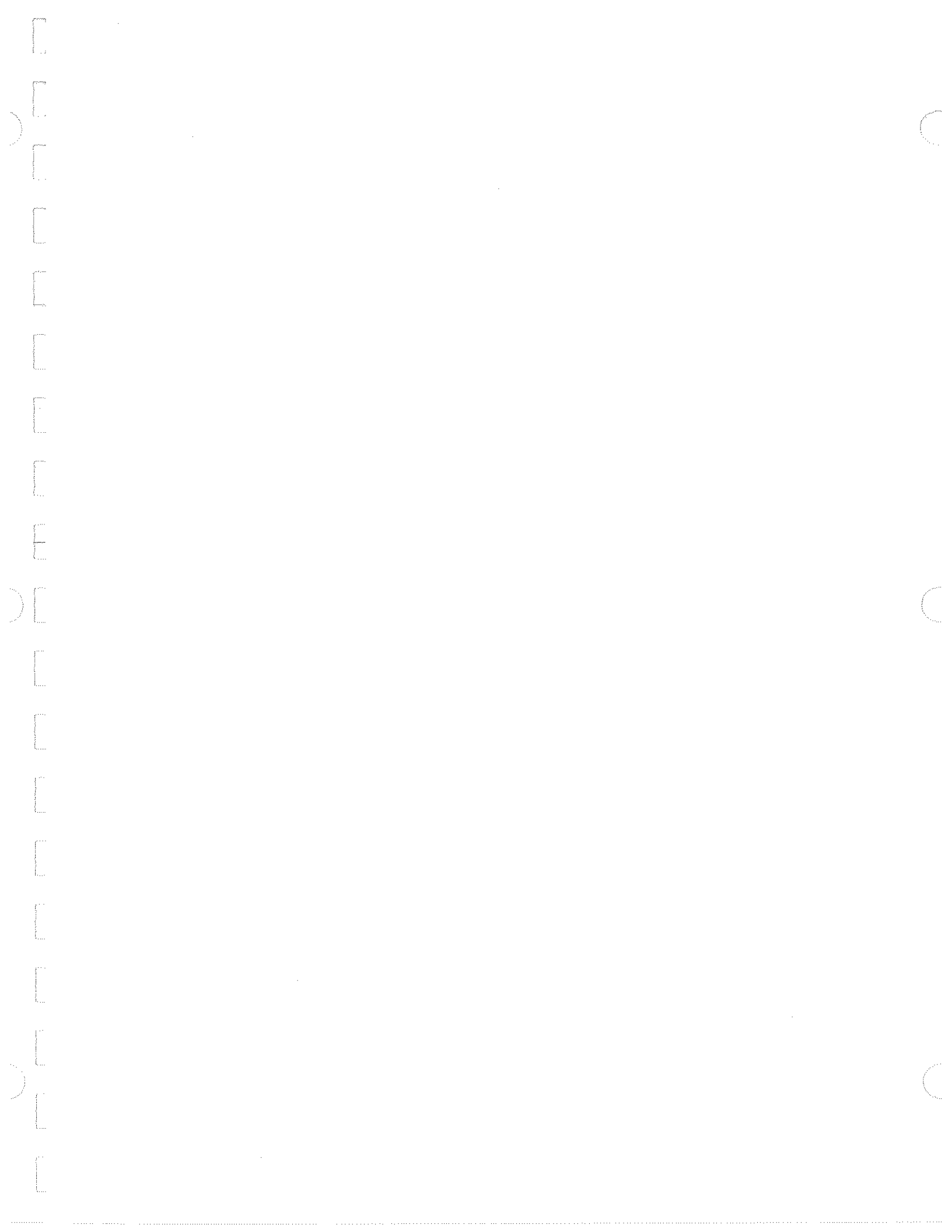

# REPLACEABLE ELECTRICAL PARTS

## PARTS ORDERING INFORMATION

Replacement parts are available from or through your local Tektronix, Inc. Field Office or representative.

Changes to Tektronix instruments are sometimes made to accommodate improved components as they become available, and to give you the benefit of the latest circuit improvements developed in our engineering department. It is therefore important, when ordering parts, to include the following information in your order: Part number, instrument type or number, serial number, and modification number if applicable.

If a part you have ordered has been replaced with a new or improved part, your local Tektronix, Inc. Field Office or representative will contact you concerning any change in part number.

Change information, if any, is located at the rear of this manual.

## SPECIAL NOTES AND SYMBOLS

X000 Part first added at this serial number  
00X Part removed after this serial number

## ITEM NAME

In the Parts List, an Item Name is separated from the description by a colon (:). Because of space limitations, an Item Name may sometimes appear as incomplete. For further Item Name identification, the U.S. Federal Cataloging Handbook H6-1 can be utilized where possible.

## ABBREVIATIONS

ACTR	ACTUATOR	PLSTC	PLASTIC
ASSY	ASSEMBLY	QTZ	QUARTZ
CAP	CAPACITOR	RECP	RECEPTACLE
CER	CERAMIC	RES	RESISTOR
CKT	CIRCUIT	RF	RADIO FREQUENCY
COMP	COMPOSITION	SEL	SELECTED
CONN	CONNECTOR	SEMICOND	SEMICONDUCTOR
ELCTLT	ELECTROLYTIC	SENS	SENSITIVE
ELEC	ELECTRICAL	VAR	VARIABLE
INCAND	INCANDESCENT	WW	WIREWOUND
LED	LIGHT EMITTING DIODE	XFMR	TRANSFORMER
NONWIR	NON WIREWOUND	XTAL	CRYSTAL

CROSS INDEX - MFR. CODE NUMBER TO MANUFACTURER

Mfr. Code	Manufacturer	Address	City, State, Zip Code
01121	ALLEN-BRADLEY CO	1201 SOUTH 2ND ST	MILWAUKEE WI 53204
03508	GENERAL ELECTRIC CO SEMI-CONDUCTOR PRODUCTS DEPT	W GENESEE ST	AUBURN NY 13021
03888	KDI PYROFILM CORP	60 S JEFFERSON RD	WHIPPANY NJ 07981
04222	AVX CERAMICS DIV OF AVX CORP	19TH AVE SOUTH P O BOX 867	MYRTLE BEACH SC 29577
04713	MOTOROLA INC SEMICONDUCTOR GROUP	5005 E MCDOWELL RD	PHOENIX AZ 85008
05397	UNION CARBIDE CORP MATERIALS SYSTEMS DIV	11901 MADISON AVE	CLEVELAND OH 44101
07263	FAIRCHILD CAMERA AND INSTRUMENT CORP SEMICONDUCTOR DIV	464 ELLIS ST	MOUNTAIN VIEW CA 94042
14193	CAL-R INC	1601 OLYMPIC BLVD	SANTA MONICA CA 90404
14552	MICRO/SEMICONDUCTOR CORP	2830 S FAIRVIEW ST	SANTA ANA CA 92704
15454	AMETEK INC RODAN DIV	2905 BLUE STAR ST	ANAHEIM CA 92806
15801	FENWAL ELECTRONICS DIV OF KIDDE WALTER AND CO INC	63 FOUNTAIN ST	FRAMINGHAM MA 01701
19701	MEPCO/ELECTRA INC A NORTH AMERICAN PHILIPS CO	P O BOX 760	MINERAL WELLS TX 76067
26805	OMNI SPECTRA INC MICROWAVE CONNECTOR DIV	140 FOURTH AVE	WALTHAM MA 02154
32997	BOURNS INC TRIMPOT DIV	1200 COLUMBIA AVE	RIVERSIDE CA 92507
50101	FREQUENCY SOURCES INC GHZ DIV	16 MAPLE RD	SOUTH CHELMSFORD MA 01824
57668	ROHM CORP	16931 MILLIKEN AVE	IRVINE CA 92713
59660	TUSONIX INC	2155 N FORBES BLVD	TUCSON, ARIZONA 85705
72982	ERIE TECHNOLOGICAL PRODUCTS INC	645 W 11TH ST	ERIE PA 16512
73138	BECKMAN INSTRUMENTS INC HELIPOT DIV	2500 HARBOR BLVD	FULLERTON CA 92634
80009	TEKTRONIX INC	4900 S W GRIFFITH DR P O BOX 500	BEAVERTON OR 97077
91418	RADIO MATERIALS CORP	4242 BYRN MAWR AVE W	CHICAGO IL 60646
91637	DALE ELECTRONICS INC	P O BOX 609	COLUMBUS NE 68601
TK1345	ZMAN AND ASSOCIATES	7633 S 180TH	KENT WA 98032

Component No.	Tektronix Part No.	Serial/Assembly No. Effective	Discont	Name & Description	Mfr. Code	Mfr. Part No.
A1	670-1403-00	B010100	B029999	CIRCUIT BD ASSY:STROBE	80009	670-1403-00
A1	670-1403-01	B030000	B039999	CIRCUIT BD ASSY:STROBE	80009	670-1403-01
A1	670-1403-03	B040000		CIRCUIT BD ASSY:STROBE	80009	670-1403-03
A2	155-0053-00	B010100	B044659	HYBRID CIRCUIT:HYBRID	80009	155-0053-00
A2	119-2418-00	B044660		HYBRID ASSEMBLY:SAMPLING GATE S6	80009	119-2418-00
A3	670-1404-00			CIRCUIT BD ASSY:SAMPLER	80009	670-1404-00
A4	670-1402-00	B010100	B029999	CIRCUIT BD ASSY:PREAMP	80009	670-1402-00
A4	670-1402-01	B030000		CIRCUIT BD ASSY:PREAMP	80009	670-1402-01
A1	670-1403-00	B010100	B029999	CIRCUIT BD ASSY:STROBE	80009	670-1403-00
A1	670-1403-01	B030000	B039999	CIRCUIT BD ASSY:STROBE	80009	670-1403-01
A1	670-1403-03	B040000		CIRCUIT BD ASSY:STROBE	80009	670-1403-03
A1C50	290-0134-00			CAP, FXD, ELCTLT:22UF, 20%, 15V	05397	T110B226M015AS
A1C52	283-0121-00			CAP, FXD, CER DI:1000PF, 20%, 200V	91418	5P102M2011958
A1C53	283-0135-00			CAP, FXD, CER DI:100PF, 5%, 500V	91418	JK101J501959
A1C54	283-0139-00			CAP, FXD, CER DI:150PF, 20%, 50V	05397	C312C151M565CA
A1C55	283-0139-00			CAP, FXD, CER DI:150PF, 20%, 50V	05397	C312C151M565CA
A1C56	283-0135-00			CAP, FXD, CER DI:100PF, 5%, 500V	91418	JK101J501959
A1C57	283-0154-00			CAP, FXD, CER DI:22PF, 5%, 50V	04222	SR155A220JAA
A1C58	283-0154-00			CAP, FXD, CER DI:22PF, 5%, 50V	04222	SR155A220JAA
A1C73	283-0121-00			CAP, FXD, CER DI:1000PF, 20%, 200V	91418	5P102M2011958
A1C77	283-0121-00			CAP, FXD, CER DI:1000PF, 20%, 200V	91418	5P102M2011958
A1CR56	152-0335-00	B010100	B039999	SEMICON DVC, DI:SNAP-OFF, SI	80009	152-0335-00
A1CR56	152-0335-01	B040000		SEMICON DVC, DI:SNAP-OFF, SI, 40V, DO-35	50101	GC20279
A1L50	120-0382-00			COIL, RF:210UH, +28%-43%, 14 TURNS	80009	120-0382-00
A1P15	131-1083-00			CONN, RCPT, ELEC:3MM, MALE RIGHT ANGLE	26805	2065-5001-00
A1P16	131-1083-00			CONN, RCPT, ELEC:3MM, MALE RIGHT ANGLE	26805	2065-5001-00
A1Q50	151-0224-00			TRANSISTOR: NPN, SI, T0-92	04713	SPS6917
A1Q70	153-0556-00			TRANSISTOR: SELECTED	04713	SPS8830
A1R50	311-0607-00			RES, VAR, NONNW: TRMR, 10K OHM, 0.5W	73138	82-25-2
A1R52	308-0243-00			RES, FXD, WW: 240 OHM, 5%, 3W	14193	SA31-2400J
A1R54	317-0390-00			RES, FXD, CMPSN: 39 OHM, 5%, 0.125W	01121	BB3905
A1R55	317-0390-00			RES, FXD, CMPSN: 39 OHM, 5%, 0.125W	01121	BB3905
A1R56	317-0510-00			RES, FXD, CMPSN: 51 OHM, 5%, 0.125W	01121	BB5105
A1R57	317-0430-00			RES, FXD, CMPSN: 43 OHM, 5%, 0.125W	01121	BB4305
A1R58	317-0430-00			RES, FXD, CMPSN: 43 OHM, 5%, 0.125W	01121	BB4305
A1R61	317-0103-00			RES, FXD, CMPSN: 10K OHM, 5%, 0.125W	01121	BB1035
A1R62	317-0103-00	B010100	B029999	RES, FXD, CMPSN: 10K OHM, 5%, 0.125W	01121	BB1035
A1R62	317-0822-00	B030000		RES, FXD, CMPSN: 8.2K OHM, 5%, 0.125W	01121	BB8225
A1R70	311-0644-00			RES, VAR, NONNW: TRMR, 20K OHM, 0.5W	32997	3329H-G48-203
A1R72	317-0332-00			RES, FXD, CMPSN: 3.3K OHM, 5%, 0.125W	01121	BB3325
A1R73	317-0101-00			RES, FXD, CMPSN: 100 OHM, 5%, 0.125W	01121	BB1015
A1R76	317-0332-00			RES, FXD, CMPSN: 3.3K OHM, 5%, 0.125W	01121	BB3325
A1R77	317-0202-00			RES, FXD, CMPSN: 2K OHM, 5%, 0.125W	01121	BB2025
A1R78	315-0203-00			RES, FXD, FILM: 20K OHM, 5%, 0.25W	57668	NTR25J-E 20K
A1RT51	307-0127-00	B010133		RES, THERMAL: 1K OHM, 10%	15801	JB-31J42
A1RT79	307-0124-00			RES, THERMAL: 5K OHM, 10%, NTC	15454	1DC502K-220-EC
A1T50	120-0318-00			XFMR, TOROID:	TK1345	120-0318-00
A1T70	120-0544-00			XFMR, TOROID:	80009	120-0544-00
A1VR18	152-0279-00	B030000		SEMICON DVC, DI:ZEN, SI, 5.1V, 5%, 0.4W, DO-7	14552	TD3810989
A2	155-0053-00	B010100	B044659	HYBRID CIRCUIT:HYBRID	80009	155-0053-00
A2	119-2418-00	B044660		HYBRID ASSEMBLY:SAMPLING GATE S6	80009	119-2418-00

Replaceable Electrical Parts - S-6

Component No.	Tektronix Part No.	Serial/Assembly No. Effective	Dscont	Name & Description	Mfr. Code	Mfr. Part No.
A2CR10	-----			(PART OF A2)		
A2J10	-----			(PART OF A2)		
A2J12	-----			(PART OF A2)		
A2J15	-----			(PART OF A2)		
A2J16	-----			(PART OF A2)		
A2R10	-----			(PART OF A2)		
A2U10	-----			(PART OF A2)		
A3	670-1404-00			CIRCUIT BD ASSY:SAMPLER	80009	670-1404-00
A3CR97	152-0141-02			SEMICON DVC,DI:SW,SI,30V,150MA,30V,DO-35	03508	DA2527 (1N4152)
A3R97	317-0101-00			RES,FXD,CMPSN:100 OHM,5%,0.125W	01121	BB1015
A3R99	315-0152-00			RES,FXD,FILM:1.5K OHM,5%,0.25W	57668	NTR25J-E01K5
A4	670-1402-00	B010100	B029999	CIRCUIT BD ASSY:PREAMP	80009	670-1402-00
A4	670-1402-01	B030000		CIRCUIT BD ASSY:PREAMP	80009	670-1402-01
A4C10	290-0188-00			CAP,FXD,ELCTLT:0.1UF,10%,35V	05397	T322A104K035AS
A4C11	283-0177-00			CAP,FXD,CER DI:1UF,+80-20%,25V	04222	SR302E105ZAATR
A4C12	283-0177-00			CAP,FXD,CER DI:1UF,+80-20%,25V	04222	SR302E105ZAATR
A4C13	283-0135-00			CAP,FXD,CER DI:100PF,5%,500V	91418	JK101J501959
A4C14	283-0135-00			CAP,FXD,CER DI:100PF,5%,500V	91418	JK101J501959
A4C20	281-0122-00			CAP,VAR,CER DI:2.5-9PF,100V	59660	518-000A2.5-9
A4C23	283-0167-00			CAP,FXD,CER DI:0.1UF,10%,100V	04222	3430-100C-104K
A4C32	283-0167-00			CAP,FXD,CER DI:0.1UF,10%,100V	04222	3430-100C-104K
A4C33	283-0167-00			CAP,FXD,CER DI:0.1UF,10%,100V	04222	3430-100C-104K
A4C34	283-0060-00			CAP,FXD,CER DI:100PF,5%,200V	59660	855-535U2J101J
A4C36	283-0060-00			CAP,FXD,CER DI:100PF,5%,200V	59660	855-535U2J101J
A4C37	283-0167-00			CAP,FXD,CER DI:0.1UF,10%,100V	04222	3430-100C-104K
A4C38	283-0167-00			CAP,FXD,CER DI:0.1UF,10%,100V	04222	3430-100C-104K
A4C40	283-0051-00			CAP,FXD,CER DI:0.0033UF,5%,100V	04222	SR301A332JAA
A4C41	283-0000-00			CAP,FXD,CER DI:0.001UF,+100-0%,500V	59660	831-610-Y5U0102P
A4C45	283-0140-00			CAP,FXD,CER DI:4.7PF,+/-0.25PF,50V	72982	8101E003A479C
A4C48	283-0238-00			CAP,FXD,CER DI:0.01UF,10%,50V	04222	SR205C103KAA
A4C91	283-0238-00			CAP,FXD,CER DI:0.01UF,10%,50V	04222	SR205C103KAA
A4C93	283-0238-00			CAP,FXD,CER DI:0.01UF,10%,50V	04222	SR205C103KAA
A4CR11	152-0333-00			SEMICON DVC,DI:SW,SI,55V,200MA,DO-35	07263	FDH-6012
A4CR12	152-0333-00			SEMICON DVC,DI:SW,SI,55V,200MA,DO-35	07263	FDH-6012
A4CR13	152-0333-00			SEMICON DVC,DI:SW,SI,55V,200MA,DO-35	07263	FDH-6012
A4CR14	152-0333-00			SEMICON DVC,DI:SW,SI,55V,200MA,DO-35	07263	FDH-6012
A4CR40	152-0141-02			SEMICON DVC,DI:SW,SI,30V,150MA,30V,DO-35	03508	DA2527 (1N4152)
A4CR41	152-0141-02			SEMICON DVC,DI:SW,SI,30V,150MA,30V,DO-35	03508	DA2527 (1N4152)
A4CR94	152-0141-02			SEMICON DVC,DI:SW,SI,30V,150MA,30V,DO-35	03508	DA2527 (1N4152)
A4Q20	151-0225-00			TRANSISTOR:NPN,SI,TO-106	04713	SPS7890
A4Q40	151-1012-00			TRANSISTOR:FET,N-CHAN,SI,TO-72	04713	SFD1012
A4R11	317-0821-00			RES,FXD,CMPSN:820 OHM,5%,0.125W	01121	BB8215
A4R12	-----			(SELECTED)		
A4R13	317-0104-00			RES,FXD,CMPSN:100K OHM,5%,0.125W	01121	BB1045
A4R14	317-0104-00			RES,FXD,CMPSN:100K OHM,5%,0.125W	01121	BB1045
A4R15	-----			(SELECTED)		
A4R16	317-0182-00	B030000		RES,FXD,CMPSN:1.8K OHM,5%,0.125W	01121	BB1825
A4R18	317-0202-00			RES,FXD,CMPSN:2K OHM,5%,0.125W	01121	BB2025
A4R21	317-0510-00			RES,FXD,CMPSN:51 OHM,5%,0.125W	01121	BB5105
A4R23	317-0332-00			RES,FXD,CMPSN:3.3K OHM,5%,0.125W	01121	BB3325
A4R30	311-0609-00			RES,VAR,NONWV:TRMR,2K OHM,0.5W	32997	3329H-L58-202
A4R32	325-0001-00			RES,FXD,FILM:100K OHM,1%,0.2W,TC=TO	03888	A3AT69
A4R34	325-0105-00			RES,FXD,FILM:4.22K OHM,1%,0.05W,TC=TO	91637	CCF50-G42200F
A4R36	325-0105-00			RES,FXD,FILM:4.22K OHM,1%,0.05W,TC=TO	91637	CCF50-G42200F
A4R38	325-0001-00			RES,FXD,FILM:100K OHM,1%,0.2W,TC=TO	03888	A3AT69



Component No.	Tektronix Part No.	Serial/Assembly No. Effective	Dscont	Name & Description	Mfr. Code	Mfr. Part No.
A4R41	301-0912-00			RES, FXD, FILM:9.1K OHM, 5%, 0.5W	19701	5053CX9K100J
A4R42	301-0103-00			RES, FXD, FILM:10K OHM, 5%, 0.50W	19701	5053CX10K00J
A4R44	317-0102-00	B010133		RES, FXD, CMPSN:1K OHM, 5%, 0.125W	01121	BB1025
A4R45	311-0607-00			RES, VAR, NONWV:TRMR, 10K OHM, 0.5W	73138	82-25-2
A4R47	317-0332-00			RES, FXD, CMPSN:3.3K OHM, 5%, 0.125W	01121	BB3325
A4R48	315-0272-00			RES, FXD, FILM:2.7K OHM, 5%, 0.25W	57668	NTR25J-E02K7
A4R49	317-0332-00			RES, FXD, CMPSN:3.3K OHM, 5%, 0.125W	01121	BB3325
A4R91	317-0473-00			RES, FXD, CMPSN:47K OHM, 5%, 0.125W	01121	BB4735
A4R93	317-0473-00			RES, FXD, CMPSN:47K OHM, 5%, 0.125W	01121	BB4735
A4R94	315-0182-00			RES, FXD, FILM:1.8K OHM, 5%, 0.25W	57668	NTR25J-E1K8
A4R96	317-0101-00			RES, FXD, CMPSN:100 OHM, 5%, 0.125W	01121	BB1015
A4RT40	307-0124-00			RES, THERMAL:5K OHM, 10%, NTC	15454	1DC502K-220-EC
A4RT43	307-0127-00	B010133		RES, THERMAL:1K OHM, 10%	15801	JB-31J42
A4U20	155-0035-00			MICROCKT, LINEAR:QUAD OPNL AMPL	80009	155-0035-00
A4VR18	152-0279-00	B010100	B029999	SEMICOND DVC, DI:ZEN, SI, 5.1V, 5%, 0.4W, DO-7	14552	TD3810989



# DIAGRAMS AND CIRCUIT BOARD ILLUSTRATIONS

## Symbols and Reference Designators

Electrical components shown on the diagrams are in the following units unless noted otherwise:

- Capacitors = Values one or greater are in picofarads (pF).  
Values less than one are in microfarads (μF).
- Resistors = Ohms (Ω).

Graphic symbols and class designation letters are based on ANSI Standard Y32.2-1975.

Logic symbology is based on ANSI Y32.14-1973 in terms of positive logic. Logic symbols depict the logic function performed and may differ from the manufacturer's data.

The overline on a signal name indicates that the signal performs its intended function when it goes to the low state.

Abbreviations are based on ANSI Y1.1-1972.

Other ANSI standards that are used in the preparation of diagrams by Tektronix, Inc. are:

- Y14.15, 1966 Drafting Practices.
- Y14.2, 1973 Line Conventions and Lettering.
- Y10.5, 1968 Letter Symbols for Quantities Used in Electrical Science and Electrical Engineering.

The following prefix letters are used as reference designators to identify components or assemblies on the diagrams.

A	Assembly, separable or repairable (circuit board, etc)	H	Heat dissipating device (heat sink, heat radiator, etc)	S	Switch or contactor
AT	Attenuator, fixed or variable	HR	Heater	T	Transformer
B	Motor	HY	Hybrid circuit	TC	Thermocouple
BT	Battery	J	Connector, stationary portion	TP	Test point
C	Capacitor, fixed or variable	K	Relay	U	Assembly, inseparable or non-repairable (integrated circuit, etc.)
CB	Circuit breaker	L	Inductor, fixed or variable	V	Electron tube
CR	Diode, signal or rectifier	M	Meter	VR	Voltage regulator (zener diode, etc.)
DL	Delay line	P	Connector, movable portion	W	Wirestrap or cable
DS	Indicating device (lamp)	Q	Transistor or silicon-controlled rectifier	Y	Crystal
E	Spark Gap, Ferrite bead	R	Resistor, fixed or variable	Z	Phase shifter
F	Fuse	RT	Thermistor		
FL	Filter				

The following special symbols may appear on the diagrams:

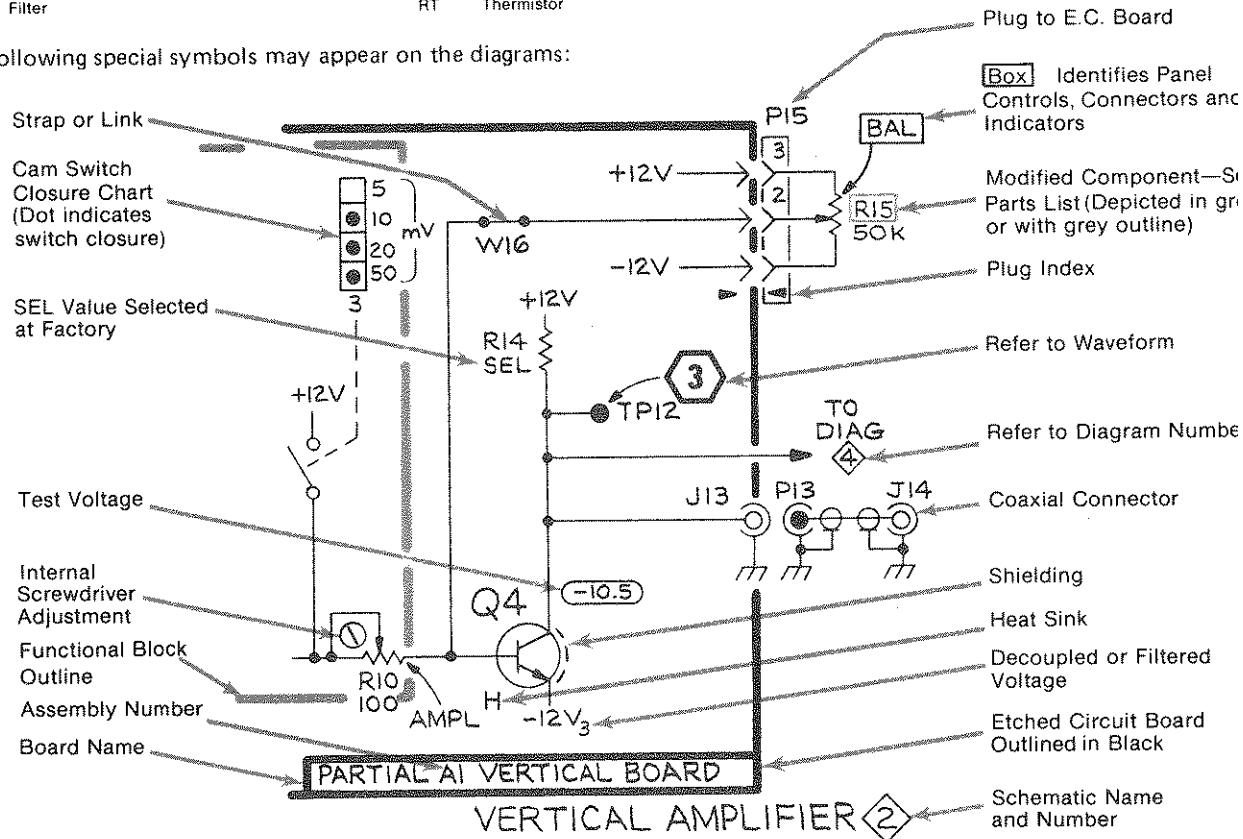

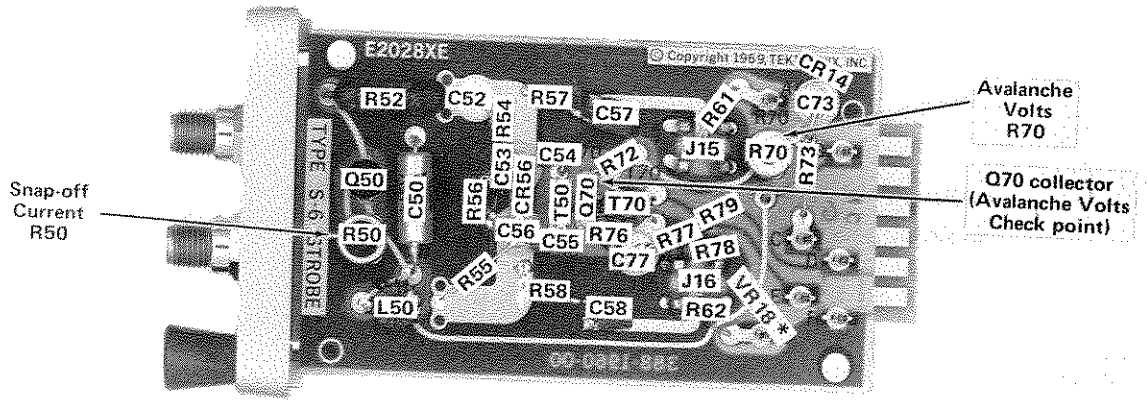

A-1 Strobe board

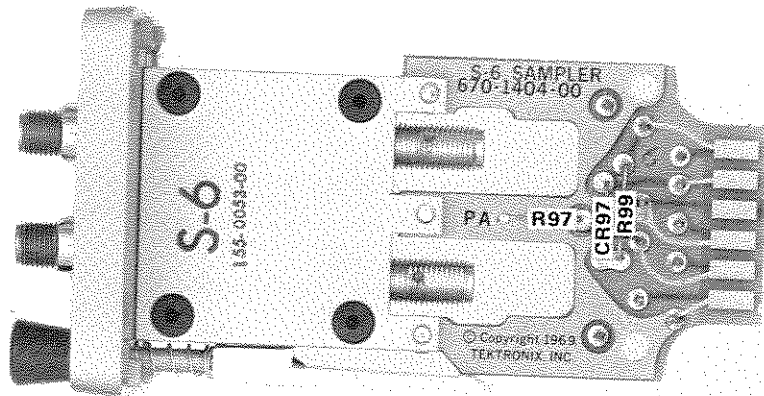

Front Panel, A-2 Hybrid Gate Assembly-Sampler, and A-3 Sampler board

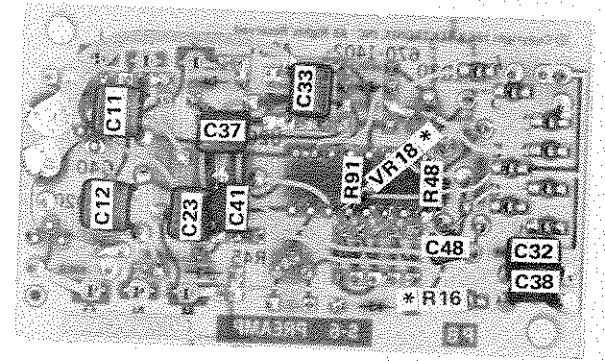
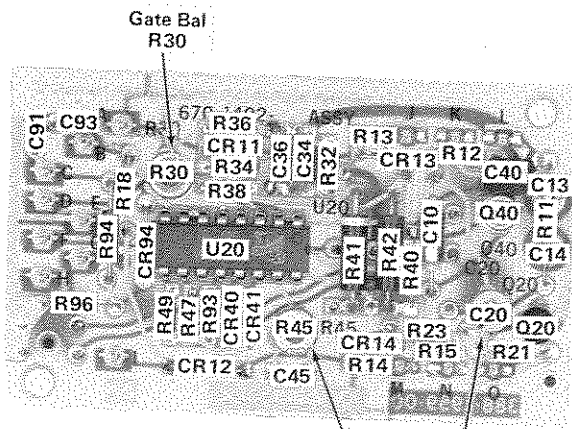

Gain R45  
L.F. Transient Response C20

\*See Parts List for serial number ranges.

A-4 Preamp board

## TROUBLESHOOTING CONDITIONS

Power for the S-6 is obtained from a Sampling Head Compartment which also provides the Strobe pulses. Use a sampling head extender so that the S-6 can be removed. Trigger the Test Oscilloscope externally via a 10X probe connected to the Sampling unit Memory Gate transformer test point (for 7S12 use TP394 on the Vertical card).

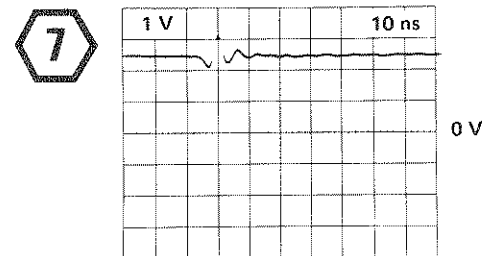
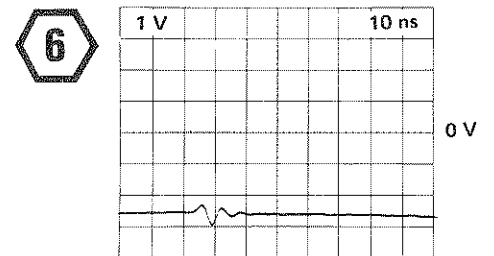
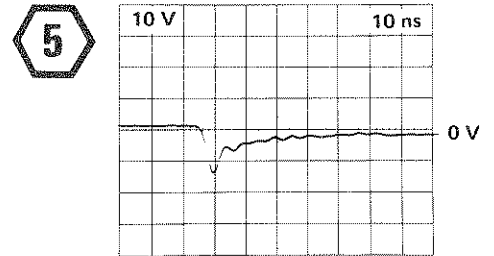
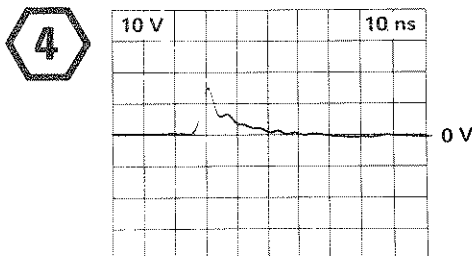
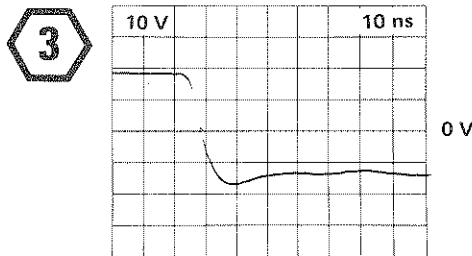
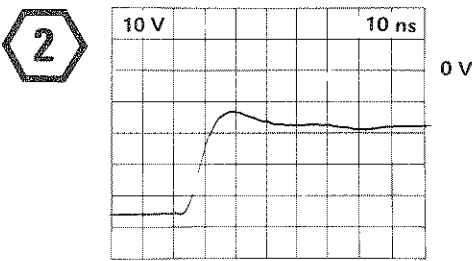
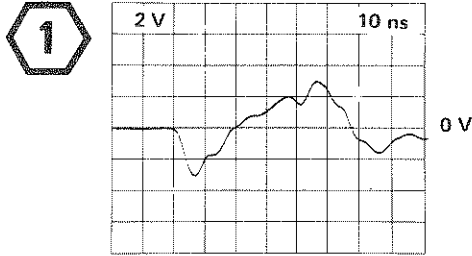

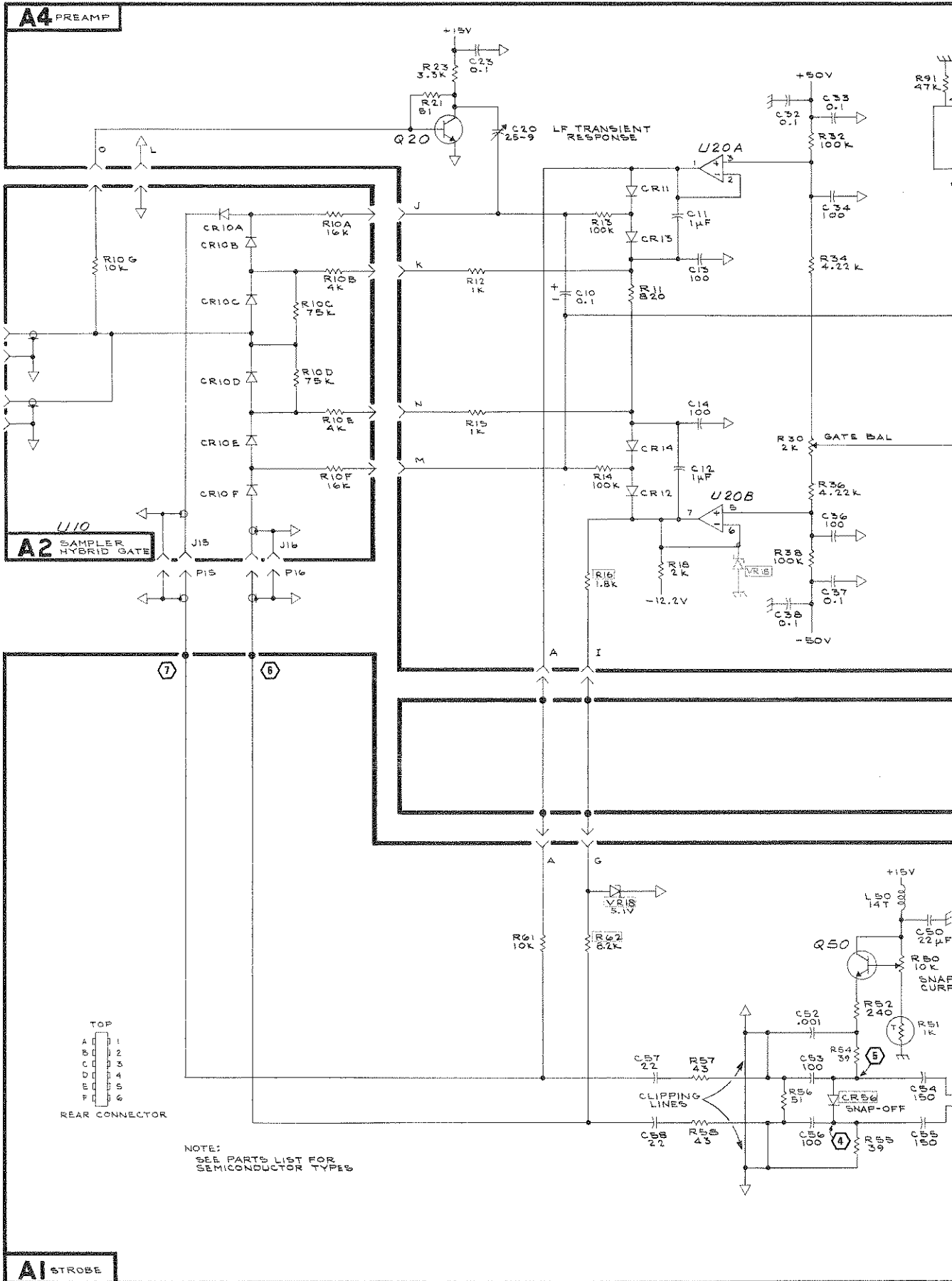

S6 SAMPLING HEAD

# REPLACEABLE MECHANICAL PARTS

## PARTS ORDERING INFORMATION

Replacement parts are available from or through your local Tektronix, Inc. Field Office or representative.

Changes to Tektronix instruments are sometimes made to accommodate improved components as they become available, and to give you the benefit of the latest circuit improvements developed in our engineering department. It is therefore important, when ordering parts, to include the following information in your order: Part number, instrument type or number, serial number, and modification number if applicable.

If a part you have ordered has been replaced with a new or improved part, your local Tektronix, Inc. Field Office or representative will contact you concerning any change in part number.

Change information, if any, is located at the rear of this manual.

## SPECIAL NOTES AND SYMBOLS

X000 Part first added at this serial number

00X Part removed after this serial number

## FIGURE AND INDEX NUMBERS

Items in this section are referenced by figure and index numbers to the illustrations.

## INDENTATION SYSTEM

This mechanical parts list is indented to indicate item relationships. Following is an example of the indentation system used in the description column.

1 2 3 4 5 *Name & Description*

*Assembly and/or Component*

*Attaching parts for Assembly and/or Component*

--- \* ---

*Detail Part of Assembly and/or Component*

*Attaching parts for Detail Part*

--- \* ---

*Parts of Detail Part*

*Attaching parts for Parts of Detail Part*

--- \* ---

Attaching Parts always appear in the same indentation as the item it mounts, while the detail parts are indented to the right. Indented items are part of, and included with, the next higher indentation. The separation symbol --- \* --- indicates the end of attaching parts.

**Attaching parts must be purchased separately, unless otherwise specified.**

## ITEM NAME

In the Parts List, an Item Name is separated from the description by a colon (:). Because of space limitations, an Item Name may sometimes appear as incomplete. For further Item Name identification, the U.S. Federal Cataloging Handbook H6-1 can be utilized where possible.

## ABBREVIATIONS

"	INCH	ELECTRN	ELECTRON	IN	INCH	SE	SINGLE END
#	NUMBER SIZE	ELEC	ELECTRICAL	INCAND	INCANDESCENT	SECT	SECTION
ACTR	ACTUATOR	ELECTLT	ELECTROLYTIC	INSUL	INSULATOR	SEMICOND	SEMICONDUCTOR
ADPTR	ADAPTER	ELEM	ELEMENT	INTL	INTERNAL	SHLD	SHIELD
ALIGN	ALIGNMENT	EPL	ELECTRICAL PARTS LIST	LPHLDR	LAMPHOLDER	SHLDR	SHOULDERED
AL	ALUMINUM	EOPT	EQUIPMENT	MACH	MACHINE	SKT	SOCKET
ASSEM	ASSEMBLED	EXT	EXTERNAL	MECH	MECHANICAL	SL	SLIDE
ASSY	ASSEMBLY	FIL	FILLISTER HEAD	MTG	MOUNTING	SLFLKG	SELF-LOCKING
ATTEN	ATTENUATOR	FLEX	FLEXIBLE	NIP	NIPPLE	SLVG	SLEEVING
AWG	AMERICAN WIRE GAGE	FLH	FLAT HEAD	NON WIRE	NOT WIRE WOUND	SPR	SPRING
BD	BOARD	FLTR	FILTER	OBD	ORDER BY DESCRIPTION	SQ	SQUARE
BRKT	BRACKET	FR	FRAME or FRONT	OD	OUTSIDE DIAMETER	SST	STAINLESS STEEL
BRS	BRASS	FSTNR	FASTENER	OVH	OVAL HEAD	STL	STEEL
BRZ	BRONZE	FT	FOOT	PH BRZ	PHOSPHOR BRONZE	SW	SWITCH
BSHG	BUSHING	FXD	FIXED	PL	PLAIN or PLATE	T	TUBE
CAB	CABINET	GSKT	GASKET	PLSTC	PLASTIC	TERM	TERMINAL
CAP	CAPACITOR	HDL	HANDLE	PN	PART NUMBER	THD	THREAD
CER	CERAMIC	HEX	HEXAGON	PNH	PAN HEAD	THK	THICK
CHAS	CHASSIS	HEX HD	HEXAGONAL HEAD	PWR	POWER	TNSN	TENSION
CKT	CIRCUIT	HEX SCC	HEXAGONAL SOCKET	RCPT	RECEPTACLE	TPG	TAPPING
COMP	COMPOSITION	HLCPS	HELICAL COMPRESSION	RES	RESISTOR	TRH	TRUSS HEAD
CONN	CONNECTOR	HLEXT	HELICAL EXTENSION	RGD	RIGID	V	VOLTAGE
COV	COVER	HV	HIGH VOLTAGE	RLF	RELIEF	VAR	VARIABLE
CPLG	COUPLING	IC	INTEGRATED CIRCUIT	RTNR	RETAINER	W	WITH
CRT	CATHODE RAY TUBE	ID	INSIDE DIAMETER	SCH	SOCKET HEAD	WSHR	WASHER
DEG	DEGREE	IDENT	IDENTIFICATION	SCOPE	OSCILLOSCOPE	XFMR	TRANSFORMER
DWR	DRAWER	IMPLR	IMPELLER	SCR	SCREW	XSTR	TRANSISTOR

## CROSS INDEX - MFR. CODE NUMBER TO MANUFACTURER

Mfr. Code	Manufacturer	Address	City, State, Zip Code
00779	AMP INC	P O BOX 3608	HARRISBURG PA 17105
02660	BUNKER RAMO CORP	2801 S 25TH AVE	BROADVIEW IL 60153
16179	AMPHENOL NORTH AMERICA DIV OMNI SPECTRA CORP	21 CONTINENTAL BLVD	MERRIMACK NH 03054
18203	MICROWAVE COMPONENT DIV ENGELMANN MICROWAVE CO	SKYLINE DRIVE	MONTVILLE NJ 07045
18359	AUGAT/PYLON CO	51 NEWCOMB ST	ATTLEBORO MA 02703
22229	SOLITRON DEVICES INC	8808 BALBOA AVE	SAN DIEGO CA 92123
22526	SEMICONDUCTOR GROUP SAN DIEGO OPERS DU PONT E I DE NEMOURS AND CO INC	30 HUNTER LANE	CAMP HILL PA 17011
26805	DU PONT CONNECTOR SYSTEMS OMNI SPECTRA INC	140 FOURTH AVE	WALTHAM MA 02154
79136	MICROWAVE CONNECTOR DIV WALDES KOHINOOR INC	47-16 AUSTEL PLACE	LONG ISLAND CITY NY 11101
80009	TEKTRONIX INC	4900 S W GRIFFITH DR P O BOX 500	BEAVERTON OR 97077
83486	ELCO INDUSTRIES INC	1101 SAMUELSON RD	ROCKFORD IL 61101



Fig. & Index No.	Tektronix Part No.	Serial/Assembly No.		Qty	12345 Name & Description	Mfr.	
		Effective	Dscont			Code	Mfr. Part No.
1-1	386-1337-10	B010100	B042309	1	PANEL, REAR:	80009	386-1337-10
	386-1337-09	B042310		1	PANEL, REAR: (ATTACHING PARTS)	80009	386-1337-09
-2	211-0141-00			3	SCREW, MACHINE: 4-40 X 3.25, PNH, SST (END ATTACHING PARTS)	83486	ORDER BY DESCR
-3	131-1133-00			1	CONTACT, ELEC: SPR LOAD PIN	18359	SPECIAL 3009
-4	380-0125-00			1	HSG, SAMPLING HD: ALUMINUM	80009	380-0125-00
-5	131-0555-00			4	.CONTACT, ELEC: GROUNDING, PH BRZ ALBALOY PL	80009	131-0555-00
-6	-----			1	CKT BOARD ASSY: STROBE (SEE A1 REPL)		
-7	344-0061-00	B010100	B039999	2	.CLIP, ELEC: DIODE, 0.08 DIA, CU BE GOLD PLATED	80009	344-0061-00
-8	131-1083-00			2	.CONN, RCPT, ELEC: 3MM, MALE RIGHT ANGLE	26805	2065-5001-00
-9	136-0252-04			9	.SOCKET, PIN TERM: U/W 0.016-0.018 DIA PINS	22526	75060-007
-10	136-0263-03	B010100	B040816	7	.SOCKET, PIN TERM: U/W 0.025 SQ PINS	00779	85864-2
	136-0263-07	B040817		7	.SOCKET, PIN TERM: U/W 0.025 SQ PIN	22526	ORDER BY DESCR
-11	-----			1	CKT BOARD ASSY: SAMPLER (SEE A3 REPL)		
-12	131-0591-00			6	.TERMINAL, PIN: 0.835 L X 0.025 SQ PH BRZ	22526	47332
-13	131-0594-00			5	.TERMINAL, PIN: BLACK	22526	47356
					(ATTACHING PARTS)		
-14	211-0196-00			3	SCREW, MACHINE: 4-40 X 0.188, SCH, STL (END ATTACHING PARTS)	TK0428	ORDER BY DESCR
-15	-----			1	CKT BOARD ASSY: PREAMPL (SEE A4 REPL)		
-16	136-0252-04			23	.SOCKET, PIN TERM: U/W 0.016-0.018 DIA PINS	22526	75060-007
-17	136-0263-03	B010100	B040816	9	.SOCKET, PIN TERM: U/W 0.025 SQ PINS	00779	85864-2
	136-0263-07	B040817		15	.SOCKET, PIN TERM: U/W 0.025 SQ PIN	22526	ORDER BY DESCR
-18	136-0327-01	B010100	B040816	6	.SOCKET, PIN TERM: 0.067 INCH DIA	00779	86281-2
-19	-----			1	HYBRID CIRCUIT: SAMPLER (SEE A2 REPL)		
-20	131-0631-00	B010100	B042649	2	.CONN, RCPT, ELEC: 3MM TYPE, FEMALE	22229	2992-6012
	131-0631-01	B042650		2	.CONN, RCPT, ELEC: SMA JACK TO SPCL END CONFIG	26805	ADVISE
-21	131-1082-00			2	.CONN, RCPT, ELEC: 3MM, FEMALE (ATTACHING PARTS)	26805	2080-5056
-22	220-0531-02			2	NUT, PLAIN, HEX: 0.25-36 X 0.312 HEX, BRS NP (END ATTACHING PARTS)	80009	220-0531-02
-23	384-0687-00	B010100	B019999	1	KNOB: 1.44 L X 0.125 OD, SST	80009	384-0687-00
-24	214-1226-01	B010100	B019999	1	SPRING, HLCP: 0.18 OD X 0.44 L, MLW CD PL	80009	214-1226-01
-25	105-0066-00	B010100	B019999	1	STRIKE, LATCH: SAMPLING HEAD	80009	105-0066-00
	105-0338-00	B020000		1	LATCH ASSEMBLY:	80009	105-0338-00
-26	354-0163-00			1	.RING, RETAINING: TYPE E EXT, U/O 0.125 ID SFT	79136	5133-12ZD
-27	384-0687-01			1	.KNOB: 1.44 L X 0.125 OD, SST	80009	384-0687-01
-28	105-0336-00			1	.STRIKE, CATCH:	80009	105-0336-00
-29	333-1414-00			1	PANEL, FRONT:	80009	333-1414-00
-30	386-1338-15			1	SUBPANEL, FRONT:	80009	386-1338-15

