

---

**TEK**

**User Reference**

Part No. 070-7719-01  
Product Group 47

**THE  
CSA 803**  
COMMUNICATIONS SIGNAL  
ANALYZER

*Please check for CHANGE INFORMATION  
at the rear of this manual.*

---

**Tektronix**  
COMMITTED TO EXCELLENCE

## Instrument Serial Numbers

Each instrument manufactured by Tektronix has a serial number on a panel insert or tag, or stamped on the chassis. The first letter in the serial number designates the country of manufacture. The last five digits of the serial number are assigned sequentially and are unique to each instrument. Those manufactured in the United States have six unique digits. The country of manufacture is identified as follows:

B010000	Tektronix, Inc., Beaverton, Oregon, USA
G100000	Tektronix Guernsey, Ltd., Channel Islands
E200000	Tektronix United Kingdom, Ltd., London
J300000	Sony/Tektronix, Japan
H700000	Tektronix Holland, NV, Heerenveen, The Netherlands

Instruments manufactured for Tektronix by external vendors outside the United States are assigned a two digit alpha code to identify the country of manufacture (e.g., JP for Japan, HK for Hong Kong, etc.).

Tektronix, Inc., P.O. Box 500, Beaverton, OR 97077

Copyright © Tektronix, Inc., 1989, 1990, 1991. All rights reserved. Tektronix products are covered by U.S. and foreign patents, issued and pending. The following are registered trademarks: TEKTRONIX, TEK, TEKPROBE, SCOPEMOBILE and



Centronics® is a registered trademark of Data Computer Corporation.

EPSON is a registered trademark of Epson America, Inc.

IBM is a registered trademark of International Business Machines Corporation.

Proprinter is a trademark of International Business Machines Corporation.

ThinkJet and LaserJet are products of the Hewlett-Packard Company.

# Learning Guide



## Learning the CSA 803

<b>If you're:</b>	<b>Then you should:</b>
New to digital sampling scopes	Read the <i>Tutorial</i> and perform the examples
Familiar with digital sampling but new to the CSA 803	Read at least the Getting Started section of the <i>Tutorial</i> and explore the <i>User Reference</i> as needed
Using the CSA 803 as part of a programmable instrumentation system and unfamiliar with instrumentation programming	Read the <i>Programmer Reference</i>
Using the CSA 803 as part of a programmable instrumentation system and are experienced with instrumentation programming	Read the Learning by Example section of the <i>Programmer Reference</i> and use the <i>Command Reference</i> as needed

## Using the CSA 803

<b>If your task is to:</b>	<b>Then you should look here first:</b>
Set up Constellation Diagrams	Constellation Diagrams, page 53
Set up Eye Diagrams	Eye Diagrams, page 95
Set up Mask Testing	Mask Testing, page 145
Set up Histograms	Histograms, page 121
Make timing, amplitude, or energy measurements	Measurements, page 157
Make TDR measurements	TDR, page 213
Perform waveform math	Trace Definition and Management, page 231
Measure Noise	Histograms, page 121



# About This Manual



This is the front-panel reference manual for the CSA 803 Communications Signal Analyzer. If you are a new user, first read the *CSA 803 Communications Signal Analyzer Tutorial* to become familiar with the CSA 803. Use this manual as a reference to answer specific questions about CSA 803 operation.

The first section of this manual, *At a Glance*, presents quick get-acquainted information and a map of the menu system. Each menu is accompanied by pointers into the detailed second section, *In Detail*.

Other manuals that complete the documentation set for the CSA 803 Communications Signal Analyzer:

- The *CSA 803 Tutorial* gives step-by-step instructions that demonstrate basic operation of the CSA 803.
- The *CSA 803 and 11801A Programmer Reference* describes using a computer to control the CSA 803 through GPIB or RS-232-C interfaces.
- The *CSA 803 and 11801A Command Reference* describes the commands used to program the CSA 803.
- The *CSA 803 Service Reference* provides module-level repair and replacement information about the CSA 803.



# Contents



<b>At a Glance</b> .....	<b>1</b>
Front Panel and Sampling Heads .....	2
Rear Panel .....	4
Display and Touch Panel .....	6
Icons .....	8
Knobs, Knob Menu, and Keypad Menu .....	10
Major Menu Buttons .....	12
Waveform Major Menu .....	14
Trigger Major Menu .....	16
Measure Major Menu .....	18
Display Modes Major Menu .....	20
Store/Recall Major Menu .....	22
Utility1 Major Menu .....	24
Enhanced Accuracy Major Menu .....	26
Utility2 Major Menu .....	28
<b>In Detail</b> .....	<b>31</b>
Acquisition .....	33
Audio Feedback .....	39
Autoset .....	41
Averaging and Enveloping .....	45
Baseline Correction .....	49
Calibrator .....	51
Color Display .....	53
Constellation Diagrams .....	57
Cursors .....	65
Diagnostics .....	71
Display Intensity .....	77
Display Persistence .....	79
Enhanced Accuracy .....	85
Eye Diagrams .....	99
GPIB Parameters .....	103
Graticules .....	107
Hardcopy .....	115
Histograms .....	125
Horizontal Controls .....	135
Initialization .....	143
Labeling .....	145
Mask Testing .....	149



Measurements .....	161
Power-On .....	183
Record Length .....	187
RS-232-C Parameters .....	191
Sampling Heads .....	197
Stored Settings .....	203
Stored Traces .....	209
System Identification .....	215
TDR .....	217
Time and Date .....	233
Trace Definition and Management .....	235
Triggering .....	247
Vectored Traces .....	251
Vertical Controls .....	255
Windows .....	259
XY Traces .....	265
<b>Appendix A: Accessories .....</b>	<b>269</b>
<b>Appendix B: Specifications .....</b>	<b>273</b>
<b>Appendix C: Safety .....</b>	<b>279</b>
<b>Appendix D: Algorithms .....</b>	<b>283</b>
<b>Appendix E: Messages .....</b>	<b>317</b>
<b>Glossary .....</b>	<b>323</b>
<b>Index .....</b>	<b>333</b>
<b>Change Information</b>	



# At a Glance



This section presents general operating instructions and a roadmap of the menu system. All menus are shown in this section. Once you find a menu of interest, you will be directed to the page in the In Detail section that discusses that feature.

You may want to consult the *CSA 803 Tutorial* for a complete tutorial introduction.

<b>Front Panel and Sampling Heads</b> .....	<b>2</b>
<b>Rear Panel</b> .....	<b>4</b>
<b>Display and Touch Panel</b> .....	<b>6</b>
<b>Icons</b> .....	<b>8</b>
<b>Knobs, Knob Menu, and Keypad Menu</b> .....	<b>10</b>
<b>Major Menu Buttons</b> .....	<b>12</b>
<b>Waveform Major Menu</b> .....	<b>14</b>
<b>Trigger Major Menu</b> .....	<b>16</b>
<b>Measure Major Menu</b> .....	<b>18</b>
<b>Display Modes Major Menu</b> .....	<b>20</b>
<b>Store/Recall Major Menu</b> .....	<b>22</b>
<b>Utility1 Major Menu</b> .....	<b>24</b>
<b>Enhanced Accuracy Major Menu</b> .....	<b>26</b>
<b>Utility2 Major Menu</b> .....	<b>28</b>

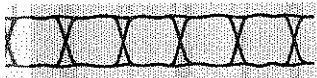

The display shows the traces and the menus, which you touch to activate. See page 7.

The major menu buttons let you select which of the major menus appears at the bottom of the display. See page 12.

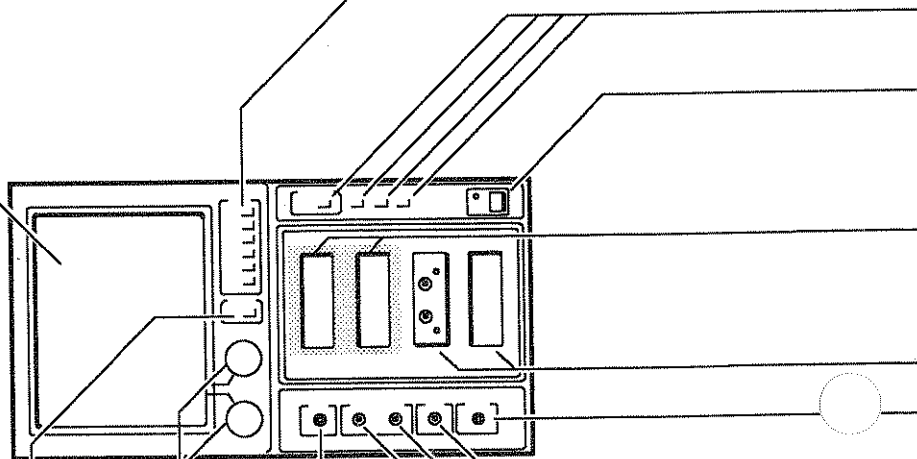

The **Touch Panel On/Off** button lets you turn off the touch panel so that you can point to the display without inadvertently making menu selections.

The two knobs control many functions of the instrument. You set the knobs to control specific functions when you make menu selections or touch icons. Using the knobs is described on page 10.

Antistatic Connector

Internal Clock Output

There are two trigger inputs, **DIRECT** and **PRESCALE**. **DIRECT** is DC-coupled with a bandwidth of 2.5 GHz. **PRESCALE** is an AC-coupled, digital prescaler which extends the trigger bandwidth to 10 GHz. See page 248.

# Front Panel and Sampling Heads



The **ACQUISITION** button stops and starts trace acquisition — see page 35. The **AUTOSET** button quickly sets the instrument parameters for a trace display — see page 41. The **HARDCOPY** button prints a copy of the display — see page 115. The **SEQUENCE SETTINGS** button lets you cycle through pre-set instrument settings — see page 207.

---

Use the **ON/STANDBY** switch as the power switch once the instrument is installed. See page 183.

---

These sampling head compartments are “power only.” They are for use with sampling heads like the SD-51 and SD-42. See page 197.

---

You install sampling heads in the sampling head compartments. See page 197.



The **CALIBRATOR** output provides a known signal for calibration. See page 51. The **INTERNAL CLOCK OUTPUT** is a trigger signal synchronized with the **CALIBRATOR**. See page 51.



Power line controls include the **LINE VOLTAGE SELECTOR SWITCH**, the fuse, the power connector, and the **PRINCIPAL POWER SWITCH**. See page 183.

The **RS-232-C** connector allows a remote computer to control the instrument through a serial interface. It can also be used to drive serial output devices. See page 191.

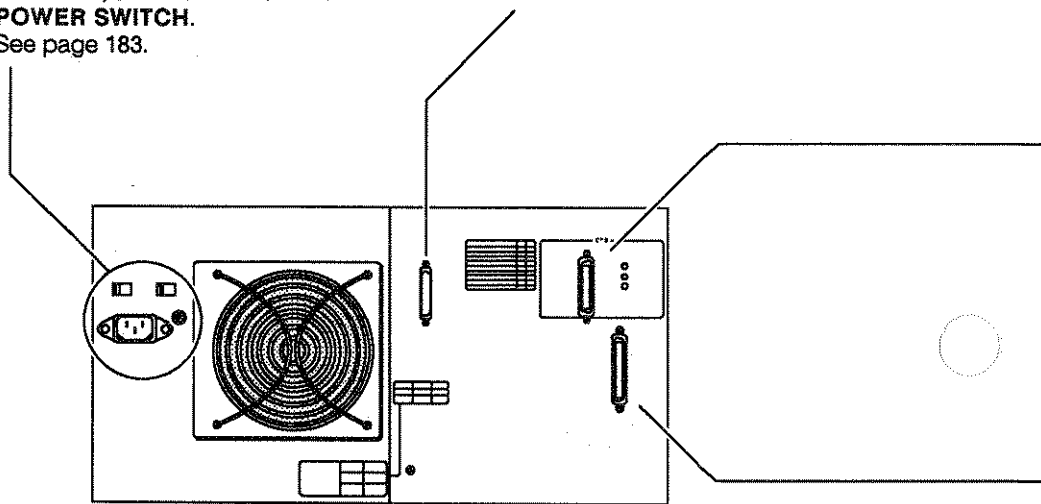

# Rear Panel

---

The **GPIB** connector allows a remote computer to control the instrument through an IEEE Std 488 parallel interface. It can also be used to drive compatible plotters. Three lights show the status of the parallel bus. See page 103.

---

The **PRINTER** connector lets you attach several kinds of printers using a Centronics interface. See page 115.



Selected trace (highlighted) and unselected trace. Axis labels and readouts apply to the selected trace. Traces can be selected by touching them. See page 240.

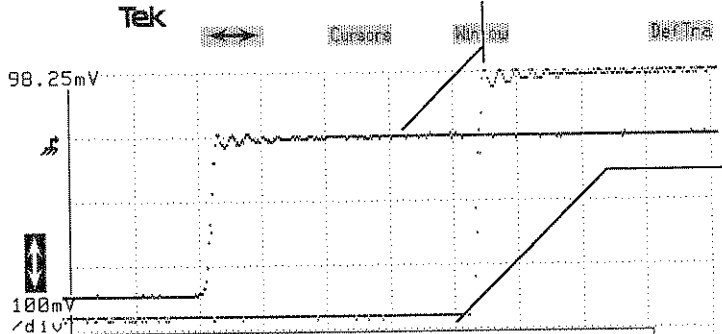

GPIB/RS232C Parameters					
GPIB Parameters			RS232C Parameters		
Mode	Address	Baud Rate	Echo	Stop Bits	
Talk/Listen	1	9600Bd	Off	1	
Terminator	GPIB Debug	Parity	Flagging	Delay	
E01	Off	None	Soft	0	
Tek C & F V81.1		EOL String	Verbose	RS232C Deburr	
		CR/LF	Off	Of	
Exit					
	Identify	Color	Hard Copy	Vert Size	M1
			Bitmap Screen	100mV/div	
				Vert Offset	M1
				-401.7mV	
Initialize	Instrument Options	Labeling	Page to Enhance Accuracy	Remove/Chan Trace 1	Set M1
	8:56:52 9-MAY-90	Off		M1	M1

# Display and Touch Panel

The display shows the output of the instrument, such as traces and measurement information. The display is combined with the touch panel to provide a touch menu system. Touch the selectors that are displayed in the various menus to execute those items. Each menu selector has a shaded top portion that names the selector, and a lower portion that shows the current status of the parameter that the selector controls.

GPB/R5232C Parameters				
GPB Parameters		RS232C Parameters		
Mode	Address	Baud Rate	Echo	Stop Bits
TalkListen	1	9600Bd	Off	1.5
Terminator	GPB Debug	Parity	Flagging	Delay
E01	Off	None	Soft	0
Tek C & F V81.1		EOL String	Verbose	RS232C Debug
		CR/LF	Off	Off
Exit				

A pop-up menu provides a temporary dialog to let you set specific parameters. This is the **GPB/R5232C** pop-up menu, which is accessed by touching the **GPB/R5232C** selector in the Utility1 major menu.

GPB/R5232C	Identify	Color	Hardcopy
			Bitmap Screen
Initialize	Instrument Options	Labelling	Page to Enhanced Accuracy
	8:56:52	Off	
	9-MAY-90		

Several different major menus are available. You display and use the major menus by pressing the major menu buttons. This is the Utility1 major menu. Touch the **GPB/R5232C** selector to display that pop-up menu. See page 12 for a description of the various major menus.

Vert. Size: M1	
100mV/div	
Vert. Off/Sec: M1	
-401.7mV	
Remove/Clp Chan	
Trace 1 Sel	
M1	M1
Main	

The Knob Menu always shows the parameters the knobs are currently assigned to control (top two selectors). You can also use the knob menu to remove traces from the display. You can touch the knob labels to see the Keypad Menu, which lets you enter a numeric value for any knob-controlled parameter. See page 10.

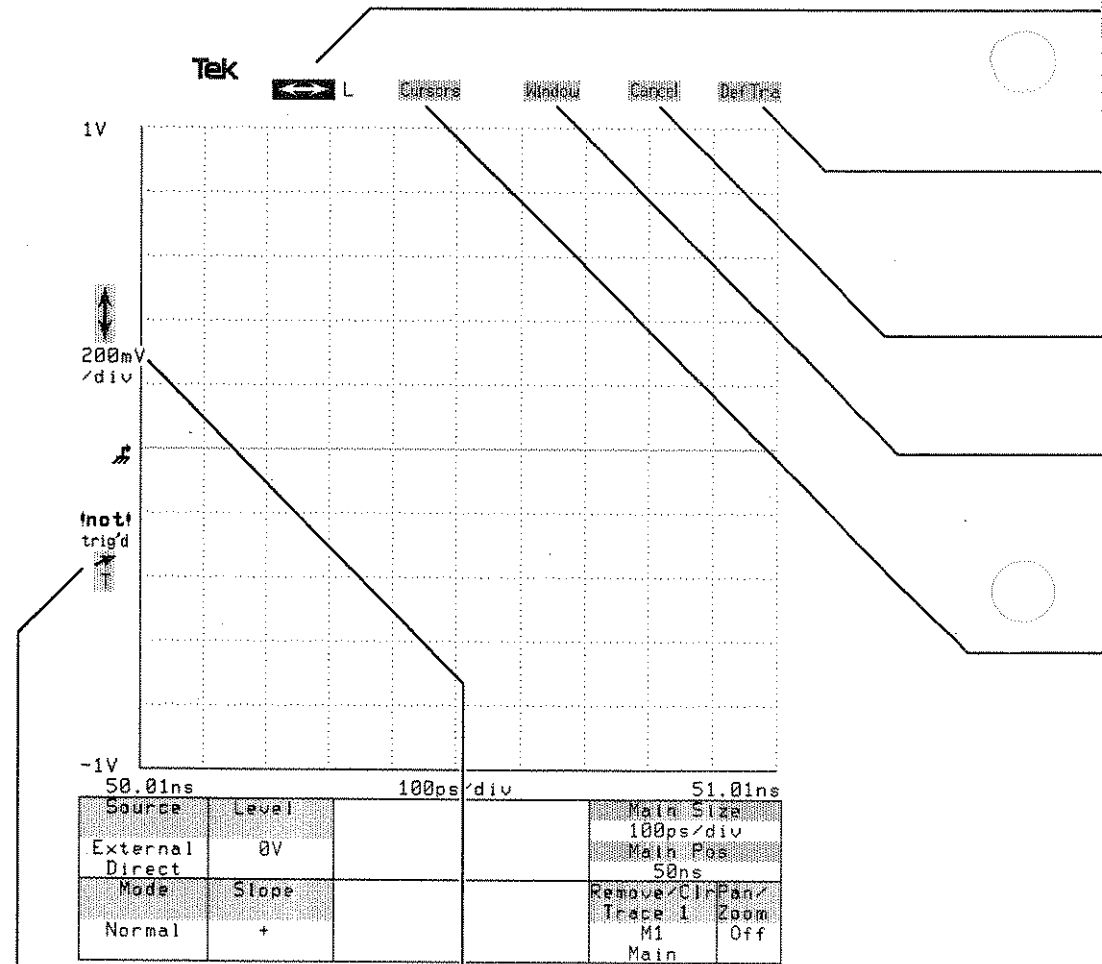
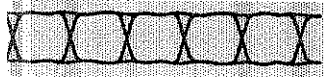

Touch the trigger icon to assign the knobs to adjust the trigger level. If the instrument is not triggered, Inot! appears above the word trig'd. See page 248.

Touch the vertical icon to assign the knobs to adjust the trace vertical size and position. See page 255.



# Icons



Touch the horizontal icon to assign the knobs to adjust the trace horizontal size and position. See page 135.



---

## Def Tra

Touch the Define Trace icon to display a pop-up menu that lets you define a new trace to be displayed. See page 235.

---

## Cancel

Blinks to indicate that a slow operation can be cancelled by touching it.

---

## Window

Touch the window icon to create a new trace that represents an enlarged portion of another trace. See page 259.



---

## Cursors

Touch the cursors icon to display bar or dot cursors for measurements of trace values. See page 65.

Icons are always available, regardless of the major menu that is displayed.

The knob labels always show the knob assignments, the parameters that the knobs will control. The bottom half of each knob label shows the current value of the parameter. When you turn a knob, you will see the current value change, and you will see the change on the display and on any displayed menus that show the parameter. Any time knob labels change they will change color. When you turn a knob, the labels return to normal.

Touch either knob label to display the Keypad Menu for that parameter.

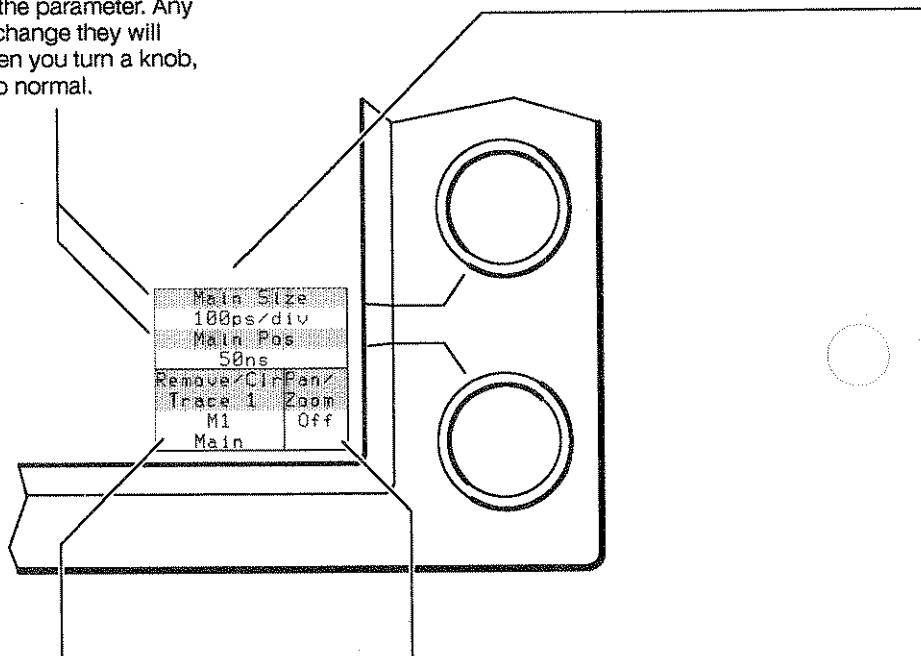

This selector lets you remove a trace from the display. First select (highlight) the trace you want removed by touching it, then touch this selector. A pop-up menu will ask you to select remove or clear. See page 242.

The **Pan/Zoom** selector lets you expand any part of a trace using horizontal magnification. See page 137. When the knobs are assigned to vertical size and offset, this selector may change to provide more vertical control. See page 255.

# Knobs, Knob Menu, and Keypad Menu

If you touch the wrong knob label by accident, the top two selectors let you choose the other knob parameter for Keypad Menu manipulation.

You can use the Keypad Menu to enter a numeric value for your parameter instead of turning the knob until the parameter is set. Touch number selectors as if you were typing the number, and end your entry by touching the **Enter** selector. **CHS** changes the sign of your number, **Back Space** lets you correct errors. The **p** (pico), **n** (nano), **μ** (micro), and **m** (milli) selectors let you scale your number.

Numeric Entry		%	Knob Res
Vert Size: M1			Vert Offset: M1
Numeric Entry			Knob Res
7	8	9	p
4	5	6	n
1	2	3	μ
0	.	CHS	m
Back Space	Enter	Set to Min	Set to Max
			255m
Vert Size: M1			200mV/div
Vert Offset: M1			0V
Remove/Clr Chan	Trace 1	Set	
M1		M1	
Main			

The **Coarse**, **Medium**, and **Fine** selectors affect the knob resolution. When set to coarse, each knob click represents a greater change than when set to medium or fine.

The **Set to Min** and **Set to Max** selectors let you quickly set a parameter to either extreme of its range of adjustment.

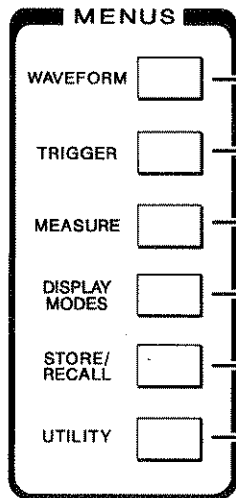

GPiB / RS232C	Identify	Color	Hardcopy
Initialize Options	Instrument	Labeling	Bitmap Screen Page to Enhanced Accuracy
	9:47:13	Off	
	9-MAY-99		

The Utility1 major menu controls general instrument parameters such as display colors, GPIB and RS-232-C settings, and hardcopy parameters. See page 24.

Storage Compensation	Gain	Offset	Delay Adjust
Calibrate All	Time Base Cal Mode	TDR Repetition	Page to Utility2 Menu
	Fast		

The Enhanced Accuracy menu controls the calibration system. See page 26.

Self Test	Extended Diagnostic		
			Page to Utility1 Menu

The Utility2 major menu provides access to the diagnostic system. See page 28.

Cursor Type	v1	-161.25mV		
Paired	v2	750.02mV		
Delta	v	162.80mV		
Set	t1	60.360ns	t1/2	30.190ns
Zero	t2	62.424ns	t2/2	31.212ns
	dt	2.0440ns	dt/2	1.0220ns
	f	459.24MHz		

The Cursors major menu controls the cursors, markers that you position on your trace to make measurements. Use the **Cursors** icon to display the Cursors major menu. See page 65.

# Major Menu Buttons

Vertical Desc	Horizontal Desc	Acquire Desc	Particules
MC	Main	Continuous	Single
Fast	512 pts		1 V
Sampling Head: End 16	Window Mode		More Trace Status

The Waveform major menu controls trace definition, acquisition, and the sampling heads. See page 14.

1. MI	2. 02		
Main	Down		
100mV	30mV		
200ps	200ps		Return to Single Trace

An alternate form of the Waveform major menu, the Trace Status menu, can be displayed using the **More...** selector in the Waveform major menu. See page 14.

Source	Level		
External Direct	8V		
Mode	Slope		
Normal	+		

The Trigger major menu controls triggering. See page 16.

Rise	Peak-Peak		Measure
2E	304,000		Compare & References
ps	mV		

The Measure major menu controls the automatic measurement system. See page 18.

Persist	Mask	Color Grad	
Histograms	Testing	Scale	
Normal			
CONTINUOUS			

The Display Modes major menu controls display persistence, histograms and mask testing. See page 20.

Store Trace	Recall Trace	Clear Trace	Delete Trace
Store Setting	Recall Setting	Sequence Settings Off	Delete Setting

The Store/Recall major menu controls storage and recall of trace data and instrument settings. See page 22.



Sampling head controls. See page 197.

Sampling Head Functions	
Selected Channel -- M1	Head Type: SD-24
Main Frame	TDR TDT: TDR On
1 2	TDR Polarity
	TDR Preset
	Diff TDR Preset
	TDR Clear
	TDR Delay -392.2m
External Channel	Smoothing
Attenuation: x1	Off
	Channel: A Below
Exit	

This pop-up menu lets you modify the trace expression of the selected trace. See page 242.

Vertical Description	
Mainframe Channels	7 8 9
1 2 3 4	4 5 6
	7 8 9
	0 CLK
Trace Functions	Exp Intg Deriv Envl
Start/Stop	Signal Sort Smooth Filter
Enter Desc	Back Space Cancel

MENU	
WAVEFORM	<input checked="" type="checkbox"/>
TRIGGER	<input type="checkbox"/>
MEASURE	<input type="checkbox"/>
DISPLAY MODES	<input type="checkbox"/>
STORE/RECALL	<input type="checkbox"/>
UTILITY	<input type="checkbox"/>

Vertical Desc	Horizontal Desc	Acquire Desc	Lower Graticule
M1	Window	Continuous	Dual s.v
Fast	512 pts		More...
Sampling Rate: Auto	Manual		Trace Status

Window Mode	
Position Mode	Manual
Tracking	Locate Window
On	
Level Mode	Level
Relative	50%
Transition Number	Slope
1	
Filtering	Top / Base Method
3	IEEE
Exit	

This pop-up menu controls the position of window traces. See page 261.

The **More...** selector displays the alternate Trace Status major menu. This displays the status of all traces on the display. See page 240.

# Waveform Major Menu

Horizontal Description	
Acquiring Timebase: Main	
Main Sample Interval: 2ps/point	
Window Sample Interval: 200fs/point	
Main	Window
Record Length	Record Length
512 points	512 points
Horizontal Reference Point	
Left	Center
XY Display Mode: X=Acquired Trace	
Trace 1	Normal
M1	Y1
Main	
XY Display Mode: X=Stored Trace	
Exit	

Record length controls.  
See page 187.

Horizontal reference point controls.  
See page 139.

XY trace controls.  
See page 265.

Acquire Description	
Stop Acquisition On	
Envelope N	Off
Record	Average Complete
Set Avg N	Envelope Both
32	Complete Avg & Env
Envelope N	Run Acquisition
Off	Continuous
Set Ep N	
32	
Exit	

Averaging and enveloping.  
See page 45.

Acquisition control.  
See page 35.

Graticules	
Create Second Graticule	Reduce to One Graticule
Move Trace to Other Graticule	
Y Units	
301	End
Reference	Baseline
Amplitude Correction	250mV
Off	
X Units	
Second	Meters
	Feet
	Inches
Propagation Velocity	
0.7	
Exit	

Graticule and axis unit controls.  
See page 107.

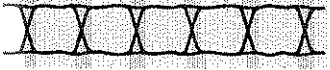

Select the trigger source using this pop-up menu. See page 247.

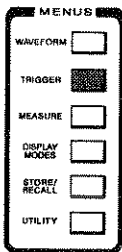
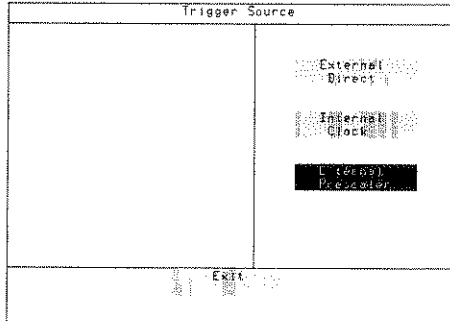

Source	Level		
External	0V		
Direct	Stops		
Normal	*		



Select Normal or Auto Trigger with this selector. See page 247.



# Trigger Major Menu



Touch this selector to assign the knobs to control trigger level. See page 247.



Touch this selector to change the trigger slope. See page 247.





Min	
Measurement Mode: Software	
Left Limit:	Right Limit:
8%	100%
45.8482ns	47.8923ns
Set: N	
32	
Cur N: 32	
Mean: -253.74999mV	
StDev: 0.0000000V	

Touch a measurement readout to display a pop-up menu that lets you control the way the measurement is taken. See page 172.

**MENUS**

WAVEFORM

TRIGGER

MEASURE

DISPLAY MODES

STORE/RECALL

UTILITY

Max	Mid	Min	Measurements
11.6415 mV	-174.800 mV	-348.000 mV	
Rise	Per 100	Over	Compares to Reference
4.94972 ns	9.99889 ns	0.00000 %	

These six selectors are reserved for the readouts of measurements that you select. This sample menu shows that the measurement system is set up to take six measurements on the selected trace. See page 161.

# Measure Major Menu

Measurements				
Get Wave & Acq.		Statistics Mode	Hardware Mode	
Reset/Cancel		Top of Best Method	Default Parameters	
Amplitude		Timing		Area/Energy
Max	Mean	Rise	Fall	Area
Min	80%	Frequency	Period	Area
Min	Over Shoot	Prop Delay	Cross	Energy
Peak-Peak	Under Shoot	Width	Duty Cycle	
Amplitude	Ext. Fac. Ratio	Phase	Jitter	Clear All
Noise				EXIT

Use this pop-up menu to specify which measurements you want to take. As you select measurements, the readouts appear immediately in the unused selectors of the major menu. See page 164.

Compare and Reference Values		
Compare	Save Current Meas Values as References	
Off		
Adjust References		
Max Ref	Min Ref	Min Ref
8V	8V	8V
Rise Ref	Period Ref	Over Ref
8s	8s	8
EXIT		

Use this pop-up menu to make your measurement relative to a reference value. See page 170.



**MENUS**

- WAVEFORM
- TRIGGER
- MEASURE
- DISPLAY MODES
- STORE/RECALL
- UTILITY

Persist	Mask	Color Grad
Histograms	Testing	Scale
Normal		
Continuous		

This menu enables you to select several kinds of display persistence and to control the histogram display. See page 79.

Persistence/Histograms		
Persist	Time	Refresh Rate
	3s	6s
Variable	Set N	Stop N
Waveforms	1000	Waveforms
Infinite	Set N	Stop N
Samples	10000	Samples
Color Grading	Set N	Stop N
MaxContrast	1	MaxContrast
Vertical Histogram	Vertical	Histogram
	Linear	Scaling
Horizontal Histogram	Horizontal	Linear
	Linear	
Display Intensity	60%	Vector Trace
		On
Clear		Exit

# Display Modes Major Menu

Mask Testing				
Mask1	Mask2	Mask3	Mask4	Mask5
Undefined	Undefined	Undefined	Undefined	Undefined
Mask6	Mask7	Mask8	Mask9	Mask10
Undefined	Undefined	Undefined	Undefined	Undefined
Edit Mask Definition		Delete Mask Definition		
Count Mask	Clear	Set N	Stop N	
Hits	Hits	Waveforms	Waveforms	
Off		1800		
Exit				

Use this menu to generate or edit masks used in mask testing. See page 149.

Color Graded Scale				
1 to 575	576 to 1151	1152 to 2303	2304 to 4607	4608 to 9214
Exit				

This pop-up menu shows the density values of the color graded display. See page 81.



These pop-up menus let you store and recall displayed traces. See page 209.

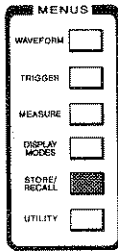
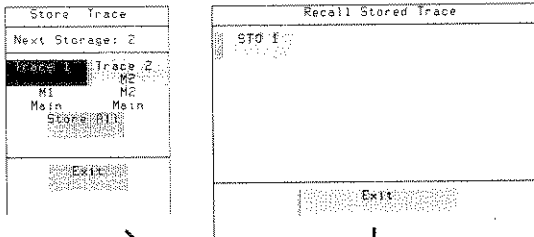

Store Trace	Recall Trace	Clear Trace	Delete Trace
Store Setting	Recall Setting	Sequence Settings Off	Delete Setting

This selector activates or disables the **SEQUENCE SETTINGS** button on the front panel. You can use that button to change from one instrument setting to the next. See page 207.

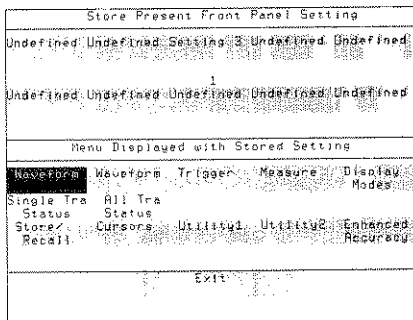

This pop-up menu lets you store an instrument setting. See page 204.

# Store/Recall Major Menu

Clear Trace	
Trace 1	Trace 2
H1	H2
Main	Main
Clear All	
Exit	

Clear displayed traces using this pop-up menu. See page 37.

Delete stored traces using this pop-up menu. See page 212.

Delete Trace		
Displayed Traces		Stored Traces
Trace 1	Trace 2	STO 1
H1	H2	
Main	Main	
Delete Selected Traces		All Traces
		Exit

Delete Setting			
Setting 1	Setting 2	Setting 3	Undefined
1	2	3	Undefined
Undefined	Undefined	Undefined	Undefined
Undefined	Undefined		
Delete Selected Settings		All Settings	Exit

Recall Front Panel Setting				
Setting 1	Undefined	Undefined	Undefined	Undefined
1	Undefined	Undefined	Undefined	Undefined
Initialize Setting				Exit

These pop-up menus let you recall or delete settings. See page 205.



Use this pop-up menu to set GPIB and RS-232-C parameters. See page 104 for GPIB, and page 192 for RS-232-C.

GPIB/RS232C Parameters				
GPIB Parameters		RS232C Parameters		
Mode	Address	Baud Rate	Echo	Stop Bits
Talk/Listen	:	9600Bd	On	1.5
Termination	GPIB Debug	Parity	Flushing	Delay
E01	Off	None	Soft	0
Tek C & F		EOL String	Verbose	RS232C Debug
V81.1		CR/LF	On	Off
Exit				

This pop-up menu shows instrument and sampling head identification and firmware version numbers. See page 215.

System Identification	
CSRB03 Mainframe ID# B010100	
Executive Processor :	2.02
Display :	2.01
Time Base/Controller :	2.02
Acquisition #1 :	9.00
Mainframe Sampling Heads	
Chan M1 :	1X Chan M2 : 1X SD-24 B020740
Chan M3 :	0X Chan M4 : 0X

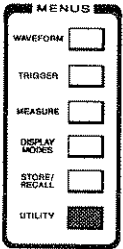

GPIB/RS232C	Identify	Color	Hardcopy
Initialize	Instrument Options	Labeling	Bitmap Screen Page to Enhanced Accuracy
	9-47:13	Off	
	9-MAY-90		

Use this selector to access the Enhanced Accuracy major menu. See page 26.

Verify Initialize
Initialize Cancel

Use this selector to initialize the instrument to a known state. See page 143.

Labeling	
By Trace	Stored Traces
By Name	Stored Settings
Trace 1	Label Mode
M1	Manual
Main	Display
	Off
	Position
G W E R I Y M I O P	
A S D F G H J K L :	
Z X C V B N M < > ? Space	
Upper Case Numbers	Greek
Lower Case Graphics	Other
	Exit

Use this pop-up menu to label traces and settings. See page 145.



# Utility1 Major Menu

Color and Intensity	
Background	Trace Color 1
H 0	L 65, S 40
G 0, S 0	Trace Color 2
Grafcator	L 60, S 55
Selectors	Trace Color 3
H100	L 55, S 45
L 35, S 10	Trace Color 4
Window	H 60
Trace H200	L 60, S 30
L 60, S 65	
Cursors	
Meas Zones	
H100	
L 40, S100	
Hue	Lightness
Saturation	
Display Intensity 60%	Previous Color All
Default Color All	
Selected Trace Color Trace 1	Color 1

This pop-up menu enables you to set the colors of various elements of the display. See page 53.

Use this pop-up menu to set Hardcopy parameters. See page 117.

Hardcopy Parameters			
Printer	Color Map		
B Pin 24 Pin	Background	Trace	Color 1
Tek 4692 Tek 4696	Grafcator Selectors	Trace	Color 2
Tek 4697	Window	Trace	Color 3
Bit InkJet HPGL	Cursors/ Meas Zones	Trace	Color 4
Screen Format	Direction	Data Format	Default Color Map
Screen Horizontal	Screen Vertical	Screen Horizontal	Screen Vertical
Output Port	Handcopy Report		
RS232C			
Exit			

Touch this selector to turn the audible beep on or off. See page 39.

Touch this selector to assign the knobs to control display brightness. See page 77.

Use these controls to set the instrument clock. See page 233.

Instrument Options			
Autoset Options			
Vertical Autoset	Horizontal Autoset	Trigger Autoset	Enable All
On	On	On	
Main Record Autoset Mode		Undo Last Autoset	
Display Intensity 60%	Audio Feedback On	Vectored Traces Off	Trace Scaling Optional
Hours 18	Minutes 12	Seconds 27	Time: 18:12:27
Month AUG	Day 28	Year 89	Date: 28-AUG-89
			Ontime: 17.2hrs
			Powerups: 32 times
Exit			

Autoset controls are described on page 41.

Turn on or off vectored traces with this selector. See page 251.

Control trace scaling, a property of traces, with this selector. See page 244.



Calibrate blowby compensation of the sampling heads that use this calibration. See page 85.

Blowby Compensation

Selected Channel -- M1

Manual: Automatic  
Calibrate: Calibrate

Store: Proceed  
Constants:

Recall: Recall  
User Const: Defaults

Exit

Calibrate gain of sampling heads. See page 85.

Loop Gain Calibration

Selected Channel -- M1

Manual: Automatic  
Calibrate: Calibrate

Store: Proceed  
Constants:

Recall: Recall  
User Const: Defaults

Divide By Two Mode: Off

Exit

MENUS

WAVEFORM

TRIGGER

MEASURE

DISPLAY MODES

STORE/RECALL

UTILITY

Blowby Compensation	Gain	Offset	Delay Adjust
Calibrate	Low Base Cal Mode	YUN Repetition	Page In Utility? Menu

Use this selector to access the Utility2 major menu. See page 28.

Calibrate All

Selected Channel -- M1

Measure Reference Channel

Calibrate: Proceed

Filtering: Store Constants: 3

Recall: Recall  
User Const: Defaults

Exit

This pop-up menu provides assistance in making all calibrations of a sampling head quickly. See page 85.

Timebase Cal Mode

High Prec

Off

Once

Exit

This pop-up menu controls the automatic self-calibration system. See page 85.

# Enhanced Accuracy Major Menu

Calibrate offset of sampling heads. See page 85.

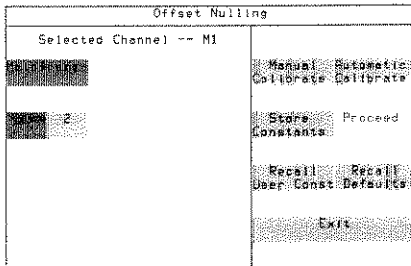

The screenshot shows a menu titled "Offset Nulling" with "Selected Channel -- M1" at the top. The menu is divided into two columns. The left column contains a list of channel numbers: 1, 2, 3, 4, 5, 6, 7, 8, 9, 10, 11, 12, 13, 14, 15, 16, 17, 18, 19, 20, 21, 22, 23, 24, 25, 26, 27, 28, 29, 30, 31, 32, 33, 34, 35, 36, 37, 38, 39, 40, 41, 42, 43, 44, 45, 46, 47, 48, 49, 50, 51, 52, 53, 54, 55, 56, 57, 58, 59, 60, 61, 62, 63, 64, 65, 66, 67, 68, 69, 70, 71, 72, 73, 74, 75, 76, 77, 78, 79, 80, 81, 82, 83, 84, 85, 86, 87, 88, 89, 90, 91, 92, 93, 94, 95, 96, 97, 98, 99, 100. The right column contains the following options: Manual Calibrate, Automatic Calibrate, Store Constants, Proceed, Recall User Const, Recall Defaults, and Exit.

Use this pop-up menu to compensate for minor timing variations between sampling heads. See page 85.

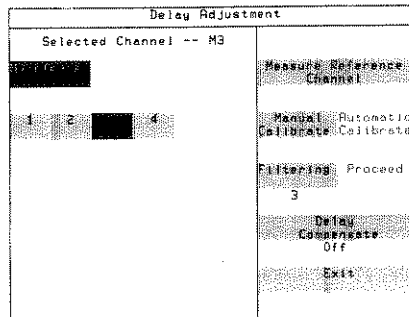

The screenshot shows a menu titled "Delay Adjustment" with "Selected Channel -- M3" at the top. The menu is divided into two columns. The left column contains a list of channel numbers: 1, 2, 3, 4, 5, 6, 7, 8, 9, 10, 11, 12, 13, 14, 15, 16, 17, 18, 19, 20, 21, 22, 23, 24, 25, 26, 27, 28, 29, 30, 31, 32, 33, 34, 35, 36, 37, 38, 39, 40, 41, 42, 43, 44, 45, 46, 47, 48, 49, 50, 51, 52, 53, 54, 55, 56, 57, 58, 59, 60, 61, 62, 63, 64, 65, 66, 67, 68, 69, 70, 71, 72, 73, 74, 75, 76, 77, 78, 79, 80, 81, 82, 83, 84, 85, 86, 87, 88, 89, 90, 91, 92, 93, 94, 95, 96, 97, 98, 99, 100. The right column contains the following options: Measure Reference Channel, Manual Calibrate, Automatic Calibrate, Filtering Proceed, Delay Compensate Off, and Exit.

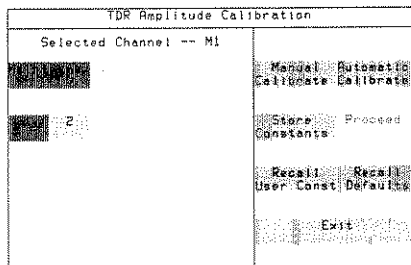

The screenshot shows a menu titled "TDR Amplitude Calibration" with "Selected Channel -- M1" at the top. The menu is divided into two columns. The left column contains a list of channel numbers: 1, 2, 3, 4, 5, 6, 7, 8, 9, 10, 11, 12, 13, 14, 15, 16, 17, 18, 19, 20, 21, 22, 23, 24, 25, 26, 27, 28, 29, 30, 31, 32, 33, 34, 35, 36, 37, 38, 39, 40, 41, 42, 43, 44, 45, 46, 47, 48, 49, 50, 51, 52, 53, 54, 55, 56, 57, 58, 59, 60, 61, 62, 63, 64, 65, 66, 67, 68, 69, 70, 71, 72, 73, 74, 75, 76, 77, 78, 79, 80, 81, 82, 83, 84, 85, 86, 87, 88, 89, 90, 91, 92, 93, 94, 95, 96, 97, 98, 99, 100. The right column contains the following options: Manual Calibrate, Automatic Calibrate, Store Constants, Proceed, Recall User Const, Recall Defaults, and Exit.

Calibrate the TDR amplitude of those sampling heads that support TDR. See page 85.



Use this selector to initiate a self-test and verify that the instrument is operating properly. See page 74.

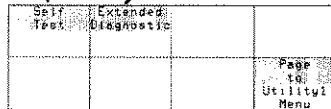
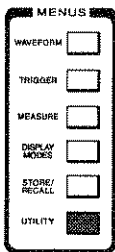
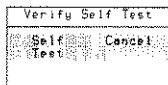

Use this selector to return to the Utility1 major menu. See page 24.

# Utility2 Major Menu

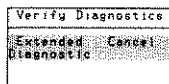

Use this selector to enter the extended diagnostics system. See page 74.



# In Detail

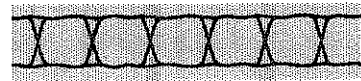

This section provides detailed information about the operations you can perform with the CSA 803. Refer to this section to answer specific questions about CSA 803 operation.

<b>Acquisition</b> .....	<b>33</b>
<b>Audio Feedback</b> .....	<b>39</b>
<b>Autoset</b> .....	<b>41</b>
<b>Averaging and Enveloping</b> .....	<b>45</b>
<b>Baseline Correction</b> .....	<b>49</b>
<b>Calibrator</b> .....	<b>51</b>
<b>Color Display</b> .....	<b>53</b>
<b>Constellation Diagrams</b> .....	<b>57</b>
<b>Cursors</b> .....	<b>65</b>
<b>Diagnostics</b> .....	<b>71</b>
<b>Display Intensity</b> .....	<b>77</b>
<b>Display Persistence</b> .....	<b>79</b>
<b>Enhanced Accuracy</b> .....	<b>85</b>
<b>Eye Diagrams</b> .....	<b>99</b>
<b>GPIB Parameters</b> .....	<b>103</b>
<b>Graticules</b> .....	<b>107</b>
<b>Hardcopy</b> .....	<b>115</b>
<b>Histograms</b> .....	<b>125</b>
<b>Horizontal Controls</b> .....	<b>135</b>



<b>Initialization</b> .....	<b>143</b>
<b>Labeling</b> .....	<b>145</b>
<b>Mask Testing</b> .....	<b>149</b>
<b>Measurements</b> .....	<b>161</b>
<b>Power-On</b> .....	<b>183</b>
<b>Record Length</b> .....	<b>187</b>
<b>RS-232-C Parameters</b> .....	<b>191</b>
<b>Sampling Heads</b> .....	<b>197</b>
<b>Stored Settings</b> .....	<b>203</b>
<b>Stored Traces</b> .....	<b>209</b>
<b>System Identification</b> .....	<b>215</b>
<b>TDR</b> .....	<b>217</b>
<b>Time and Date</b> .....	<b>233</b>
<b>Trace Definition and Management</b> .....	<b>235</b>
<b>Triggering</b> .....	<b>247</b>
<b>Vectored Traces</b> .....	<b>251</b>
<b>Vertical Controls</b> .....	<b>255</b>
<b>Windows</b> .....	<b>259</b>
<b>XY Traces</b> .....	<b>265</b>



# Acquisition



Acquisition is the process of digitizing data points from a signal and assembling them into a trace record that is shown on the oscilloscope display. Once you create a trace, acquisition of the signal is continuous and you see a live trace on the display.

## How Traces are Acquired

When the CSA 803 acquires trace records, it bases the sampling process on a trigger event, an electrical event that occurs on the trigger signal. The trigger signal is independent of the signal being acquired.

When the trigger event is detected, the CSA 803 waits a specified period of time before sampling and digitizing the first trace point. This time period is the *horizontal position* of the trace, which is set using the knobs. After the first point is digitized, the CSA 803 waits for another trigger event before sampling and digitizing the second point of the trace record. For the second point, the waiting time between the trigger event and the sampling and digitizing of the point is increased by the *sample interval*.

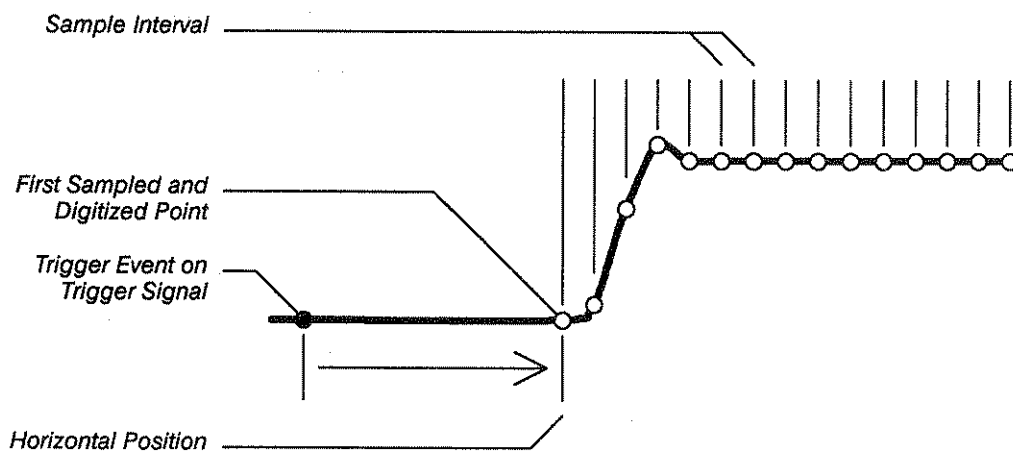

Acquisition of a Trace

## Acquisition



The acquisition process continues until all the points in the trace are sampled and digitized. Points are acquired in order from left to right, and each point is sampled from a separate trigger event. When all the points in the trace record have been sampled and digitized, the trace is displayed.

A trace remains on the display until it is replaced by a more recent acquisition or until you clear the trace. The process of clearing traces is described on page 37.

You can set the number of points in a trace record, called the *record length*, to be 512, 1024, 2048, 4096, or 5120 points. Setting the record length is described in more detail on page 187.

## Determining the Sample Interval

The sample interval is the time difference represented between successive points on the trace record. This is different from the *sampling rate*, which is the actual time that it takes to sample and digitize the successive points in the trace record. Since only one point is sampled and digitized after a trigger event, the sampling rate is much slower than the sample interval.

To compute the sample interval, divide the time period that the trace record displays by the number of points in the trace record. For example, if you are displaying a trace at 20 ns per division, the trace displays a little more than 200 ns of time. (There are a few points outside the 10-division graticule on either side.) If the trace has 2048 points, the sample interval is 200 ns divided by 2048, or 100 ps.

All traces on the main time base have the same record length and horizontal size. Similarly, all traces on window time bases share the same record length and horizontal size. This means that the CSA 803 uses one sample interval for main traces and a different sample interval for window traces. You can see what the current sample intervals are by looking at the top of the **Horizontal Desc** pop-up menu in the Waveform major menu.

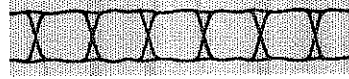

## Controlling Acquisition

You can freeze the traces on the display at any time by pressing the **ACQUISITION** button. This button is found above the sampling heads, near the column of major menu buttons. This technique lets you stop live traces to examine them more closely.

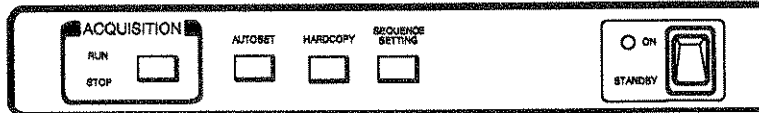

Next to the **ACQUISITION** button are **RUN** and **STOP** lights. One or the other of these lights is always on, telling you whether acquisition is occurring.

See Averaging and Enveloping on page 45 for details of how to use this pop-up menu to specify averaging or enveloping modes.

The **Acquire Desc** pop-up menu in the Waveform major menu also controls acquisition. You can specify that acquisition stop after all the data points are sampled for a single record. If you use the averaging or enveloping features, you can specify that acquisition stop after enough records have been acquired to provide a complete average and/or envelope.

You can also stop acquisition based on the number of samples or waveforms acquired for a color-graded display, the number of samples or waveforms acquired for a histogram, or the number of "hits" acquired in mask testing. See the sections on Display Persistence, Histograms, and Mask Testing for more information about these acquisition conditions.

## Acquisition

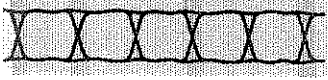

Acquire Description					
Stop Acquisition On					
Average N	One	Average			
Off	Record	Complete			
Set AvgN	Envelope	Both			
32	Complete	Avg & Env			
Envelope N	Run Acquisition				
Off	Continuous				
Set EnvN					
32					
Exit					

Vertical Desc	Horizontal Desc	Acquire Desc	Graticules	Main Record Len	Min Record Len
M1	Main	Continuous	Single	512	512
Fast	@ 512 pts		s, V		
Sampling Head Func's	Window Mode		More...	Remove/Cln	Trace 1
			Trace Status	M1	Main

### The Acquire Desc Pop-up Menu

You use the selectors in the **Stop Acquisition On** section of the pop-up menu to specify that acquisition stop on these various conditions. You can specify **One Record**, **Average Complete**, **Envelope Complete**, or **Both Avg and Env**. If you select **One Record**, all waveforms will be reacquired and acquisition will stop after a new, complete acquisition has been made for each waveform.

When you wish to resume normal, continuous acquisition, touch the **Continuous** selector under the heading **Run Acquisition**.



## Clearing Traces

A trace may be displayed, but not currently acquiring new trace data. This happens if a trace is not triggered, or if you use the **ACQUISITION** button to stop acquisition.

When the trace is displayed but is not acquiring data, the trace record from the last acquisition remains on the display. This is why traces appear frozen on the display when you turn **ACQUISITION** off.

You can clear the frozen trace data from the screen, using the **Clear Trace** pop-up menu in the Store/Recall major menu. This pop-up menu is illustrated on the next page. To clear a trace, touch the selector in the pop-up menu that represents the trace you want to clear. Traces are identified both by trace number and by trace expression and time base.

The **Clear All** selector lets you clear all traces at once.

You cannot clear a trace that displays only stored trace data. For example, if you have a trace that is defined to be **STO1 + STO2**, then that trace will not be listed in the **Clear Trace** pop-up menu.

If you clear traces that are being acquired (live traces on the display), they will be cleared and replaced with new trace data. You may notice that the trace blinks as it is cleared and replaced. The **Remove/Clr** pop-up menu can also be used to clear the selected trace.

Acquisition



Clear Trace

Trace 1	Trace 2
M4	M3
Main	Main
Trace 3	
M3+Avg(M4)	
Main	
Clear All	
Exit	

Store Trace	Recall Trace	Clear Trace	Delete Trace	Main Size	500ps/div	
				Main Pos	450ns	
Store Setting	Recall Setting	Sequence Settings	Delete Setting	Remove/Clone Trace 3	M3+Avg(M4)	Zoom off
		Off		Main		

*The Clear Trace Pop-up Menu*

# Audio Feedback

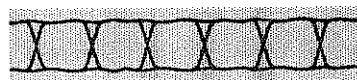

When you select a function on the touch screen, a beep indicates that your selection has been noted and is being acted on. This beep can be turned on or off.

To turn the audio feedback on or off use the Instrument Options pop-up menu from the Utility1 major menu. Touch the Audio Feedback selector in this pop-up menu to turn the beep off or on.

Audio Feedback Selector

Instrument Options					
Autoset Options					
Vertical Autoset	Horizontal Autoset	Trigger Autoset	Enable All		
On	On	On			
Main Record Autoset Mode					
Period Mode	Edge Mode	Undo Last Autoset			
Display Intensity	Audio Feedback	Vectorized Trace	Trace Scaling		
60%	On	On	Optional		
Hours	Minutes	Seconds	Time:	10:43:12	
10	43	12	Date:	16-APR-90	
Month	Day	Year	Ontime:	107.8hrs	
APR	16	90	Powerups:	118 times	
Exit					
GPIB / RS232C	Identify	Color	Hardcopy	Main Size	
			Bitmap Screen	5us/div	
				Main Pos	
				79.84304ns	
Initialize Instrument Options	Labeling	Page to	Remove/Clr Trace 1	Zoom	
10:43:12	Off	Enhanced Accuracy	M1	Off	
16-APR-90			Main		

The Instrument Options Pop-up Menu

*Audio Feedback*

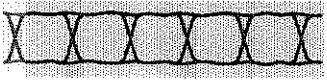



# Autoset



Adjusting an oscilloscope to display a stable trace of usable size and amplitude can be a time-consuming process. The Autoset feature of the CSA 803 can quickly give you a stable, meaningful trace display.

The  
**AUTOSET**  
Button

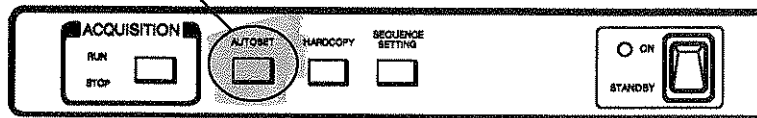

The sampling head channels must be calibrated for autoset to work properly. See *Enhanced Accuracy*, on page 85, for more information on sampling head calibration.

When you press the **AUTOSET** button, located above the sampling heads, you tell the CSA 803 to examine the signal and adjust the following controls for optimum display:

- **Vertical** gain and offset; and for calculated traces, vertical size and position
- **Horizontal** size and position
- **Trigger** level, if appropriate to that trigger source.

## Undoing an Autoset

If you don't like the results of an autoset, you can restore the status of the CSA 803 by touching the **Undo Last Autoset** selector in the **Instrument Options** pop-up menu of the **Utility1** major menu. This menu appears on the next page.

Autoset



Autoset Options

The Instrument Options pop-up menu lets you set several autoset parameters, so that you can tailor the autoset operation to your needs.

Instrument Options					
Autoset Options					
Vertical Autoset	Horizontal Autoset	Trigger Autoset	Enable All		
On	On	On			
Main Record Autoset Mode			Undo Last Autoset		
Period Mode	Edge Mode				
Display Intensity	Audio Feedback	Vectorized Trace	Trace Scaling		
60%	On	On	Optional		
Hours	Minutes	Seconds	Time: 10:43:12		
10	43	12	Date: 16-APR-90		
			Ontime: 107.8hrs		
			Powerups: 118 times		
Month	Day	Year			
APR	16	90			
Exit					
GPIB / RS232C	Identify	Color	Hardcopy	Main Size	
			Bitmap Screen	5µs/div	
				Main Pos	
				79.84304ns	
Initialize	Instrument Options	Labeling	Page to Enhanced Accuracy	Remove/Clr Trace 1	Pan/Zoom
	10:43:12 16-APR-90	Off		M1	Off
				Main	

The Instrument Options Pop-up Menu

## Autoset



The **Main Record Autoset Mode** section has two selectors. These selectors let you choose between **Edge Mode**, which shows a single rising or falling edge of signal across 20% or less of the display, or **Period Mode**, which shows three or more complete cycles of a signal.

The **Autoset Options** section has four selectors to let you turn off certain autoset operations. When you set the **Vertical Autoset**, **Horizontal Autoset**, or **Trigger Autoset** to **Off**, those parameter sets will not change when you press the **AUTOSET** button. The **Enable All** selector sets the other three selectors to their normal **On** state.

*Autoset*



# Averaging and Enveloping



The averaging and enveloping functions allow you to examine and manage noisy signals.

- Averaging reduces the apparent noise of a displayed trace and provides a cleaner display. The CSA 803 presents a trace that is an average of several accumulated trace records. Each sample in a record is numerically averaged with the same sample in all the other records. The resulting trace is displayed.
- Enveloping shows the cumulative effect of noise over a period of time. It is similar to averaging in that several trace records are accumulated and a combined result is displayed. An enveloped trace shows the maximum excursions of the individual trace records. This often results in a “thicker” trace that shows the limits of variation of the signal.

## Defining an Averaged or Enveloped Trace

There are two ways of establishing an averaged or enveloped trace.

1. If you are establishing a new trace you can use the **AVG**( or **ENV**( trace functions as you define your trace. These can be selected from the **Def Tra** menu. For more information on this method, see Trace Definition and Management on page 235.
2. The easiest method is to establish the trace first without averaging or enveloping. Then, after you have the trace adjusted, you can invoke averaging or enveloping.

The following procedure describes averaging and enveloping using the second method described above.

- Step 1: Create the trace you want using any method.
- Step 2: If the trace isn't selected, touch the trace to select it.
- Step 3: To average the trace, press the **WAVEFORM** button, touch the **Acquire Desc** selector in the major menu, and then touch the **Average N** selector in the pop-up menu.

If you aren't sure how to define a trace, see Trace Definition and Management on page 235.

Averaging and Enveloping



- Step 4: To envelope the trace, press the **WAVEFORM** button, touch the **Acquire Desc** selector in the major menu, and then touch the **Envelope N** selector in the pop-up menu.

Acquire Description		
Stop Acquisition On		
Average N	One Record	Average Complete
Off		
Set AvgN	Envelope Complete	Both Avg & Env
32		
-----		
Envelope N	Run Acquisition	
Off	Continuous	
Set EnvN		
32		
Exit		

Vertical Desc	Horizontal Desc	Acquire Desc	Graticules	Main Size	Main Pos	Trace 1 Zoom
M1	Main	Continuous	Single s, V	2µs/div	25.6371µs	Off
Fast	@ 512 pts		More...	Remove/Clip	Trace 1	Zoom
Sampling Head Enc's	Window Mode		Trace Status	M1	Main	

The Acquire Desc Pop-up Menu

The **Vertical Desc** selector status, shows that the average or envelope function is part of the trace expression.



### Terminating Averaging or Enveloping Record Count

When you want to return to normal trace display, touch the **Average N** or **Envelope N** selector in the Acquire Description pop-up menu.

Several complete trace records are combined to form an averaged or enveloped trace. You can set the number of records that the CSA 803 accumulates and combines.

Use the **Set Avg N** and **Set Env N** selectors in the **Acquire Desc** pop-up menu to assign the knobs to set the number of records. The top knob sets the number of records to accumulate for an average, and the bottom knob does the same for enveloping.

Each knob click changes the current value by a multiple of two in the coarse setting. You can use the numeric keypad to enter specific values or change the knob resolution.

### Limiting Acquisition

You can have the CSA 803 stop acquiring trace data when enough data is accumulated to determine a complete average or envelope. This has the effect of freezing the trace. The selectors in the **Stop Acquisition On** section of the Acquire Description pop-up menu let you specify **One Record**, **Average Complete**, **Envelope Complete**, or **Both Avg & Env**. When you want to resume normal continuous acquisition, touch the **Continuous** selector.

### Side Effects of Averaging and Enveloping

Averaging improves the accuracy of some software measurements because the measurements are taken from averaged data. However, some measurements can be adversely affected by averaging or enveloping. For example, if you take a rise time measurement of a signal with horizontal jitter, the averaged trace will indicate an inaccurately slow reading. Be cautious when taking software measurements of averaged or enveloped traces. One way to take an accurate rise time measurement on a signal with jitter is to use statistical measurements on the unaveraged signal.

Hardware measurements are unaffected by averaging or enveloping because these measurements are taken directly from the signal.

*Averaging and Enveloping*





# Baseline Correction



Baseline correction holds the vertical position of a trace on the display while the signal is changing. This feature is most useful in TDR measurements because changes in transmission line impedance affect the vertical placement of the trace.

When baseline correction is first turned on, the left-most region of the selected trace is examined and the vertical screen placement of this trace segment is determined. The left-most region is the region of samples soonest after the trigger, and may or may not be shown on the trace display. Thereafter, the baseline correction feature periodically examines this left-most region of the trace and automatically adjusts the vertical position to move that portion of the trace to its established vertical placement.

Select the Waveform major menu to access the **Graticules** pop-up menu. Touch the **Baseline Correction** selector in the **Graticules** pop-up menu to turn baseline correction on or off.

Baseline correction works on all channels (up to 4) in all defined traces. Baseline Correction is automatically turned on when Rho is selected for Y Units and turned off when Volts are selected for Y Units.

## Example

The following example shows the value of Baseline Correction.

- Step 1: Turn baseline correction off.
- Step 2: Using an SD-24 sampling head, establish a TDR display of a short, unterminated cable. Position the trace horizontally so that the first rise does not occur to the left of the first graticule division.
- Step 3: Terminate the cable using a 50  $\Omega$  terminator. Observe that the impedance change moves the entire trace vertically on the display.
- Step 4: Remove the 50  $\Omega$  terminator.
- Step 5: Turn baseline correction on.

*Baseline Correction*



- Step 6: Replace the 50  $\Omega$  terminator on the cable. Observe that this time, the baseline of the signal has not moved vertically on the display. Instead, the vertical axis coordinates have adjusted to the new trace values being displayed.



# Calibrator



The **CALIBRATOR** output connector provides a known signal output for your use in calibrating sampling heads. This connector is found at the bottom right of the front panel.

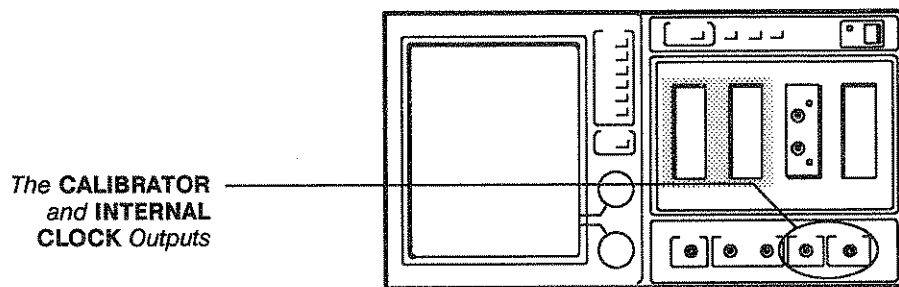

*Location of the **CALIBRATOR** and **INTERNAL CLOCK** Outputs*

The signal from the calibrator output is a fast risetime, 250 mV square wave with a period of approximately 10  $\mu$ s.

The internal clock trigger source is synchronized with the calibrator output, and provides a trigger event approximately 45 ns prior to the rising edge of the calibrator signal. This synchronized trigger signal is available at the **INTERNAL CLOCK** connector, located below the sampling heads.

To see the calibrator signal on the screen, follow these steps.

- Step 1: Initialize the instrument (press the **UTILITY** button, touch **Initialize**, then touch **Initialize** again).
- Step 2: Connect the **CALIBRATOR** output to any sampling head input, using an SMA cable.
- Step 3: Press the sampling head **SELECT CHANNEL** button for the channel you are using.

*Calibrator*

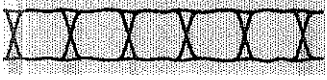

- Step 4: Select the internal clock trigger source (press the **TRIGGER** button, touch the **Source** selector in the major menu, and touch the **Internal Clock** selector in the pop-up menu).
- Step 5: Press the **AUTOSET** button.



# Color Display



Specific colors are assigned to the items on the display. The background, graticule and selectors, and cursors and measurement annotations are displayed in distinct colors for easy identification. In addition, there are up to four colors for traces and an additional color for window traces.

The four trace colors are assigned automatically to traces as the traces are defined. When a window trace is defined, it is displayed in the window trace color. When you select a trace, its color brightens.

## Color Selection

You can modify the display colors to suit your preferences using the **Color** pop-up menu in the Utility1 major menu, shown on the next page. You can change the colors displayed and the overall intensity of the display. You can also reassign the color of the selected trace to any of the four trace colors or window trace color.

The upper section of the **Color** pop-up menu has a selector for each display color. Next to each selector is a box the color of that display element, and beneath the selector is a readout of the hue, lightness, and saturation values of that color.

- **Hue** is the characteristic associated with a color name, such as red. It is expressed in degrees on a range of 0° to 360°.
- **Lightness** is the intensity of the color, or the amount of light it transmits. Lightness is expressed from 0% (black) to 100% (white).
- **Saturation** is the vividness of the color, or the extent that it differs from gray. Saturation is expressed from 0% (maximum white content) to 100% (fully saturated).

To change the color of a display element, select the element in the **Color** pop-up menu. The knobs are automatically assigned to control **Lightness** and **Saturation**; select **Hue** if you want to adjust the hue of the color. Adjust the color using the control knobs.

Color Display



Color and Intensity

Background H 0 L 0, S 0 Graticule/ Selectors H180 L 35, S 10 Window Trace H290 L 60, S 65 Cursors/ Meas Zones H120 L 40, S100	Trace Color 1 H170 L 65, S 40 Trace Color 2 H130 L 60, S 55 Trace Color 3 H230 L 55, S 45 Trace Color 4 H 60 L 60, S 30
---	--

Hue                      Lightness                      Saturation

<b>Display</b>	<b>Previous</b>	<b>Default</b>
<b>Intensity</b>	<b>Colors</b>	<b>Color</b>
60%		All

	<b>Selected</b>	
	<b>Trn Color</b>	
	Trace 1	
	Color 1	

GPIB / RS232C	Identify	<b>Color</b>	Hardcopy	Desu Intensity 60%	Desu Intensity 60%
			Bitmap Screen		
Initialize	Instrument Options 8:04:27 26-APR-90	Labeling Off	Page to Enhanced Accuracy	Remove/Clr Trace 1 M1 Main	

*The Color Pop-up Menu*



### Restoring Colors

Two selectors in the **Color** pop-up menu let you restore colors to their default settings or to the colors previously defined.

- **Previous Colors** restores all eight display elements to the colors they had when you displayed the **Color** pop-up menu.
- **Default Color** sets the selected display element to the factory default color.

When no display elements are selected, the **All** label is displayed below the **Default Color** selector, and touching **Default Color** sets all eight display elements to the factory default colors.

### Reassigning Trace Colors

Although the four trace colors are assigned to traces in order as they are created, you can change a trace's color assignment using the **Selected Tra Color** selector at the bottom of the **Color** pop-up menu.

The status area below the **Selected Tra Color** shows the trace number of the selected trace and the number of the color assigned to that trace, for example **Trace Color 1**. The box next to the selector displays the color of the trace.

Touch the **Selected Tra Color** selector to change the color assignment of the selected trace. As you touch the **Selected Tra Color** selector, it cycles through the four trace colors and window trace color. Touch the **Window Trace** selector to change the color assignment of the window trace.

### Setting the Display Intensity

You can adjust the overall intensity, or brightness, of the display. Touch the **Display Intensity** selector in the **Color** pop-up menu to assign the knobs to control the intensity of the display. Display intensity can be from 0% to 100%.

*Color Display*

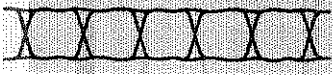



# Constellation Diagrams



A constellation diagram is the result of displaying one data signal against another in an XY format, resulting in a matrix display of the various signal levels. This section provides general instructions to help you display a constellation diagram on the CSA 803.

## Displaying a Constellation Diagram

You will need the following equipment:

- A two-channel sampling head or two single-channel sampling heads
- 3 SMA cables
- A static protection wrist strap

To display a constellation diagram:

- Step 1: Press the **UTILITY** button, touch **Initialize** in the **Utility1** major menu, and then touch **Initialize** in the **Verify Initialize** pop-up menu.
- Step 2: Put on the wrist strap and ensure that it is connected to the antistatic connector on the front panel of the CSA 803.
- Step 3: Connect a cable from signal source 1 (often called the "I" signal) to Channel 1 (for simplicity, we assume you are using a two channel sampling head).
- Step 4: Connect another cable, of the same length, from signal source 2 (often called the "Q" signal) to Channel 2.
- Step 5: Connect the third cable from your trigger source to the **DIRECT** trigger input on the front panel or to the **PRESCALE** trigger input. Use the **DIRECT** input for signals of less than 2.5 GHz, otherwise use the **PRESCALE** input for signals from 2 GHz up to 10 GHz. Be sure not to exceed the maximum input voltage shown below each of the trigger inputs.

## Constellation Diagrams

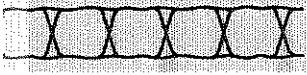

- Step 6: Press the **TRIGGER** button. Touch the **Source** selector in the Trigger major menu. Touch either **External Direct** or **External Prescaler** depending on the connector to which you connected your clock signal. Touch **Exit** to remove the pop-up menu.
- Step 7: Turn on Channel 2 by pressing the select channel button next to the input connector.
- Step 8: Turn on Channel 1 by pressing the select channel button next to the input connector.
- Step 9: To acquire a constellation diagram, you need to sample the data on both channels at a point where it is stable (this is, not transitioning between states). See the figure on the following page.

Constellation Diagrams



Locate this region at the left graticule edge

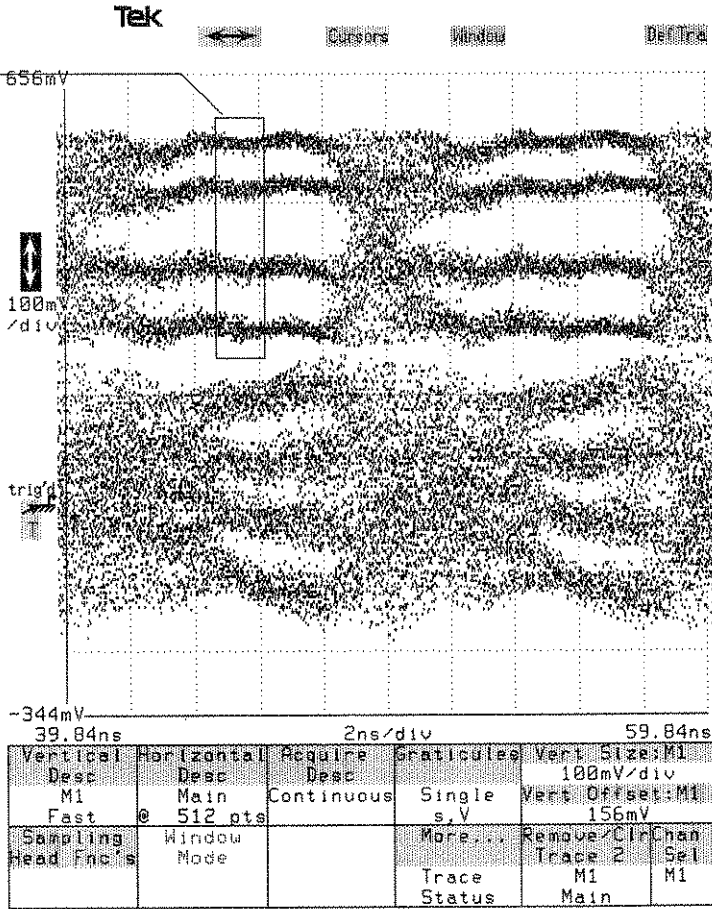

Adjusting the Main Position

## Constellation Diagrams



- Step 10: To set the CSA 803 for this condition, create a normal YT waveform on each of the two channels. Adjust the horizontal size and position to expand a small section of the waveform horizontally and to fill most of the screen vertically. The exact settings required to achieve this result will depend on your signal. For fast signals, you can even set the horizontal size to zero ps/div by keying in 0 on the knob pop-up keypad. Repeat this process for both channels until you have two waveforms that look something like the figure below.

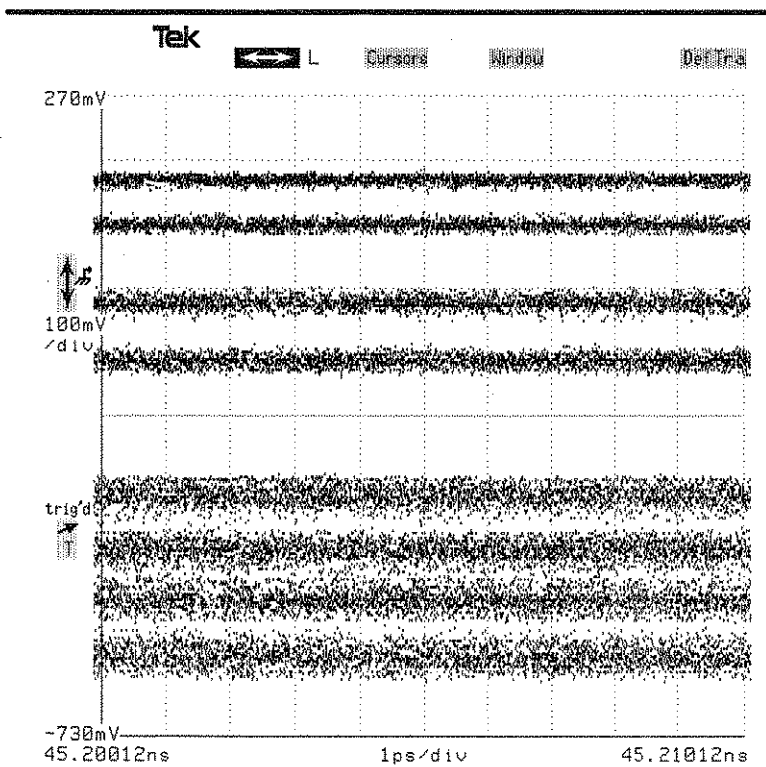

*How the Expanded Waveforms Should Appear*

## Constellation Diagrams



- Step 11: Adjust the Main size to 0 ps/div. You should see two or more distinct voltage levels (depending on the signal) across the full screen. If not, go back to 1 ns/div and reposition the four states on the left graticule edge.
- Step 12: Select channel 2 by touching it. You can determine which channel is selected by the yellow blinking light next to the input connector.
- Step 13: Press the **WAVEFORM** button.
- Step 14: Select **Horizontal Desc** from the major menu.
- Step 15: Touch the **Trace 2** selector in the XY Display Mode section of the pop-up menu.

If a 45° line appears instead of a constellation diagram, you have selected the wrong trace as the "X" component. This results in plotting one channel against itself, which produces a diagonal line instead of a constellation diagram. To select the correct channel, go back to the **Horizontal Desc** pop-up menu and select the other (non-highlighted) channel in the XY display mode section of the pop-up menu.

Constellation Diagrams

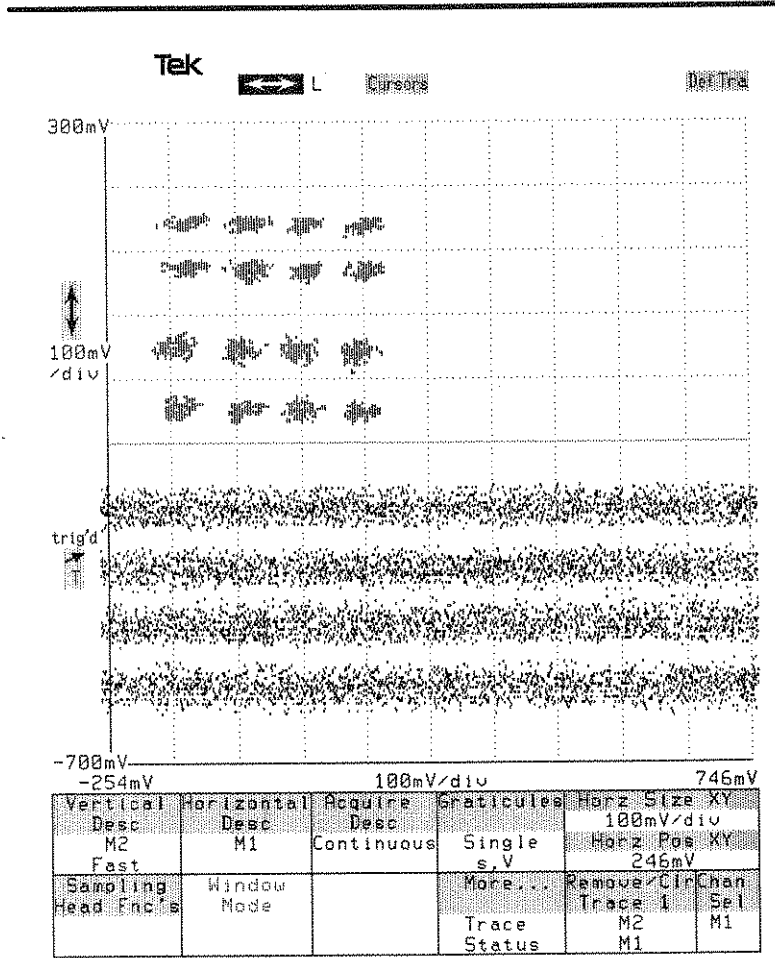

The Display After Selecting the XY Display Mode

### Constellation Diagrams



- Step 16: The channel 2 trace should now appear as a constellation diagram and the channel 1 trace should remain unchanged. Now, delete the channel 1 trace (touch the other signal display and use the **Remove/Clr** pop-up menu) and adjust the constellation diagram to fill the screen. To enlarge the constellation diagram, adjust the size and position controls as necessary.

You should now have a constellation diagram in the center of the screen. You can now use histograms, mask testing, variable persistence, and color grading to evaluate the constellation diagram.

*Constellation Diagrams*

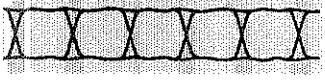



# Cursors



Cursors provide a way to measure the difference between two trace locations that you specify. Cursors are markers that you position using the knobs. Once the cursors are positioned, readouts in the Cursors major menu show the absolute locations of the two cursors, and the difference ( $\Delta$ ) between them.

- **Vertical cursors** are a pair of vertical bars. The position of the cursors and the horizontal distance between them is shown in horizontal axis units.
- **Horizontal cursors** are a pair of horizontal bars. The position of the cursors and the vertical distance between them is shown in vertical axis units.
- **Paired-Dots cursors** are a pair of small, diamond-shaped dots resting on the trace. As you move a dot cursor using the knob, it follows the trace to the left or right. The cursor readout shows both the vertical and horizontal positions, in the respective axis units.
- **Split-Dots cursors** appear similar to paired dots, except the dots may be on different traces. The readout indicates both the vertical and horizontal measurements, in the respective axis units.

Consider using the automated measurement system to take measurements before using cursors.

You can use cursors to take several measurements. However, the automated measurement system is easier, faster, and more accurate. You can take many common measurements using the Measure major menu. See Measurements on page 161 for more information.

## Cursors



### Cursor Operation

Establish all trace displays **before** turning on the cursors.

The **Cursors** icon functions much like a major menu button.

Before you use cursors, display the trace(s) that you want to measure. The trace should be selected (highlighted). For split-dot cursors, either trace may be the selected one.

To invoke the Cursor major menu, touch the **Cursors** icon, located above the graticule with the selected trace. This icon operates like one of the menu buttons at the right of the screen: it has its own major menu. When the Cursor menu is displayed, none of the lights of the major menu buttons are lighted.

When you touch the **Cursors** icon, the CSA 803 displays the cursors and their readouts. Whenever you touch the **Cursors** icon, the knobs are assigned to adjust cursor positions.

The Cursors major menu has three selectors, **Cursor Type**, **Set Zero**, and **Exit**. The rest of the major menu area shows the data readouts associated with the displayed cursors.

Cursor Type			
Vertical Bars	Horizontal Bars		
Paired Dots	Split Dots		
Split Crsr 2 to Tra			
Exit			
Cursor Type	v1 -3.0000mV	Cursor 1	78.94304ns
Paired Dots	v2 -3.0000mV	Cursor 2	20.51894μs
Exit	Δv 0.0000V	Remove/Clr	Trace 1
Set Zero	t1 78.943ns	M1	Main
	t2 20.519μs		
	Δt 20.440μs		
	1/Δt 48.924kHz		
	t1/2 39.472ns		
	t2/2 10.259μs		
	Δt/2 10.220μs		

*The Cursors Major Menu and Cursor Type Pop-up Menu*



### Selecting Cursor Types

At the top of the **Cursor Type** pop-up menu, you can select from four cursor types. If you select **Vertical Bars**, **Horizontal Bars**, or **Paired Dots**, the CSA 803 removes the pop-up menu and shows the selected cursors. The knobs control the cursor positions.

If you select **Split Dots**, the pop-up menu stays on the display, and the lower half of the pop-up menu is active. The lower menu shows a selector for each displayed trace (for example **Trace 1**, **Trace 2**). The selector for the displayed trace is highlighted.

At this point, both split-dot cursors are assigned to the selected (highlighted) trace. To assign the second (right-most) cursor to a different trace, touch the selector for that trace. This action removes the pop-up menu and moves the second cursor to the selected trace.

### Cursor Calibration

Cursor readout can be referenced to a user-set horizontal point. This is useful for making distance or time measurements using TDR or TDT. To specify cursor readout based on cursor position, press the **Set Zero** selector. The **Set Zero** pop-up menu is displayed.

Set to Zero					
Set Cur1 Zero	Clear Cursors	Set Zero Rho	Proceed	Exit	
Cursor Type	p1 -998.00mp	Q 50.04mΩ	Qx2 100.1mΩ	Cursor 1 40.22376ns	
Paired Dots	p2 986.00mp	7.093kΩ	6.567kΩ	Cursor 2 50.44376ns	
Δp	1.9840p	0.0000	0.0000		
Exit	Set Zero	t1 40.224ns	t1/2 20.112ns	Remove/Clr Trace 1	
		t2 50.444ns	t2/2 25.222ns	M1	
		Δt 10.220ns	Δt/2 5.110ns		
		1/Δt 97.847MHz		Main	

The Set Zero Pop-up Menu

## Cursors



To set the current horizontal value of Cursor 1 to zero, touch the **Set Cur1 Zero** selector. A  $\Delta$  (delta) is displayed in the status area of the **Cursor Type** selector, indicating that cursor measurements are made by subtracting that value. This is useful in TDR and TDT measurements. Touch **Clear Cursors** to return to normal mode. Touching **Set Zero Rho** enables you to position the cursors on a portion of the trace that you wish to be used as the “zero rho” (or  $50 \Omega$ ) position. (**Set Zero Rho** is not selectable unless Y Units is set to **Rho** in the **Graticules** pop-up menu.)

- To undo the effect of setting zero rho, the selected trace must be removed and redefined. However, you can also recalibrate the zero rho point for better results.

Once you have positioned the cursors, select **Proceed**. The CSA 803 will calculate a constant (RHOZERO) to be saved with the selected trace. The RHOZERO constant is added to the rho position (RHOPOS) for the selected trace. Every time RHOPOS is recalculated for the selected trace (for example, by baseline correction) RHOZERO will be added to RHOPOS again. This makes the cursor readout (and the automated measurement system) more accurate for the selected trace.

### Removing Cursors

You can remove cursors by touching the **Exit** selector in the status area. The front panel will return to the previously selected major menu.

### Additional Cursor Facts

- Once cursors are established on a trace or trace pair, touching another trace selects that trace and moves both cursors to it.
- Split Dots cursors cannot be used on X-Y traces. Other cursor types operate normally on X-Y traces.



- If the horizontal axis displays time (the normal case), then the horizontal cursor readout shows the inverse of the delta ( $1/\Delta t$ ), which can be used to show frequency. The cursor readout also shows the absolute values of the cursor locations and the distance between them.
- A dot cursor is displayed as a vertical bar if it is placed on a trace where trace data cannot be displayed. For example, if your trace is not triggered and therefore is not showing on the display, placing dot cursors on it will show vertical bars. This is because without trace data, there is no known vertical position for the dot.
- When a trace is scaled in rho, and the cursor type is dots or Horizontal Bars, ohms ( $\Omega$ ) and ohmsX2 ( $\Omega \times 2$ ) values will also be displayed for the cursor.

### Cursor Examples

#### Measuring Trace Amplitude

The following procedure shows how to use cursors to measure trace amplitude.

- Step 1: Acquire and display a trace you want to measure. Make sure all of the trace is within the graticule area, but make the trace as tall as possible for best vertical resolution (use the vertical icon if necessary).
- Step 2: Select the trace you want to measure.
- Step 3: Touch **Cursors**, **Cursor Type** and **Horizontal Bars**.
- Step 4: Use the knobs to move the cursor positions to the top and bottom of the trace. Use the **Cursor 1** or **Cursor 2** selectors in the Knob menu to increase the resolution of the knobs. This lets you position the cursors more precisely. The  $\Delta v$  readout at the display bottom indicates the trace amplitude.

## Cursors



### Measuring Time Between Points On Different Traces

The following procedure shows how to use cursors to measure time between points on different traces.

- Step 1: Create a display of the two traces you want to measure. Make sure that the point you want to measure on each trace is visible on the display. For the most accurate results, use the shortest time per division that shows the points to be measured.
- Step 2: Leave either of these traces as the selected trace, and note the number of the other trace.
- Step 3: Touch **Cursors**, **Cursor Type** and **Split Dots**.
- Step 4: Touch the trace selector of the other trace that you want to place a cursor on. If you've forgotten its number, the trace description appears in each selector.
- Step 5: The cursors are now placed, one on each trace. Use the knobs to move the cursors to the two locations from which you want to measure time difference. Then read the time difference ( $\Delta t$ ) at the bottom of the display.

# Diagnostics

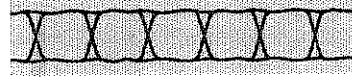

The CSA 803 features a diagnostic system that performs comprehensive tests of the instrument. This ensures you that your instrument is operating correctly. A set of tests is automatically performed whenever the CSA 803 is powered on. You can execute additional diagnostic tests at any time.

There are three categories of tests:

The CSA 803 executes the power-on and self-test diagnostics whenever the power is turned on.

- **Power-On Diagnostics** are basic functional tests. These ensure that the various microprocessors are running and communicating with each other. The power-on diagnostics take about 5 seconds to execute and are run only at power-on.
- **Self-Test Diagnostics** are a subset of the extended diagnostics and are executed as a group at power-on. You can also execute this group at any time. This group of tests takes about 15 seconds to execute.
- **Extended Diagnostics** are a complete set of tests which you can execute either individually or as a group at any time. A separate menu system controls the extended diagnostics. Any time the self-test diagnostics encounter a failure, the extended diagnostics menu remains on the screen so that you are notified of the failure.

Do not touch the touch screen or press the front panel buttons during any diagnostic tests. You may cause the diagnostics to report spurious failures.

The extended diagnostics menu is primarily intended as an aid for those servicing the instrument. This manual introduces the menu but does not discuss the extended diagnostics completely. For complete information, see the *CSA 803 Service Reference*.



## Power-On Diagnostics

The CSA 803 executes the power-on diagnostics whenever you turn the power on; this is the only time these tests are executed. The power-on diagnostics test the most fundamental operations of the microprocessors and the communication paths between microprocessors.

Power-on diagnostics take about 5 seconds to execute. During this time the front panel lights will blink and the display will show the following message. (If the display is not yet warmed up, you may not be able to see the message.)

### Diagnostics in Progress

### Comm Test in Progress

If the power-on diagnostics are completed successfully, the self-test diagnostics are executed immediately and you will see the message **Self Test in Progress** on the display.

If the power-on diagnostics fail, one or more of the following indications will notify you.

- The instrument emits a high-low beep.
- The instrument freezes and a message appears on the display. For example:

### Dsy Kernel Failure RAM Data Bit

- The instrument freezes and some of the front panel lights are turned on.





## Self-Test Diagnostics

The CSA 803 automatically executes the self-test diagnostics after the power-on diagnostics are completed successfully.

The self-test diagnostics can also be initiated by touching the **Self Test** selector, located in the Utility2 major menu (press the **UTILITY** button until the Utility2 menu appears), and then touching **Self Test** in the verification pop-up menu.

Verify Self Test				
Self Test	Cancel			
Self Test	Extended Diagnostic			Main Size 1ns/div
				Main Pos 40.22376ns
			Page to Utility1 Menu	Remove/ClrPan/ Trace 1 M1 Zoom Off

### The Self Test Pop-up Menu in the Utility2 Major Menu

The self-test diagnostics take about 15 seconds to execute. During this time you will see the message **Self Test in Progress** on the display. You will also see the front panel lights blink on and off, and you will see several test patterns on the display.

If the self-test diagnostics are completed successfully, the instrument will return to the state it was in before the self-test ran. In the case where the self-test diagnostics were executed after power-on, the instrument will return to the state it was in when last powered off.

If the self-test diagnostics fail, the **Extended Diagnostic** menu is displayed and the failure is noted on the display. You can exit the extended diagnostic system and try to use the instrument, but until the failure is repaired you should not rely on any measurements taken. Call your service person to repair the cause of any failures.



## Extended Diagnostics

You can enter the extended diagnostic system by touching the **Extended Diagnostic** selector, located in the Utility2 major menu (press the **UTILITY** button until the Utility2 menu appears), and then touching **Extended Diagnostic** in the verification pop-up menu. When self-test diagnostics fail, the extended diagnostic system is entered automatically.

Verify Diagnostics					
Extended Diagnostic			Cancel		
Self Test	Extended Diagnostic			Main Size Ins/div	
				Main Pos 40.22376ns	
			Page to Utility1 Menu	Remove/Clr Trace 1 M1 Main	Pan/ Zoom Off

### The Extended Diagnostic Pop-up Menu in the Utility2 Major Menu

The extended diagnostic system is an independent subsystem of the instrument. While in this system, few of the front panel buttons operate and the Extended Diagnostics menu covers the entire display.

To leave the extended diagnostic system and return to normal instrument operation, touch the **(E) Exit** selector in the extended diagnostic menu twice. The instrument will return to the state it was in before the extended diagnostics were entered. In the case where extended diagnostics were entered after power-on, the instrument will return to the state it was in when last powered off.



The top portion of the Extended Diagnostics menu shows three columns with the status of the diagnostic tests.

<u>SUBSYSTEM</u>	<u>INDEX</u>	<u>FAULTS</u>
a) Executive	****	
b) Display	****	
c) Time Base	****	
d) Main Acq	****	

*The Top Portion of the Extended Diagnostics Menu*

If the extended diagnostic system has been entered because of a test failure, the asterisks in the **INDEX** column will be replaced with test results. The three columns of this display have the following meanings:

- **SUBSYSTEM** lists the names of the subsystem tests.
- **INDEX** shows the test status for each subsystem. Four asterisks (\*\*\*\*) indicate the subsystem tests have yet to be executed. The word **pass** indicates all tests in this subsystem have executed successfully. Any other number or letter sequence indicates a diagnostic failure.
- **FAULTS** shows the number of tests in the subsystem that failed.

Running all of the extended diagnostics takes about 40+ seconds depending on system configuration. You may execute all the tests from the extended diagnostics menu by touching the **(x) All** selector to set the all parameter **On**, and then touching the **(r) Run** selector.

While the diagnostic tests are running, the **(r) Run** selector changes to a **(q) Quit** selector. You can touch this selector, anywhere else on the screen or a button to stop execution of diagnostic tests.

Do not rely on any measurements taken from an instrument that does not pass all extended diagnostics. Call your service person for repair.

*Diagnostics*



When the extended diagnostic tests are complete, the **(r) Run** selector is displayed again, and the test status appears in the **INDEX** and **FAULT** columns.

When you are done with the extended diagnostic tests, touch the **(e) Exit** selector twice in succession.

# Display Intensity



To change the brightness of the display, use the **Instrument Options** pop-up menu from the Utility1 major menu. Touch the **Display Intensity** selector in this pop-up menu. This assigns the knobs to control the intensity of the display. You can then use either knob to adjust the intensity.

Display intensity can also be changed in the **Color** pop-up menu, or in the **Persist/Histograms** pop-up menu in the Display Modes major menu.

The Display Intensity Selector

Instrument Options					
Autoset Options					
Vertical Autoset	Horizontal Autoset	Trigger Autoset	Enable	All	
On	On	On			
Main Record Autoset Mode			Undo Last Autoset		
Period Mode	Edge Mode				
Display Intensity	Audio Feedback	Vector Trace	Trace Scaling		
60%	On	On	Optional		
Hours	Minutes	Seconds	Time: 10:43:12		
10	43	12	Date: 16-APR-90		
			Overtime: 107.8hrs		
			Powerups: 118 times		
Month	Day	Year			
APR	16	90			
Exit					
GPIB / RS232C	Identify	Color	Hardcopy	Main Size	
			Bitmap Screen	Sus/div	
			Page to	Main Pos	
			Enhanced Accuracy	79.84304ns	
Initialize Instrument Options	Labeling		Remove/Clear	Trace 1	Zoom
10:43:12	Off		Main	M1	Off
16-APR-90					

The Instrument Options Pop-up Menu

*Display Intensity*



# Display Persistence

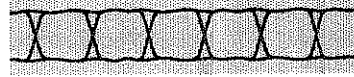

Persistence is a measure of how long a data point remains displayed. Traces can be displayed in four different persistence modes: Normal, Variable, Infinite, and Color Grading.

The persistence mode is selected from the **Persist/Histograms** pop-up menu. To display the **Persist/Histograms** menu, press the **DISPLAY MODES** button and then touch **Persist/Histograms**.

Persistence/Histograms			
Normal	Persist Time 3s	Refresh Rate 6s	
Variable	Set N Waveforms 1000	Stop N Waveforms	
Infinite	Set N Samples 10000	Stop N Samples	
Color Grading	Set N MaxContrst 1	Stop N MaxContrst	
Vertical Histogram	Vertical Limits	Histogram Scaling Linear	
Horizontal Histogram	Horizontal Limits		
Display Intensity 60%		Vectored Trace On	
Clear		Exit	
			Vert. Size: M1 50mV/div Vert. Offset: M1 -132.5mV
Persist/Histograms Infinite Continuous	Mask Testing	Color Grad Scale	Remove/Clr Chan Trace 1 Set M1 M1

*The Persist/Histograms Pop-up Menu*

## Display Persistence



### Setting the Persistence Mode

There are four persistence modes in the **Persist/Histograms** pop-up menu. To select the mode, touch the appropriate selector.

#### Normal

In normal mode, each record replaces its predecessor record by erasing it from the screen.

#### Variable

In variable persistence mode, the CSA 803 accumulates waveform data on the screen for a user-specified period and then automatically removes them from the screen after the time has expired or aged.

The duration over which the waveform is displayed on the screen before the data is removed is user selectable. The range for persistence is 200 ms to 20 s. To set the duration, select **Persist Time** and use the knobs or the keypad pop-up menu to set the time.

Variable persistence mode cannot be selected when histograms are displayed or mask testing is occurring. Histograms and mask testing can be displayed only in infinite persistence and color grading modes. If any displayed waveform has a record length longer than 512 points when **Variable Persistence** is selected, the record length is set to 512 points and a message is displayed informing you of the change in record length.

#### Infinite

In infinite persistence mode, accumulated waveform data points remain on the screen indefinitely until some instrument set-up change occurs which causes the process to start over. For example, infinite persistence is used in mask testing and if **Clear Hits** is selected during testing, the waveform data is cleared and the mask count begins accumulating all over.

If any displayed waveform has a record length longer than 512 points, when **Infinite Persistence** is selected, the record length is set to 512 points and a message is displayed informing you of the change in record length.





### Color Grading

This mode is similar to infinite persistence mode. The only difference is that the accumulated points are color graded (shaded with different colors) to indicate the density of the points.

Because the data at any point on the screen can change in this mode, there is an additional control available in color grading mode that is not available for infinite persistence mode. This is the **Refresh Rate**. The screen is not refreshed after every acquisition; instead, the screen is refreshed at a specific, user-selectable rate. The **Refresh Rate** controls how often the screen is updated with new data (this also applies to histogram displays). The range for refresh rate is 5 s to 180 s. To change the refresh rate, display the **Persist/Histograms** pop-up menu and touch **Refresh Rate**. Both of the knobs are now assigned to control the refresh rate.

You can also set the refresh rate to 0 using the keypad pop-up menu, which means the display is never updated. The color graded database is not affected by the refresh rate (only the display is), so setting the refresh rate to 0 may speed some computations, such as measurements.

If any displayed waveform has a record length longer than 512 points when **Color Grading** is selected, the record length is set to 512 points and a message is displayed informing you of the change in record length.

### Interpreting the Color Graded Display

Colors in the color graded display are based on the number of hits that have fallen in a "bin", with a bin assigned to each pixel of the display. A bin can represent a maximum of 65,535 hits. In a single-graticule display, the bins are arranged in a 512 (horizontal) by 256 (vertical) matrix. In a dual-graticule display, there are 512 (horizontal) by 128 (vertical) bins on each graticule.

## Display Persistence



There are three algorithms used to assign colors to the display. The algorithm used depends on the maximum number of hits for any pixel in the display. These algorithms are detailed in Appendix D, Algorithms. An example of the assignment of colors is shown in the table below. Max in the table represents the maximum number of hits in any bin, which for this algorithm must be at least 16.

*A Sample Assignment of Colors to Hit Density*

Hit Density	Default Color	Maps To
1/2 Max to Max	Pale Yellow	Trace Color 1
1/4 Max to 1/2 Max - 1	Rose	Trace Color 2
1/8 Max to 1/4 Max - 1	Purple	Trace Color 4
1/16 Max to 1/8 Max - 1	Light Blue	Window Trace
1 to 1/16 Max	Green	Trace Color 3

To see the actual range of values represented by each color, press **Color Grad Scale** in the Display Modes major menu. The **Color Grad Scale** pop-up menu shows the hit density for each of the five waveform colors. The hit density readouts are updated when the CSA 803 updates the color graded display.

Color Grading Scale					
					Exit
1 to 163	164 to 327	328 to 654	655 to 1309	1310 to 2619	
				Vert. Size: M1 50mV/div	
				Vert. Offset: M1 -132.5mV	
Persist/ Histograms	Mask Testing	Color Grad Scale		Remove/ClrChan Trace 1	Sel M1
Color Grad				M1	M1
Continuous				Main	

*The Color Grad Scale Pop-up Menu*

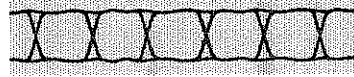

### Changing Colors

Changing display colors is described in more detail in Color Display, on page 53.

There are five colors used in the color graded display. The colors can be changed, from the **Color** pop-up menu in the Utility1 major menu. The colors are mapped to the four trace colors and the window trace color. To change the colors of the color graded display, press the **UTILITY** button, touch **Color** and change the appropriate trace color.

Although the four trace colors are assigned to traces in order as they are created, you can change a trace's color assignment, and thus the color used in the color graded display, using the **Trace Color N** selectors at the right side of the **Color** pop-up menu.

The selectors at the right side of the pop-up menu show the number of the color (HLS: hue, lightness and saturation) assigned to that trace, for example **Trace Color 3**. The box next to the selector displays the color of the trace. To change the color of trace 3, touch **Trace Color 3**. Notice that **Lightness** and **Saturation** are highlighted and the knobs are assigned to **Lightness** and **Saturation**. Turn the knobs to change the color attributes. If you touch **Color**, the menu will be removed and you can see the color graded display better. The knobs are assigned to **Lightness** and **Saturation** as long as you are in the Utility major menu. You can now change the color and see how the new color works with the other colors in the color graded display. Changing the **Selected Tra Color** has no effect on the Color Grading colors. To return to the Display Modes major menu, press the **DISPLAY MODES** button.

## Display Persistence

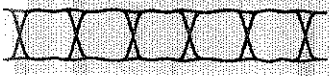

### Limiting Acquisition

In color grading mode, every pixel on the screen is assigned a "bin" which counts the number of samples that fall on that pixel. Each bin can hold a maximum count of 65,535. If a sample falls into a bin which is full, an overflow is generated. You can limit the number of acquisitions performed based on the number of times overflows occur. The **Set N MaxContrast** selector controls the number of overflows allowed before acquisition is stopped. The stop condition can be satisfied by N overflows in one bin and/or one overflow in N bins (that is, the total number of overflows in all bins). To stop acquisition after a set number of overflows, touch **Set N MaxContrast**. This assigns the knobs to limit the number of overflows allowed before the digitizer is stopped. The range for the number of overflows is 1 to 65,535. To begin acquisition, touch **Stop N MaxContrast**. Touching this selector starts acquisition, which then continues until the specified number of overflows have occurred. When the number of overflows have occurred, acquisition stops. Thus, there are two steps to stop acquisition based on the number of overflows:

- Step 1: Set the number of overflows used to limit acquisition by touching **Set N MaxContrast** and using the knobs
- Step 2: Begin the acquisition by touching **Stop N MaxContrast**

If you want to stop the acquisition while still acquiring data, press **RUN/STOP**.

# Enhanced Accuracy



Use enhanced accuracy only when the instrument temperature has stabilized. It takes 20 minutes for the CSA 803 to completely warm up.

The Enhanced Accuracy menu allows you to control the continuous self-calibration features of the CSA 803. It also allows you to perform some user-assisted calibration procedures on the sampling heads. You do not need tools to make these calibrations; you use the front panel of the CSA 803. You can choose to have the CSA 803 calibrate the sampling heads automatically, or, for most sampling heads, you can use the knobs to calibrate manually.

Blowby Compensate	Gain	Offset	Delay Adjust
Calibrate All	Time Base Cal Mode Fast	TDR Amplitude	Page to Utility2 Menu

*The Enhanced Accuracy Major Menu*

The Enhanced Accuracy menu is selected from the Utility1 major menu by selecting **Page to Enhanced Accuracy**. The eight selectors in this menu fall into these categories:

- **Control of Automated Calibration**—the **Time Base Cal Mode** selector controls the internal time base automated calibration system. You can select among Fast, High Precision, Off or Once. The **Delay Compensate** selector, in the **Delay Adjust** pop-up menu, controls operation of the automated delay adjustment.
- **Calibration Assistance**—the **Calibrate All** selector helps you quickly calibrate a sampling head channel, as well as deskew sampling head delays.
- **Sampling Head Calibration**—the **Blowby Compensate**, **Gain**, **Offset**, **TDR Amplitude**, and **Delay Adjust** selectors let you calibrate sampling head parameters. You can make each of these calibration adjustments automatically with instrument assistance, or you can make each calibration manually using the knobs.



### Control of Automated Calibration

The CSA 803 automatically calibrates the internal time base and vertical amplifiers, without your intervention. You can specify whether you want the calibration optimized for accuracy or for system speed. Touch the **Time Base Cal Mode** selector of the Enhanced Accuracy major menu to display the pop-up menu. Note that **Off** and **Once** turn off automatic calibration, thus, if the instrument is left in either mode, it can drift out of specification. The instrument should be left in **Fast** or **High Prec** mode for normal operation.

**Time Base Cal Mode Comparison**

Setting	Benefit	Side Effect
Fast	Increases system throughput slightly.	Reduces accuracy slightly.
High Prec	Increases accuracy slightly.	Slows system throughput slightly.
Off	Increases system throughput.	System can drift out of specification if left in this mode.
Once	Forces the instrument to perform one complete pass of the time base and vertical calibration, then return to the OFF state. This single calibration will be a <b>Fast</b> calibration if the previous <b>Time Base Cal Mode</b> setting was <b>Fast</b> ; High Precision if the previous setting was <b>High Prec</b> .	Generally used in OFF state to force calibration.



The CSA 803 periodically compensates the sampling head delay adjustments without your intervention. This maintains the accuracy of the delay adjustment calibrations you have performed earlier. You can specify whether or not you want the CSA 803 to perform this automatic compensation. Touch the **Delay Compensate** selector in the **Delay Adjust** pop-up menu to set this parameter to either **On** or **Off**.

**Delay Compensate Comparison**

<b>Setting</b>	<b>Benefit</b>	<b>Side Effect</b>
Off	Increases system throughput slightly.	May allow time coincidence of different sampling heads to drift over time and temperature.
On	Compensates for drift in deskew adjustment between sampling heads.	Slows system throughput slightly.

Enhanced Accuracy

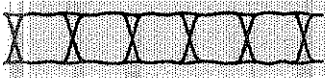

**Calibration Assistance**

The easiest way to calibrate the sampling heads is to use the **Calibrate All** selector to perform all the calibration adjustments for a single sampling head channel at once. The CSA 803 prompts you to make the signal connections that are needed to calibrate automatically.

Calibrate All					
Selected Channel -- M1					
1	2	3	4	Measure Reference Channel	
			Calibrate Proceed Channel		
			Filtering Store Constants		
			3		
			Recall Recall User Const Defaults		
Exit					
Blowby Compensate	Gain	Offset	Delay Adjust	Main Size	
				1ns/div	
				Main Pos	
				48.22376ns	
Calibrate All	Time Base Cal Mode	TDR Amplitude	Page to Utility2 Menu	Remove/Clr Trace 1 M1 Main	Pan/Zoom Off
	Fast				

*The Calibrate All Pop-up Menu*





With the **Calibrate All** pop-up menu, you must first establish the reference channel before you can calibrate any channels.

You should first decide which sampling head channel you want to use as the reference channel for delay adjust. The delay adjustment of the other heads will be calibrated to match the time position of this head. Select the reference channel using the selectors in the **Selected Channel** section of the **Calibrate All** pop-up menu. Then touch the **Measure Reference Channel** selector, and follow the displayed directions to connect the calibrator output to the selected channel. Touch the **Proceed** selector to measure that channel.

Once the reference channel is calibrated, you can calibrate all the channels, including the reference channel. You select the channel you want to calibrate using the selectors in the **Selected Channel** section of the **Calibrate All** pop-up menu. Then you touch the **Calibrate** selector to begin calibrating that channel. The sequence for calibrating the sampling head channel is:

1. A message prompts you to connect the calibrator output to the selected channel and touch the **Proceed** selector. The CSA 803 automatically calibrates blowby, gain, and delay adjust.
2. Another message prompts you to connect a 50  $\Omega$  terminator to the selected channel and touch the **Proceed** selector. The CSA 803 automatically calibrates offset.
3. If the sampling head supports TDR, a final message prompts you to connect a 50  $\Omega$  terminator to the selected channel and touch the **Proceed** selector. The CSA 803 automatically calibrates TDR amplitude.

Once a channel is calibrated, you can select a different channel using the selectors in the **Selected Channel** section of the **Calibrate All** pop-up menu and calibrate that new channel.



## Sampling Head Calibrations

Some sampling heads do not require blowby compensation. The blowby selector is not selectable (dim) for this type of head.

When you have calibrated a channel, it is good practice to store its calibration values using the **Store Constants** selector. This stores the current calibration values into sampling head non-volatile memory. When the system is powered on, it calibrates the sampling heads to the values that were stored as constants. If you later change the calibration values but do not store them, the **Recall User Const** selector of the **Calibrate All** pop-up menu will recall and use all the calibration values for the selected sampling head channel.

You can also recall the calibration values that were set at the factory, by touching the **Recall Defaults** selector of the **Calibrate All** pop-up menu. Since temperature and humidity variations affect calibration, these factory defaults may only approximate ideal performance of your sampling heads.

You can perform individual calibrations on the sampling heads. If you have used the **Calibrate All** pop-up menu to calibrate the sampling head channel, you have already performed all the calibrations and there is no need to repeat them individually.

You should refer to the User/Installation Manual for the sampling head or heads that you are using. This will tell you which calibrations are appropriate to that particular head. Some sampling heads do not require or allow certain calibrations. Some calibrations are rarely needed on certain types of sampling heads.

You can make five individual calibrations on the sampling heads.

- **Blowby Compensate** adjusts the sampling head to minimize DC level trace aberrations near the point of a large voltage change. Calibrate blowby compensation only if you notice that the displayed trace is not flat near the point of a large voltage change.
- **Gain** adjusts the dot transient response of a sampling head channel. A channel that is out of adjustment will change the shape of the displayed trace as you change the horizontal size, particularly at very high sweep speeds. Trace noise can be increased when gain is greater than unity (1). This calibration is temperature sensitive. If any of these conditions occur, check the gain calibration.

### Enhanced Accuracy



- **Offset** adjusts the DC voltage accuracy by setting the reference level to zero. This calibration is temperature sensitive, and can also be affected by gain calibration. If the temperature of your environment changes, or if you calibrate gain, also calibrate offset.
- **TDR Amplitude** adjusts the DC voltage levels of the TDR pulse. TDR Amplitude is thermally stable, and should rarely need to be calibrated. If you notice the amplitude of the TDR pulse is not to specification, you should calibrate the TDR amplitude. The Reference Amplitude (in the Graticules pop-up menu) is used in rho mode and should be set to match the voltage calibrated here (nominally 250 mV).
- **Delay Adjust** lets you deskew different sampling heads to any one sampling head. The reference head you choose is measured, and the delay of the other sampling heads is adjusted to match that reference head. Calibrate delay adjust only when you need to measure delays between two sampling heads to close tolerance. When the **Delay Compensate** selector is set to **Off**, compensation of the sampling head delays is not done automatically and the deskew calibration is not maintained automatically by the system.



### Typical Calibration Method

The five available sampling head calibrations are made in a similar way. The following description is of the options used when making a typical calibration. Further discussion of the manual method of making each individual calibration follows the description of the typical method.

To make a sampling head calibration, touch the selector in the Enhanced Accuracy major menu that names the parameter you want to calibrate. These include **Blowby Compensate**, **Gain**, **Offset**, **Delay Adjust**, and **TDR Amplitude**. Each of these displays a pop-up menu. All of these pop-up menus are similar, and the illustration on the next page of the **Offset** pop-up menu is typical of these menus.

When you use these pop-up menus, you first select the sampling head channel you want to calibrate. The left side of the pop-up menu is reserved for this. The **Selected Channel** line at the top of this section shows which channel is currently selected. You can use the selectors in this section to change the selected channel.

Many of the calibration controls on the right of the pop-up menu are common to all five of the pop-up menus. All these common selectors operate similarly, and give you the same options for each calibration.

Each of the calibrations can be made manually or automatically. In addition, you can set the calibration to the factory default, or to be the same as a calibration you made earlier.



Offset Calibration					
Selected Channel -- M1			Offset Null		
1	2	3	4	Manual Calibrate	Automatic Calibrate
			Store Constants	Proceed	
			Recall User Const	Recall Defaults	
Exit					
Blowby Compensate	Gain	Offset	Delay Adjust	Main Size	
				Ins/div	
				Main Pos	
				40.22375ns	
Calibrate All	Time Base Cal Mode	TDR Amplitude	Page to Utility2 Menu	Remove/Clr Trace 1	Zoom M1 Off
	Fast			Main	

A Typical Calibration Pop-up Menu

Some calibrations, such as Offset, have more than one calibration value. Automatic calibration adjusts all the calibrations associated with that parameter.

- To calibrate automatically, touch the **Automatic Calibrate** selector. A message will tell you to either connect the **CALIBRATOR** output to the sampling head channel you are calibrating, or to attach a terminator to the sampling head channel you are calibrating. (For most sampling heads, a 50 Ω terminator is appropriate. Refer to the Installation/User manual for the sampling head.) When you have done as directed, touch the **Proceed** selector. The instrument will calibrate automatically.
- To save the current calibration values, touch the **Store Constants** selector in the pop-up menu. Any time you want to restore the calibration to the stored value, touch the **Recall User Const** selector in the pop-up menu.

## Enhanced Accuracy



Once you assign the knobs to calibrate manually, the knob assignment remains until you change it or go to another major menu. Be careful not to inadvertently change an earlier calibration.

- When the CSA 803 is powered on, the sampling head calibration values are taken from the stored user constants. It is a good idea to store calibration values immediately after you finish each calibration.
- To reset the calibration value to the factory default, touch the **Recall Defaults** selector in the calibration pop-up menu.
- To calibrate manually, you will need to establish a specific trace display before beginning to calibrate. Once the proper trace display is established, press the **UTILITY** major menu button, touch **Page to Enhanced Accuracy** and touch the desired calibration selector in the major menu area. Select the sampling head channel you want to calibrate. Then touch the **Manual Calibrate** selector in the pop-up menu. This assigns the knobs to that calibration. You adjust the knobs to see the effect on the trace. If the pop-up menu is in the way, touch the **Exit** selector to remove it.

### Calibrating Gain Manually

The **Gain** pop-up menu has one selector in addition to the standard ones for calibration pop-up menus. The **Divide By Two Mode** selector turns the trigger divide by two mode on or off. Normal operation of the CSA 803 internal clock requires that this selector be set to **Off**. Set it to **On** only when calibrating gain.

To calibrate gain manually, first establish a display of the calibrator signal on the sampling head channel you want to calibrate. Adjust the vertical size to 50 mV/div and the horizontal size to 500 ps/div. Center the rising edge of the calibrator trace on the graticule. See the illustration on the next page. Touch the **Divide By Two Mode** selector to turn this mode **On**.

Adjust the calibration value to the display that aligns the single line portion of the trace with the bottom of the high-amplitude portion. If several settings qualify, select the setting that gives the highest amplitude.

Remember to turn off the **Divide By Two Mode** after the gain has been calibrated.

Enhanced Accuracy

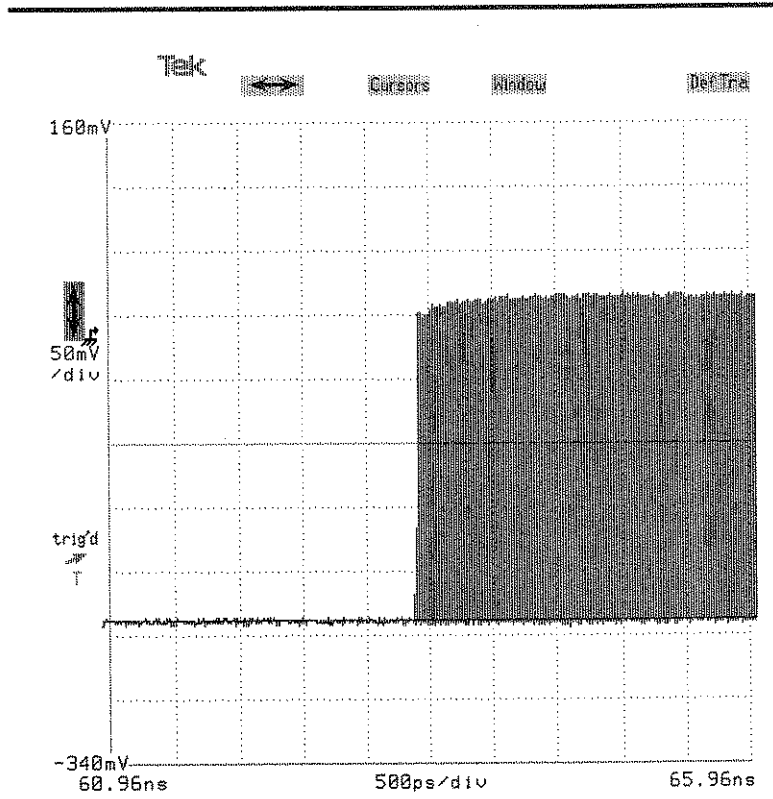
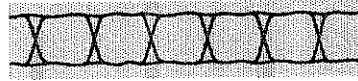

Loop Gain Calibration (in Vectored Trace Mode)

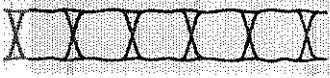

You should calibrate gain before calibrating offset.

### Calibrating Blowby Compensation Manually

To calibrate blowby compensation manually, first establish a display of the calibrator signal on the sampling head channel you want to calibrate. Adjust the vertical size to 50 mV/div and the horizontal size to 500 ps/div. Center the rising edge of the calibrator trace on the graticule.

Adjust the calibration value to the display that gives the flattest horizontal trace segments.

### Calibrating Offset Manually

To calibrate offset manually, first attach a 50  $\Omega$  terminator to the sampling head channel you want to calibrate. Establish a trace showing this channel, with a vertical size of 50 mV/div. Touch the vertical icon ( $\updownarrow$ ) and the **Vert Offset:##** knob label selector to show the Numeric Keypad pop-up menu. On the pop-up menu, touch **0** and **Enter**. This sets the vertical offset to zero, positioning 0 V at the center height of the graticule.

Adjust the calibration value to set the trace exactly on the centerline of the graticule. Repeat the process using a vertical size of 10 mV/div.

There are two offset values to calibrate manually; normal sampling mode and smoothing mode. Calibrate both separately by setting the sampling head in the desired mode before making the calibration. **Smoothing** is selected from the **Sampling Head Fnc's** pop-up menu of the **Waveform** major menu.

### Calibrating TDR Amplitude Manually

To calibrate TDR amplitude manually, first attach a 50  $\Omega$  terminator to the sampling head channel you want to calibrate. Establish a TDR trace showing this channel, with a vertical size of 50 mV/div and a horizontal size of 1 ns/div. Touch the vertical icon ( $\updownarrow$ ) and the **Vert Offset:##** knob label selector to show the Numeric Keypad pop-up menu. On the pop-up menu, touch **0** and **Enter**. This sets the vertical offset to zero, positioning 0 V at the center height of the graticule. Center the rising edge of the pulse horizontally on the graticule.





Adjust the calibration value to set the height of the first part of the trace exactly at the bottom (+ TDR Polarity) or top (- TDR Polarity) of the graticule.

There are two TDR Amplitude values to calibrate manually; one for each polarity of TDR pulse. Calibrate both separately by setting the TDR polarity of the sampling head before making the calibration. **TDR Polarity** is selected from the **Sampling Head Fnc's** pop-up menu of the **Waveform** major menu.

After calibrating TDR amplitude, check to see that the Reference Amplitude (in the **Graticules** pop-up menu) is set to match the voltage calibrated here.

#### Adjusting Delay Adjust Manually

The delay adjust calibration corrects for minor deviations in time coincidence between sampling heads. You select which head you want to use as a reference, and then calibrate the other heads to that standard.

This calibration is a not an attribute of any one sampling head, so the values for this calibration cannot be stored in the heads. There are no **Store Constants** or **Recall User Const** selectors in the **Delay Adjust** pop-up menu.

To establish the reference channel, you select the desired channel in the **Delay Adjust** pop-up menu, and then touch the **Measure Reference Channel** selector. The display will show a message for you to connect the calibrator output signal to the specified channel. When you have done so, touch the **Proceed** selector and the system will measure the delay automatically.

There is no need to calibrate the reference channel manually.

Once you have determined the reference value, you can calibrate the other heads to this value, either manually or automatically.

To manually calibrate delay adjust on other heads, first display the calibrator signal on the *reference* channel, and note the horizontal position of the rising edge. Then, using the same signal, cables and settings, display the signal on either channel of the sampling head that you want to calibrate.

The two channels of dual-channel sampling heads are locked in time coincidence. When you have calibrated one channel, there is no need to calibrate delay adjust on the other.

*Enhanced Accuracy*



The top knob is assigned to the calibration value. Adjust the calibration value so that the signal event is placed at the same horizontal position as on the reference channel.

You can specify whether or not the CSA 803 should automatically maintain the results of delay adjust. Touch the **Delay Compensate** selector of the **Delay Adjust** pop-up menu to set the delay adjust parameter to either **On** (maintain delay adjustment) or **Off** (do not maintain the delay adjustment automatically).



# Eye Diagrams

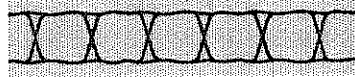

An eye diagram is typically the display of a random digital data signal vs. time, with the display triggered by the data clock. This section provides general instructions to help you display a constellation or eye diagram on the CSA 803.

## Displaying an Eye Diagram

You will need the following equipment:

- At least a single-channel sampling head
- Two SMA cables
- A static protection wrist strap

To display an eye diagram:

- Step 1: Press the **UTILITY** button, touch **Initialize** in the Utility1 major menu, and then touch **Initialize** in the **Verify Initialize** pop-up menu.
- Step 2: Put on the wrist strap and ensure that it is connected to the antistatic connector on the front panel of the CSA 803.
- Step 3: Connect a cable from your data line to channel 1.
- Step 4: Connect a cable from your clock to the **DIRECT** trigger input on the front panel or the **PRESCALE** trigger input. Use the **DIRECT** input for signals of less than 2.5 GHz, otherwise use the **PRESCALE** input for signals up to 10 GHz. Be sure not to exceed the maximum input voltage listed below each of the trigger inputs.
- Step 5: Press the **TRIGGER** button. Touch the **Source** selector in the Trigger major menu. Touch either **External Direct** or **External Prescaler** depending on the connector to which you connected your clock signal. Touch **Exit** to remove the pop-up menu.

## Eye Diagrams

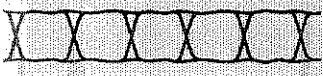

- Step 6: Select channel 1 by pressing the select channel button next to the input connector on the sampling head.
- Step 7: Press the **AUTOSET** button. The signal may not be recognizable at this point.
- Step 8: Because the signal is a random pulse train, the horizontal size cannot be properly auto set. Adjust the horizontal size to display a useful eye diagram.

Eye Diagrams

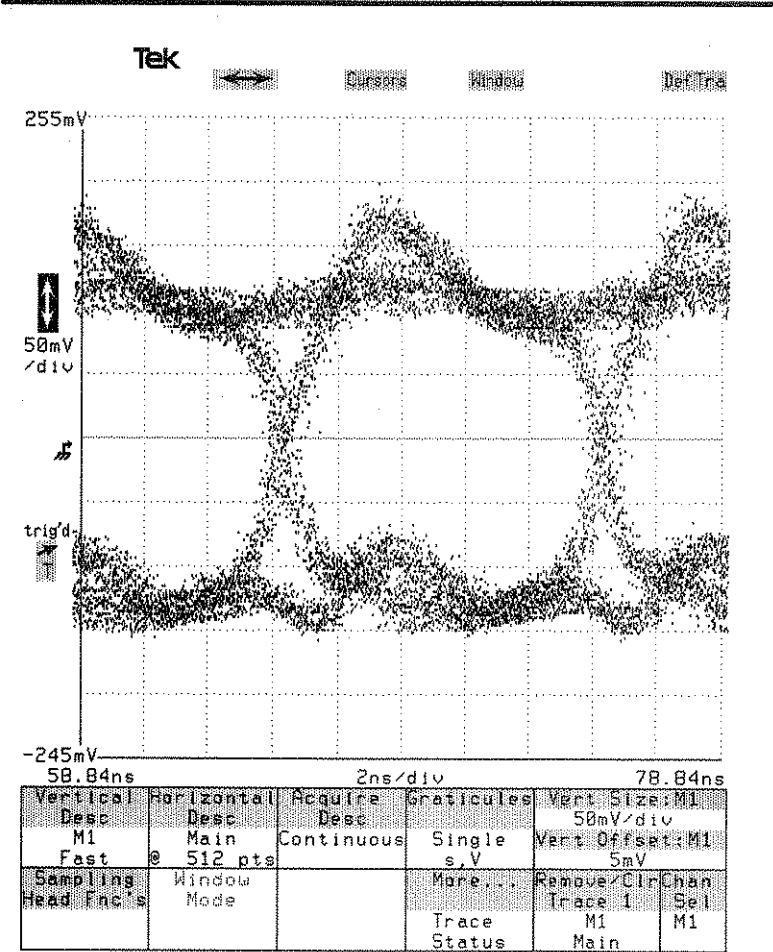

An Eye Diagram Display

## Eye Diagrams



- Step 9: One way to enhance the display of the eye diagram is to use Variable Persistence. To do this, press the **DISPLAY MODES** button, touch the **Persist/Histograms** selector, touch the **Variable** selector in the pop-up menu, and then touch **Exit** to remove the pop-up menu. For additional information on variable persistence, see Setting the Persistence Mode on page 80.
  
- Step 10: One of the most powerful display modes in the CSA 803 is color grading. Color grading adds statistical information to the display by varying the color according to the number of "hits" for a given pixel. Color grading adds a third dimension to the persistence display and allows accumulating data in a statistical database for later analysis with histograms or masks. To turn on color grading, touch the **Persist/Histograms** selector, touch the **Color Grading** selector in the pop-up menu, and touch the **Exit** selector to remove the menu. For more information on color grading, see Setting the Persistence Mode on page 80.

# GPIB Parameters



The CSA 803 can be controlled by a remote computer, through one of two interfaces. These interfaces are industry standards IEEE Std 488 and RS-232-C. IEEE Std 488 is also known as the General Purpose Interface Bus or GPIB.

This manual does not discuss the details of connecting a remote computer to the CSA 803 or the syntax and capabilities of remote commands. That information is found in the *CSA 803 and 11801A Programmer Reference*.

## GPIB Connection

Connect the cable from your GPIB controller (computer) to the **IEEE STD 488 PORT** connector on the CSA 803 rear panel. Three red lights show the internal GPIB status of the CSA 803:

- **SRQ** (Service Request) is lighted whenever the CSA 803 activates the Service Request line. This indicates to the controller that the CSA 803 has requested service.
- **NRFD** (Not Ready For Data) is lighted whenever the CSA 803 is not yet ready for the next data byte.
- **NDAC** (Not Data Accepted) is lighted whenever a data byte is on the bus but has not yet been captured by any listener device.

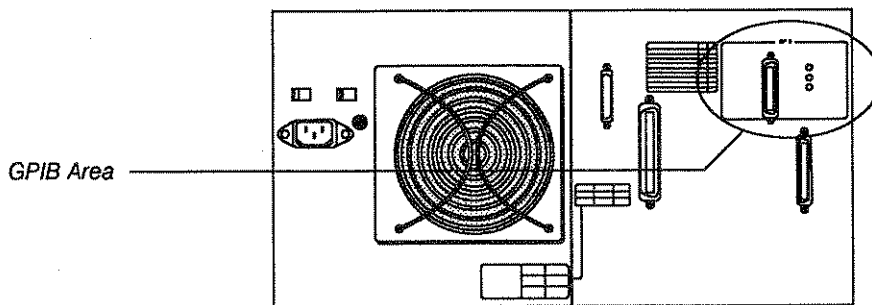

*GPIB Rear-Panel Connector and Lights*

GPIB Parameters

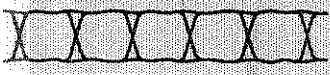

**Setting GPIB Parameters**

Communication between the devices on a GPIB bus can occur only if all bus devices are configured in a compatible manner. For example, each device on the bus must have a unique identifying address.

Use the **GPIB/RS232C** pop-up menu in the Utility1 major menu to set these GPIB parameters directly, before you attempt to communicate with other devices on the bus.

GPIB/RS232C Parameters					
GPIB Parameters		RS232C Parameters			
Mode	Address	Baud Rate	Echo	Stop Bits	
Talk/Listen	1	9600Bd	On	1.5	
Terminator	GPIB Debug	Parity	Flagging	Delay	
EOI	Off	None	Soft	0	
Tek C & F VB1.1		EOL String	Verbose	RS232C Debug	
		CR/LF	Off	Off	
Exit					
<b>GPIB / RS232C</b>	Identify	Color	Hardcopy	Main Size	
			Bitmap Screen	16.523994In/div	
Initialize	Instrument Options	Labeling	Page to	Main Pos	
	16:47:15	Off	Enhanced Accuracy	313.95589In	
	24-APR-90			Trace 1	
				Zoom	
				M1	Off
				Main	

*The GPIB/RS232C Pop-up Menu*

The following list describes each selector in the **GPIB Parameters** section of this pop-up menu:





GPIB parameters are not changed when you initialize the CSA 803.

- **Mode**—lets you set the mode to either **Talk/Listen**, **Talk Only** or **Off Bus**. Off bus effectively disconnects the CSA 803 from the bus. The CSA 803 must be in talk/listen mode to communicate with a controller using the GPIB. Talk only can be used to drive a printer or plotter over the GPIB.
- **Address**—assigns the knobs to the GPIB address of the CSA 803. The GPIB address can be from 0 to 30. No other device on the bus can use the address that you assign to the CSA 803.
- **Terminator**—lets you select between two types of message terminations. All message terminations assert the EOI (End Or Identify) signal in the interface. You can choose to have the CSA 803 recognize a Line Feed (LF) character as a message terminator in addition to EOI, by setting the **Terminator** selector to **EOI/LF**. The CSA 803 will then append a Line Feed character to the end of all messages. Set the **Terminator** selector to **EOI** to have only the EOI line recognized as a message terminator.
- **GPIB Debug**—lets you turn the debugging feature On or Off. When you turn debug on, the CSA 803 displays each command from the GPIB controller as it is executed. The messages appear at the top of the display. Debug off is the normal mode of operation. Set debug on if you need to watch the result of each CSA 803 command of a controlling program running in the GPIB controller. When debug mode is on, it slows the GPIB interface throughput significantly.

*GPIB Parameters*



# Graticules



The grid on the display where traces appear is called a graticule. The graticule axis labels show you the horizontal and vertical scale factors of the selected trace, most often expressed in time per division and voltage per division.

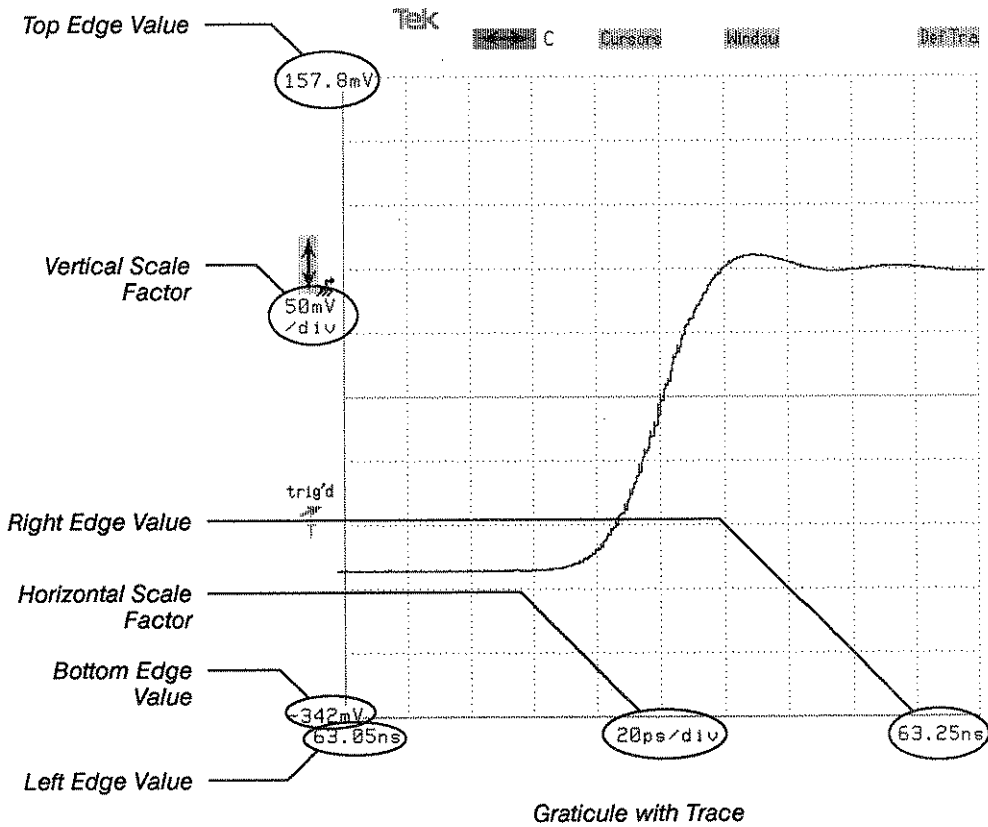

Traces extend outside the graticule area slightly. The axis labels represent the graticule edge, not the trace edge.

If a graticule shows two or more traces, one trace is brighter because it is the trace for which the axis labels are correct. The axis labels are displayed in the same color as this trace. The other traces may or may not share the same axis labels.

## Graticules



You can display two different graticules, each being half the height of a single-graticule display. In this case, each graticule shows one trace brighter than any others on that graticule. In addition, the graticule with the selected trace has the vertical ( $\updownarrow$ ) and horizontal ( $\leftrightarrow$ ) icons. The bright trace on the graticule with icons is the selected trace.

The menu selectors act on and report the status of the selected trace.

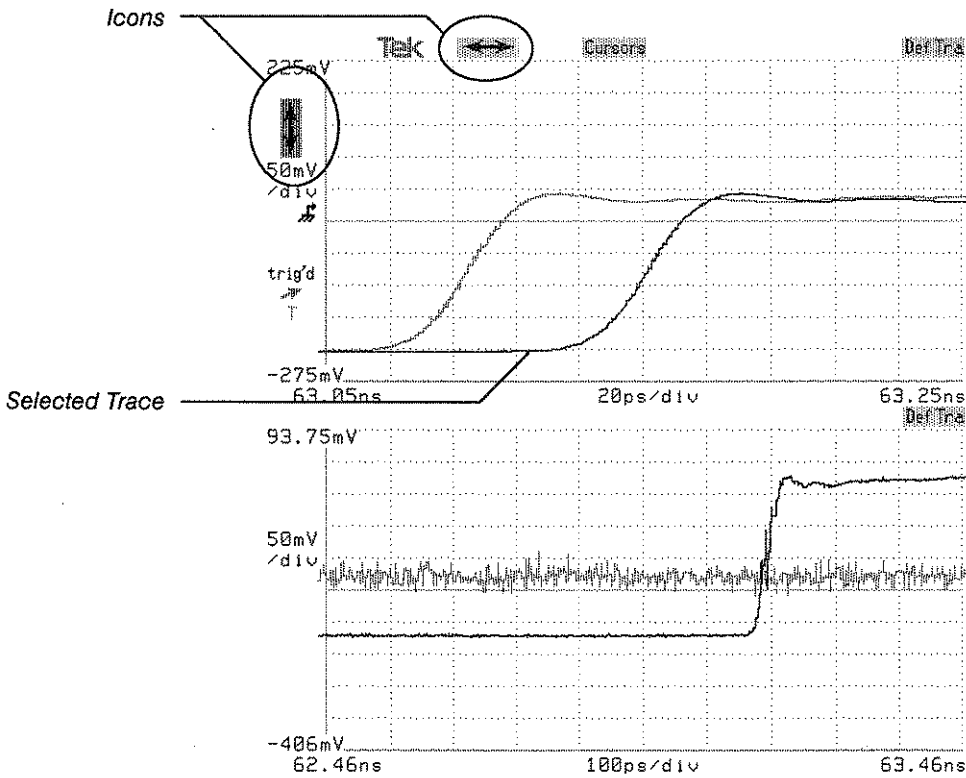

Dual Graticules with Multiple Traces

## Graticules



You can make any trace the selected trace by touching it. If you select the wrong one because the traces are close together, touch again until the desired trace is selected and becomes brightened. Other methods of selecting traces are discussed in Trace Definition and Management on page 235.

You can control the number of graticules, the placement of traces on the graticules, and the graticule axis units by using the **Graticules** pop-up menu in the Waveform major menu. When dual graticules are displayed, the **Graticules** selector is renamed **Upper Graticule** or **Lower Graticule**, depending on which graticule has the icons and the selected trace.

## Graticules



Graticules

Move Trace to Other Graticule

---

Y Units

Volts     Rho

250mV    Off

---

X Units

Seconds     Meters     Feet     Inches

Propagation Velocity

0.7

---

Vertical Desc	Horizontal Desc	Acquire Desc	Graticules	Main Size	Main Pos
M1	Main	Continuous	Single	100ps/div	37.1ns
Fast	@ 512 pts		More...	Remove/Clr	Pan/Zoom
Sampling Head	Window Mode		Trace Status	Trace 1 M1 Main	Off

*The Graticules Pop-up Menu*

## Managing Graticules and Traces

When only one graticule is being displayed, you can create a dual-graticule display using the **Graticules** pop-up menu from the **Waveform** major menu. Touch the **Create Second Graticule** selector in this pop-up menu. The selected trace and all traces from window time bases will be placed on the lower graticule. The upper graticule will show all other traces.



When two graticules are being displayed, you can move the selected trace from the graticule it is on to the other. Touch the **Move Trace to Other Graticule** selector to move the trace. After the trace is moved, it remains the selected trace. The horizontal icon ( $\leftrightarrow$ ) and vertical icon ( $\updownarrow$ ) move to the new graticule.

When two graticules are being displayed, you can combine the traces from both graticules into a single-graticule display. Touch the **Reduce to One Graticule** selector to combine the traces onto one large graticule. The trace that was selected before the operation remains the selected trace on the new single graticule.

When the last trace is removed from the second graticule, the second graticule is automatically removed, leaving a single graticule.

## Changing Axis Units

Usually, the graticule axis labels are units of time on the horizontal axis and units of voltage on the vertical axis. For some tasks these axis labels are more meaningful if expressed in other units. Horizontal units of distance are appropriate for TDR and TDT measurements. The CSA 803 allows you to specify the horizontal axis units to be feet, meters or inches. You can also specify the propagation delay, which is the fraction of the speed of light at which signals travel through your transmission line.

Changing axis units on one graticule also changes the axis units of all graticules displayed.

The vertical axis units most appropriate to TDR measurements are either units of rho ( $\rho$ ) or of impedance ( $Z$ ). The CSA 803 lets you specify units of rho for the vertical axis. Rho values can be converted to impedance values by using the following equation (where  $Z_0$  is usually 50  $\Omega$ ):

$$Z = Z_0 \frac{1 + \rho}{1 - \rho}$$

However, readout of impedance is available from the Cursors menu whenever the vertical axis is scaled in rho units.

The status area of the **Graticules** selector in the Waveform major menu always shows the number of graticules and the axis units of measure.

Rho is not selectable for vertical axis units unless the selected trace is displayed in Volts units and TDR is turned on.

## Graticules



### Vertical Axis Units

To change the vertical axis units, use the **Graticules** pop-up menu in the Waveform major menu. The section of this pop-up menu labeled **Y Units** governs the vertical axis units.

You can touch either the **Volts** or **Rho** selectors to set the vertical axis labels to those units. The current setting is highlighted.

Rho is not selectable unless the following are true:

- The selected trace can be displayed in Volts units, as opposed to U or N units. Traces such as "Log (M1)" or "M1/M2" are not scaled in Volts and therefore cannot be scaled in Rho. Any linear combination of channels and stored traces can be displayed in Volts or Rho.
- TDR must be on in all channels in the selected trace.

The **Reference Amplitude** selector assigns the knobs to control the rho reference amplitude. This has meaning only when the vertical axis units are rho. For TDR measurements, the rho reference amplitude should be set to the absolute amplitude of the TDR pulse sent by the sampling head. A voltage change equal to the reference amplitude corresponds to a change in rho of 1.

The **Baseline Correction** selector is discussed in the Baseline Correction section of this manual. The baseline correction feature of the CSA 803 is used to hold the vertical position of a trace on the display when the TDR pulse level shifts due to a change in termination impedance. This selector appears in the **Y Units** section of the **Graticules** pop-up menu because the feature is most useful when TDR pulses are being started or stopped, causing the trace to shift vertically. Baseline Correction is automatically turned on when **TDR Preset** or **Differential TDR Preset** is selected in the **Sampling Head Fnc's** menu.





### Horizontal Axis Units

To change the horizontal axis units, use the **Graticules** pop-up menu in the Waveform major menu. The section of this pop-up menu labeled **X Units** governs the horizontal axis units.

You can touch the **Seconds**, **Meters**, **Feet** or **Inches** selectors to set the horizontal axis labels to those units. The current setting is highlighted.

The **Propagation Velocity** selector assigns the knobs to let you specify the fraction of the speed of light at which the signal passes through your transmission line or network. Propagation velocity only applies to axis units of distance, and does not apply if your horizontal axis units are seconds.

Propagation velocity is relative to an air-line transmission cable, so a setting of 1.0 indicates that your transmission line or network passes signals at the same speed as an air-insulated cable. The default value of 0.7 applies to most 50  $\Omega$  SMA coaxial cables with plastic dielectric.

*Graticules*

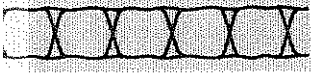

# Hardcopy



A variety of printers and plotters are supported for producing a paper copy of the display. This section will cover how to configure your system for most printers. Also, refer to your printer manual for the proper printer settings.

## Installing the Printer

Connect the printer to the CSA 803. Depending on the printer, you will want to use the **PRINTER** connector, the **GPIB** connector, or the **RS-232-C** connector.

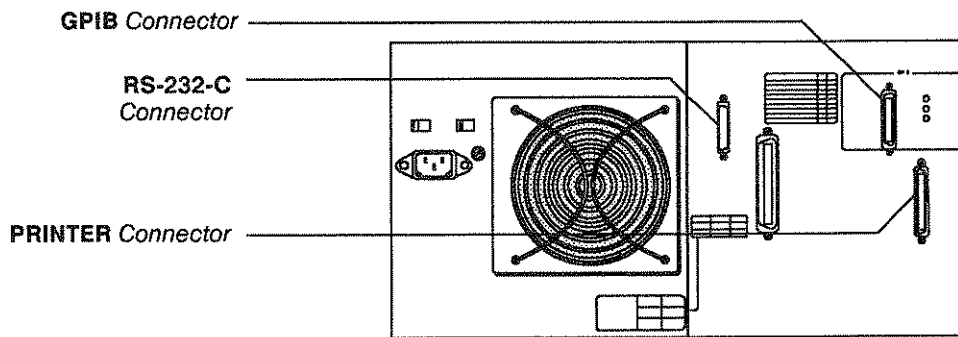

*Printer Connectors on Rear Panel*

- **PRINTER** is the appropriate connector for Centronics®-compatible printers. This is the standard interface for the CSA 803 and no special configuration of the CSA 803 is required.
- **GPIB** is the General Purpose Interface Bus parallel interface connector. Use a standard cable fifteen meters or less in length. If you are not using a controller to initiate the hardcopy, set the GPIB Mode parameter of the CSA 803 to Talk Only and set the printer to Listen Only or Listen Always mode (address 31). Setting GPIB parameters is explained on page 104.

*Hardcopy*

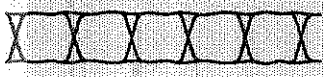

- **RS-232-C** is a serial interface connector. Use a standard, straight-wired cable with male connectors on both ends. Hard flagging is used, so all lines must be connected. Do not use a null modem cable. The CSA 803 acts as a DCE device. Connecting the CSA 803 to a computer also requires a straight-wired cable, but soft flagging may be used.

The RS-232-C parameters baud rate, parity, and number of stop bits, of the CSA 803 should be set to match those of the printer or computer. When you connect a printer to the RS-232-C connector, you may also need to set the RS-232-C flagging to **Hard**. Setting RS-232-C parameters is explained on page 192.



## Hardcopy Parameters

Set the printing properties of the CSA 803 using the **Hardcopy** pop-up menu in the Utility1 major menu. This menu includes selectors for seven types of printers and for specific options available with some printers.

Hardcopy Parameters			
Printer		Color Map	
B Pin	24 Pin	Background Trace	Color 1
Tek 4692	Tek 4696	Graticule/ Trace Selectors	Color 2
Tek 4697	Bitmap Dump	Window Trace	Color 3
Alt InkJet	HPGL	Cursors/ Trace Meas Zones	Color 4
Screen Format	Direction	Data Format	Default Color Map
Screen	Horizontal	BinHex	Compacted
Output Port	RS232C	Hardcopy Abort	
Exit			

GPIB / RS232C	Identify	Color	Hardcopy	Dsw Intensity	60%
			Bitmap Screen	Dsw Intensity	60%
Initialize	Instrument Options	Labeling	Page to	Remove/Clr Trace 1	
	10:32:42	Off	Enhanced Accuracy	M1	Main
	25-APR-90				

### The Hardcopy Pop-up Menu

## Hardcopy



Printer selection and the associated parameters are not affected by initialization.

### Printer Selections

The selectors in the Printer section of the **Hardcopy** pop-up menu determine the printing configuration of the CSA 803. The settings of the other hardcopy parameters will vary according to the printer that is selected. When you change one of these parameters, you are setting its default value for the selected printer type. These settings are not changed when you initialize the CSA 803.

- **8 Pin** supports several eight-pin dot-matrix printers, including the Tektronix 4644, Epson® FX80 and Epson EX800. The IBM® ProPrinter™ and Epson RX80 may also be used, but only the **HiRes** screen format provides useful output for these printers. All the supported printers typically use the **PRINTER** (Centronics) connector.

Set the configuration switches on your printer as recommended in its manual except set No Auto Line Feed, No Perf Skip, and Inbuf On.

- **24 Pin** supports the Extended Epson command set for 24-pin dot-matrix printers, including the Epson LQ500, Epson LQ1000, NEC® P6, and NEC P7. These printers typically use the **PRINTER** (Centronics) connector.

Set the configuration switches on your printer as recommended in its manual except set No Auto Line Feed, No Auto-Carriage Return, No Perf Skip, and Inbuf On.

- **Tek 4692** supports the Tektronix 4692 color graphics copier. The Tek 4693D may also be used when set to 4692 emulation, Full Color, Maximized by Interpolation, and Portrait Mode. These printers typically use the **PRINTER** (Centronics) connector.
- **Tek 4696** supports the Tektronix 4696 and 4695 color inkjet plotters. These printers typically use the **PRINTER** (Centronics) connector.



- **Tek 4697** supports the Tektronix 4697 ColorQuick™ Ink-Jet printer. This printer typically uses the **PRINTER** connector.
- **Bitmap Dump** provides the ability to acquire the screen data for external processing. For example, you can use this option to send the display data to a computer. The format of this information is determined by the **Data Format** selector. (Data format is discussed on page 121.) You will typically want to use the  **GPIB** or **RS-232-C** connector for this type of transfer.
- **Alt Inkjet** supports the HP ThinkJet and HP LaserJet printers. The ThinkJet should be used in HP graphics mode, not Epson emulation mode. For the HP ThinkJet, either **Draft** or **HiRes** screen mode may be used, but **HiRes** mode will be very slow. Only **Draft** screen mode will produce usable output with the HP LaserJet. Either the **PRINTER** (Centronics ) connector, **RS-232-C** connector or the **GPIB** connector may be used.
- **HPGL** supports the HPGL color plotter command set. When **HiRes** is selected under **Screen Format**, an HPGL hardcopy will show graticules, axis labels, all waveforms and the major menus at the bottom of the screen. You can suppress the plotting of the major menus by selecting **Draft** under **Screen Format**. Color graded displays are not plotted with HPGL. Supported plotters include the Tek HC100, HP-7475, and HP-7550. These printers can be connected to the **PRINTER** (Centronics) connector. The HP-7474 and HP-7550 may be connected to the **GPIB** or **RS-232-C** connector.

### Color Map

The selections in the **Color Map** section of the menu become available whenever a color printer or plotter is selected. A color selector is available for selected elements of the display. To change a color, simply select the element in the menu, then use the control knobs or keypad pop-up menu to adjust the setting. To restore the color map to its factory default settings, touch the **Default Color Map** selector.

## Hardcopy



The color selections are expressed in terms appropriate to the selected printer. When **Tek 4692** is selected, the colors are expressed as hexadecimal RGB values. For the **Tek 4696** selection, thirteen color name selections are available. **HPGL** supports pen numbers 0 to 8.

### Screen Format

The **Screen Format** selector provides several qualities of hardcopy output. Different format selections are available for different printer types.

- **HiRes** produces an enhanced contrast display on printers with limited gray-scale capability. Selected items, including windows, are highlighted for easy identification.
- **Draft** produces hardcopies faster than **HiRes** mode, but sacrifices some gray-scale capability.
- **Reduced** produces low-resolution hardcopies a quarter of the size of **Draft** hardcopies. Advantages are quicker printing and use of less memory.
- **Screen** produces an exact color replica of the screen without reformatting to enhance features. Available for color printers and plotters only.
- **Dithered** reduces saturation and increases contrast by dithering icons and selector backgrounds. May be used with **Tek 4692**, **Tek 4696**, **Tek 4697**, and **Bitmap Dump**.





### Direction

The **Direction** selector controls whether information is sent to a printer as horizontal rows or as vertical columns. For most printers, this has the effect of rotating the image by 90°. Some printers will produce an image more quickly in one direction than in the other. When **Direction** is set to **Horizontal**, screen information is sent to the printer by horizontal rows starting at the top left corner of the display. When it is set to **Vertical**, the information is sent by vertical columns starting at the bottom left corner of the display.

### Data Format

When **Bitmap Dump** is selected, the screen data is transferred as an ASCII title block followed by a pixel data block. The format of the pixel data is determined by the **Data Format** setting. Touch this selector to cycle through the four available formats.

- **Binary** mode bytes of pixel data are sent as a stream of binary values without delimiters.
- **Binary Compacted** mode pixel data are compressed before being sent. See the discussion of compression, below.
- **BinHex** mode converts every four bits into a hexadecimal character. Each line is terminated by a new-line character.
- **BinHex Compacted** mode pixel data are compressed and then converted into BinHex characters.

**Title Block** – consists of three character strings terminated by new-line characters. The first line contains the firmware version numbers, time and date, and the CSA 803 ID number. The second and third lines give the number of pixels per display line and the number of display lines, respectively. In **Binary** mode, the title block is terminated by a NULL character.

## Hardcopy



**Pixel Data Compression** – significantly reduces the size of the pixel data block. Without compression, each data byte contains a single three-bit pixel. With compression, two pixels are stored in the six low-order bits of the data byte, and the two high-order bits are a repetition encoding with the following meaning:

### Repetition Encodings

Bit 7	Bit 6	Meaning
0	1	Pattern repeats once
1	0	Pattern repeats twice
1	1	Pattern repeats three times
0	0	Following byte(s) contain repetition count

If the second byte of the pixel block has a value in the range 4-225, it is the pattern repetition count. If the value is 1-3 decimal, it is the high order bits of a 10-bit repetition count, and the third byte of the pixel block contains the eight lower-order bits.

### Output Port

The **Output Port** selector allows you to choose **GPIO**, **RS232C**, or **Centronics** (the **PRINTER** connector). The selection must match the rear panel connection.

### Making a Hardcopy

Once you have installed a printer and configured the CSA 803 properly, you can make a hardcopy of the screen by pressing the **HARDCOPY** button on the front panel.

The  
**HARDCOPY**  
Button

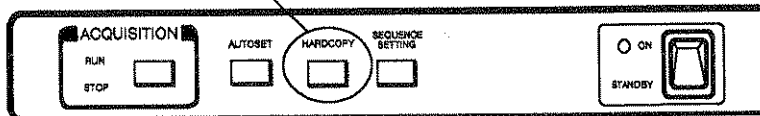

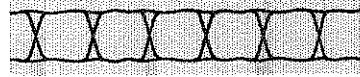

When you press the **HARDCOPY** button, the display freezes for a short time. The shades of intensity on the display may be altered. The printer starts printing immediately.

The length of time that the display is frozen depends on the hardcopy mode, complexity of the display, and memory available for hardcopies. During this pause the CSA 803 formats and buffers the print commands.

After the pause, the CSA 803 returns to normal operation and continues to print the hardcopy. When the display becomes active again, you may operate the CSA 803 without affecting the hardcopy being printed.

You can also initiate a new hardcopy at this point. The CSA 803 will automatically queue multiple screen displays for hardcopy output. The number of hardcopies that can be queued is subject to the amount of available memory.

When the hardcopy is printed, a message is displayed. The hardcopy is not complete until this message appears. You should not turn off the CSA 803, perform self-test diagnostics, or use the Extended Diagnostics menu until the hardcopy is complete, or the hardcopy will be terminated before it is finished.

You can terminate a hardcopy by selecting **Hardcopy Abort**, in the **Hardcopy** pop-up menu. A message will appear stating that the hardcopy has been cancelled.

You can also terminate the hardcopy while the screen is still frozen by pressing the **HARDCOPY** button a second time.

Do not turn off the CSA 803 or perform diagnostics until the hardcopy is complete.

### **Terminating A Hardcopy In Progress**

## Hardcopy



### Hardcopy Defaults

The following table summarizes the factory default settings associated with each printer selection in the **Hardcopy** pop-up menu. These settings are not affected by initialization.

*Hardcopy Defaults*

Printer	Screen Format	Direction	Data Format	Output Port
8 pin	HiRes	N/A	N/A	Centronics
24 pin	HiRes	N/A	N/A	Centronics
Tek 4692	Screen	Vertical	N/A	Centronics
Tek 4696	Dithered	Vertical	N/A	Centronics
Tek 4697	Dithered	Horizontal	N/A	Centronics
Bitmap Dump	Screen	Vertical	BinHex Compacted	Centronics
Alt Inkjet	Draft	Horizontal	N/A	Centronics
HPGL	HiRes	N/A	N/A	Centronics

The default settings for the color map associated with a color printer setting may be recovered by selecting **Default Color Map** in the **Hardcopy** pop-up menu.

# Histograms



The CSA 803 can display histograms constructed from the selected trace's waveform data. You can display either a vertical (voltage) or horizontal (time) histogram. Only one type of histogram can be displayed at a time.

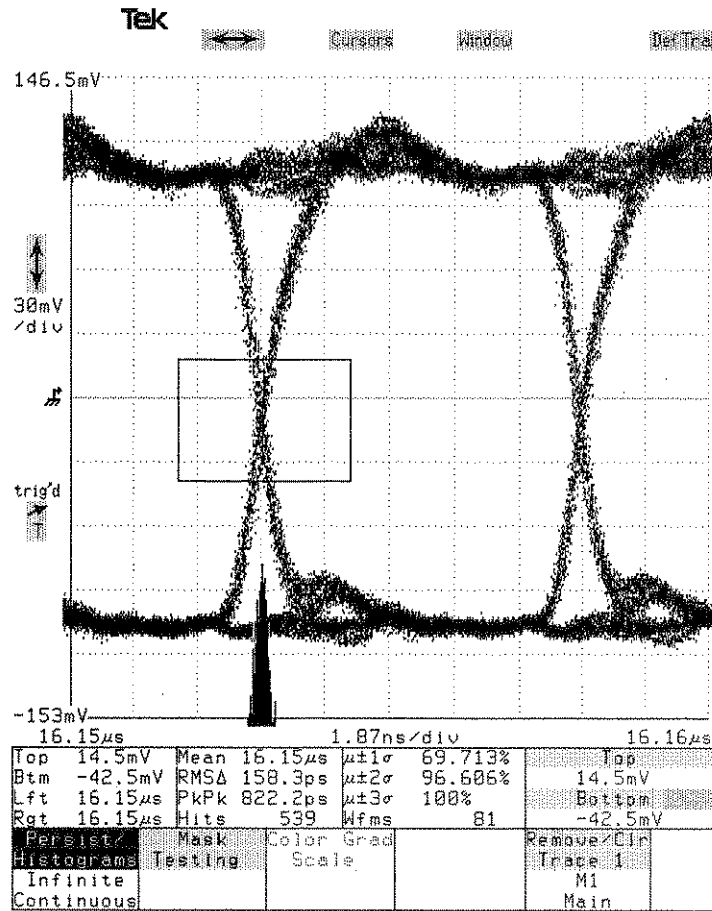

A Histogram Displayed on an Eye Diagram

## Histograms



To create a histogram, use the **Persist/Histograms** pop-up menu. You can specify the section of the selected trace used to determine the histogram and set histogram scaling to either linear or logarithmic. You can specify that acquisition stop after a set number of trace acquisitions or after a set number of samples have been acquired.

Persistence/Histograms					
Normal	Persist Time	Refresh Rate			
	3s	6s			
Variable	Set N Waveforms	Stop N Waveforms			
	1000				
Infinite	Set N Samples	Stop N Samples			
	10000				
Color Grading	Set N MaxContrast	Stop N MaxContrast			
	1				
Vertical Histogram	Vertical Limits	Histogram Scaling			
		Linear			
Horizontal Histogram	Horizontal Limits				
Display Intensity	Vectorized Trace				
60%	On				
Clear	Exit				
				Vert Size:M1	
				50mV/div	
				Vert Offset:M1	
				-132.5mV	
Persist/Histograms	Mask Testing	Color Grad Scale		Remove/Cln Chan	
Infinite				Trace 1 Sel	
Continuous				M1 M1	
				Main	

*The Persist/Histograms Pop-up Menu*



## Displaying a Histogram

To turn on the histogram display, press the **DISPLAY MODES** button, touch **Persist/Histogram** and then touch either the **Vertical Histogram** or **Horizontal Histogram** selector. This changes the display mode to infinite persistence if the current mode is normal or variable. If the current display mode is color graded, it won't change. When the histogram display is turned on, the waveform record length is set to 512 points. If the record length was greater than 512, you will see a message informing you of the change in record length.

A rectangular box, used to specify the section of the selected trace used to generate the histogram, is displayed when histograms are turned on. If the display is in color graded mode when the histogram display is turned on, the histogram is initialized with data from the color graded display.

Note that the color graded display does not make a distinction between the selected trace and non-selected traces when the histogram is initialized with data from the color graded display. Thus it is possible to get samples from non-selected traces in the histogram data (if the histogram box encompasses any non-selected trace). Therefore, when using the color graded mode, display only one trace or maintain enough vertical separation between traces so they don't overlap. Also, histograms can be displayed (calculated) after waveforms have been accumulated in color graded mode (even if acquisition has been stopped), whereas they cannot in infinite persistence mode.

By using dual graticules, you can acquire histograms on two traces simultaneously. Display one trace on each graticule, and set up a histogram for each trace. Only the histogram for the selected axis is displayed, but both are acquired.

## Histogram Controls

The histogram display can be affected by several controls. You can specify which part of the selected trace is used to calculate the histogram. You can stop acquisition based on the number of waveforms acquired or the number of histogram samples acquired. You can set how often the histogram display is updated with new data and you can set scaling to logarithmic or linear. All the histogram controls are located in the **Persist/Histograms** pop-up menu.

## Histograms

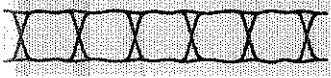

### Changing the Size of the Histogram Box

To change the section of the selected trace used for the histogram, touch either **Vertical Limits** or **Horizontal Limits**. Touching the **Vertical Limits** selector assigns the top knob to **Upper Limit** and the bottom knob to **Lower Limit**. Touching **Horizontal Limits** assigns the top knob to **Left Limit** and the bottom knob to **Right Limit**. Turning either knob will change the position of the assigned edge of the histogram box, thus limiting the part of the selected trace used for the histogram.

The vertical and horizontal limits of the histogram box can be set without turning on the histogram display. To set the size and location of the histogram box without turning on the histogram display, touch either **Vertical Limits** or **Horizontal Limits** first without touching either the **Vertical Histogram** or **Horizontal Histogram** selector. This way, you can set up your histogram limits before you begin acquiring your data.

Histogram limits are set separately for each displayed trace. And because a histogram applies only to the selected trace, if you select a different trace, the histogram display will disappear. If you then reselect the original trace, the histogram display will reappear. This enables you to display several traces, each with a different histogram display. (Remember that only one histogram, that of the selected trace, can be displayed at a time.)

Histogram limits are expressed in axis units (usually volts and seconds), but are actually determined by screen position. The histogram limits will remain fixed on the screen regardless of changes in vertical or horizontal size and position.





### Limiting Acquisition

You can limit acquisition based on either the number of waveforms or the number of samples, or “hits,” acquired in the histogram. These functions are controlled by the **Set N** and **Stop N** selectors in the **Persist/Histograms** pop-up menu.

To limit acquisition based on the number of waveforms acquired, display the **Persist/Histograms** menu and touch **Set N Waveforms**. This assigns the knobs to limit the number of waveforms acquired. The range for the number of waveforms acquired is 1 to  $2^{32}-1$  (approximately four billion). To begin conditional acquisition, touch **Stop N Waveforms**. Acquisition will stop when N waveforms have been acquired.

The number of waveforms left to acquire is shown in the lower-left corner of the display.

To limit acquisition based on the number of histogram hits, first touch **Set N Samples**. This assigns the knobs to limit the number of samples acquired. Using the knobs, set the number of samples you wish to acquire. The range for the number of samples acquired is 1 to  $2^{32}-1$  (approximately four billion). To begin acquisition, touch **Stop N Samples**. Touching this selector starts acquisition, which then continues until N samples have been acquired.

The number of samples left to acquire is shown in the lower-left corner of the display.

Thus, there are two steps to stop acquisition based on the number of samples acquired:

- Step 1: Set the number of waveforms or samples using **Set N Wfms** or **Set N Samples**.
- Step 2: Begin the acquisition by selecting **Stop N Wfms** or **Stop N Samples**.

If you want to stop the acquisition before the conditional acquisition completes, press **RUN/STOP**.

Histograms



The data that appears in the histogram readout is calculated as waveforms are acquired. The histogram display is updated based on the Refresh Rate.

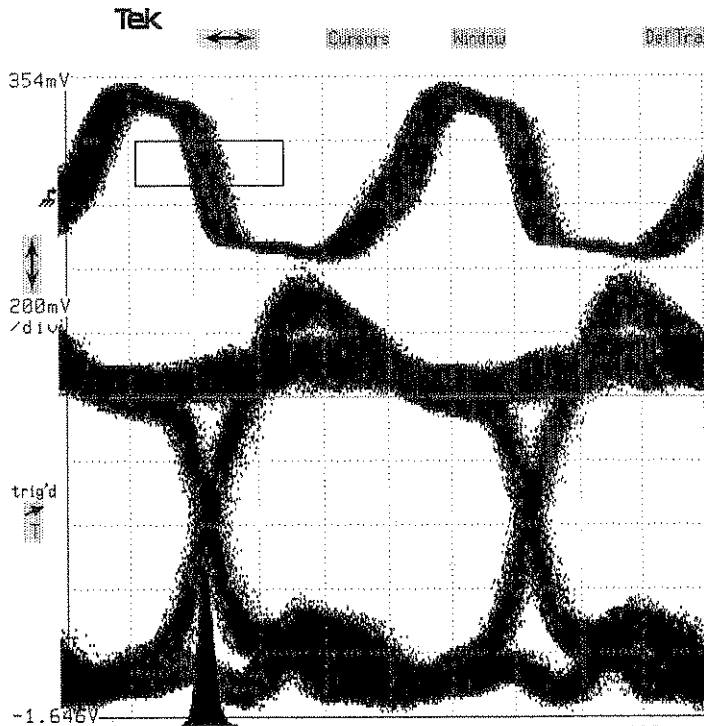

Number of waveforms or samples left to acquire is shown here

Top	154mV	Mean	506.4ns	$\mu\pm 1\sigma$	71.811%	Waveform N	
Btm	14mV	RMSA	245.2ps	$\mu\pm 2\sigma$	95.625%		1000
Lft	504.3ns	PkPk	1.76ns	$\mu\pm 3\sigma$	99.656%	Waveform N	
Rgt	506.9ns	Hits	4357	Wfms	446		1000
Persist	Mask	Color	Grad			Remove/Clr	
Histograms	Testing	Scale				Trace 2	
Infinite						M2	
#Wfm	314					Main	

Using Stop N Wfms

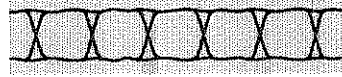

### Changing the Refresh Rate

The rate the histogram display is updated can be varied from five seconds to three minutes (180 seconds). To change how often the histogram is updated, touch **Refresh Rate**. You can now turn either of the control knobs to change the time between updates or you can use the knob pop-up menu to enter the time directly.

### Changing Scaling

You can set the histogram scaling to either linear or logarithmic. To change the histogram scaling, touch **Histogram Scaling**. Linear scaling better illustrates the relative quantity of various data, while logarithmic scaling provides better detail at the edges of the histogram. Histogram scaling is a display feature; it does not affect the histogram data.

## Histograms



### Clearing the Histogram Data

To clear the data in the histogram display, touch the **Clear** selector in the **Persist/Histogram** pop-up menu or touch the **Clear Trace** selector in the **Remove/Clr** pop-up menu

Histograms cannot be displayed for stored traces. Histograms can be displayed for calculated traces if the calculated trace contains at least one active channel, even if the calculated trace contains a stored trace.

### The Histogram Readout

In the major menu area of the display is a readout of histogram characteristics. Included in the display are the values for the position of each of the sides of the histogram box, statistical values and measurements.

---

Top	14.5mV	Mean	16.15 $\mu$ s	$\mu\pm 1\sigma$	68.948%
Btm	-42.5mV	RMS $\Delta$	171ps	$\mu\pm 2\sigma$	97.822%
Lft	16.15 $\mu$ s	PkPk	1.040ns	$\mu\pm 3\sigma$	100%
Rgt	16.15 $\mu$ s	Hits	1821	Wfms	282
Persist	Mask	Color	Grad		
Histograms	Testing	Scale			
Infinite					
Continuous					

### Histogram Readout Appears Below the Trace Display

- Top, Btm, Lft, and Rgt represent the position of each of the sides of the histogram box, in appropriate axis units. That is, Top and Btm values are given in volts; Lft and Rgt are given in seconds.
- Mean is the average value of all the acquired points within the histogram box. Pk-Pk is the difference between the most positive acquired point and the least positive acquired point, when Vertical Histogram is selected. When horizontal Histogram is selected, Pk-Pk is the difference between the left-most data point and the right-most data point within the histogram box.

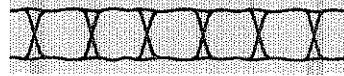

- $RMS\Delta$  is the RMS deviation (also known as standard deviation).  $\mu \pm 1\sigma$  represents the percentage of waveform points which fell within one standard deviation of the mean.  $\mu \pm 2\sigma$  and  $\mu \pm 3\sigma$  represent the percentage of waveform points which fell within two and three standard deviations of the mean, respectively.
- $Wfms$  is the number of waveforms that have been acquired since the histogram display was turned on.  $Hits$  is the number of waveform data points that have fallen inside the histogram box.

*Histograms*



# Horizontal Controls

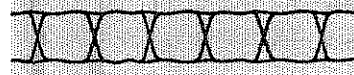

The horizontal controls let you set the horizontal size and placement of your traces. Touch the horizontal icon (↔) to access these controls.

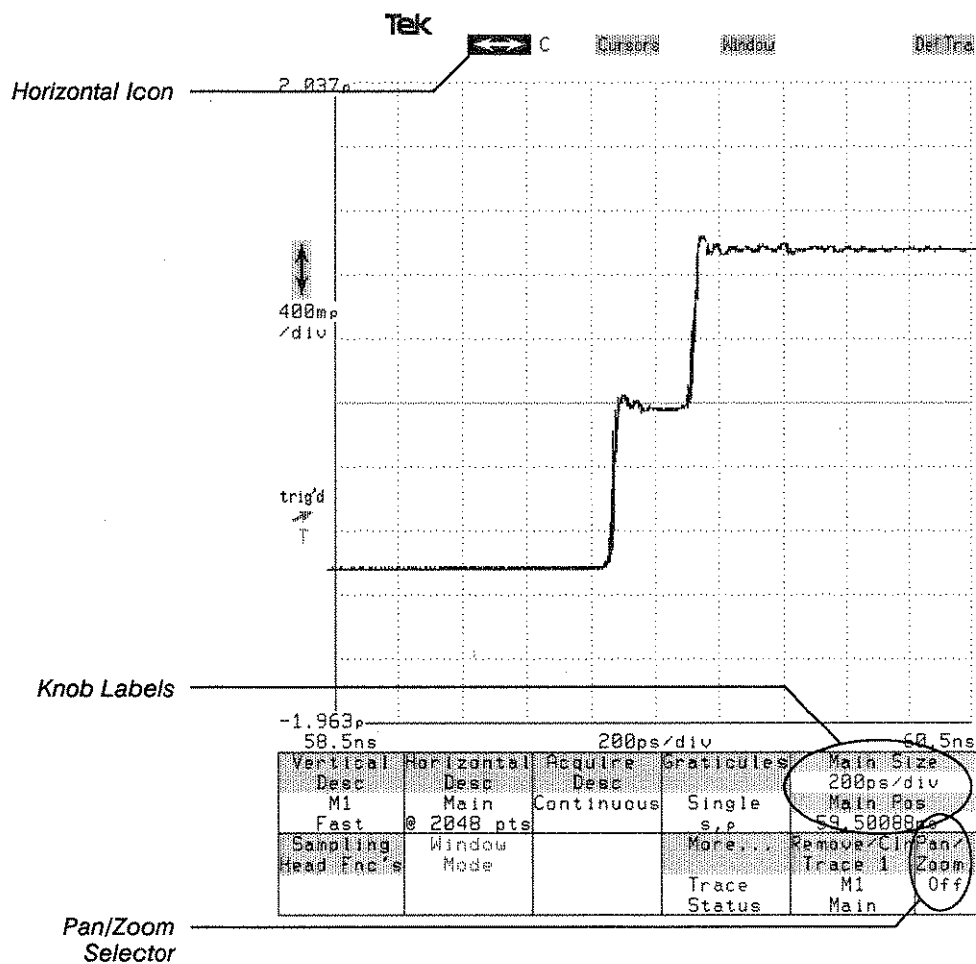

Horizontal Controls



### Setting Horizontal Size and Position

Touch a knob label to display the Keypad pop-up menu. This lets you set horizontal size and position numerically, or quickly set them to maximum or minimum limits. It also lets you set the knob resolution.

You can change the horizontal magnification, or *size*, of a trace. You can also move the trace left or right to see different portions of the trace. This is called adjusting the horizontal *position*. To do either of these, touch the horizontal (↔) icon. This assigns the knobs to adjust the horizontal size (top knob) and position (bottom knob) of the selected trace.

The axis label for the left edge of the graticule is slightly different than the horizontal position of a trace. This is because traces extend slightly beyond the edges of the graticule. The illustration on the previous page shows the main position (the knob label) is 59.5 ns, and the left edge of the graticule is 58.5 ns.

If you want to change the size or position of a different trace, touch the desired trace to select it. Then you can use the knobs to adjust horizontal size and position.

### Interactions With Other Traces

The knob labels tell you whether the selected trace is from the main time base or a window time base.

All traces from the main time base share the same size and position. If you change the size or position of one main trace, you will change the size or position of all of main traces.

All traces from window time bases have the same horizontal size. If you change the horizontal size of one window trace, you will change the horizontal size of all window traces. Each window trace can have a unique horizontal position.





## Pan/Zoom

Pan/Zoom does not change the way trace data is sampled and recorded, it only changes the way the trace data is displayed.

Pan/Zoom allows you to magnify any portion of the selected trace to examine it more closely. You can magnify (zoom) the selected trace to the point where each digitized sample appears on the display, and you can move the magnified trace left and right (pan) to examine any part of the trace.

The maximum magnification is determined by the trace record length, which is described in the Record Length section of the user reference manual. The trace display area is 512 pixels wide, so you can magnify a 5120-point trace up to 10 times. A 512-point trace already displays only one digitized sample per pixel, and cannot be magnified.

Whenever the  $\leftrightarrow$  icon is highlighted, the lower right corner of the display shows the **Pan/Zoom** selector. Normally, Pan/Zoom is **off**, and the knobs are assigned to horizontal size and position. When you touch the **Pan/Zoom** selector to set it **on**, the knobs are assigned to **Horz Mag** (Zoom) and **Horz Pos Gr** (Pan).

You use the top knob, **Horz Mag**, to specify how much magnification you want on the selected trace. You use the bottom knob, **Horz Pos Gr**, to position the segment of the trace that you want to view onto the display. The knob label status area shows how many trace data points are not shown because they are off the left end of the screen. When you set **Horz Pos Gr** to zero, you display the leftmost portion of the trace.

You can use horizontal magnification to see the exact data points of a trace record. Set horizontal magnification to the maximum and turn off trace vectoring. Trace Vectoring is discussed in the **Vectored Traces** section of the user reference manual. The display will show each sampled data point of the trace.

Horizontal Controls

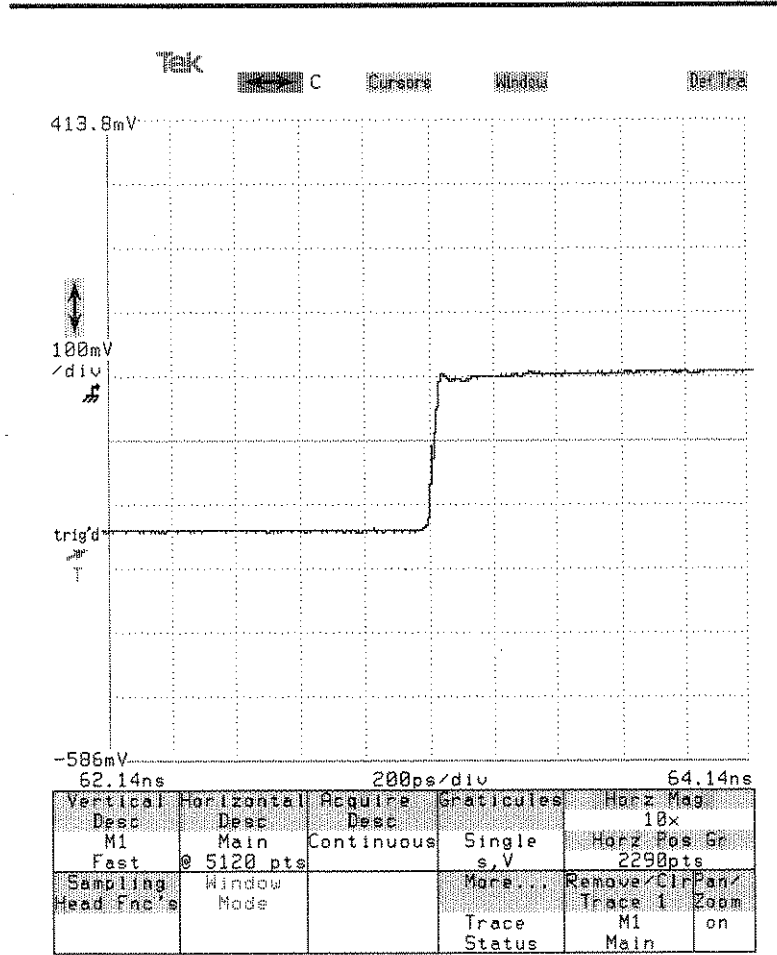

Horizontal Magnification with Pan/Zoom



## Changing the Horizontal Reference Point

When you change the horizontal size of a trace, you magnify or compress the horizontal scale. Normally, the same point of the trace shows at the left edge of the display after the horizontal size is changed. The point about which the expansion or contraction of the trace occurs is called the horizontal reference point.

You may find that having the horizontal reference point at the left edge of the display is not appropriate for your task. For example: you have a trace that shows a rising edge of a pulse near the center of the display. When you increase the horizontal size of the trace, the rising edge moves off the right edge of the display. You must move the trace to the left with horizontal position in order to view the rising edge of the pulse at its new size.

You can change the horizontal reference point to keep the interesting portion of the trace on the display whenever you change horizontal size. In the example above, before you changed the horizontal size, you could change the horizontal reference point to the center of the display. Then, the part of the trace that was in the center of the display remains in the center of the display after the horizontal size changes. The current setting for horizontal reference point is indicated by a letter next to the horizontal icon ( $\leftrightarrow$ ). L indicates the horizontal reference point is set to Left, C indicates Center and R indicates Right.

The horizontal reference point applies only to horizontal size. In Pan/Zoom mode, the **Horz Pos Gr** setting serves a similar purpose.

Use the **Horizontal Desc** pop-up menu of the Waveform major menu to control the horizontal reference point. The pop-up menu has three selectors in the section labeled **Horizontal Reference Point: Left, Center, and Right**. The selector for the current setting is highlighted. Touch the selector that corresponds to the setting you want.

## Horizontal Controls



In some cases, changing the horizontal size control (time per division) may force the horizontal position to change. For example, with the reference point set to Center, small main position settings may cause the first point of the record to reach the minimum delay for the trigger point. Further increases in the main size will cause the horizontal position to be moved to maintain the minimum delay for the first sample of the record. However, the oscilloscope remembers any forced horizontal position changes and restores the position to its original location when the main size is set to smaller values. If the user adjusts the main position, when the setting has been forced to change, the CSA 803 *does not* restore the old position when main size is decreased.

## Horizontal Controls



Horizontal Description					
Acquiring Timebase: Main Main Sample Interval: 2ps/point Window Sample Interval: 200fs/point Main Record Length: 512 points Window Record Length: 512 points					
Horizontal Reference Point					
Left		Center		Right	
XY Display Mode: X=Acquired Trace					
Trace 1 M1 Main				Normal YT	
XY Display Mode: X=Stored Trace					
Exit					
Vertical Desc	Horizontal Desc	Acquire Desc	Graticules	Main Size	Main Pos
M1 Fast	Main @ 512 pts	Continuous	Single s,v	100ps/div	37.1ns
Sampling Head Fnc's	Window Mode		More...	Remove/Clr Trace 1 M1	Par/ Zoom Off
			Trace Status	Main	

### The Horizontal Desc Pop-up Menu

*Horizontal Controls*



# Initialization



Whenever you begin a new task using the CSA 803, you should initialize the system so that all settings are at “factory default.” That way you do not get unexpected results because of settings remaining from the last use of the CSA 803.

To initialize the system settings to default, touch the **Initialize** selector in the Utility1 major menu, then touch Initialize in the Verify Initialize pop-up menu.

Verify Initialize					
Initialize		Cancel			
GPIB / RS232C	Identify	Color	Hardcopy	Main Size	1.87ns/div
			Bitmap Screen	Main Pos	16.14521µs
Initialize	Instrument Options	Labeling	Page to	Remove/Clr	Pan/Zoom
	14:25:13 26-APR-90	Off	Enhanced Accuracy	M1	Off

*The Initialize Verification Pop-up Menu*

An alternate method to initialize is to select **Initialize Setting** in the **Recall Setting** pop-up menu in the Store/Recall major menu.

The following settings are *not* affected when you initialize:

- Stored traces and stored settings
- Sampling head calibration values
- Time and Date
- The following GPIB parameters: Address, Mode, and Terminator
- The following RS-232-C parameters: Baud Rate, Echo, Stop Bits, Parity, Flagging, Delay, and EOL String
- Hardcopy parameters

## Initialization



### Initializing and Erasing Nonvolatile RAM

You can erase all information stored in nonvolatile RAM by holding down the **WAVEFORM** and **TRIGGER** major menu buttons when you turn on the CSA 803. Release the buttons when the lights next to the major menu buttons stop flickering. When the power-on sequence is complete, the message "Teksecure Erase Memory Status: erase, instrument ID, on-time, and number of power-ups retained" will appear on the display.

When nonvolatile RAM is erased in this manner, the CSA 803 writes over all nonvolatile RAM locations where settings can be stored with the hexadecimal value FFFF and writes the hexadecimal value ABCD over all locations where traces can be stored. Any Enhanced Accuracy calibration of the CSA 803 is lost.

The following information is *not* lost when nonvolatile RAM is erased:

- Serial number of the CSA 803
- Accumulated time the CSA 803 has been on
- Number of times the CSA 803 has been powered on
- Factory calibration constants, which are established at the factory and cannot be changed by the user or by the CSA 803
- Time and Date



# Labeling



You can label active traces, stored traces, and stored settings for easier identification.

A label is a string of up to ten letters, numbers, or spaces that appears next to a displayed trace or as part of a trace or stored setting selector in menus.

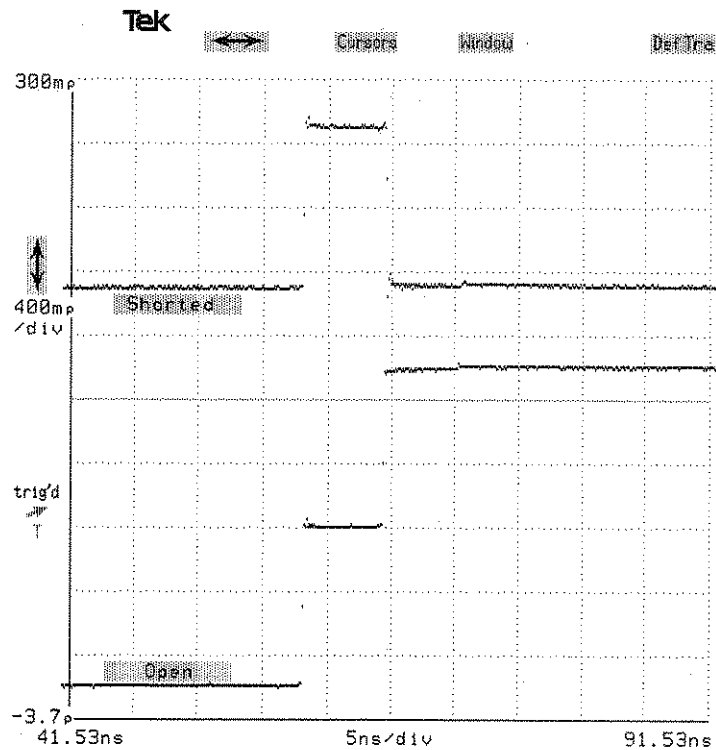

*Labels Displayed with Active Traces*

## Labeling



### Creating Labels

You can create and edit labels by using the **Labeling** pop-up menu, shown on the next page. Select **Labeling** in the **Utility 1** major menu to display the pop-up menu. The uppermost section of this menu contains selectors for **Displayed Traces**, **Stored Traces**, and **Stored Settings**. Beneath these selectors, the selectors for individual active traces, stored traces, or stored settings appear. If there are more stored traces or stored settings than can be displayed at once, use the **Page↑** and **Page↓** selectors to scroll through the menu.

To create or change a label, select the item you want to label from the **Labeling** pop-up menu. For example, select **Stored Trace**, then select the stored trace you want to label. You can then type the label by touching the character selectors in the lower half of the menu. (Letters are laid out as if they were on a standard keyboard.) The selectors beneath the characters allow you to choose **Upper Case** letters, **Lower Case** letters, **Numbers** (which include some punctuation and symbols), **Graphics**, **Greek** letters, or **Other** characters. You can mix character types within a label. As you type, the label appears in the selector, just below the trace or setting number. A maximum of 10 characters can be used for a label.

Use the **Back Space** selector to correct errors as you type a label. Touch **Erase** to completely erase the selected label. Use the **Exit** selector to leave the pop-up menu. When you leave the pop-up menu, new labels are entered automatically. If you want to enter a label without leaving the **Labeling** menu, touch the selector for the labeled item in the menu.

You cannot use the same label for two items of the same type (for example, two active traces or two stored traces). If you attempt to enter a duplicate label, the error message "Duplicate label" appears on the display and the previous label is restored.

You can use automatic labeling if you don't want to enter labels yourself. Automatic labeling labels the trace with its trace description. For example, if you turn on channel 2, the label attached to the trace will be M2. If you define a trace using the **Def Tra** pop-up menu, the label will be the trace description, up to 10 characters. To enable automatic labeling, touch the **Label Mode** selector to set it to automatic.

You cannot enter the same label for two items of the same type.

## Labeling



When you store a labeled trace, or create an active trace that displays a stored trace, the label will be copied to the new trace unless this would duplicate a label on another trace in the same class.

Labeling				
Displayed Traces	Stored Traces	Stored Settings		
Trace 1		Label Mode		
M1		Manual		
Main		Display		
		Off		
		Position		
Q	W	E	R	T
Y	U	I	O	P
A	S	D	F	G
H	J	K	L	:
Z	X	C	V	B
N	M	<	>	? Space
Upper Case	Numbers	Greek	Erase	Back
			Space	Exit
Lower Case	Graphics	Other		
GPIB / R5232C	Identify	Color	Hardcopy	Year Set
			Bitmap Screen	Year Set
				90
Initialize Instrument Options	Labeling	Page to	Remove/Clr Trace 1	
14:13:14	Off	Enhanced Accuracy	M1	
18-APR-90			Main	

### The Labeling Pop-up Menu

## Labeling



### Displaying Labels with Traces

Changing the trace description of an active trace will not change the label of the trace.

Labels of displayed traces may be displayed on the screen with the traces. When **Displayed Traces** is selected, **Display** and **Position** selectors appear to the right of the trace selectors in the **Labeling** pop-up menu. Turning on **Display** will cause the labels to appear with the traces. Labels will appear in the selectors for all traces whether **Display** is turned on or off.

Labels that are displayed on the screen move with the traces. You can position each label relative to its trace. Select **Position** to assign the knobs to set the vertical (top knob) and horizontal (bottom knob) position of the label. The label position is relative to a specific point on the trace. By changing the horizontal position of the label, you are changing the point the label will follow. By changing the vertical label position, you can specify the vertical offset of the label from the point. If the trace record point is out of the range of the graticule, the label will remain at the top or bottom of the graticule.

You can select a trace by touching its displayed label.

# Mask Testing



The CSA 803 enables you to perform mask testing using the **Mask Testing** pop-up menu. The **Mask Testing** menu allows you to create, edit, delete, and activate masks.

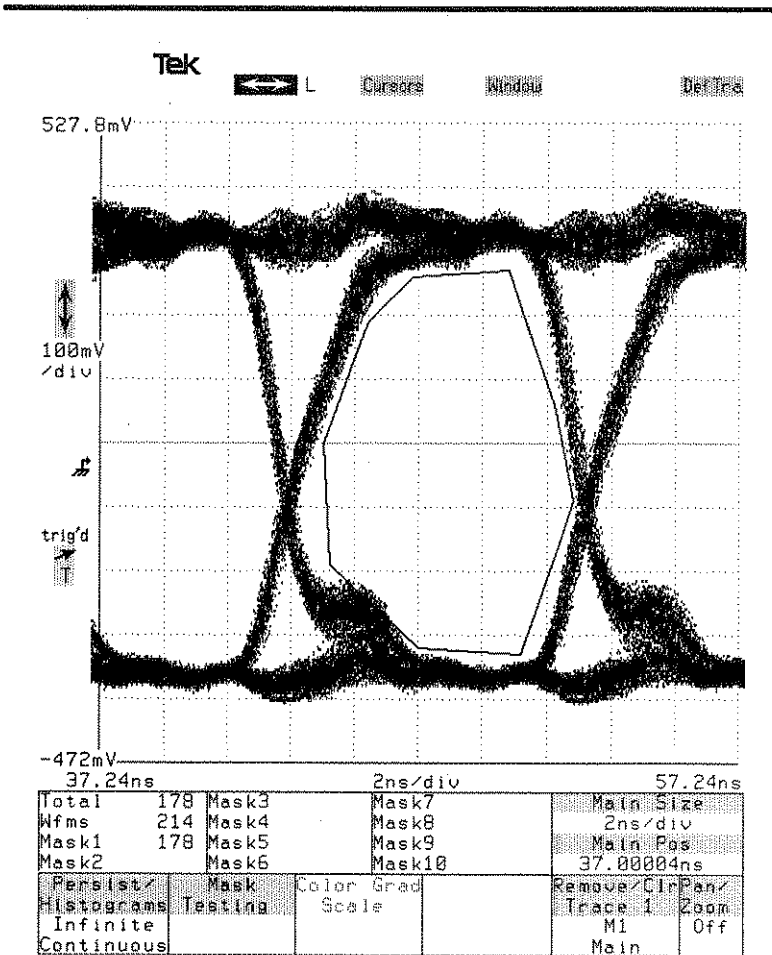

*Mask Testing on an Eye Diagram*

## Mask Testing



Masks are created using the **Mask Testing** pop-up menu. To display the Mask Testing menu, press the **DISPLAY MODES** button, then touch **Mask Testing**. You can create up to 10 masks, of up to 50 points each. The **Mask Testing** menu also enables you to specify that acquisition stop after a set number of trace acquisitions or after a set number of mask hits have been acquired. To remove the **Mask Testing** menu, touch **Exit**.

Mask Testing				
Mask1	Mask2	Mask3	Mask4	Mask5
6 Points	Undefined	Undefined	Undefined	Undefined
Mask6	Mask7	Mask8	Mask9	Mask10
Undefined	Undefined	Undefined	Undefined	Undefined
Edit Mask Definition		Delete Mask Definition		
Count Mask Hits Off	Clear Hits	Set N Waveforms 1000	Stop N Waveforms	
Set N Mask Hits 100	Stop N Mask Hits	Stop N Total Hits		
Exit				
Total Wfms	Mask3	Mask7	Main Size	
Mask1	Mask4	Mask8	500ps/div	
Mask2	Mask5	Mask9	Main Pos	
	Mask6	Mask10	39.37624ns	
Persist/ Histograms Infinite Continuous	Mask Testing	Color Grad Scale	Remove/Clr Pan/ Trace 1 M1 Main	Zoom Off

*The Mask Testing Pop-up Menu*



## Creating Masks

A mask is created by moving a cross-hair cursor on the display and adding or deleting points as required. You can edit or use the masks at any time by selecting the **Mask Testing** pop-up menu from the Display Modes major menu.

To create a mask, press the **DISPLAY MODES** button, and then touch **Mask Testing**. This brings up the **Mask Testing** pop-up menu. To create a new mask, select any one of the "MaskN" labels, for example, **Mask1**. Next, touch **Edit Mask Definition**. This displays the mask editing screen. A cross-hair cursor is located at the center of the display. The cursor is moved by turning the knobs. The upper knob is assigned to **Mask Cursor X** and the bottom knob is assigned to **Mask Cursor Y**.

To add a point to a mask, use the cursors to locate the cross-hair cursor over the location where you want to add a point. Touch **Add Point**. To delete a point from a mask, locate the cursor over the point to be deleted. Touch **Delete Point**. When you are finished creating the mask, touch **Exit Mask Editing**.

To edit an existing mask, touch **Mask Testing** in the Display Modes major menu. Select the mask you want to edit by touching the appropriate **MaskN Definition** selector and then touch **Edit Mask Definition**. You can now add or delete points as described previously.

### Storing Mask Definitions

Masks are saved with stored settings, so you can save sets of masks by defining them, then storing the instrument setting. For the same reason, any defined masks will be overwritten whenever you recall a stored setting or initialize the CSA 803.

For more details on  
Stored Settings, see  
page 203.

Mask Testing

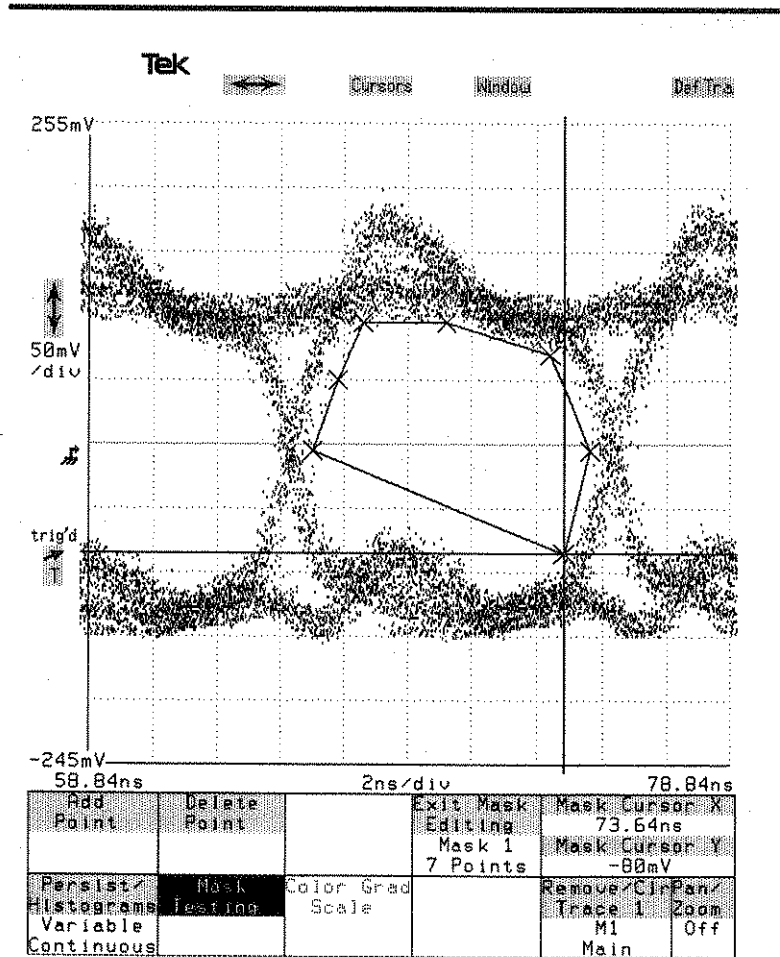

Editing a Mask





Masks are created by connecting the points independent of the order they are entered. Points are connected by sorting the points into left-to-right order and grouping them across a diagonal from the left-most point to the right-most point. If two points share the same horizontal position along either the left or right edge of the mask, then the diagonal runs from the top left-most point to the bottom right-most point. Points below the diagonal form the bottom boundary of the mask; points above it form the top boundary. Thus, it is difficult to make masks that have concave sides. (See Hints for Creating Masks, below.)

The illustrations on the following pages show how mask points are connected when you edit a mask.

#### Deleting Masks

To delete a mask, first display the **Mask Testing** menu. Select the mask to delete by touching the **MaskN** selector and then touch **Delete Mask Definition**.

#### Hints for Creating Masks

To ensure the best results when creating masks, remember the following:

- Locate one point along the left edge or right edge of the mask further left or further right than any other. You can still create straight lines along the edge; just place one point further left or right than the others on the edge.
- Points are connected left to right.
- All points above the imaginary line between the left-most point and the right-most point are grouped together as the "top." All points below the imaginary line between the left-most and right-most point are grouped together as the "bottom." Thus, an added point that falls below the imaginary line will be added, in left-to-right order, to the bottom group of points. And an added point which falls above the imaginary line will be added to the top group of points.

## Mask Testing

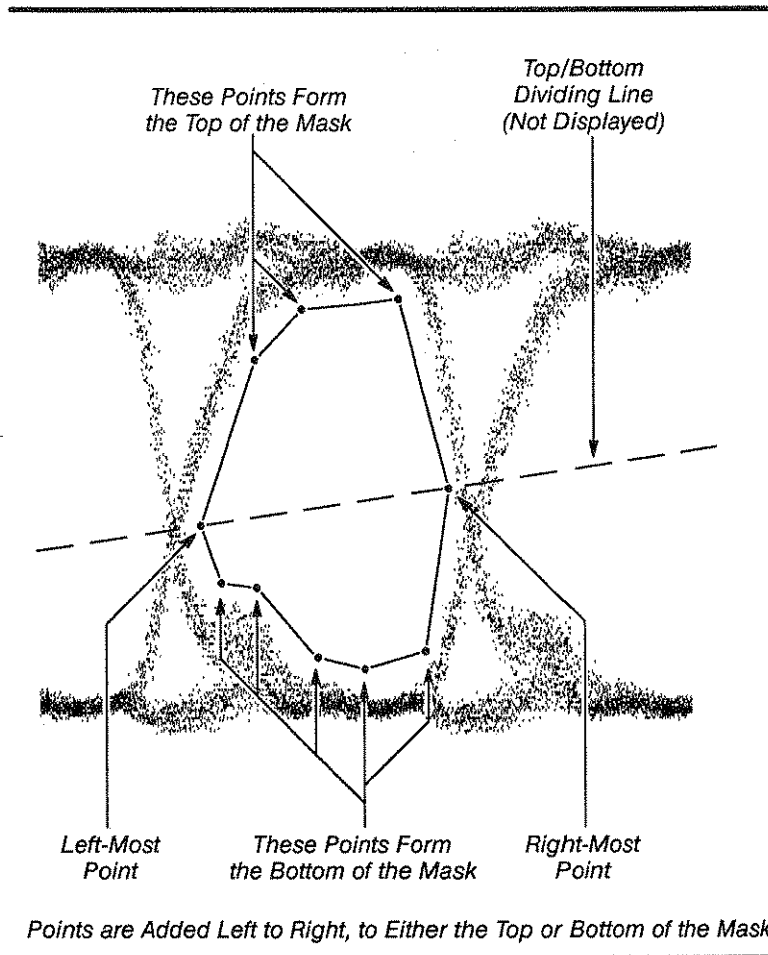

- If you wish to create a mask with a concave area, create several masks to cover the same area. Data falling into two overlapping masks is counted only once as part of **Total**.

Mask Testing

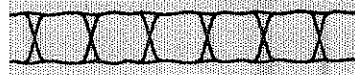

Mask With Point Added  
Below Top/Bottom  
Dividing Line

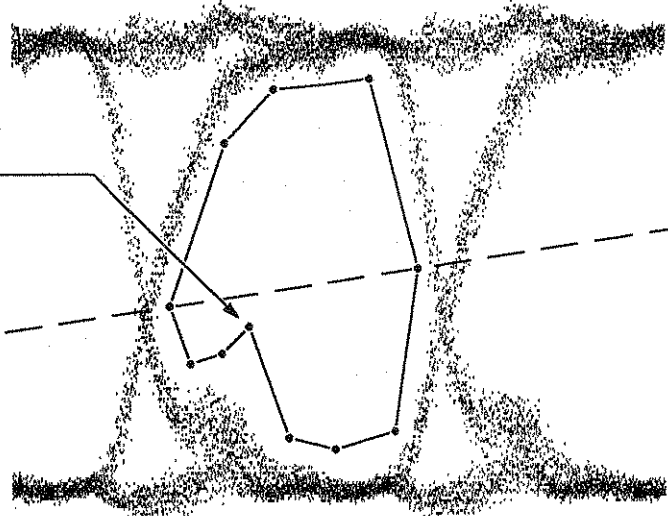

Mask With Point Added  
Above Top/Bottom  
Dividing Line

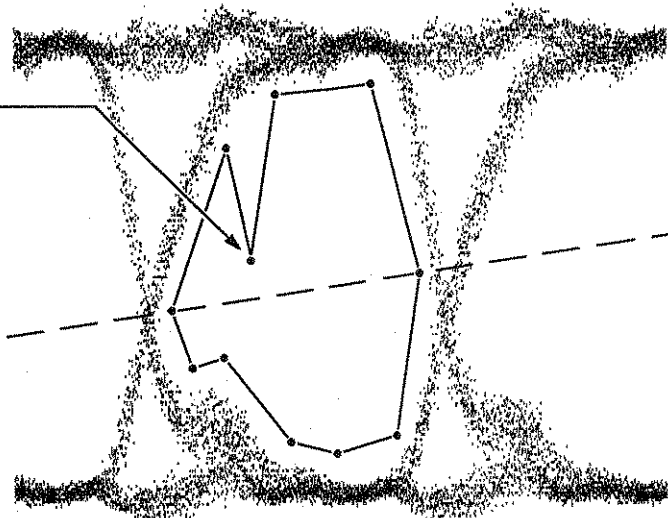

Where a Point is Added Affects How Points are Connected

## Mask Testing



### Starting Mask Testing

After exiting mask editing, masks will remain on the display. However, mask testing does not begin automatically. To initiate mask testing, display the **Mask Testing** menu, and touch **Count Mask Hits**.

Mask counts are allowed only in Infinite or Color Grading display modes. If the display mode is either Normal or Variable when mask testing is initiated, the display mode is switched to Infinite Persistence. If the display mode is Color Grading, then the display mode isn't changed. If the display mode is Color Grading when mask testing is turned on, the mask count data is initialized with data from the color graded display.

Note that the color graded display mode makes no distinction between selected and non-selected traces. Thus, if your mask overlaps a non-selected trace in Color Grading mode, the mask will contain samples from the non-selected trace. To avoid this, maintain enough vertical separation between traces to prevent overlap. Masks are not allowed on stored traces, though masks can be applied to calculated traces with stored components (for example, M1 - STO1).

When mask testing begins, the mask count readout, just above the **Mask Testing** selector, begins displaying results. There are three boxes which contain the mask count readout.

The numbers in the three boxes are:

- Total number of hits (data points within all masks)
- Total number of waveforms acquired
- Number of hits in each mask

Total is the sum of data points that fall inside *all* of the defined masks. This number takes into account the overlap between masks. That is, if a data point falls into two overlapping masks, the data point will be counted only once.

Wfms is the number of waveforms which have been acquired.

## Mask Testing



To turn on mask counting, select **Count Mask Hits** in the **Mask Testing** pop-up menu.

Total	1416	Mask3	2	Mask7	Main Size
Wfms	784	Mask4		Mask8	2ns/div
Mask1	1115	Mask5		Mask9	Main Pos
Mask2	295	Mask6		Mask10	37.1ns
Persist	Mask	Color Grad		Remove/Clr	Pan/
Histograms	Testing	Scale		Trace 1	Zoom
Infinite				M1	Off
Continuous				Main	

### Mask Count Readout

Mask1 through Mask10 show the number of data points that have fallen inside the named mask.

When mask testing is initiated, the readouts are active as long **Mask Testing** is selected (**Mask Testing** is highlighted). Like the histogram display, the counting is continued in the background as long as the Display Modes major menu is displayed even if you select the **Persist/Histograms** pop-up menu. Counting is cancelled if you select another major menu.

Masks are global. That is, all traces share the same masks. However, only data from the selected trace is counted when mask testing is on, even if other traces fall within the mask boundaries. (As described earlier, mask testing in Color Grading mode is an exception; samples from all traces are counted in Color Grading mode.) When you select another trace, all mask counts are cleared.

### Clearing the Hit Count

To clear the counters in the mask readout, display the **Mask Testing** menu and select **Clear Hits**. This sets the counters for the various masks, the total hits and waveform counters to zero, in addition to clearing the waveform data for the selected trace. Like histograms, these counters are cleared by any implicit or explicit clearing of the waveform data such as selecting **Clear Trace** from the **Remove/Clr** pop-up menu.

## Mask Testing



### Limiting Acquisition

You can limit acquisition under mask testing based on either the number of waveforms acquired or the number of mask hits detected. These functions are controlled by the **Set N** and **Stop N** selectors in the **Mask Testing** pop-up menu.

To limit acquisition based on the number of waveforms acquired, display the **Mask Testing** pop-up menu and touch **Set N Wfms**. This assigns the knobs to limit the number of waveforms acquired. The range for the number of waveforms acquired is 1 to  $2^{32}$  (approximately four billion). To begin conditional acquisition, touch **Stop N Wfms**. Acquisition will stop when N waveform records have been acquired.

The number of waveforms left to acquire is shown in the lower-left corner of the display.

To limit acquisition based on the number of samples acquired, first touch **Set N Samples**. This assigns the knobs to limit the number of samples acquired. Using the knobs, set the number of samples you wish to acquire. The range for the number of samples acquired is 1 to  $2^{32}$  (approximately four billion). To begin acquisition, touch **Stop N Samples**. Touching this selector starts acquisition, which then continues until N samples have been acquired.

The number of samples left to acquire is shown in the lower-left corner of the display.

Thus, there are two steps to stop acquisition based on the number of samples acquired:

- Step 1: Set the number of waveforms or samples using **Set N Wfms** or **Set N Samples**.
- Step 2: Begin the acquisition by selecting **Stop N Wfms** or **Stop N Samples**.

If you want to stop the acquisition before the conditional acquisition completes, press **RUN/STOP**.

Mask Testing

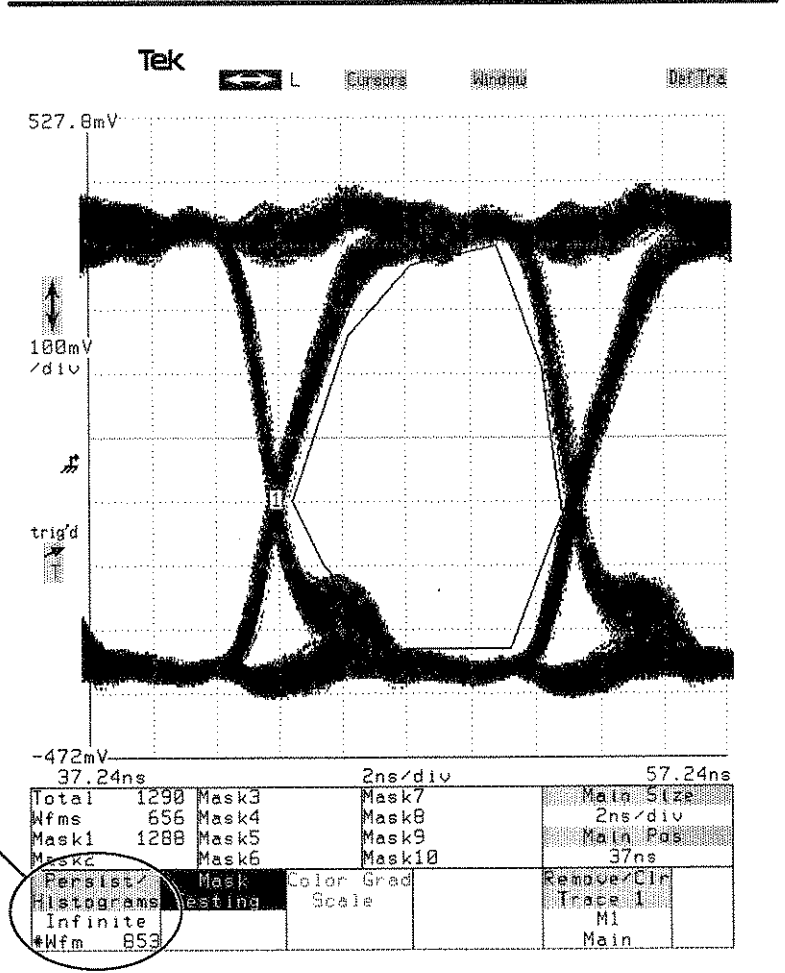
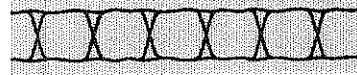

Number of waveforms left to acquire is shown here

Using Stop N Wfms

*Mask Testing*





# Measurements



Measurements are numeric readouts of properties of a trace. Measurements are updated continuously so that as the signal changes the numeric readouts change also. You can select up to six measurements for each of your traces. The readouts of the measurements of the selected trace appear in the Measure major menu. The measurements are listed in the table below and on the next page.

*Measurements*

Selector	Measures
<b>Max</b>	Maximum amplitude, the most positive peak voltage/rho value.
<b>Min</b>	Minimum amplitude, the most negative peak voltage/rho value.
<b>Mid</b>	Middle amplitude, halfway between maximum amplitude and minimum amplitude.
<b>Mean</b>	Arithmetic mean of all signal points.
<b>RMS</b>	True Root Mean Square voltage.
<b>Peak-Peak</b>	The voltage difference between maximum amplitude and minimum amplitude.
<b>Overshoot</b>	The difference between the maximum amplitude and the topline value, expressed as a percentage of the difference between the topline and baseline values.
<b>Undershoot</b>	The difference between the baseline value and the minimum amplitude, expressed as a percentage of the difference between the topline and baseline values.
<b>Amplitude</b>	The difference between the topline and baseline values.
<b>Extinct Ratio</b>	The extinction ratio; equal to the topline value divided by the baseline value.
<b>Noise</b>	The vertical dispersion of a trace. (Available in Statistics mode only.)

*Amplitude Measurements*

Measurements



Measurements (Cont.)

	Selector	Measures
Timing Measurements	Rise	The transition time of a rising pulse edge.
	Fall	The transition time of a falling pulse edge.
	Frequency	The reciprocal of the period.
	Period	The time taken for one complete signal cycle.
	PropDelay	The time between mesial crossings of two different traces or two points on the same trace.
	Cross	The time from the trigger point to a specified level crossing.
	Width	The time the signal takes to go from a voltage level crossing to the next crossing of the opposite slope.
	Duty Cycle	The percentage of a period that a waveform spends above the mesial.
	Phase	The phase angle from the selected waveform to the reference waveform.
	Jitter	The horizontal dispersion of the trace. (Available in Statistics mode only.)
Area and Energy Measurements	Area +	The area under the curve of a trace.
	Area -	The difference between the area under the curve above a reference level, and the area under the curve below that reference level.
	Energy	The energy represented under the curve of a trace. This integral of the squared voltages can be divided by the resistance of the circuit to yield power measurements.



## Setting Up Measurements

Measurements are taken from displayed traces. The trace on which measurements are based must be adjusted so that all areas that are needed to take the measurements are visible on the display. No part of the trace should extend above or below the graticule display area. If a measurement requires a full cycle, as in frequency or period measurements, then adjust the horizontal size to show at least one complete cycle of the signal. If a measurement requires a rising or falling edge, as in rise or cross measurements, then adjust the horizontal size and position to show the complete rising or falling edge.

Hardware measurements, described on page 166, are an exception. Hardware measurements are not taken from the displayed data, and are not affected by the vertical size settings. (Hardware measurements are, however, affected by horizontal settings.)

Once the trace display is established, press the **MEASURE** button to display the Measure major menu. Initially, this menu is mostly blank. The six empty selectors are reserved as places where measurement readouts will appear when you select your measurements.

			Measurements
			Compare & References

### Measure Major Menu

Touch the **Measurements** selector to display a pop-up menu with all the measurement selectors available. Touch the individual measurement selectors to take measurements of your trace. As you select each measurement, the result of the measurement is immediately displayed in one of the selector areas of the Measure major menu.

Measurements

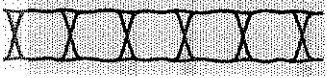

The illustration below shows the **Measurements** pop-up menu with two measurements, Frequency and RMS, selected. The numeric readouts for these two measurements are in the major menu area.

Select measurements here

Remove the pop-up menu here

View the readouts here

Measurements					
Software Mode		Statistics Mode		Hardware Mode	
Measurement Functions		Top / Base Method IEEE		Default Parameters	
Amplitude		Timing		AreaEnergy	
Max	Mean	Rise	Fall	Area +	
Mid	<b>RMS</b>	<b>Frequency</b>	Period	Area -	
Min	Over Shoot	PropDelay	Cross	Energy	
Peak-Peak	Under Shoot	Width	Duty Cycle		
Amplitude	Extinct Ratio	Phase	Jitter	Clear All	
Noise				Exit	
Frequency	RMS		Measurements	Left Limit	0%
4.97336 GHz	105.130 mV			Right Limit	100%
			Compare & References	Remove/Clear Trace 1	M1
					Main

**Measurements Pop-up Menu with Frequency and RMS Selected**



If your **Measurements** pop-up menu shows only timing measurements, touch the **Software Mode** selector at the top of the menu.

When the measurements you want are selected, you can remove the pop-up menu by touching either the **Exit** selector in the pop-up menu or the **Measurements** selector in the major menu area. This lets you see the trace as the measurements are taken.

Measurements are part of the definition of a trace. When the **Measure** major menu is displayed, the measurements of the selected trace are also displayed.

### Deleting Measurements

To delete a measurement that is established on a trace, touch the **Measurements** selector in the **Measure** major menu. In the pop-up menu, touch the selectors for the measurements you want to remove. As you touch the measurement selectors, they will turn off highlighting and the measurement readouts will be removed from the major menu area. **Clear All** deletes all measurements. When you are finished removing measurements, touch the **Exit** selector to remove the pop-up menu.

### Topline/ Baseline Calculation

The **Top/Base Method** selector allows you to select the method of determining the topline and baseline. You can choose between the standard IEEE method (histograms) or an alternate method that smooths and differentiates the waveform data before calculating topline and baseline. The alternate method is particularly suited to pulse waveforms with ringing or other anomalies. Try this method whenever the IEEE method produces unstable topline and baseline results.

The IEEE method is always used for statistics mode measurements.

## Measurements



### Measurement Mode

Measurements may be taken in software mode, hardware mode, or statistics mode. In software mode, measurements are taken from the digitized trace data record, the same data that forms the trace on the display. Software mode is the default.

In hardware mode, measurements are taken from the analog signal output from the sampling head before it is digitized and assembled into a trace record. The CSA 803 uses special timer circuits to take hardware measurements. The advantage of hardware measurements is that they are performed faster than software measurements.

In statistics mode, measurements are taken from color graded waveform data and are based on histograms computed at the crossing levels. You can use statistical measurements to measure "random" data such as eye diagrams. Statistics mode also provides jitter and noise measurements, and can be more accurate for other measurements on waveforms with significant jitter or noise.

Statistics mode can be selected only in color graded display mode. Because the color graded database does not distinguish between traces, statistical measurements are limited to one trace per graticule. (Stored traces may be left on the display; they are ignored by the statistical measurement algorithm.)

All 24 measurements in the **Measurements** pop-up menu can be taken as statistical measurements. In software mode, all measurements except Noise and Jitter are available. Only seven timing measurements (Rise, Fall, Frequency, Period, Prop Delay, Cross, and Width) can be taken as hardware measurements. Duty Cycle and Phase are software measurements; Jitter and Noise are statistical measurements. For example, the Rise measurement can be taken as a software measurement, a hardware measurement, or a statistical measurement. The RMS measurement is not a timing measurement, and cannot be taken as a hardware measurement.

You cannot take measurements in different modes on the same trace. You can, however, create two or three identical traces and take measurements in different modes on each. You can display only the measurements for the one trace at a time.



### Statistical Measurement Considerations

A number of factors can affect measurements in statistics mode. Most of these limitations result from the need to collect histograms to determine the topline, baseline, and crossings of the trace.

- Measurements may be incorrect if not enough trace records have been acquired. Eye diagrams and signals with significant noise or jitter are examples of signals that will require many trace records for accurate measurements.
- If a rising or falling edge is nearly instantaneous (relative to the horizontal size), no data may be acquired on that edge, and timing measurements will be incorrect or will report an error.
- The CSA 803 may not be able to recognize an eye diagram if the the areas above and below the eye crossings are closed, or if the proximal and distal levels do not pass through the open areas. You may need to adjust the proximal and distal parameters so that they pass through these areas, and adjust the mesial so that it does not.
- If the measurement zone left limit passes through the crossing of an eye diagram, the statistics mode algorithm will automatically move the left limit for timing measurements. To reset the left limit, use the default parameters or the parameters of another measurement, such as **Rise**, to move the left limit to the left of the first eye crossing.)
- If you use dual graticules, each graticule has only 128 vertical values (compared to 256 for a single graticule), so set the vertical size as large as possible for better precision.
- The time required to take statistical measurements can vary from a few hundred milliseconds to over a second, depending on which measurements are selected and what the measurement parameters are.

Refer to the table on the next page to determine the best measurement type for your application.

## Measurements



Measurement Mode Comparison

	Software	Hardware	Statistics
<b>Functions</b>	All measurements <i>except</i> Noise and Jitter available.	Limited to 7 timing measurements.	Full range of 24 measurements available.
<b>Trace Complexity</b>	All trace expressions supported	Only traces without arithmetic operators or functions are allowed. Averaging and enveloping are allowed, but the measurement is taken from unaveraged samples.	All trace expressions that include an active channel are supported.
<b>Display Restrictions</b>	Any display mode. Measurements are taken from a single trace record, regardless of display mode.	Any display mode. Measurements are taken from a single trace record, regardless of display mode.	Color graded mode only. One active trace per graticule.
<b>Resolution</b>	Affected by displayed vertical size and trace functions (e.g., averaging) and smoothing.	Unaffected by display or functions. Only sampling head smoothing will affect hardware measurements.	Affected by displayed vertical size and trace functions (e.g., averaging) and smoothing. Limited to 512-point record length.
<b>Speed</b>	Slower	Faster	Updated when color graded database is updated (based on refresh rate).



## Measurements

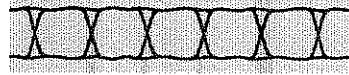

Use the **Measurements** pop-up menu of the Measure major menu to select the measurement mode. At the top of this pop-up menu are three selectors: **Software Mode**, **Statistics Mode**, and **Hardware Mode**. The selector for the current mode is always highlighted. Touch the selector for the mode you want.

When you select **Hardware Mode**, the Amplitude, Area/Energy, Duty Cycle, Phase, and Jitter measurement selectors do not appear. If any of these measurements were established when you selected hardware measurements, they are removed from the trace measurements, and a message appears on the display to warn you that some measurements have been removed. Any timing measurements that were established are kept and changed to hardware mode measurements.

When you select **Software Mode**, all existing timing measurements are kept and converted to software measurements. If the Jitter or Noise measurements were established in statistics mode, they will be removed when you switch to software mode.

When you select **Statistics Mode**, all existing measurements are converted to statistical measurements. You must be in the color graded display mode in order to use statistics mode.



## Comparing Measurements to References

If you change the axis units on a trace, for example from volts to rho, the reference values are not changed to match the new units. Be sure the reference value is stored with appropriate units.

You can establish reference values for your measurements and have the CSA 803 display the measurement readouts as the amount of variance from the reference value. For example, you can store the propagation delay through the cables that connect to your device under test. Then, by turning on compare mode, you can measure the delay through the device under test with the cable delay automatically removed from the measurement result. You can also use this feature to compare measurements on several different tests or parts.

You can also tell the CSA 803 to save the current measurement readouts as the reference values for those measurements. If you then turn on the compare feature, you can observe how much the signal deviates from those references as you tune the circuit under test.

When the compare mode is on and measurement readouts show difference values, the measurement readouts show a delta (  $\Delta$  ) in the selector label to remind you that difference values are being displayed. For example, the **RMS** measurement readout in the major menu area becomes the  $\Delta$ **RMS** readout when compare mode is turned on.

Measurement reference values are stored separately for each trace. The reference values you establish for one trace will not affect the reference values for other traces.

The compare feature affects all measurements on all traces. When you turn on compare mode, all measurement readouts show  $\Delta$  comparison values, even if you select a different trace.

Compare mode is turned on or off using the **Compare & References** pop-up menu in the Measure major menu.

You set the reference values to the current measurement values by touching the **Save Current Meas Values as References** selector. When you touch this selector, all the reference values for the measurements established on the selected trace are copied from the current measurement readouts.

Measurements

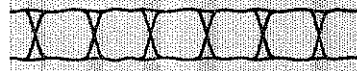

Compare and Reference Values		
Compare	Save Current Meas	Values as References
Off		
Adjust References		
RMS	Mean	Frequency
Ref	Ref	Ref
169.26mV	-115.1mV	100kHz
Period	Rise	Fall
Ref	Ref	Ref
10μs	76.31ns	73.484ns
Exit		

RMS	Mean	Frequency	Measurements	Main Size
169.315	-115.058	100.004		5μs/div
mV	mV	kHz		Main Pos
				99.91456ns
Period	Rise	Fall	Compare & References	Remove/ClrPan/Trace 1 Zoom
9.99968	76.310	72.943		M1 Off
μs	ns	ns		Main

**Compare & References Pop-up Menu**

When compare mode is off, you can use the knobs or keypad menu to set the reference values. A selector appears in the **Adjust References** section of the **Compare & References** pop-up menu for each measurement currently established on the selected trace. Each of these has the word **Ref** after the measurement name, for example, the **RMS Ref** selector. Touch the reference selector for the measurement reference you want to adjust, and both knobs are set to adjust that reference value. Turn either knob, or touch either knob label to display the keypad pop-up menu, to enter the numeric reference value.

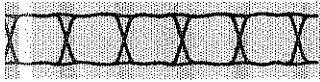

## Changing Measurement Parameters

Once you have established a measurement on a trace, you can find out more information about the measurement and you can control the way the CSA 803 takes the measurement by changing the measurement parameters.

Touch the measurement readout selector in the major menu area to see the additional information. This displays a pop-up menu for the individual measurement. It also displays *annotation lines* that overlay the selected trace displayed on the graticule. These lines show the value of the *measurement parameters* that pertain to that particular measurement.

In addition to the annotation lines, the portion of the trace that is used by the CSA 803 to determine the measurement value is highlighted when in Normal display mode, or marked by dashed vertical lines in other display modes.

The illustration on the next page shows a typical pop-up menu for an individual measurement, along with the annotation lines and the highlighted portion of the trace.

Many of the selectors in the measurement pop-up menu set the knobs to adjust the measurement parameters. As you turn the knob, the annotation lines move to reflect the new value of the measurement parameter. For example, in the software Frequency pop-up menu, the **Left Limit**, **Right Limit**, **Mesial**, and **S/N Ratio** selectors set the knobs to those measurement parameters.

The dotted line style of the annotation lines is repeated in the relevant parameter selector in the pop-up menu for the individual measurement.

You can remove the annotation lines completely by pressing the **MEASURE** major menu button.

When you remove the measurement pop-up menu by touching its selector in the major menu area, the annotation lines remain on the display. The knob settings remain also; so you can set the knobs in the pop-up menu, remove the pop-up menu from the display, and adjust the measurement parameter with the annotation lines on the trace.

Measurements



Tek ← Cursors Window DefTrce

413.8mV

Frequency

Measurement Mode: Square

Left Limit: 36%    Right Limit: 100%

18.4723μs    51.2323μs

Baseline    Topline

---

0%    100%

-226.250mV    21.7500mV

MediaL    S/N Ratio

---

50%    10

-102.250mV

Tracking    Level Mode

on    Relative

---

Set N    Setup

32

Cur N: 32

Mean: 100.09966kHz

StDev: 016.21752mHz

5μs/div    50.64μs

Frequency		Measurements	Left Limit 36%
100.099 kHz			Right Limit 100%
		Compare & Remove References	Trace 1 M1 Main

Left Limit Measurement Parameter Selector

Left Limit Annotation Line

A Typical Individual Measurement Pop-up Menu

Measurements



In the illustration above, the Left Limit measurement parameter is set to 36%. The left limit vertical line is positioned 36% of the way across the graticule, and the CSA 803 measures the frequency from the first complete cycle to the right of the left limit. The highlighted portion of the trace shows the area being measured.

The following table shows the measurement parameters. Some apply only to hardware measurements, some only to software measurements, some only to statistical measurements, and some apply to all three. No pop-up menu for an individual measurement uses all these parameters; only the ones that apply to that particular measurement are shown in the pop-up menu.

Changing a measurement parameter in one measurement changes it in all measurements of the selected trace that use that parameter.

Measurement Parameters

SW	HW	Stat	Name	Definition
✓	✓	✓	Baseline	The 0% level on which proximal, mesial, and distal levels are based. When tracking mode is on, the CSA 803 repeatedly determines the baseline and you cannot adjust it. When tracking mode is off, you can set baseline, or you can have the CSA 803 set it once by touching the <b>Setup</b> selector.
✓		✓	Data Interval	Determines whether the measurement will be taken from one cycle of the trace or the entire measurement zone.
		✓	Dispersion	Selects the peak-to-peak or RMSΔ (standard deviation) statistic for the Noise and Jitter measurements.

Measurements



Measurement Parameters (Cont.)

SW	HW	Stat	Name	Definition
✓	✓	✓	Distal	The distal (most distant from the origin) voltage level. Rise and fall times are measured between the proximal and distal voltage levels, which are typically 10% and 90% of the baseline to topline voltages. May be set as a relative (percent) or absolute (volts) value.
	✓		Filtering	The number of successive samples that must cross a threshold level before the transition is considered valid. Noisy signals will be most affected by filtering.
		✓	Histogram Points	The number of points in the histograms taken for Jitter and Noise measurements. This parameter cannot be adjusted, but appears in the Jitter and Noise pop-up menus as <b>Hist Pts</b> .
		✓	Jitter Level	The level at which the Jitter measurement is taken, in volts. This parameter cannot be adjusted, but appears in the Jitter pop-up menu as <b>Jitt Lvl</b> . This parameter will be affected by the Jitter Location setting.
		✓	Jitter Location	The location of the histogram for the Jitter measurement. May be Mesial or Eye Cross. If the CSA 803 does not recognize the signal as an eye diagram, only Mesial is available.
✓		✓	Left Limit	The beginning of the trace measurement zone.

## Measurements



### Measurement Parameters (Cont.)

SW	HW	Stat	Name	Definition
✓	✓	✓	Level Mode	In <i>absolute</i> level mode, you set proximal, distal, mesial, and reference levels in absolute voltage values. In <i>relative</i> level mode, you set these parameters in terms of percentages of the baseline to topline distance.
✓	✓	✓	Mesial	The middle voltage level, expressed as a percentage of baseline to topline distance. May be set as a relative (percent) or absolute (volts) value.
		✓	Noise Location	The location of the histogram for the Noise measurement. May be Baseline or Topline.
✓	✓	✓	Proximal	The proximal (closest from origin) voltage level. Rise and fall times are measured between the proximal and distal voltage levels, which are typically 10% and 90% of the baseline to topline voltages. May be set as a relative (percent) or absolute (volts) value.
✓	✓	✓	Reference Level	The transition crossing voltage level. May be set as a relative (percent) or absolute (volts) value.
✓		✓	Right Limit	The end of the trace measurement zone.



Measurements



Measurement Parameters (Cont.)

SW	HW	Stat	Name	Definition
✓			S/N Ratio	The amplitude of a noise rejection band centered on the mesial level. Transitions through the mesial level are qualified by S/N ratio by the requirement that the signal enter the noise rejection band and leave the band at the opposite limit with the same slope and with no intermediate values outside the noise rejection band. S/N ratio may be set to any value from 1 to 99. The reciprocal of the number is the fraction of the topline to baseline distance that the noise rejection band extends above and below the mesial line. For a 1 V peak-to-peak signal, S/N ratio of 20 creates a noise rejection band 0.05 V above and 0.05 V below the mesial level.
✓	✓	✓	Second Trace	The Prop Delay and phase measurements shows the timing difference between two traces. One of the traces is always the selected trace. Second Trace lets you select which trace the selected trace is compared to.
✓	✓	✓	Slope	The direction the trace must pass through a reference level.

Measurements



Measurement Parameters (Cont.)

SW	HW	Stat	Name	Definition
✓	✓	✓	Topline	The 100% level on which proximal, mesial, distal, and reference levels are based. When tracking is on, the CSA 803 repeatedly determines the topline for itself and you cannot adjust it. When tracking is off, you can set topline, or you can have the CSA 803 set it once by touching the <b>Setup</b> selector, and then adjust the values with the knobs.
✓	✓	✓	Tracking	With tracking on, the topline and baseline are repeatedly determined by the CSA 803. Tracking off allows you to set topline and baseline. Tracking is only available if level mode is relative.
	✓		Transition Number	The number of times the signal must pass through a specified voltage level before the measurement zone begins.

Measurements

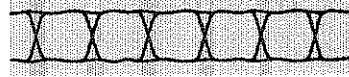

**Measurement Statistics**

The CSA 803 collects measurement statistics automatically when in either software or hardware mode. (Statistics are not collected in statistics mode.) You can set the N parameter to determine the number of individual measurements on which the statistics are based.

Each measurement readout selector in the Measure major menu can be touched to bring up the pop-up menu for the individual measurement. This menu shows the number of measurement samples taken so far, the mean, and the standard deviation. The **Set N** selector sets the knobs to control the N parameter.

Reported Statistics

Max					
Measurement Mode:		Software			
Left Limit	Right Limit				
0%	100%				
79.0430ns	51.1790μs				
Set N					
32					
Cur N: 32					
Mean : 5.6250125mV					
StDev: 1.0000324mV					
Max		Measurements	Set N		
6.75001 mV			32		
			Set N		
			32		
		Compare & Remove/Clr References	Trace 1		
			M2		
			Main		

Statistics in an Individual Measurement Pop-up Menu

## Measurements

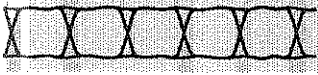

### Changing Default Parameters

Whenever you define a new trace, the measurement parameters for that trace are initialized by copying them from a set of default parameters. There is one set of default parameters for the CSA 803. You can set the default parameters to the values you want. This does not change the measurement parameters of any existing traces, but will set the initialized state of all new traces that you define.

You might want to change the default parameters if you are about to create a number of traces and take measurements from them, knowing that they will all need the same measurement parameters. Setting the default parameters before creating the traces saves time over the process of changing the measurement parameters of each trace individually.

You access the default parameters through the **Measurements** pop-up menu in the Measure major menu. When this pop-up menu is first displayed, it shows a list of measurements, and the **Measurement Functions** selector is highlighted. If you touch the **Default Parameters** selector, the menu changes to show the default parameters.

Defaults for either software, hardware, or statistics mode are shown, depending on whether **Software Default**, **Hardware Default**, or **Statistics Default** is highlighted at the top of the menu. You can change to another set of defaults by touching the appropriate selector. Changing the default does not affect the current measurement mode.

Once the appropriate set of defaults is displayed, touch the selector that names the default you want to set. A knob will be assigned to set the value of that default parameter.

Once you have the defaults set the way you want them, you can change all the measurement parameters of the selected trace to the default settings by touching the **Initialize All** selector. This selector changes all the measurement parameters of the selected trace only; other traces are not affected.

Measurements



Measurements				
Software Default	Statistics Default	Hardware Default		
Measurement Functions		Default Parameters		
Left Limit		Right Limit		
0%		100%		
Tracking		Level Mode		
On		Relative		
Proximal	Distal	Reference Level		
10%	90%	50%		
Mesial	S/N Ratio	Data Interval		
50%	10	whole zone		
Initialize All				
Max		Measurements	Set N	
134.000			32	
mV			Set N	
			32	
		Compare & Remove/CI	Trace 1	
		References	M1	
			Main	

Measurements Pop-up Menu with Software Defaults

*Measurements*



# Power-On

## Installation

Before you first power on your CSA 803, you should make certain it is correctly installed. The installation sequence involves the following controls, connectors and switches on the rear panel:

- **POWER Connector**
- **FUSE**
- **LINE VOLTAGE SELECTOR switch**
- **PRINCIPAL POWER SWITCH**

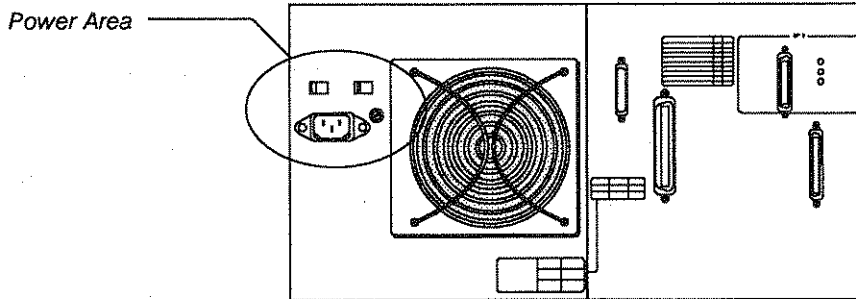

*Power Connector, Fuse, and Switches*

In addition, you will need to know the location of the **ON/STANDBY** switch on the front panel.

*The  
ON/STANDBY  
Switch*

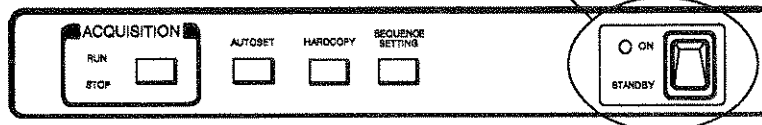

Power-On



**CAUTION**  
Never install or  
remove a sampling  
head with the  
CSA 803 power on.

The following steps describe the installation procedure for the CSA 803.

- Step 1: Set the **PRINCIPAL POWER SWITCH** to **OFF**.
- Step 2: Set the front panel **ON/STANDBY** switch to **STANDBY**.
- Step 3: Set the **LINE VOLTAGE SELECTOR** to the proper range for your power system.
- Step 4: Check the **FUSE** to be sure it is of the proper type and rating, as printed on the rear panel.
- Step 5: Install one or more sampling heads in the front panel compartments.

To install a sampling head, place it into a compartment and push it in with firm pressure. Once it is seated, turn the screw shaft on the sampling head to tighten the head into place. Sampling heads are described on page 197.

- Step 6: Connect the power cord from the **POWER** connector to your power system.
- Step 7: Set the **PRINCIPAL POWER SWITCH** to **ON**.

The **PRINCIPAL POWER SWITCH** controls all AC power to the instrument. The **ON/STANDBY** switch controls power to most of the instrument's circuits, but continues to supply power to certain circuits even when set to **STANDBY**.

- Step 8: To operate the instrument, set the front panel **ON/STANDBY** switch to **ON**.

Once the CSA 803 is installed, use the **ON/STANDBY** switch as the power switch.





## Power-On Sequence

Complete descriptions of the diagnostics are on page 71.

Each time you power on the CSA 803, the instrument performs a sequence of internal checks, and then restores the settings that were in effect when the instrument was last powered off. The sequence is:

1. The power-on diagnostics are performed and take about five seconds to execute. If these diagnostics fail, the instrument will freeze and you will not be able to operate it.
2. The self-test diagnostics are performed, and take about 15 seconds to execute. If these diagnostics fail, the extended diagnostic system is entered, and the extended diagnostic menu is displayed.
3. The system restores all the settings and traces that it can. If the configuration of mainframe and sampling heads has not changed since the last power-off, then the instrument will completely restore to the state it was in when powered off.

Stored traces are not restored at power-on. Once you power off the CSA 803, all stored traces are permanently lost.

## Warm-Up Period

It takes about 20 minutes for the CSA 803 to warm up after power-on. You should perform any enhanced accuracy calibrations only when the instrument has warmed up and achieved thermal stability. The enhanced accuracy calibrations are described on page 85.

*Power-On*



# Record Length



The number of samples that form a trace is called the record length. You can select record lengths of 512, 1024, 2048, 4096, and 5120 samples.

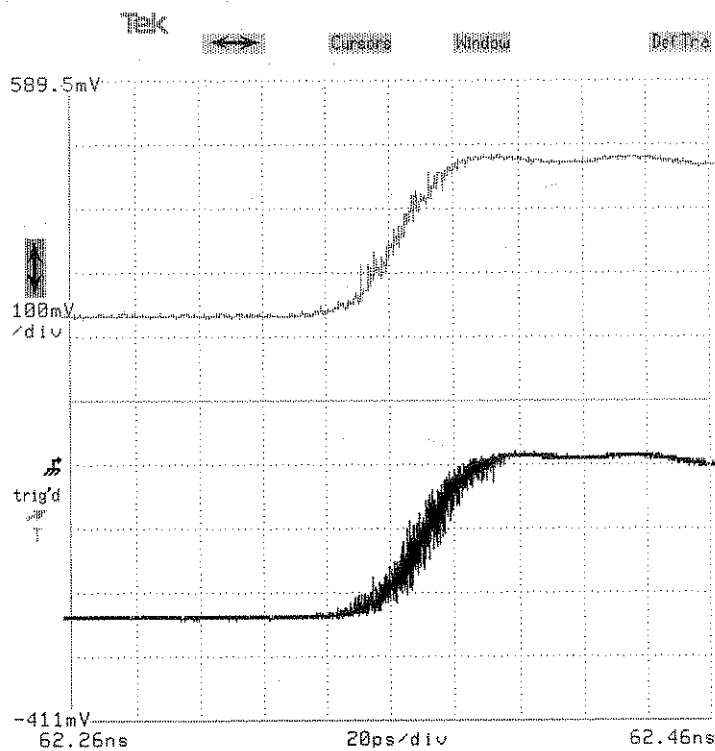

Traces with Record Lengths of 512 (top) and 5120 (bottom)

## Record Length



You can set the main record length and the window record length using the knobs. All traces on the main time base have the same record length. Window traces similarly share identical record length.

Variable, Infinite and Color Grading persistence displays will work only with the 512-point record length. If the record length is longer when one of these display modes is selected, the record length is automatically shortened to 512 points. Returning to Normal persistence does not reset the record length; it remains at 512 points.

The 4096-point record length has the same sample interval (the time between successive trace samples) as 5120-point records. The 4096-point trace appears shorter on the display than 5120-point traces. Many Fast Fourier transform algorithms require record lengths that are a power of two. The 4096-point record length is provided as a convenience, and the visual truncation is a natural result.

You control the record length by using the **Horizontal Desc** pop-up menu in the **Waveform** major menu. The **Main Record Length** and **Window Record Length** selectors assign the knobs to set the record lengths. The **Horizontal Desc** pop-up menu shows the sample intervals for the current settings.

Record Length



Record Length Section

Horizontal Description

---

Acquiring Timebase: Main  
 Main Sample Interval: 2ps/point  
 Window Sample Interval: 200fs/point  
 Main Record Length: 512 points  
 Window Record Length: 512 points

---

Horizontal Reference Point

Left    
  Center    
  Right

---

XY Display Mode: X=Acquired Trace

Trace 1	Normal
M1	YT
Main	

---

XY Display Mode: X=Stored Trace

Exit

Vertical Desc	Horizontal Desc	Acquire Desc	Graticules	Main Size	Pan/Zoom
M1	Main	Continuous	Single s,V	100ps/div	
Fast	@ 512 pts			Main Pos	
Sampling Head Fac's	Window Mode		More...	37.1ns	
			Trace Status	Remove/Clr Trace 1	Zoom Off
				M1	
				Main	

The Horizontal Desc Pop-up Menu

*Record Length*

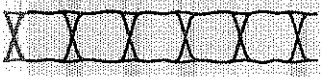

# RS-232-C Parameters

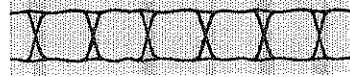

The CSA 803 can be controlled by a remote computer, through one of two interfaces. These interfaces are industry standards IEEE Std 488 (GPIB) and RS-232-C.

This manual does not discuss the details of connecting a remote computer to the CSA 803 or the syntax and capabilities of remote commands. That information is found in the *CSA 803 and 11801A Programmer Reference*.

## RS-232-C Connection

Connect the cable from your computer to the **RS-232-C** connector on the CSA 803 rear panel. The CSA 803 is configured as data communications equipment (DCE), and the computer must be configured as data terminal equipment (DTE).

RS-232-C Connector

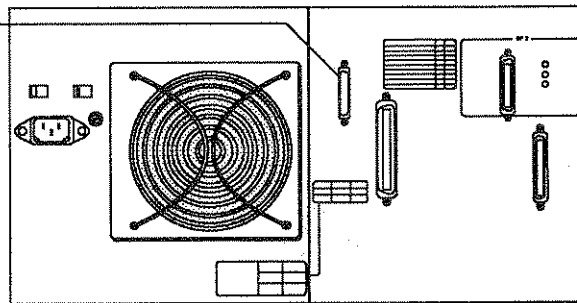

Location of RS-232-C Connector

RS-232-C Parameters



**Setting  
RS-232-C  
Parameters**

Communication between the CSA 803 and the attached computer can occur only if the two are configured in a compatible manner.

Use the  **GPIB/RS232C**  pop-up menu in the Utility1 major menu to set the RS-232-C parameters directly, before you attempt to communicate with the attached computer.

GPIB/RS232C Parameters					
GPIB Parameters			RS232C Parameters		
Mode	Address	Baud Rate	Echo	Stop Bits	
Talk/Listen	1	9600Bd	On	1.5	
Terminator	GPIB Debug	Parity	Flagging	Delay	
EOI	Off	None	Soft	0	
Tek C & F V81.1		EOL String	Verbose	RS232C Debug	
		CR/LF	Off	Off	
Exit					
<b>GPIB / RS232C</b>	Identity	Color	Hardcopy	Main Size	
			Bitmap Screen	16.523994In/div	
Initialize	Instrument Options	Labeling	Page to	Main Pos	
	16:47:15	Off	Enhanced Accuracy	313.95589In	
	24-APR-90			Trace 1	
				Remove/Clear/Zoom	
				M1	Off
				Main	

*The GPIB/RS232C Pop-up Menu*





The following list describes each selector in the **RS232C Parameters** section of this pop-up menu:

The RS-232-C parameters are not changed when you initialize the CSA 803.

- **Baud Rate**— assigns the knobs to adjust baud rate and delay. You can set the baud rate to 110, 150, 300, 600, 1200, 2400, 2400, 4800, 9600, or 19,200. You should set the baud rate to match the computer you are using.
- **Echo**— lets you set echo to **ON** or **OFF**. If you observe two identical characters transmitted when you expect only one, echo is on when it shouldn't be. If you see no character transmitted when one was expected, echo might be set to off inappropriately.
- **Stop Bits**— lets you select among 1, 1.5, or 2 stop bits. Touch the selector repeatedly until the appropriate number is shown in the selector. You should set the number of stop bits to match the computer you are using.
- **Parity**— lets you select among **Even** parity, **Odd** parity, or **None**. Touch the selector repeatedly until the appropriate setting is displayed in the selector. Parity is an error detection scheme. You should set parity to match that of the computer you are using.



- **Flagging**—lets you select among **Hard flagging**, **Soft flagging**, or **None**. Touch the selector repeatedly until the appropriate setting is displayed in the selector. Flagging is used by the CSA 803 or the computer to signal that its input buffer is full, and that the other device should stop transmitting until further notice.

When soft flagging is selected, the CSA 803 sends a Ctrl-S (decimal 13) to signal the other device to stop transmission, and recognizes Ctrl-S as a signal to stop transmitting. Ctrl-Q restarts transmission. When hard flagging is selected, the CSA 803 uses the RS-232-C DSR/DTR signal to control data transmission. You should set the type of flagging to match the computer you are using.

- **Delay**—assigns the knobs to baud rate and delay. Delay is the minimum time that the CSA 803 will wait before responding to a command sent from the computer. The delay setting can be 0 to 60 seconds.
- **EOL String**—lets you select the end-of-line query terminator to one of the following: **LF** (Line Feed), **CR** (Carriage Return), **CR/LF**, or **LF/CR**. Touch the selector repeatedly until the appropriate setting is displayed in the selector.



- **Verbose**—lets you set verbose **ON** or **OFF**. When verbose is on, the CSA 803 posts to the computer a message indicating the success or failure of each command sent to the CSA 803. When verbose is off, the computer can specifically query the CSA 803 about the success or failure of each command if so programmed.
- **RS232C Debug**—lets you set debug **ON** or **OFF**. When debug is on, the CSA 803 displays each command from the computer as it is executed. The messages appear at the top of the display. Debug off is the normal mode of operation. Set debug on if you need to watch the result of each CSA 803 command of a program that is running in the computer. When debug mode is on it slows performance significantly.

*RS-232-C Parameters*

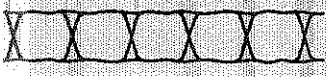

# Sampling Heads

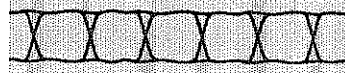

A sampling head is a small plug-in device that samples electrical signals and converts them to a much lower speed analog output signal. At least one sampling head must be installed in the CSA 803 to acquire signals.

Several types of sampling heads are available. The type and number of sampling heads you will use depends on the tasks you are performing with the CSA 803.

The CSA 803 mainframe provides four compartments for sampling heads, as shown below. Only the two right compartments can be used for acquisition. The two compartments on the left are power-only. They are for use with non-acquisition heads such as the SD-51 Trigger Head or the SD-42 Optical-to-Electrical Converter. Some sampling heads have two separate channels; others have only one.

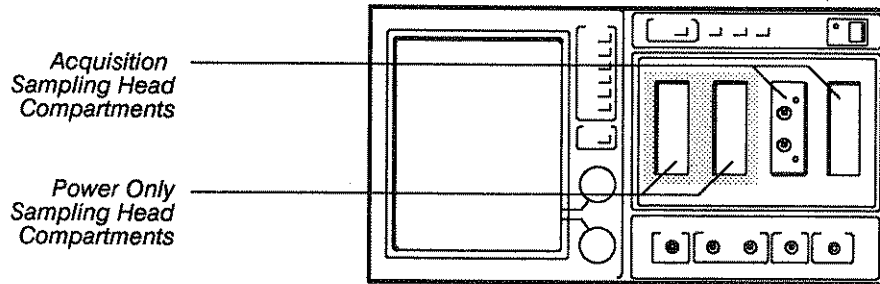

*Location of Sampling Head Compartments*

## Installing Sampling Heads

### CAUTION

Never install or remove a sampling head with the CSA 803 power on.

Power off the instrument before installing or removing sampling heads. To install a sampling head, place the head in the compartment and slowly push it in with firm pressure. Once the head is seated, turn the screw shaft on the sampling head to tighten the head into place.

## Sampling Heads



### Sampling Head Front Panel

The front panel of a typical sampling head is shown below. The sampling head illustrated, the SD-24 TDR/Sampling Head, has two channels.

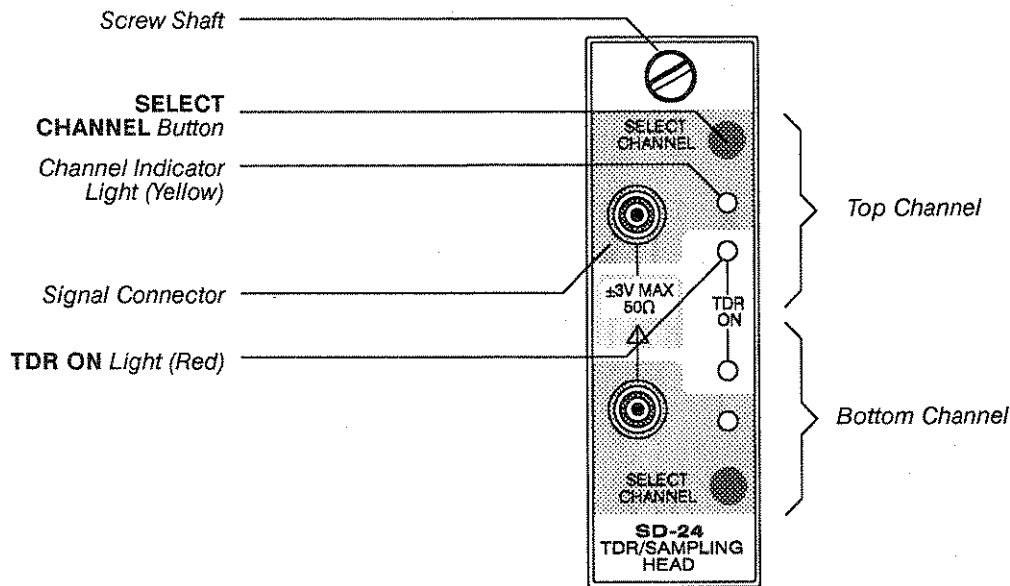

Sampling Head Control Panel (SD-24 shown)



#### CAUTION

Applying a voltage outside the range printed on the sampling head can result in damage. Static electricity is a hazard.

Each channel has a signal connector for signal input and for TDR pulse output. Each channel also has a **SELECT CHANNEL** button and an associated yellow channel indicator light, and a red **TDR ON** indicator light.

The input diodes in sampling heads are susceptible to damage from electrostatic discharge and from voltage levels that are outside the range printed on the face of the sampling head. Always wear an antistatic wrist strap connected to the **ANTISTATIC CONNECTION** on the CSA 803 when you are making connections to a sampling head or handling the device under test.

### Sampling Heads

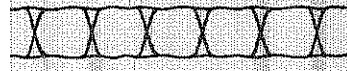

The channel indicator light can have three states: off, on steady, or blinking. The operation of the **SELECT CHANNEL** button depends on the light:

- If the yellow light is off, the channel is not displayed. Pressing the button creates a trace of that channel.
- If the yellow light is on steady, the channel is displayed but is not part of the selected trace. Pressing the button selects that trace, causing the light to blink.
- If the yellow light is blinking, the channel is part of the selected trace. Pressing the button will remove *all* traces displaying that channel.

The red **TDR ON** light indicates whether or not the sampling head is sending out a TDR (Time Domain Reflectometry) pulse through the signal connector. You cannot control the TDR function from the sampling head front panel; a menu in the mainframe is used to turn this feature on and off.

### Controlling TDR and Smoothing Functions

The time domain reflectometry (TDR) and smoothing functions cannot be controlled from the sampling head front panel. These functions are controlled using the **Sampling Head Fnc's** pop-up menu in the Waveform major menu.

The left part of the **Sampling Head Fnc's** pop-up menu lets you select the sampling head channel on which to set TDR or smoothing. The selectors in the right part of the pop-up menu always reflect the status of the TDR or smoothing for the sampling head channel selected in the left part.

### Time-Domain Reflectometry (TDR) and Time-Domain Transmission (TDT)

Time Domain Reflectometry, or TDR, is a method of characterizing a transmission line or network by sending a signal into one end and monitoring the electrical reflections. Some sampling heads have a TDR feature.

## Sampling Heads

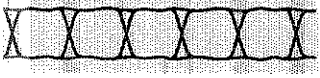

A TDR pulse can also be used to make Time Domain Transmission (TDT) measurements. TDT is a technique that allows you to measure the response of a system by sending pulses through a device and monitoring the output of the device. The measurements are made on signals transmitted through the device, rather than reflections from the device (as in TDR).

The selectors in the **Head Type** section of the **Sampling Head Fnc's** pop-up menu let you control the TDR functions of a sampling head that has the TDR feature. The **TDR/TDT** selector turns the feature **On** or **Off**. The **TDR Polarity** selector sets the polarity of the TDR pulse to **+** or **-**. **TDR  $\Delta$ Delay** assigns the knobs to set the delay between the TDR pulses generated by the two channels of the sampling head.

**TDR Preset** turns on the TDR step generator, selects Internal Clock trigger, creates a waveform on the selected channel, turns on rho scaling, turns on baseline correction, and autosets the TDR pulse. **Diff TDR Preset** performs the same actions as **TDR Preset** except it creates two channels of TDR, with opposite polarities. **Preset Clear** partially undoes TDR and Diff TDR settings by turning off TDR generators (waveforms are not deleted), and if no channels have TDR on, trigger source is set to external, trigger mode is set to Auto, baseline correction is turned off and vertical scaling is set to Volts (instead of rho).



## Sampling Heads



Sampling Head Functions				
Selected Channel -- M1			Head Type: SD-24	
1	2	3	4	
TDR/TDT Off			TDR Polarity +	
TDR Preset			Diff TDR Preset	
Preset Clear			TDR A Delay -392.2m	
External Channel Attenuation x1 0dB			Smoothing Off	
Exit				
Vertical Desc M1 Fast	Horizontal Desc Main @ 512 pts	Acquire Desc Continuous	Articulates Single s.V	Main Size 2ns/div Main Pos 37.1ns
Sampling Head Fnc's	Window Mode		More... Trace Status	Remove/CirPan/ Trace 1 Zoom M1 Main Off

### The Sampling Head Fnc's Pop-up Menu

**External Channel Attenuation** enables you to enter a number representing the external attenuation of a channel. Once the number has been entered (1 is the default), the instrument then uses the total attenuation factor in scaling measurement results. Note that the attenuation factor is also applied to Vertical Size.

Total attenuation is the product of the external attenuation times the hardware attenuation of the probe or sampling head. The hardware attenuation factor is displayed in the **Identify** pop-up menu of the Utility1 major menu.

## Sampling Heads

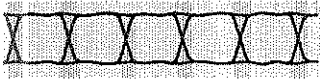

External attenuation can be specified either as a scaling factor (2, 5, 10 etc.) or in decibels (dB). dB is related to the attenuation factor by the formula:

$$dB = 20 \times \log_{10} (\text{attenuation factor})$$

The range for dB is -120 to +120.

Negative dB values or fractional attenuation factors indicate gain, rather than attenuation.

External channel attenuation is a feature of the mainframe, not of the sampling head. Thus, this feature applies to all sampling heads.

### Smoothing

If you turn on smoothing for one channel of a dual-channel sampling head, both channels are smoothed.

Smoothing is processing applied by the sampling head prior to the digitization of a trace, to reduce noise. When smoothing is on, the sampling head samples each trace sample, or dot, eight times before going on to the next dot. The average of the eight samples is digitized as the dot value in the trace record.

You turn smoothing on or off with the **Smoothing** selector in the **Sampling Head Fnc's** pop-up menu. Not all sampling heads provide smoothing, so **Smoothing** may not be selectable in some cases.

# Stored Settings



When you initialize the CSA 803, you recall a stored setting that was established at the factory. You can save your own instrument settings for quick recall.

If you establish a test set-up, you might want to store the setting and go to another task. After the instrument settings have been changed because of the intervening work, you could recall the test setting that you saved. Masks are saved with stored settings, so you can use stored settings to store sets of masks for different tests.

You can store up to ten different instrument settings for recall. You can also use the **SEQUENCE SETTINGS** button to recall saved settings in a specific order. This is useful if your work requires several instrument set-ups for standardized tests.

Stored settings are saved when you power off the instrument. They will be available when you power on.

The following instrument controls are not saved with stored settings, and are not changed when settings are recalled:

- Stored traces
- GPIB and RS-232-C parameters, except GPIB address is saved
- Enhanced accuracy calibrations, except **Delay Compensate** and **Time Base Cal Mode** are saved
- Display colors and intensity, audio feedback, vectored trace mode, and hardcopy mode
- Sequence settings mode

## Stored Settings



## Storing Settings

Use the **Store Setting** pop-up menu in the Store/Recall major menu to store a setting. After you set the instrument, touch the **Store Setting** selector to display the pop-up menu.

Store Present Front Panel Setting					
Setting 1	Setting 2	Undefined	Undefined	Undefined	
1	2				
Undefined	Undefined	Undefined	Setting 3	Undefined	
Menu Displayed with Stored Setting					
Waveform	Waveform	Trigger	Measure	Display Modes	
Single Tra	All Tra				
Status	Status				
Store/Recall	Cursors	Utility1	Utility2	Enhanced Accuracy	
Exit					
Store Trace	Recall Trace	Clear Trace	Delete Trace	Main Size	16.523994In/div
				Main Pos	313.95589In
Store Setting	Recall Setting	Sequence Settings	Delete Setting	Remove/ClrPan/Trace 1	Zoom M1 Off
		Off		Main	

### The Store Setting Pop-up Menu

You can choose which major menu you want to be displayed when the stored setting is recalled. Touch the selector of the desired major menu in the section of the pop-up menu titled **Menu Displayed with Stored Setting**. Both **Waveform** major menus are listed as options, and the **Cursors** major menu is also listed as an option.

## Stored Settings



After you choose the major menu you want recalled with the stored setting, touch one of the ten selectors in the top part of the **Store Setting** pop-up menu to store the setting in that storage area. This removes any setting previously stored there.

## Recalling Stored Settings

You can recall a stored setting using the **Recall Setting** pop-up menu in the Store/Recall major menu. Touch the **Setting n** selector, where n is the setting number you want to recall.

The **Recall Setting** pop-up menu also provides a way to initialize the CSA 803. The **Initialize Setting** selector operates the same as the Utility1 major menu **Initialize** selector. Initialization is described completely on page 143.

Recall Front Panel Setting					
Setting 1	Setting 2	undefined	undefined	undefined	undefined
1	2				
undefined	undefined	undefined	undefined	undefined	undefined
Initialize Setting			Exit		
Store Trace	Recall Trace	Clear Trace	Delete Trace	Main Size	100ps/div
				Main Pos	61.94628ns
Store Setting	Recall Setting	Sequence Settings	Delete Setting	Remove/Clear Trace 1	Pan/Zoom
		Off		M4	off
				Main	

### The Recall Setting Pop-up Menu

Stored Settings



**Deleting Stored Settings**

Use the **Delete Setting** pop-up menu in the Store/Recall major menu to delete a stored setting. Select the setting or settings to delete by touching the selectors in the top part of the pop-up menu. As you touch these selectors, they highlight to show that they will be deleted when you touch the **Delete Selected Settings** selector. Touch a highlighted selector a second time to remove it from the list of settings to delete. The **All Settings** selector is a quick way to select all the stored settings.

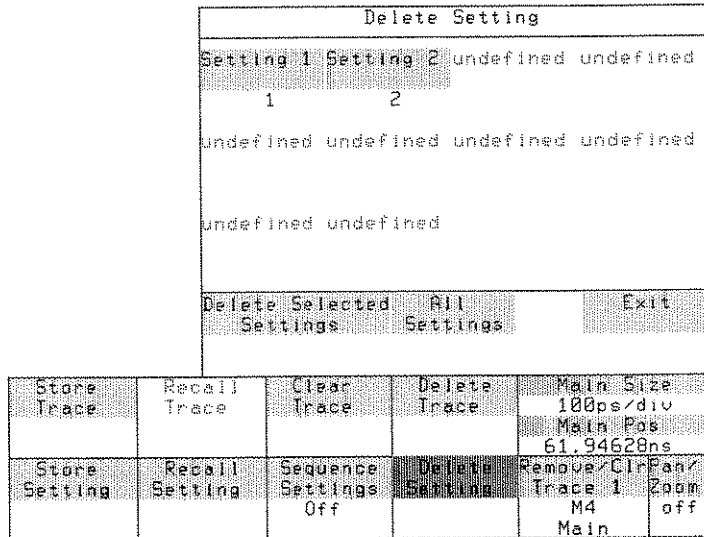

*The Delete Setting Pop-up Menu*

## Stored Settings

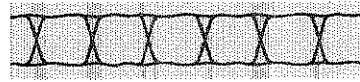

## Sequencing Through Stored Settings

If you have several settings saved, you can quickly cycle through the settings in a specified order. This is useful if you have a series of test set-ups that you want to use repeatedly.

When you store a setting using the **Store Setting** pop-up menu, the setting selector is assigned a number from 1 through 10. This is the sequence number for cycling through the settings. The sequence number is always from **Setting 1** through **Setting 10** in numeric order, omitting the storage areas that have no setting stored.

You can store settings in any storage area. You can determine the sequencing position of settings you store, because you can determine which setting comes before and comes after the setting you are storing.

Enable sequencing of settings by touching the **Sequence Settings** selector in the Store/Recall major menu. This selector can set sequencing to **On** or **Off**. When this selector is set to **Off**, the **SEQUENCE SETTING** button on the front panel does not operate.

When you have stored all the settings you want to sequence through and have enabled sequencing, use the **SEQUENCE SETTING** button to recall the next setting of the sequence. This button is located above the sampling head compartments, near the **ON/STANDBY** switch.

The  
**SEQUENCE  
SETTING  
Button**

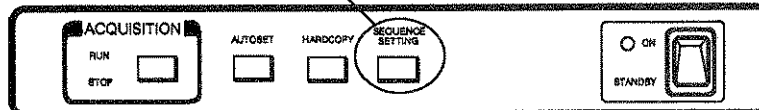

*Stored Settings*





# Stored Traces



A stored trace is a trace record of a single acquisition cycle. You can think of it as a “snapshot” of a trace. In normal acquisition mode, the stored trace is the same as the trace record on the display. For traces acquired in variable persistence, infinite persistence, or color grading modes, only the current 512-point trace record is saved (not the entire history of displayed points).

Once you have stored a trace, you can use it as an element of trace expressions in other traces. For example, you could define a trace to be **M1-*STO3***. This trace acquires data from sampling head channel M1 and subtracts from each sample the data recorded in stored trace number 3.

Stored traces are not saved when you power off the CSA 803. When you power on the instrument there are no traces stored.

## Storing Traces

When you store a trace, you take a copy of the trace record of the selected trace. The trace record is always copied into the stored trace location with the lowest available number.

Store Trace					
Next Storage: 3					
Trace 1		Trace 2			
M4		M4			
Main		Main			
Store All					
Exit					
Store Trace	Recall Trace	Clear Trace	Delete Trace	Main Size	
				100ps/div	
				Main Pos	
				61.94628ns	
Store Setting	Recall Setting	Sequence Settings	Delete Setting	Remove/Clr Trace 1	Par/Zoom
		Off		M4	off
				Main	

*The Store Trace Pop-up Menu*

## Stored Traces



Use the following steps to store a trace:

- Step 1: Create a stable trace on the display.
- Step 2: Press the **Store/Recall** major menu button, and touch the **Store Trace** selector in the major menu.
- Step 3: Observe the **Next Storage:** notation at the top of the pop-up menu. The trace you store will be assigned this number.
- Step 4: Touch the selector that represents the trace you want to store. All displayed traces are listed.

You can also use the **Store All** selector to store all the displayed traces as separate stored traces. In this case, the **Next Storage:** notation tells you the first storage number that will be used.

## Stored Traces



### Recalling Stored Traces

Once a trace is stored, you can use it when creating a trace expression. To create a trace that displays a stored trace, touch the **Def Tra** icon, then in the pop-up menu touch the **Stored Traces** selector, the selector for the stored trace you want to display, and the **Enter Desc** selector.

The **Recall Trace** pop-up menu provides a simpler way to do the same thing. Press the **Store/Recall** major menu button and touch the **Recall Trace** selector to display the pop-up menu. In the pop-up menu, touch the selector for the stored trace you want to display.

Recall Stored Trace					
STO 1		STO 2			
Exit					
Store Trace	Recall Trace	Clear Trace	Delete Trace	Main Size	
				100ps/div	
				Main Pos	
				61.94628ns	
Store Setting	Recall Setting	Sequence Settings	Delete Setting	Remove/Cl Trace 1	Zoom
		Off		M4	off
				Main	

*The Recall Trace Pop-up Menu*

## Stored Traces

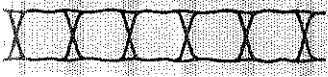

### Deleting Stored Traces

You can delete stored traces by using the **Delete Traces** pop-up menu in the Store/Recall major menu. This pop-up menu is also used to delete displayed traces.

In the **Delete Traces** pop-up menu, touch the selectors for the displayed and stored traces you want to delete. The traces are not deleted until you touch the **Delete Selected Traces** selector. You may select several traces to be deleted before touching the **Delete Selected Traces** selector. As you select traces to delete, their selectors highlight to tell you they will be deleted. If you touch a trace selector by accident, touch it again to remove the highlighting. If you want to delete all the displayed and stored traces, touch the **All Traces** selector.

You cannot delete a stored trace if it is being used as part of a displayed trace. In the illustration on the next page, stored trace 1 is used in the trace definition of displayed trace 3. The selector for stored trace 1 cannot be selected.

Stored Traces



Delete Trace					
Displayed Traces			Stored Traces		
Trace 1	Trace 2		ST0 1	ST0 2	
M2	M1				
Main	Main				
Trace 3					
M2+Intg(S...					
Main					
Delete Selected Traces		All Traces		Exit	
Store Trace	Recall Trace	Clear Trace	Delete Trace	Vert Size:M2	200mV/div
				Vert Offset:M2	-830.5mV
Store Setting	Recall Setting	Sequence Settings Off	Delete Setting	Remove/Cl Chan	Trace 1 Sel M2

The Delete Trace Pop-up Menu

*Stored Traces*



# System Identification



You can determine the configuration of your system by looking at the **Identify** pop-up menu in the Utility1 major menu.

System Identification					
CSA803 Mainframe ID# B010100					
Executive Processor : 2.16					
Display : 2.05					
Time Base/Controller: 2.33					
Acquisition #1 : 9.00					
Mainframe Sampling Heads					
Chan M1 :	1X	Chan M2 :	1X	SD-24	B021111
Chan M3 :	0X	Chan M4 :	0X		
GPIB / R9232C	Identify	Color	Hardcopy	Main Size	
			Bitmap Screen	2ns/div	
				Main Pos	
				37.1ns	
Initialize	Instrument	Labeling	Page	Remove/Clr	Pan/
	Options		to	Trace 1	Zoom
	15:48:09	Off	Enhanced	M1	Off
	26-APR-90		Accuracy	Main	

## The Identify Pop-up Menu

The top portion of the **Identify** pop-up menu shows the instrument serial number, and the version numbers of the firmware (programming) for the various internal microprocessors.

The lower portion of the **Identify** pop-up menu shows which channels have sampling heads installed (1X) and which channels are not available (0X). For those channels that have sampling heads, the sampling head type and serial number is shown.

*System Identification*





# TDR



This section describes how to perform time domain reflectometry (TDR) measurements. TDR measurements can be made only with an SD-24 TDR/Sampling Head or an SD-20 Loop-Thru Sampling Head; none of the other SD Series sampling heads provide TDR capabilities.

## TDR Step Generation

Both channels in the SD-24 TDR/Sampling Head have a step generator, which gives both channels TDR measurement capabilities. You can use the outputs of both generators to perform differential and common mode TDR measurements.

The SD-20 Loop-Thru Sampling Head is capable of performing single-ended TDR when used with an external signal generator. This discussion pertains mainly to the SD-24 TDR/Sampling Head.

The step generator circuitry consists fundamentally of an adjustable current source and a diode switch. Initially, before the step, the diode switch is biased to conduct current to the output. When the diode switch opens, the step occurs. The following simplified diagram shows the switch and the current source.

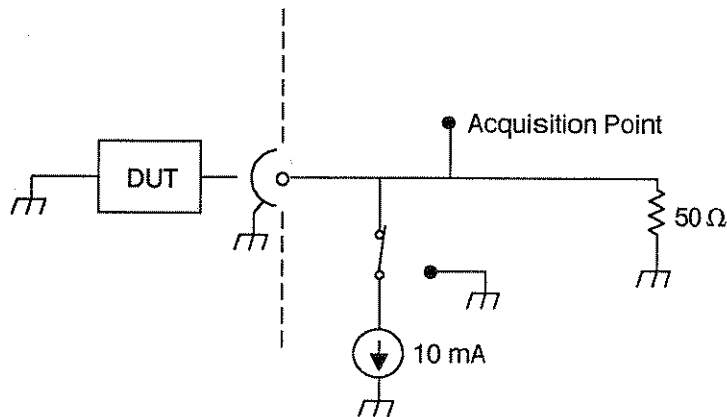

*Step Generator Simplified Schematic Diagram*



Because of the architecture of the step generator, the output voltage of the step depends on the DC resistance to ground of the device under test. The following sections describe the operation with a short circuit, an open circuit, and a  $50\ \Omega$  load.

### Operation Into a Short Circuit

Initially, the diode switch is conducting  $-10\ \text{mA}$ . Since the step generator output is initially shorted, the resistance to ground is  $0\ \Omega$  and the output voltage is  $0\ \text{V}$ .

When the diode switch opens (reverse-biased), apparent resistance to ground at the acquisition point (and at the channel connector) is  $25\ \Omega$ , because the internal termination resistance is  $50\ \Omega$  and the connector impedance is  $50\ \Omega$ . The voltage at the acquisition point rises to  $+250\ \text{mV}$ .

The transition propagates to the short in the device under test and is negatively reflected back to the acquisition point; canceling the transition. The time displayed from the first transition to the second transition is the propagation time from the acquisition point to the short in the device under test and back.

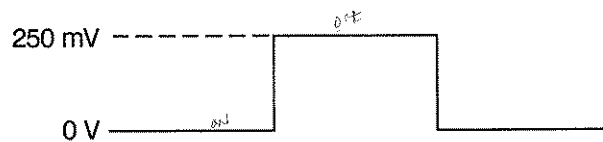

*Step Generator with a Shorted Output*



### Operation Into a 50 $\Omega$ Load

Initially, the diode switch is conducting. Since the step generator output is connected to a 50  $\Omega$  load, the resistance to ground at the acquisition point is 25  $\Omega$  (because of the internal 50  $\Omega$  impedance). The 10 mA current source places -250 mV at the acquisition point.

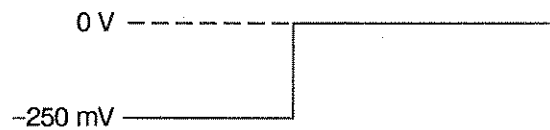

*Step Generation with a 50  $\Omega$  Load*

When the diode switch opens (reverse-biased), the return path to ground is broken and the acquisition point rises to 0 V. The matched impedance allows the acquisition point to remain at 0 V.

### Operation Into an Open Circuit

Initially, the diode switch is conducting. Since the step generator output is open, the resistance to ground at the acquisition point is 50  $\Omega$  (because of the internal 50  $\Omega$  impedance). The -10 mA current source places -500 mV at the acquisition point, as a starting condition.

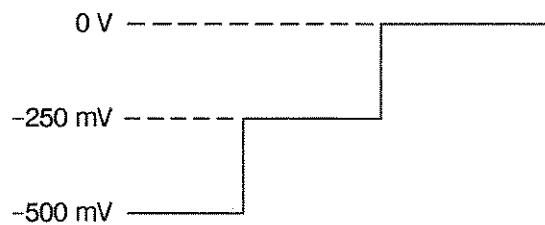

*Step Generation with a 50  $\Omega$  Load*

## TDR



When the diode switch opens (reverse-biased), apparent resistance to ground at the acquisition point (and at the channel connector) is  $25\ \Omega$ , because the internal circuit impedance is  $50\ \Omega$  and the connector impedance is  $50\ \Omega$ . This causes the acquisition point to rise to  $-250\ \text{mV}$ .

The transition propagates to the open in the device under test and is reflected back to the acquisition point, causing the voltage at the acquisition point to rise to  $0\ \text{mV}$ . At the acquisition point, the time displayed from the first step to the second step is the propagation time from the acquisition point to the open in the device under test and back.

### Baseline Correction

Baseline correction is a feature of the CSA 803 Communications Signal Analyzer. This feature holds the displayed baseline of a trace in one location despite variations of the offset in the sampling head. These offset variations are caused by changes in impedance at the device under test as just described.

Baseline correction is especially useful with TDR/TDT measurements. Without baseline correction, changes in the DC resistance to ground for the cable or device under test would cause the entire step to move vertically on the display.

Baseline correction keeps the baseline in one location vertically. For the CSA 803, you can enable baseline correction from the Graticules pop-up menu. However, if you use the **TDR Preset** selector to set up for TDR measurements, baseline correction is automatically turned on. For more information on baseline correction, see page 49.



### Example: Taking TDR Measurements

This example demonstrates the TDR (Time Domain Reflectometry) feature of the SD-24 sampling head. TDR is a method of examining and measuring a network or transmission line by sending a step into the network and monitoring the reflections.

For this example you will need an CSA 803 with at least one SD-24 installed. Also, you will need one SMA cable, preferably of 5 ns length.

- Step 1: Initialize the CSA 803 (press **UTILITY**, touch **Initialize** and touch **Initialize** again).
- Step 2: Attach one end of the cable to any SD-24 sampling head input. Leave the other end unattached.

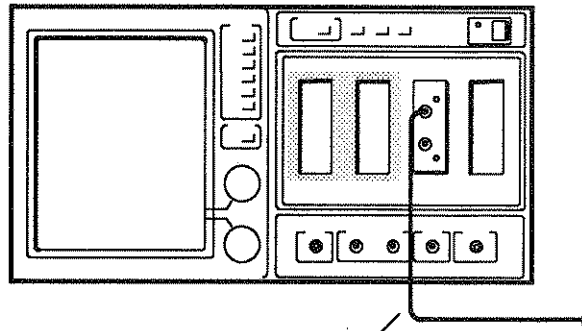

Not  
Connected

Connections for Example

- Step 3: Press the **SELECT CHANNEL** button on the sampling head input channel to which you have connected the cable.

## TDR



You see only a flat trace on the display because there is no signal on the channel. But, when the TDR feature is used, the sampling head supplies the signal for you. As with the calibrator signal, the TDR step is synchronized with the internal clock.

- Step 4: Press the **WAVEFORM** button, and touch the **Sampling Head Fnc's** selector.
- Step 5: To turn on TDR, touch **TDR Preset**. The TDR Preset function acts to turn on the step generator for the selected channel, creates a trace from that channel, sets the graticule to rho scaling, turns on baseline correction, and autosets the TDR waveform.

The sampling head will turn on a red light next to the channel input connector, indicating that TDR is activated for that channel. TDR can be used on each channel independently.

- Step 6: Adjust the display sizes and positions to show a trace similar to that shown on the next page. **AUTOSET** may make this job easier, and the vertical ( $\updownarrow$ ) and horizontal ( $\leftrightarrow$ ) icons will let you make fine adjustments.

TDR

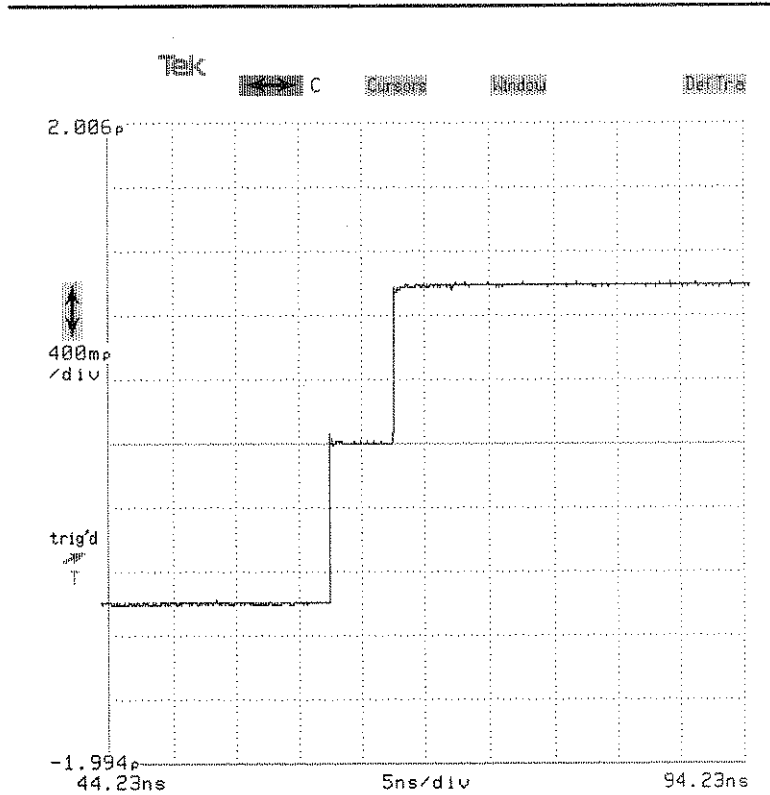

#### *TDR Step and Reflection*

The first rise of this trace is the incident TDR step leaving the sampling head; the second rise is the reflection of the step returning from the end of the cable.

#### **Changing Graticule Units for TDR**

The units of measure commonly used in TDR are units of rho ( $\rho$ ), measured on the vertical axis, and time on the horizontal axis. You can change the measurements by using the **Graticules** selector on the **Waveform** major menu.

TDR



Graticules

Create Second Graticule      Reduce to One Graticule

Move Trace to Other Graticule

---

Y Units

Volts      Rho

Reference Amplitude 250mV      Baseline Correction Off

---

X Units

Seconds      Meters      Feet      Inches

Propagation Velocity 0.7

---

Exit

Vertical Desc	Horizontal Desc	Acquire Desc	Graticules	Main Size
M1 Fast	@ 512 pts	Continuous	Single s.V	100ps/div
Sampling Head Fnc's	Window Mode		More...	Main Pos 37.1ns
			Trace Status	Remove/Clr Pan/Trace 1 Zoom M1 Off

*The Graticules Pop-up Menu*





- Step 7: Touch **Graticules** in the major menu and **Feet**, **Meters**, or **Inches** in the pop-up menu. If you know that the propagation velocity of your cable differs from the default, touch the **Propagation Velocity** selector and adjust this parameter. If you don't know the velocity or are using Tektronix SMA cables, accept the 0.7 default. This unitless number represents the fraction of the speed of light that signals pass through your network or transmission line. If you don't know the propagation velocity but you know the dielectric constant of the transmission medium, you can convert their dielectric constant to a propagation velocity using the following equation:

$$\text{Prop velocity} = \frac{1}{\sqrt{\text{dielectric constant}}}$$

Measurements and cursor readouts are always expressed in the same units as the graticule axes.

The horizontal axis is now calibrated in your chosen units of measurement.

To set the vertical axis to rho, you need to specify the amplitude, in volts, of the incident step that the sampling head sends through the cable. Touching the **Reference Amplitude** selector assigns both knobs to this parameter.

For the SD-24, this step amplitude is 250 mV. This amplitude is also the default setting of this parameter, so you don't need to change this parameter when using the SD-24.

For the SD-20, the step amplitude depends on the external signal source used.

Note that when using the TDR Preset function, the vertical axis scaling is automatically set to Rho.

- Step 8: Touch **Exit** to remove the pop-up menu and view the trace and graticule.

## TDR



### Example: Differential and Common Mode TDR

The CSA 803 can perform differential and common mode TDR measurements with the SD-24 sampling head. As described earlier, the sampling head has two sampling input channels and two independent step generators.

The step generator output for each channel is selectable for positive or negative polarity and amplitude. This example will show you how to use the two channels and step generators of an SD-24 to perform differential and common mode TDR measurements.

For this example you need at least one SD-24 installed in the left acquisition slot of the CSA 803. You also need one SMA cable, preferably of 5 ns length.

- Step 1: Initialize the CSA 803 (press **UTILITY**, touch **Initialize** and touch **Initialize** again).
- Step 2: Attach one end of the cable to any SD-24 sampling head input. Leave the other end unattached.
- Step 3: Press the **SELECT CHANNEL** button on the sampling head input channel to which you have connected the cable.
- Step 4: Touch the **Sampling Head Fnc's** selector.
- Step 5: Touch **TDR Preset**.
- Step 6: Attach the loose end of the cable to the lower channel connector on the same sampling head.
- Step 7: Adjust the display size and position to show a trace similar to that shown in the following figure.

TDR

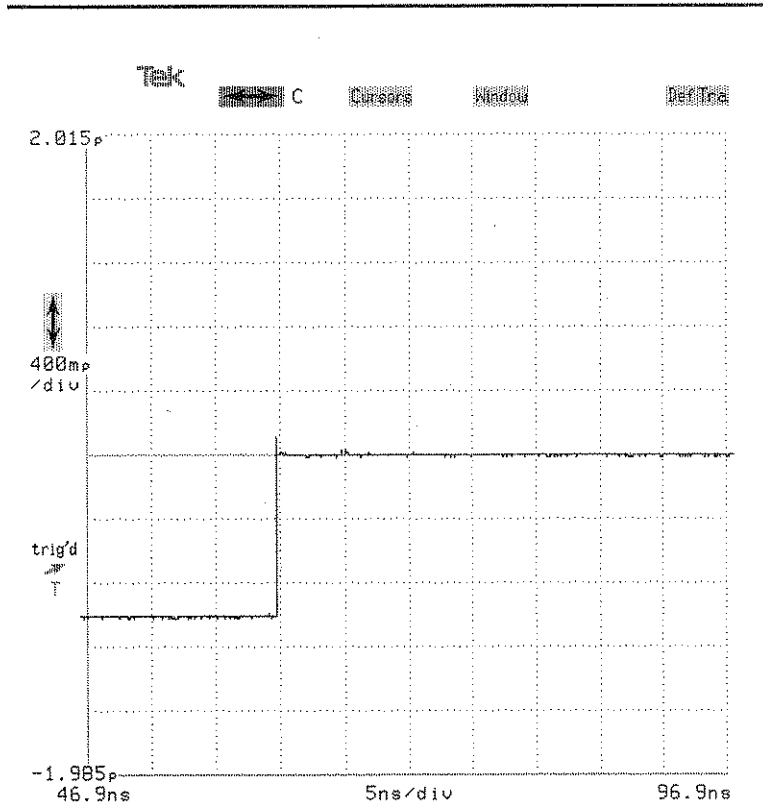
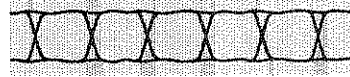

Single Channel TDR

In the above figure, notice that there is only one rising edge, that of the incident TDR step. There is very little or no reflection, because the impedance of the termination in the receiving channel connector matches the impedance of the cable.

## TDR



- Step 8: Press the **SELECT CHANNEL** button for the lower channel on the sampling head. Adjust the vertical and horizontal settings to display the TDR step generated by the upper channel.

The horizontal distance separating the leading edges on the two traces is the time it takes the step transmitted by channel 1 (upper channel) to be sampled by channel 2 (lower channel).

- Step 9: Touch **Sampling Head Fnc's**, touch **2** under Selected Channel. Touch **TDR/TDT** to turn on the step generator for that channel. The lower channel on each sampling head has an internal delay adjustment. This lets you set the time at which the step generator for the lower channel asserts the TDR step. Touch the **TDR Head  $\Delta$  Delay** selector. Then touch **Exit** to remove the pop-up menu.

In step 9, you turned on TDR for the lower channel, and you also assigned the knobs to adjust delay for the TDR step generator. With some adjustments, the mainframe displays the following two traces.

TDR

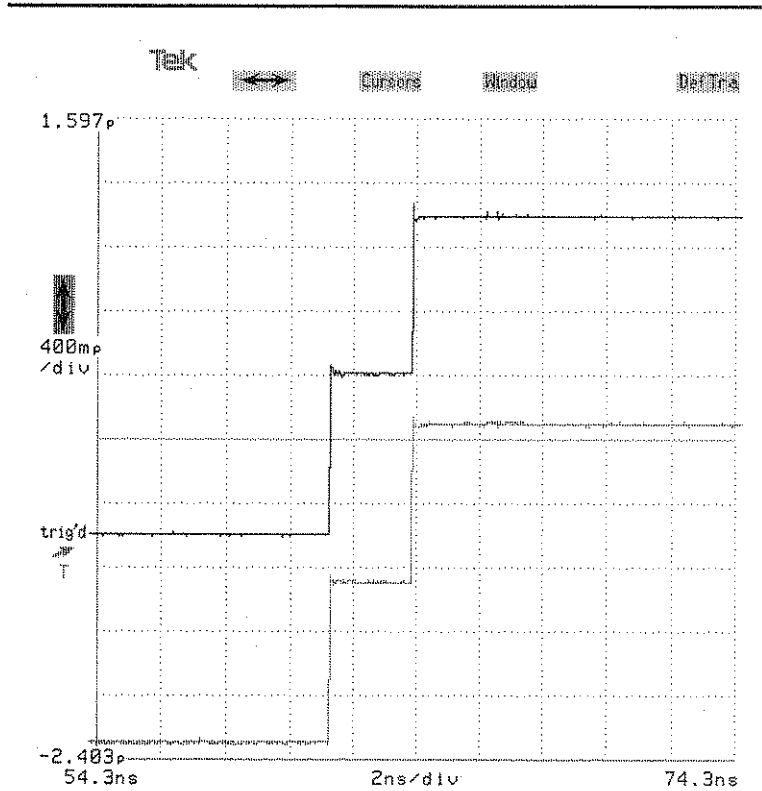

Channels 1 and 2 TDR

Notice that there are two rising edges on each trace. On the upper trace, the left-most edge is the step transmitted by the step generator of the upper channel, M1. The second rising edge is the step transmitted by the step generator of lower channel, M2.

On the lower trace, the left-most edge is the step transmitted by the step generator of the lower channel, M2. The second rising edge is the step transmitted by the step generator or the upper channel, M1.

## TDR



Note that both steps are positive. This is equivalent to common mode transmission. For both traces, common mode operation appears as though the cable is open at the middle (since the two steps meet and are cumulative).

- Step 10: Turn either knob on the mainframe to adjust the delay for channel 2. This varies the time when channel 2 asserts the TDR step.

Notice that on the upper trace the second edge moves horizontally, and on the lower trace the first edge moves horizontally. They are actually the same step, seen at different times by the two channels.

- Step 11: Press the **WAVEFORM** button. On the display, touch **Sampling Head Fnc's**. Touch **1** and the **TDR Polarity** selector. This causes channel 1 to assert a negative TDR step. Touch **Exit**.

Notice that the upper channel is asserting a negative TDR step. This is equivalent to differential TDR. Note that in both traces, the step appears as though the cable is shorted at the center of the cable (since the two steps meet and cancel to zero volts).

When the TDR steps on the two channels are opposite (one positive and one negative), you can now define a trace that represents the true differential signal by touching the **DefTra** icon and touching **1, -, 2, Enter Desc**.

When the TDR steps on the two channels are the same polarity (both positive or negative), you can define a trace that represents the true common mode signal by touching the **DefTra** icon and touching **1, +, 2, Enter Desc**.

This example has been designed to show how the instrument acquires common-mode and differential TDR traces, and how they relate to each other.



Differential TDR is quickly set up by using the **Diff TDR Preset** selector on the **Sampling Head Fnc's** pop-up menu. This preset automates the setup for differential TDR by:

- Turning on both channels of the SD-24
- Turning on both step generators
- Inverting the polarity on one step generator
- Autosetting both traces
- Turning on Baseline Correction
- Changing the vertical scaling from volts to rho

#### **TDT Measurements**

You can make forward and reverse Time Domain Transmission (TDT) measurements using the SD-24. To perform a TDT measurement, connect one sampling head channel to the input of the device under test and the other sampling head channel to the output of the device under test. You can then alternately enable the step generators on both channels and sample the transmitted signal on the other channel to perform forward and reverse TDT measurements.

## TDR

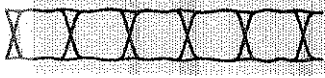

### More About TDR Measurements

When making differential or common mode TDR measurements, it is important that the two steps arrive at the same time at the reference plane (usually the connection point to the device under test). To check and adjust this condition, disconnect the transmission cables from device under test *at the point where the cables connect to the device*. If the cables aren't matched perfectly, matching either the incident or the reflected edges will not match the steps at the end of the cable, since the reflections had to travel back through unmatched cables as well. As shown in the figure below, to match the steps at the open end, make the delay between the incident steps,  $T_1$ , equal but opposite sign to the delay between the reflected steps,  $T_2$ .

For some measurements and comparisons, you may want to visually line up the leading edges of both TDR steps, even though you've delayed the step assertion time for one channel. To do this, create a window of each trace, and place each window trace in the lower graticule. Then select one of the window traces and, using the  $\updownarrow$  icon and the lower knob, position the leading edge of the trace. This does not affect the arrival of the TDR steps at the reference plane.

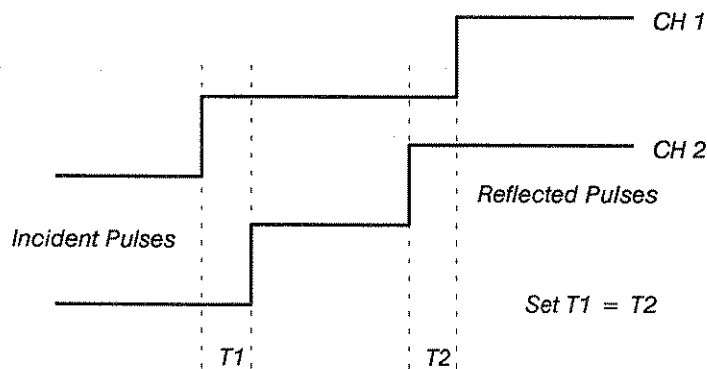

*Ensuring Pulses Arrive at the Reference Plane at the Same Time*



# Time and Date



The CSA 803 has an internal clock that keeps track of the time and date. You can set the clock using the **Instrument Options** pop-up menu in the Utility1 major menu. When you touch the **Hours**, **Minutes**, **Seconds**, **Month**, **Day**, or **Year** selector, one of the knobs is assigned to set that clock parameter.

Next to the time and date selectors is a readout showing how many times the CSA 803 has been powered on, and how many hours it has been on.

Time and Date  
Selectors

Instrument Options					
Autoset Options					
Vertical Autoset	Horizontal Autoset	Trigger Autoset	Enable	All	
On	On	On			
Main Record Autoset Mode			Undo Last Autoset		
Period Mode	Edge Mode				
Display Intensity 60%					
Audio Feedback On		Vector Trace On		Trace Scaling Optional	
Hours	Minutes	Seconds	Time: 10:43:12		
10	43	12	Date: 16-APR-90		
			Ontime: 107.8hrs		
			Powerups: 118 times		
Month	Day	Year			
APR	16	90			
Exit					
GPiB / R5232C	Identify	Color	Hardcopy	Main Size	
			Bitmap Screen	5ms/div	
				Main Pos	
				79.84304ns	
Initialize	Instrument Options	Labeling	Page to	Remove/Clear	Pan/Zoom
	10:43:12	Off	Enhanced Accuracy	M1	Off
	16-APR-90			Main	

The Instrument Options Pop-up Menu

*Time and Date*



# Trace Definition and Management



Traces are the visible representation on the display of the electrical signal, or combination of signals, that the CSA 803 samples and digitizes. You can define and display up to eight traces simultaneously.

You define a new trace on the main time base by entering a *trace expression*. A trace expression is a description of the signal sources and mathematical computation that determines the trace display. An example of a simple trace expression is **M1**, which specifies that a trace should show the signal source of mainframe channel 1, with no mathematical computation. The trace defined by this trace expression displays the signal that the CSA 803 samples and digitizes from the specified sampling head input channel.

An example of a complex trace expression is **Log(M1 + M2)**, which specifies that the signals from mainframe channels 1 and 2 are to be algebraically added, and the base 10 log of the sum is to be shown as the final trace.

## Defining New Traces

You define traces on a window time base using the **Window** icon, described on page 259.

### Defining Traces Using the DefTra Icon

You enter trace expressions using the **DefTra** icon. A **DefTra** icon appears above the top right corner of the graticule or graticules on the display. Touch the **DefTra** icon above the graticule on which you want to define a new trace. When you touch the icon, a blank **DefTra** pop-up menu is displayed. This pop-up menu covers the entire display, as shown on the next page.

You use the selectors of the **DefTra** pop-up menu to “type” your trace expression. As you type, the trace expression you are building appears at the top of the pop-up menu. The **Back Space** selector lets you correct errors as you type. When your trace expression is complete, touch the **Enter Desc** selector to remove the pop-up menu and create the new trace.

For example, to enter the expression **Log(M1 + M2)**, touch the following selectors in sequence: **Log**(, **1**, **+**, **2**, **)**, **Enter Desc**.

Trace Definition and Management



Trace Expression Being Entered

Channel Selectors

Numeric Keypad

Trace Functions or Stored Traces

Syntax Selectors

Vertical Description							
M1+							
Mainframe Channels				7	8	9	+
1	2	3	4	4	5	6	-
				1	2	3	*
				0	.	EEX	/
		Abst	Avgt	Diff	End		
Trace Functions		Expt	Intgt	Ln	Log		
Stored Traces		Signum	Sqrt	Smooth	Filter		
Enter Desc	(	)	,	Back Space	Cancel		
Vertical Desc	Horizontal Desc	Acquire Desc	Graticules	Main Size			
M1	Main	Continuous	Single	5us/div			
Fast	@ 512 pts		s,V	Main Pos			
Sampling Head Func's	Window Mode		More...	Remove/Clr	Pan/Zoom		
			Trace Status	Trace 1	M1	Off	
				Main			

The DefTra Pop-up Menu

Another example of a trace expression, M1-(2\*Smooth(STO1,5)), is entered as 1, -, (, 2, \*, Smooth(, Stored Traces, STO1, ,, 5, ), ), Enter Desc.

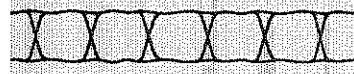

The selectors presented in the **DefTra** pop-up menu are grouped into the following categories:

- **Channel Selectors**—let you specify a sampling head channel. The CSA 803 presents only those channel numbers where a sampling head is installed.
- **Numeric Keypad**—lets you enter a numeric value as part of your trace expression, or one of the four arithmetic operators +, -, \*, and /.
- **Trace Functions**—let you specify a function, which are listed on the next page. This area of the menu is shared with the stored traces selectors described below. If the **Trace Functions** selector is highlighted, the trace function selectors are shown. Touch the **Trace Functions** selector to highlight it if the stored traces list is shown.
- **Stored Traces**—list all the traces that have been stored in the CSA 803. For a discussion of stored traces, see *Stored Traces* on page 209. This area of the menu is shared with the trace functions selectors described above. If the **Stored Traces** selector is highlighted, the stored trace selectors are shown. Touch the **Stored Traces** selector to highlight it if the trace functions list is shown.
- **Syntax Selectors**—( and ) let you specify the order of mathematical operations. Each opening parenthesis must be matched with a closing parenthesis. Use the , selector to separate arguments to functions that require more than one argument, as does **Smooth**(. Use **Back Space** to correct errors as you enter the trace expression. Always finish your trace expression by touching the **Enter Desc** selector. **Cancel** allows you to leave the **DefTra** pop-up menu without implementing the trace expression entered. **Cancel** can be selected at any time.

Trace Functions and Stored Traces can both be included in a single trace expression.

All trace functions have an opening parenthesis. You must use a closing parenthesis to enclose the function arguments.



Average and envelope can be applied to a trace that is already defined and being displayed. See Averaging and Enveloping, on page 45

### Using Trace Functions in Trace Expressions

Trace functions operate on arguments which are usually channels or trace expressions. The function is applied to each individual sample of the trace. The trace that is displayed is built from the function being applied to each sample.

#### Trace Functions

Function	Effect on Arguments
<b>Abs(...)</b>	The absolute value of the argument trace.
<b>Avg(...)</b>	The average of several trace record acquisitions of the argument. The number of records acquired is controlled by the knobs after touching the <b>Avg N</b> selector in the <b>Acquire Desc</b> pop-up menu.
<b>Diff(...)</b>	The differential of the argument.
<b>Env(...)</b>	The limit of excursion of several trace record acquisitions of the argument. The number of records acquired is controlled by the knobs after touching the <b>Env N</b> selector in the <b>Acquire Desc</b> pop-up menu.
<b>Exp(...)</b>	The natural antilog of the argument.
<b>Filter(...)</b>	Applies the Smooth function to a trace two times. Like <b>Smooth</b> , Filter has two arguments. The first argument is the trace to be filtered, the second argument is a rise time. Each time Filter is evaluated, the record length, time per division, and the specified rise time are used to calculate the number of dots to be used in the smoothing algorithm.
<b>Intg(...)</b>	The integral of the argument.
<b>Ln(...)</b>	The natural logarithm of the argument.
<b>Log(...)</b>	The base 10 logarithm of the argument.
<b>Signum(...)</b>	The sign of the argument. Signum returns 1 if an argument is greater than zero and -1 if less than zero.



## Trace Functions (Cont.)

Function	Effect on Arguments
<b>Smooth(...)</b>	A moving average of a trace. This function has two arguments, separated by a comma ( , ). The first argument is the trace to be smoothed, the second argument is the number of samples in the moving average. If the second argument is 9, then 4 samples before each point and 4 samples after each point are averaged with the point value. If the second argument is an even number, one is added to it to make it odd. <b>Smooth(</b> can be applied to stored traces or a single channel live trace.
<b>Sqrt(...)</b>	The square root of the argument.

Stored traces are described on page 209.

## Defining Traces Using the Sampling Head Channel Button

A short-cut method of defining traces is available. When you want to define a trace that represents a single sampling head channel, you can press the **SELECT CHANNEL** button on the sampling head. There are two limitations to this method:

- The channel must not be displayed as part of any other trace being displayed. If the yellow channel light is on, either steady or blinking, this method of defining a trace cannot be used.
- The trace expression will consist only of this channel. You cannot use this method to enter complex trace expressions.

## Trace Numbers

When you define a new trace, the CSA 803 assigns it a trace number. Trace numbers range from 1 through 8. New traces are assigned the lowest available number. Once a number is assigned to a trace, the number does not change.

## Selecting Traces

When you define a new trace, it is highlighted (bright intensity) on the display. This indicates that it is the selected trace. When multiple traces are displayed, there is always one selected trace. The graticule labels and axes match the color of the selected trace.



The selectors, knobs, and buttons operate on the selected trace. The graticule axis labels show the vertical and horizontal size and position of the selected trace. Selectors that show trace status, such as the **Vertical Desc** and **Horizontal Desc** selectors in the Waveform major menu, show the status of the selected trace. When you use the  $\leftrightarrow$  and  $\updownarrow$  icons to assign the knobs to horizontal or vertical size and position, the knobs affect the selected trace.

When you have more than one trace on the display, you can select and highlight any trace. There are three methods that you can use to select a trace; touch the trace on the display, use the All Trace Status major menu, or use the sampling head **SELECT CHANNEL** button.

#### Selecting Traces by Touch

The fastest way to select a trace is to touch it on the display. When you touch the graticule area of the display, a box is displayed that shows the boundaries of your touch. If a single trace passes through the boxed area when you remove your finger, that trace will become the selected trace. The touch box disappears when you withdraw your finger and select a trace.

You can drag your finger across the display to change the position of the box before you remove your finger to select the trace.

If several traces pass through the area indicated by the touch box, one becomes the selected trace when you remove your finger. Touching the same area repeatedly will select different traces. You can select traces by touching the same spot on the display repeatedly, until the trace you want is selected.

#### Selecting Traces Using the Trace Status Menu

You can see the status of all displayed traces at once using the Trace Status menu. You are shown the trace number, the first part of the trace expression, the time base, and the vertical and horizontal size per division.





To view this information, touch the **More...** selector in the Waveform major menu. The entire Waveform major menu is replaced by the Trace Status major menu, though the light beside the **WAVEFORM** button remains lighted.

This menu shows one selector for each displayed trace. You can select any trace by touching its selector. The selector for the selected trace is always highlighted. The **Return to Single Trace** selector restores the regular Waveform major menu.

1: M1	2: M2		
Main	Main		
200mV	200mV		
500ns	500ns		
			Return to Single Trace

*The Trace Status Menu*

**Selecting Traces Using the Sampling Head Channel Button**

You may want to select a trace that displays a specific sampling head channel. If that sampling head channel is not already part of the selected trace, you can press the **Select Channel** button on the sampling head.

You can look at the channel light on the sampling head to determine if that channel is part of the selected trace. If the light is on and blinking, then the channel is part of the selected trace, and pressing the channel button will remove the selected trace. If the light is on and not blinking, that indicates that the channel is displayed but is not part of the selected trace. Pressing the channel button will select a trace that contains that channel.

Stored traces are described on page 209.



### Modifying Traces

You can change the trace expression of the selected trace. When you touch the **Vertical Desc** selector in the Waveform major menu, the **Vertical Desc** pop-up menu is displayed.

This menu is identical to the pop-up menu that is displayed when you touch the **DefTra** icon. When you display the **Vertical Desc** pop-up menu, the trace expression of the selected trace appears at the top of the pop-up menu. You can use the **Back Space** selector to alter the trace, or you can extend the trace expression. When you touch the **Enter Desc** selector, the new trace expression is applied to the selected trace.

### Removing Traces

You can remove traces from the display in two different ways: using the **Remove/Clr** selector in the Knob menu or using the **Select Channel** button on the sampling head.

#### Removing Traces Using the Remove/Clr Selector

The **Remove/Clr** selector in the Knob menu always shows the number, the trace expression, and the time base of the selected trace. The knob menu is displayed at all times, and so the **Remove/Clr** selector is available regardless of which major menu is displayed.

As shown in the following diagram, when you touch the **Remove/Clr** selector, a small pop-up menu appears allowing you to remove or clear the selected trace. Removing a trace turns off the selected channel and causes the trace to disappear. Clearing a trace affects averaged, enveloped, color graded, variable persistence and infinite persistence waveforms. Touching **Clear** causes the selected function to start over, removing all current waveform data. The selected waveform remains on-screen; its description is unaltered.

## Trace Definition and Management



Verify Remove/Clear Trace					
Remove		Clear		Cancel	
Trace 1		Trace 1			
M1		M1			
Main		Main			
Vertical Desc	Horizontal Desc	Acquire Desc	Graticules	Main Size	Pan/Zoom
M1	Main	Continuous	Single	2ns/div	
Fast	@ 512 pts		s, V	Main Pos	
Sampling Head: Fnc's	Window Mode		More...	Remove/Clear	Trace 1
			Trace Status	M1	Off
				Main	

### The Remove/Clr Selector in the Knob Menu

#### Removing Traces Using the Sampling Head Channel Button

You can use the **Select Channel** button on the sampling head to remove all traces displaying that channel as part of their trace expression.

When a sampling head channel is incorporated as part of the selected trace, the yellow channel light on the sampling head is on and blinking. If you press the channel button on the sampling head when the light is blinking, *all* traces displaying that channel are removed.



## Trace Scaling

When you define a new trace, it is defined as either a fast trace or a high precision trace. Fast traces are computed with integer arithmetic, and operate significantly faster than high precision traces. High precision traces use floating-point arithmetic to provide highest precision.

Normally, the trace is defined to be fast unless some part of the trace expression forces high precision. Floating-point functions such as **Diff()** and **Log()** will force the trace to be defined as high precision.

You can force complex traces to be defined as high precision traces by using the **Instrument Options** pop-up menu in the **Utility1** major menu. In this pop-up menu, the **Trace Scaling** selector can be set to **Optional** or **Forced**. When set to optional, new traces are defined as fast traces if they can be implemented as fast traces. When set to forced, new complex traces are defined as high precision traces. Single-channel traces without waveform math are always acquired in Fast mode.

Once a trace is defined, its trace scaling cannot be changed. The setting of the **Trace Scaling** selector affects only the definition of new traces.

Trace Definition and Management



Trace Scaling Selector

Instrument Options					
Autoset Options					
Vertical Autoset	Horizontal Autoset	Trigger Autoset	Enable	All	
On	On	On			
Main Record Autoset Mode			Undo Last Autoset		
Period Mode	Edge Mode				
Display Intensity	Audio Feedback	Vector Trace	Trace Scaling		
50%	On	On	Optional		
Hours	Minutes	Seconds	Time: 10:43:12		
10	43	12	Date: 16-APR-90		
			Ontime: 107.8hrs		
			Powerups: 118 times		
Month	Day	Year			
APR	16	90			
Exit					
GPIB / RS232C	Identify	Color	Hardcopy	Main Size	
			Bitmap Screen	5us/div	
				Main Pos	
				79.84304ns	
Initialize	Instrument Options	Labeling	Page to	Remove/Cir	Pan/Zoom
	10:43:12	Off	Enhanced Accuracy	M1	Off
	16-APR-90			Main	

The Instrument Options Pop-up Menu

*Trace Definition and Management*



# Triggering



A trigger is an electrical event that initiates acquisition of a trace. The event that triggers acquisition is when the trigger *source*, the signal being monitored by the trigger circuits, passes through a specified voltage *level* in the specified direction (the trigger *slope*).

Until a trigger event takes place, a newly defined trace will not appear on the display. If triggering of an acquired trace stops, the last trace record is left "frozen" on the display. The trigger status is shown to the left of the graticule as either **trig'd** or **Inot! trig'd**.

The trigger source can be the internal clock, or a signal that you apply to one of the trigger input connectors on the CSA 803 front panel. You can connect the signal being sampled to the trigger input connectors using a signal splitter or power divider, so that the sampled signal is also the trigger signal. Whatever signal you use as the trigger source, it should be synchronized with the signal you are sampling and displaying.

External triggers can be connected to either the **DIRECT** or **PRESCALE\*** connectors on the CSA 803 front panel. Signals connected to the **DIRECT** connector are fed directly to the trigger circuitry. The signal is DC coupled and can be up to 2.5 GHz. Signals connected to the **PRESCALE** connector are divided by eight and then fed to the trigger circuits. Though the prescaler's divide ratio is fixed, it is randomized to prevent locking on a particular bit in a bit stream with a pattern length that is a multiple of eight. Signals fed to the **PRESCALE** connector are AC coupled and can be up to 10 GHz.

You can set the trigger mode to auto mode, which will produce an internal trigger in the absence of other trigger events on the trigger signal.

*\*Option 10 instruments do not have the prescaler installed.*

When you use conditional acquire with an external trigger source, the CSA 803 may appear to lock up. The instrument is waiting for a trigger event. To restore operation, supply a triggering signal to one of the trigger inputs.

## Triggering

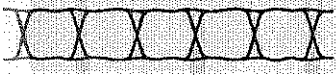

Use the trigger icon ( $\overline{\tau}$ ) to assign the knobs to set the trigger level.

You can assign the knobs to set the trigger level of the selected trace by touching the  $\overline{\tau}$  icon to the left of each graticule. Use the Trigger major menu to access all other trigger controls. The selectors in this menu are:

- **Source**—displays a pop-up menu that lets you select the signal that the CSA 803 monitors for the trigger event. The **External Direct** source is the **DIRECT** connector on the CSA 803 front panel. The **Internal Clock** source is synchronized with the **CALIBRATOR** output on the CSA 803 front panel. The **External Prescaler** source is the **PRESCALE** connector on the CSA 803 front panel. (**External Prescaler** is dimmed if the prescaler option is not installed.) The **Channel** source is a sampling head channel. This option is displayed only when at least one of the sampling heads installed in the system has trigger source capability. **Channel Select** provides a keypad for selecting channels with trigger source capability from the available channels. Channels that do not exist or do not have trigger source capabilities are not displayed.



## Triggering



Trigger Source					
			External Direct		
			Internal Clock		
			External Prescaler		
Exit					
Source	Level			Main Size	
External Prescaler				200ps/div	
				Main Pos	
				58.8198ns	
Mode	Slope			Remove/ClrPan/	
Normal				Trace 1	Zoom
				M1	Off
				Main	

### The Trigger Major Menu and Source Pop-up Menu

- **Level**— assigns the knobs to set the trigger level. Touching this selector is the same as touching the  $\nabla$  icon to the left of the graticule.
- **Mode**— selects between **Normal** mode and **Auto** mode. Auto mode supplies unsynchronized trigger events in the absence of trigger events on the trigger signal.
- **Slope**— selects between + (a rising slope trigger event) and - (a falling slope trigger event).

*Triggering*



# Vectored Traces



Vectored traces is a display mode that enhances the appearance of displayed traces by eliminating any gaps or discontinuities.

The trace display area is 512 pixels (dots) wide. When a trace with a record length of 512 samples is displayed, each sample has its own unique horizontal position on the display. When traces with record lengths longer than 512 samples are displayed, two or more samples must share the same horizontal location. For a trace of 5120 samples, each horizontal place shows the results of ten samples.

When more than one sample shares the same horizontal location, the resulting display is always a series of vertical lines, called columns, that extend from the top sample to the bottom sample.

The CSA 803 normally does not extend the columns to “touch” adjacent columns, so that gaps are shown in the trace. You can turn on trace vectoring so that intermediate data is assumed for display purposes and columns are extended to touch adjacent columns.

Trace vectoring makes the biggest difference in the appearance of a trace with 512 samples. As the record length of a trace increases, the visual enhancement of trace vectoring becomes less evident.

When you display a 512-sample trace, with trace vectoring turned off, the individual samples of the trace show as dots. When you display a trace of more than 512 samples, you can use horizontal magnification to achieve the same effect by displaying any 512-sample portion of the trace. For information about horizontal magnification, see Pan/Zoom on page 137.

## Vectored Traces

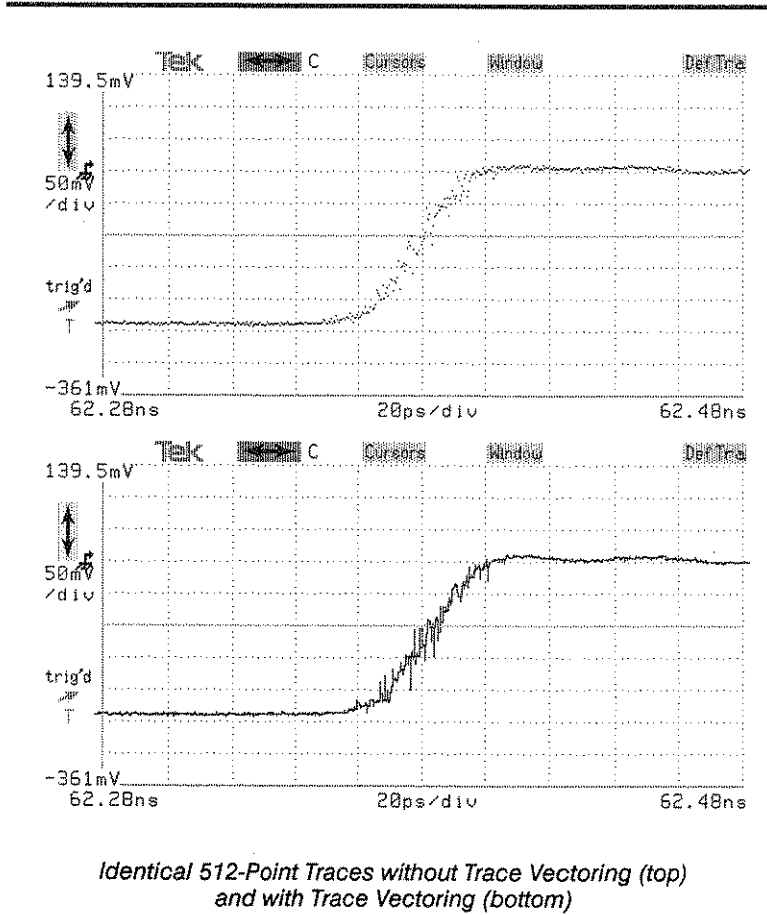
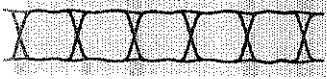

You turn trace vectoring on or off using the **Instrument Options** pop-up menu in the **Utility1** major menu. Touch the **Vectored Trace** selector to set it to **Off** or **On**.

Trace vectoring can also be turned on or off in the **Persist/Histograms** pop-up menu in the **Display Modes** major menu.

Vectored Traces



Vectored Trace Selector

Instrument Options					
Autoset Options					
Vertical Autoset	Horizontal Autoset	Trigger Autoset	Enable	All	
On	On	On			
Main Record Autoset Mode			Undo Last Autoset		
Period Mode	Edge Mode				
Display Intensity	Audio Feedback	Vectored Trace	Trace Scaling		
60%	On	On	Optional		
Hours	Minutes	Seconds	Time: 10:43:12		
10	43	12	Date: 16-APR-90		
			Uptime: 107.8hrs		
			Powerups: 118 times		
Month	Day	Year			
APR	15	90			
Exit					
GPIB / RS232C	Identify	Color	Hardcopy	Main Size	
			Bitmap Screen	5as/div	
				Main Pos	
				79.84304ns	
Initialize Instrument	Labeling	Page to	Remove/Cl	Pan/	Zoom
Options			Trace 1		
10:43:12	Off	Enhanced Accuracy	M1		Off
16-APR-90			Main		

The Instrument Options Pop-up Menu

*Vectored Traces*

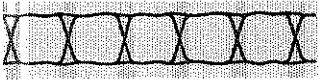

# Vertical Controls

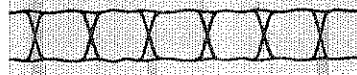

The vertical controls let you set the vertical size and placement of your traces. Touch the vertical icon (↕) to access these controls.

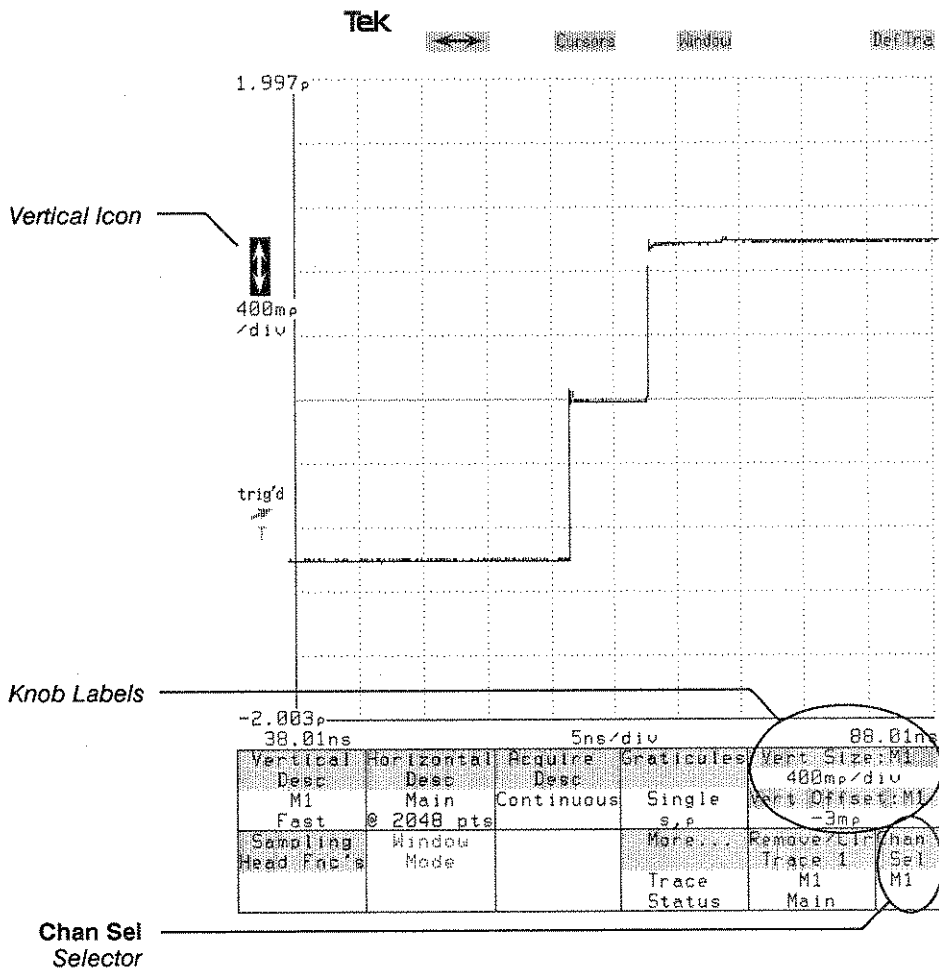

Vertical Controls



## Setting Vertical Size and Offset

Touch a knob label to display the keypad pop-up menu. This lets you set vertical size and offset numerically, or quickly set them to maximum or minimum limits. It also lets you set the knob resolution.

You can change the vertical magnification, or *size*, of a trace. You can also move the trace up or down on the display. This is called adjusting the vertical *offset*. To do either, touch the vertical ( $\updownarrow$ ) icon; this assigns the knobs to adjust the vertical size (top knob) and offset (bottom knob) of a channel of the selected trace.

If you want to change the size or offset of a different trace, touch the desired trace to select it. Then use the knobs to adjust vertical size and offset.

## Adjusting Channels and Adjusting Traces

When you adjust the vertical size or offset of a trace acquired in Fast mode, you are adjusting the size or offset of one of the channels that is in the trace expression. If the trace you are adjusting has the trace expression **M1 + M2**, you can adjust the vertical size of only one channel at a time. This has the following side effects:

- Changing the channel size or offset for this trace changes the channel size or offset for all the other traces that display that channel.
- If the trace you are adjusting has more than one channel in its trace expression, changing the vertical size of one channel does not change the size of the other channels. If the vertical scale factors of all the channels in a trace do not match, the vertical size of the trace is undefined.

For example, in the case of the trace **M1 + M2**, if M1 has a vertical size of 50 mV/div and M2 has a vertical size of 100 mV/div, the trace will have undefined vertical units.

You can select which channel of the trace you want to adjust with the knobs. Whenever the  $\updownarrow$  icon is highlighted, the lower right corner of the display shows the **Chan Sel** selector. This selector always shows which channel the knobs are set to adjust. You can touch this selector until it shows the channel you want to adjust with the knobs.





### Adjusting High Precision Traces

High precision traces use floating-point arithmetic in their calculation. When the selected trace is a high precision trace, you will see **High Prec** in the bottom line of the **Vertical Desc** selector in the **Waveform** major menu.

You can adjust the vertical size and offset of high precision traces, without adjusting a channel.

When you adjust the vertical controls of a high precision trace, the **Chan Sel** selector at the lower right of the display can be used to specify the individual channel to adjust, and to specify the **Calcd Tra**, or calculated trace. When you specify that you want to adjust the calculated trace, the knobs adjust the size and offset of the trace without changing the vertical size and offset of other traces displaying that channel.

### Trace Separation

When you adjust the vertical size and offset of a trace on a window time base, the **Chan Sel** selector at the lower right of the display can be used to specify the individual channel to adjust, and to specify **Trace Sep**, or trace separation. This vertical offset control lets you move a window trace up or down, to visually separate it from other window traces or the main time base trace.

See Trace Scaling on page 244 for a description of high precision traces.

*Vertical Controls*



# Windows



A window trace is a trace that represents a portion of another trace that is magnified horizontally. A window trace is sampled separately from the main trace it is magnifying.

Windows are created by touching the **Window** icon above the graticule. When you touch the **Window** icon, the CSA 803 creates a second graticule to show the window trace. The portion of the main trace that is windowed is highlighted. The display below is the result of touching the **Window** icon when the top trace was displayed alone on a single-graticule display.

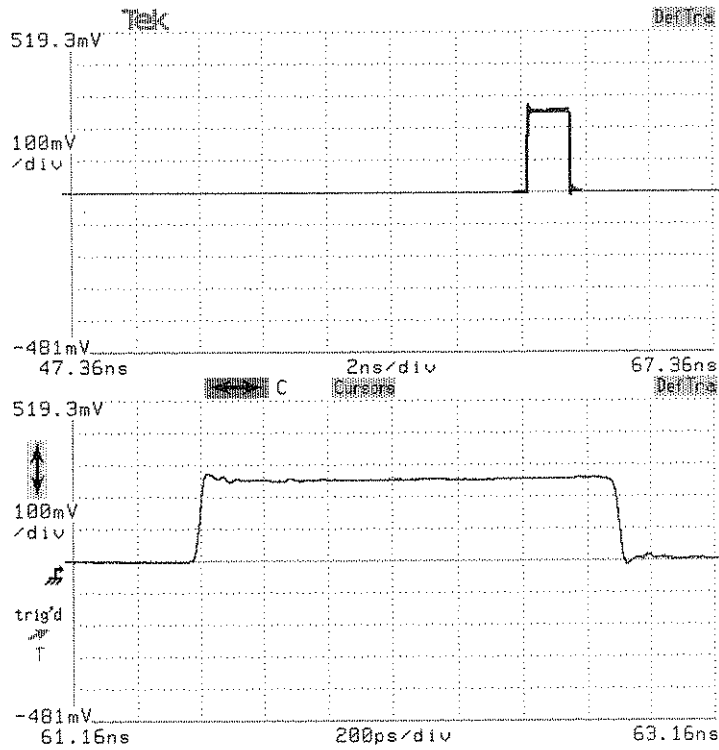
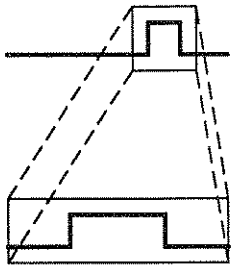

A Window Trace Display

## Windows

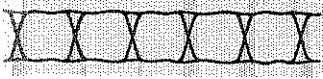

The window trace has the same trace expression as the main trace. The difference between the two is the time base that each uses; the main trace uses the main time base, while the window trace uses a window time base. The **Horizontal Desc** selector in the **Waveform** major menu always shows the time base of the selected trace.

A window trace is independent of the main trace. Once a window trace is established, you can remove the main trace or move the window trace from graticule to graticule.

You can create more than one window trace from a single main trace. You cannot create a window trace of a window trace.

If you remove all windows, the display automatically returns to a single graticule display.

### Changing Window Size and Position

All window traces are the same horizontal size. If you change horizontal size on one window trace, you change horizontal size on all window traces.

You can change the size and position of a window trace just as you do with any main trace. Touch the  $\leftrightarrow$  or  $\updownarrow$  icons to assign the knobs to horizontal size and position or vertical size and offset. Complete information about horizontal size and position is on page 135, and vertical size and offset is on page 255.

All main traces share the same time base, and so all have the same horizontal size and position. Each window trace has its own time base, and so each can have a different horizontal position. However, all window time bases have the same horizontal size.

As you change the horizontal size or position of a window trace, the highlighted portion of the main trace changes size and position. This allows you to always see the portion of the main trace that the window trace is magnifying. (In display modes other than Normal, the main trace will not show a highlighted region.)

### Trace Separation

When you use the  $\updownarrow$  icon to offset any trace, the **Chan Sel** selector in the lower right corner of the screen can be used to select which channel you want to size or offset. Touch the **Chan Sel** selector until it shows the channel you want.



When you use the  $\updownarrow$  icon to offset a window trace, the **Chan Sel** selector can be used to select **Trace Sep**. When you set the **Chan Sel** selector to **Trace Sep**, the vertical offset knob moves the selected trace up or down without moving other traces that show the same channels as the selected trace. This lets you visually separate the selected window trace from other window or main traces that may overlap it.

### Positioning Window Traces Automatically

The limitations on window complexity when automatic positioning is used are identical to the complexity limitations on hardware measurements.

The CSA 803 can position your window traces automatically based on an electrical event that occurs on the main trace. This triggers the window trace in a manner similar to triggering of the main trace. Automatic window positioning can only be used on traces that do not use arithmetic operators or trace functions.

You initiate and control automatic window positioning using the **Window Mode** pop-up menu in the Waveform major menu. Touch the **Position Mode** selector in this pop-up menu to set the positioning mode to **Automatic** or to **Manual**.

## Windows



Window Mode					
Position Mode					
Manual					
Tracking		Locate Window			
On					
Level Mode		Level			
Relative		50%			
Transition Number		Slope			
1		+			
Filtering		Top / Base Method			
3		IEEE			
Exit					
Vertical Desc	Horizontal Desc	Acquire Desc	Lower Graticule	Window Size	
M1	Window @ 512 pts	Continuous	Dual e.V	200ps/div	
Sampling Head Func's	Window Mode		More...	Window Pos	
	Manual		Trace Status	39.34088ns	
				Remove/CI	Pan/Zoom
				Trace 3	M1 Off
				M1	Window

### The Window Mode Pop-up Menu

The electrical event that triggers the automatic window position is the point at which the main trace passes through a specified voltage *level* in the specified direction (the *slope*) the specified number of times (the *transition number*).

You can specify the voltage level in volts (absolute) or as a percentage of the baseline-to-topline voltage of the trace (relative).

The selectors of the **Window Mode** pop-up menu let you control the window positioning in the following ways:



- **Position Mode**— can be set to **Manual** (you position the window with the knobs) or **Automatic** (the CSA 803 positions the window based on an electrical event on the main trace).

Automatic window positioning has a resolution equal to one Main record sample interval. If the Main record sample interval is large compared to the window size, the position may appear to “jump.” In most cases, this will not affect the accuracy of measurements, because the CSA 803 automatically compensates for the change in position.

- **Transition Number**— assigns a knob to specify the number of times the electrical event must occur before the window trace is positioned. This affects only an automatic window with tracking on, or an automatic window when locate window is performed.
- **Slope**— selects between + (a rising slope transition event) or - (a falling slope transition event).
- **Filtering**— assigns a knob to set the number of successive trace samples that must cross the transition level before the transition is counted as valid. Noisy signals will be affected most by filtering. This affects only an automatic window with tracking on, or an automatic window when locate window is performed.
- **Level Mode**— selects between **Absolute** (you specify the transition level in terms of volts) or **Relative** (you specify the transition level in terms of percentage of baseline-to-topline height of the trace).
- **Level**— assigns a knob to set the transition voltage level in the mode determined by the **Level Mode** selector.
- **Tracking**— This affects only an automatic window with tracking on, or an automatic window when locate window is performed. Three types of tracking are available:

## Windows



**Relative tracking**—Baseline and topline are recalculated and used to calculate an absolute level. Window position is then found using that absolute level.

**Absolute tracking**—Absolute level used to find window position.

**No tracking (either)**—No position change until **Locate Window** is selected. A Relative tracking or Absolute tracking measurement is performed once each time **Locate Window** is selected.

- **Locate Window**—meaningful only when **Position Mode** is **Automatic** and **Tracking** is **Off**, tells the CSA 803 to position the window trace.
- **Top/Base Method**—allows you to select the method of determining the topline and baseline. You can choose between the standard IEEE method (histograms) or an alternate method that smooths and differentiates the waveform data before calculating topline and baseline. The alternate method works better than the IEEE method for ramps, triangular or irregular square waves.

The **Top/Base Method** parameter affects all window traces. It also affects how automatic measurements are performed on all traces. You can also change this parameter from the **Measurements** pop-up menu in the **Measure** major menu.



# XY Traces



Most traces show a signal voltage (the vertical axis) as it varies over time (the horizontal axis). You can display a trace that shows how two traces compare with each other, independent of time. Such an XY trace shows the signal voltage of one trace on one axis against the signal voltage of the other trace on the other axis.

You can have only one XY trace. You cannot take measurements of XY traces.

This XY trace is a constellation diagram. Constellation diagrams are discussed on page 57.

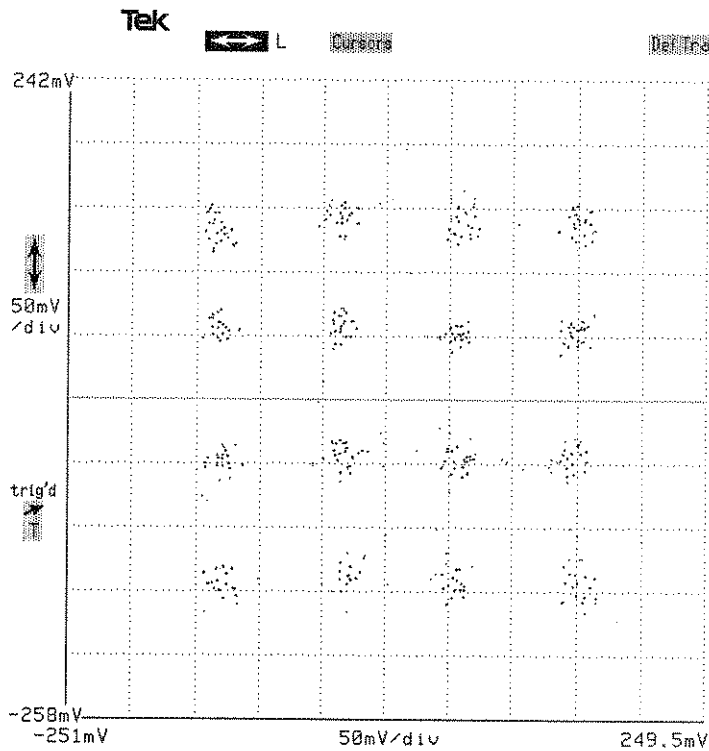

An XY Trace

When an XY trace is displayed, the axis units cannot be changed from volts on either axis.

XY Traces



Horizontal Description

Acquiring Timebase: Main  
 Main Sample Interval: 2ps/point  
 Window Sample Interval: 200fs/point  
 Main Record Length: 512 points      Window Record Length: 512 points

Horizontal Reference Point

Left       Center       Right

---

XY Display Mode: X=Acquired Trace

Trace 1 M1 Main	Normal YT
-----------------------	--------------

---

XY Display Mode: X=Stored Trace

Exit

Vertical Desc	Horizontal Desc	Acquire Desc	Graticules	Main Size	Pan/Zoom
M1 Fast	Main @ 512 pts	Continuous	Single s,V	100ps/div Main Pgs 37.lns	Remove/Clr Trace 1 Zoom Off
Sampling Head Func's	Window Mode		More... Trace Status	Main	

XY Trace Section

**The Horizontal Desc Pop-up Menu**

You initiate and control XY traces using the **Horizontal Desc** pop-up menu in the Waveform major menu. Two sections of the menu are titled **XY Display Mode**, one for displayed traces and one for stored traces.

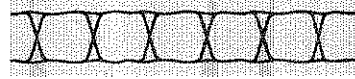

The sequence to follow when creating XY traces is:

- Step 1: Define a trace that shows the information you want on the X axis (the horizontal axis). This trace may be a displayed trace or a stored trace.
- Step 2: Define and display a trace with the information you want on the Y axis (the vertical axis).
- Step 3: Select the trace that displays the Y-axis information.
- Step 4: Press the **WAVEFORM** major menu button, and touch the **Horizontal Desc** selector to display the pop-up menu.
- Step 5: Touch the selector in the **Horizontal Desc** pop-up menu that represents the trace showing the X-axis information. If the X-axis trace is a displayed trace, it will appear in the section titled **XY Display Mode: X=Acquired Trace**. If the X-axis trace is a stored trace, it will appear in the section titled **XY Display Mode: X=Stored Trace**.

When you touch the X-axis trace selector in the **Horizontal Desc** pop-up menu, the trace is immediately converted into an XY trace on the display.

If the trace defining the X-axis information is a displayed trace, this process will leave two traces on the display; the XY trace and the X-axis information trace. Once the XY trace is established, you can remove the trace displaying the X-axis information.

To restore an XY trace to normal YT mode, select the XY trace and touch the **Normal YT** selector in the **Horizontal Desc** pop-up menu.

Constellation diagrams are a common application of XY traces. See Constellation Diagrams, on page 57, for more details.

*XY Traces*

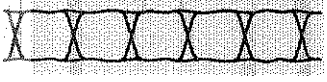

# Appendix A: Accessories

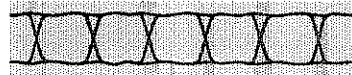

## Standard Accessories

The CSA 803 instrument package includes the following standard accessories:

- *CSA 803 Tutorial*, Tektronix part number 070-7718-01.
- *CSA 803 User Reference* (this manual).
- *CSA 803 and 11801A Programmer Reference*, Tektronix part number 070-7738-01.
- *CSA 803 and 11801A Command Reference*, Tektronix part number 070-7720-01.
- *CSA 803 Service Reference*, Tektronix part number 070-7721-01.
- Power Cord (North American 120 V), Tektronix part number 161-0066-00.
- Two 8 $\frac{1}{2}$ -inch SMA interconnecting cables, Tektronix part number 174-1120-00.
- One-foot SMA interconnecting cable, Tektronix part number 174-1364-00.
- Antistatic wrist strap, Tektronix part number 006-3415-04

To obtain replacements, refer to a Tektronix products catalog or contact your local Tektronix field representative.

## Optional Accessories

The following optional accessories have been selected from our catalog specifically for the CSA 803. For detailed information and prices, see a Tektronix products catalog or contact your local Tektronix field representative.

- Option 1R Rack Mount, converts the CSA 803 for rack mounting.

*Appendix A: Accessories*



- Option 10, Delete Prescaler, deletes the Prescaler trigger input.
- GPIB cable, two meter, Tektronix part number 012-0991-00.
- RS-232-C cable, ten foot, Tektronix part number 012-0911-00.
- Ten-foot Centronics printer cable, Tektronix part number 012-0555-00.
- Sampling head extender cable, one-meter , Tektronix part number 012-1220-00.
- Sampling head extender cable, two-meter, Tektronix part number 012-1221-00.
- Sampling head panel, blank, Tektronix part number 200-3395-00.
- Acquisition extender, Tektronix part number 067-1323-00.
- Acquisition System extender, Tektronix part number 067-1324-00.
- Calibration pulser, Tektronix part number 067-1338-00.
- Hardcopy unit: Epson-compatible Dot Matrix Printer, Tektronix 4697.
- Tektronix SCOPE-MOBILE cart, Model 205.
- Calibration Head, Tektronix part number 067-1413-00.



## Power Cord Options

The following power cords are available for the CSA 803.

- Option A1 Universal European 220 V/6A, 50 Hz, Tektronix part number 161-0066-09.
- Option A2 United Kingdom 240 V/6A, 50 Hz, Tektronix part number 161-0066-10.
- Option A3 Australian, 240V/6A, 50 Hz, Tektronix part number 161-0066-11.
- Option A4 North American 250 V/10A, 60 Hz, Tektronix part number 161-0066-12.
- Option A5 Switzerland, 240 V/6A, 50 Hz, Tektronix part number 161-0154-00 .

*Appendix A: Accessories*





# Appendix B: Specifications



The electrical characteristics apply to the following conditions:

- The instrument has had a 20-minute warm-up period.
- The instrument is operating in an environment that meets the limits described in Environmental Specifications in this section.

### *Vertical System Specifications*

Characteristic	Specification
Input sources	
Mainframe	2 sampling heads, 4 channels
Bandwidth	Dependent on sampling head
Risetime	Dependent on sampling head
Amplifier gain accuracy	$\pm 1\%$ of full-scale range
Vertical resolution	
Trace data	8 bits
Hardware measurements	14 bits
Input sensitivity	2 mV/div to 255 mV/div in 1 mV/div steps
Offset accuracy	$\pm 2$ mV
Offset range	$\pm 2$ V
Offset resolution	0.25 mV
Measurement level accuracy	$\pm 1$ mV
Vertical acquisition resolution	
Single graticule	25 points/div
Dual graticule	25 points/div
Vertical display resolution	
Single graticule	50 pixels/div
Dual graticule	25 pixels/div

Appendix B: Specifications



*Time Base Specifications*

Characteristic	Specification
Internal reference clock	Crystal-controlled oscillator, voltage-controlled oscillator for timebase
Sample rate	200 kHz maximum
Record length	User selectable, 512, 1024, 2048, 4096, or 5120 points.
Sweep rate resolution	1-2-5 steps or 1 ps/div increments
Record duration	10 ps to 50 ms
Maximum sweep rate	
512-point record	1 ps/div
1024-point record	1 ps/div
2048-point record	2 ps/div
4096-point record	5 ps/div
5120-point record	5 ps/div
Time interval measurement accuracy	10 ps or $\pm 0.01\%$ of selected delay



*Input and Output Specifications*

<b>Characteristic</b>	<b>Specification</b>
Touch panel	Infrared beam touchable array, 22 rows of 11 columns
Knobs	2 general-purpose knobs, set by user to desired function
Calibrator output pulse	
Voltage	500 mV open circuit or 250 mV into 50 $\Omega$
Frequency	Approximately 100 kHz (50 kHz if divide-by-two mode selected)
Risetime	Approximately 250 ps into 50 $\Omega$
Internal clock output	Synchronized with TDR and calibrator output
Voltage	Positive pulse from 0 to 2.0 V
Impedance	from 50 $\Omega$
Repetition rate	Approximately 100 kHz (50 kHz if divide-by-two mode selected)



*Trigger Specifications*

Characteristic	Specification
Trigger source	External Direct, Internal Clock, or External Prescaler
Trigger mode	
Auto	Free runs after 50 ms timeout
Normal	Acquisition only after trigger event
Maximum trigger input	
Direct	-1.5 V to +1.5 V
Prescaler	-2.5 V to +2.5 V
Trigger level	-1 V to +1 V
Trigger level resolution	1 mV
Trigger accuracy	10% of full scale
Trigger sensitivity	
Direct - DC coupled	40 mV peak-peak from DC to 200 MHz, increasing to 150 mV at 800 MHz, increasing to 250 mV at 2.5 GHz
Prescaler - AC coupled	600 mV typical peak-peak from 2 GHz to 8 GHz. Less than 2 V from 8 GHz to 10 GHz
Main and window position	Minimum 40 ns pre-trigger required
Initial window delay	40 ns to 50 ms in 1-ps steps
Strobe skew adjustment	$\pm 1.5$ ns

Appendix B: Specifications



*Display Specifications*

Characteristic	Specification
CRT	8 1/2 inch diagonal, color, magnetic deflection. Vertical raster orientation. Nominal screen size: 6.087 inches vertical by 4.496 inches horizontal
Character display	44 lines of 55 characters
Character height	0.10 in (upper case)
Character cell	16 pixel vertical by 10 pixel horizontal

*AC Line Power Specifications*

Characteristic	Specification
Voltage ranges	90 to 132 V rms or 180 to 250 V rms Voltage ranges apply to trace distortion, which reduces peak line voltage 5%
Frequency	48 Hz to 440 Hz
Power	320 W
Current	4.6 A rms at 50 Hz, 90 V line with 5% clipping
Fuse	6A, 250 V normal blow

Appendix B: Specifications

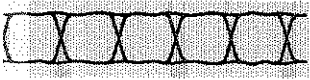

*Environmental Specifications*

<b>Characteristic</b>	<b>Specification</b>
Temperature	Meets MIL-T-28800D, Type III, Class 5, tested per paragraphs 4.5.5.1.3 and 4.5.5.1.4
Operating	0°C to 50°C
Non-operating	-40°C to 75°C
Humidity	Up to 95% relative humidity, at up to 50°C
Altitude	Meets MIL-T-2800D, Type III, Class 5
Operating	Up to 4.5km (15,000 ft)
Non-operating	Up to 15km (50,000 ft)
Vibration	Operating, sampling heads not installed: meets MIL-T-2800D, Type III, Class 5, section 4.5.5.3.1
Shock	Non-operating, sampling heads not installed: meets Mil-T-2800D, Type III, Class 5, section 4.5.5.3.1
Bench handling	Operating: meets MIL-T-2800D, Type III, Class 5, section 4.5.5.3
Packaged product vibration and bounce	Packaged product, sampling heads not installed: meets ASTM D999-75, Method A, para 3.1 (NSTA Proj. 1A-B-1)
Drop of packaged product	Packaged product, sampling heads not installed: meets ASTM D775-61, Method 1, para 5 (NSTA Proj. 1A-B-2).
Electrostatic immunity	No disruption or degradation of performance: up to 15 kV. No damage to instrument: up to 20 kV

# Appendix C: Safety

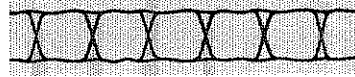

## Safety

### Terms in Manuals

*CAUTION* statements identify conditions or practices that could result in damage to the equipment or other property.

*WARNING* statements identify conditions or practices that could result in personal injury or loss of life.

### Terms on Equipment

*CAUTION* indicates a personal injury hazard not immediately accessible as one reads the marking, or a hazard to property including the equipment itself.

*DANGER* indicates a personal injury hazard immediately accessible as one reads the marking.

### Symbols in Manuals



*Static Sensitive Devices*

### Symbols on Equipment



**DANGER**  
*High Voltage*



**Protective**  
*ground (earth)*  
*terminal*



**ATTENTION**  
*Refer to*  
*manual*

This safety information applies to all operators and service personnel.

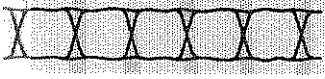

### **Power Source**

This product is intended to operate from a power source that will not apply more than 250 V rms between the supply conductors or between either supply conductor and ground.

### **Grounding the Instrument**

The CSA 803 is grounded through the power cord. To avoid electric shock, plug the power cord into a properly wired receptacle where earth ground has been verified by a qualified service person. Do this before making connections to the input or output terminals of the instrument.

Without the protective ground, all parts of the instrument are shock hazards. This includes knobs and controls that may appear to be insulators.

### **Use the Proper Fuse**

Using an improper fuse can create a fire hazard. Always use fuses that exactly meet the specifications in the CSA 803 parts list. Match fuse type, voltage rating, and current rating.

### **Do Not Operate in Explosive Atmospheres**

The CSA 803 provides no explosion protection from static discharges or arcing components. Do not operate the instrument in an atmosphere of explosive gases.

### **Do Not Remove Covers or Panels**

To avoid personal injury, do not operate this instrument without the panels or covers.

#### **CAUTION**

Operating the instrument without the covers in place may cause overheating and harm the instrument.





## Electrical Connections

**CAUTION**  
Do not overtighten SMA-compatible connectors.

### SMA-Compatible Connectors

You must attach cables to SMA-compatible connectors carefully to prevent damage to the cable or the instrument connector.

When attaching a cable to or removing a cable from an SMA-compatible connector, do not turn the cable, turn only the nut. Align the two connectors carefully and engage the connector nut over the exposed threads on the other connector. Use only finger pressure to make this initial connection. Then use a torque wrench *only* to tighten the connection to the range of 7–10 lb-in (79–112 N-cm).

There are two types of SMA-compatible connectors on the CSA 803:

- Standard SMA connectors with plastic insulating material between the center lead and the outer shield. An example is the trigger **INPUT** connector.
- High-precision APC 3.5 connectors, which have air insulation between the center lead and outer shield. An example is the **CALIBRATOR** output connector.

The APC 3.5 connectors are of closer mechanical tolerance than the standard SMA connector. Attaching a worn or damaged SMA cable to an APC 3.5 connector may damage the APC 3.5 connector.

### Electrostatic Discharge

The input diodes used in the sampling heads are susceptible to damage from overdrive signal or DC voltages, and from electrostatic discharge. Never apply a voltage outside the range printed on the front of the sampling head. Operate the instrument only in a static-controlled environment.



**CAUTION**  
Applying a voltage outside the range printed on the sampling head can result in damage. Static electricity is also a hazard.



### Packaging for Shipment

If you ship the CSA 803, pack it in the original shipping carton and packing material. If the original packing material is unavailable, package the instrument as follows:

- Step 1: Obtain a corrugated cardboard shipping carton with inside dimensions at least 15 cm (6 in) taller, wider, and deeper than the instrument. The shipping carton must be constructed of cardboard with 375 pound test strength.
- Step 2: If you are shipping the CSA 803 to a Tektronix field office for repair, attach a tag to the instrument showing the instrument owner and address, the name of the person to contact about the instrument, the instrument type, and the serial number.
- Step 3: Wrap the instrument with polyethelene sheeting or equivalent material to protect the finish.
- Step 4: Cushion the instrument on all sides by tightly packing dunnage or urethane foam between the carton and the instrument, allowing 7.5 cm (3 in) on each side.
- Step 5: Seal the carton with shipping tape or an industrial stapler.

# Appendix D: Algorithms



Digitized traces are a sequence of samples stored as 16-bit signed integers. The samples are numbered from 0 through the record length less one; a 512-point record numbers samples from 0 through 511.

Three sample values represent invalid data points.

- The value  $-32,768$  (hexadecimal 8000) represents *null*, an unacquired data point. A trace that is defined but has never been acquired contains null values. Clearing a trace fills it with null values. A trace is either completely filled with null values or it contains no null values; null values and non-null values cannot coexist in the same trace record.
- The value  $-32,767$  (hexadecimal 8001) represents a data value below the dynamic range of the digitizer. This is called *underrange*. Underrange values do not appear on a displayed trace.
- The value  $+32,767$  (hexadecimal 7FFF) represents a data value above the dynamic range of the digitizer. This is called *overrange*. Overrange values do not appear on a displayed trace.

When a trace function encounters one of these three data values, it passes the invalid data value as its output. When a measurement encounters one of these three data values, the measurement is noted as an error. There are exceptions to these rules, as noted below. All trace functions assume that the trace record contains data other than these three values, unless specifically noted.

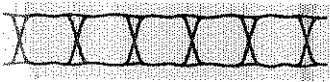

### Trace Functions

#### Absolute Value

$$Abs(n) = W(n)$$

for  $W(n) \geq 0$

$$Abs(n) = -W(n)$$

for  $W(n) < 0$

where:

$n$  = index into the record of data points  
 $W(n)$  = input sampled data point

#### Average

$$Avg_p(n) = W(n)$$

for  $p = 1$

$$Avg_p(n) = Avg_{p-1}(n) + \frac{[W(n) - Avg_{p-1}(n)]}{2^{INT(\log_2(p)/\log_e 2)}}$$

for  $1 < p < P$

$$Avg_p(n) = Avg_{p-1}(n) + \frac{[W(n) - Avg_{p-1}(n)]}{P}$$

for  $p \geq P$

where:

$n$  = index into record of data points  
 $W(n)$  = input sampled data point  
 $p$  = record number  
 $P$  = total number of records specified for average  
 $INT$  = integer part of

**Differentiate**

$$Diff(n) = [W(1) - W(0)]/T$$

for  $n = 0$

$$Diff(n) = [W(n+1) - W(n-1)]/(2T)$$

for  $1 \leq n \leq (R-1)$

$$Diff(R-1) = [W(R-1) - W(R-2)]/T$$

for  $n = R-1$

where:

$n$  = index into the record of data points

$W(n)$  = input sampled data point

$T$  = time interval between successive samples

$R$  = record length

**Envelope**

$$Env_p(n) = W(n)$$

for  $p = 1$

$$Env_p(n) = \text{Minimum of } [Env_{p-1}(n), W(n), W(n+1)]$$

for  $p > 1$  and  $n$  even(2, 4, 6, ...,  $R-1$ )

$$Env_p(n) = \text{Maximum of } [Env_{p-1}(n), W(n-1), W(n)]$$

for  $p > 1$  and  $n$  odd(1, 3, 5, ...,  $R-2$ )

where:

$n$  = index into record of data points

$W(n)$  = input sampled data point

$p$  = record number

$R$  = record length

$P$ , the total number of records specified for enveloping, is used only to determine completion for conditional acquisition, when acquisition is stopped on envelope complete.



**Exponential**

$$Exp(n) = e^{W(n)}$$

where:

$n$  = index into record of data points

$W(n)$  = input sampled data point

This function is implemented by the 80287 math coprocessor and supporting routines.

**Filter**

$$Filter(n) = Smooth(Smooth(n))$$

where:

$$Smooth(n) = (1/s) \left[ \sum_{m=0}^{n+h} W(m) + (h-n) \times W(0) \right]$$

for  $n < h$

$$Smooth(n) = (1/s) \left[ \sum_{m=n-h}^{n+h} W(m) \right]$$

for  $h \leq n \leq R-1-h$

$$Smooth(n) = (1/s) \left[ \sum_{m=n-h}^{R-1} W(m) + (M-1-n) \times W(M-1) \right]$$

for  $n > M-1-h$



where:

$n$  = index into record of data points

$W(n)$  = input sampled data point

$s$  = smoothing interval = Round ( $sf$ )

$$sf = \frac{\text{risetime}}{(\text{time per dot}) \times 1.10557}$$

$\text{risetime}$  = the second argument to Filter

where:

$\text{risetime} > 10 \text{ ps}$  and  $< 50 \text{ ms}$

$h$  = half interval:  $(s - 1)/2$  rounded up

$R$  = record length in points

The smoothed trace is derived by computing the average value of the corresponding point of the original trace and some number of points of the original trace on either side of the corresponding point. The number of points on either side is derived from the smoothing interval, the second argument of the Smooth function. Near the ends of the trace, nonexistent points beyond the ends of the trace are required for averaging. The nonexistent points are assumed to be the value of the corresponding end points. This method of extending the trace is arbitrary, so the results within a smoothing interval of the ends of the trace must be interpreted accordingly.

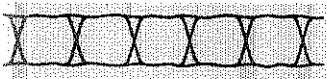

### Integrate

$$Intg(n) = 0$$

for  $n = 0$

$$Intg(n) = \left[ 1/2W(0) + \sum_{m=1}^{n-1} W(m) + 1/2W(n) \right] \times T$$

for  $1 \leq n \leq R$

where:

$n$  = index into record of data points

$W(n)$  = input sampled data point

$T$  = time interval between successive samples

$R$  = record length in points

### Logarithm

$$Log(n) = \log_{10} W(n)$$

where:

$n$  = index into record of data points

$W(n)$  = input sampled data point

This function is implemented by the 80287 math coprocessor and supporting routines.

### Natural Logarithm

$$Ln(n) = \log_e W(n)$$

where:

$n$  = index into record of data points

$W(n)$  = input sampled data point

This function is implemented by the 80287 math coprocessor and supporting routines.





### Rho

Rho is normally calculated to be between +1 and -1 by:

For trace M1:

$$\rho = \frac{\text{volts}}{(RA \times \text{pol})} - \rho_{\text{pos}}$$

$$\rho_{\text{pos}} = \frac{(\text{Ref Voltage})}{(RA \times \text{pol})} + 1 + \rho_{\text{zero}}$$

where:

*RA* = Reference Amplitude (normally 250 mV); where the reference amplitude is equivalent to the change in volts that corresponds to a change of 1 in rho

*pol* = +1 if M1 has positive polarity, -1 if M1 has negative polarity

*volts* = the voltage at any point in M1

*Ref Voltage* = the voltage of M1 measured as early in time as possible. Baseline correction keeps remeasuring the reference voltage, and will force a recalculation of rho<sub>pos</sub> any time it changes by more than a few millivolts

*rhozero* = 0 by default. The cursor feature **Set Zero Rho** sets this value.

For trace "M1-M2," where M1 has positive polarity and M2 has negative polarity:

$$\rho = \frac{\text{volts}}{(RA \times r_f)} - \rho_{\text{pos}}$$

$$\rho_{\text{pos}} = \frac{(\text{RhoPos of } M1)}{r_f} + \frac{(\text{RhoPos of } M2)}{r_f} + \rho_{\text{zero}}$$

$$\text{RhoPos of } M_j = \frac{(\text{Ref Voltage } M_j)}{(RA \times (\text{pol of } M_j))} + 1$$

Appendix D: Algorithms

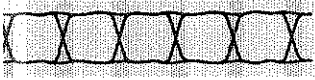

where:

*volts* = voltage at any point in M1-M2

*rf* = rhofactor; 2 for this trace

*Mj* = M1 or M2

For trace "M1 - STO1," where STO1 was created from M1:

$$rho = \frac{volts}{(RA \times rf)} - rhopos$$

$$rho = \frac{(RhoPos\ of\ M1)}{rf} - \frac{(RhoPos\ of\ STO1)}{rf} + rhozero$$

$$RhoPos\ of\ M_j = \frac{(Ref\ Voltage\ M_j)}{(RA \times (pol\ of\ M_j))} + 1$$

where:

*RhoPos of STO1* = RhoPos of STO1 at the time STO1 was created

*rf* = rhofactor; 2 for this trace

*Mj* = M1 or M2

For trace " $C_1 \times T_1 + \dots + C_n \times T_n$ :"

$$rho = \frac{volts}{(RA \times rf)} - rhopos$$

$$rhopos = \frac{C_1 \times (pol1) \times (RhoPos\ of\ T_1)}{rf} + \dots +$$

$$\frac{C_n \times (poln) \times (RhoPos\ of\ T_n)}{rf} + rhozero$$



where:

$C_i$  = a numeric constant (for example, 1.0 or 0.5)

$T_j$  = a channel or stored trace

$pol_j$  = +1 or -1 polarity if  $T_j$  is a channel, or  
= rhofactor of a stored trace which equals the rhofactor of  
the live trace when the stored trace was created

$rf$  = rhofactor =  $C_1 \times (pol_1) + \dots + C_n \times (pol_n)$   
however, if this is 0, then:

$$= \frac{ABS(C_1 \times (pol_1)) + \dots + ABS(C_n \times (pol_n))}{2}$$

Trace functions Smooth, Filter, and Avg have no effect on the formulas used for rho.

For trace " $C_0 + C_1 \times T_1 + \dots + C_n \times T_n$ " the rho values produced are the same as if  $C_0$  was 0.

### Signum

$Signum(n) = 1.0$

for  $W(n) > 0$

$Signum(n) = 0$

for  $W(n) = 0$

$Signum(n) = -1$

for  $W(n) < 0$

where:

$n$  = index into record of data points

$W(n)$  = input sampled data point



### Square Root

$$Sqrt(n) = W(n)^{1/2}$$

where:

$n$  = index into record of data points

$W(n)$  = input sampled data point

This function is implemented by the 80287 math coprocessor and supporting routines.

### Smooth

$$Smooth(n) = (1/s) \left[ \sum_{m=0}^{n+h} W(m) + (h-n) \times W(0) \right]$$

for  $n < h$

$$Smooth(n) = (1/s) \left[ \sum_{m=n-h}^{n+h} W(m) \right]$$

for  $h \leq n \leq R-1-h$

$$Smooth(n) = (1/s) \left[ \sum_{m=n-h}^{R-1} W(m) + (M-1-n) \times W(M-1) \right]$$

for  $n > M-1-h$

where:

$n$  = index into record of data points

$W(n)$  = input sampled data point

$s$  = smoothing interval in samples; the second argument

$h$  = half interval:  $(s-1)/2$  rounded up

$R$  = record length in points



The smoothed trace is derived by computing the average value of the corresponding point of the original trace and some number of points of the original trace on either side of the corresponding point. The number of points on either side is derived from the smoothing interval, the second argument of the Smooth function.

Near the ends of the trace, nonexistent points beyond the ends of the trace are required for averaging. The nonexistent points are assumed to be the value of the corresponding end points. This method of extending the trace is arbitrary, so the results within a smoothing interval of the ends of the trace must be interpreted accordingly.

## Software Measurements

Measurements are taken using the measurement parameters. You can directly set many the measurement parameters, or you can specify that some are to be determined automatically by the CSA 803. It is common to have the CSA 803 dynamically measure topline and baseline.

You specify automatic topline and baseline positioning by turning tracking on in the individual measurement pop-up menus. The mesial level, when topline and baseline are automatically positioned by tracking, is calculated:

$$mesial = [(m\%/100) \times (topline - baseline)] + baseline$$

where  $m\%$  is the percentage of topline to baseline height to use for mesial level. Proximal, distal, and reference levels are calculated similarly from percentage levels. These percentage levels are set using the knobs.

When you use tracking, the topline and baseline are determined either from the IEEE histogram method or from an alternate method. The IEEE method of determining topline and baseline, is as follows:

1. Create a histogram of the trace data points. For each possible vertical value, count the number of data points having that value.



2. The largest value that has a non-zero point count is the maximum value.
3. The smallest value that has a non-zero point count is the minimum value.
4. Determine the median value, halfway between the maximum and minimum values.
5. Examine the point counts between the median value and the maximum value, to find the largest point count. If this point count is greater than or equal to twice the second-largest point count, the value associated with the point count is the topline. If the largest point count is not twice the second-largest point count, then the maximum value is used as the topline.
6. Examine the point counts between the median value and the minimum value, to find the largest point count. If this point count is greater than or equal to twice the second-largest point count, the value associated with the point count is the baseline. If the largest point count is not twice the second-largest point count, then the minimum value is used as the baseline.

The Alternate method of determining topline and baseline, is as follows:

1. Smooth the raw waveform data.
2. Differentiate the smoothed waveform data.
3. Smooth the differentiated data.
4. Search the smoothed, differentiated data for the largest negative and positive peaks. The peaks must be equal to at least 30% of the peak-to-peak amplitude to qualify as valid.
5. Determine the 30% value of the largest valid topline and largest valid baseline peak.



6. Search the smoothed, differentiated data for crossings of the -30% and +30% levels, and build a table of these crossings.
7. Using the table built in step 6, qualify the original waveform data into topline, baseline, and ignore points.
8. The topline value is the average of all the points in the topline group.
9. The baseline value is the average of all the points in the baseline group.

### Amplitude

$$\text{Amplitude} = \text{topline} - \text{baseline}$$

### Area+

$$\text{Area+} = \sum_{j=m}^{n-1} \frac{\text{ABS}[W(j+1) - R] + \text{ABS}[w(j) - R]}{2} \times T$$

where:

- $m$  = index of left-most measurement zone sample
- $n$  = index of right-most measurement zone sample
- $W(j)$  = input sampled data point
- $R$  = reference level measurement parameter
- $T$  = time interval between successive samples
- $\text{ABS}$  = the absolute value function



**Area-**

$$Area = \sum_{j=m}^{n-1} \frac{[W(j+1) - R] + [w(j) - R]}{2} \times T$$

where:

- $m$  = index of left-most measurement zone sample
- $n$  = index of right-most measurement zone sample
- $W(j)$  = input sampled data point
- $R$  = reference level measurement parameter
- $T$  = time interval between successive samples

**Cross**

The cross measurement finds the left-most crossing of the reference level of the proper slope that is within the measurement zone. The horizontal position of the crossing point is displayed.

Linear interpolation between vertical points and between time intervals is necessary to determine the crossing time, when the reference level value does not correspond to acquired data.

**Duty Cycle**

1. Calculate the Period of the selected waveform (perform a period measurement).
2. Calculate the pulse width of the selected waveform (perform a width measurement).
3. If the positive portion of the part of the waveform measured for the Period measurement lies between the first two mesial crossings in the measurement zone, then:

$$Duty\ Cycle = \frac{100 \times Width}{Period}$$





If the positive portion of the part of the waveform measured for the Period measurement lies between the second and third mesial crossings in the measurement zone, then:

$$\text{Duty Cycle} = 100 - \frac{100 \times \text{Width}}{\text{Period}}$$

### Energy

$$\text{Energy} = \sum_{j=m}^{n-1} \frac{W(j+1)^2 + w(j)^2}{2} \times T$$

where:

- $m$  = index of left-most measurement zone sample
- $n$  = index of right-most measurement zone sample
- $W(j)$  = input sampled data point
- $T$  = time interval between successive samples

### Extinction Ratio

$$\text{Extinction Ratio} = \frac{\text{topline}}{\text{baseline}}$$



### Fall

1. Find the first point in the measurement zone that is greater than the distal value, searching from left to right.
2. From this point, find the first distal crossing and note the time,  $t_d$ .
3. From the distal crossing, examine points to the right, looking for the proximal crossing  $t_p$ . Update  $t_d$  if subsequent distal crossings are found.
4. Calculate the fall time:

$$Fall = t_p - t_d$$

Linear interpolation between vertical points and between time intervals is necessary to determine the crossing times, when the proximal and distal values do not correspond to acquired data.

### Frequency

1. Search the measurement zone for the left-most mesial crossing of positive slope. Continue the search to the right to find the first upper signal/noise ratio level crossing to the right of the first mesial crossing. The horizontal coordinate of this crossing is  $Cross_p$ .
2. Search the measurement zone for the left-most mesial crossing of negative slope. Continue the search to the right to find the first lower signal/noise ratio level crossing to the right of the second mesial crossing. The horizontal coordinate of this crossing is  $Cross_n$ .
3. If  $Cross_p < Cross_n$ , set  $Cross_1 = Cross_p$ ,  $Cross_2 = Cross_n$ , and  $Slope = positive$ . If  $Cross_p > Cross_n$ , set  $Cross_1 = Cross_n$ ,  $Cross_2 = Cross_p$ , and  $Slope = negative$ .

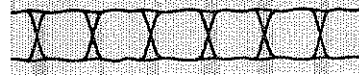

4. If  $Slope =$  positive, search for the third left-most mesial crossing, and continue the search to find the next upper signal/noise ratio level crossing to the right. If  $Slope =$  negative, use the next lower signal/noise ratio level crossing to the right. The horizontal coordinate of this crossing is  $Cross_3$ .
5. Calculate the frequency:

$$Frequency = \frac{1}{Cross_3 - Cross_1}$$

Linear interpolation between vertical points and between time intervals is necessary to determine the crossing time, when the mesial value does not correspond to acquired data.

#### Max

The maximum digitized or calculated data point in the measurement zone of the trace record. An overrange value in the trace record will qualify the measurement readout with "≥". If the trace is null, the measurement value will show "error".



**Mean**

$$Mean = \sum_{j=m}^{n-1} \frac{W(j+1) + W(j)}{[2(n-m)]}$$

where:

- $m$  = index of left-most measurement zone sample
- $n$  = index of right-most measurement zone sample
- $W(j)$  = sampled data point

The summation extends over the interval of time corresponding to one period when Data Interval is set to one period, or the entire measurement zone when Data Interval is set to the entire zone.

**Mid**

$$Mid = \frac{Max + Min}{2}$$

An overrange value in the trace record will qualify the measurement with "≥", and an underrange value in the trace record will qualify the measurement with "≤". If the trace record has both underrange and overrange values, the measurement readout will be "0.0000 ?V". If the trace is null, the measurement value will show "error".

**Min**

The minimum digitized or calculated data point in the measurement zone of the trace record. An underrange value in the trace record will qualify the measurement readout with "≤". If the trace is null, the measurement value will show "error".



### Over Shoot

$$OverShoot = 100 \times \frac{Max - topline}{topline - baseline}$$

If the values of *topline* and *baseline* are equal, the measurement value will show "error".

### Peak-Peak

$$PeakPeak = Max - Min$$

An overrange value in the trace record will qualify the measurement with " $\geq$ ", and an underrange value in the trace record will qualify the measurement with " $\leq$ ". If the trace record has both underrange and overrange values, the measurement readout will be qualified with "?". If the trace is null, the measurement value will show "error".



### Period

1. Search the measurement zone for the left-most mesial crossing of positive slope. Continue the search to the right to find the first upper signal/noise ratio level crossing to the right of the first mesial crossing. The horizontal coordinate of this crossing is  $Cross_p$ .
2. Search the measurement zone for the left-most mesial crossing of negative slope. Continue the search to the right to find the first lower signal/noise ratio level crossing to the right of the second mesial crossing. The horizontal coordinate of this crossing is  $Cross_n$ .
3. If  $Cross_p < Cross_n$ , set  $Cross_1 = Cross_p$ ,  $Cross_2 = Cross_n$ , and  $Slope = positive$ . If  $Cross_p > Cross_n$ , set  $Cross_1 = Cross_n$ ,  $Cross_2 = Cross_p$ , and  $Slope = negative$ .
4. If  $Slope = positive$ , search for the third left-most mesial crossing, and continue the search to find the next upper signal/noise ratio level crossing to the right. If  $Slope = negative$ , use the next lower signal/noise ratio level crossing to the right. The horizontal coordinate of this crossing is  $Cross_3$ .
5. Calculate the period:  
$$Period = Cross_3 - Cross_1$$

Linear interpolation between vertical points and between time intervals is necessary to determine the crossing time, when the mesial value does not correspond to acquired data.

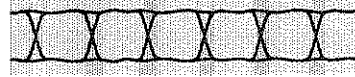

### Phase

1. On the selected waveform, search the measurement zone for the left-most mesial crossing. The horizontal position is  $Cross_{sel}$ .
2. On the reference waveform, search the measurement zone for the left-most mesial crossing of the same slope. The horizontal position is  $Cross_{ref}$ .

3. Calculate the skew:

$$Skew = Cross_{ref} - Cross_{sel}$$

Linear interpolation between vertical points and between time intervals is necessary to determine the crossing time when the mesial value does not correspond to acquired data.

4. Calculate the period value of the selected waveform. (Perform a Period measurement.)
5. Calculate the phase shift:

$$Phase = \frac{Skew}{360 \times Period} \text{ mod } 360$$

If the measurement of either *Period* or *Skew* results in an error, the Phase measurement will show "error".



### Prop Delay

1. On the selected trace, search the measurement zone for the left-most mesial crossing of the specified slope. The horizontal position is  $Cross_1$ .
2. On the second trace, search the measurement zone for the left-most mesial crossing of the specified slope. The horizontal position is  $Cross_2$ .

3. Calculate the delay:

$$Delay = Cross_2 - Cross_1$$

Linear interpolation between vertical points and between time intervals is necessary to determine the crossing time, when the mesial value does not correspond to acquired data.

### Rise

1. Find the first point in the measurement zone that is less than the proximal value, searching from left to right.
2. From this point, find the first proximal crossing and note the time,  $t_p$ .
3. From the proximal crossing, examine points to the right, looking for the distal crossing  $t_d$ . Update  $t_p$  if subsequent proximal crossings are found.

4. Calculate the rise time:

$$Rise = t_d - t_p$$

Linear interpolation between vertical points and between time intervals is necessary to determine the crossing times, when the proximal and distal values do not correspond to acquired data.



**RMS**

$$RMS = \sum_{j=m}^{n-1} \frac{[W(j+1)^2 + W(j)^2]^{1/2}}{[2(n-m)]^{1/2}}$$

where:

- $m$  = index of left-most measurement zone sample
- $n$  = index of right-most measurement zone sample
- $W(j)$  = sampled data point

The summation extends over the interval of time corresponding to one period when Data Interval is set to one period, or the entire measurement zone when Data Interval is set to the entire zone.

**Under Shoot**

$$UnderShoot = 100 \times \frac{baseline - Min}{topline - baseline}$$

If the values of *topline* and *baseline* are equal, the measurement value will show "error".



### Width

1. Search the measurement zone for the leftmost mesial crossing of positive slope. Continue the search to the right to find the first upper signal/noise ratio level crossing to the right of the first mesial crossing. The horizontal coordinate of this crossing is  $Cross_p$ .
2. Search the measurement zone for the leftmost mesial crossing of negative slope. Continue the search to the right to find the first lower signal/noise ratio level crossing to the right of the second mesial crossing. The horizontal coordinate of this crossing is  $Cross_n$ .
3. If  $Cross_p < Cross_n$ , set  $Cross_1 = Cross_p$ ,  $Cross_2 = Cross_n$ , and  $Slope = positive$ . If  $Cross_p > Cross_n$ , set  $Cross_1 = Cross_n$ ,  $Cross_2 = Cross_p$ , and  $Slope = negative$ .
4. Calculate the width:  
$$Width = Cross_2 - Cross_1$$

Linear interpolation between vertical points and between time intervals is necessary to determine the crossing time, when the mesial value does not correspond to acquired data.

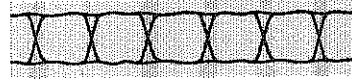

## Statistical Measurements

The algorithms for statistical measurements are identical to those for software measurements, except as noted below. A statistical measurement represents all the data in the color graded database, representing many acquisitions of the selected trace.

The IEEE histogram method is always used to determine topline and baseline when tracking is on. See page 293 for a description of this method. The proximal, mesial, distal, and reference values are then determined as percentages of the topline and baseline.

In statistical measurement mode, the CSA 803 creates a voltage histogram in order to calculate Amplitude, Area+, Area-, or Energy.

The CSA 803 uses timing (horizontal) histograms to determine the crossing values for timing measurements. The timing histograms have a height of 1% of the amplitude (topline – baseline) of the waveform, and are computed at the proximal, mesial, distal, and reference levels. Peaks in the histogram indicate crossings. A peak must be at least 1/8 the height of the maximum peak to be recognized.

### Jitter

The Jitter measurement is available only in statistical measurement mode.

1. Find the leftmost mesial crossing, using timing histograms. This horizontal value is  $Cross_1$ .
2. Find the second mesial crossing, using the same method. If a second crossing is found, its horizontal value is  $Cross_2$ .
  - a. If a second crossing was found, center the histogram horizontal limits about the first crossing, with a width equal to  $Cross_1 - Cross_2$ . That is:

$$RightLimit = Cross_1 + \frac{Cross_2 - Cross_1}{2}$$

$$LeftLimit = Cross_1 - \frac{Cross_2 - Cross_1}{2}$$



- b. If no second crossing was found, the histogram limits are the Left Limit and Right Limit of the measurement zone.
3. Set the top and bottom limits of the histogram at the mesial level.
4. If the Jitter Location is set to Eye Cross and the trace was recognized as an eye diagram, measure the jitter above and below the mesial to find the minimum jitter. Otherwise, calculate the jitter at the mesial.

### Noise

The Noise measurement is available only in statistical measurement mode.

1. Find the leftmost mesial crossing, using timing histograms. This horizontal value is  $Cross_1$ . If no mesial crossing is found, set  $hcenter$  midway between the measurement zone Left and Right limits.
2. If a first mesial crossing was found, find the second mesial crossing, using timing histograms. This horizontal value is  $Cross_2$ . If no second mesial crossing is found, set  $hcenter$  midway between  $Cross_1$  and the measurement zone Right Limit.
3. If a second crossing was found, center  $hcenter$  between  $Cross_1$  and  $Cross_2$  (for an eye diagram, the center of the "eye").
4. Set the left and right limits of the histogram at  $hcenter$ .
5. If Noise Location is Baseline, then center the top limit of the histogram midway between the topline and the baseline and set the bottom limit at the bottom of the graticule.



6. If Noise Location is Topline, then center the bottom limit of the histogram midway between the topline and the baseline and set the top limit at the top of the graticule.
7. Collect a vertical histogram within these limits. If the histogram is empty and the trace is not recognized as an eye diagram, then set *hcenter* midway between the first crossing and the Left limit of the measurement zone, and measure the Noise from a vertical histogram within the limits determined.

### Phase

If the reference trace is not the selected trace, the Phase measurement must be taken using a dual-graticule display, with the selected trace on one graticule, and the reference trace on the other. No other traces may be displayed on either graticule.

If either trace is an eye diagram, the Phase measurement will use the first crossing on the trace, regardless of slope. The Left Limit measurement parameter may be adjusted to control which crossings are used.

### Prop Delay

If the reference trace is not the selected trace, the Prop Delay measurement must be taken using a dual-graticule display, with the selected trace on one graticule, and the reference trace on the other. No other traces may be displayed on either graticule.



## Hardware Measurements

For all hardware measurements, the CSA 803 determines the voltage levels that are used for the measurement. These are the mesial, distal, proximal, and reference voltage levels. If Level mode is set to absolute, then these levels are set to absolute voltages using the knobs.

If Level mode is set to Relative, then the CSA 803 performs the following steps to determine the baseline and topline voltages:

1. If Tracking is off, the CSA 803 uses the baseline and topline values last set using the knobs, or left from the most recent use of tracking.
2. If Tracking is on, the CSA 803 acquires a 2,048-point trace record and builds a histogram. The CSA 803 determines the baseline and topline voltages from the histogram. The histogram algorithm is identical to that used for software measurements.
3. Using the baseline and topline voltages, CSA 803 calculates the mesial, proximal, distal and reference levels from the percentage levels set using the knobs.
4. The CSA 803 acquires a new trace record of the current record length. The measurement hardware determines the dot number(s) on the trace(s) where the signal crosses the level(s) required for the measurement. The dot number is affected by the user settings for the transition number and filtering, and if appropriate, slope.

The determination of which dot represents a level crossing is not performed on the digitized trace data, but on the analog signal, using comparators in the measurement circuitry.

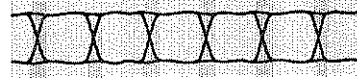
**Cross**

$$Cross = Dly + (T \times M)$$

where:

$Dly$  = delay time from trigger to left edge of selected trace

$T$  = time between successive dots of selected trace

$M$  = selected trace dot number from comparators

**Fall**

$$Fall = T \times (M_p - M_d)$$

where:

$M_d$  = distal dot number from comparators

$M_p$  = proximal dot number from comparators

$T$  = time between successive dots of trace

**Frequency**

$$Frequency = \frac{1}{T \times (M_{m1} - M_{m2})}$$

where:

$M_{m1}$  = first mesial dot number from comparators

$M_{m2}$  = second mesial dot number from comparators

$T$  = time between successive dots of trace

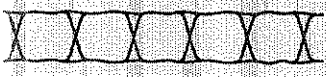

### Period

$$\text{Period} = T \times (M_{m1} - M_{m2})$$

where:

- $M_{m1}$  = first mesial dot number from comparators
- $M_{m2}$  = second mesial dot number from comparators
- $T$  = time between successive dots of trace

### Prop Delay

$$\text{PropDelay} = [Dly_2 + (T_2 \times M_2)] - [Dly_1 + (T_1 \times M_1)]$$

where:

- $Dly_1$  = delay time from trigger to left edge of selected trace
- $T_1$  = time between successive dots of selected trace
- $M_1$  = selected trace dot number from comparators
- $Dly_2$  = delay time from trigger to left edge of second trace
- $T_2$  = time between successive dots of second trace
- $M_2$  = second trace dot number from comparators

### Rise

$$\text{Rise} = T \times (M_d - M_p)$$

where:

- $M_d$  = distal dot number from comparators
- $M_p$  = proximal dot number from comparators
- $T$  = time between successive dots of trace



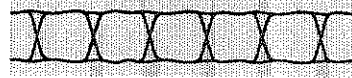

**Width**

$$\text{Width} = T \times (M_{m1} - M_{m2})$$

where:

$M_{m1}$  = first mesial dot number from comparators

$M_{m2}$  = opposite slope second mesial dot number

$T$  = time between successive dots of trace



**Color Grading**

Three algorithms are used to assign colors to the Color Grading display. A statistical database is used to track the number of times a waveform point falls on each pixel of the display, where each time a data point “falls” on a pixel it is counted as a hit. The algorithms are based on the maximum number of hits that have occurred on any pixel in the display. In the following algorithms Max is the maximum number of hits.

For Max > 15:

Hit Density	Default Color	Maps To
[Max/2 + 1] to Max	Pale Yellow	Trace Color 1
[Max/4 + 1] to Max/2	Rose	Trace Color 2
[Max/8 + 1] to Max/4	Purple	Trace Color 4
[Max/16 + 1] to Max/8	Light Blue	Window Trace
1 to Max/16	Green	Trace Color 3

For Max ≥ 6 and Max ≤ 15:

$$sf = \text{Scale Factor} = \sqrt[4]{Max}$$

Hit Density	Default Color	Maps To
[Max/sf + 1] to Max	Pale Yellow	Trace Color 1
[Max/sf <sup>2</sup> + 1] to Max/sf	Rose	Trace Color 2
[Max/sf <sup>3</sup> + 1] to Max/sf <sup>2</sup>	Purple	Trace Color 4
[Max/sf <sup>4</sup> + 1] to Max/sf <sup>3</sup>	Light Blue	Window Trace
1 to Max/sf <sup>4</sup>	Green	Trace Color 3

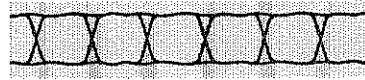

For Max < 6:

Hit Density	Default Color	Maps To
Max	Pale Yellow	Trace Color 1
Max-1	Rose	Trace Color 2
Max-2	Purple	Trace Color 4
Max-3	Light Blue	Window Trace
Max-4	Green	Trace Color 3

For all points where Hit Density  $\leq 0$ , no color is assigned. Note that if Max is less than 5, not all colors will be represented on the display.

*Appendix D: Algorithms*



# Appendix E: Messages



The CSA 803 displays a message at the top of the display whenever one of the following events occurs:

- Errors—The CSA 803 cannot perform a requested operation.
- Warnings—The instrument performs the requested operation, but warns you that the results may be corrupted or meaningless.
- Ready Messages—The CSA 803 is waiting for your response to complete the task.
- Operation Complete Messages—An operation is complete.

When a message appears on the display, you can remove it by performing any operation: touching the graticule area, making a menu selection, or pressing a button.

When a hardcopy is made, any message on the display is removed immediately before making the copy.

## Selected Message Descriptions

The meaning of most messages is self-evident. The listing below shows some of the messages that might be unclear, and gives more information about the cause of the message.

### **Autoset failed, bad trigger level.**

Autoset failed due to an unacceptable trigger signal. Autoset will not change trigger coupling, slope, or external attenuation. Make certain these are appropriate for your trigger source before using autoset.

### **Baseline correction failed to find -1 p point.**

If the trace is not triggered, or if the portion of the trace immediately to the left of the display (earlier in time) is not a flat trace, the voltage reference cannot be determined.



**Blowby calibration failed — can't find reference step.**

The required signal is not connected to the channel being calibrated. Be certain to follow the instruction message on the display before touching the **Proceed** selector.

**Calculated waveforms cannot be measured in hardware mode.**

Hardware measurements can only be taken from traces without arithmetic operators or trace functions.

**Change in channel (#, Unit) configuration.**

Do not change sampling heads with the power on. Doing so may damage the mainframe, the sampling head, or both.

**Channel (#, Unit) powered down during mainframe operation — Cycle power to continue.**

Do not change sampling heads with the power on. Doing so may damage the mainframe, the sampling head, or both.

**Channel (#, Unit) powered-up during mainframe operation — Cycle power to utilize.**

Do not change sampling heads with the power on. Doing so may damage the mainframe, the sampling head, or both.

**Channel (#, Unit) was not maintained at desired calibration delay value.**

Indicates that the automated calibration system attempted to adjust the delay of the named sampling head channel. If you are not using the delay adjust feature of the Enhanced Accuracy major menu, you can turn off the **Delay Compensate** selector to stop the CSA 803 from making the delay adjust calibration.



**Connect a 50- $\Omega$  terminator to the selected channel and press Proceed when ready.**

The CSA 803 is waiting for you to put a terminator on the signal connector of the sampling head channel you are calibrating, and touch the **Proceed** selector. If you touch the **Proceed** selector without attaching the terminator, the calibration will fail or the results will be inaccurate.

**Delay adjust calibration failed, can't find transition.**

The required signal is not connected to the channel being calibrated. Be certain to follow the instruction message on the display before touching the **Proceed** selector.

**Delay adjust measurement on reference channel failed — Can't find transition.**

The required signal is not connected to the channel being calibrated. Be certain to follow the instruction message on the display before touching the **Proceed** selector.

**Error detected in acquisition system: (channel #).**

The time base controller detected an acquisition system error. You should contact your service person. The message is accompanied by six groups of four characters. You should note the accompanying information for your service person.

**Front panel locked out.**

A command from a computer on a remote interface (GPIB or RS-232-C) has disabled the touch panel. Touches are ignored until the remote computer restores touch panel operation.

**Hardcopy absent or off-line.**

Either no printer is connected to the CSA 803, or the printer that is connected is not on-line. Until the condition is remedied, hardcopies cannot be taken.



**Minor time base calibration problem: (channel #).**

The time base calibration is no longer accurate to enhanced accuracy specifications. Be sure you wait 20 minutes for the CSA 803 system to warm up before performing enhanced accuracy calibrations. If this error message occurs repeatedly after warm-up, contact your service person.

**Non-volatile RAM completely reset.**

Due to a battery failure, the settings and internal calibrations of the system were reset to default at power-on. The instrument may need complete recalibration. The number of power-on cycles and the uptime count, stored settings, and instrument calibration have all been lost.

**Non-volatile RAM front panel settings lost, instrument ID data retained.**

The front panel settings were reset to default at power-on, because the settings were corrupted. This can reflect an internal problem, or the settings can be corrupted by improper commands from a remote computer connected to the GPIB or RS-232-C interfaces.

**Reference trace defaulted to selected trace.**

The reference trace for a prop delay measurement is no longer a valid trace, so the reference is now the same trace as the trace being measured. For example, assume you defined a prop delay measurement on trace 2, using trace 1 as a reference trace. If you delete trace 1, then the next time you display the measurements on trace 2, you will see this message.

**Rho scaling failed to find -1  $\rho$  point. Cannot calibrate rho scales.**

If the trace is not triggered, or if the portion of the trace to the immediately to the left of the display (earlier in time) is not a flat trace, the voltage reference cannot be determined.





**Time base calibration failed.**

The time base controller detected an acquisition system error. You should contact your service person.

**Time base system error.**

The time base controller detected an acquisition system error. You should contact your service person. The message is accompanied by six groups of four characters. You should note the accompanying information for your service person.

*Appendix E: Messages*

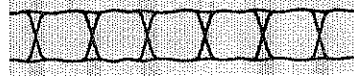

# Glossary

**Acquisition**

The process of repeatedly sampling the signals coming through input channels, and accumulating the samples into traces.

**Active Graticule**

The graticule in a dual-graticule display that shows the selected trace.

**Annotation**

Lines that show the current measurement parameter settings in a visual way.

**Autoset**

A means of letting the CSA 803 set itself to provide a stable and meaningful display of a given trace.

**Averaging**

Displaying a trace that is the combined result of several acquisitions, thereby reducing apparent noise.

**Axis Label**

There are three notations on each axis. The first and last notation on each axis show the numeric value of the graticule edge (*not* the edge of the displayed points, which are slightly outside the graticule). The center notation is the scale factor expressed in units per division.

**Baseline Correction**

The process of maintaining the displayed vertical placement of a trace, correcting for changes in the signal levels that would ordinarily move the trace up or down.

**Channel**

A place to connect a signal or attach a network or transmission line to sampling heads. Also, the smallest component of a trace expression.

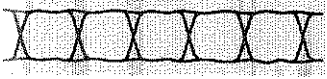
**Channel Number**

The number assigned to a specific signal input connector. The top channel of the left-most sampling head compartment of the CSA 803 mainframe is always mainframe channel 1, regardless of any repositioning or omission of sampling heads.

**Complex Trace**

A trace with a trace expression beyond a single channel specification. Any trace using a numeric value, a function, a reference to a stored trace, or an arithmetic operator is a complex trace.

**Control Knob**

see *Knob*

**Cursor**

Any of four styles of paired markers that you position with the knobs. The CSA 803 displays the positions of the cursors and the distance between them in axis units.

**Default Measurement Parameter**

A value from the default set of measurement parameters. The operator can change the default values. Whenever a trace is created, the measurement parameters are copied from the default set.

**Distal**

The most distant point from a reference point. As used in the CSA 803, the ending measurement point for timing measurements.

**Dragging**

The act of changing your touch panel selection by moving your finger without removing it from the screen. The selection that is activated is the last one that you were touching before removing your finger.

**Dual Graticule**

A display with two graticules. Each one is half the height of the single graticule.

**Entry Line**

A text line that shows your input as you enter selections in a pop-up menu.

**Enveloping**

Displaying a trace that shows the extremes of variation of several acquisitions.

**GPIB (General Purpose Interface Bus)**

An interface that allows remote computer control of, and data capture from, an CSA 803.

**Graticule**

The grid where traces are displayed.

**Hardcopy**

A paper print or plot of the display.

**Hardware Measurement**

An automated measurement that is captured by special circuitry that monitors signals directly, as opposed to software measurements that are derived from acquired trace samples.

**Highlighted Trace**

The selected trace in a single-graticule or dual-graticule display. Also, in a dual-graticule display, the last selected trace on the non-active graticule—the graticule without icons.

**Horizontal Reference Point**

The point about which the trace is expanded or contracted when horizontal size adjustments are made. The horizontal reference point remains anchored as the rest of the trace grows or shrinks around it.

**Icon**

A marker on the edge of the graticule that performs a specific function when touched.

**Initialize**

Setting the CSA 803 to a completely known, default condition.

**Internal Clock**

A trigger source that is synchronized with the Calibrator signal.

**Keypad Menu**

A pop-up menu that controls knob resolution and lets you enter specific numeric values for any control to which a knob is assigned.

**Knob**

One of the two large rotary controls to the right of the CSA 803 screen.

**Knob Assignment**

The value that a knob will adjust at a given time.

**Knob Menu**

The on-screen menu that always displays the current knob assignment. The knob menu also lets you display the Keypad menu.

**Knob Resolution**

The amount of change caused by each click of a knob.

**Major Menu**

The menu that is displayed at the bottom of the screen alongside the Knob menu. One of the several major menus is always displayed.

**Major Menu Button**

A labeled button above the knobs that determines which major menu is displayed.

**Measurement**

An automated numeric readout that the CSA 803 provides directly from the displayed trace in real time, without operator intervention.

**Measurement Parameter**

One of several controls that the CSA 803 operator can exercise over the automated measurement process.

**Measurement Statistics**

The accumulation of a history of individual measurement readouts, showing the mean and standard deviation of a selected number of samples.

**Measurement Tracking**

The process of automatically adjusting the measurement parameters to reflect changes in the trace.

**Mesial**

The middle point of a range of points. As used in the CSA 803, the middle measurement point between proximal and distal points for timing measurements, and the intermediate height between baseline and topline for amplitude measurements.

**Outline Box**

A visual feedback mechanism of the touch panel. Your potential selection is always indicated by a box while you have your finger touching the screen.

**Persistence**

The amount of time a data point remains displayed. There are four persistence modes available in the CSA 803: Normal, Variable, Infinite and Color Grading.

**Pixel**

A visible point on the display. The CSA 803 display is 551 pixels wide and 704 pixels high. Each pixel may be set to any of the display colors.

**Pop-up Menu**

A temporary menu that provides an interactive dialog for a specific purpose. A sub-menu of a major menu.

**Principal Power Switch**

The master power switch located on the rear panel of the CSA 803.

**Proximal**

The point closest to a reference point. As used in the CSA 803, the beginning measurement point for timing measurements.

**Record Length**

The number of samples (data points) that make up a trace.

**RS-232-C**

An interface that allows remote computer control of, and data capture from, an CSA 803.

**Sample Interval**

The time interval between successive samples in a trace record.

**Sampling Head**

A high-performance amplifier that captures the incoming signal of a channel and reports the sampled data to the CSA 803.

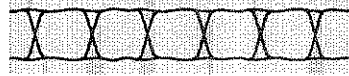

**Selected Trace**

The highlighted (brightest) trace of a multi-trace display. The selected trace is the trace that is acted on by the knobs and menu selectors.

**Selector**

An area of a menu that performs some action when you touch it.

**Setting**

The state of the front panel and system at a given time.

**Software Measurement**

An automated measurement that is derived from acquired trace samples, as opposed to hardware measurements that are captured by special circuitry that monitors the signals directly.

**Smoothing**

Processing applied by the sampling head prior to the digitization of a trace, to reduce apparent noise. With smoothing, the sampling head samples the signal 8 times instead of once, and the average of the samples is then used by hardware measurements and the digitizing circuitry.

**Statistical Measurement**

An automated measurement that is derived from color graded waveform data and is based on histograms computed at the crossing levels. A statistical measurement can be selected only in color graded display mode.

**Stored Trace**

A collection of sampled points that constitute a single trace acquisition that is saved in memory.

**Time Base**

The time-dependent specifications that control the acquisition of a trace. The time base determines when and how long to acquire and digitize signal data points.

**Time-Domain Reflectometry (TDR)**

A method of characterising a transmission line or network by sending a signal from one end and monitoring the electrical reflections.

**Trace**

The visible representation of an input signal or combination of signals. Identical to waveform.

**Trace Expression**

The definition of what the trace displays. It can include one or more channels combined arithmetically and modified by functions.

**Trace Number**

A number assigned by the CSA 803 to identify a trace. Displayed traces are numbered 1 through 8. A new trace is always given the lowest available number.

**Tracking**

The process of automatically adjusting the measurement parameters or window position to reflect changes in the trace.

**Trigger**

An electrical event that initiates acquisition of a trace as specified by the time base.

**Uptime**

The number of hours the instrument has been powered on.

**Vertical Description**

*see Trace Expression*

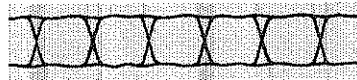
**Waveform**

The visible representation of an input signal or combination of signals. Identical to trace.

**Window**

A trace that represents a horizontally expanded portion of another trace.

**XY Trace**

A trace where both horizontal and vertical position of the data points reflect signal data.

**YT Trace**

A trace where the vertical position of the trace data points reflects signal data, and the horizontal position of the trace data points reflects time.

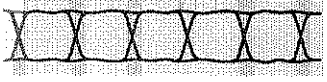

# Index



## A

- Accessories, 269–271
- Acquire Desc** pop-up menu, 35, 45–47
- Acquisition, 33–38
  - conditional, 35
  - stopping and starting, 35
- ACQUISITION** button, 35
- Algorithms
  - measurement, 283, 293–315
  - trace function, 283–293
- All trace status menu, 240–241
- APC 3.5. *See Connectors*
- Audio feedback, 39
- Autoset, 41–43
- AUTOSET** button, 41
- Averaging, 45–47
- Axis labels, 107
- Axis units
  - rho, 111–113
  - seconds, meters, and feet, 111, 113

## B

- Baseline, 174, 293–295
- Baseline correction, 49–50, 220
- Beep. *See Audio feedback*
- Blowby Compensate** pop-up menu, 90, 96
- Brightness. *See Display intensity*
- Buttons, 2–3
  - ACQUISITION**, 35
  - AUTOSET**, 41
  - HARDCOPY**, 122–124
  - sampling head **SELECT CHANNEL**, 198–199
  - SEQUENCE SETTING**, 207



## C

- Calibration. *See Enhanced accuracy*
- Calibrator** output, 51
- Calipers. *See Cursors*
- Cancel, 9
- Clear (Histograms), 132
- Clear Cursors** selector, 68
- Clear Trace** pop-up menu, 37–38
- Clearing traces, 37–38
- Clock. *See Time and date*
- Color, 53, 54, 55
- Color Grading mode, 81
- Color** pop-up menu, 53, 54, 55
- Common mode TDR measurements, 217, 226, 229–231
- Compare & References** pop-up menu, 170–171
- Connectors, 2–3, 4–5
  - APC 3.5, 281
  - DIRECT**, 247
  - GPIB**, 103–105, 115
  - INTERNAL CLOCK**, 51
  - POWER**, 183
  - PRESCALE**, 247
  - PRINTER**, 115
  - RS-232-C**, 115–116, 191
  - SMA, 281
- Constellation Diagrams, 57–63
- Cursor Type** pop-up menu, 65–67
- Cursors, 65–70
- Cursors** icon, 66

## D

- DefTra** icon, 235–239



**DefTra** pop-up menu, 235–239  
**Delay Adjust** pop-up menu, 91, 97–98  
Delayed sweep. *See Windows*  
**Delete Setting** pop-up menu, 206  
**Delete Trace** pop-up menu, 212, 213  
Diagnostics, 71–76  
    extended, 71, 74–76  
    power-on, 71–72  
    self-test, 71, 73  
**Diff TDR Preset, Sampling Head Fnc's**, 200  
Differential TDR measurements, 217, 226, 229–231  
Display, 2–3, 6–7  
Display intensity, 55, 77  
Display Persistence, 79–84  
Displaying Labels, 148  
Distal, 174

## **E**

Electrostatic discharge, 281  
Enhanced accuracy, 85–98  
    automatic calibration, 88–89, 92–93  
    manual calibration, 94–98  
    sampling heads, 85–98  
Enveloping, 45–47  
Error messages, 317–321  
**Extended Diagnostic** selector, 74  
**External Channel Attenuation, Sampling Head Fnc's**, 201  
Eye Diagrams, 99–102

## **F**

Fast. *See Trace scaling*  
Filtering, 174



Fuse, 4–5, 183, 277

## G

**Gain** pop-up menu, 90, 94–95

**GPIB**, 103–105

**GPIB** connector, 103–105, 115

**GPIB/RS232C** pop-up menu, 104–105, 192–195

Graticules, 107–113, 265

**Graticules** pop-up menu, 49–50, 109–113

## H

Hardcopy, 115–124

    color map, 119

    Defaults, 124

**HARDCOPY** button, 122–124

**Hardcopy Options** pop-up menu, 117–124

High precision. *See Trace scaling*

Histograms, 125–133

    Clear, 132

    Hits, 133

    Mean, 132

$\mu \pm 1\sigma$ , 133

    Pk–Pk, 132

    record length, 127

    Refresh Rate, 131

    RMSdelta, 133

    Set N Samples, 129, 158

    Set N Wfms, 129

    Stop N Samples, 129, 158

    Stop N Wfms, 129

    Wfms, 133

Hits (histogram display), 133

Horizontal

    controls, 135–141





icon (↔), 135, 260  
pan/zoom, 137–138  
reference point, 139–141  
size and position, 33, 135–141, 260

**Horizontal Bars** selector, 67

**Horizontal Desc** pop-up menu, 139–141, 188–189, 266–267

Horizontal Histogram, 127

## I

Icons, 8–9

**Cursors**, 66

**DefTra**, 235–239

horizontal (↔), 135, 260

trigger (↗), 248

vertical (↓), 255–257, 260–261

**Window**, 259–260

**Identify** pop-up menu, 215–216

Infinite Persistence, 80

Initialization, 143–144

**Instrument Options** pop-up menu, 39, 41–43, 77, 233–234,  
244–246, 252–253

Intensity, display, 55

**INTERNAL CLOCK** connector, 51

## K

Keypad pop-up menu, 10–11

Knob menu, 10–11

Knobs, 2–3, 10–11

## L

Label Mode, 146

**Label** pop-up menu, 147



- Labeling** pop-up menu, 146–148
- Labels, 145–148
  - displayed on graticule, 148
  - positioning, 148
- Level mode, 174
- LINE VOLTAGE SELECTOR** switch, 183
- Lower Graticule** pop-up menu, 109–113

## M

- Mask Cursor X, 151
- Mask Testing pop-menu, Set N Wfms, 158
- Mask Testing** pop-up menu, 149–160
  - Clear Hits, 157
  - Edit Mask Definition, 151
  - Mask1–Mask10, 157
  - Stop N Wfms, 158
  - Total, 156
  - Wfm, 156
- Mean (histogram display), 132
- Measurements, 161–181
  - algorithms, 283, 293–315
  - comparing to references, 170–171
  - default parameters, 180–181
  - defining, 163–165
  - factors affecting accuracy, 47
  - hardware and software, 166–169
  - individual measurement pop-up menus, 172–173
  - parameters, 172–178
  - statistics, 179
  - statistics mode, 166–169
  - Topline/Baseline calculation, 165
- Measurements** pop-up menu, 163–169, 180–181
- Menus, 12–29
- Mesial, 174
- Messages, 317–321



**More...** menu, 240–241  
 $\mu \pm 1\sigma$  (histogram display), 133

## N

Normal Persistence, 80

## O

**Offset** pop-up menu, 91, 96  
**ON/STANDBY** switch, 183  
Options, 269–271  
Overall intensity, 55

## P

Packaging, 282  
**Paired Dots** selector, 67  
Pan/zoom, 137–138  
Persist/Histogram pop-up menu, 126, 150  
Persist/Histograms pop-up menu

- Color Grading, 81
- Infinite, 80
- Normal, 80
- Refresh Rate, 81
- Set N MaxContrast, 84
- Stop N MaxContrast, 84
- Variable, 80

Persist/Histograms pop-menu, 79–84  
Pk-Pk (histogram display), 132  
Pop-up menus, 6–7

- Acquire Desc**, 35, 45–47
- Blowby Compensate**, 90, 96
- Clear Trace**, 37–38
- Color**, 53, 54, 55
- Compare & References**, 170–171

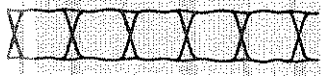

**Cursor Type**, 65–67  
**DefTra**, 235–239  
**Delay Adjust**, 91, 97–98  
**Delete Setting**, 206  
**Delete Trace**, 212, 213  
**Gain**, 90, 94–95  
**GPIO/RS232C**, 104–105, 192–195  
**Graticules**, 49–50, 109–113  
**Hardcopy Options**, 117–124  
**Horizontal Desc**, 139–141, 188–189, 266–267  
**Identify**, 215–216  
individual measurement, 172–173  
**Instrument Options**, 39, 41–43, 77, 233–234, 244–246,  
252–253  
keypad, 10–11  
**Label**, 147  
**Labeling**, 146, 147, 148  
**Lower Graticule**, 109–113  
**Mask Testing**, 149–160  
**Measurements**, 163–169, 180–181  
**Offset**, 91, 96  
**Recall Setting**, 205  
**Recall Trace**, 211  
**Sampling Head Fnc's**, 199–202  
**Set Zero**, 67  
**Store Setting**, 204–205  
**Store Trace**, 209, 210  
**TDR Amplitude**, 91, 96–97  
**Upper Graticule**, 109–113  
**Vertical Desc**, 242  
**Window Mode**, 261–264  
**POWER** connector, 183  
Power-on, 183–185  
Prescale, 247  
**Preset Clear, Sampling Head Fnc's**, 200  
**PRINCIPAL POWER SWITCH**, 183  
**PRINTER** connector, 115  
**Proceed** selector, 68



Propagation velocity, 113

## R

**Recall Setting** pop-up menu, 205

**Recall Trace** pop-up menu, 211

Record Length, 127

Record length, 187–189

Reference amplitude, 112

Reference plane, 232

Refresh Rate, 131

**Remove/Clr**, 37

Rho, 111–112

Rho units, selecting, 223–225

RMSdelta (histogram display), 133

**RS-232-C** connector, 115–116, 191

RS-232-C parameters, 191–195

## S

Safety, 279–282

**Sampling Head Fnc's** pop-up menu, 199–202

Sampling heads, 197–202

    compartments, 2–3, 197

    red light, 198–199

**SELECT CHANNEL** button, 198–199

    smoothing, 201–202

    yellow light, 198–199

Scaling, trace, 244–246

**SELECT CHANNEL** button, 221, 226

**Self Test** selector, 73

**SEQUENCE SETTING** button, 207

**Set Cur1 Zero** selector, 68

Set N Samples, 129, 158



Set N Wfms, 129, 158  
**Set Zero Rho** selector, 68  
**Set Zero** selector, 67  
Settings  
    default, 143–144  
    initialize, 143–144  
    stored, 203–207  
Shipping, 282  
SMA. *See Connectors*  
Smooth function, 239  
Smoothing, 201–202  
Specifications, 273–278  
• **Split Dots** selector, 67  
Standard Deviation (histogram display), 133  
Statistical measurements, 166–169  
Step generator, operation, 217–220  
Stop N Samples, 129, 158  
Stop N Wfms, 129, 158  
**Store Setting** pop-up menu, 204–205  
**Store Trace** pop-up menu, 209, 210  
Stored settings, 203–207  
    Sequencing, 207  
Stored traces, 209–213  
Switches, 2–3, 4–5  
    **LINE VOLTAGE SELECTOR**, 183  
    **ON/STANDBY**, 183  
    **PRINCIPAL POWER SWITCH**, 183  
System identification, 215–216

## T

TDR, 199, 217–232  
    differential and common mode measurements, 226  
    plus alignment, 232

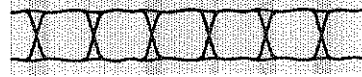

- taking measurements, 221–232
- TDR Amplitude** pop-up menu, 91, 96–97
- TDR Head D Delay, Sampling Head Fnc's**, 200
- TDR Polarity, Sampling Head Fnc's**, 200
- TDR Preset, Sampling Head Fnc's**, 200
- TDR/TDT, Sampling Head Fnc's**, 200
- TDT, 231
- Time and date, 233–234
- Time Base Cal Mode** selector, 86
- Time bases, 136
- Time Domain Reflectometry (TDR), 217–232
- Time Domain Transmission (TDT), 200, 231
- Topline, 293–295
- Touch panel, 6–7
- Traces, 235–246
  - clearing, 37–38, 242–243
  - defining, 235–239
  - functions, 45
  - modifying, 242
  - removing, 242–243
  - scaling, 244–246
  - selecting, 108–109, 239–241
  - stored, 209, 210, 211, 212, 213
  - trace expressions, 235–239
  - trace function algorithms, 283–293
  - trace functions, 238–239
  - trace numbers, 239
  - trace scaling, 244–246
  - trace separation, 257
  - vectoring, 251–253
  - XY, 265–267
- Tracking, 178
- Trigger
  - DIRECT** connector, 247
  - PRESCALE** connector, 247
- Trigger icon (  ), 248



Triggering, 247–249  
  Channel, 248–249  
  External Direct, 248–249  
  External Prescaler, 248–249  
  Internal Clock, 248–249

## U

**Upper Graticule** pop-up menu, 109–113

## V

Variable persistence, 80  
Vectored traces, 251–253  
Vertical  
  icon (↕), 255–257, 260–261  
  size and offset, 49–50, 255–257, 260–261  
**Vertical Bars** selector, 67  
**Vertical Desc** pop-up menu, 242  
Vertical Histogram, 127

## W

Wfms (histogram display), 133  
**Window** icon, 259–260  
**Window Mode** pop-up menu, 261–264  
Windows, 259–264

## X

XY traces, 265–267



## **MANUAL CHANGE INFORMATION**

At Tektronix, we continually strive to keep up with latest electronic developments by adding circuit and component improvements to our instruments as soon as they are developed and tested.

Sometimes, due to printing and shipping requirements, we can't get these changes immediately into printed manuals. Hence, your manual may contain new change information on following pages.

A single change may affect several sections. Since the change information sheets are carried in the manual until all changes are permanently entered, some duplication may occur. If no such change pages appear following this page, your manual is correct as printed.

