



**DM 502A  
AUTORANGING  
DIGITAL  
MULTIMETER**

**INSTRUCTION MANUAL**

**Tektronix, Inc.  
P.O. Box 500  
Beaverton, Oregon 97077**

Serial Number \_\_\_\_\_

## WARRANTY

This Tektronix product is warranted against defective materials and workmanship, under normal use, for a period of one year from date of initial shipment. Tektronix will repair or replace, at its option, those products determined to be defective within the warranty period and returned, freight prepaid, to a Tektronix Service Center. There is no implied warranty for fitness of purpose.

Please direct all requests for service or replacement parts to the nearest Tektronix Service Center or Field Office; include the type or part number of the product and its serial number.

Copyright © 1979 by Tektronix, Inc. All rights reserved.  
Contents of this publication may not be reproduced in any form without the permission of Tektronix, Inc.

Products of Tektronix, Inc. and its subsidiaries are covered by U.S. and foreign patents and/or pending patents.

TEKTRONIX, TEK, SCOPE-MOBILE, and  are registered trademarks of Tektronix, Inc.

Printed in U.S.A. Specification and price change privileges are reserved.

# OPERATORS SAFETY SUMMARY

The general safety information in this part of the summary is for both operating and servicing personnel. Specific warnings and cautions will be found throughout the manual where they apply, but may not appear in this summary.

## TERMS

### In This Manual

CAUTION statements identify conditions or practices that could result in damage to the equipment or other property.

WARNING statements identify conditions or practices that could result in personal injury or loss of life.

### As Marked on Equipment

CAUTION indicates a personal injury hazard not immediately accessible as one reads the marking, or a hazard to property including the equipment itself.

DANGER indicates a personal injury hazard immediately accessible as one reads the marking.

## SYMBOLS

### In This Manual



This symbol indicates where applicable cautionary or other information is to be found.

### As Marked on Equipment



DANGER — High voltage.



Protective ground (earth) terminal.



ATTENTION — refer to manual.

### Power Source

This product is intended to operate in a power module connected to a power source that will not apply more than 250 volts rms between the supply conductors or between either supply conductor and ground. A protective ground connection by way of the grounding conductor in the power cord is essential for safe operation.

### **Grounding the Product**

When installed in the power module, this product is grounded through the grounding conductor of the power cord. To avoid electrical shock, plug the power cord into a properly wired receptacle before connecting to the product input or output terminals. Upon loss of the protective ground connection, all accessible conductive parts (including knobs and controls that may appear to be insulating) can render an electric shock.

### **Use the Proper Fuse**

To avoid fire hazard, use only the fuse specified in the parts list for your product, and which is identical in type, voltage rating, and current rating.

Refer fuse replacement to qualified service personnel.

### **Do Not Operate In Explosive Atmospheres**

To avoid explosion, do not operate this product in an atmosphere of explosive gases unless it has been specifically certified for such operation.

### **Do Not Remove Covers or Panels**

To avoid personal injury, do not remove the product covers or panels. Do not operate the product without the covers and panels properly installed.

### **Do Not Operate Without Covers**

To avoid personal injury, do not operate this product without covers or panels installed. Do not apply power to the plug-in via a plug-in extender.

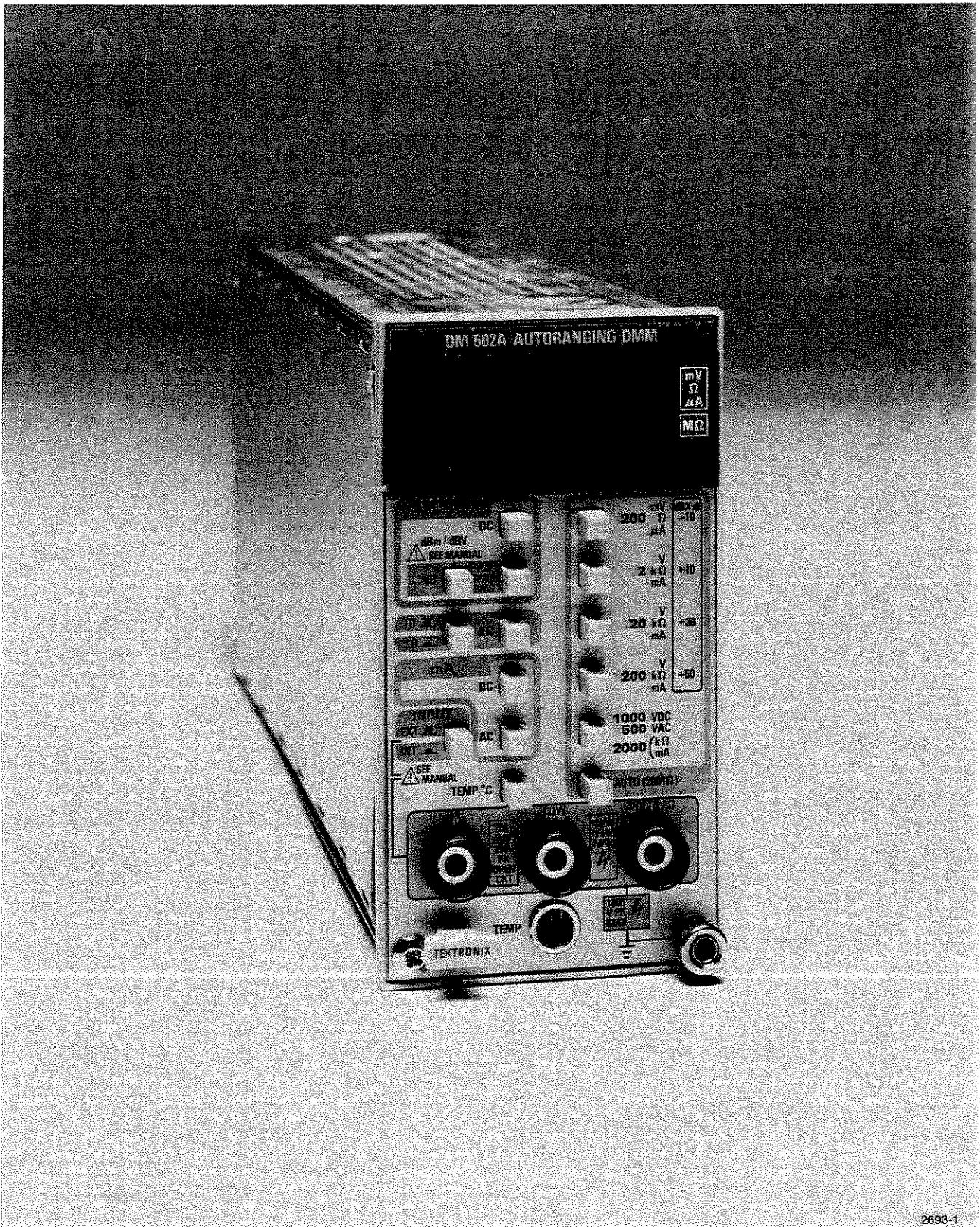

2693-1

DM 502A Autoranging Digital Multimeter.



# SPECIFICATION

## Instrument Description

The DM 502A Digital Multimeter measures dc and ac voltage and current, dBm, dBV, resistance, and temperature. The ac functions are true rms responding. The ranges for dc voltage, ac voltage, dBm, dBV, and resistance are automatically or manually selected as desired. The current and temperature ranges are manually selected.

Rear interface connector input is pushbutton selected from the front panel. Readout in dBm or dBV is chosen by an internal jumper. The unit is shipped with the internal jumper in the dBm position.

The readout is a 3 1/2 digit display using seven segment LED. The decimal point is automatically positioned depending on the operating range of the instrument. Polarity indication is automatic.

## Accessories

Standard accessories include this instruction manual, a set of test leads, and the TEKTRONIX P6601 temperature probe. The P6601 temperature probe and temperature measurement capabilities are deleted for Option 2 instruments.

## Performance Conditions

The electrical characteristics are valid only if the DM 502A has been calibrated at an ambient temperature between +21°C and +25°C and is operating at an ambient temperature between 0°C and +50°C.

Items listed in the Performance Requirements column of the Electrical Characteristics are verified by completing the Performance Check in the Calibration section of this manual. Items listed in the Supplemental Information column are not verified in this manual. They are either explanatory notes or performance characteristics for which no limits are specified.

## ELECTRICAL CHARACTERISTICS

Table 1-1  
DC VOLTMETER

Characteristics	Performance Requirements	Supplemental Information
Accuracy for 200 mV, 2 V, 20 V, 200 V, and 1000 V ranges (Front Panel and Rear Interface) +18°C to +28°C 200 mV to 200 V ranges 1000 V range	$\pm(0.1\% \text{ of reading} + 0.05\% \text{ of full scale})$ $\pm(0.1\% \text{ of reading} + 0.1\% \text{ of full scale})$	Automatic or manual ranging.  Maximum input for rear interface is 200 V peak.
0°C to +18°C, +28°C to +50°C 200 mV to 200 V ranges 1000 V range	$\pm(0.2\% \text{ of reading} + 0.1\% \text{ of full scale})$ $\pm(0.2\% \text{ of reading} + 0.2\% \text{ of full scale})$	Maximum input for rear interface is 200 V peak.
Common Mode Rejection Ratio	$\geq 100$ dB at dc. $\geq 80$ dB at 50 to 60 Hz $\pm 0.2$ Hz.	Verified with a 1 k $\Omega$ unbalance in series with LOW terminal. (Internal clock frequency must be 20.48 kHz $\pm 1\%$ .)
Normal Mode Rejection Ratio	$\geq 50$ dB at 50 or 60 Hz $\pm 0.2$ Hz.	(Internal clock frequency must be 20.48 kHz $\pm 1\%$ .)

Table 1-1 (cont)

Characteristics	Performance Requirements	Supplemental Information
Maximum Resolution		100 $\mu$ V.
Step Response Time		<1 second within any range. Add 1.5 seconds for each range change in the AUTO mode.
Input Resistance		10 M $\Omega$ $\pm$ 0.5%.
Input Terminals		Front panel (EXT) or rear interface (INT). Switch selectable.
Maximum Input Voltage		
Front Panel Terminals		
VOLTS/ $\Omega$ to LOW		1000 V peak.
VOLTS/ $\Omega$ to Ground		1000 V peak.
LOW to ground		1000 V peak.
Rear Interface Terminals		
Pin 28B to Pin 28A		200 V peak.
Pin 28B to Ground		200 V peak.
Pin 28A to Ground		200 V peak.

Table 1-2  
AC VOLTMETER (TRUE RMS)

Characteristics	Performance Requirements	Supplemental Information
Accuracy for 200 mV, 2 V, 20 V, 200 V, and 500 V ranges:		Automatic or manual ranging.
Front Panel		
+18°C to +28°C		
200 mV to 200 V ranges		
20 Hz to 40 Hz	$\pm$ (1.5% of reading + 0.3% of full scale)	
40 Hz to 20 kHz	$\pm$ (0.6% of reading + 0.3% of full scale)	
500 V range		
20 Hz to 40 Hz	$\pm$ (1.5% of reading + 1.2% of full scale)	
40 Hz to 20 kHz	$\pm$ (0.6% of reading + 1.2% of full scale)	
0°C to +18°C, +28°C to +50°C		
200 mV to 200 V ranges		
20 Hz to 40 Hz	$\pm$ (1.8% of reading + 0.35% of full scale)	
40 Hz to 20 kHz	$\pm$ (0.8% of reading + 0.35% of full scale)	
500 V range		
20 Hz to 40 Hz	$\pm$ (1.8% of reading + 1.4% of full scale)	
40 Hz to 20 kHz	$\pm$ (0.8% of reading + 1.4% of full scale)	
Rear interface	Increase above percent of reading tolerances by 0.5%.	Maximum rear interface input is 200 V peak.



Table 1-2 (cont)

Characteristics	Performance Requirements	Supplemental Information
Usable from 20 kHz to 100 kHz 200 mV to 200 V ranges  500 V range		Typically $\leq \pm(5\%$ of reading + 0.3% of full scale).  Typically $\leq + (5\%$ of reading + 1.2% of full scale).
Common Mode Rejection Ratio	$\geq 60$ dB at 60 Hz	Verified with 1 k $\Omega$ unbalance in series with the LOW terminal.
Maximum Resolution		100 $\mu$ V.
Response Time		<1 second within any range. Add 1.5 seconds for each range change in the AUTO mode.
Input Impedance		10 M $\Omega$ $\pm 0.5\%$ paralleled by <60 pF.
Input Terminals		Front panel (EXT) or rear interface (INT) Switch selectable..
Maximum Input Voltage Front Panel Terminals VOLTS/ $\Omega$ to LOW VOLTS/ $\Omega$ to Ground LOW to Ground		500 Vrms, not to exceed 1 kV peak. 500 Vrms, not to exceed 1 kV peak. 500 Vrms, not to exceed 1 kV peak.
Rear Interface Terminals Pin 28B to Pin 28A Pin 28B to Ground Pin 28A to Ground		Not to exceed 200 V peak. Not to exceed 200 V peak. Not to exceed 200 V peak.
Crest Factor		4 at full scale on all ranges except 500 V, $\leq 2$ on 500 V range.

Table 1-3  
DECIBELS (dB)—TRUE RMS

Characteristics	Performance Requirements	Supplemental Information
Accuracy for $-10$ dB, $+10$ dB, $+30$ dB, and $+50$ dB ranges (Front Panel and Rear Interface)		Automatic or manual ranging. Front panel shows maximum range value with 40 dB below dynamic range.
$+18^\circ\text{C}$ to $+28^\circ\text{C}$	$\pm 0.5$ dB from $+50$ dB to $-50$ dB from 20 Hz to 20 kHz. $\pm 0.5$ dB from $-50$ dB to $-60$ dB from 20 Hz to 2 kHz. $\pm 1.5$ dB from $-50$ dB to $-60$ dB from 2 kHz to 20 kHz.	

Table 1-3 (cont)

Characteristics	Performance Requirements	Supplemental Information
0°C to +18°C, +28°C to +50°C	±1.1 dB from +50 dB to -50 dB from 20 Hz to 20 kHz. ±1.1 dB from -50 dB to -60 dB from 20 Hz to 2 kHz. ±2.1 dB from -50 dB to -60 dB from 2 kHz to 20 kHz.	
Maximum Resolution		0.1 dB.
Response Time		<1 second within any range. Add 1.5 seconds for each range change in the AUTO mode.
Input Impedance		10 MΩ ±0.5% paralleled by <60 pF.
Input Terminals		Front panel (EXT) or rear interface (INT). Switch selectable.
Maximum Input Voltage Front Panel Terminals VOLTS/Ω to LOW VOLTS/Ω to Ground LOW to Ground		500 Vrms, not to exceed 1 kV peak. 500 Vrms, not to exceed 1 kV peak. 500 Vrms, not to exceed 1 kV peak.
Rear Interface Terminals Pin 28B to Pin 28A Pin 28B to Ground Pin 28A to Ground		Not to exceed 200 V peak. Not to exceed 200 V peak. Not to exceed 200 V peak.
Crest Factor		4 at full scale except ≤2 above 40 dB.
Reference Voltage dBV dBm		1 V. 0.7746 V (1 mW dissipated in 600 Ω).
Noise Level		Typically below -75 dB.

**Table 1-4  
OHMMETER**

Characteristics	Performance Requirements	Supplemental Information		
Accuracy for 200 $\Omega$ , 2 k $\Omega$ , 20 k $\Omega$ , 200 k $\Omega$ , 2000 k $\Omega$ , and 20 M $\Omega$ ranges.		Automatic or manual ranging.		
+18° C to +28° C 200 $\Omega$ to 2000 k $\Omega$ ranges 20 M $\Omega$ range	$\pm(0.5\%$ of reading + 0.05% of full scale + 0.2 $\Omega$ ). $\pm(1\%$ of reading + 0.05% of full scale).			
0° C to +18° C, +28° C to +50° C 200 $\Omega$ to 2000 k $\Omega$ ranges 20 M $\Omega$ range	$\pm(0.8\%$ of reading + 0.1% of full scale + 0.2 $\Omega$ ). $\pm(1.3\%$ of reading + 0.1% of full scale).			
Rear Interface	Add 0.5 $\Omega$ to the front-panel accuracies stated for the 200 $\Omega$ to 2000 k $\Omega$ ranges.			
Response Time		<1 second within any range. Add 1.5 seconds for each range change in the AUTO mode.		
Input Terminals		Front panel (EXT) or rear interface (INT). Switch selectable.		
Maximum Input Volts		130 Vdc or ac rms indefinitely. 230 Vdc or ac rms for 1/2 hour (200 V peak at rear interface).		
Measuring Current and Full Scale Volts		<b>Range</b>	<b>HI-OHMS Current</b>	<b>Full Scale Voltage</b>
		200 $\Omega$ 2 k $\Omega$ 20 k $\Omega$ 200 k $\Omega$ 2000 k $\Omega$ 20 M $\Omega$	1 mA 1 mA .1 mA 10 $\mu$ A 1 $\mu$ A .1 $\mu$ A	0.2 V 2.0 V 2.0 V 2.0 V 2.0 V 2.0 V
		<b>Range</b>	<b>LO-OHMS Current</b>	<b>Full Scale Voltage</b>
		200 $\Omega$ 2 k $\Omega$ 20 k $\Omega$ 200 k $\Omega$ 2000 k $\Omega$ 20 M $\Omega$	1 mA .1 mA 10 $\mu$ A 1 $\mu$ A .1 $\mu$ A .1 $\mu$ A	0.2 V 0.2 V 0.2 V 0.2 V 0.2 V 2.0 V
Maximum Resolution		100 m $\Omega$ .		
Maximum Open Circuit Voltage		14 V.		

**Table 1-5  
DC AMMETER**

Characteristics	Performance Requirements	Supplemental Information	
Accuracy for 200 $\mu$ A, 2 mA, 20 mA, 200 mA and 2000 mA ranges:		Manual ranging only.	
Front Panel only			
+18°C to +28°C	$\pm(0.2\%$ of reading + 0.05% of full scale).		
0°C to +18°C, +28°C to +50°C	$\pm(0.3\%$ of reading + 0.1% of full scale).		
Response Time		<1 second.	
Maximum Open Circuit Input Voltage mA to LOW terminals		250 V peak.	
Maximum Input Current		2 A on any range.	
Input Terminals		Front panel input only.	
Input Resistance		Range	Resistance
		200 $\mu$ A	1 k $\Omega$
		2 mA	100 $\Omega$
		20 mA	10.2 $\Omega$
		200 mA	1.2 $\Omega$
2000 mA	0.4 $\Omega$		
Maximum Floating Voltage mA terminal to Ground		1000 V peak.	
LOW terminal to Ground		1000 V peak.	

**Table 1-6  
AC AMMETER (TRUE RMS)**

Characteristics	Performance Requirements	Supplemental Information	
Accuracy for 200 $\mu$ A, 2 mA, 20 mA, 200 mA and 2000 mA ranges:		Manual ranging only.	
Front Panel			
40 to 10 kHz Sine wave			
+18°C to +28°C	$\pm(0.6\%$ of reading + 0.3% of full scale).	Useable to 20 kHz.	
0°C to +18°C, +28°C to +50°C	$\pm(0.7\%$ of reading + 0.5% of full scale).		
Response Time		<1 second.	
Maximum Open Circuit Input Voltage mA to LOW terminals		250 V peak.	
Maximum Input Current		2 A on any range.	
Input Terminals		Front panel input only.	
Input Resistance		Same as for dc ammeter.	
Maximum Floating Voltage mA terminal to Ground		1000 V peak.	
LOW terminal to Ground		1000 V peak.	

**Table 1-7  
TEMPERATURE**

Characteristics	Performance Requirements	Supplemental Information
Accuracy for the $-55^{\circ}\text{C}$ to $+200^{\circ}\text{C}$ range:		Manual ranging only.
+18 $^{\circ}\text{C}$ to +28 $^{\circ}\text{C}$ Ambient P6601 Probe calibrated to instrument	$\pm 2.5^{\circ}\text{C}$ from $-55^{\circ}\text{C}$ to $+150^{\circ}\text{C}$ . $\pm 3.5^{\circ}\text{C}$ from $+150^{\circ}\text{C}$ to $+200^{\circ}\text{C}$ .	
Any P6601 probe	$\pm 4.5^{\circ}\text{C}$ from $-55^{\circ}\text{C}$ to $+150^{\circ}\text{C}$ . $\pm 5.5^{\circ}\text{C}$ from $+150^{\circ}\text{C}$ to $+200^{\circ}\text{C}$ .	
0 $^{\circ}\text{C}$ to +18 $^{\circ}\text{C}$ , +28 $^{\circ}\text{C}$ to +50 $^{\circ}\text{C}$ Ambient Probe calibrated to instrument	$\pm 4^{\circ}\text{C}$ from $-55^{\circ}\text{C}$ to $+150^{\circ}\text{C}$ . $\pm 5^{\circ}\text{C}$ from $+150^{\circ}\text{C}$ to $+200^{\circ}\text{C}$	
Any probe	$\pm 6^{\circ}\text{C}$ from $-55^{\circ}\text{C}$ to $+150^{\circ}\text{C}$ . $\pm 7^{\circ}\text{C}$ from $+150^{\circ}\text{C}$ to $+200^{\circ}\text{C}$ .	
Input Terminals		Front panel only.

**Table 1-8  
MISCELLANEOUS**

Characteristics	Description
Power Consumption	Approximately 8 W.
Reading Rate	3 per second.
Over-Range Indication	Flashing display except 1000 Vdc and 500 Vac ranges.
Warm-up Time	30 minutes (60 minutes after storage in high humidity environment).

## ENVIRONMENTAL CHARACTERISTICS

Table 1-9  
ENVIRONMENTAL<sup>a</sup>

Characteristics	Description	
Temperature Operating Nonoperating	0°C to +50°C <sup>b</sup> -55°C to +75°C	Test to MIL-T-28800B, class 5 with exceptions <sup>d</sup> .
Humidity Operating Nonoperating	+30°C and +50°C to 90%, +5 -0% <sup>b</sup> +30°C to +60°C to 90%, +5 -0%	Test to MIL-T-28800B, class 5.
Altitude Operating Nonoperating	4.5 km (15,000 ft.) <sup>b</sup> 15 km (50,000 ft.)	Test to MIL-T-28800B, class 3.
Vibration Operating	0.64 mm (0.025") disp., 5-55-5 Hz <sup>a/c</sup> (sine wave) 75 min. total	Test to MIL-T-28800B, class 3.
Shock Nonoperating	50 g's (1/2 sine) 11 ms <sup>a/c</sup> 18 shocks	Test to MIL-T-28800B, class 3.
Bench Handling Operating	45° or 4" or equilibrium <sup>c</sup> , whichever occurs first.	Test to MIL-T-28800B, class 3.
E.M.C. Operating	30 Hz to 1 GHz <sup>b</sup>	Test to MIL-T-28800B, class 3.
Electrical Discharge Operating	20 kV max. <sup>b</sup>	Charge applied to each protruding area of the product under test except the input terminals. No MIL-T-28800 equivalent.
Transportation		Qualified under National Transit Association Pre-shipment Test Procedures Project: 1A-B-1 and 1A-B-2.

<sup>a</sup> See Table 1-10 for system modifiers.

<sup>b</sup> With power module.

<sup>c</sup> Without power module.

<sup>d</sup> Temperature: During low temperature test MIL-T-28800B, paragraph 4.5.5.1.3(b) for class 5, steps 4 and 5 shall be performed before step 2. Also, the instrument shall not be operating during step 6, paragraph 4.5.5.1.3(e), class 5. While operating, condensed moisture shall not be present on class 5 instruments. Drying of the instrument for this class may be performed in a suitable chamber, if necessary.

**Table 1-10**  
**TM 500 SYSTEMS**  
**ENVIRONMENTAL SPECIFICATIONS**

<b>Characteristics</b>	<b>TM 501</b>	<b>TM 503</b>	<b>TM 504</b>	<b>TM 506</b>	<b>TM 515</b>
Temperature Operating Nonoperating	Meets same test standards as plug-in.				
Humidity Operating Nonoperating	Meets same test standards as plug-in.				
Altitude Operating Nonoperating	Meets same test standards as plug-in.				
Vibration Operating	0.26 mm (0.010 in) disp., 10-55 Hz (sine wave) 75 min. total			0.38 mm (0.015 in) disp. 10-55 Hz (sine wave) 75 min.	
Shock Operating	20 g's (1/2 sine) 11 ms, 18 shocks			30 g's (1/2 sine) 11 ms, 18 shocks	
Bench Handling Operating	Meets same test standards as plug-in.				
Electric Discharge Operating	Meets same test standards as plug-in.				
Transportation Vibration Package Drop	Meets same test standards as plug-in.				

**Table 1-11**  
**PHYSICAL CHARACTERISTICS**

<b>Characteristics</b>	<b>Description</b>
Finish	Anodized aluminum panel and chassis
Net Weight	≈2.5 lbs. (1.13 kg).
Overall Dimensions	2.633 in (66.8 mm) W x 11.240 in (285.3 mm) D x 4.961 in (125.9 mm) H.





# OPERATING INSTRUCTIONS

## Installation and Removal

The DM 502A is calibrated and ready for use when received. It operates in any compartment of a TM 500 series power module. See the power module instruction manual for line voltage requirements and power module operation. Figure 2-1 shows the DM 502A installation and removal procedure.

### CAUTION

*Turn the power module off before inserting the DM 502A. Otherwise, arcing may occur at the rear interface connectors, reducing their useful life and damage may be done to the plug-in circuitry.*

Before installing the DM 502A in the power module, make certain that the internal jumper is set for the desired dB mode of operation, dBm, or dBV. Refer the setting of this jumper to qualified personnel.

Check to see that the plastic barriers on the interconnecting jack of the selected power module compartment match the cutouts in the DM 502A circuit board edge connector. Align the DM 502A chassis with the upper and lower guides of the selected compartment. Press the DM 502A in and firmly seat the circuit board in the interconnecting jack.

To remove the DM 502A pull the release latch (located in the lower left corner) until the interconnecting jack disengages and the DM 502A slides out.

Check that the DM 502A is fully inserted in the power module. Pull the power switch on the power module. One or more characters in the LED display should now be visible.

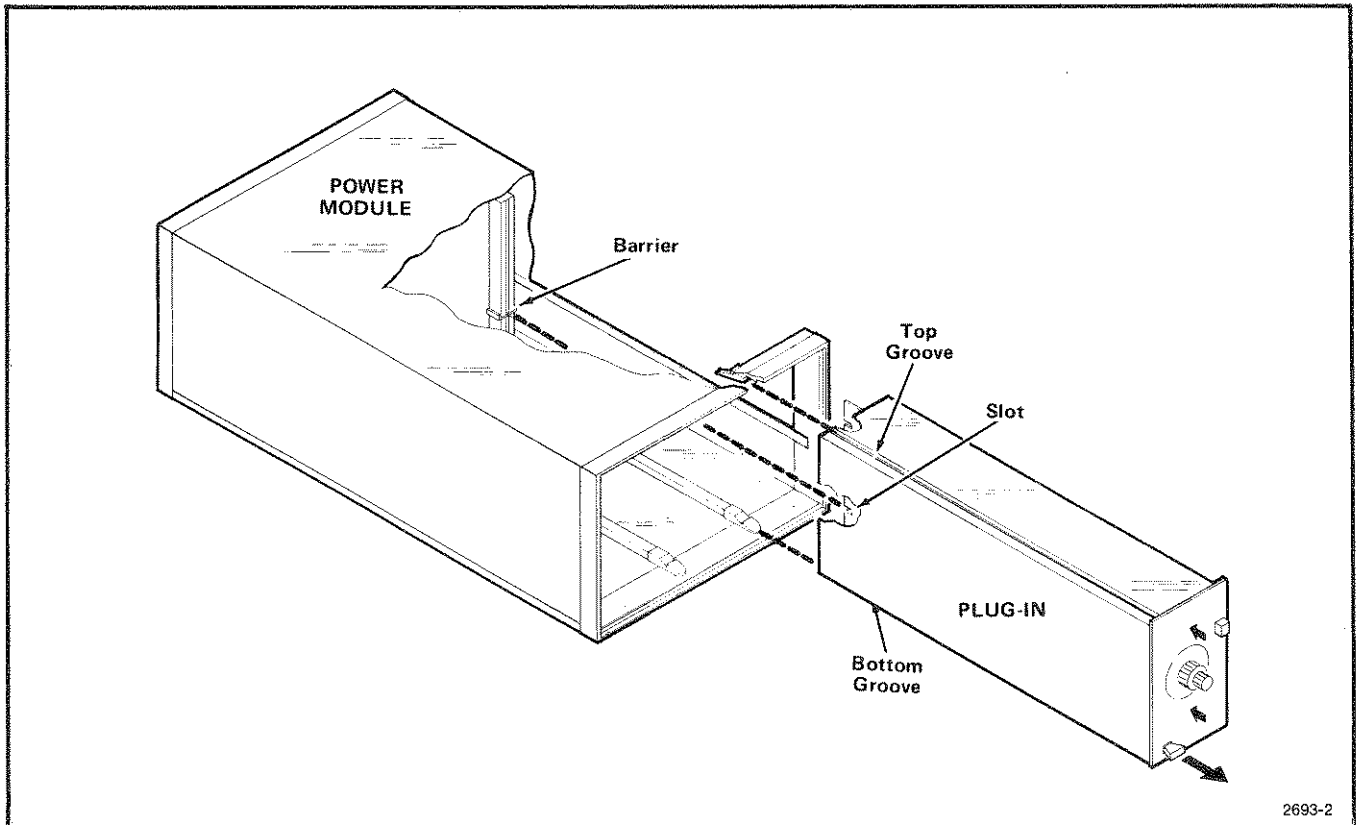



Fig. 2-1. Installation and removal.

**Controls, Connectors, and Indicators**

All controls, connectors, and indicators (except for the rear interface connector and the internal jumper used to select readout for the dBm or dBV modes) required for operation of the DM 502A are located on the front panel. Figure 2-2 provides a brief description of all front-panel controls, connectors, and indicators.



- 1 Display**  
 3 1/2 digit LED readout with properly positioned decimal point. Special scale factors are illuminated by separate LEDs.
- 2  $\mu$ A**  
 Illuminated when units are microamperes.
- 3 mV**  
 Illuminated when units are millivolts.
- 4  $\Omega$**   
 Illuminated when units are Ohms.
- 5 M $\Omega$**   
 Illuminated when units are megohms.
- VOLTS**
- 6 DC**  
 Selects dc voltage ranges.
- 7 VOLTS AC TRUE RMS**  
 Selects ac voltage ranges.

**dBm/dBV**   
 See Decibel Measurements on page 2-4.
- 8 dB**  
 Selects dB ranges when depressed along with AC VOLTS TRUE RMS. Reference dBm or dBV is internally selectable.
- 9 k $\Omega$**   
 Selects resistance measuring ranges.
- 10 HI-LO**  
 Button in selects full scale voltage as 0.2 in all ranges except 20 M $\Omega$  which is 2 V. Button out selects full scale voltage as 2 except in 200  $\Omega$  range which is 0.2 V.

- mA**
- 11 DC**  
 Selects dc current measuring range.
- 12 AC**  
 Selects ac current measuring ranges.
- 13 INPUT EXT-INT**   
 Button out selects front panel input; button in selects rear interface input for dc and ac volts, resistance and current measurements only.



*The maximum input voltage is 1 kV peak at the front panel connectors and 200 V peak at the rear interface connectors. The front panel VOLTS/ $\Omega$  and LOW connectors may be floated 1 kV maximum above ground, the rear input connectors 200 V.*

- 14 TEMP  $^{\circ}$ C**  
 Select temperature readout in  $^{\circ}$ C.
- 15 mA**   
 Use in conjunction with LOW terminal for current measurements.
- 16 LOW**   
 Common terminal for all inputs except temperature.
- 17 TEMP**  
 Connect temperature probe to this terminal.
- 18 Ground Terminal**  
 Chassis ground.
- 19 VOLTS/ $\Omega$**    
 Use in conjunction with LOW terminal for voltage and resistance measurements.
- 20 AUTO (20 M $\Omega$ )**  
 Selects automatic ranging for dc and ac voltage, dB and resistance. The 20 M $\Omega$  range is available only in the automatic mode.
- 21 Range Select Pushbuttons**  
 Press these buttons to select the desired measurement ranges.

## CONTROL AND CONNECTORS

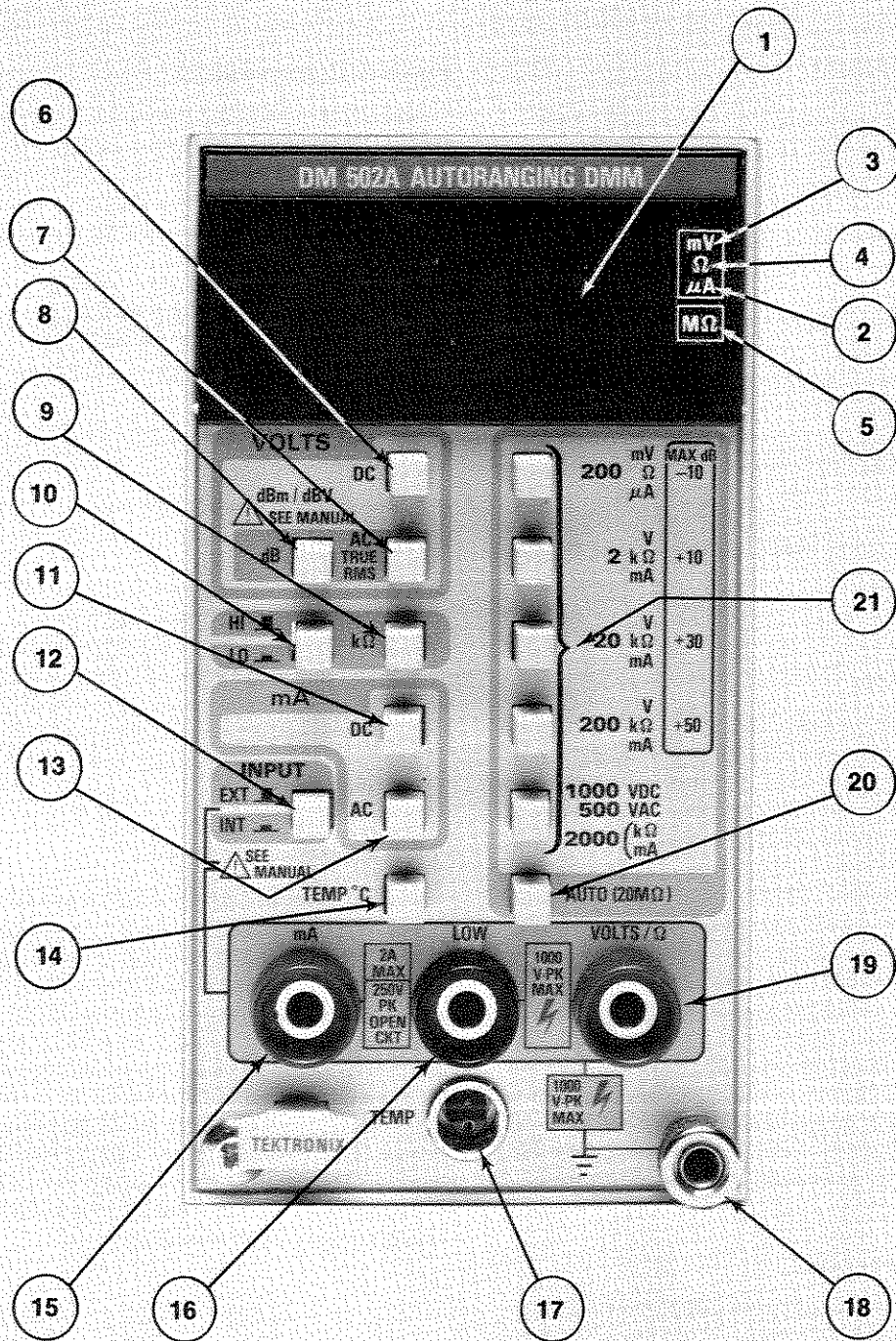

2693-3

Fig. 2-2. Front panel controls and connectors.

## Input Connections



If the INPUT button is pressed, signal inputs are made via the rear interface connector (INT); if the button is out, signal inputs are made via the front panel connector (EXT).



*The maximum input voltage is 1 kV peak at the front panel connectors and 200 V peak at the rear interface connectors. The front panel VOLTS/Ω and LOW connectors may be floated 1 kV maximum above ground, the rear input connectors 200 V.*

Three input jacks provide measurement connections. The VOLTS/Ω and LOW input jacks are normally used for all measurements except current and temperature. Normal measurement conditions will be with the LOW terminal ungrounded. A connection between the LOW and GND input jack post may be made to reference the input against DM 502A chassis ground. Use caution, as the LOW terminal is then connected to earth ground through the three-wire power cord. False readings may be obtained due to ground loops.

## Making Measurements

With the DM 502A properly installed in the power module, allow 30 minutes warmup time for operation to specified accuracy. Select the desired measurement mode: voltage, decibels, resistance, current, or temperature. Then select the desired measurement range or the automatic (AUTO) range in all modes except current and temperature. When the value of the measurand is unknown, use the automatic mode. Units of measurement are volts, decibels, kilohms, milliamperes or degrees centigrade unless the appropriate suffix μA (microamperes), mV (millivolts), Ω (Ohms) or MΩ (megohms) is illuminated at the right of the display. The decimal point is automatically positioned. To use the 20 MΩ range push the button marked AUTO (20 MΩ). If the autoranging feature is not desired, push the desired measurement range button. The measurement units are read the same as in the automatic mode of operation.

## Dc Voltage Measurements

Press the VOLTS DC pushbutton and AUTO or the desired measurement range button. Apply the voltage to be measured to the VOLTS/Ω and LOW connectors. Observe the maximum voltage ratings. The readout displays a + if the VOLTS/Ω input is positive with respect to the LOW input. A – is displayed if the LOW input is more positive. With the input shorted, the display reads zero, ± one count.

## Ac Voltage Measurements

Press the VOLTS AC TRUE RMS and AUTO or the desired measurement range button. Apply the voltage to be measured to the VOLTS/Ω and LOW connectors. Observe the maximum input voltage ratings.

## Decibel Measurements



Press the VOLTS AC TRUE RMS, dB, and AUTO or the desired measurement range pushbutton. The DM 502A will read directly in dBm or dBV depending on the position of the internal jumper. This jumper is located on the main board in the upper rear quadrant and is numbered P1517.

### WARNING

*Refer jumper change to qualified personnel.*

The formula for calculating dB from voltage is:

$$\text{dB} = 20 \log_{10} \frac{E_2}{E_1}$$

When the DM 502A is set for dBV, 1 V is the reference voltage ( $E_1$ ) in the formula and the instrument calculates and displays the dBV value. When the jumper is set for dBm, the reference voltage is 0.7746 V, the equivalent of 1 mW dissipated in 600 Ω. The unknown voltage is  $E_2$ .

## Resistance Measurements

Connect the resistance to be measured to the VOLTS/Ω and LOW input terminals. Select the maximum resistance measuring range desired by pressing the appropriate pushbutton or the AUTO pushbutton if automatic ranging is desired. Press the kΩ and the HI or LO pushbutton depending on the voltage desired at the measurement terminals. The voltage at the measurement terminals with the LO pushbutton pressed is 0.2 V in all ranges except 20 MΩ, which is 2.0 V. With the HI pushbutton pressed the voltage is 2.0 V in all ranges except 200 Ω which is 0.2 V. Use the LO ranges (lower voltage) for incircuit resistance measurements where diode junctions might be forward biased with the higher voltages.

## Current Measurements

Connect the ac or dc current to be measured to the mA and LOW input connections. Observe the maximum voltage ratings. Press the mA, DC, or AC pushbuttons and the current range desired. The DM 502A does not auto range in the current modes.

### Temperature Measurements

Connect the P6601 temperature probe to the front panel TEMP connector. Use care to align the connector pins. Press the TEMP °C button. For best accuracy calibrate the individual instrument to the probe used. Apply the probe sensor tip to the device being measured. For optimum temperature transfer, coat the surface of the device being measured with silicone grease and apply the probe tip squarely to the surface. Allow sufficient time for the probe tip to stabilize before taking a reading. The time required depends on several factors. Generally, when the tip is first applied to the device under test, the readings change less rapidly and finally stabilize.

See the P6601 manual for more information on temperature measurements and probe use.

### Repackaging Information

If the Tektronix instrument is to be shipped to a Tektronix Service Center for service or repair, attach a tag showing the owner (with address) and the name of an individual at your firm that can be contacted. Include the complete instrument serial number and a description of the service required.

Save and re-use the package in which your instrument was shipped. If the original packaging is unfit for use or not available, repackage the instrument as follows:

Surround the instrument with polyethylene sheeting to protect the finish of the instrument. Obtain a carton of corrugated cardboard of the correct carton strength and having inside dimensions of no less than six inches more than the instrument dimensions. Cushion the instrument by tightly packing three inches of dunnage or urethane foam between carton and instrument on all sides. Seal the carton with shipping tape or an industrial stapler.

The carton test strength for this instrument is 200 pounds per square inch.

