



**PLEASE CHECK FOR CHANGE INFORMATION
AT THE REAR OF THIS MANUAL.**

**SG 504
LEVELED
SINE WAVE
GENERATOR**

INSTRUCTION MANUAL

**Tektronix, Inc.
P.O. Box 500
Beaverton, Oregon 97077**

Serial Number _____

Copyright ©1976, 1978 Tektronix, Inc. All rights reserved.
Contents of this publication may not be reproduced in any
form without the written permission of Tektronix, Inc.

Products of Tektronix, Inc. and its subsidiaries are covered
by U.S. and foreign patents and/or pending patents.

TEKTRONIX, TEK, SCOPE-MOBILE, and  are reg-
istered trademarks of Tektronix, Inc.

Printed in U.S.A. Specification and price change privileges
are reserved.

TABLE OF CONTENTS

		Page
SECTION 1	OPERATING INSTRUCTIONS French Version German Version Japanese Version	1-1
SECTION 2	SPECIFICATION AND PERFORMANCE CHECK	2-1

WARNING

The remaining portion of this Table of Contents lists servicing instructions that expose personnel to hazardous voltages. These instructions are for qualified service personnel only.

SECTION 3	ADJUSTMENT	3-1
SECTION 4	MAINTENANCE AND INTERFACING INFORMATION	4-1
SECTION 5	CIRCUIT DESCRIPTION	5-1
SECTION 6	OPTIONS	6-1
SECTION 7	REPLACEABLE ELECTRICAL PARTS	7-1
SECTION 8	DIAGRAMS AND CIRCUIT BOARD ILLUSTRATION	8-1
SECTION 9	REPLACEABLE MECHANICAL PARTS AND EXPLODED VIEW	9-1
CHANGE INFORMATION		

SAFETY SUMMARY

The following text contains a two-part summary of general safety precautions that must be observed during all phases of operation, service, and repair of this instrument.

OPERATIONS SAFETY SUMMARY

The general safety information in this part of the summary is for both operating and servicing personnel. Specific warnings and cautions may be found throughout the manual where they apply, but may not appear in this summary.

TERMS

In This Manual:

WARNING statements identify conditions or practices that could result in personal injury or loss of life.

CAUTION statements identify conditions or practices that could result in damage to the equipment or other property.

As Marked on Equipment:

CAUTION indicates a personal injury hazard not immediately accessible as one reads the marking, or a hazard to property including the equipment itself.

DANGER indicates a personal injury hazard immediately accessible as one reads the markings.

SYMBOLS

In This Manual:



This symbol indicates where applicable cautionary or other information is to be found.

As Marked on Equipment:



DANGER—High Voltage.



Protective ground (earth) terminal.



ATTENTION—refer to manual.

Grounding the Power Module

This instrument is grounded through the grounding conductor of the power module. To avoid electrical shock, plug the power module cord into a properly wired receptacle before connecting to the instrument input or output terminals.

Do not use the power cord grounding conductor as the only grounding connection between two or more devices. To avoid electrical shock, connect the grounding terminals together with separate conductors.

Use the Proper Power Cord

Use only the power cord and connector specified for the power module. Use only a power cord that is in good condition.

For detailed information on power cords and connectors, see the power module manual.

Refer cord and connector changes to qualified service personnel.

Use the Proper Fuse

To avoid fire hazard, use only the fuse specified in the parts list for your instrument, and which is identical in type, voltage rating, and current rating.

Refer fuse replacement to qualified service personnel.

Do Not Operate in Explosive Atmospheres

To avoid explosion, do not operate this instrument in an atmosphere of explosive gases unless it has been specifically certified for such operation.

Do Not Remove Covers or Panels

To avoid personal injury, do not remove the instrument covers or panels. Do not operate the instrument without the covers and panels properly installed.

Do Not Operate Without Covers

To avoid personal injury, do not operate this instrument without covers or panels installed. Do not apply power to the instrument via a plug-in extender.

SERVICING SAFETY SUMMARY

FOR QUALIFIED SERVICE PERSONNEL ONLY

Refer also to the preceding Operators Safety Summary.

Do Not Service Alone

Do not perform internal service or adjustment of this instrument unless another person capable of rendering first aid and resuscitation is present.

Use Care When Servicing With Power On

Dangerous voltages exist at several points in this instrument. To avoid personal injury, do not touch exposed connections and components while power is on.

Disconnect power before removing protective panels, soldering, or replacing components.

Power Source

The power module is intended to operate from a power source that will not apply more than 250 volts between the supply conductors or between either supply conductor and ground. A protective ground connection by way of the grounding conductor in the power cord is essential.

SG 504

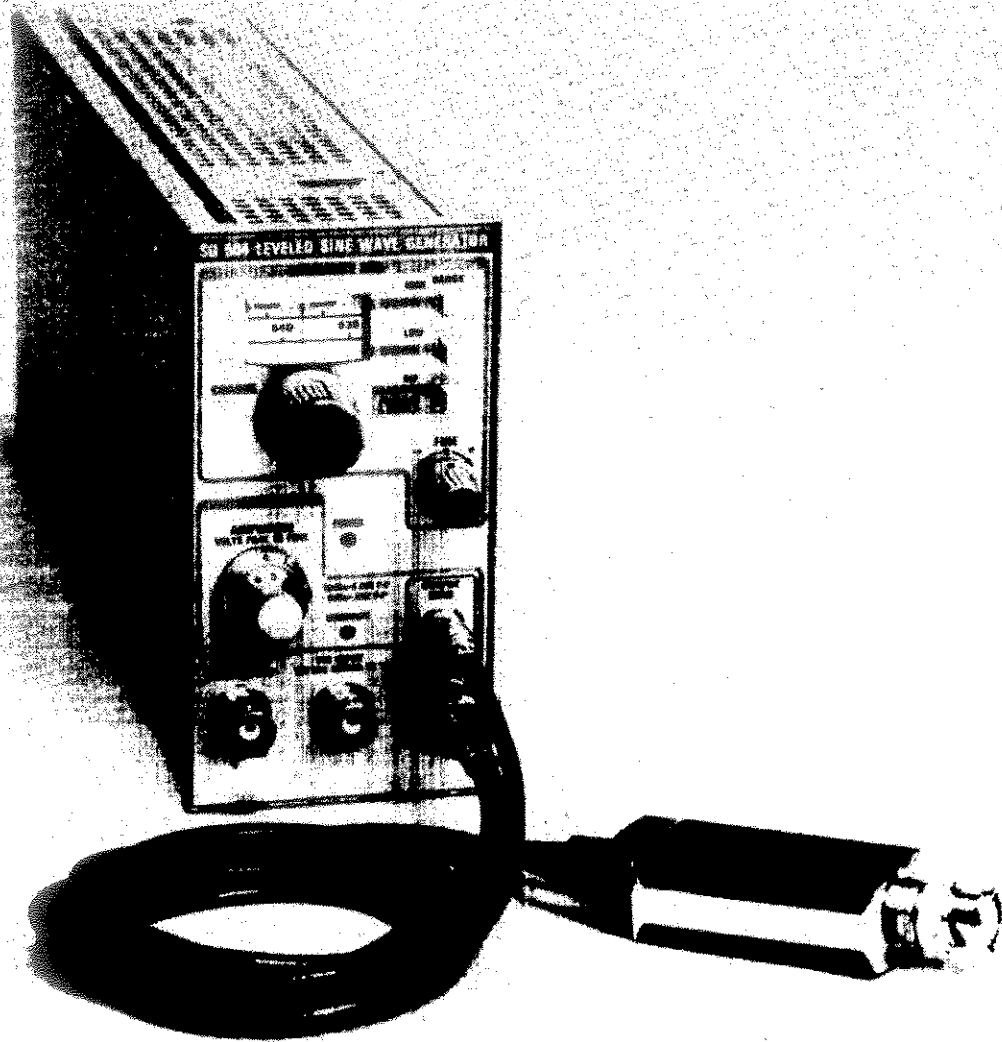

1632-01

SG 504 Levelled Sine Wave Generator.

OPERATING INSTRUCTIONS

Description

The SG 504 provides a constant-amplitude sine wave over a frequency range from 245 MHz to 1050 MHz. Amplitude-reference sine waves of .05 MHz or 6.0 MHz (selected by internal switch) are provided. The output head has an output impedance of 50 ohms. The peak-to-peak voltage from the output head is adjusted by a calibrated five-turn potentiometer. The SG 504 Leveled Sine Wave Generator is designed for use in the TM 500 series power modules.

The front-panel FREQUENCY MONITOR OUT connector provides at least a 0.3 V peak-to-peak signal at the selected output frequency (245 to 1050 MHz) for monitoring or external triggering. There is also a provision for frequency modulating the 245 to 1050 MHz output signal. When lit, the UNLEVELED light indicates a mismatched load or when the OUTPUT AMPLITUDE front-panel control should be turned counterclockwise. When the output head is disconnected from the front panel, the UNLEVELED light is also illuminated.

Rear interface connections are provided for the FM INPUT, FREQUENCY MONITOR OUT, and amplitude control. If the rear interface is used, these front panel features must be disconnected. They cannot both be used at once. For further information about the interface assignments, see Section 4, Maintenance and Interfacing Information, of this manual.

Installation and Removal

CAUTION

Turn the power module off before inserting the plug-in and before connecting the output head to the SG 504 front-panel connectors; otherwise, damage may occur to the plug-in circuitry. It is also recommended that the power module be turned off before removing the SG 504. Refer to Fig. 1-1. If it becomes necessary to install the output head cables after the instrument has been turned on, make sure the four-pin connector is inserted first. Then, connect the bnc coaxial connector. Check to see that the plastic barriers on the interconnecting jack of the selected power module compartment match the cut-outs in the SG 504 circuit board edge connector.

Align the SG 504 chassis with the upper and lower guides of the selected compartment. Push the module in and press firmly to seat the circuit board in the interconnecting jack.

To remove the SG 504, pull on the release latch located in the lower left corner, until the interconnecting jack disengages and the SG 504 will slide out.

Controls and Connectors

Refer to Fig. 1-2. Even though the SG 504 is fully calibrated and ready to use, the functions and actions of the controls and connectors should be reviewed before attempting to use the instrument. Pull the Power switch on the power module to apply power to the SG 504. The POWER indicator light indicates when power is applied to the SG 504.

Except for very early models of the SG 504, the front panel bears the inscription:



This symbol is to direct the operator to read the operating instructions to avoid a hazardous situation.

CAUTION

When using the crank on the FREQUENCY MHz dial, observe the stop notations on the dial tape. To prevent possible internal damage or miscalibration, do not force the knob hard against the mechanical stops.

OPERATING CONSIDERATIONS

Overheating

The SG 504 is designed to operate at an ambient temperature from 0°C to +50°C. However, when operating several power supplies in a multi-plug-in power module, especially at high line voltages, or when operating close to other heat-producing equipment, internal temperature may exceed safe limits and actuate a thermal cutout in the power module. Refer to the power module instruction manual for more complete information.

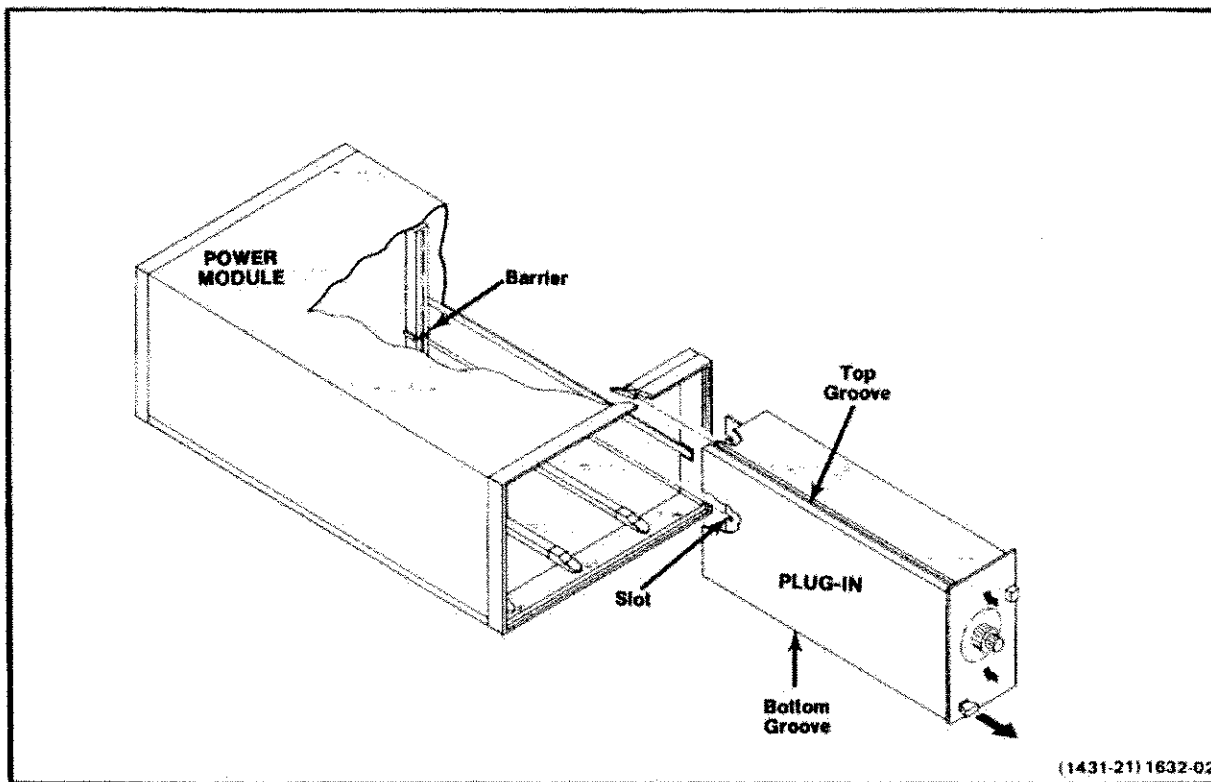

(1431-21) 1632-02

Fig. 1-1. Plug-in module installation/removal.

CAUTION

If the SG 504 is left in a power on state for long periods of time, turn the OUTPUT AMPLITUDE control to less than 3 volts output amplitude. In all cases, reduce the output amplitude to less than 3 volts when the output head is unterminated. This procedure prolongs instrument life.

Connect the properly terminated output head to the device under test. If the front-panel UNLEVELED light comes on, turn the OUTPUT AMPLITUDE control counterclockwise until the light goes out. Output heads may be interchanged and will perform within specifications; however, optimum performance is obtained by not changing heads after calibration.

Output Loading

The SG 504 is designed to operate into a 50-ohm impedance. If the load is a much greater impedance than 50-ohm, connect a feed-through termination to the output head and then make connection to the load. Refer to Fig. 1-3(B) for reference.

It is important to minimize adapter and transmission line discontinuities and reflections. Adding coaxial cable between the output head and the load impairs the constant amplitude function, since transmission line insertion losses vary with frequency.

NOTE

When lit, the UNLEVELED light on the front panel indicates a mismatched load or when the OUTPUT AMPLITUDE control should be turned counterclockwise. When the output head is disconnected from the front panel, the UNLEVELED light is also illuminated.

If there is a dc voltage across the load, use a dc blocking capacitor between the output head and the load. A dc blocking capacitor, listed in the Accessories section of this manual, can be used for frequencies from 6 to 1050 MHz.

If signal amplitudes less than the minimum (0.5 V p-p) are desired, use appropriate attenuators connected between the output head and the device under test.

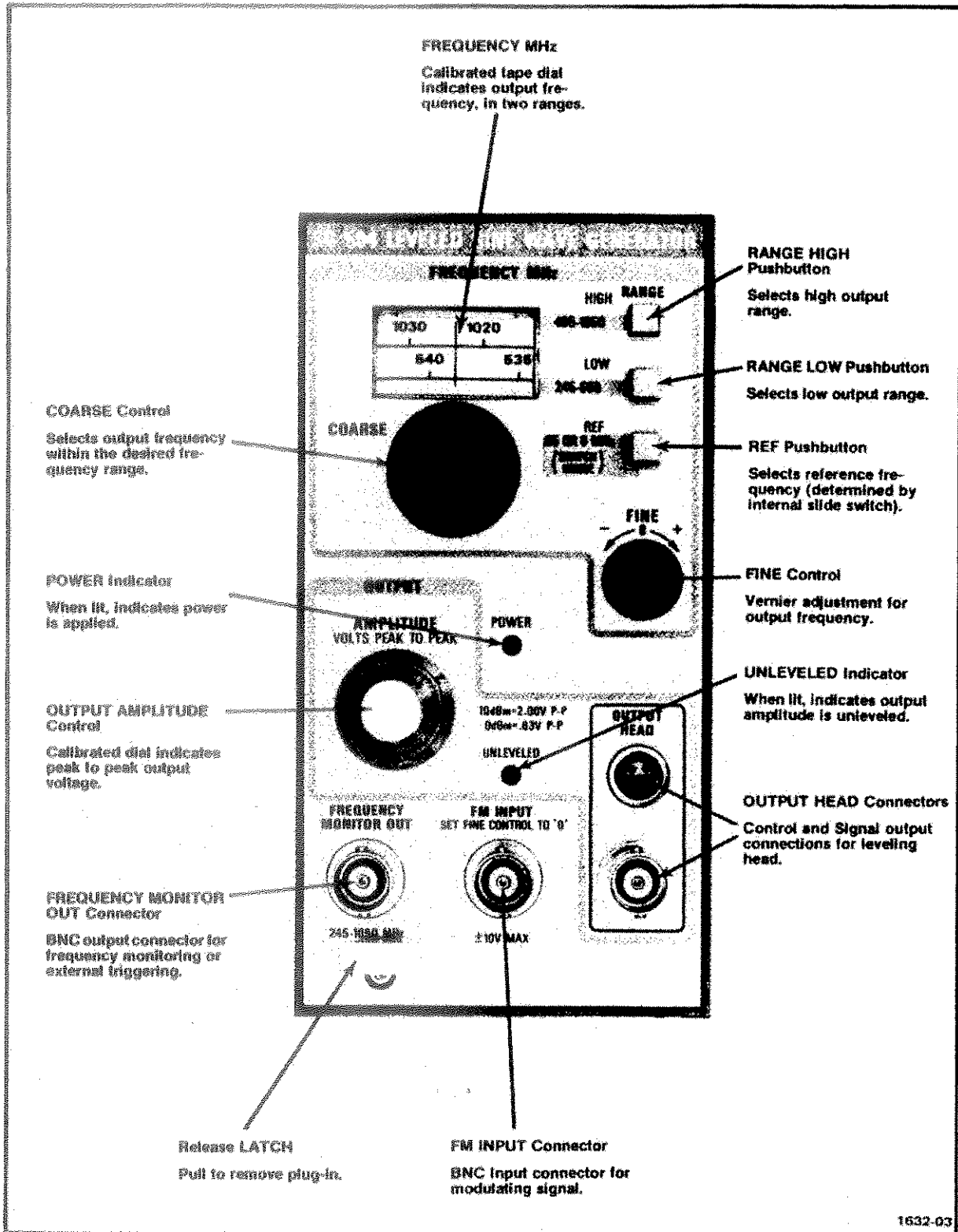

Fig. 1-2. SG 504 controls and connectors.

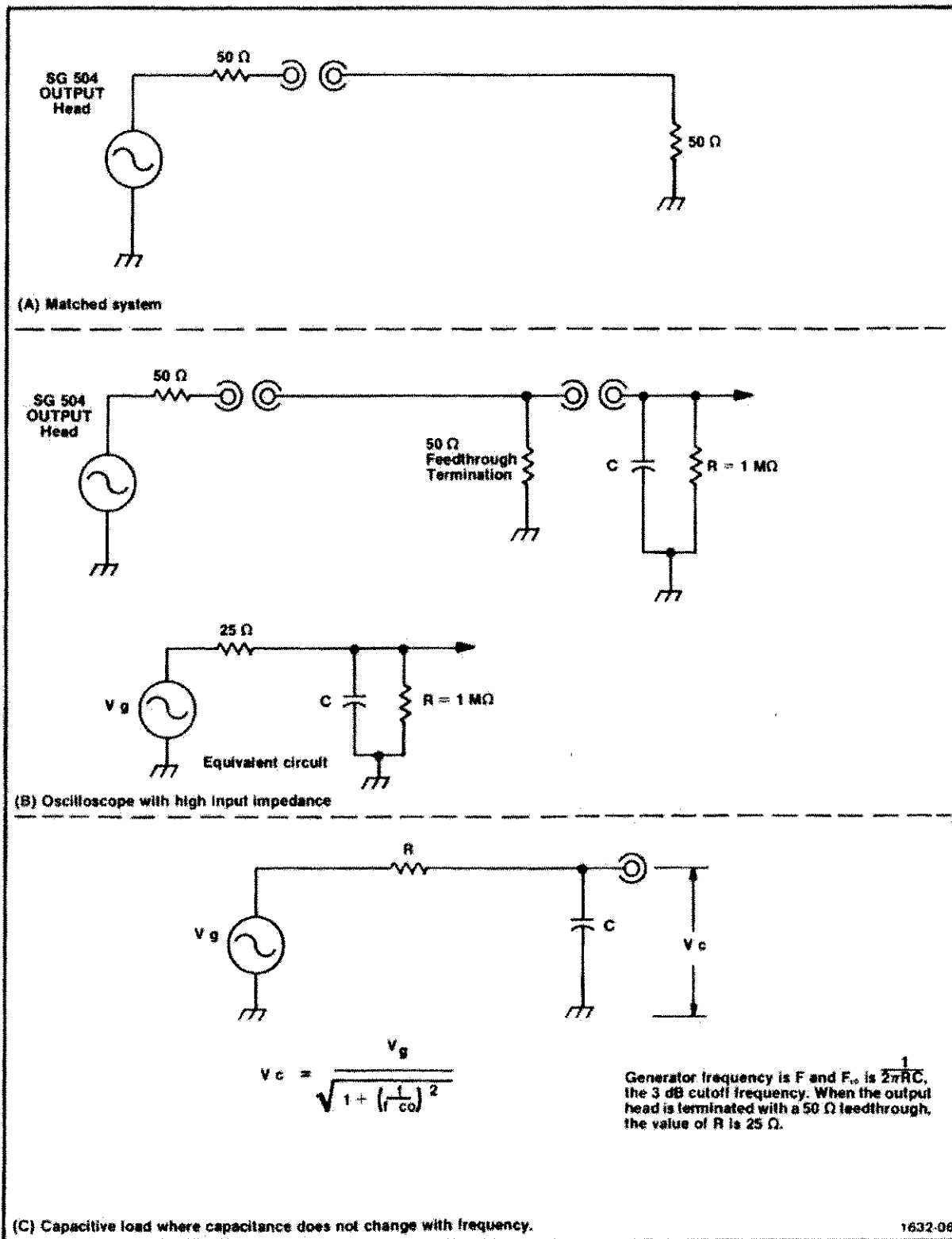

Fig. 1-3. Equivalent circuits for SG 504, 50-ohm coaxial cable and various terminations.

NOTE

Tektronix attenuators with -02 suffix are recommended. Other attenuators may be used; however, measurement accuracy may be compromised.

When operating the SG 504, always consider the total load impedance and its effect on the output amplitude. The input capacitance of the equipment under test will affect the bandwidth. The equivalent circuit shown in Fig. 1-3(C) is useful in estimating the amplitude changes caused by capacitive loads. Note that as system input capacitance increases, bandwidth decreases.

WARNING

When the SG 504 is energized, hazardous voltages exist at some of the circuit board terminals. Before changing the reference frequency with the internal slide switch, be sure to disconnect the power to the SG 504. Refer to Fig. 3-1 for internal switch location.

Bandpass Measurements

To measure the bandpass of an oscilloscope or other device, connect the output head to the device. Select the reference frequency (0.05 MHz or 6.0 MHz), using the internal slide switch on the main board. Push the front panel REF pushbutton. Adjust the OUTPUT AMPLITUDE

control for the desired amplitude. Now push either the HIGH or LOW RANGE pushbuttons and adjust the COARSE frequency control until the amplitude equals 0.707 times the reference deflection. The frequency is now the 3 dB down frequency of the device under test. If bandpass measurements are made at different ambient temperatures, recheck the reference amplitude.

When frequency accuracy better than 2% is required, connect a frequency counter to the FREQUENCY MONITOR OUT connector. The signal available at this connector is the same frequency as the output and its use does not load or affect the amplitude of the signal from the output head. However, the output head must remain connected to the load for this frequency measurement to be accurate.

Frequency Modulated Output

To frequency modulate the output, connect the modulating signal to the FM INPUT connector on the front panel. Set the front panel FREQUENCY MHz FINE control to zero. Set the OUTPUT AMPLITUDE control below approximately 3 V peak to peak. This is desirable because at higher levels the frequency may shift slightly with changes in the AMPLITUDE control settings. The FM INPUT and the FREQUENCY MHz FINE control drive the same summing point. Consequently, the maximum frequency deviation + and - at a particular frequency, can be demonstrated by turning the FINE control fully cw and then fully ccw and noting the frequency change. The FINE control range is equivalent to approximately a ± 9 V change at the FM INPUT. Do not use more than ± 9 V at the FM INPUT. Linear deviation is assured below ± 1 V input.

NOTE

Tektronix attenuators with -02 suffix are recommended. Other attenuators may be used; however, measurement accuracy may be compromised.

When operating the SG 504, always consider the total load impedance and its effect on the output amplitude. The input capacitance of the equipment under test will affect the bandwidth. The equivalent circuit shown in Fig. 1-3(C) is useful in estimating the amplitude changes caused by capacitive loads. Note that as system input capacitance increases, bandwidth decreases.

WARNING

When the SG 504 is energized, hazardous voltages exist at some of the circuit board terminals. Before changing the reference frequency with the internal slide switch, be sure to disconnect the power to the SG 504. Refer to Fig. 3-1 for internal switch location.

Bandpass Measurements

To measure the bandpass of an oscilloscope or other device, connect the output head to the device. Select the reference frequency (0.05 MHz or 6.0 MHz), using the internal slide switch on the main board. Push the front panel REF pushbutton. Adjust the OUTPUT AMPLITUDE

control for the desired amplitude. Now push either the HIGH or LOW RANGE pushbuttons and adjust the COARSE frequency control until the amplitude equals 0.707 times the reference deflection. The frequency is now the 3 dB down frequency of the device under test. If bandpass measurements are made at different ambient temperatures, recheck the reference amplitude.

When frequency accuracy better than 2% is required, connect a frequency counter to the FREQUENCY MONITOR OUT connector. The signal available at this connector is the same frequency as the output and its use does not load or affect the amplitude of the signal from the output head. However, the output head must remain connected to the load for this frequency measurement to be accurate.

Frequency Modulated Output

To frequency modulate the output, connect the modulating signal to the FM INPUT connector on the front panel. Set the front panel FREQUENCY MHz FINE control to zero. Set the OUTPUT AMPLITUDE control below approximately 3 V peak to peak. This is desirable because at higher levels the frequency may shift slightly with changes in the AMPLITUDE control settings. The FM INPUT and the FREQUENCY MHz FINE control drive the same summing point. Consequently, the maximum frequency deviation + and - at a particular frequency, can be demonstrated by turning the FINE control fully cw and then fully ccw and noting the frequency change. The FINE control range is equivalent to approximately a ± 9 V change at the FM INPUT. Do not use more than ± 9 V at the FM INPUT. Linear deviation is assured below ± 1 V input.

SPECIFICATION AND PERFORMANCE CHECK

SPECIFICATION

Performance Conditions

The electrical characteristics are valid only if the SG 504 has been calibrated at an ambient temperature between +20°C and +30°C and is operating at an ambient temperature between 0°C and +50°C unless otherwise noted.

Items listed in the Performance Requirements column of the Electrical Characteristics are verified by completing the Performance Check in this manual. Items listed in the Supplemental Information column are not verified in this manual; they are either explanatory notes or performance characteristics for which no limits are specified.

Table 2-1

ELECTRICAL CHARACTERISTICS

Characteristics	Performance Requirements	Supplemental Information
Frequency Range	245 MHz to 1050 MHz in two ranges, plus 50 kHz to 6 MHz reference Frequency.	50 kHz and 6 MHz reference frequency selected by internal slide switch.
Accuracy	±2% of dial indication.	
Amplitude Accuracy	Within 3% of indicated amplitude at reference frequency.	
Amplitude Flatness	Within 4% of the value at 50 kHz or 6 MHz reference frequency.	Flatness is referenced to the NBS corrections of Tektronix standards. Uncertainties of the NBS are not included in this specification. This specification applies with output head between -15°C and +55°C ambient.
Leveled Amplitude Range	0.5 V to at least 4.0 V p-p 0.5 V to 5.0 V p-p for loads with VSWR less than 1.2:1 from 0°C to +35°C.	
Harmonic Content	Harmonic suppression relative to fundamental; 2nd harmonic at least 25 dB down; 3rd and all higher harmonics typically at least 40 dB down.	
Frequency Monitor Output	At least 0.3 V p-p into 50 Ω load from 245 to 1050 MHz only.	
Residual Fm		Typically less than 1 part per million.

Table 2-1 (cont)

Characteristics	Performance Requirements	Supplemental Information
Fm Input Deviation		Deviation sensitivity: ± 9 V produces from $\pm 0.05\%$ to $\pm 0.4\%$ deviation of carrier, depending on output frequency.
Frequency Range		Dc to 100 kHz.
Input Resistance		50 k Ω .

Table 2-2

ENVIRONMENTAL CHARACTERISTICS

Characteristics	Information
Temperature Operating	0°C to +50°C.
Storage	-40°C to +75°C.
Altitude Operating	To 15,000 feet; maximum operating temperature decreased by 1°C/1,000 feet from 5,000 to 15,000 feet.
Storage	To 50,000 feet.
Vibration Operating and Non-operating	With the instrument complete and operating, vibration frequency swept from 10 to 55 to 10 Hz at 1 minute per sweep. Vibrate 15 minutes in each of the three major axes at 0.015 inch total displacement. Hold 10 minutes at any major resonance, or if none, at 55 Hz. Total time 75 minutes.
Shock Operating and Non-operating	30 g's, 1/2 sine, 11 ms duration, 2 shocks in each direction along 3 major axes, for a total of 18 shocks.

Table 2-3

PHYSICAL CHARACTERISTICS

Characteristics	Information
Overall Dimensions (measured at maximum points) Height	5.0 inches 12.7 centimeters
Width	2.6 inches 6.6 centimeters
Length	12.2 inches 31.0 centimeters
Net Weight (Instrument Only)	2 pounds, 14 ounces 1.3 kilograms

PERFORMANCE CHECK

Introduction

This procedure checks the electrical characteristics of the SG 504 that appear in the Specification portion of this section. If the instrument fails to meet the requirements given in this performance check, the calibration procedure should be performed. This procedure can also be used by an incoming inspection facility to determine acceptability of performance.

The electrical characteristics in this section are valid only if the SG 504 is calibrated at an ambient temperature of $+20^{\circ}\text{C}$ to $+30^{\circ}\text{C}$ and operated at an ambient temperature of 0°C to $+50^{\circ}\text{C}$. Forced air circulation is required for ambient temperature above $+40^{\circ}\text{C}$.

Tolerances that are specified in this performance check procedure apply to the instrument under test and do not include test equipment error.

Test Equipment Required

The following test equipment, or equivalent, is required to perform the performance check. Test equipment characteristics listed are the minimum required to verify the performance of the equipment under test. Substitute equipment must meet or exceed the stated requirements. All test equipment is assumed to be operating within tolerances.

Special test devices are used where necessary to facilitate the procedure. Most of these are available from Tektronix, Inc. and can be ordered through your local Tektronix Field Office or representative.

Table 2-4

LIST OF TEST EQUIPMENT REQUIREMENTS

Description	Performance Requirements	Application	Example
Oscilloscope	Bandwidth, dc to 100 MHz; minimum deflection factor, 1 mV/div; sweep rate, 10 ms/div to 50 ns/div; accuracy, within 3%.	Used throughout procedure to provide display.	TEKTRONIX 7603, 7A13, 7B80 Oscilloscope System.
Digital Voltmeter	Range, 0 to 50 V; accuracy, within 0.1%.	Output voltage flatness check.	TEKTRONIX DM 501 Digital Multimeter. [†]
Power Module	Three compartments or more.	All tests.	TEKTRONIX TM 503 or TM 504.
Calibration Generator	Amplitude calibration, 5 mV to 5 V; accuracy, $\pm 0.25\%$ into 1 M Ω ; output, square wave at approximately 1 kHz.	Reference amplitude check.	TEKTRONIX PG 506 Calibration Generator. [†]
Spectrum Analyzer	Range, 100 kHz to 2.5 GHz; calibrated levels in decade steps from -30 to $+20$ dBm; impedance, 50 Ω .	Harmonic Suppression check.	TEKTRONIX 7L12 Spectrum Analyzer, MOD 139U.
Counter	Maximum Frequency, 10 MHz; Period Avg mode capable to 10^3 ; output sensitivity, 5 V; display accuracy, 1 count in 10^3 .	Reference frequency accuracy check.	TEKTRONIX DC 501 Digital Counter.

[†]Requires TM 500-Series Power Module.

Specification and Performance Check—SG 504

Table 2-4 (cont)

Description	Performance Requirements	Application	Example
Peak-to-Peak Detector	Frequency range, 50 Hz to 500 MHz; requires 1.2 V p-p input voltage.	Output voltage flatness check.	Tektronix 067-0625-00 Calibration Fixture.
Power Meter	Frequency range, 100 kHz to 2 GHz (depending on power sensor); power range, 1 to 100 mW; recorder output, 1 k Ω output impedance; instrumentation uncertainty, $\pm 1\%$ of full scale.	Amplitude flatness check.	Hewlett-Packard 435A.
Power Sensor	Frequency range, 10 MHz to 2 GHz; power range, 1 to 100 mW; impedance, 50 Ω .	Amplitude flatness check.	Hewlett-Packard 8481A.
Termination, precision	Impedance, 50 Ω ; connectors, bnc; accuracy, $\pm 0.1\%$.	Amplitude and frequency accuracy checks.	Tektronix Part No. 011-0129-00.
Coaxial cable (2 required)	Impedance, 50 Ω ; length, 42 inches; connectors, bnc.	Provides signal inter-connection.	Tektronix Part No. 012-0057-01.
Attenuator, X2 (2 required)	Impedance, 50 Ω ; connectors, 50 Ω ; accuracy, 2%.	Output voltage flatness check.	Tektronix Part No. 011-0069-02.
Attenuator, X10 (2 required)	Impedance, 50 Ω ; connectors, bnc; accuracy, 2%.	High and low frequency accuracy, monitor output amplitude check.	Tektronix Part No. 011-0059-02.
Adapter	GR to N female.	Output voltage flatness check.	Tektronix Part No. 017-0062-00.
Adapter	GR to bnc female.	Output voltage flatness check.	Tektronix Part No. 017-0063-00.
Adapter (2 required)	Bnc female to dual banana.	Output voltage flatness check.	Tektronix Part No. 103-0090-00.
Adapter	Bnc male to N female.	Monitor output amplitude check.	Tektronix Part No. 103-0058-00.
Adapter	Bnc tee.	Reference amplitude and High—Low frequency accuracy check.	Tektronix Part No. 103-0030-00.
Resistor	2.4 M Ω , 1/2 W, 5%.	Output voltage flatness check.	Tektronix Part No. 301-0245-00.

Specification and Performance Check—SG 504

Preliminary Procedure

1. Ensure that all test equipment and the SG 504 under test are suitably adapted to the line voltage to be applied. Refer to the installation section of the power module manual.
2. Ensure that all test equipment is suitably adapted to the applied line voltage.
3. Connect the SG 504 Output Head to the two front-panel connectors labeled OUTPUT HEAD. Connect a precision 50-ohm feedthrough termination to the Output Head.
4. Remove the left side cover of the SG 504, and set the internal slide switch, S190, to the 0.05 MHz position. See Fig. 3-1 for switch location.
5. Install the SG 504 into the power module, and if applicable, install the TM 500 series test equipment into the test equipment power module.
6. Connect the equipment under test and the test equipment to a suitable line voltage source. Turn all equipment on and allow at least 20 minutes for the equipment to stabilize.

WARNING

Throughout the following procedure, the operator is directed to change the position of switch S190 (reference frequency selector) while the SG 504 is energized. Use extreme care, for hazardous voltages exist at some of the circuit board terminals.

Initial Control Settings

Set the following controls during warm-up time:

SG 504

RANGE	REF (pushbutton in)
FREQUENCY MHz	245
FINE	0 (centered)
OUTPUT AMPLITUDE	0.5
(Internal slide switch)	.05 MHz

Oscilloscope

Intensity, Focus	Set for well-defined trace and normal brightness
------------------	--

Differential Comparator

Volts/Div	.1 V
Variable	Fully clockwise (cal)
+ Input	Ac
- Input	Ac
Bandwidth Limit	Full
Position	Centered

Time Base Plug-In

Time/Div	5 μ s
Variable	(Cal in)
Triggering	
+ Slope	Selected
Mode	P-P auto
Coupling	Ac
Source	Internal
Position	Set so trace starts at left side of graticule.
Display Mode	Main sweep
Magnifier	X1

Counter

Display Time	.1 sec
Measurement Interval	
Attenuation	X5
Display Time Control	Fully counterclockwise

PERFORMANCE CHECK PROCEDURE

1. Check Output of 0.05 MHz and 6 MHz Reference Frequency

a. Connect the SG 504 Output Head, through a 50 Ω precision termination, to the + input of the differential comparator.

b. Set the time-base triggering controls for a stable display.

c. Check—the crt display for a sine-wave signal amplitude of 5.0 divisions with no visible distortion of the waveform.

d. Set the SG 504 OUTPUT AMPLITUDE control to 5.5. Set the differential comparator deflection factor for 1 V/div.

e. Check—the crt display for a sine-wave signal amplitude of 5.5 divisions, with no visible distortion of the waveform, and the SG 504 UNLEVELED light remains off.

Specification and Performance Check—SG 504

f. Set the SG 504 internal slide switch, S190, to the 6 MHz position. See Fig. 3-1 for switch location.

g. Set the time-base sweep rate to 50 ns/div; set the triggering controls for a stable display.

h. Check—the crt display for a sine-wave signal amplitude of 5.5 divisions, with no visible distortion of the waveform, and the SG 504 UNLEVELED light remains off.

i. Set the SG 504 OUTPUT AMPLITUDE control to 0.5. Set the differential comparator deflection factor for .1 V/div.

j. Check—the crt display for a sine-wave signal amplitude of 5.0 divisions, with no visible distortion of the waveform.

k. Disconnect the SG 504 Output Head from the differential comparator.

2. Check Accuracy of 0.05 MHz and 6 MHz Reference Frequency

a. Connect the SG 504 Output Head, through a 50 Ω precision termination, to the input of the counter. Adjust the SG 504 OUTPUT AMPLITUDE control to 1.0.

b. Check—the frequency accuracy at 0.05 MHz is within $\pm 2\%$ (0.05 MHz, ± 0.001 MHz).

c. Set the SG 504 internal slide switch, S190, to the 6 MHz position. See Fig. 3-1 for switch location.

d. Check—the frequency accuracy at 6 MHz is within $\pm 2\%$ (6 MHz, ± 0.12 MHz).

e. Disconnect the SG 504 Output Head from the counter.

3. Check Accuracy of 0.05 MHz Reference Amplitude

a. Set the time-base sweep rate to 200 $\mu\text{s}/\text{div}$. Set the SG 504 OUTPUT AMPLITUDE control to 5.0.

b. Connect a 1 kHz, 5 volt square-wave signal from the calibration generator, through a bnc tee connector, to the + input of the differential comparator, using a 50 Ω cable. Connect a 50 Ω cable from the tee connector to the time-base unit external trigger input.

c. Set the differential comparator deflection factor for 100 mV/div; set BW switch to 5 MHz.

d. Connect the SG 504 Output Head, through a 50 Ω precision termination, to the differential comparator input connector.

e. Set the time-base triggering controls for a stable display; a crt display similar to Fig. 2-1 is obtained.

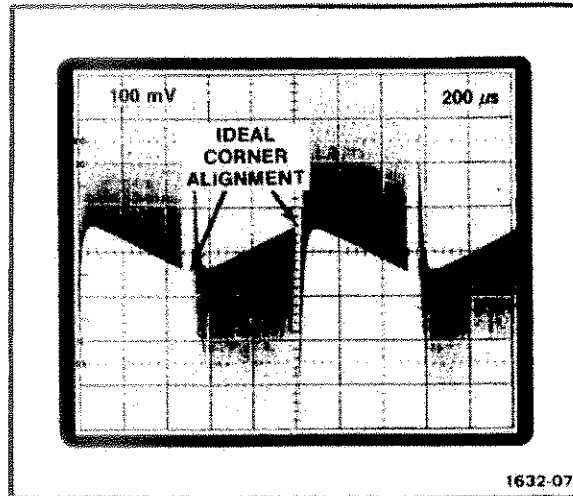

Fig. 2-1. Display of complex waveform (idealized) with 5 volt reference amplitude at 0.05 MHz, properly set.

f. Check—that the corners of the idealized waveform are aligned as illustrated in Fig. 2-1, within one division. Disregard waveform tilt.

g. Set the SG 504 OUTPUT AMPLITUDE control to 0.5. Set the calibration generator for a 0.5 volt, 1 kHz square-wave signal.

h. Set the differential comparator deflection factor for 10 mV/div.

i. Check—that the waveform is similar as illustrated in Fig. 2-2 (within one vertical division).

j. Disconnect all test equipment.

Specification and Performance Check—SG 504

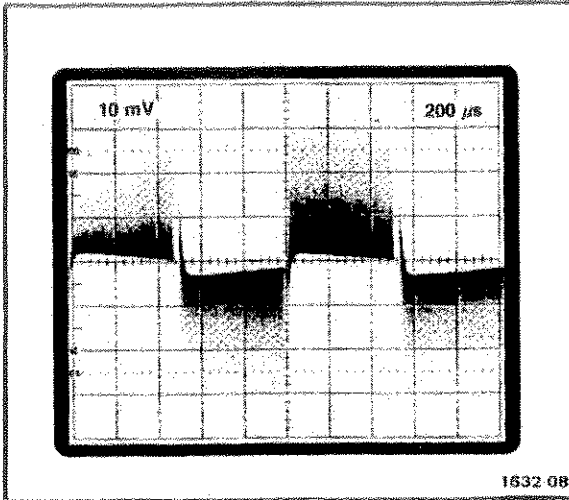

Fig. 2-2. Display of complex waveform (idealized) with 0.5 volt reference amplitude of 0.05 MHz, properly set.

4. Check Harmonic Suppression and Leveling

a. Set the Spectrum Analyzer controls as follows:

Time/Div	Spectrum
Triggering	
Mode	P-P auto
Source	Free run
Slope	+
Video Filters	30 kHz
Freq Span/Div	Max Span (250 MHz/div)
Resolution	3 MHz
Auto Phase	In
RF dB	50
Reference Level	20 dBm
Ref Var	Cal
Base Line Clipper	Counterclockwise
10 dB/Div	Pushbutton in
Frequency display	Start
Frequency MHz	0100
Fine	Midrange

b. Connect the SG 504 Output Head to the spectrum analyzer RF input connector.

c. Set the SG 504 OUTPUT AMPLITUDE control to 5.0. Push in the LOW RANGE pushbutton.

d. Rotate the SG 504 COARSE control until the dial tape indicates 245 at the cursor line. Position the zero frequency marker to the left edge of the graticule with the spectrum analyzer position control. A display similar to Fig. 2-3 should be obtained.

e. Position the fundamental vertically to the top graticule line with the spectrum analyzer position control. See Fig. 2-4 for reference.

f. Rotate the SG 504 COARSE control from 245 MHz to 550 MHz slowly and check that the vertical distance (suppression) between the top of the second harmonic and fundamental is at least 2.5 divisions (25 dB); the tops of the third and remaining harmonics are separated at least 4.0 divisions (40 dB). See Fig. 2-4 for reference.

NOTE

The SG 504 UNLEVELED light must remain off during all harmonic checks.

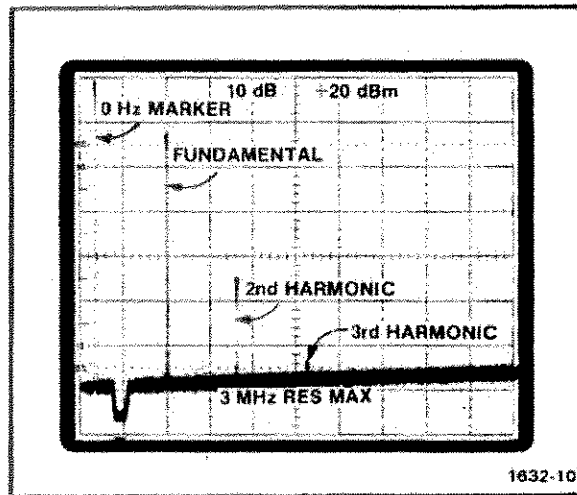

Fig. 2-3. Display of 245 MHz signal and harmonics.

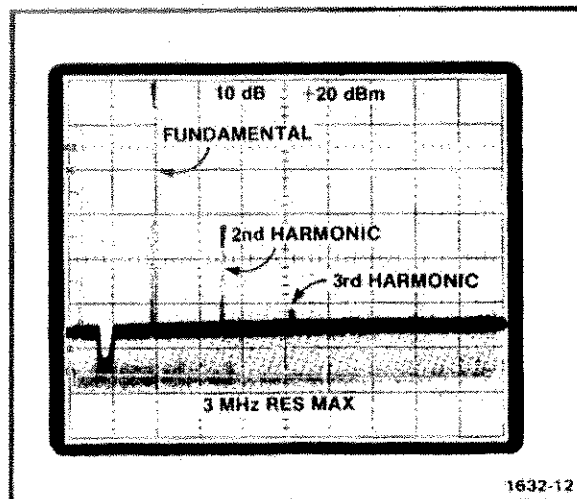

Fig. 2-4. Typical display of 245 MHz signal with fundamental properly positioned.

Specification and Performance Check—SG 504

- g. Push in the SG 504 HIGH RANGE pushbutton. Rotate the COARSE control until the dial tape indicates 495 at the cursor line.
- h. Check—rotate the SG 504 COARSE control from 495 MHz to 1050 MHz and check that the vertical distance (suppression) between the top of the second harmonic and fundamental is at least 2.5 divisions (25 dB); the tops of the third and remaining harmonics are separated at least 4.0 divisions (40 dB). See Fig. 2-4 for reference.
- i. Repeat parts e through h of this step for the 1.0 setting of the SG 504 OUTPUT AMPLITUDE control; set Reference Level to +10 dBm and Ref dB to 40. The harmonic specification is the same as listed in part h of this step.
- j. Repeat parts e through h of this step for the 0.5 volt setting of the SG 504 OUTPUT AMPLITUDE control; Reference Level is set to 0 dBm and RF dB is set to 30. The harmonic specification is the same as listed in part h of this step.
- k. Set the spectrum analyzer Reference Level to +20 dBm and the RF dB to 50.
- l. Set the SG 504 OUTPUT AMPLITUDE control to 5.0; set the internal slide switch, S190, to the 6 MHz position. See Fig. 3-1 for switch location.
- m. Set the spectrum analyzer Frequency Span/Div control to 2 MHz, and Resolution to .3 MHz; disconnect the Output Head from the spectrum analyzer input connector.
- n. Adjust the spectrum analyzer Frequency Coarse control to approximately 0000 MHz; slowly adjust the Frequency Fine control to position the zero marker to the left side of the graticule. Reconnect the Output Head to the spectrum analyzer input connector.
- o. Check—that the fundamental is vertically positioned at the top of the graticule line.
- p. Check—that the vertical distance (suppression) between the top of the second harmonic and fundamental is at least 2.5 divisions (25 dB); the tops of the third and remaining harmonics are separated at least 4.0 divisions (40 dB). See Fig. 2-4 for reference.
- q. Repeat parts o and p of this step for the 0.5 volt setting of the SG 504 OUTPUT AMPLITUDE control; Reference Level is set to 0 dBm and RF dB is set to 30.
- r. Set the spectrum analyzer Reference Level to -20 dBm and the RF dB to 50.
- s. Set the SG 504 OUTPUT AMPLITUDE control to 5.0; set the internal slide switch, S190, to the 0.05 MHz position. Disconnect the SG 504 Output Head from the spectrum analyzer input connector. See Fig. 3-1 for switch location.
- t. Set the spectrum analyzer Frequency Span/Div control to 20 kHz and Resolution to 3 kHz.
- u. Push and release the spectrum analyzer Video Filter pushbutton.
- v. Adjust the spectrum analyzer Frequency Fine control to position the zero marker to the left side of the graticule; reconnect the SG 504 Output Head to the spectrum analyzer input connector.
- w. Repeat parts o and p of this step for the 0.5 volt setting of the SG 504 OUTPUT AMPLITUDE control; Reference Level is set to 0 dBm and RF dB is set to 30.
- x. Set the spectrum analyzer Reference Level to +20 dBm and RF dB to 50.
- y. Disconnect the SG 504 Output Head from the spectrum analyzer input connector.

5. Check Frequency Accuracy (Low and High Range)

- a. Connect a bnc tee connector to the RF input of the spectrum analyzer; connect a 50 Ω cable from the bnc tee to the spectrum analyzer cal out connector.
- b. Connect two X10 50 Ω attenuators in series, and connect the series-connected attenuators to the SG 504 Output Head; connect the other end of the attenuator to the bnc tee connector.
- c. Push in the spectrum analyzer Frequency display Center pushbutton; set Frequency MHz to 250, using the coarse control. Set the Fine control to midrange.

Specification and Performance Check—SG 504

d. Set the spectrum analyzer Frequency Span/Div control to 1 MHz with a resolution of 30 kHz. Set the RF dB to 0 with a reference level of -30 dBm.

e. Push in the SG 504 LOW RANGE pushbutton. Rotate the COARSE control until the dial tape indicates 250 at the cursor line.

f. Set the SG 504 OUTPUT AMPLITUDE control to 4.0.

NOTE

This procedure uses the harmonics of the 50 MHz cal out signal to check the accuracy of the frequency at six check points. Essentially the same procedure can be followed to check the accuracy of any other frequency on the low or high range, providing that the frequency checked is a harmonic of the 50 MHz cal out signal from the spectrum analyzer. Frequencies other than the six calibration check points must be within the 2% specifications.

g. Adjust the spectrum analyzer Frequency Coarse control to horizontally center the 250 MHz signal on the graticule. Use Table 2-5 as reference for verification of the six frequency check points.

NOTE

The two markers may coincide during the low frequency range setting. If so, verify the presence of the SG 504 frequency signal by slightly adjusting the SG 504 COARSE control.

Table 2-5

LOW AND HIGH RANGE FREQUENCY ACCURACY

	SG 504 Frequency Dial Setting	Allowable Deviation from Frequency Marker
Low Range	250 MHz	±1.9 divisions (±1.9 MHz)
	450 MHz	±3.4 divisions (±3.4 MHz)
	550 MHz	±4.1 divisions (±4.1 MHz)
High Range	500 MHz	±3.8 divisions (±3.8 MHz)
	750 MHz	±5.6 divisions (±5.6 MHz)
	1050 MHz	±7.9 divisions (±7.9 MHz)

h. Disconnect all test equipment.

i. Set the spectrum analyzer Reference Level control to -20 dBm and the RF to 50.

6. Check Flatness (Peak-to-Peak Amplitude Regulation)

a. Set the SG 504 controls as follows: REF pushbutton in, OUTPUT AMPLITUDE control to 0.5, FREQUENCY MHz setting to 245, and FINE control to 0 (centered).

b. Connect a 2.4 megohm, 5% resistor across the digital voltmeter floating input terminals. Connect the SG 504 Output Head via bnc female-to-GR adapter to the input of the peak-to-peak detector. Use two 50 Ω cables and two dual banana to bnc adapters to connect the output of the peak-to-peak detector to the floating input terminals on the digital voltmeter; maintain correct polarity, HI to + and LO to -. Set the digital voltmeter to the 20 volts dc range.

c. Slowly adjust the SG 504 OUTPUT AMPLITUDE control until the digital voltmeter reading indicates ±.000. Output amplitude from the SG 504 should be about 1.2 volts; this establishes a 0.0% reference setting at 0.05 MHz.

d. Set the SG 504 internal slide switch, S190, to the 6 MHz position. See Fig. 3-1 for switch location.

NOTE

Do not disturb the approximate 1.2 volt setting of the SG 504 OUTPUT AMPLITUDE control, as set in part c. of this step; otherwise, an incorrect deviation reading will occur.

e. Check—the flatness deviation from the 0.0% reference setting; the voltage reading of the digital voltmeter should not be greater than 0.5% (.001 volt output from the peak-to-peak detector is equivalent to 0.1%).

f. Push in the SG 504 LOW RANGE pushbutton. Note and record the reading of the digital voltmeter for the flatness deviation at 245 MHz; for example, -0.2%. The total percentage deviation calculation must include the digital voltmeter reading and the calibration factor of the peak-to-peak detector. For example, a reading of -.002 volt on the digital voltmeter is equivalent to -0.2% deviation. Applying a correction factor of -0.3% algebraically to the -0.2% value results in a total percentage deviation of -0.5%. Record the actual algebraic sum at this point; it will be used later in the procedure.

Specification and Performance Check—SG 504

g. Retain the 2.4 megohm resistor connected across the digital voltmeter input terminals; disconnect the peak-to-peak detector and all cables.

h. Set the power meter to the 10 mW range and calibration factor for 100.

i. Connect a 50 Ω cable from the power meter recorder output (rear panel) via bnc female to dual-banana adapter to the floating input terminals of the digital voltmeter; maintain correct polarity, HI to + and LO to -.

j. Connect the SG 504 Output Head via bnc female to GR adapter, to a GR-to-N female adapter to the input of the power sensor.

k. Check—that the digital voltmeter reading is between +.300 and +.425; for example, +.324. Note and record the actual reading; it will be used later in the procedure.

l. Slowly rotate the SG 504 COARSE control clockwise from 245 MHz to 550 MHz, as indicated on the dial tape; check for a maximum and minimum digital voltmeter reading while sweeping over the entire low frequency band. Note and record the maximum and the minimum reading.

NOTE

Consult the power sensor calibration chart to determine calibration factor correction points for the power meter front-panel calibration factor setting. A 99 or 98 calibration factor may be needed.

m. Push in the SG 504 HIGH RANGE pushbutton; slowly rotate the SG 504 COARSE control counterclockwise from 495 MHz to 1050 MHz, as indicated on the dial tape. Check for a maximum and minimum digital voltmeter reading while sweeping over the entire high frequency band (observe the possible need for a power meter calibration factor setting to 99 or 98 at the proper frequency points). Note and record the most maximum and minimum reading obtained over the two bands (parts l or m of this step). For this example only, a maximum reading of +.330 and a minimum reading of +.315.

n. Itemize the collected data from parts f through m of this step and perform the following calculations to compute the flatness deviation. For example:

1. Flatness deviation at 245 MHz = -0.5% (part f)
2. Reference number on digital voltmeter = +.324 (part k)
3. Maximum reading on digital voltmeter = +.330 (part m)
4. Minimum reading on digital voltmeter = +.315 (part m)

Calculate the difference between the reference number obtained in part k of this step (+.324), and the maximum and minimum values obtained in part m of this step. The difference from the maximum number will be a positive value and the difference from the minimum number will be a negative value. For this example:

$$(+.330) - (+.324) = +.006$$

$$(+.315) - (+.324) = -.009$$

To convert the difference values into percentage, divide each result by the reference number; multiply by 100, and then divide by 2:

$$\frac{+.006}{+.324} \quad \times 100 = \frac{+.185}{2} = +0.93\%$$

$$\frac{-.009}{+.324} \quad \times 100 = \frac{-2.78}{2} = -1.39\%$$

Algebraically add the flatness deviation at 245 MHz (part f of this step) to both percentage values:

$$(+0.93\%) + (-0.5\%) = +0.43\%$$

$$(-1.39\%) + (-0.5\%) = -1.89\%$$

For this example of computing the flatness deviation, the +0.43% value represents the maximum deviation above the 0.05 MHz reference amplitude and the -1.89% value represents the maximum deviation below the 0.05 MHz reference amplitude. Maximum flatness deviation from the 0.05 MHz reference amplitude should not exceed 3%.

o. Use two 50 Ω cables and two dual banana to bnc adapters to connect the output of the peak-to-peak detector to the floating input terminals of the digital voltmeter; maintain correct polarity, HI to - and LO to -.

Specification and Performance Check—SG 504

p. To check flatness deviation at a higher output from the SG 504, insert two X2 attenuators between the SG 504 Output Head and the peak-to-peak detector.

q. Set the SG 504 internal slide switch, S190, to the 0.05 MHz position. Push in the SG 504 REF pushbutton. See Fig. 3-1 for switch location.

r. Slowly adjust the SG 504 OUTPUT AMPLITUDE control until the digital voltmeter reading indicates ± 0.00 . Output amplitude from the SG 504 should be about 4.8 volts; this establishes a 0.0% reference setting at 0.05 MHz. Set the internal slide switch, S190, to the 6 MHz position. See Fig. 3-1 for switch location.

s. Check—the flatness deviation from the 0.0% reference setting; the voltage reading of the digital voltmeter should not be greater than 0.5% (.001 volt output from the peak-to-peak detector is equivalent to 0.1%).

NOTE

Do not disturb the approximate 4.8 volt setting of the SG 504 OUTPUT AMPLITUDE control, as set in part r of this step; otherwise, an incorrect deviation reading will occur.

t. Push in the SG 504 LOW RANGE pushbutton. Note and record the reading of the digital voltmeter for the flatness deviation at 245 MHz. (Refer to part f of this step for correction factor explanation.)

u. Disconnect the peak-to-peak detector, two X2 attenuators, and all cables.

v. Change power meter to 100 mW range and repeat part h and i.

w. Connect the SG 504 Output Head to the input of the power sensor.

x. Check—that the digital voltmeter reading is between +.485 and +.675. Note and record the actual reading; it will be used later in the procedure.

y. Slowly rotate the SG 504 COARSE control clockwise from 245 MHz to 550 MHz, as indicated on the dial tape; check for a maximum and minimum digital voltmeter reading while sweeping over the entire low frequency band. Note and record the maximum and minimum reading.

NOTE

Consult the power sensor calibration chart to determine calibration factor correction points for the power meter front-panel calibration factor setting. A 99 or 98 calibration factor may be needed.

z. Repeat part m of this step (disregard the example readings given, as new readings will be recorded).

aa. Itemize the collected data from parts t through y of this step and perform the calculations as outlined in part n of this step.

ab. Set the SG 504 controls as follows: OUTPUT AMPLITUDE to 0.5, LOW RANGE pushbutton in, FINE control to 0 (centered), and FREQUENCY MHz setting to 245.

ac. Disconnect the SG 504 Output Head from the power sensor.

7. Check Amplitude of Frequency Monitor Output

a. Connect a 50 Ω , X10 attenuator to the SG 504 Output Head; connect a 50 Ω termination to the X10 attenuator.

b. Remove the adapters from the power sensor and connect a bnc male to N female adapter to the power sensor; connect the power sensor to the SG 504 FREQUENCY MONITOR OUT connector.

c. Set the power meter to the 3 mW range and calibration factor control to 100.

d. Slowly rotate the SG 504 COARSE control clockwise from 245 MHz to 550 MHz on the low band, as indicated on the dial tape; then, switching to the high band, rotate the SG 504 COARSE control counter-clockwise from 1050 MHz to 495 MHz, while observing the power meter reading. The minimum reading on the power meter over the entire frequency band should not be less than 0.25 mW.

e. Set the SG 504 OUTPUT AMPLITUDE control to 1.0 volt, 2.0 volts, and 3.5 volts. Repeat part d of this step for each of the output amplitude voltage settings. The power meter reading should not be less than 0.25 mW at each voltage setting.

f. Disconnect all cables.

This completes the Performance Check procedure of the SG 504 Leveled Sine Wave Generator.

ADJUSTMENT

Introduction

This adjustment procedure is to be used to restore the SG 504 to original performance specifications. Adjustment need not be performed unless the instrument fails to meet the Performance Requirements of the Electrical Characteristics listed in the Specification section, or the Performance Check cannot be completed satisfactorily.

Completion of all adjustment steps in this procedure ensures that the instrument will meet the performance requirements listed in Section 2 Specification and Performance Check. However, to fully ensure satisfactory performance, it is recommended that the Performance Check be performed after any adjustment is made.

Services Available

Tektronix, Inc. provides complete instrument repair and adjustment at local Field Service Centers and at the Factory Service Center. Contact your local Tektronix Field Office or representative for further information.

Test Equipment Required

The test equipment listed in Table 3-1, or equivalent, is required for adjustment of the SG 504. Specifications given for the test equipment are the minimum necessary for accurate adjustment and measurement. All test equipment is assumed to be correctly calibrated and operating within specification.

If other test equipment is substituted, control settings or calibration setup may need to be altered to meet the requirements of the equipment used.

A flexible plug-in extender, Tektronix Part No. 067-0645-02, is useful for troubleshooting or adjusting the SG 504; however, the complete Adjustment Procedure can be performed without use of the extender.

Table 3-1

LIST OF TEST EQUIPMENT REQUIREMENTS

Description	Performance Requirements	Application	Example
Oscilloscope	Bandwidth, dc to 100 MHz; minimum deflection factor, 1 mV/div; sweep rate, 10 ms/div to 1 μ s/div; accuracy, within 3%.	Used throughout procedure to provide display.	TEKTRONIX 7603, 7A13, 7B80 Oscilloscope System.
Digital Voltmeter	Range, 0 to 50 V; accuracy, within 0.1%.	Output voltage flatness check.	TEKTRONIX DM 501 Digital Multimeter. ¹
Power Module	Three compartments or more.	All tests.	TEKTRONIX TM 503 or TM 504.
Calibration Generator	Amplitude calibration, 5 mV to 5 V; accuracy, $\pm 0.25\%$ into 1 M Ω ; output, square wave at approximately 1 kHz.	Amplitude Set check	TEKTRONIX PG 506 Calibration Generator. ¹
Spectrum Analyzer	Range, 100 kHz to 300 MHz; calibrated levels in decade steps from -45 dB to -35 dB; impedance, 50 Ω ; accuracy, linear display, within 10%.	Harmonic suppression check.	TEKTRONIX 7L12 Spectrum Analyzer MOD 139U.

¹Requires TM 500-Series Power Module.

Table 3-1 (cont)

LIST OF TEST EQUIPMENT REQUIREMENTS

Description	Performance Requirements	Application	Example
Counter	Maximum Frequency, 500 kHz; Period Avg mode capable to 10^3 ; output sensitivity, 5 V; display accuracy, 1 count in 10^3 .	Reference frequency accuracy check.	TEKTRONIX DC 501 Digital Counter.*
Peak-to-Peak Detector	Frequency range, 50 Hz to 500 MHz; requires 1.2 V p-p input voltage.	Output voltage flatness check.	Tektronix 067-0625-00 Calibration Fixture.
Power Meter	Frequency range, 100 kHz to 2 GHz (depending on power sensor); power range, 1 to 100 mW; recorder output, 1 k Ω output impedance; instrumentation uncertainty, $\pm 1\%$ of full scale.	Amplitude flatness check.	Hewlett-Packard 435A.
Power Sensor	Frequency range, 10 MHz to 2 GHz; power range, 1 to 100 mW; impedance, 50 Ω .	Amplitude flatness check.	Hewlett-Packard 8481A.
Termination, precision.	Impedance, 50 Ω ; connectors bnc, accuracy, $\pm 0.1\%$.	Amplitude and frequency accuracy checks.	Tektronix Part No. 011-0129-00.
Coaxial cable (2 required)	Impedance, 50 Ω ; length, 42 inches; connectors, bnc.	Provides signal inter-connection.	Tektronix Part No. 012-0057-01.
Attenuator, X2 (2 required)	Impedance, 50 Ω ; connectors 50 Ω ; accuracy, 2%.	Output voltage flatness check.	Tektronix Part No. 011-0069-02.
Attenuator, X10 (2 required)	Impedance, 50 Ω ; connectors, bnc; accuracy, 2%.	High and Low frequency accuracy, monitor output amplitude check.	Tektronix Part No. 011-0059-02.
Adapter	GR to N female.	Output voltage flatness check.	Tektronix Part No. 017-0062-00.
Adapter	GR to bnc female.	Output voltage flatness check.	Tektronix Part No. 017-0063-00.
Adapter (2 required)	Bnc female to dual banana.	Output voltage flatness check.	Tektronix Part No. 103-0090-00.
Adapter	Bnc male to N female.	Monitor output amplitude check.	Tektronix Part No. 103-0058-00.
Adapter	Bnc tee.	Reference amplitude and High—Low frequency accuracy check.	Tektronix Part No. 103-0030-00.

Table 3-1 (cont)
LIST OF TEST EQUIPMENT REQUIREMENTS

Description	Performance Requirements	Application	Example
Resistor	2.4 M Ω , 1/2 W, 5%.	Output voltage flatness check.	Tektronix Part No. 301-0245-00.
Resistor	330 Ω , 1 W, 5%.	Oscillator current limit check.	Tektronix Part No. 303-0331-00.
Screwdriver	Three-inch shaft, 3/32 inch bit.	Used to adjust variable resistors.	Xcelite R-3323.
Alignment tool	Fits 5/64-inch (ID) hex cores.	Used to adjust coils in harmonic suppression check and reference frequency.	Tektronix Part No. 003-0307-00 (handle) 003-0310-00 (insert).
Alignment tool	Five-inch, for slotted cores.	Used to adjust coils in harmonic suppression check.	Tektronix Part No. 003-0301-00.

Preparation

a. Remove the left side cover of the SG 504 to gain access to the component side of the circuit boards. Pull the rear end of the side cover outward from the side of the instrument (the cover snaps into place).

b. Install the SG 504 into the left power module compartment, or if appropriate, connect the SG 504 to the power module by means of the flexible plug-in extender.

c. Set the power module for the line voltage to be applied (see power module manual) and connect it to the variable autotransformer; connect the autotransformer to the line voltage source. Be sure that the power switch is off.

d. Connect the SG 504 Output Head to the two front-panel connectors labeled OUTPUT HEAD. Connect a precision 50 Ω feedthrough termination to the Output Head.

e. Install the TM 500-series equipment, including the SG 504 into the power module.

f. Connect all test equipment to a suitable line voltage source.

g. Turn on all test equipment and allow at least 20 minutes for the equipment to warm up and stabilize.

NOTE

Throughout the following procedure, the operator is directed to change the position of switch S190 (reference frequency selector) while the SG 504 is energized. Use extreme care, for hazardous voltages exist at some of the circuit board terminals.

Initial Control Settings

Set the following controls during warm-up time:

SG 504

RANGE	REF (pushbutton in)
FREQUENCY MHz	245
FINE	0 (centered)
OUTPUT AMPLITUDE	.05
Internal Slide Switch	.5 MHz

Adjustment—SG 504

Counter

Display Time	
Measurement Interval	.1 sec
Attenuation	X5
Display Time Control	Fully counter-clockwise

Oscilloscope

Intensity, Focus	Set for well-defined trace and normal brightness.
------------------	---

Differential Comparator

Volts/Div	.1 V
Variable	Fully clockwise (cal)
+Input	AC
-Input	AC
Bandwidth	Full
Position	Centered

Time Base Plug-In

Time/Div	5 μ s
Variable (Cal in)	
Triggering	
+Slope	Selected
Mode	P-P auto
Coupling	AC
Source	Internal
Position	Set so trace starts at left side of graticule.
Display Mode	Main sweep
Magnifier	X1

ADJUSTMENT PROCEDURE

1. Adjust -18 Volt Power Supply

a. Connect the digital voltmeter between the -18 V test point and Gnd test point on the Main circuit board. See Fig. 3-1 for voltage test point location.

b. Check—for a meter reading of -18 volts, ± 20 mV.

c. Adjust—-18 V adj, R590, for a meter reading of 18 volts. See Fig. 3-1 for adjustment location.

d. Adjust the autotransformer output voltage from the low limit to the high limit as indicated in Table 3-2. Meter reading should not vary more than ± 20 mV for each 10% line voltage change. Return the autotransformer to the nominal line voltage setting.

e. Disconnect the digital voltmeter.

Table 3-2

POWER MODULE UNIVERSAL TRANSFORMER

Line Selector Block Position	Regulating Ranges	
	110-Volts Nominal	220-Volts Nominal
L	90 V ac to 110 V ac	180 V ac to 220 V ac
M	99 V ac to 121 V ac	198 V ac to 242 V ac
H	108 V ac to 132 V ac	216 V ac to 264 V ac
Line Fuse Data	1.6 A slow-blow	0.8 A slow-blow

2. Check +5 Volt Supply

a. Connect the digital voltmeter between the +5 V test point and Gnd test point on the Main circuit board. See Fig. 3-1 for voltage test point location.

b. Check—for meter reading of +5, ± 0.3 V.

c. Disconnect the digital voltmeter.

3. Check -14/-23 Volt Oscillator Supply

a. Connect the digital voltmeter between the -14/-23 V (TP2) test point and Gnd test point on the Main circuit board. See Fig. 3-1 for voltage test point location.

b. Push in the SG 504 LOW RANGE pushbutton.

c. Check—for meter reading of -14 V, ± 0.4 V.

d. Push in the SG 504 REF pushbutton.

e. Disconnect the bnc cable of the Output Head from the SG 504 front-panel connector; connect a X10, 50 Ω attenuator to this bnc connector.

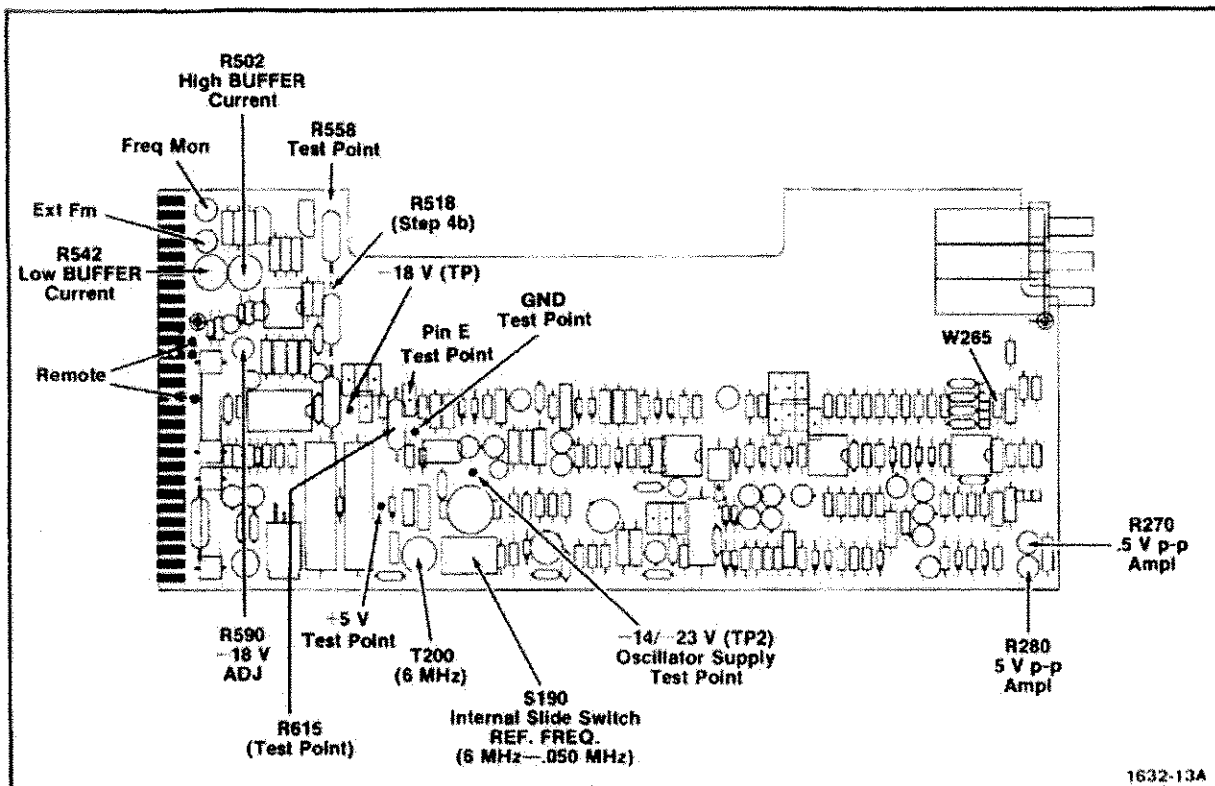

Fig. 3-1. Location of test points, connectors, and adjustments on main circuit board.

f. Check the digital voltmeter reading (approximately -22.0 to -23.2 V); then record a value that is one volt lower than the actual reading. This recorded value will be used in Step 8 part k and Step 9 part n.

g. Disconnect the X10, $50\ \Omega$ attenuator from the SG 504 front-panel OUTPUT HEAD connector. Reconnect the bnc cable of the Output Head to this connector.

h. Disconnect the digital voltmeter.

4. Check Oscillator Supply Current Limit

a. Connect the digital voltmeter across R615. See Fig. 3-1 for location.

b. Connect a $330\ \Omega$, 1 W resistor between the $-14/-23\text{ V}$ (TP2) testpoint and Gnd test point on the Main circuit board. See Fig. 3-1 for location.

c. Check the digital voltmeter reading (approximately $+5.5$ to $+5.9\text{ V}$); then record a value that is 0.4 V lower than the actual reading. This recorded value will be used in Step 8 part m and Step 9 part p.

d. Disconnect the $330\ \Omega$ resistor and the digital voltmeter.

5. Check Buffer Amplifier Bias Voltage

a. Connect the digital voltmeter between Pin E test point and Gnd test point on the Main circuit board. See Fig. 3-1 for location.

b. Check—for a meter reading of -12.0 V to -12.9 V .

c. Disconnect the digital voltmeter.

6. Check Output of 0.05 MHz and 6 MHz Reference

a. Connect the SG 504 Output Head, through a $50\ \Omega$ precision termination, to the minus ($-$) input of the differential comparator.

b. Set the time-base triggering controls for a stable display.

c. Check—the crt display for a sine-wave signal amplitude of 5.0 divisions, with no visible distortion of the waveform.

Adjustment—SG 504

d. Set the SG 504 OUTPUT AMPLITUDE control to 5.5. Set the differential comparator deflection factor for 1 V/div.

e. Check—the crt display for a sine-wave signal amplitude of 5.5 divisions.

f. Set the SG 504 internal slide switch, S190, to the 6 MHz position. See Fig. 3-1 for switch location.

g. Set the time-base sweep rate to 50 ns/div; set the triggering controls for a stable display.

h. Check—the crt display for a sine-wave signal amplitude of 5.5 divisions, with no visible distortion of the waveform, and the SG 504 UNLEVELED light remains off.

i. Set the SG 504 OUTPUT AMPLITUDE control to 0.5. Set the differential comparator deflection factor for 0.1 V/div.

j. Check—the crt display for a sine-wave signal amplitude of 5.0 divisions, with no visible distortion of the waveform.

7. Adjust Reference Amplitude at 0.05 MHz

a. Set the time-base sweep rate to 200 μ s/div. Set the SG 504 OUTPUT AMPLITUDE control to 5.0.

b. Connect a 1 kHz, 5 volt square-wave signal from the calibration generator, through a bnc tee connector, to the + input of the differential comparator, using a 50 Ω cable. Connect a 50 Ω cable from the tee connector to the time-base unit external trigger input.

c. Set the differential comparator BW switch to 5 MHz.

d. Set the time-base triggering controls for a stable display; a crt display similar to Fig. 3-2 is obtained.

e. Adjust—5 V P-P Ampl. R280, so the corners of the idealized waveform are aligned as illustrated in Fig. 3-2. See Fig. 3-1 for adjustment location.

f. Set the SG 504 OUTPUT AMPLITUDE control to 0.5.

g. Set the calibration generator for a 0.5 volt, 1 kHz square-wave signal.

h. Set the differential comparator deflection factor for 10 mV/div.

i. Set the time-base triggering controls for a stable display; a crt display similar to Fig. 3-3 is obtained.

j. Adjust—.5 V P-P Ampl. R270, so the corners of the idealized waveform are aligned as illustrated in Fig. 3-3. See Fig. 3-1 for adjustment location.

k. Interaction—repeat parts a through j of this step until best accuracy (corner alignment) is obtained at the 0.5 and 5.0 settings of the SG 504 OUTPUT AMPLITUDE control.

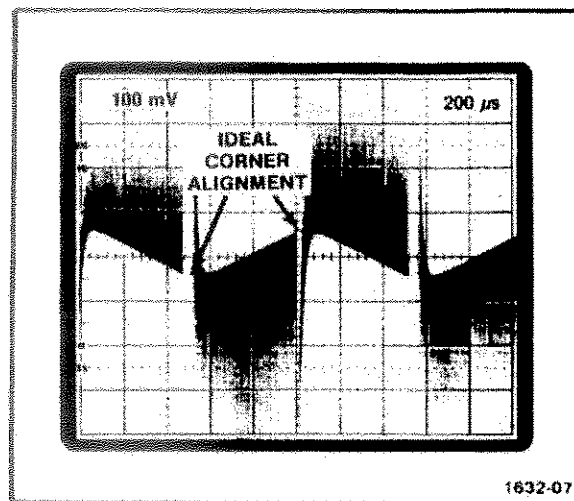

Fig. 3-2. Display of complex waveform (idealized) with 5 volt reference amplitude at 0.05 MHz, properly set.

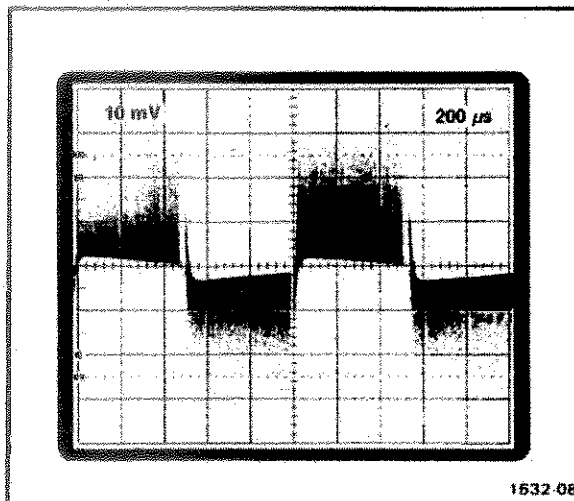

Fig. 3-3. Display of complex waveform (idealized) with 0.5 volt reference amplitude at 0.05 MHz, properly set.

8. Adjust Low Range Harmonic Suppression and Leveling

- a. Set the Spectrum Analyzer controls as follows:

Time/Div	Spectrum
Triggering	
Mode	P-P auto
Source	Free run
Slope	+
Video Filters	30 kHz
Freq Span/Div	Max Span (250 MHz/div)
Resolution	3 MHz
Auto Phase In	
RF dB	50
Reference Level	20 dBm
Ref Var	Cal
Base Line Clipper	Counterclockwise
10 dB/Div	Pushbutton in
Frequency display	Start
Frequency MHz	0100
Fine	Midrange

- b. Connect the SG 504 Output Head to the spectrum analyzer RF input connector.

- c. Set the SG 504 OUTPUT AMPLITUDE control to 5.5. Push in the LOW RANGE pushbutton.

- d. Rotate the SG 504 COARSE control until the dial tape indicates 245 at the cursor line.

- e. Position the zero frequency marker to the left edge of the graticule with the spectrum analyzer position control. A display similar to Fig. 3-4 should be obtained.

- f. Position the fundamental vertically to the top graticule line with the spectrum analyzer position control. See Fig. 3-5 for reference.

- g. Connect the digital voltmeter between R558 test point (top of resistor) and Gnd test point on the Main circuit board. See Fig. 3-1 for test point location.

- h. Adjust—Low Buffer Current, R542, for a meter reading of -15.9 V.

- i. Disconnect the positive lead of the digital voltmeter from R558 test point and connect it to $-14/-23$ V (TP2) test point. See Fig. 3-1 for test point location.

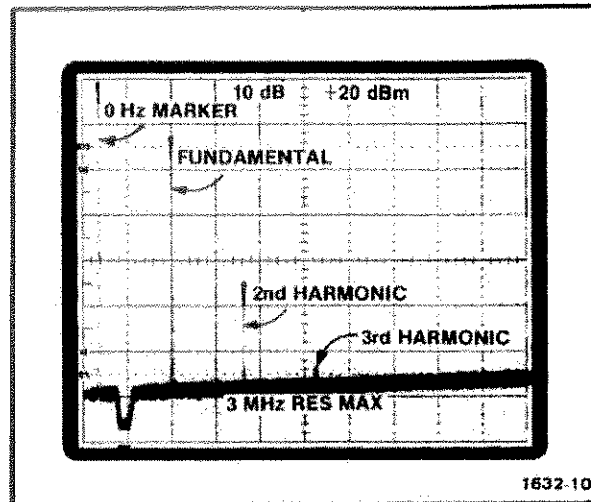

Fig. 3-4. Display of 100 MHz signal and harmonics.

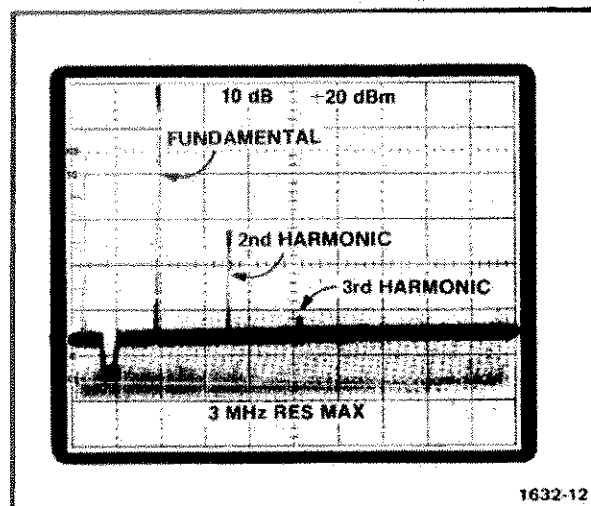

Fig. 3-5. Display of 100 MHz signal with fundamental properly positioned.

- j. Rotate the SG 504 COARSE control from 245 MHz to 550 MHz.

- k. Adjust—Low Band, C125, for a minimum voltage reading on the digital voltmeter. (The minimum voltage point—greater than 14 volts, but less than recorded value in Step 3 part f—is very sensitive to the adjustment of C125.) See Fig. 3-6 for adjustment location.

- l. Disconnect the digital voltmeter and reconnect it across R615. See 3-1 for location.

Adjustment—SG 504

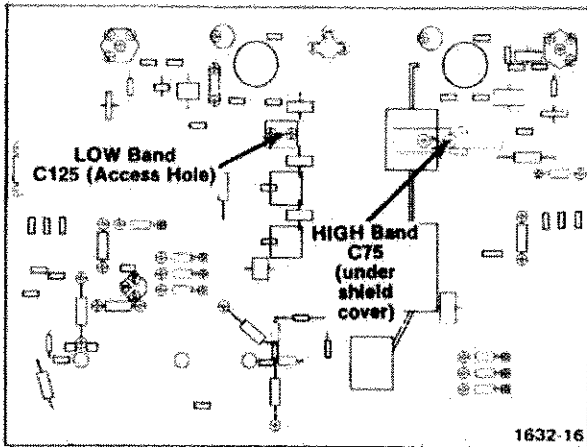

Fig. 3-6. Location of low band and high band adjustments on RF circuit board.

m. Check—slowly rotate the SG 504 COARSE control from 550 MHz to 245 MHz and check that meter reading remains at least 0.5 volt lower than recorded value in Step 4 part c.

n. Check—slowly rotate the SG 504 COARSE control from 245 MHz to 550 MHz and check that the vertical distance (suppression) between the top of the second harmonic and fundamental is at least 2.7 divisions (27 dB); the tops of the third and remaining harmonics are separated at least 4.2 divisions (42 dB). See Fig. 3-5 for reference.

o. Repeat part m of this step while observing the SG 504 UNLEVELED light; it must remain off for all frequencies of the SG 504 LOW RANGE setting. If the light comes on near the upper end of the LOW RANGE setting, a very slight readjustment of C125 should turn it off. If a readjustment is made, recheck the harmonic suppression (part m of this step).

NOTE

The adjustment of C125 affects those frequencies above the middle of the SG 504 LOW RANGE. If the SG 504 UNLEVELED light comes on for frequencies on the lower half of the SG 504 LOW RANGE, or excessive harmonics are noted, a maintenance problem is indicated.

9. Adjust High Range Harmonic Suppression and Leveling

a. Set the spectrum analyzer controls as outlined in Step 6 part a.

b. Check—the SG 504 OUTPUT AMPLITUDE control to 5.5. Push in the HIGH RANGE pushbutton.

c. Rotate the SG 504 COARSE control until the dial tape indicates 495 at the cursor line.

d. Position the zero frequency marker to the left edge of the graticule with the spectrum analyzer position control. A display similar to Fig. 3-4 should be obtained.

e. Position the fundamental vertically to the top graticule line with the spectrum analyzer position control. See Fig. 3-5 for reference.

f. Connect the digital voltmeter between R518 test point (top of resistor) and Gnd test point on the Main circuit board. See Fig. 3-1 for test point location.

g. Adjust—High Buffer Current, R502, for a meter reading of -15.9 V.

h. Check—slowly rotate the SG 504 COARSE control from 495 MHz to 1050 MHz and check that the vertical distance (suppression) between the top of the second harmonic and fundamental display is at least 2.7 divisions (27 dB); the tops of the third and remaining harmonics are separated at least 4.2 divisions (42 dB). See Fig. 3-5 for reference.

i. Repeat part h of this step while observing the SG 504 UNLEVELED light; it must remain off for all frequencies of the SG 504 HIGH RANGE setting. Proceed with parts j through q if the SG 504 UNLEVELED light turns on only near the upper end of the SG 504 HIGH RANGE setting.

NOTE

The adjustment of C75 affects those frequencies above the middle of the SG 504 HIGH RANGE. If the SG 504 UNLEVELED light comes on for frequencies on the lower half of the SG 504 HIGH RANGE, a maintenance problem is indicated.

j. Remove the shield cover from the rf board. High Band adjustment C75 is located near Q70 and is a slug-tuned capacitor. See Fig. 3-6 for reference.

k. Disconnect the positive lead of the digital voltmeter from R518 test point and connect it to $-14/-23$ V (TP2) test point. See Fig. 3-1 for test point location.

l. Set the SG 504 COARSE control to 1050 MHz. If the SG 504 UNLEVELED light is not on, adjust High Band, C75, clockwise until the light just turns on, then turn C75 counterclockwise until the light turns off.

m. Slowly rotate the SG 504 COARSE control from 1050 MHz and observe if the SG 504 UNLEVELED light turns on. If the light is lit, readjust High Band, C75, counterclockwise until the light just turns off. Rotate the COARSE control towards 1000 MHz; adjust C75 counterclockwise if light turns on. Adjust C75 an additional one-third turn counterclockwise beyond the last adjustment.

n. Slowly rotate the SG 504 COARSE control between 1000 MHz and 1050 MHz and note the digital voltmeter reading remains at least 1 volt lower than recorded voltage of Step 3 part f. If the maximum voltage exceeds that value, slightly readjust High Band adjustment C75, counterclockwise for that value.

o. Disconnect the digital voltmeter and reconnect it across R615. See Fig. 3-1 for location.

p. Check—slowly rotate the SG 504 COARSE control from 1050 MHz to 495 MHz, and check that the meter reading remains 0.5 volt lower than recorded value in Step 4 part c.

q. Disconnect the digital voltmeter. Replace the rf shield cover, and repeat parts h and i of this step.

10. Check Harmonic Suppression at 0.5 Volt and 1 Volt (Low and High Range)

a. Set the SG 504 OUTPUT AMPLITUDE control to 0.5.

b. Set the spectrum analyzer RF dB to 30 and Reference Level to 0 dBm.

c. Push in the SG 504 LOW RANGE pushbutton. Check that the fundamental is vertically positioned at the top of the graticule line. See Fig. 3-5 for reference.

d. Check—slowly rotate the SG 504 COARSE control from 245 MHz to 550 MHz and check that the vertical distance (suppression) between the top of the second harmonic and fundamental is at least 2.7 divisions (27 dB); the tops of the third and remaining harmonics are separated at least 4.0 divisions (40 dB). See Fig. 3-5 for reference.

e. Set the SG 504 OUTPUT AMPLITUDE control to 1.0. Set the spectrum analyzer RF dB to 40 and Reference Level to 10 dBm.

f. Repeat parts c and d of this step.

g. Push in the SG 504 HIGH RANGE pushbutton.

h. Repeat parts a through f of this step for the HIGH RANGE position.

i. Set the spectrum analyzer Reference Level to +20 dBm and RF dB to 50.

11. Adjust 6 MHz and Check 0.05 MHz Reference Frequency Accuracy

a. Connect the SG 504 Output Head, through a 50 Ω precision termination, to the input of the counter. Adjust the SG 504 OUTPUT AMPLITUDE control to 1.0.

b. Set the SG 504 internal slide switch, S190, to the 6 MHz position. See Fig. 3-1 for switch location. Push in the SG 504 REF pushbutton.

c. Check—the frequency accuracy at 6 MHz is 6.00, ± 0.06 MHz, as displayed on the counter.

d. Adjust—T200 (6 MHz), for a counter display of 6.00. (The proper position of the tuning slug should be near the bottom of the coil.) See Fig. 3-1 for adjustment location.

e. Set the internal slide switch, S190, to the 0.05 MHz position. See Fig. 3-1 for switch location.

f. Check—the frequency accuracy at 0.05 MHz is within $\pm 2\%$ (0.05 MHz, ± 0.001 MHz).

12. Check Harmonic Suppression of the Reference

a. Set the SG 504 OUTPUT AMPLITUDE control to 5.5; set the internal slide switch, S190, to the 6 MHz position. See Fig. 3-1 for switch location.

b. Set the spectrum analyzer Frequency Span/Div control to 2 MHz, and Resolution to 0.3 MHz; disconnect the Output Head from the spectrum analyzer input connector.

c. Adjust the spectrum analyzer Frequency Coarse control to approximately 0000 MHz; slowly adjust the Frequency Fine control to position the zero marker to the left side of the graticule. Reconnect the Output Head to the spectrum analyzer input connector.

Adjustment—SG 504

d. Check that the fundamental is vertically positioned at the top of the graticule line.

e. Check—that the vertical distance (suppression) between the top of the second harmonic and fundamental is at least 3.3 divisions (33 dB); the tops of the third and remaining harmonics are separated at least 4.2 divisions (42 dB). See Fig. 3-5 for reference.

f. Repeat parts d and e of this step for the 0.5 volt setting of the SG 504 OUTPUT AMPLITUDE control; Reference Level is set to 0 dBm and RF dB is set to 30.

g. Set the spectrum analyzer Reference Level to +20 dBm and the RF dB to 50.

h. Set the SG 504 OUTPUT AMPLITUDE control to 5.0; set the internal slide switch, S190, to the 0.05 MHz position. Disconnect the SG 504 Output Head from the spectrum analyzer input connector. See Fig. 3-1 for switch location.

i. Set the spectrum analyzer Frequency Span/Div control to 20 kHz and Resolution to 3 kHz.

j. Push and release the spectrum analyzer Video Filter pushbutton.

k. Adjust the spectrum analyzer Frequency Fine control to position the zero marker to the left side of the graticule; reconnect the SG 504 Output Head to the spectrum analyzer input connector.

l. Check that the fundamental is vertically positioned at the top of the graticule line.

m. Check—that the vertical distance (suppression) between the top of the second harmonic and fundamental is at least 3.3 divisions (33 dB); the tops of the third and remaining harmonics are separated at least 4.2 divisions (42 dB). See Fig. 3-5 for reference.

n. Repeat parts l and m of this step for the 5 volt setting of the SG 504 OUTPUT AMPLITUDE control; Reference Level is set to 0 dBm and RF dB is set to 30.

o. Set the spectrum analyzer Reference Level to +20 dBm and RF dB to 50.

p. Disconnect the SG 504 Output Head from the spectrum analyzer input connector.

b. Connect the two 50 Ω attenuators in series, and connect the series-connected attenuators to the SG 504 Output Head; connect the other end of the attenuator to the bnc tee connector.

c. Push in the spectrum analyzer Frequency display Center pushbutton; set Frequency MHz to 450, using the Coarse control. Set the Fine control to midrange.

d. Set the spectrum analyzer Frequency Span/Div control to 1 MHz with a resolution of 30 kHz. Check that the 30 kHz video filter is removed (pushbutton out). Set the RF dB to 0 with a reference level of -30 dBm.

e. Push in the SG 504 LOW RANGE pushbutton. Rotate the COARSE control until the dial tape indicates 450 at the cursor line.

f. Set the SG 504 OUTPUT AMPLITUDE control to 4.0.

g. Adjust the spectrum analyzer Frequency Coarse control to horizontally center the 450 MHz marker on the graticule.

h. Check—that the 450 MHz signal from the SG 504 is within 0.5% (± 2.25 MHz, or ± 2.25 divisions).

NOTE

The two markers may coincide during the low frequency range setting. If so, verify the presence of the SG 504 frequency signal by slightly adjusting the SG 504 COARSE control.

i. Set spectrum analyzer Frequency MHz to 750, using the Coarse control; horizontally center the 750 MHz marker on the graticule.

j. Push in the SG 504 HIGH RANGE pushbutton. Rotate the COARSE control until the dial tape indicates 750 at the cursor line.

k. Check—that the 750 MHz signal from the SG 504 is within 0.5% (± 3.75 MHz, or ± 3.75 divisions).

NOTE

The 450 MHz frequency is the mechanical alignment check point for the SG 504 LOW RANGE setting and 750 MHz frequency is the mechanical alignment check point for the SG 504 HIGH RANGE setting.

13. Check Frequency Accuracy (Low and High Range)

a. Connect a bnc tee connector to the RF input of the spectrum analyzer; connect a 50 Ω cable from the bnc tee to the spectrum analyzer cal out connector.

l. Use the spectrum analyzer in essentially the same manner to check the frequency accuracy at the specified check points. All four frequencies must be within 0.5% of their indicated values on the dial tape to assure an over-all accuracy of 2%. Use Table 3-3 as reference for verification of the four frequency check points.

Table 3-3

LOW AND HIGH RANGE FREQUENCY ACCURACY

	SG 504 Frequency Dial Setting	Allowable Deviation from Frequency Marker
Low Range	250 MHz	± 1.25 div (± 1.25 MHz)
Range	550 MHz	± 2.75 div (± 2.75 MHz)
High Range	500 MHz	± 2.50 div (± 2.50 MHz)
Range	1050 MHz	± 5.25 div (± 5.25 MHz)

m. Disconnect the SG 504 Output Head from the spectrum analyzer and proceed to Step 16 (Flatness Check) if all six frequency check points are within their specified limits.

14. Low Range Frequency Adjustment

NOTE

Perform the 450 MHz (Low Range) and 750 MHz (High Range) mechanical alignment check point procedure only if the SG 504 does not meet the frequency accuracy specifications as outlined in Step 13.

a. Repeat parts a through g of Step 13. Be certain that the SG 504 FINE control is set to 0 (centered).

b. To mechanically align the low range tuning section to the 450 MHz alignment point of the dial tape, loosen the two hex-type set screws located on the rear portion of the gear spur. Refer to Fig. 3-7 for reference.

c. Grasp the flexible coupler linking the two tuning sections, and turn the coupler very slowly until the 450 MHz signal from the SG 504 is aligned with the 450 MHz marker. Rotate the SG 504 COARSE control slowly to set the 450 MHz dial tape mark under the cursor line.

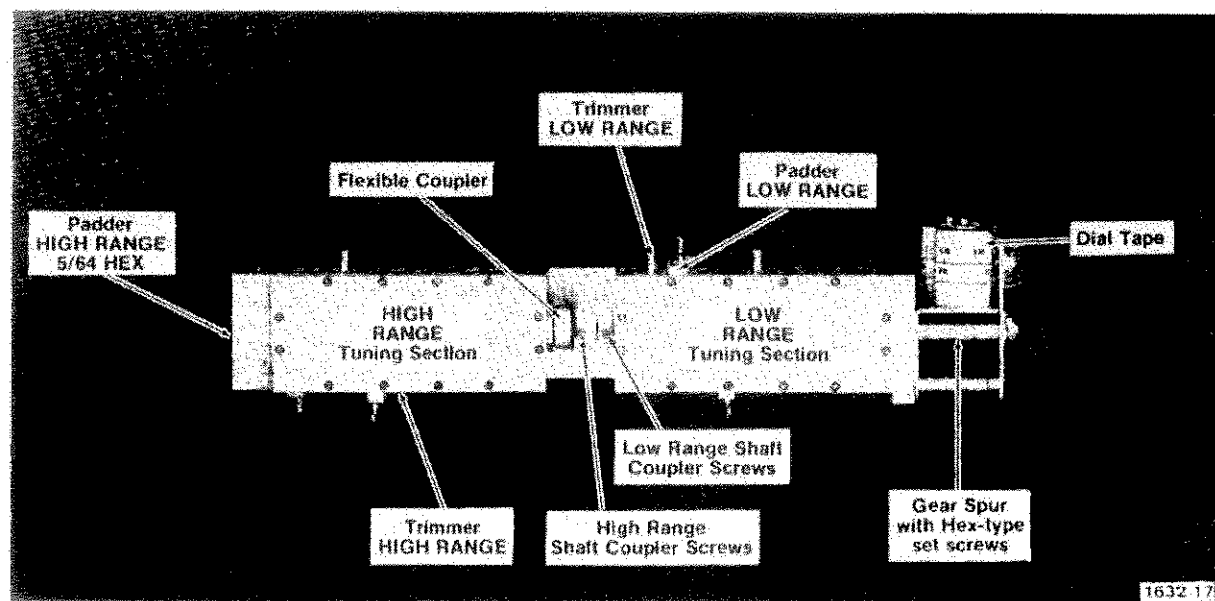

Fig. 3-7. Location of trimmer and padder adjustments on oscillator assembly.

Adjustment—SG 504

d. Tighten the hex-type set screws one at a time while making certain that the SG 504 450 MHz signal and the spectrum analyzer 450 MHz marker coincide. Rotate the SG 504 COARSE control slightly clockwise and counterclockwise to verify coincidence.

e. When mechanical alignment has been achieved, recheck the low range frequency accuracy as outlined in Step 13 part I, using Table 3-3 as reference.

f. If frequency accuracy cannot be obtained as outlined in part e of this step, proceed with the calibration of the Low range tuning section.

g. Set the SG 504 dial tape to 550; set the spectrum analyzer Frequency MHz to 550, using the Coarse control. Horizontally center the 550 MHz marker on the graticule.

h. Adjust—low range trimmer, until the SG 504 550 MHz signal and the spectrum analyzer 550 MHz marker coincide. See Fig. 3-7 for adjustment location.

i. Set the SG 504 dial tape to 250; set the spectrum analyzer Frequency MHz to 250, using the Coarse control. Horizontally center the 250 MHz marker on the graticule.

j. Adjust—low range padder, until the SG 504 250 MHz signal and the spectrum analyzer 250 MHz marker coincide. See Fig. 3-7 for adjustment location.

k. Recheck all three frequency ranges (450 MHz, 550 MHz, and 250 MHz) for 0.5% accuracy limits.

15. High Range Frequency Adjustment

NOTE

The Low Range tuning section must be in mechanical and electrical alignment before any frequency adjustments are made to the High Range tuning section. Refer to Step 14.

a. Push in the SG 504 HIGH RANGE pushbutton. Rotate the COARSE control until the dial tape indicates 750 at the cursor line.

b. Check that the SG 504 OUTPUT AMPLITUDE control is set to 4.0, and the FINE control is set to 0 (centered).

c. Adjust the spectrum analyzer Frequency Coarse control to horizontally center the 750 MHz marker on the graticule.

d. Rotate the SG 504 COARSE control until the 750 MHz signal is aligned with the spectrum analyzer 750 MHz marker.

e. To mechanically align the high range tuning section to the 750 MHz alignment point of the dial tape, loosen the two high range shaft coupler screws located on the rear portion of the flexible coupler. Refer to Fig. 3-7 for reference. Do not loosen the low range shaft coupler screws.

f. Hold the high range shaft with a thin-blade screwdriver, or grip the shaft with long-nose pliers (sides must be ground flat to fit between the case and the flexible coupler). Rotate the SG 504 COARSE control slowly to set the 750 MHz dial tape marker under the cursor line.

g. Tighten the high range shaft coupler screws, making certain the SG 504 750 MHz signal and the spectrum analyzer 750 MHz marker coincide. Rotate the SG 504 COARSE control slightly clockwise and counterclockwise to verify coincidence. (Tighten the flexible coupler screws just enough to hold the shaft firmly. Excessive torque will strip the threads and may damage the shaft).

h. When mechanical alignment has been achieved, recheck the high range frequency accuracy as outlined in Step 13 part I, using Table 3-3 as reference.

i. If frequency accuracy cannot be obtained as outlined in part h of this step, proceed with the calibration of the high range tuning section.

j. Set the SG 504 dial tape to 1050; set the spectrum analyzer Frequency MHz to 1050, using the Coarse control. Horizontally center the 1050 MHz marker on the graticule.

k. Adjust—high range trimmer, until the SG 504 1050 MHz signal and the spectrum analyzer 1050 marker coincide. See Fig. 3-7 for adjustment location.

l. Set the SG 504 dial tape to 500; set the spectrum analyzer Frequency MHz to 500, using the Coarse control. Horizontally center the 500 MHz marker on the graticule.

m. Adjust—high range padder, until the SG 504 500 MHz signal and the spectrum analyzer 500 MHz marker coincide. See Fig. 3-7 for adjustment location.

NOTE

The padder adjustment screw will cause the oscillator to stop if advanced too far clockwise. To check proper setting, turn padder 1/2 turn clockwise beyond optimum adjustment point, then return padder to correct setting. The oscillator must remain active during this check.

n. Recheck all three frequency ranges (750 MHz, 1050 MHz, and 500 MHz) for 0.5% accuracy limits.

o. Disconnect the SG 504 Output Head and all test equipment from the spectrum analyzer.

16. Check Flatness (Peak-to-Peak Amplitude Regulation)

a. Set the SG 504 controls as follow: REF pushbutton in, OUTPUT AMPLITUDE control to 0.5, FREQUENCY MHz setting to 245, and FINE control to 0 (centered).

b. Connect a 2.4 megohm, 5% resistor across the digital voltmeter floating input terminals. Connect the SG 504 Output Head via bnc female-to-GR adapter to the input of the peak-to-peak detector. Use two 50 Ω cables and two dual banana to bnc adapters to connect the output of the peak-to-peak detector to the floating input terminals on the digital voltmeter; maintain correct polarity, HI to + and LO to -. Set the digital voltmeter to the 20 volts dc range.

c. Slowly adjust the SG 504 OUTPUT AMPLITUDE control until the digital voltmeter reading indicates ± 0.00 . Output amplitude from the SG 504 should be about 1.2 volts; this establishes a 0.0% reference setting at 0.05 MHz.

d. Set the SG 504 internal slide switch, S190, to the 6 MHz position. See Fig. 3-1 for switch location.

NOTE

Do not disturb the approximate 1.2 volt setting of the SG 504 OUTPUT AMPLITUDE control, as set in part c of this step; otherwise, an incorrect deviation reading will occur.

e. Check—the flatness deviation from the 0.0% reference setting; the voltage reading of the digital voltmeter should not be greater than 0.5% (.001 volt output from the peak-to-peak detector is equivalent to 0.1%).

f. Push in the SG 504 LOW RANGE pushbutton. Note and record the reading of the digital voltmeter for the flatness deviation at 245 MHz; for example, -0.2% . The total percentage deviation calculation must include the digital voltmeter reading and the calibration factor of the peak-to-peak detector. For example, a reading of -0.002 volt on the digital voltmeter is equivalent to -0.2% deviation. Applying a correction factor of -0.3% algebraically to the -0.2% value, results in a total percentage deviation of -0.5% . Record the actual algebraic sum at this point; it will be used later in the procedure.

g. Retain the 2.4 megohm resistor connected across the digital voltmeter input terminals; disconnect the peak-to-peak detector and all cables.

h. Set the power meter to the 10 mW range and calibration factor for 100.

i. Connect a 50 Ω cable from the power meter recorder output (rear panel) via bnc female to dual-banana adapter to the floating input terminals of the digital voltmeter; maintain correct polarity, HI to + and LO to -.

j. Connect the SG 504 Output Head via bnc female to GR adapter, to a GR-to-N female adapter to the input of the power sensor.

k. Check—that the digital voltmeter reading is between $+0.300$ and $+0.425$; for example, $+0.324$. Note and record the actual reading; it will be used later in the procedure.

l. Slowly rotate the SG 504 COARSE control clockwise from 245 MHz to 550 MHz, as indicated on the dial tape; check for a maximum and minimum digital voltmeter reading while sweeping over the entire low frequency band. Note and record the maximum and the minimum reading.

NOTE

Consult the power sensor calibration chart to determine the calibration factor correction points for the power meter front-panel calibration factor setting. A 99 or 98 calibration factor may be needed.

Adjustment—SG 504

m. Push in the SG 504 HIGH RANGE pushbutton; slowly rotate the SG 504 COARSE control counterclockwise from 495 MHz to 1050 MHz, as indicated on the dial tape. Check for a maximum and minimum digital voltmeter reading while sweeping over the entire high frequency band (observe possible need for a power meter calibration factor setting to 99 or 98 at the proper frequency points). Note and record the most maximum and minimum reading obtained over the two bands (parts l or m of this step). For this example only, a maximum reading of +.330 and a minimum reading of +.315.

n. Itemize the collected data from parts f through m of this step and perform the following calculations to compute the flatness deviation. For example:

1. Flatness deviation at 245 MHz = -0.5% (part f).
2. Reference number on digital voltmeter = +.324 (part k).
3. Maximum reading on digital voltmeter = +.330 (part m).
4. Minimum reading on digital voltmeter = +.315 (part m).

Calculate the difference between the reference number obtained in part k of this step (+.324), and the maximum and minimum values obtained in part m of this step. The differences from the maximum number will be a positive value and the difference from the minimum number will be a negative value. For this example:

$$\begin{aligned} (+.330) - (+.324) &= +.006 \\ (+.315) - (+.324) &= -.009 \end{aligned}$$

To convert the difference values into percentage, divide each result by the reference number; multiply by 100, and then divide by 2:

$$\frac{+.006}{+.324} \times 100 = \frac{+.185}{2} = +0.93\%$$

$$\frac{-.009}{+.324} \times 100 = \frac{-2.78}{2} = -1.39\%$$

Algebraically add the flatness deviation at 245 MHz (part f of this step) to both percentage values:

$$\begin{aligned} (+0.93\%) + (-0.5\%) &= +0.43\% \\ (-1.39\%) + (-0.5\%) &= -1.89\% \end{aligned}$$

For this example of computing the flatness deviation, the +0.43% value represents the maximum deviation above the 0.05 MHz reference amplitude and the -1.89% value represents the maximum deviation below the 0.05 MHz reference amplitude. Maximum flatness deviation from the 0.05 MHz reference amplitude should not exceed 3%.

o. Use two 50 Ω cables and two dual banana to bnc adapters to connect the output of the peak-to-peak detector to the floating input terminals of the digital voltmeter; maintain correct polarity, HI to + and LO to -.

p. To check flatness deviation at a higher output from the SG 504, insert two X2 attenuators between the SG 504 Output Head and the peak-to-peak detector.

q. Set the SG 504 internal slide switch, S190, to the 0.05 MHz position. Push in the SG 504 REF pushbutton. See Fig. 3-1 for switch location.

r. Slowly adjust the SG 504 OUTPUT AMPLITUDE control until the digital voltmeter reading indicates $\pm .000$. Output amplitude from the SG 504 should be about 4.8 volts; this establishes a 0.0% reference setting at 0.05 MHz. Set the internal slide switch, S190, to the 6 MHz position. See Fig. 3-1 for switch location.

s. Check—the flatness deviation from the 0.0% reference setting; the voltage reading of the digital voltmeter should not be greater than 0.5% (.001 volt output from the peak-to-peak detector is equivalent to 0.1%).

NOTE

Do not disturb the approximate 4.8 volt setting of the SG 504 OUTPUT AMPLITUDE control, as set in part r of this step; otherwise, an incorrect deviation reading will occur.

t. Push in the SG 504 LOW RANGE pushbutton. Note and record the reading of the digital voltmeter for the flatness deviation at 245 MHz. (Refer to part f of this step for correction factor explanation.)

u. Disconnect the peak-to-peak detector, two X2 attenuators, and all cables.

v. Change power meter to 10 mW and repeat step h.

w. Connect the SG 504 Output Head to the input of the power sensor.

x. Check—that the digital voltmeter reading is between +.485 and +.675. Note and record the actual reading; it will be used later in the procedure.

y. Slowly rotate the SG 504 COARSE control clockwise from 245 MHz to 550 MHz, as indicated on the dial tape; check for a maximum and minimum digital voltmeter reading while sweeping over the entire low frequency band. Note and record the maximum and minimum reading.

NOTE

Consult the power sensor calibration chart to determine calibration factor correction points for the power meter front-panel calibration factor setting. A 99 or 98 calibration factor may be needed.

z. Repeat part m of this step (disregard the example readings given, as new readings will be recorded).

aa. Itemize the collected data from parts t through y of this step and perform the calculations as outlined in part n of this step.

ab. Set the SG 504 controls as follows: OUTPUT AMPLITUDE to 0.5, LOW RANGE pushbutton in, FINE control to 0 (centered), and FREQUENCY MHz setting to 245.

ac. Disconnect the SG 504 Output Head from the power sensor.

17. Check Amplitude of Frequency Monitor Output

a. Connect a 50 Ω , X10 attenuator to the SG 504 Output Head; connect a 50 Ω termination to the X10 attenuator.

b. Remove the adapters from the power sensor and connect a bnc male to N female adapter to the power sensor; connect the power sensor to the SG 504 FREQ MONITOR OUT connector.

c. Set the power meter to the 3 mW range and calibration factor control to 100.

d. Slowly rotate the SG 504 COARSE control clockwise from 245 MHz to 550 MHz on the low band, as indicated on the dial tape; then, switching to the high band, rotate the SG 504 COARSE control counterclockwise from 1050 MHz to 495 MHz, while observing the power meter reading. The minimum reading on the power meter over the entire frequency band should not be less than 0.25 mW.

e. Set the SG 504 OUTPUT AMPLITUDE control to 1.0 volt, 2.0 volts, and 3.5 volts. Repeat part d of this step for each of the output amplitude voltage settings. The power meter reading should not be less than 0.25 mW at each voltage setting.

f. Disconnect all cables.

This completes the Adjustment procedure of the SG 504 Leveled Sine Wave Generator.

MAINTENANCE AND INTERFACING INFORMATION

Preventive Maintenance

There are no special preventive maintenance procedures that apply to the SG 504. Refer to the power module instruction manual for general preventive maintenance procedures and instructions.

Corrective Maintenance

Refer to the power module instruction manual for general corrective maintenance procedures and instructions.

System Maintenance

System maintenance procedures are provided in the power module manual; i.e., preventive maintenance, troubleshooting aids, parts removal and replacement procedures, parts ordering information, etc.

Oscillator Performance (LOW or HIGH RANGE)

To determine if an oscillator section is functioning properly, perform the following procedure. Remove the coaxial cable from the oscillator section and connect a Selectro-to-bnc adapter cable, listed in the Accessories section of this manual, to the oscillator section under test. Connect a 10X attenuator to the bnc end of the cable and connect the attenuator to the input of the power sensor/power meter system. Unsolder the voltage connection (labeled Oscillator Supply) from the oscillator section under test. Apply an external -22 V supply between the oscillator voltage input and ground. Be certain of the voltage polarity before making connection; a positive voltage with respect to ground at this point may damage the oscillator section.

The power output from an oscillator section under test must fall within the following milliwatt range for the frequencies listed.

Table 4-1

POWER LIMITS FOR OSCILLATOR

SG 504 Frequency Range	Dial Setting	Power Limits
LOW RANGE	245 MHz	30 mW - 65 mW
LOW RANGE	550 MHz	45 mW - 100 mW
HIGH RANGE	495 MHz	45 mW - 75 mW
HIGH RANGE	1050 MHz	120 mW - 175 mW

The oscillator section(s) are not customer serviceable. If an oscillator section is not functioning properly, send the entire instrument to the nearest Tektronix Service Center. Do not send any oscillator section for repair without the instrument.

Servicing and Replacing Output Buffer Amplifiers

WARNING

The ceramic portions of Q70 and Q120 contain BERYLLIUM OXIDE as a major ingredient. Beryllium Oxide heat sinks are safe under most conditions. The only hazard is that a toxic effect may occur if Beryllium Oxide fumes or fine particles are inhaled. Grinding, crushing, or heating above 1800° F can produce fumes or fine particles. Avoid such action and subsequent inhalation to assure the absence of any hazard. No hazard is present in normal instrument operation or maintenance. Disposal of transistors containing Beryllium Oxide should be handled in such a manner to ensure that no future hazard will exist.

Due to high-frequency loading effects when troubleshooting the circuits of Q70 or Q120 with the power on, do not place a probe directly to the base of either transistor. If it becomes necessary to measure the base-emitter (bias) voltage of Q70 or Q120, place the proper probe at the junction of L52-R54 or at the junction of L102-R104 and the other probe on the emitter. The normal operating bias for either transistor is between 0.7 V and 0.85 V at the low end of the LOW or HIGH RANGE of the SG 504.

Maintenance and Interfacing Information—SG 504

To replace Q70 or Q120, first remove the four connectors to the rf board. Remove the cover of the rf board by removing the eight screws holding it in place. Next, remove the rf board by removing the four screws holding it to the main circuit board and lift the rf board out. Remove the nut holding the defective transistor to the heat sink. Unsolder the leads of the defective transistor and remove the transistor. Pay particular attention to the spring washer between the heat sink and the rf board; the spring washer must be in place when the transistor is re-installed. The spring washer should stay in place. If it becomes dislocated do not loosen the nuts holding the heat sink to the board; use another means to center the spring washer before replacing Q70 or Q120. Use a solder wick instead of a suction device to unsolder the transistor leads.

To re-install Q70 or Q120, trim the leads to their proper lengths and insert the transistor through the holes in the rf board, the spring washer, and the heat sink. Be certain that the collector lead is properly oriented and maintains its orientation while tightening the nut on the transistor stud. Be certain to replace the flat washer between the stud nut and the heat sink. Torque the nut holding the transistor to the heat sink to six inch-pounds. Solder the transistor leads in place.

In order to avoid grounding the collector tabs of Q520 or Q560, do not reapply power to the instrument until the High Range coaxial cable is reconnected.

Replacement of Q520 or Q560

If it becomes necessary to replace either of these transistors, note the orientation of the bevel on the transistor case. The emitter terminal of Q520 and Q560 is on the beveled side of the case. Proper orientation of Q520 and Q560 is shown on the Parts Location Grid and by a dot on the circuit board which indicates the emitter connection. The metal tabs are connected to the collector terminal.

Dial Tape Mechanism

NOTE

In order to facilitate re-calibration of the oscillator sections when it becomes necessary to repair the dial tape mechanism, it is suggested that the oscillator be tuned for a 450 MHz output signal before removing the oscillator sections.

The oscillator sections must be removed to repair or replace the dial tape or its associated mechanism. To remove the oscillator sections, first remove the rf board according to the instructions under the heading Servicing and Replacing Output Buffer Amplifiers. Unsolder the four

connections to the Low and High Range sections (Oscillator Supply, Oscillator Varactor). Remove the front panel COARSE knob plus the nut and washer holding the bushing to the front panel. Remove the five screws holding the oscillator sections to the main circuit board and slide both sections backwards until the oscillator shaft clears the front panel.

To remove the dial tape from its mounting, remove the two retaining rings, the two flat washers, and the tape retaining plate. Carefully remove the dial tape with its rollers. Do not bend or distort the Teflon washers under the tape rollers.

A new dial tape comes with one roller (similar to a typewriter ribbon). To replace a new dial tape, start the new tape on the roller that was in the original assembly and unroll the tape until the 450 MHz calibration mark is centered between the two rollers. Slightly turn the oscillator shaft so that the four set screws attaching the gear to the oscillator shaft are accessible through the lower left quadrant of the assembly. Place the dial tape rollers over the support posts so that the teeth in the tape are engaged with the gear. Be certain that the two Teflon washers are between the rollers and the mounting; a bent or distorted Teflon washer may bind the tape. Replace the tape retaining plate, flat washers, and retaining rings in that order. Apply Lubriplate to the total length of the top edge of the new tape.

After replacing the dial tape, the oscillator sections, the control knob, and the rf board refer to the appropriate steps in the Adjustments Procedure for detailed information that describes how to calibrate the oscillator sections to the tape dial readings.

Checking the Output Head

If the SG 504 is not operating properly, and calibration does not correct the problem, then an Output Head malfunction is the likely cause and should be checked for a possible defect.

Turn off the power and check that the five dc control connections between the harmonica connector (P265) located on the main circuit board, and the front-panel connector (J260) are properly made. Inspect the pins in J260 and P260 to verify that no pin is bent or broken. Also, check the internal wiring on P260 to verify that wires are not broken, frayed, or shorted together.

Perform the following check steps to determine if possible defects exist in the Output Head. If any of the readings are significantly different than those listed in the check steps, a defect in the Output Head can be assumed. If that is determined, return it to the nearest Tektronix Field Service Center, as it is not customer repairable.

CAUTION

Before using an ohmmeter, determine the polarity of the test leads. Identify or label the + and - voltage leads. This is especially important when testing circuits that contain diodes. When testing diodes with an ohmmeter do not use an ohmmeter scale where the voltage between the test leads exceeds the diode break-down rating or causes excessive forward current to flow through the diode(s). For the SG 504 Output Head the open-circuit voltage between the ohmmeter test leads should not exceed 26 volts and the maximum short-circuit current should not exceed 20 mA. A TEKTRONIX DM 501 or DM 502 meets these requirements.

Disconnect the harmonica connector (P265) from the main circuit board, and disconnect the coaxial (signal) cable from the front-panel connector. Remove all terminations from the Output Head and proceed with the checks as follows:

1. Resistance between coaxial cable input and head output should be between 49.3 Ω and 51.3 Ω .
2. Resistance between the input of the coaxial cable and ground should be between 1.3 k Ω and 1.8 k Ω .
3. Resistance between pin 2 of P265 and ground should indicate an open circuit.
4. Resistance between pin 3 of P265 and ground should indicate an open circuit.
5. Connect + voltage lead of ohmmeter to pin 2 of P265. Resistance between pin 2 of P265 and coaxial cable input should indicate an open circuit.
6. Resistance between pin 1 of P265 and ground should indicate between 0.9 k Ω and 1.1 k Ω .
7. Ground pin 1 of P265 and connect the - voltage lead of the ohmmeter to pin 4. Using the 2 k Ω scale on the TEKTRONIX DM 501 or DM 502, the resistance between pin 4 of P265 and ground should indicate between 0.9 k Ω and 1.7 k Ω . (Value in ohms is valid only for 1 mA of measurement current.)
8. Connect + voltage lead of ohmmeter to pin 2 of P265. Using the 2 k Ω scale on the TEKTRONIX DM 501 or DM 502, the resistance between pins 2 and 3 of P265 should indicate between 0.9 k Ω and 1.2 k Ω . (Value in ohms is valid only for 1 mA of measurement current.)
9. Connect + voltage lead of ohmmeter to pin 4 of P265. Resistance between pin 4 of P265 and ground should indicate an open circuit.
10. Connect + voltage lead of ohmmeter to pin 4 of P265. Resistance between pins 3 and 4 of P265 should indicate an open circuit.
11. Connect + voltage lead of ohmmeter to pin 4 of P265. Resistance between pins 1 and 4 of P265 should indicate an open circuit.
12. Connect + voltage lead of ohmmeter to pin 3 of P265. Resistance between pins 2 and 3 of P265 should indicate an open circuit. If a diode checker or transistor curve trace is available, a reverse breakdown of 26 V or greater at 0.5 μ A should be measured. Do not exceed 0.5 μ A of current for the reverse breakdown test.
13. Apply an external 10 volts (peak-to-peak), 50 kHz sine wave to the input of the coaxial cable. A dc voltage of approximately 9.3 volts should be indicated between pins 2 and 3 of P265 (pin 3 positive with respect to pin 2).

Checking Power Supply Ripple

To check the ripple on the following power supplies, differential measurements must be made. This requires an oscilloscope with a differential amplifier unit. Power supply ripple checks are to be made only on the Low or High Range of the SG 504. Attach one differential amplifier probe to the test point labeled power supply gnd and make differential measurements to check for the following limits:

1. -18 Volt supply; equal to or less than 1 mV, peak-to-peak.
2. +5.2 Volt supply; equal to or less than 3 mV, peak-to-peak.
3. -14/-23 Volt Oscillator Supply; equal to or less than 2 mV, peak-to-peak.

Troubleshooting

Use the Performance Check, Adjustment Procedure, and Circuit Description as aids to locate trouble in the event of equipment failure. The test equipment listed in the Performance Check and Adjustment Procedure will prove useful in troubleshooting the SG 504.

Maintenance and Interfacing Information—SG 504

Functions Available at Rear Connector

A slot between pins 23 and 24 on the rear connector identifies the SG 504 as a member of the signal source family. Insert a barrier in the corresponding position of the power module jack to prevent other than signal source plug-ins from being used in that compartment. This protects the plug-in should specialized connections be made to that compartment. Consult the Building A System section of the power module manual for further information.

Signal outputs, or specialized connections, may be made to the rear interface connectors as shown in Fig. 4-1. The instrument is not wired with these connections. The following connections apply to the SG 504.

Frequency Monitor Output. To use this feature, pull the end of the blue coaxial cable from the rear of the front-panel FREQ MON OUT connector. Connect the free end of the cable to the connector marked Freq Mon, located at the rear interface connector. Refer to Fig. 3-1 for location.

FM Input. To use this feature, pull the end of the red/white coaxial cable from the rear of the front-panel FM INPUT connector. Connect the free end of the cable to the connector marked Ext Fm, located at the rear interface connector. Refer to Fig. 3-1 for location.

Remote Amplitude Control. This feature allows external amplitude control of the output signal through the rear interface connector. To use this feature, make the following changes, using Fig. 3-1 as reference: Unsolder and lift the upper end of the link jumper, W265, from the circuit board. Place one end of a wire into the vacant circuit board hole, and solder the wire end; place the opposite end of the

wire into the top hole of a double-hole-pair, marked Remote, located at the rear interface connector. Solder the wire end. Finally, connect a 51 k Ω 1/4 W, 5% resistor between the bottom hole of the pair and the hole below the word Remote. Solder the resistor to the circuit board.

The voltage range at pin 21B for full amplitude control of the output signal is -1 V to -11 V maximum. The -1 V provides minimum output amplitude while -11 V provides maximum output amplitude. Do not exceed -11 V.

REPACKAGING FOR SHIPMENT

If the SG 504 is to be shipped to a Tektronix Service Center for service or repair, disconnect the Output Head cables from the front-panel connectors before packaging the instrument and Output Head. Attach a tag showing: owner (with address) and the name of an individual at your firm that can be contacted. Include complete instrument serial number and a description of the service required.

Save and re-use the package in which your instrument was shipped. If the original packaging is unfit for use or not available, repackage the instrument as follows:

Surround the instrument with polyethylene sheeting to protect the finish of the instrument. Obtain a carton of corrugated cardboard of the correct carton strength and having inside dimensions of no less than six inches more than the instrument dimensions. Cushion the instrument by tightly packing three inches of dunnage or urethane foam between carton and instrument, on all sides. Seal carton with shipping tape or industrial stapler.

The carton test strength for your instrument is 200 pounds.

Remarks	Function	Pin B		Pin A	Function	Remarks
User installed	Frequency Monitor Output Ground	28	Signal Source Barrier Slot ↓	28	Frequency Monitor Output	User installed
		27		27	Frequency Monitor Output Ground	User installed
		26		26		
User installed	FM Input Ground	25		25		
User installed	FM Input	24		24		
		23		23		
User installed	Remote Amplitude Control Ground	22		22		
User installed	Remote Amplitude Control	21		21		
		20		20		
		19		19		
		18		18		
		17		17		
		16		16		
		15		15		
		14		14		
	25 V ac winding	13		13	25 V ac winding	
	+33.5 V filtered dc	12		12	+33.5 V filtered dc	
	Collector lead of pnp series-pass	*11		11*	Base lead of pnp series-pass	
	Transformer shield	10		10*	Emitter lead of pnp series-pass	
	±33.5 V common return	9		9*	±33.5 V common return	
	-33.5 V filtered dc	*8		8*	-33.5 V filtered dc	
	Collector lead of npn series-pass	*7		7*	Emitter lead of npn series-pass	
	No connection	6		6*	Base lead of npn series-pass	
	17.5 V ac winding	5	5	17.5 V ac winding		
	+11.5 V common return	*4	4*	+11.5 V common return		
	+11.5 V common return	3	3	+11.5 V common return		
	+11.5 V filtered dc	*2	2*	+11.5 V filtered dc		
	25 V ac winding	*1	1*	25 V ac winding		
		B		A		

Rear view of plug-in

Assignments listed for pins 1A-13A and 1B-13B are available in all power modules; however only those pins marked with an asterisk (*) are used by the SG 504.

1632-18

Fig. 4-1. Input/Output assignments for plug-in rear interface connector contacts.

CIRCUIT DESCRIPTION

Introduction

This section of the manual contains a description of the circuitry used in the SG 504 Leveled Sine Wave Generator. Individual descriptions are separated into the following parts: Amplitude Reference Oscillator and Buffer Amplifier, Frequency Modulating Circuitry, Low Band Oscillator and Buffer, High Band Oscillator and Buffer, Shunt-Series PIN Diode Current Shapers, Leveling Output Head and Amplifier, Uneveled Lamp Drivers, -18 V Supply, Buffer Current Supply, Over-Voltage Protection, -14/-23 V Oscillator Supply, and +5 V Supply. The circuit titles correspond to those listed in the Block Diagram. The numbered diamond by each title refers to the corresponding circuit diagram in the Diagrams section of this manual.

General

The SG 504 consists of a .05 MHz or 6 MHz Hartley amplitude reference oscillator, two transistorized cavity oscillators, and the necessary buffer amplifiers. Constant amplitude output from the generator is controlled by a variable power supply and low and high band PIN diode attenuators. The leveling amplifier drives both the oscillator supply and PIN diode current shaping amplifiers, and is driven by the peak-to-peak detector in the output head. Also included are the FM circuitry and the necessary power supplies.

Amplitude Reference Oscillator and Buffer Amplifier 1

The reference output frequency of .05 MHz or 6 MHz is generated by Q190 operating as a Hartley oscillator. The tank circuit for the .05 MHz reference signal is composed of T205, C205 and C207, and for the 6 MHz reference signal, T200 and C200. The tank circuits are switched by an internal slide switch (S190) for the reference frequency desired. Oscillator feedback is taken from the first tap on either coil (Pin 3 on T200 or Pin 2 on T205) through R196 and C195. The signal to buffer amplifier transistor Q220 is also taken from this first tap through C220. Diodes VR230, CR230, CR232, and VR232 serve as output voltage limiting diodes. Transistor Q215 is a current switch for the output buffer amplifier (Q220). When the REF button on the front panel is pushed, a negative voltage from the oscillator power supply is applied to the emitter of Q190. This voltage energizes the oscillator. The oscillator obtains collector voltage from the +5 V supply through the emitter-base junction of Q215 and R212. This action causes Q215 to conduct, supplying current to the buffer amplifier transistor (Q220). When the reference oscillator is inoperative, no current flows through the base-emitter

junction of Q215, thus removing current from Q220. The output amplitude of the reference oscillator is controlled by varying the emitter voltage supplied to Q190 from the oscillator power supply. The oscillator power supply is driven by the leveling amplifier (U295). The output from the reference oscillator is applied through L178 to the output head.

Frequency Modulating Circuitry 1

This circuitry consists of operational amplifier U25 which is driven by two basic inputs: the FINE control, R15, or an externally applied signal to the FM INPUT on the front panel. The output voltage from the operational amplifier varies the frequency of the high and low varactor controlled oscillators over a narrow range. If the FINE control is moved in the cw direction, pin 2 of U25 moves slightly positive with respect to pin 3. This causes pin 6 to go negative. This increases the amount of back bias on the varactor diodes, reducing their capacitance. This action raises the output frequency. The opposite is true when the FINE control is moved in the ccw direction.

The modulating signal is also connected to pin 2 of operational amplifier U25 through R12. When the modulating signal goes in the positive direction, the output of the operational amplifier goes negative, increasing the back bias on the varactor diodes. The output frequency increases in proportion to the amplitude of the modulating signal. The output voltage at pin 6 of U25 varies from about -3 V to about -21 V. When the FINE control is centered, the output voltage at pin 6 is about -12 V. Supply voltage to U25 is regulated by VR25. Diodes CR30 and VR30 provide protection for excessive negative voltage at the modulating input. Protection for excessive positive voltage at the modulating input is accomplished by limiting the negative supply voltage for U25 to about 25 V.

Low Band Oscillator and Buffer 1

When the LOW button is pressed, voltage is applied from the oscillator voltage supply to the low band transistorized cavity oscillator. The output from the oscillator is applied (through C97 and C99 and their associated components serving as a matching network) to the base of low band buffer transistor Q120. As the input impedance of the buffer transistor is less than 50 Ω , a matching network is required to match the output of the cavity (which is about 50 Ω) to the buffer transistor. The -12 V bias supply is isolated from the output signal through L102, C102, and C104. The emitter is ac grounded via C110, C112, C114, and C116 and isolated via L108 from

Circuit Description—SG 504

the emitter power supply. The output from the buffer is taken from the collector of Q120, then fed through a low-pass filter to the 50 Ω PIN diode attenuator. (L125, L126, and L128, along with their associated capacitors, form the low pass filter and matching network.) Collector dc current for Q120 flows to ground through L130, acting as a rf choke. The frequency monitor output is taken from the PIN diode attenuator input.

The signal now flows through low band series PIN diode CR130. As described later under the heading PIN diode current shaper, increasing the dc current flow through CR130 reduces the attenuation through the diode. Rf chokes L135 and L130 provide the dc path. High band series PIN diode CR80 (for the non-operating oscillator) has no dc current flowing, therefore isolating that buffer. The output signal flows in a 50 Ω environment, past shunt PIN diodes CR155, CR158, and CR160 to the output head. Shunt PIN diode control voltage is applied to the three shunt diodes via L150. Capacitors C147 and C150 isolate the shunt diode control voltage from the output and the series diodes. Low band capacitor C125 allows proper adjustment of the oscillator at the 550 MHz frequency point.

High Band Oscillator and Buffer 1

This circuitry is similar to the Low Band Oscillator and Buffer. The oscillator is also a transistorized cavity with an output impedance of approximately 50 Ω . The output signal from the cavity flows through a network that matches the lower impedance at the input of Q70, the buffer amplifier. This network is composed of C47, C49, C50, L45, L48, and R45. Toroid L52 serves to isolate the transistor bias supply from the signal; L58 isolates the emitter current supply from any signal appearing on the emitter of the buffer transistor. The various capacitors connected from the emitter of Q70 to ground ensure that the emitter of Q70 remains at ac ground for all frequencies involved. Output from Q70 is taken from the collector and fed through a low pass filter to high band series PIN diode CR80. This network also matches the output impedance of Q70 to the 50 Ω PIN diode attenuator input. The high band signal is fed to the output head through CR80 and past the shunt PIN diodes. High band capacitor C75 allows proper adjustment of the oscillator at the 1050 MHz frequency point.

Shunt-Series PIN Diode Current Shapers 2

The output from leveling amplifier U295 pin 6 is applied to the + input (pin 3) of U335A, and the - input (pin 6) of U335B. Operational amplifier U335A drives the current-shaping transistors for the shunt PIN diodes; U335B drives the series PIN diode current-shaping transistors. PIN diodes CR80 and CR130 are in series with the output signal, while PIN diodes CR155, CR158, and CR160 shunt the output signal to ground.

If the output signal increases due to decreased loading, pin 2 of U295 goes positive, upsetting the balance in the feedback loop. Pin 6 of U295 goes negative, causing pin 3 of U335A and pin 6 of U335B to also go negative. Pin 1 of U335A goes negative, increasing current flow in transistors Q380, Q395, and Q405. This action increases current flow through Q410 and Q415; consequently the shunt PIN diodes. Increased current through the shunt PIN diodes reduces the output signal amplitude and restores signal balance. Pin 7 of U335B moves in the positive direction, reducing current flow in Q345 and Q355. This action cuts back on current flow in Q365 and Q370, therefore decreasing current in the series PIN diodes. In summary, the output signal is reduced.

The current shapers are designed so the input impedance of the series and shunt combination approximates 50 Ω for all attenuation ratios. Resistors R418, R420, and R422 set the bias current to the series PIN diodes in the attenuators, so that the attenuator input impedance remains approximately 50 Ω at maximum attenuation.

Leveling Output Head and Amplifier 2

Operational amplifier U295 serves as the leveling amplifier. The voltage at the + terminal, pin 3 (about -0.8 V) is set by current flowing from the -18 V supply through R288 and a diode-resistor network in the output head to ground. This output head diode-resistor circuit provides temperature compensation. The voltage difference between the peak-to-peak detector circuit in the head and the voltage level set by R275 (the OUTPUT AMPLITUDE VOLTS control), drives pin 2 of U295 with respect to pin 3. The OUTPUT AMPLITUDE VOLTS control sets a dc reference voltage, while the actual output signal amplitude sets the comparison voltage. Under leveled operating conditions, the voltage at pins 2 and 3 of U295 match. When the OUTPUT AMPLITUDE VOLTS control is moved to increase the output amplitude, pin 2 of U295 goes negative, causing pin 6 to move in the positive direction. This action increases output from the oscillator or reduces PIN diode attenuation until the dc voltage from the peak-to-peak detector again establishes equilibrium at the input of U295. The leveled operating range of voltage on pin 6 of U295 varies from about -13 V to 0 V.

Unleveled Lamp Drivers 1 2

When pin 6 goes more positive than about 0.6 V, steering diode CR318 turns Q315 on and illuminates the UNLEVELED light. This indicates that the maximum available output signal is passing through the buffer amplifier. If pin 6 goes more negative than -15 V, Q305 turns off and CR310 conducts, turning Q315 on illuminating the UNLEVELED lamp. This is caused by disconnecting the output head control cable, which results in pin 3 of U295 going more negative than pin 2. This drives pin 6 to its negative limit, which reduces the oscillator output and increases PIN diode attenuation.

A second protection circuit prevents excessive signal voltages from developing if the signal cable to the output head is disconnected while the control cable is connected. With the signal cable connected, there is a 1.5 k Ω resistance in the output head to ground that holds Q170 off. With the signal cable disconnected, the base of Q170 moves toward -12 V. Since Q170 is saturated, its collector now rests at ground. This action moves pin 2 of U295 in the positive direction, increasing attenuation in the PIN diode attenuator or reducing oscillator output. This positive going voltage at pin 2 also turns Q305 off, causing CR310 to conduct. This action turns Q315 on and illuminates the UNLEVELED lamp.

-18 V Supply

The -18 V supply is obtained from the -33.5 V dc supply which is in turn supplied by the power module. The -33.5 V passes current through the series-pass pnp transistor located in the mainframe. This transistor is controlled by U580, an integrated circuit precision voltage regulator. Adjustment of R590 sets the -18 V output level through pin 9 of U580. Pin 9 sets the base current for the series-pass transistor. If the total current through R604 and R605 exceeds approximately 400 mA, Q600 comes into conduction. This action reduces the base current in the series-pass transistor, limiting current to the load.

A -12.4 V base bias voltage for the low and high buffers is obtained by R525 and R526, and the emitter follower action of Q530 connected between the -18 V supply and ground.

Buffer Current Supply

Emitter current for the high buffer comes from the -18 V supply. Operational amplifier U510A, adjusted by R502, sets the voltage across R518 to determine this current. Emitter current for the low buffer also comes from the -18 V supply. Operational amplifier U510B, adjusted by R542, sets the voltage across R558. Proper adjustment here reduces the harmonic content of the output signal and allows for the maximum leveled output signal.

Over-Voltage Protection

An over-voltage protection circuit is provided for both the -18 V supply and the -14/-23 V oscillator supply through the use of Q650, Q655, and Q660. If the -18 V supply moves to an approximate -23 V, Q655 turns on, triggering Q660 into conduction. This action shorts the -18 V supply to ground. If the -14/-23 V supply reaches

-26 V, Q650 conducts and triggers Q660 on with the same results. Once Q660 is turned on, the instrument must be shut off and turned back on in order to reset this scr.

-14/-23 V Oscillator Supply

Current from the floating 25 V ac supply in the mainframe is bridge rectified by CR610. Approximately -23 V is added to -18 V providing about -41 V for the FM circuitry, as well as supplying about -39 V with respect to ground, to the emitter of the npn series-pass transistor located in the mainframe. This -41 V and -39 V increases by about 2 V when switching to the reference oscillators from the high or low variable frequency cavity oscillators.

Resistors R624 and R625 provide -10 V at the base of Q620. Transistors Q620 and Q630 form an emitter-coupled pair that operates as a voltage comparator. Resistors R630 and R634 establish the -14 V supply voltage at the collector of Q630 when Q640 is biased off. Regulator VR640 is the -6.2 V reference for the base of Q640. Voltage from the leveling amplifier is fed into the emitter of this same transistor to shift the oscillator supply more negative. Increased voltage is obtained from this supply when the voltage at pin 6 of U295 ranges between about -5 V and 0 V. When Q640 turns on, Q630 reduces conduction; Q620 and the npn series-pass transistor in the mainframe increase conduction. This continues up to the point where the leveling amplifier is balanced, or the oscillator supply reaches the -23 V level and Q640 saturates.

When the current through R615 exceeds approximately 60 mA, VR615 conducts. This stops the base of the series-pass transistor from going more positive, thus limiting the amount of current available for the oscillators to about 55 mA.

+5 V Supply

The +5 V supply is derived from the +11.5 V supply which is in turn supplied by the power module. The +11.5 V supply is the input for U570, which is the +5 volt regulator. Integrated circuit U570 contains a current-limiting feature that starts to function at the 1.5 A level. The POWER pilot lamp operates from the +5 V supply and remains on as long as power is applied to instrument, even though the other supplies may be shut down by overload.

OPTIONS

No options are available at this time.

REPLACEABLE ELECTRICAL PARTS

PARTS ORDERING INFORMATION

Replacement parts are available from or through your local Tektronix, Inc. Field Office or representative.

Changes to Tektronix instruments are sometimes made to accommodate improved components as they become available, and to give you the benefit of the latest circuit improvements developed in our engineering department. It is therefore important, when ordering parts, to include the following information in your order: Part number, instrument type or number, serial number, and modification number if applicable.

If a part you have ordered has been replaced with a new or improved part, your local Tektronix, Inc. Field Office or representative will contact you concerning any change in part number.

Change information, if any, is located at the rear of this manual.

SPECIAL NOTES AND SYMBOLS

X000 Part first added at this serial number
00X Part removed after this serial number

ITEM NAME

In the Parts List, an Item Name is separated from the description by a colon (:). Because of space limitations, an Item Name may sometimes appear as incomplete. For further Item Name identification, the U.S. Federal Cataloging Handbook H6-1 can be utilized where possible.

ABBREVIATIONS

ACTR	ACTUATOR	PLSTC	PLASTIC
ASSY	ASSEMBLY	QTZ	QUARTZ
CAP	CAPACITOR	RECP	RECEPTACLE
CER	CERAMIC	RES	RESISTOR
CKT	CIRCUIT	RF	RADIO FREQUENCY
COMP	COMPOSITION	SEL	SELECTED
CONN	CONNECTOR	SEMICOND	SEMICONDUCTOR
ELGTLT	ELECTROLYTIC	SENS	SENSITIVE
ELEC	ELECTRICAL	VAR	VARIABLE
INCAND	INCANDESCENT	WW	WIREWOUND
LED	LIGHT EMITTING DIODE	XFMR	TRANSFORMER
NONWIR	NON WIREWOUND	XTAL	CRYSTAL

Replaceable Electrical Parts—SG 504

CROSS INDEX—MFR. CODE NUMBER TO MANUFACTURER

Mfr. Code	Manufacturer	Address	City, State, Zip
0000A	LEMO USA	2015 SECOND ST.	BERKELEY, CA 94710
00853	SANGAMO ELECTRIC CO., S. CAROLINA DIV.	P O BOX 128	PICKENS, SC 29671
01121	ALLEN-BRADLEY COMPANY	1201 2ND STREET SOUTH	MILWAUKEE, WI 53204
01295	TEXAS INSTRUMENTS, INC., SEMICONDUCTOR GROUP	P O BOX 5012, 13500 N CENTRAL EXPRESSWAY	DALLAS, TX 75222
02735	RCA CORPORATION, SOLID STATE DIVISION	ROUTE 202	SOMERVILLE, NY 08876
03508	GENERAL ELECTRIC COMPANY, SEMI-CONDUCTOR PRODUCTS DEPARTMENT	ELECTRONICS PARK	SYRACUSE, NY 13201
04222	AVX CERAMICS, DIVISION OF AVX CORP.	P O BOX 867, 19TH AVE. SOUTH	MYRTLE BEACH, SC 29577
04713	MOTOROLA, INC., SEMICONDUCTOR PROD. DIV.	5005 E MCDOWELL RD, PO BOX 20923	PHOENIX, AZ 85036
07263	FAIRCHILD SEMICONDUCTOR, A DIV. OF FAIRCHILD CAMERA AND INSTRUMENT CORP.	464 ELLIS STREET	MOUNTAIN VIEW, CA 94042
08806	GENERAL ELECTRIC CO., MINIATURE LAMP PRODUCTS DEPARTMENT	NELA PARK	CLEVELAND, OH 44112
12697	CLAROSTAT MFG. CO., INC.	LOWER WASHINGTON STREET	DOVER, NH 03820
12969	UNITROBE CORPORATION	580 PLEASANT STREET	WATERTOWN, MA 02172
14433	ITT SEMICONDUCTORS	3301 ELECTRONICS WAY	WEST PALM BEACH, FL 33402
16546	GLOBE UNION INC. USCC/CENTRALAB ELECTRONICS DIV.	P O BOX 3049	WEST PALM BEACH, FL 33402
18324	SIGNETICS CORP.	4561 COLORADO	LOS ANGELES, CA 90039
24931	SPECIALITY CONNECTOR CO., INC.	811 E. ARQUES	SUNNYVALE, CA 94086
27014	NATIONAL SEMICONDUCTOR CORP.	2620 ENDRESS PLACE	GREENWOOD, IN 46142
32997	BOURNS, INC., TRIMPOT PRODUCTS DIV.	2900 SEMICONDUCTOR DR.	SANTA CLARA, CA 95051
50852	MELSEY CORPORATION	1200 COLUMBIA AVE.	RIVERSIDE, CA 92507
51642	CENTRE ENGINEERING INC.	202 CABLE ROAD	CABLE PLACE, LI, NY 11514
52763	STETTNER-TRUSH, INC.	2820 E COLLEGE AVENUE	STATE COLLEGE, PA 16801
56289	SPRAGUE ELECTRIC CO.	67 ALBANY STREET	CAZENOVIA, NY 13035
71400	BUSSMAN MFG., DIVISION OF MCGRAW-EDISON CO.	87 MARSHALL ST.	NORTH ADAMS, MA 01247
72982	ERIE TECHNOLOGICAL PRODUCTS, INC.	2536 W. UNIVERSITY ST.	ST. LOUIS, MO 63107
73138	BECKMAN INSTRUMENTS, INC., HELIPOT DIV.	644 W. 12TH ST.	ERIE, PA 16512
75042	IRW ELECTRONIC COMPONENTS, INC FIXED RESISTORS, PHILADELPHIA DIVISION	2500 HARBOR BLVD.	FULLERTON, CA 92634
80009	TEKTRONIX, INC.	401 N. BROAD ST.	PHILADELPHIA, PA 19108
80031	ELECTRA-MIDLAND CORP., MEPCO DIV.	P O BOX 500	BEAVERTON, OR 97077
82389	SWITCHCRAFT, INC.	22 COLUMBIA ROAD	MORRISTOWN, NJ 07960
91637	DALE ELECTRONICS, INC.	5555 N. ELSTON AVE.	CHICAGO, IL 60630
91836	KINGS ELECTRONICS CO., INC.	P. O. BOX 609	COLUMBUS, NE 68601
95275	VITRAMON, INC.	40 MARBLEDALE ROAD	TUCKAHOE, NY 10707
98291	SEALECTSO CORP.	P O BOX 544	BRIDGEPORT, CT 06601
		225 HOYT	MAMARONECK, NY 10544

Replaceable Electrical Parts—SG 504

Ckt No.	Tektronix Part No.	Serial/Model No. Eff	Discont	Name & Description	Mfr Code	Mfr Part Number
A1	670-3403-00	B010100	B010523	CKT BOARD ASSY:MAIN	80009	670-3403-00
A1	670-3403-01	B010524		CKT BOARD ASSY:MAIN	80009	670-3403-01
A2	670-4038-00	B010100	B011079	CKT BOARD ASSY:RF	80009	670-4038-00
A2	670-4038-01	B011080		CKT BOARD ASSY:RF	80009	670-4038-01
A40	119-0727-00			OSCILLATOR, RF: CAV, TUNABLE, TDM, 245-550MHZ (A40, AVAILABLE AS A UNIT ONLY)	50852	ENGMEL 119
C25	283-0111-00			CAP., FXD, CER DI: 0.1UF, 20%, 50V	72982	8121-N088250104M
C26	290-0517-00			CAP., FXD, ELCTLT: 6.8UF, 20%, 35V	56289	196D685X0035KA1
C34	281-0523-00			CAP., FXD, CER DI: 100PF, +/-20PF, 500V	72982	301-00002M0101M
C47	283-0311-00			CAP., FXD, CER DI: 4.7PF, +/-0.25PF, 100V	04222	ULA151A4R7C2
C49	283-0311-00			CAP., FXD, CER DI: 4.7PF, +/-0.25PF, 100V	04222	ULA151A4R7C2
C50	283-0310-00			CAP., FXD, CER DI: 2.5PF, +/-0.25PF, 100V	04222	08051A2R5CA8060
C52	283-0353-00			CAP., FXD, CER DI: 0.1UF, 10%, 50V	95275	VJ1210Y104K-H
C54	283-0353-00			CAP., FXD, CER DI: 0.1UF, 10%, 50V	95275	VJ1210Y104K-H
C58	283-0353-00			CAP., FXD, CER DI: 0.1UF, 10%, 50V	95275	VJ1210Y104K-H
C60	290-0534-00			CAP., FXD, ELCTLT: 1UF, 20%, 35V	56289	196D105X0035HA1
C62	283-0353-00			CAP., FXD, CER DI: 0.1UF, 10%, 50V	95275	VJ1210Y104K-H
C64	283-0309-00			CAP., FXD, CER DI: 150PF, 10%, 50V	04222	ULA355A151K1T60
C66	283-0353-00			CAP., FXD, CER DI: 0.1UF, 10%, 50V	95275	VJ1210Y104K-H
C75	281-0217-00			CAP., VAR, CER DI: 0.5-3.5PF, 400V	52763	311908141
C87	283-0353-00			CAP., FXD, CER DI: 0.1UF, 10%, 50V	95275	VJ1210Y104K-H
C90	283-0353-00			CAP., FXD, CER DI: 0.1UF, 10%, 50V	95275	VJ1210Y104K-H
C97	283-0318-00			CAP., FXD, CER DI: 10PF, 100V	04222	ULA151A100K2
C99	283-0371-00			CAP., FXD, CER DI: 33PF, 5%, 100V	56289	11C1005C0G330J10
C100	281-0618-00			CAP., FXD, CER DI: 4.7PF, +/-0.5PF, 200V	72982	374001C0H0479D
C102	283-0353-00			CAP., FXD, CER DI: 0.1UF, 10%, 50V	95275	VJ1210Y104K-H
C104	283-0353-00			CAP., FXD, CER DI: 0.1UF, 10%, 50V	95275	VJ1210Y104K-H
C108	283-0353-00			CAP., FXD, CER DI: 0.1UF, 10%, 50V	95275	VJ1210Y104K-H
C110	290-0534-00			CAP., FXD, ELCTLT: 1UF, 20%, 35V	56289	196D105X0035HA1
C112	283-0353-00			CAP., FXD, CER DI: 0.1UF, 10%, 50V	95275	VJ1210Y104K-H
C114	283-0309-00			CAP., FXD, CER DI: 150PF, 10%, 50V	04222	ULA355A151K1T60
C116	283-0353-00			CAP., FXD, CER DI: 0.1UF, 10%, 50V	95275	VJ1210Y104K-H
C125	281-0182-00			CAP., VAR, PLSTC: 1.8-10PF, 500V	80031	2805D1R810BHO2F0
C126	283-0318-00			CAP., FXD, CER DI: 10PF, 100V	04222	ULA151A100K2
C128	283-0265-00			CAP., FXD, CER DI: 3.35PF, +/-1.5PF	72982	A02BL9A4LC0G339B
C137	283-0353-00			CAP., FXD, CER DI: 0.1UF, 10%, 50V	95275	VJ1210Y104K-H
C140	283-0353-00			CAP., FXD, CER DI: 0.1UF, 10%, 50V	95275	VJ1210Y104K-H
C145	283-0309-00			CAP., FXD, CER DI: 150PF, 10%, 50V	04222	ULA355A151K1T60
C147	283-0309-00			CAP., FXD, CER DI: 150PF, 10%, 50V	04222	ULA355A151K1T60
C150	283-0252-00			CAP., FXD, CER DI: 1000PF, 10%, 50V	04222	ULA105C102K2T60
C152	283-0353-00			CAP., FXD, CER DI: 0.1UF, 10%, 50V	95275	VJ1210Y104K-H
C154	283-0252-00			CAP., FXD, CER DI: 1000PF, 10%, 50V	04222	ULA105C102K2T60
C160	283-0309-00			CAP., FXD, CER DI: 150PF, 10%, 50V	04222	ULA355A151K1T60
C170	283-0309-00			CAP., FXD, CER DI: 150PF, 10%, 50V	04222	ULA355A151K1T60
C174	283-0353-00			CAP., FXD, CER DI: 0.1UF, 10%, 50V	95275	VJ1210Y104K-H
C176	281-0819-00	XB011080		CAP., FXD, CER DI: 33PF, 5%, 50V	72982	8035BC0G330
C178	283-0338-00			CAP., FXD, CER DI: 330PF, 10%, 100V	16546	N100CJ331K
C190	283-0203-00			CAP., FXD, CER DI: 0.47UF, 20%, 50V	72982	8131N075E474M
C195	283-0177-00			CAP., FXD, CER DI: 1UF, +80-20%, 25V	56289	273C5
C197	283-0203-00			CAP., FXD, CER DI: 0.47UF, 20%, 50V	72982	8131N075E474M
C200	283-0625-00			CAP., FXD, MICA D: 220PF, 1%, 500V	00853	D105F221F0
C202	283-0177-00			CAP., FXD, CER DI: 1UF, +80-20%, 25V	56289	273C5
C205	283-0695-00			CAP., FXD, MICA D: 440PF, 1%, 300V	00853	D193F4441F0
C207	283-0672-00			CAP., FXD, MICA D: 200PF, 1%, 500V	00853	D155F2010F0
C216	283-0177-00			CAP., FXD, CER DI: 1UF, +80-20%, 25V	56289	273C5
C220	283-0203-00			CAP., FXD, CER DI: 0.47UF, 20%, 50V	72982	8131N075E474M

Replaceable Electrical Parts—SG 504

Ckt No.	Tektronix Part No.	Serial/Model No. Eff	Dscont	Name & Description	Mfr Code	Mfr Part Number
C226	283-0203-00			CAP., FXD, CER DI: 0.47UF, 20%, 50V	72982	8131N075E474M
C228	283-0203-00			CAP., FXD, CER DI: 0.47UF, 20%, 50V	72982	8131N075E474M
C274	283-0111-00	X8010524		CAP., FXD, CER DI: 0.1UF, 20%, 50V	72982	8121-N08825U104M
C290	283-0111-00			CAP., FXD, CER DI: 0.1UF, 20%, 50V	72982	8121-N08825U104M
C292	283-0198-00			CAP., FXD, CER DI: 0.22UF, 20%, 50V	72982	8121N083Z500224M
C295	283-0111-00			CAP., FXD, CER DI: 0.1UF, 20%, 50V	72982	8121-N08825U104M
C298	283-0111-00			CAP., FXD, CER DI: 0.1UF, 20%, 50V	72982	8121-N08825U104M
C300	283-0177-00			CAP., FXD, CER DI: 1UF, +80-20%, 25V	56289	273C5
C335	283-0111-00			CAP., FXD, CER DI: 0.1UF, 20%, 50V	72982	8121-N08825U104M
C504	290-0517-00			CAP., FXD, ELCTLT: 6.8UF, 20%, 35V	56289	196D685X0035KA1
C510	283-0111-00			CAP., FXD, CER DI: 0.1UF, 20%, 50V	72982	8121-N08825U104M
C544	290-0517-00			CAP., FXD, ELCTLT: 6.8UF, 20%, 35V	56289	196D685X0035KA1
C565	283-0203-00			CAP., FXD, CER DI: 0.47UF, 20%, 50V	72982	8131N075E474M
C570	283-0111-00			CAP., FXD, CER DI: 0.1UF, 20%, 50V	72982	8121-N08825U104M
C582	290-0517-00			CAP., FXD, ELCTLT: 6.8UF, 20%, 35V	56289	196D685X0035KA1
C584	283-0139-00			CAP., FXD, CER DI: 150PF, 20%, 50V	51642	W100-050-X5P151M
C586	283-0150-00			CAP., FXD, CER DI: 650PF, 5%, 200V	72982	835-5158651J
C587	290-0517-00			CAP., FXD, ELCTLT: 6.8UF, 20%, 35V	56289	196D685X0035KA1
C595	283-0111-00			CAP., FXD, CER DI: 0.1UF, 20%, 50V	72982	8121-N08825U104M
C600	290-0745-00			CAP., FXD, ELCTLT: 22UF, +50-10%, 25V	56289	502D225
C610	290-0725-00			CAP., FXD, ELCTLT: 100UF, +75-10%, 50V	56289	30D107G050DH9
C612	290-0725-00			CAP., FXD, ELCTLT: 100UF, +75-10%, 50V	56289	30D107G050DH9
C625	290-0718-00			CAP., FXD, ELCTLT: 22UF, 20%, 35V	56289	196D226X0035PE4
C634	290-0517-00			CAP., FXD, ELCTLT: 6.8UF, 20%, 35V	56289	196D685X0035KA1
C660	283-0111-00			CAP., FXD, CER DI: 0.1UF, 20%, 50V	72982	8121-N08825U104M
CR30	152-0141-02			SEMICOND DEVICE: SILICON, 30V, 150MA	01295	1N4152R
CR55	152-0141-02			SEMICOND DEVICE: SILICON, 30V, 150MA	01295	1N4152R
CR80	152-0579-00			SEMICOND DEVICE: SILICON, 100V, 2.5A	12969	UM6601B
CR85	152-0141-02			SEMICOND DEVICE: SILICON, 30V, 150MA	01295	1N4152R
CR86	152-0141-02			SEMICOND DEVICE: SILICON, 30V, 150MA	01295	1N4152R
CR87	152-0141-02			SEMICOND DEVICE: SILICON, 30V, 150MA	01295	1N4152R
CR105	152-0141-02			SEMICOND DEVICE: SILICON, 30V, 150MA	01295	1N4152R
CR130	152-0579-00			SEMICOND DEVICE: SILICON, 100V, 2.5A	12969	UM6601B
CR135	152-0141-02			SEMICOND DEVICE: SILICON, 30V, 150MA	01295	1N4152R
CR136	152-0141-02			SEMICOND DEVICE: SILICON, 30V, 150MA	01295	1N4152R
CR137	152-0141-02			SEMICOND DEVICE: SILICON, 30V, 150MA	01295	1N4152R
CR155	152-0579-00			SEMICOND DEVICE: SILICON, 100V, 2.5A	12969	UM6601B
CR158	152-0579-00			SEMICOND DEVICE: SILICON, 100V, 2.5A	12969	UM6601B
CR160	152-0579-00			SEMICOND DEVICE: SILICON, 100V, 2.5A	12969	UM6601B
CR190	152-0141-02			SEMICOND DEVICE: SILICON, 30V, 150MA	01295	1N4152R
CR230	152-0141-02			SEMICOND DEVICE: SILICON, 30V, 150MA	01295	1N4152R
CR232	152-0141-02			SEMICOND DEVICE: SILICON, 30V, 150MA	01295	1N4152R
CR310	152-0141-02			SEMICOND DEVICE: SILICON, 30V, 150MA	01295	1N4152R
CR318	152-0141-02			SEMICOND DEVICE: SILICON, 30V, 150MA	01295	1N4152R
CR345	152-0141-02			SEMICOND DEVICE: SILICON, 30V, 150MA	01295	1N4152R
CR348	152-0141-02			SEMICOND DEVICE: SILICON, 30V, 150MA	01295	1N4152R
CR355	152-0141-02			SEMICOND DEVICE: SILICON, 30V, 150MA	01295	1N4152R
CR362	152-0141-02			SEMICOND DEVICE: SILICON, 30V, 150MA	01295	1N4152R
CR380	152-0141-02			SEMICOND DEVICE: SILICON, 30V, 150MA	01295	1N4152R
CR386	152-0141-02			SEMICOND DEVICE: SILICON, 30V, 150MA	01295	1N4152R
CR395	152-0141-02			SEMICOND DEVICE: SILICON, 30V, 150MA	01295	1N4152R
CR396	152-0141-02			SEMICOND DEVICE: SILICON, 30V, 150MA	01295	1N4152R
CR405	152-0141-02			SEMICOND DEVICE: SILICON, 30V, 150MA	01295	1N4152R

Replaceable Electrical Parts—SG 504

Ckt No.	Tektronix Part No.	Serial/Model No. Eff	Discont	Name & Description	Mfr Code	Mfr Part Number
CR586	152-0141-02			SEMICONV DEVICE:SILICON,30V,150MA	01295	1N4152R
CR600	152-0066-00			SEMICONV DEVICE:SILICON,400V,750MA	14433	LG4016
CR610	152-0585-00			SEMICONV DEVICE:SILICON,BRIDGE,200V,1A	80009	152-0585-00
CR612	152-0066-00			SEMICONV DEVICE:SILICON,400V,750MA	14433	LG4016
CR640	152-0141-02			SEMICONV DEVICE:SILICON,30V,150MA	01295	1N4152R
CR660	152-0066-00			SEMICONV DEVICE:SILICON,400V,750MA	14433	LG4016
CR662	152-0066-00			SEMICONV DEVICE:SILICON,400V,750MA	14433	LG4016
DS320	150-0048-01			LAMP, INCAND:5V,0.06A,SEL	08806	683AS15
DS574	150-0048-01			LAMP, INCAND:5V,0.06A,SEL	08806	683AS15
F595	159-0025-00			FUSE, CARTRIDGE:3AG,0.5A,250V,FAST-BLOW	71400	AGC 1/2
F610	159-0083-00			FUSE, CARTRIDGE:0.15A,250V,FAST-BLOW	71400	AGC 15/100
J10	131-1315-00	8010100	8010979	CONN,RCPT,ELEC:BNC,FEMALE	80009	131-1315-00
J10	131-1315-01	8010980		CONN,RCPT,ELEC:BNC,FEMALE	24931	28JR 306-1
J11	131-1003-00			CONN,RCPT,ELEC:CKT BD MT,3 PRONG	80009	131-1003-00
J12	131-1003-00			CONN,RCPT,ELEC:CKT BD MT,3 PRONG	80009	131-1003-00
J20	131-1003-00			CONN,RCPT,ELEC:CKT BD MT,3 PRONG	80009	131-1003-00
J39	131-0391-00			CONNECTOR,RCPT,:50 OHM,COAX,SNAP-ON MALE	98291	51-051-0049
J41	131-0391-00			CONNECTOR,RCPT,:50 OHM,COAX,SNAP-ON MALE	98291	51-051-0049
J80	131-1315-00	8010100	8010979	CONN,RCPT,ELEC:BNC,FEMALE	80009	131-1315-00
J80	131-1315-01	8010980		CONN,RCPT,ELEC:BNC,FEMALE	24931	28JR 306-1
J81	131-1003-00			CONN,RCPT,ELEC:CKT BD MT,3 PRONG	80009	131-1003-00
J164	131-0391-00			CONNECTOR,RCPT,:50 OHM,COAX,SNAP-ON MALE	98291	51-051-0049
J165	131-0818-00			CONNECTOR,RCPT,:BNC,FEMALE	91836	KC19-153BNC
J260	131-0771-00			CONN,RCPT,ELEC:4 CONT,QUICK DISCONNECT	0000A	80A-304NYL
L45	108-0577-00			COIL,RF:FIXED,30NH	80009	108-0577-00
L48	108-0578-00			COIL,RF:FIXED,45NH	80009	108-0578-00
L52	120-0342-00			XFMR,TOROID:10 TURNS,SINGLE	80009	120-0342-00
L58	108-0509-00			COIL,RF:2.45UH	80009	108-0509-00
L75	120-0342-00			XFMR,TOROID:10 TURNS,SINGLE	80009	120-0342-00
L85	108-0683-00			COIL,RF:900MH	80009	108-0683-00
L95	108-0577-00			COIL,RF:FIXED,30NH	80009	108-0577-00
L98	108-0420-00			COIL,RF:60NH	80009	108-0420-00
L102	108-0526-00			COIL,RF:50UH	80009	108-0526-00
L108	108-0509-00			COIL,RF:2.45UH	80009	108-0509-00
L125	108-0578-00			COIL,RF:FIXED,45NH	80009	108-0578-00
L126	108-0578-00			COIL,RF:FIXED,45NH	80009	108-0578-00
L128	108-0578-00			COIL,RF:FIXED,45NH	80009	108-0578-00
L130	108-0526-00			COIL,RF:50UH	80009	108-0526-00
L135	108-0683-00			COIL,RF:900MH	80009	108-0683-00
L150	108-0509-00			COIL,RF:2.45UH	80009	108-0509-00
L178	108-0345-00			COIL,RF:FIXED,1.89UH	80009	108-0345-00
L220	108-0795-00			COIL,RF:FIXED,2NH	80009	108-0795-00
LR190	108-0333-00			COIL,RF:0.9UH	80009	108-0333-00
Q70	151-0474-01			TRANSISTOR:SILICON,NPN	80009	151-0474-01
Q120	151-0474-01			TRANSISTOR:SILICON,NPN	80009	151-0474-01
Q170	151-0453-00			TRANSISTOR:SILICON,PNP	80009	151-0453-00
Q190	151-0103-00			TRANSISTOR:SILICON,NPN	80009	151-0103-00
Q215	151-0301-00			TRANSISTOR:SILICON,PNP	27014	2N2907A
Q220	151-0235-00			TRANSISTOR:SILICON,PNP	80009	151-0235-00
Q305	151-0190-00			TRANSISTOR:SILICON,NPN	07263	S032677
Q315	151-0190-00			TRANSISTOR:SILICON,NPN	07263	S032677
Q345	151-0190-00			TRANSISTOR:SILICON,NPN	07263	S032677

Replaceable Electrical Parts—SG 504

Ckt No.	Tektronix Part No.	Serial/Model No. Eff	Dscont	Name & Description	Mfr Code	Mfr Part Number
Q355	151-0190-00			TRANSISTOR: SILICON, NPN	07263	S032677
Q365	151-0453-00			TRANSISTOR: SILICON, PNP	80009	151-0453-00
Q370	151-0301-00			TRANSISTOR: SILICON, PNP	27014	2N2907A
Q380	151-0190-00			TRANSISTOR: SILICON, NPN	07263	S032677
Q395	151-0190-00			TRANSISTOR: SILICON, NPN	07263	S032677
Q405	151-0190-00			TRANSISTOR: SILICON, NPN	07263	S032677
Q410	151-0301-00			TRANSISTOR: SILICON, PNP	27014	2N2907A
Q415	151-0453-00			TRANSISTOR: SILICON, PNP	80009	151-0453-00
Q520	151-0365-00			TRANSISTOR: SILICON, NPN	03508	X42C182
Q530	151-0301-00			TRANSISTOR: SILICON, PNP	27014	2N2907A
Q560	151-0365-00			TRANSISTOR: SILICON, NPN	03508	X42C182
Q600	151-0453-00			TRANSISTOR: SILICON, PNP	80009	151-0453-00
Q620	151-0453-00			TRANSISTOR: SILICON, PNP	80009	151-0453-00
Q630	151-0453-00			TRANSISTOR: SILICON, PNP	80009	151-0453-00
Q640	151-0453-00			TRANSISTOR: SILICON, PNP	80009	151-0453-00
Q650	151-0453-00			TRANSISTOR: SILICON, PNP	80009	151-0453-00
Q655	151-0453-00			TRANSISTOR: SILICON, PNP	80009	151-0453-00
Q660	151-0515-01			SCR: SILICON	04713	2N4441
R10	315-0823-00			RES., FXD, CMPSN: 82K OHM, 5%, 0.25W	01121	CB8235
R12	315-0104-00			RES., FXD, CMPSN: 100K OHM, 5%, 0.25W	01121	CB1045
R15	311-1095-00			RES., VAR, NONWIR: 10K OHM, 20%, 0.50W	12697	382-CM40386
R16	315-0512-00			RES., FXD, CMPSN: 5.1K OHM, 5%, 0.25W	01121	CB5125
R18	315-0683-00			RES., FXD, CMPSN: 68K OHM, 5%, 0.25W	01121	CB6835
R22	315-0563-00			RES., FXD, CMPSN: 56K OHM, 5%, 0.25W	01121	CB5635
R23	321-0390-00			RES., FXD, FILM: 113K OHM, 1%, 0.125W	91637	MFF1816G11302F
R25	301-0102-00			RES., FXD, CMPSN: 1K OHM, 5%, 0.50W	01121	EB1025
R26	315-0131-00			RES., FXD, CMPSN: 130 OHM, 5%, 0.25W	01121	CB1315
R30	315-0104-00			RES., FXD, CMPSN: 100K OHM, 5%, 0.25W	01121	CB1045
R38	315-0621-00			RES., FXD, CMPSN: 620 OHM, 5%, 0.25W	01121	CB6215
R40	315-0621-00			RES., FXD, CMPSN: 620 OHM, 5%, 0.25W	01121	CB6215
R45	317-0560-00			RES., FXD, CMPSN: 56 OHM, 5%, 0.125W	01121	BB5605
R54	315-0101-00			RES., FXD, CMPSN: 100 OHM, 5%, 0.25W	01121	CB1015
R80	317-0511-00			RES., FXD, CMPSN: 510 OHM, 5%, 0.125W	01121	BB5115
R95	317-0330-00			RES., FXD, CMPSN: 33 OHM, 5%, 0.125W	01121	BB3305
R104	315-0101-00			RES., FXD, CMPSN: 100 OHM, 5%, 0.25W	01121	CB1015
R130	317-0511-00			RES., FXD, CMPSN: 510 OHM, 5%, 0.125W	01121	BB5115
R170	315-0102-00			RES., FXD, CMPSN: 1K OHM, 5%, 0.25W	01121	CB1025
R172	315-0564-00			RES., FXD, CMPSN: 560K OHM, 5%, 0.25W	01121	CB5645
R174	317-0512-00			RES., FXD, CMPSN: 5.1K OHM, 5%, 0.125	01121	BB5125
R190	315-0471-00			RES., FXD, CMPSN: 470 OHM, 5%, 0.25W	01121	CB4715
R194	315-0241-00			RES., FXD, CMPSN: 240 OHM, 5%, 0.25W	01121	CB2415
R196	315-0131-00			RES., FXD, CMPSN: 130 OHM, 5%, 0.25W	01121	CB1315
R210	315-0103-00			RES., FXD, CMPSN: 10K OHM, 5%, 0.25W	01121	CB1035
R212	315-0101-00			RES., FXD, CMPSN: 100 OHM, 5%, 0.25W	01121	CB1015
R215	301-0180-00			RES., FXD, CMPSN: 18 OHM, 5%, 0.50W	01121	EB1805
R218	301-0220-00			RES., FXD, CMPSN: 22 OHM, 5%, 0.50W	01121	EB2205
R220	315-0471-00			RES., FXD, CMPSN: 470 OHM, 5%, 0.25W	01121	CB4715
R222	315-0510-00			RES., FXD, CMPSN: 51 OHM, 5%, 0.25W	01121	CB5105
R224	315-0101-00			RES., FXD, CMPSN: 100 OHM, 5%, 0.25W	01121	CB1015
R265	321-0069-00			RES., FXD, FILM: 51.1 OHM, 1%, 0.125W	91637	MFF1816G51R10F
R266	321-0289-00			RES., FXD, FILM: 10K OHM, 1%, 0.125W	91637	MFF1816G10001F
R268	321-0165-00			RES., FXD, FILM: 511 OHM, 1%, 0.125W	91637	MFF1816G511R0F
R270	311-1260-00			RES., VAR, NONWIR: 250 OHM, 10%, 0.50W	32997	3329P-LS8-251

Replaceable Electrical Parts—SG 504

Ckt No.	Tektronix Part No.	Serial/Model No. Eff	Dscont	Name & Description	Mfr Code	Mfr Part Number
R272	321-0147-00	B010100	B010523	RES., FXD, FILM: 332 OHM, 1%, 0.125W	91637	MFF1816G332R0F
R272	321-0150-00	B010524		RES., FXD, FILM: 357 OHM, 1%, 0.125W	91637	MFF1816G357R0F
R275	311-1531-00			RES., VAR, WW: 2K OHM, 5%, 1.5W	01121	535-9504
R278	321-0203-00			RES., FXD, FILM: 1.27K OHM, 1%, 0.125W	91637	MFF1816G12700F
R280	311-1260-00			RES., VAR, NONWIR: 250 OHM, 10%, 0.50W	32997	J329P-L58-251
R285	315-0275-00	B010100	B010523	RES., FXD, CMPSN: 2.7M OHM, 5%, 0.25W	01121	CB2755
R285	315-0395-00	B010524		RES., FXD, CMPSN: 3.9M OHM, 5%, 0.25W	01121	CB3955
R286	315-0275-00			RES., FXD, CMPSN: 2.7M OHM, 5%, 0.25W	01121	CB2755
R288	315-0204-00			RES., FXD, CMPSN: 200K OHM, 5%, 0.25W	01121	CB2045
R290	315-0103-00			RES., FXD, CMPSN: 10K OHM, 5%, 0.25W	01121	CB1035
R292	315-0103-00			RES., FXD, CMPSN: 10K OHM, 5%, 0.25W	01121	CB1035
R295	315-0103-00			RES., FXD, CMPSN: 10K OHM, 5%, 0.25W	01121	CB1035
R304	315-0473-00			RES., FXD, CMPSN: 47K OHM, 5%, 0.25W	01121	CB4735
R305	315-0123-00			RES., FXD, CMPSN: 12K OHM, 5%, 0.25W	01121	CB1235
R308	315-0123-00			RES., FXD, CMPSN: 12K OHM, 5%, 0.25W	01121	CB1235
R310	315-0332-00			RES., FXD, CMPSN: 3.3K OHM, 5%, 0.25W	01121	CB3325
R315	315-0473-00			RES., FXD, CMPSN: 47K OHM, 5%, 0.25W	01121	CB4735
R318	315-0102-00			RES., FXD, CMPSN: 1K OHM, 5%, 0.25W	01121	CB1025
R320	315-0120-00			RES., FXD, CMPSN: 12 OHM, 5%, 0.25W	01121	CB1205
R324	315-0101-00			RES., FXD, CMPSN: 100 OHM, 5%, 0.25W	01121	CB1015
R330	315-0273-00			RES., FXD, CMPSN: 27K OHM, 5%, 0.25W	01121	CB2735
R332	315-0203-00			RES., FXD, CMPSN: 20K OHM, 5%, 0.25W	01121	CB2035
R334	315-0103-00			RES., FXD, CMPSN: 10K OHM, 5%, 0.25W	01121	CB1035
R338	315-0303-00			RES., FXD, CMPSN: 30K OHM, 5%, 0.25W	01121	CB3035
R340	315-0183-00			RES., FXD, CMPSN: 18K OHM, 5%, 0.25W	01121	CB1835
R342	315-0273-00			RES., FXD, CMPSN: 27K OHM, 5%, 0.25W	01121	CB2735
R344	315-0132-00			RES., FXD, CMPSN: 1.3K OHM, 5%, 0.25W	01121	CB1325
R348	315-0302-00			RES., FXD, CMPSN: 3K OHM, 5%, 0.25W	01121	CB3025
R352	315-0272-00			RES., FXD, CMPSN: 2.7K OHM, 5%, 0.25W	01121	CB2725
R354	315-0562-00			RES., FXD, CMPSN: 5.6K OHM, 5%, 0.25W	01121	CB5625
R358	315-0751-00			RES., FXD, CMPSN: 750 OHM, 5%, 0.25W	01121	CB7515
R362	315-0751-00			RES., FXD, CMPSN: 750 OHM, 5%, 0.25W	01121	CB7515
R365	315-0102-00			RES., FXD, CMPSN: 1K OHM, 5%, 0.25W	01121	CB1025
R370	301-0330-00			RES., FXD, CMPSN: 33 OHM, 5%, 0.50W	01121	EB3305
R375	315-0103-00			RES., FXD, CMPSN: 10K OHM, 5%, 0.25W	01121	CB1035
R378	315-0103-00			RES., FXD, CMPSN: 10K OHM, 5%, 0.25W	01121	CB1035
R382	315-0153-00			RES., FXD, CMPSN: 15K OHM, 5%, 0.25W	01121	CB1535
R384	315-0472-00			RES., FXD, CMPSN: 4.7K OHM, 5%, 0.25W	01121	CB4725
R386	315-0272-00			RES., FXD, CMPSN: 2.7K OHM, 5%, 0.25W	01121	CB2725
R390	315-0392-00			RES., FXD, CMPSN: 3.9K OHM, 5%, 0.25W	01121	CB3925
R392	315-0622-00			RES., FXD, CMPSN: 6.2K OHM, 5%, 0.25W	01121	CB6225
R394	315-0242-00			RES., FXD, CMPSN: 2.4K OHM, 5%, 0.25W	01121	CB2425
R396	315-0361-00			RES., FXD, CMPSN: 360 OHM, 5%, 0.25W	01121	CB3615
R400	315-0332-00			RES., FXD, CMPSN: 3.3K OHM, 5%, 0.25W	01121	CB3325
R402	315-0242-00			RES., FXD, CMPSN: 2.4K OHM, 5%, 0.25W	01121	CB2425
R406	315-0511-00			RES., FXD, CMPSN: 510 OHM, 5%, 0.25W	01121	CB5115
R410	301-0330-00			RES., FXD, CMPSN: 33 OHM, 5%, 0.50W	01121	EB3305
R415	315-0471-00			RES., FXD, CMPSN: 470 OHM, 5%, 0.25W	01121	CB4715
R418	315-0132-00	B010100	B010225	RES., FXD, CMPSN: 1.3K OHM, 5%, 0.25W	01121	CB1325
R418	315-0102-00	B010226		RES., FXD, CMPSN: 1K OHM, 5%, 0.25W	01121	CB1025
R420	315-0120-00	B010100	B010225	RES., FXD, CMPSN: 12 OHM, 5%, 0.25W	01121	CB1205
R420	315-0102-00	B010226		RES., FXD, CMPSN: 1K OHM, 5%, 0.25W	01121	CB1025
R422	315-0120-00			RES., FXD, CMPSN: 12 OHM, 5%, 0.25W	01121	CB1205

Replaceable Electrical Parts—SG 504

Ckt No	Tektronix Part No.	Serial/Model No. Eff.	Discont	Name & Description	Mfr Code	Mfr Part Number
R500	321-0303-00			RES.,FXD,FILM:14K OHM,1%,0.125W	91637	MFF1816G14001F
R502	311-1564-00			RES.,VAR,NONWIR:TRMR,500 OHM,0.5W	73138	91-86-0
R504	321-0306-00			RES.,FXD,FILM:15K OHM,1%,0.125W	91637	MFF1816G15001F
R508	321-0311-00			RES.,FXD,FILM:16.9K OHM,1%,0.125W	91637	MFF1816G16901F
R512	321-0303-00			RES.,FXD,FILM:14K OHM,1%,0.125W	91637	MFF1816G14001F
R514	315-0202-00			RES.,FXD,CMPSN:2K OHM,5%,0.25W	01121	CB2025
R518	308-0344-00			RES.,FXD,WV:18.2 OHM,1%,3W	91637	RS2B-K18R20F
R525	315-0362-00			RES.,FXD,CMPSN:3.6K OHM,5%,0.25W	01121	CB3625
R526	315-0103-00			RES.,FXD,CMPSN:10K OHM,5%,0.25W	01121	CB1035
R530	315-0152-00			RES.,FXD,CMPSN:1.5K OHM,5%,0.25W	01121	CB1525
R540	321-0303-00			RES.,FXD,FILM:14K OHM,1%,0.125W	91637	MFF1816G14001F
R542	311-1564-00			RES.,VAR,NONWIR:TRMR,500 OHM,0.5W	73138	91-86-0
R544	321-0306-00			RES.,FXD,FILM:15K OHM,1%,0.125W	91637	MFF1816G15001F
R548	321-0311-00			RES.,FXD,FILM:16.9K OHM,1%,0.125W	91637	MFF1816G16901F
R552	321-0303-00			RES.,FXD,FILM:14K OHM,1%,0.125W	91637	MFF1816G14001F
R554	315-0202-00			RES.,FXD,CMPSN:2K OHM,5%,0.25W	01121	CB2025
R558	308-0344-00			RES.,FXD,WV:18.2 OHM,1%,3W	91637	RS2B-K18R20F
R574	315-0120-00			RES.,FXD,CMPSN:12 OHM,5%,0.25W	01121	CB1205
R582	321-0305-00			RES.,FXD,FILM:14.7K OHM,1%,0.125W	91637	MFF1816G14701F
R583	321-0247-00			RES.,FXD,FILM:3.65K OHM,1%,0.125W	91637	MFF1816G36500F
R588	321-0238-00			RES.,FXD,FILM:2.94K OHM,1%,0.125W	91637	MFF1816G29400F
R590	311-1261-00			RES.,VAR,NONWIR:500 OHM,10%,0.50W	32997	3329P-L58-501
R592	321-0238-00			RES.,FXD,FILM:2.94K OHM,1%,0.125W	91637	MFF1816G29400F
R595	315-0102-00			RES.,FXD,CMPSN:1K OHM,5%,0.25W	01121	CB1025
R600	315-0102-00			RES.,FXD,CMPSN:1K OHM,5%,0.25W	01121	CB1025
R604	307-0104-00			RES.,FXD,CMPSN:3.3 OHM,5%,0.25W	01121	CB3305
R605	307-0104-00			RES.,FXD,CMPSN:3.3 OHM,5%,0.25W	01121	CB3305
R610	308-0142-00			RES.,FXD,WV:30 OHM,5%,3W	91637	RS2B-K30R00J
R612	308-0142-00			RES.,FXD,WV:30 OHM,5%,3W	91637	RS2B-K30R00J
R615	308-0720-00	B010100	B010225	RES.,FXD,WV:50 OHM,1%,3W	12697	RS2B-850R00F
R615	323-0094-00	B010226		RES.,FXD,FILM:93.1 OHM,1%,0.50W	75042	CECT0-93R10F
R617	315-0102-00			RES.,FXD,CMPSN:1K OHM,5%,0.25W	01121	CB1025
R620	315-0102-00			RES.,FXD,CMPSN:1K OHM,5%,0.25W	01121	CB1025
R624	321-0244-00			RES.,FXD,FILM:3.4K OHM,1%,0.125W	91637	MFF1816G34000F
R625	321-0253-00			RES.,FXD,FILM:4.22K OHM,1%,0.125W	91637	MFF1816G42200F
R628	315-0102-00	B010100	B010225	RES.,FXD,CMPSN:1K OHM,5%,0.25W	01121	CB1025
R628	315-0202-00	B010226		RES.,FXD,CMPSN:2K OHM,5%,0.25W	01121	CB2025
R630	321-0289-00			RES.,FXD,FILM:10K OHM,1%,0.125W	91637	MFF1816G10001F
R634	321-0251-00			RES.,FXD,FILM:4.02K OHM,1%,0.125W	91637	MFF1816G40200F
R636	321-0226-00	B010100	B010225	RES.,FXD,FILM:2.21K OHM,1%,0.125W	91637	MFF1816G22100F
R636	321-0224-00	B010226		RES.,FXD,FILM:2.1K OHM,1%,0.125W	91637	MFF1816G21000F
R638	315-0242-00	B010100	B010225	RES.,FXD,CMPSN:2.4K OHM,5%,0.25W	01121	CB2425
R638	315-0202-00	B010226		RES.,FXD,CMPSN:2K OHM,5%,0.25W	01121	CB2025
R640	315-0222-00	B010100	B010225	RES.,FXD,CMPSN:2.2K OHM,5%,0.25W	01121	CB2225
R640	315-0242-00	B010226		RES.,FXD,CMPSN:2.4K OHM,5%,0.25W	01121	CB2425
R650	321-0275-00			RES.,FXD,FILM:7.15K OHM,1%,0.125W	91637	MFF1816G71500F
R651	321-0318-00			RES.,FXD,FILM:20K OHM,1%,0.125W	91637	MFF1816G20001F
R653	315-0202-00			RES.,FXD,CMPSN:2K OHM,5%,0.25W	01121	CB2025
R655	315-0622-00			RES.,FXD,CMPSN:6.2K OHM,5%,0.25W	01121	CB6225
R656	315-0153-00			RES.,FXD,CMPSN:15K OHM,5%,0.25W	01121	CB1535
R660	315-0102-00			RES.,FXD,CMPSN:1K OHM,5%,0.25W	01121	CB1025
S30A-C	260-1555-00			SWITCH,PUSH:2 STA,PN10,4 POLE	80009	260-1555-00

Replaceable Electrical Parts—SG 504

Ckt No.	Tektronix Part No.	Serial/Model No.		Name & Description	Mfr Code	Mfr Part Number
		Eff	Dscont			
S190	260-1811-00			SWITCH, SLIDE:DPDT, 0.5A, 125VAC DC	82389	C56206L2
T200	120-0936-00			XPMR, RF: VARIABLE, 5-10MHZ	80009	120-0936-00
T205	120-0931-00			XPMR, RF: POT CORE, 50KHZ	80009	120-0931-00
U25	156-0511-00			MICROCIRCUIT, LI: OPERATIONAL AMPLIFIER	18324	NE531N
U250	015-0282-00			DIODE LEVELER:	80009	015-0282-00
U295	156-0067-00			MICROCIRCUIT, LI: OPERATIONAL AMPLIFIER	02735	85145
U335	156-0158-00			MICROCIRCUIT, LI: DUAL OPERATIONAL AMPLIFIER	18324	MC1458V
U510	156-0158-00			MICROCIRCUIT, LI: DUAL OPERATIONAL AMPLIFIER	18324	MC1458V
U570	156-0277-00			MICROCIRCUIT, LI: VOLTAGE REGULATOR	07263	MICROA7805UC
U580	156-0071-00			MICROCIRCUIT, LI: VOLTAGE REGULATOR	04713	MC1723CL
VR25	152-0022-00			SEMICONV DEVICE: ZENER, 1W, 25V, 5%	04713	SZ12815
VR30	153-0062-00			SEMICONV DVC, SE: ZENER, SELECTED	80009	153-0062-00
VR230	152-0337-00			SEMICONV DEVICE: ZENER, 0.4W, 6.3V, 3.2%	04713	SZG210K
VR232	152-0337-00			SEMICONV DEVICE: ZENER, 0.4W, 6.3V, 3.2%	04713	SZG210K
VR510	152-0175-00			SEMICONV DEVICE: ZENER, 0.4W, 5.6V, 5%	04713	SZG35008
VR550	152-0175-00			SEMICONV DEVICE: ZENER, 0.4W, 5.6V, 5%	04713	SZG35008
VR615	153-0062-00	B010100	B010225	SEMICONV DVC, SE: ZENER, SELECTED	80009	153-0062-00
VR615	152-0337-00	B010226		SEMICONV DEVICE: ZENER, 0.4W, 6.3V, 3.2%	04713	SZG210K
VR640	152-0175-00	B010100	B010225	SEMICONV DEVICE: ZENER, 0.4W, 5.6V, 5%	04713	SZG35008
VR640	152-0337-00	B010226		SEMICONV DEVICE: ZENER, 0.4W, 6.3V, 3.2%	04713	SZG210K
VR655	152-0337-00			SEMICONV DEVICE: ZENER, 0.4W, 6.3V, 3.2%	04713	SZG210K

STANDARD ACCESSORIES

Fig. & Index No.	Tektronix Part No.	Serial/Model No.		Qty						Name & Description	Mfr Code	Mfr Part Number	
		Eff	Dscont		1	2	3	4	5				
	070-1632-01			1							MANUAL, TECH: INSTRUCTION	80009	070-1632-01

OPTIONAL ACCESSORIES

	015-0221-00			1							CAPACITOR, CPLG: 0.047UF, BNC	80009	015-0221-00
	175-1869-00			1							CABLE ASSY, RF: 50 OHM COAX, 4.0 L	80009	175-1869-00

DIAGRAMS AND CIRCUIT BOARD ILLUSTRATIONS

Symbols and Reference Designators

Electrical components shown on the diagrams are in the following units unless noted otherwise:

- Capacitors = Values one or greater are in picofarads (pF).
Values less than one are in microfarads (μF).
- Resistors = Ohms (Ω).

Graphic symbols and class designation letters are based on ANSI Standard Y32.2-1975.

Logic symbology is based on ANSI Y32.14-1973 in terms of positive logic. Logic symbols depict the logic function performed and may differ from the manufacturer's data.

The overline on a signal name indicates that the signal performs its intended function when it goes to the low state.

Abbreviations are based on ANSI Y1.1-1972.

Other ANSI standards that are used in the preparation of diagrams by Tektronix, Inc. are:

- Y14.15, 1966 Drafting Practices.
- Y14.2, 1973 Line Conventions and Lettering.
- Y10.5, 1968 Letter Symbols for Quantities Used in Electrical Science and Electrical Engineering.

The following prefix letters are used as reference designators to identify components or assemblies on the diagrams.

A	Assembly, separable or repairable (circuit board, etc)	H	Heat dissipating device (heat sink, heat radiator, etc)	S	Switch or contactor
AT	Attenuator, fixed or variable	HR	Heater	T	Transformer
B	Motor	HY	Hybrid circuit	TC	Thermocouple
BT	Battery	J	Connector, stationary portion	TP	Test point
C	Capacitor, fixed or variable	K	Relay	U	Assembly, inseparable or non-repairable (integrated circuit, etc.)
CB	Circuit breaker	L	Inductor, fixed or variable	V	Electron tube
CR	Diode, signal or rectifier	M	Meier	VR	Voltage regulator (zener diode, etc.)
DL	Delay line	P	Connector, movable portion	W	Wirestrap or cable
DS	Indicating device (lamp)	Q	Transistor or silicon-controlled rectifier	Y	Crystal
E	Spark Gap, Ferrite bead	R	Resistor, fixed or variable	Z	Phase shifter
F	Fuse	RT	Thermistor		
FL	Filter				

The following special symbols may appear on the diagrams:

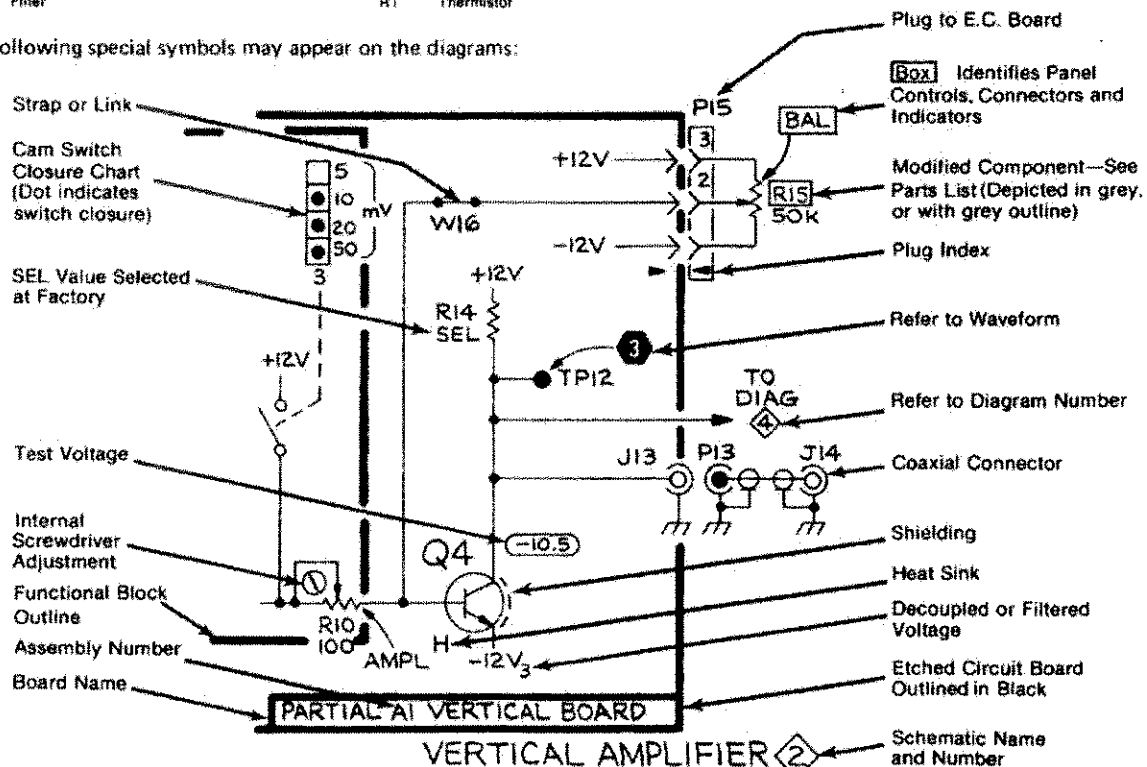

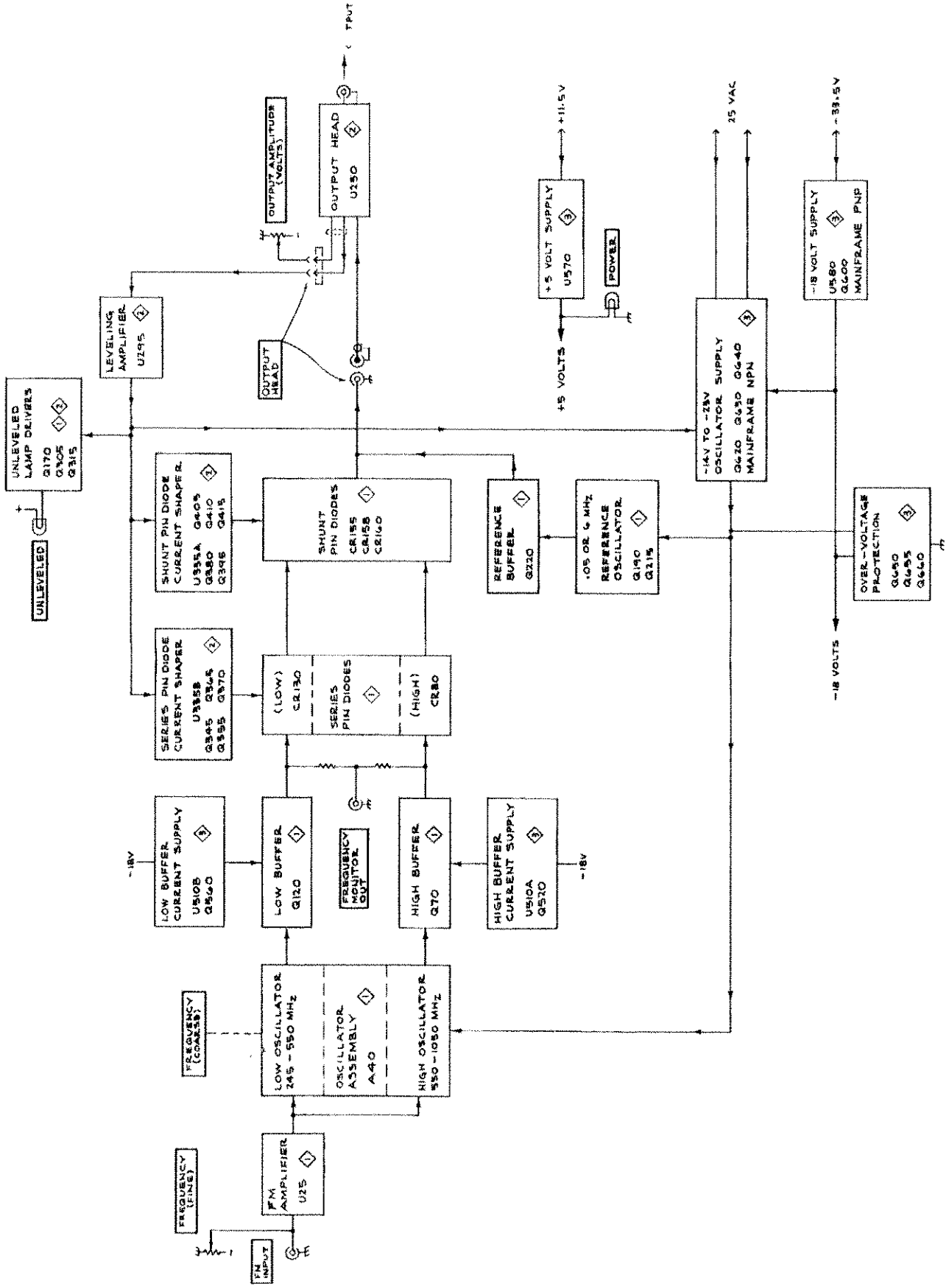

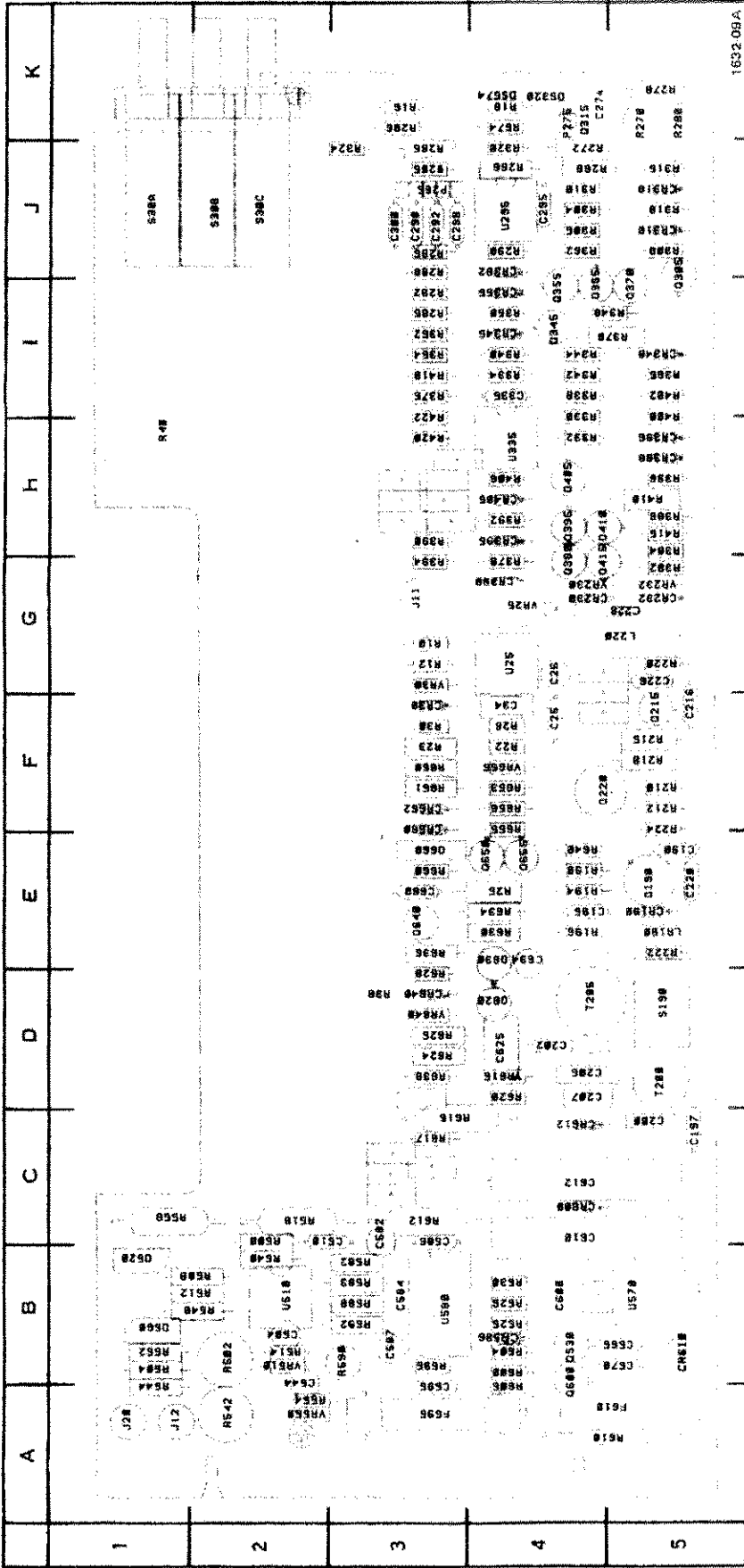

A1--MAIN CIRCUIT BOARD

CKT NO	GRID/CKT		GRID/CKT		GRID/CKT		GRID/CKT		GRID/CKT		GRID/CKT		GRID/CKT		GRID/CKT		GRID/CKT		GRID/CKT		GRID/CKT		GRID/CKT		
	LOC	NO	LOC	NO	LOC	NO	LOC	NO	LOC	NO	LOC	NO	LOC	NO	LOC	NO	LOC	NO	LOC	NO	LOC	NO	LOC	NO	
C25	F4	C570	B5	CR586	B4	Q220	F4	R22	F4	R288	J3	R375	I3	R530	B4	R634	E4	VR25	G4	VR25	G4	VR25	G4	VR25	G4
C26	G4	C582	C3	CR600	C4	Q305	J5	R23	F3	R290	J4	R378	G4	R540	B2	R636	E3	VR30	G3	VR30	G3	VR30	G3	VR30	G3
C34	FA	C584	B3	CR610	B5	Q315	K4	R25	E4	R292	I3	R382	G5	R542	A2	R638	D3	VR230	G4	VR230	G4	VR230	G4	VR230	G4
C190	E5	C586	C3	CR612	C4	Q345	I4	R26	F4	R295	J3	R384	H5	R544	B1	R640	F4	VR232	G5	VR232	G5	VR232	G5	VR232	G5
C195	E4	C587	B3	CR640	D3	Q345	I4	R30	F3	R304	J4	R386	H5	R548	B1	R650	F3	VR510	B2	VR510	B2	VR510	B2	VR510	B2
C197	C5	C595	B3	CR660	F3	Q365	I4	R38	D3	R305	J5	R390	H3	R552	B1	R651	F3	VR550	A2	VR550	A2	VR550	A2	VR550	A2
C200	C5	C600	C4	CR662	F5	Q370	I5	R40	E4	R308	J4	R392	H4	R554	A2	R655	F4	VR615	D3	VR615	D3	VR615	D3	VR615	D3
C202	D4	C610	C4	DS320	K4	Q380	G4	R194	E4	R310	J5	R394	G3	R558	C1	R660	E3	VR660	D3	VR660	D3	VR660	D3	VR660	D3
C207	D4	C612	E4	DS374	K4	Q405	H4	R198	E4	R316	J5	R400	I5	R582	B3	R660	E3	VR665	F4	VR665	F4	VR665	F4	VR665	F4
C220	F5	C660	F3	FS95	A3	Q415	G4	R210	F5	R320	J4	R406	H4	R590	B3	R660	E3	VR665	F4	VR665	F4	VR665	F4	VR665	F4
C228	G5	CR190	G4	F610	A5	Q520	B1	R212	F5	R330	J4	R410	H5	R595	B3	R660	E3	VR665	F4	VR665	F4	VR665	F4	VR665	F4
C265	D4	CR232	G5	J11	G3	Q560	B1	R218	F5	R332	H4	R415	H5	R595	B3	R660	E3	VR665	F4	VR665	F4	VR665	F4	VR665	F4
C274*	K4	CR310	J5	J12	A1	Q600	B4	R222	E5	R338	I4	R418	I3	R600	B4	R660	E3	VR665	F4	VR665	F4	VR665	F4	VR665	F4
C290	J3	CR318	J5	J20	A1	Q620	D4	R224	F5	R340	I4	R422	H3	R604	B4	R660	E3	VR665	F4	VR665	F4	VR665	F4	VR665	F4
C292	J3	CR345	J5	L220	G5	Q640	E4	R265	J3	R342	I4	R500	C2	R610+	A5	R660	E3	VR665	F4	VR665	F4	VR665	F4	VR665	F4
C295	J4	CR348	I5	L220	G5	Q640	E3	R268	J4	R348	I4	R504	B2	R612	C3	R660	E3	VR665	F4	VR665	F4	VR665	F4	VR665	F4
C300	J3	CR355	J4	LR190	E5	Q650	E4	R270	K5	R348	I4	R504	B2	R612	C3	R660	E3	VR665	F4	VR665	F4	VR665	F4	VR665	F4
C303	J3	CR362	G4	P275	K4	Q660	E3	R272	K5	R352	I3	R508	B1	R615	C3	R660	E3	VR665	F4	VR665	F4	VR665	F4	VR665	F4
C504	B2	CR386	H5	P265	J3	R10	G3	R276	K5	R354	I4	R512	I4	R620	D3	R660	E3	VR665	F4	VR665	F4	VR665	F4	VR665	F4
C510	C2	CR395	H4	Q190	E5	R12	G3	R280	K5	R354	I4	R512	I4	R620	D3	R660	E3	VR665	F4	VR665	F4	VR665	F4	VR665	F4
C544	B2	CR398	H4	Q190	E5	R12	G3	R285	K3	R354	I4	R512	I4	R620	D3	R660	E3	VR665	F4	VR665	F4	VR665	F4	VR665	F4
C548	B5	CR405	H4	Q215	F5	R18	K4	R286	K3	R370	I5	R526	B4	R630	E4	R660	E3	VR665	F4	VR665	F4	VR665	F4	VR665	F4

* See Parts List for serial number ranges.

† On backside of board.

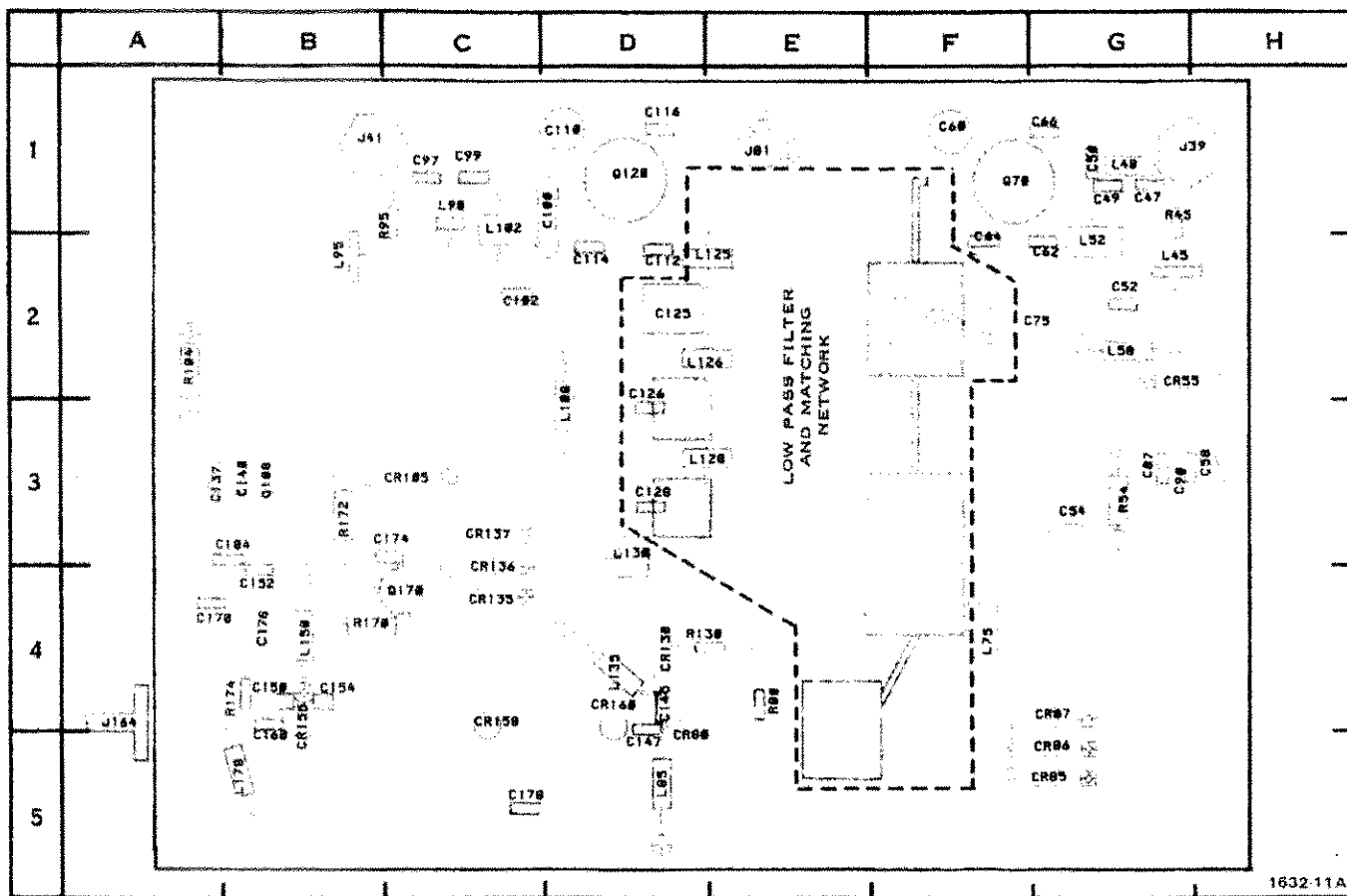

A2-RF CIRCUIT BOARD

CKT NO	GRID LOC	CKT NO	GRID LOC	CKT NO	GRID LOC	CKT NO	GRID LOC
C47	G1	C137	A3	J39	H1	R45	G1
C49	G1	C140	B3	J41	B1	R54	G3
C50	G1	C145	D4	J81	E1	R80	E4
C52	G2	C147	D5	J164	A4	R95	C1
C54	G3	C150	B4			R104	A2
C58	H3	C152	B4	L45	G2	R130	E4
C60	F1	C154	B4	L52	G2	R170	B4
C62	G2	C160	B4	L58	G2	R172	B3
C64	F2	C170	A4	L75	F4	R174	B4
C66	G1	C174	C3	L85	D5		
C75	G2	C176	B4	L95	B2	Q78	F1
C87	G3	C178	C5	L98	C1	Q120	D1
C90	G3	CR55	G2	L102	C1	Q170	C4
C97	C1	CR80	D4	L108	D2		
C99	C1	CR85	G5	L125	E2		
C100	D1	CR86	G5	L126	E2		
C102	C2	CR87	G4	L128	E3		
C104	B3	CR105	C3	L130	E3		
C108	B3	CR130	D4	L135	D4		
C110	D1	CR135	C4	L150	B4		
C112	D2	CR136	C3	L178	B5		
C114	D2	CR137	C3				
C116	D1	CR155	B4				
C125	D2	CR158	C4				
C126	D2	CR160	D4				
C128	D3						

VOLTAGE AND WAVEFORM CONDITIONS

WARNING

Dangerous potentials exist at several points throughout this instrument. When the instrument is operated with the covers removed, do not touch exposed connections or components. Some transistors have voltages present on their cases. Disconnect the power source before replacing parts.

The voltages and waveforms shown on this diagram were taken with the SG 504 Output Head connected and its input terminated into 50 ohms. The internal slide switch, S190, was set to 6 MHz. The front-panel controls were set as follows:

VOLTAGES

RANGE	REF
FINE	"0"
OUTPUT AMPLITUDE	5.5

*WAVEFORMS

RANGE	REF
FINE	"0"
OUTPUT AMPLITUDE	5.5

*gnd reference: center horizontal graticule line

Voltage Conditions. The voltages shown on the diagram were obtained using a digital multimeter with a 10 M Ω input impedance (TEKTRONIX DM 501 Digital Multimeter or TEKTRONIX 7D13 Digital Multimeter used with readout equipped, 7000-series oscilloscope).

Waveform Conditions. The waveforms shown are actual waveform photographs taken with a Tektronix Oscilloscope Camera System and Projected Graticule. Vertical deflection factor shown on the waveform is the actual deflection factor from the probe tip. Voltages and waveforms on the diagrams are not absolute and may vary between instruments because of component tolerances, internal calibration, or front-panel settings. Readouts are simulated in larger-than-normal type.

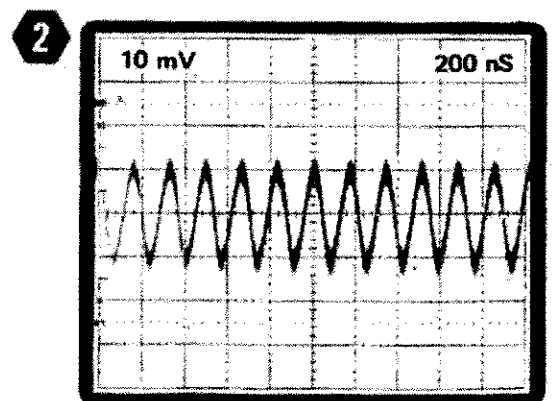
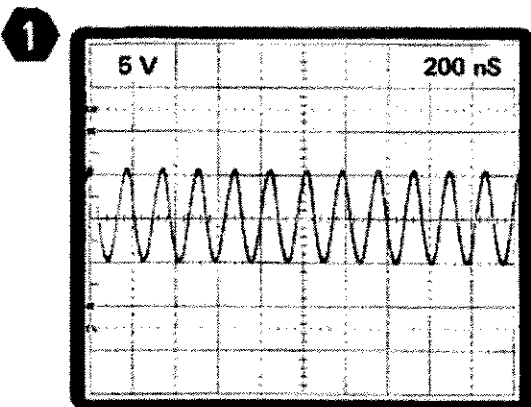

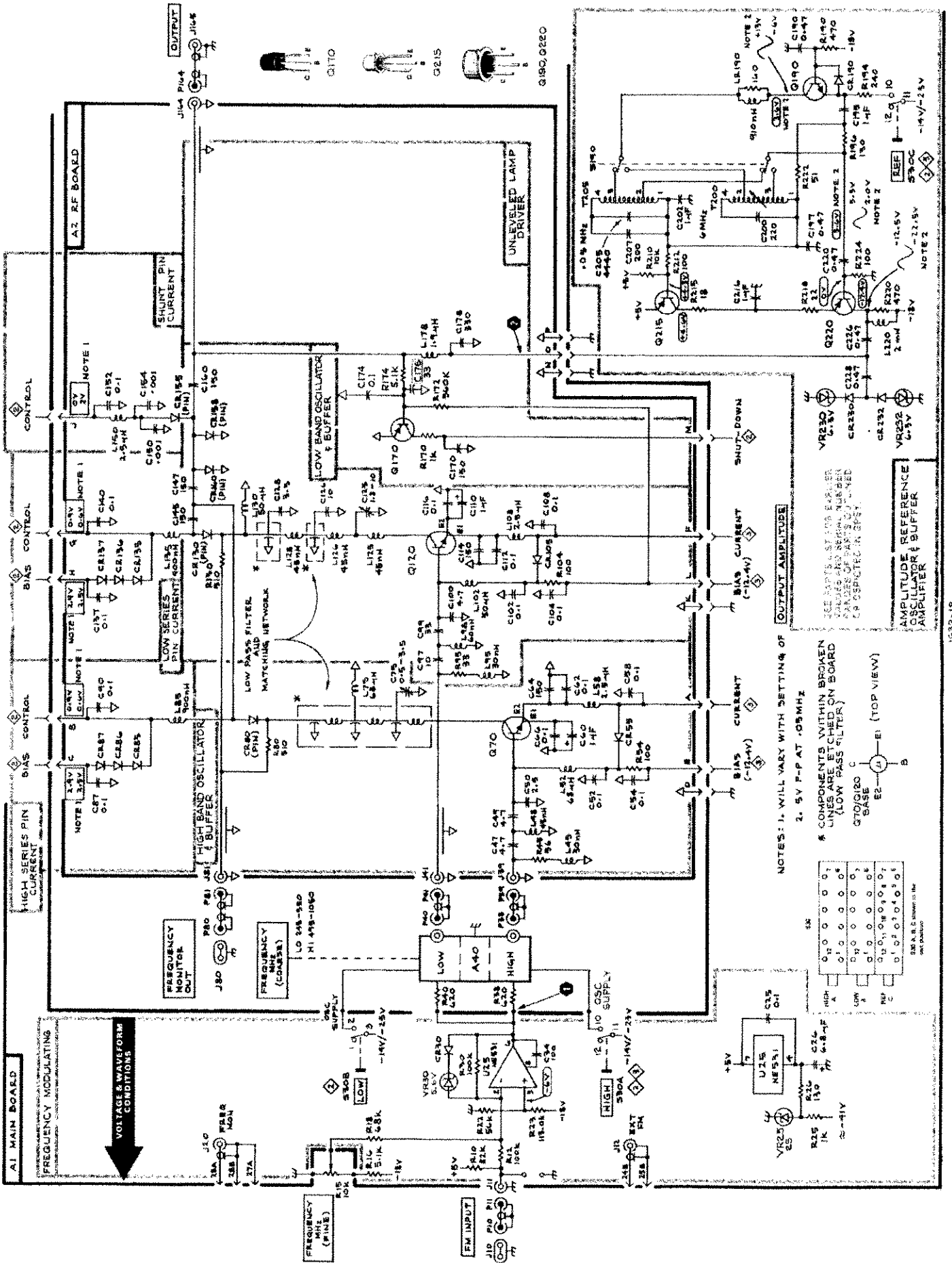

NOTES: 1. WILL VARY WITH SETTING OF
2. 5V P-P AT .05MHZ

* COMPONENTS WITHIN BROKEN
LINES ARE ETCHED ON BOARD

Q10/Q15
BASE
E2 - E1 (TOP VIEW)

Q20/Q21
BASE
E2 - E1 (TOP VIEW)

Q22/Q23
BASE
E2 - E1 (TOP VIEW)

Q24/Q25
BASE
E2 - E1 (TOP VIEW)

Q26/Q27
BASE
E2 - E1 (TOP VIEW)

Q28/Q29
BASE
E2 - E1 (TOP VIEW)

Q30/Q31
BASE
E2 - E1 (TOP VIEW)

Q32/Q33
BASE
E2 - E1 (TOP VIEW)

Q34/Q35
BASE
E2 - E1 (TOP VIEW)

Q36/Q37
BASE
E2 - E1 (TOP VIEW)

Q38/Q39
BASE
E2 - E1 (TOP VIEW)

Q40/Q41
BASE
E2 - E1 (TOP VIEW)

Q42/Q43
BASE
E2 - E1 (TOP VIEW)

Q44/Q45
BASE
E2 - E1 (TOP VIEW)

Q46/Q47
BASE
E2 - E1 (TOP VIEW)

Q48/Q49
BASE
E2 - E1 (TOP VIEW)

Q50/Q51
BASE
E2 - E1 (TOP VIEW)

Q52/Q53
BASE
E2 - E1 (TOP VIEW)

Q54/Q55
BASE
E2 - E1 (TOP VIEW)

Q56/Q57
BASE
E2 - E1 (TOP VIEW)

Q58/Q59
BASE
E2 - E1 (TOP VIEW)

Q60/Q61
BASE
E2 - E1 (TOP VIEW)

Q62/Q63
BASE
E2 - E1 (TOP VIEW)

Q64/Q65
BASE
E2 - E1 (TOP VIEW)

Q66/Q67
BASE
E2 - E1 (TOP VIEW)

Q68/Q69
BASE
E2 - E1 (TOP VIEW)

Q70/Q71
BASE
E2 - E1 (TOP VIEW)

Q72/Q73
BASE
E2 - E1 (TOP VIEW)

Q74/Q75
BASE
E2 - E1 (TOP VIEW)

Q76/Q77
BASE
E2 - E1 (TOP VIEW)

Q78/Q79
BASE
E2 - E1 (TOP VIEW)

Q80/Q81
BASE
E2 - E1 (TOP VIEW)

Q82/Q83
BASE
E2 - E1 (TOP VIEW)

Q84/Q85
BASE
E2 - E1 (TOP VIEW)

Q86/Q87
BASE
E2 - E1 (TOP VIEW)

Q88/Q89
BASE
E2 - E1 (TOP VIEW)

Q90/Q91
BASE
E2 - E1 (TOP VIEW)

Q92/Q93
BASE
E2 - E1 (TOP VIEW)

Q94/Q95
BASE
E2 - E1 (TOP VIEW)

Q96/Q97
BASE
E2 - E1 (TOP VIEW)

Q98/Q99
BASE
E2 - E1 (TOP VIEW)

Q100/Q101
BASE
E2 - E1 (TOP VIEW)

VOLTAGE AND WAVEFORM CONDITIONS

WARNING

Dangerous potentials exist at several points throughout this instrument. When the instrument is operated with the covers removed, do not touch exposed connections or components. Some transistors have voltages present on their cases. Disconnect the power source before replacing parts.

The voltages and waveforms shown on this diagram were taken with the SG 504 Output Head connected and its input terminated into 50 ohms. The internal slide switch, S190, was set to 6 MHz. The front-panel controls were set as follows:

VOLTAGES		*WAVEFORMS	
RANGE	REF	RANGE	REF
FINE	"0"	FINE	"0"
OUTPUT AMPLITUDE	5.5	OUTPUT AMPLITUDE	5.5

*gnd reference: center horizontal graticule line

Voltage Conditions. The voltages shown on the diagram were obtained using a digital multimeter with a 10 M Ω input impedance (TEKTRONIX DM 501 Digital Multimeter or TEKTRONIX 7D13 Digital Multimeter used with readout equipped, 7000-series oscilloscope).

Waveform Conditions. The waveforms shown are actual waveform photographs taken with a Tektronix Oscilloscope Camera System and Projected Graticule. Vertical deflection factor shown on the waveform is the actual deflection factor from the probe tip. Voltages and waveforms on the diagrams are not absolute and may vary between instruments because of component tolerances, internal calibration, or front-panel settings. Readouts are simulated in larger-than-normal type.

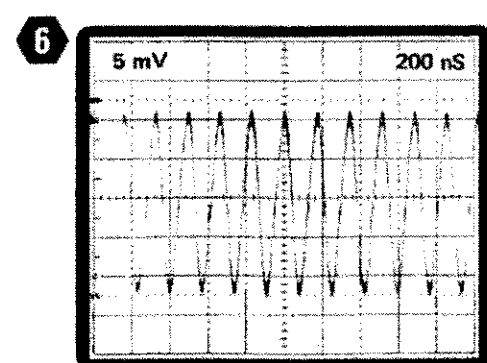
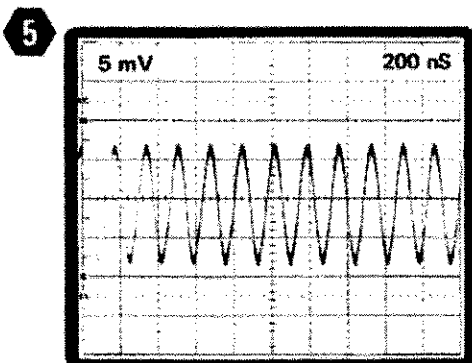
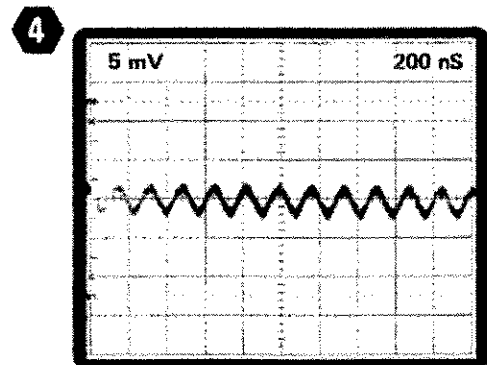
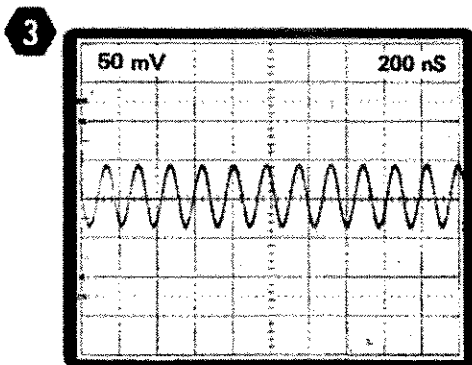

VOLTAGE CONDITIONS

WARNING

Dangerous potentials exist at several points throughout this instrument. When the instrument is operated with the covers removed, do not touch exposed connections or components. Some transistors have voltages present on their cases. Disconnect the power source before replacing parts.

The voltages shown on this diagram were taken with the SG 504 Output Head connected and its input terminated into 50 ohms. The internal slide switch, S190, was set to 6 MHz. The front-panel controls were set as follows: RANGE switch to REF, FINE control to "0", and OUTPUT AMPLITUDE control to 5.5.

Voltage conditions. The voltages shown on this diagram were obtained using a digital multimeter with a 10 M Ω input impedance (TEKTRONIX DM 501 Digital Multimeter or TEKTRONIX 7D13 Digital Multimeter used with readout equipped, 7000-series oscilloscope).

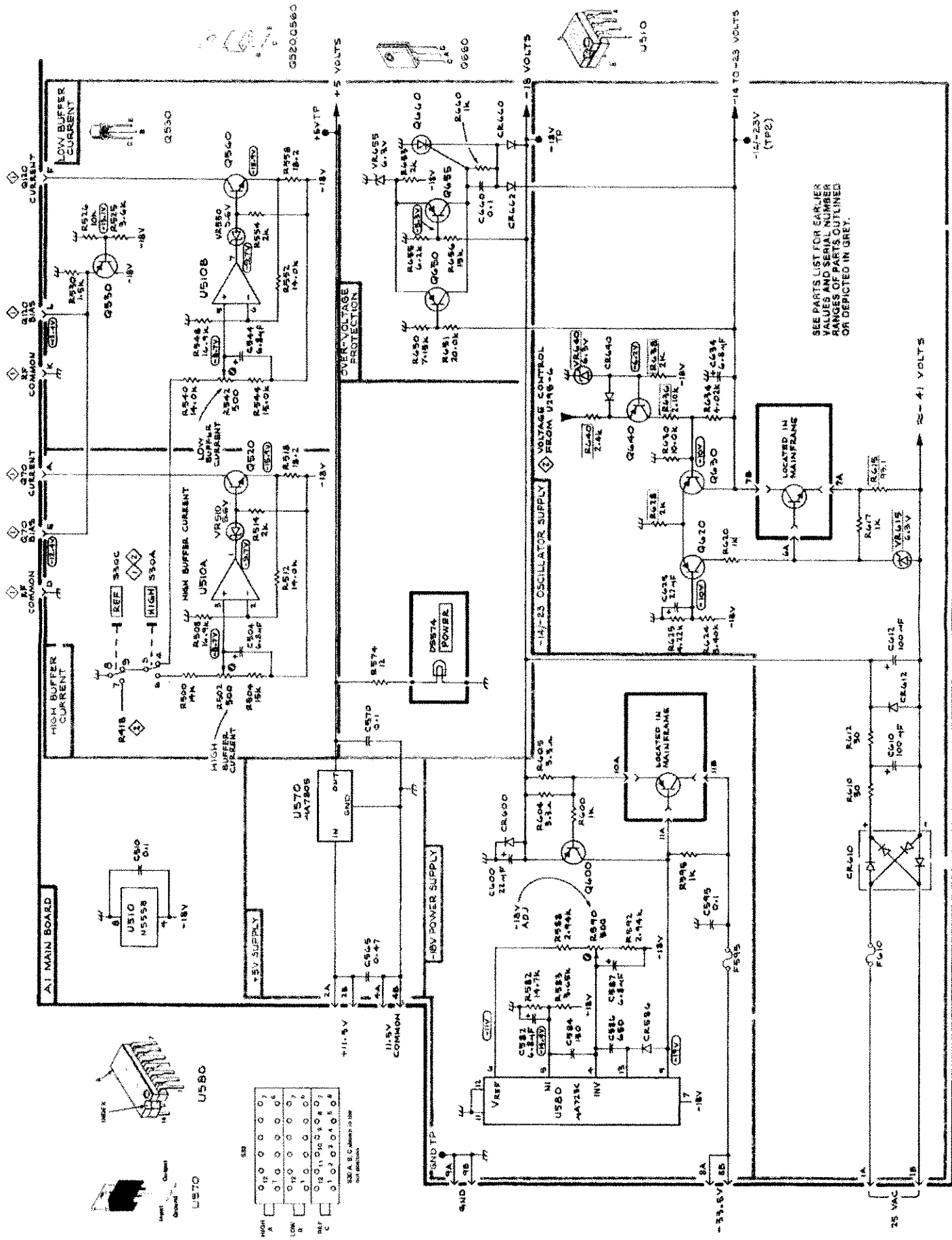

SEE PARTS LIST FOR EARLIER
VALUES AND SERIAL NUMBER
RANGES OF PARTS OUTLINED
OR DEPICTED IN GREY.

REPLACEABLE MECHANICAL PARTS

PARTS ORDERING INFORMATION

Replacement parts are available from or through your local Tektronix, Inc. Field Office or representative.

Changes to Tektronix instruments are sometimes made to accommodate improved components as they become available, and to give you the benefit of the latest circuit improvements developed in our engineering department. It is therefore important, when ordering parts, to include the following information in your order: Part number, instrument type or number, serial number, and modification number if applicable.

If a part you have ordered has been replaced with a new or improved part, your local Tektronix, Inc. Field Office or representative will contact you concerning any change in part number.

Change information, if any, is located at the rear of this manual.

SPECIAL NOTES AND SYMBOLS

X000 Part first added at this serial number
00X Part removed after this serial number

FIGURE AND INDEX NUMBERS

Items in this section are referenced by figure and index numbers to the illustrations.

INDENTATION SYSTEM

This mechanical parts list is indented to indicate item relationships. Following is an example of the indentation system used in the description column.

1	2	3	4	5	Name & Description
					<i>Assembly and/or Component</i>
					<i>Attaching parts for Assembly and/or Component</i>

					<i>Detail Part of Assembly and/or Component</i>
					<i>Attaching parts for Detail Part</i>

					<i>Parts of Detail Part</i>
					<i>Attaching parts for Parts of Detail Part</i>

Attaching Parts always appear in the same indentation as the item it mounts, while the detail parts are indented to the right. Indented items are part of, and included with, the next higher indentation. The separation symbol ----- indicates the end of attaching parts.

Attaching parts must be purchased separately, unless otherwise specified.

ITEM NAME

In the Parts List, an Item Name is separated from the description by a colon (:). Because of space limitations, an Item Name may sometimes appear as incomplete. For further Item Name identification, the U.S. Federal Cataloging Handbook H6-1 can be utilized where possible.

ABBREVIATIONS

INCH	ELECTRON	IN	INCH	SE	SINGLE END
NUMBER SIZE	ELEC	INCAND	INCANDESCENT	SECT	SECTION
ACTR	ELECT	INSUL	INSULATOR	SEMICOND	SEMICONDUCTOR
ADPTR	ELEM	INTL	INTERNAL	SHLD	SHIELD
ALIGN	EPL	LPHDR	LAMPHOLDER	SHLDR	SHOULDERED
AL	EQPT	MACH	MACHINE	SKT	SOCKET
ALUMINUM	EXT	MECH	MECHANICAL	SL	SLIDE
ASSEM	FIL	MTG	MOUNTING	SLFLKG	SELF-LOCKING
ASSY	FLEX	NIP	NIPPLE	SLVG	SLEEVING
ATTEN	FLH	NON WIRE	NOT WIRE WOUND	SPR	SPRING
AWG	FLTR	ORD	ORDER BY DESCRIPTION	SO	SQUARE
BD	FR	OD	OUTSIDE DIAMETER	SST	STAINLESS STEEL
BRKT	FSTNR	OVH	OVAL HEAD	STL	STEEL
BRS	FT	PH BRZ	PHOSPHOR BRONZE	SW	SWITCH
BRZ	FXD	PL	PLAIN or PLATE	T	TUBE
BUSHG	GSKT	PLSTC	PLASTIC	TERM	TERMINAL
CAB	HDL	PN	PART NUMBER	THD	THREAD
CAP	HEX	PNH	PAN HEAD	THK	THICK
CER	HEX HD	PWR	POWER	TNSN	TENSION
CHAS	HEX SOC	RCPT	RECEPTACLE	TPG	TAPPING
CKT	HLCPS	RES	RESISTOR	TRH	TRUSS HEAD
COMP	HLEXT	RGD	RIGID	V	VOLTAGE
CONN	HV	RLF	RELIEF	VAR	VARIABLE
COV	IC	RTNR	RETAINER	W/	WITH
CPLG	ID	SCH	SOCKET HEAD	WSHR	WASHER
CRT	IDENT	SCOPE	OSCILLOSCOPE	XFMR	TRANSFORMER
DEG	IMPLR	SCR	SCREW	XSTR	TRANSISTOR
DWR					

CROSS INDEX—MFR. CODE NUMBER TO MANUFACTURER

Mfr. Code	Manufacturer	Address	City, State, Zip
000BK	STAUFFER SUPPLY	105 SE TAYLOR	PORTLAND, OR 97214
000CY	NORTHWEST FASTENER SALES, INC.	7923 SW CIRRUS DRIVE	BEAVERTON, OREGON 97005
000EL	PORTLAND SCREW CO.	6520 N. BASIN AVE.	PORTLAND, OR 97217
0000A	LEMO USA	2015 SECOND ST.	BERKELEY, CA 94710
05129	KILO ENGINEERING COMPANY	2015 D	LA VERNE, CA 91750
05820	WAKEFIELD ENGINEERING, INC.	AUDUBON ROAD	WAKEFIELD, MA 01880
07700	TECHNICAL WIRE AND PRODUCTS, INC.	129 DERMODY ST.	CRANFORD, NJ 07016
08261	SPECTRA-STRIP CORP.	7100 LAMPSON AVE.	GARDEN GROVE, CA 92642
12327	FREEWAY CORPORATION	9301 ALLEN DRIVE	CLEVELAND, OH 44125
13103	THERMALLOY COMPANY, INC.	2021 W VALLEY VIEW LANE P O BOX 34829	DALLAS, TX 75234
22526	BERG ELECTRONICS, INC.	YOUR EXPRESSWAY	NEW CUMBERLAND, PA 17070
22670	G.M. NAMEPLATE, INC.	2040 15TH AVENUE WEST	SEATTLE, WA 98119
55210	GETTIG ENG. AND MFG. COMPANY	PO BOX 85, OFF ROUTE 45	SPRING MILLS, PA 16875
73743	FISCHER SPECIAL MFG. CO.	446 MORGAN ST.	CINCINNATI, OH 45206
73803	TEXAS INSTRUMENTS, INC., METALLURGICAL MATERIALS DIV.	34 FOREST STREET	ATTLEBORO, MA 02703
74445	HOLO-KROME CO.	31 BROOK ST. WEST	HARTFORD, CT 06110
78189	ILLINOIS TOOL WORKS, INC. SHAKEPROOF DIVISION	ST. CHARLES ROAD	ELGIN, IL 60120
79136	WALDES, KOHLNOOR, INC.	47-16 AUSTEL PLACE	LONG ISLAND CITY, NY 11101
79807	WROUGHT WASHER MFG. CO.	2100 S. O BAY ST.	MILWAUKEE, WI 53207
80009	TEKTRONIX, INC.	P O BOX 500	BEAVERTON, OR 97077
83385	CENTRAL SCREW CO.	2530 CRESCENT DR.	BROADVIEW, IL 60153
93907	TEXTRON INC. CAMCAR DIV	600 18TH AVE	ROCKFORD, IL 61101
98291	SEAELECTRO CORP.	225 ROYT	MAMARONECK, NY 10544

Replaceable Mechanical Parts—SG 504

Fig. & Index No.	Tektronix Part No.	Serial/Model No. Eff Dscnt	Qty	1	2	3	4	5	Name & Description	Mfr Code	Mfr Part Number
-1	337-1399-02		2						SHLD,ELECTRICAL:SIDE WITH INSULATOR	80009	337-1399-02
									. EACH SIDE COVER INCLUDES:		
-2	342-0196-00		1						INSULATOR,FILM:	80009	342-0196-00
-3	015-0282-00		1						DIODE LEVELER:	80009	015-0282-00
-4	131-0778-00		1						CONNECTOR,PLUG:QUICK DISCONNECT	0000A	F 0.304 NYL
-5	366-0494-05		1						KNOB:GRAY,0.127 ID X 0.5 OD,0.531H	80009	366-0494-05
	213-0153-00		1						SETSCREW:5-40 X 0.125,STL BK OXD,HEX SKT	000CY	08D
-6	366-1286-04	B010100 B010569	1						KNOB:LATCH	80009	366-1286-04
	366-1690-00	B010570	1						KNOB:STL GY,0.53 X0.23 X 1.059 (ATTACHING PARTS)	80009	366-1690-00
-7	214-1840-00	B010100 B010569X	1						PIN,KNOB SECRG:0.094 OD X 0.120 INCH LONG	80009	214-1840-00
									- - - * - - -		
-8	366-0402-03		1						KNOB:GRAY,W/SPRING AND CRANK	80009	366-0402-03
	213-0153-00		2						SETSCREW:5-40 X 0.125,STL BK OXD,HEX SKT	000CY	08D
-9	331-0360-00		1						DIAL,CONTROL:5 TURN,0 THRU5.0	05129	771-S5
-10			1						RES.,VAR,WW:(SEE R275 REPL)		
-11			2						CONNECTOR,RCPT:(SEE J10 AND J80 REPL)		
-12			1						CONNECTOR,RCPT:(SEE J260 REPL) (ATTACHING PARTS)		
-13	220-0551-00		1						NUT,PLAIN,HEX.:9 MM X 0.437 INCH	73743	08D
-14	210-0255-00		1						TERMINAL,LUG:0.391" ID INT TOOTH	80009	210-0255-00
									- - - * - - -		
	175-1869-00		1						CA ASSY,SP,ELEC:50 OHM COAX,4.0 L	80009	175-1869-00
-15			1						CONNECTOR,RCPT,:(SEE J165 REPL)		
-16	131-0375-00		1						CONNECTOR,PLUG,:RIGHT ANGLE	98291	051-328-3188-220
-17	366-1559-00		3						PUSH BUTTON:STL GY,0.18 SQ X 0.43	80009	366-1559-00
-18	426-1072-00		3						FRAME,PUSH BTN:PLASTIC	80009	426-1072-00
-19			1						RES.,VAR NONWIR:(SEE R15 REPL) (ATTACHING PARTS)		
-20	210-0583-00		1						NUT,PLAIN,HEX.:0.25-32 X 0.312 INCH,BRS	73743	2X20317-402
-21	210-0940-00	B010100 B010225	1						WASHER,FLAT:0.25 ID X 0.375 INCH OD,STL	79807	08D
	210-0046-00	B010226	1						WASHER,LOCK:0.261 ID,INTL,0.018 THK,BRS (ATTACHING PARTS)	78189	1214-05-00-0541C
-22	333-1785-00		1						PANEL,FRONT:	80009	333-1785-00
-23	214-1513-01	B010100 B010569	1						LCH,PLUG-IN RET:	80009	214-1513-01
	105-0719-00	B010570	1						LATCH,RETAINING:PLUG-IN (ATTACHING PARTS)	80009	105-0719-00
-24	213-0113-00		1						SCR,TPG,THD FOR:2-32 X 0.312 INCH,PNH STL (ATTACHING PARTS)	93907	08D
									- - - * - - -		
	105-0718-00	XB010570 B010839	1						BAR,LATCH RLSE:	80009	105-0718-00
	105-0718-01	B010840	1						BAR,LATCH RLSE:	80009	105-0718-01
-25	200-0935-00		2						BASE,LAMPHOLDER:0.29 OD X 0.19 CASE	80009	200-0935-00
-26			2						LAMP,INCAND:(SEE DS320 AND DS574 REPL)		
-27	352-0157-00		2						LAMPHOLDER:WHITE PLASTIC	80009	352-0157-00
	210-0992-00		2						WASHER,NONMETAL:0.265 INCH ID X 0.437" OD	80009	210-0992-00
-28	378-0602-00		1						LENS,LIGHT:GREEN	80009	378-0602-00
-29	378-0602-01		1						LENS,LIGHT:AMBER	80009	378-0602-01
-30	386-2694-00		1						SUBPANEL,FRONT: (ATTACHING PARTS)	80009	386-2694-00
-31	213-0229-00	B010100 B010929	4						SCR,TPG,THD FOR:6-20 X0.375"100 DEG,FLH STL	93907	08D
	213-0123-00	B010930	4						SCREW,TPG,TF:6-32 X 0.375,SPCL TYPE,FLH (ATTACHING PARTS)	93907	08D
-32	337-1899-00		1						SHIELD,ELEC:REAR SUBPANEL	80009	337-1899-00
-33	331-0189-00		1						LENS,TAPE DIAL:MOLD ACRYLIC (ATTACHING PARTS)	80009	331-0189-00
-34	211-0105-00		2						SCREW,MACHINE:4-40 X 0.188,100 DEG,FLH STL (ATTACHING PARTS)	83385	08D
-35	386-1299-00		1						PL,RING,DIAL TA:PH BRZ (ATTACHING PARTS)	80009	386-1299-00
-36	354-0233-00		2						RING,RETAINING:0.100 ID X 0.203 INCH OD	79136	5133-14PP
-37	210-0803-00		2						WASHER,FLAT:0.15 ID X 0.032 THK,STL CD PL (ATTACHING PARTS)	12327	08D
-38	331-0188-04		1						DIAL,TAPE:PRINTED AND COILED	80009	331-0188-04
-39	401-0042-00		1						BEARING,CAM SW:0.255 ID X 0.50" OD,NYLON	80009	401-0042-00
-40	210-1043-00	B010100 B010619	2						WASHER,NONMETAL:0.254 ID X 0.685" OD,TEFLON	80009	210-1043-00

Replaceable Mechanical Parts—SG 504

Fig. & Index No.	Tektronix Part No.	Serial/Model No. Eff Dscnt	Qty	1 2 3 4 5	Name & Description	Mfr Code	Mfr Part Number
-41	210-1043-01 386-1290-00	B010620	2 1		WASHER, FLAT: 0.254 ID X 0.02 THK, PLSTC PL, MTG, DIAL WDO: BRS CD PL (ATTACHING PARTS)	80009 80009	210-1043-01 386-1290-00
-42	210-0413-00		1		NUT, PLAIN, HEX.: 0.375-32 X 0.50 INCH, STL	73743	3145-402
-43	210-0012-00		1		WASHER, LOCK: INTL, 0.375 ID X 0.50" OD STL	78189	1220-02-00-0541C
-44	211-0020-00		3		SCREW, MACHINE: 4-40 X 1.125 INCH, PNH STL	83385	OBD
-45	361-0165-00		3		SPACER, SLEEVE: 0.155 OD X 0.875 INCH LONG	80009	361-0165-00
-46	407-0386-00		1		BRACKET, ANGLE: DIAL TAPE, BRASS CD PL	80009	407-0386-00
-47	214-0953-00		1		GEAR, SPUR: 0.825 LONG THRU HUB (ATTACHING PARTS)	80009	214-0953-00
-48	213-0048-00 213-0075-00	B010100 B010225 B010226	4 4		SETSCREW: 4-40 X 0.125 INCH, HEX SOC STL SETSCREW: 4-40 X 0.094, STL BK OXD, HEX SKT (ATTACHING PARTS)	74445 000BK	OBD OBD
-49	384-1218-00		1		SHAFT, VAR RES:	80009	384-1218-00
-50	337-1944-00		1		SHIELD, ELEC: (ATTACHING PARTS)	80009	337-1944-00
-51	211-0008-00		8		SCREW, MACHINE: 4-40 X 0.25 INCH, PNH STL (ATTACHING PARTS)	83385	OBD
-52	-----		1		CKT BOARD ASSY: RF (SEE A2 REPL) (ATTACHING PARTS)		
-53	211-0116-00 211-0292-00	B010100 B011579 B011580	4 4		SCR, ASSEM WSHR: 4-40 X 0.312 INCH, PNH BRS SCR, ASSEM WSHR: 4-40 X 0.29, BRS NI PL (ATTACHING PARTS)	83385 78189	OBD OBD
-54	337-2288-00		1		SHIELD, ELEC: CIRCUIT CARD	80009	337-2288-00
-55	337-1945-00		2		SHIELD, ELEC:	80009	337-1945-00
-56	258-0481-00		1		WIRE MESH, KNIT: 0.094 DIA, 2 FEET LONG	07700	20-41211
-57	-----		2		TRANSISTOR: (SEE Q70 AND Q120 REPL) (ATTACHING PARTS FOR EACH)		
-58	220-0555-00		2		NUT, PLAIN, HEX.: 8-32 X 0.25 INCH STL	000EL	OBD
-59	210-0804-00		2		WASHER, FLAT: 0.17 ID X 0.375 INCH OD, STL	12327	OBD
-60	210-0839-00		2		WSHR, SPR TNSN: 0.25 ID X 0.438 OD (ATTACHING PARTS)	78189	3539-14-01-0541C
-61	214-2280-00		1		HEAT SINK, ELEC: 5.45 L, 0.80 AL (ATTACHING PARTS)	80009	214-2280-00
-62	210-0551-00		3		NUT, PLAIN, HEX.: 4-40 X 0.25 INCH, STL	83385	OBD
-63	210-0802-00		3		WASHER, FLAT: 0.15 ID X 0.312 INCH OD (ATTACHING PARTS)	12327	OBD
-64	129-0216-00		8		SPACER, POST: 0.187 OD, 0.312 INCH LONG	80009	129-0216-00
-65	-----		3		CONNECTOR, RCPT: (SEE J39, J41 AND J164 REPL)		
-66	131-0787-00		15		CONTACT, ELEC: 0.64 INCH LONG	22526	47359
-67	136-0252-04		1		SOCKET, PIN TERM: U/W 0.016-0.018 DIA PINS	22526	75060-007
-68	-----		1		CONNECTOR, BODY: (SEE J81 REPL)		
-69	334-2990-00 -----	XB010430	1 1		MARKER, IDENT: CAUTION OSCILLATOR, RF: (SEE A40 REPL) (ATTACHING PARTS)	22670	OBD
-70	211-0121-00		5		SCR, ASSEM WSHR: 4-40 X 0.438 INCH, PNH BRS (ATTACHING PARTS)	83385	OBD
-71	-----		1		CKT BOARD ASSY: MAIN (SEE A1 REPL) (ATTACHING PARTS)		
-72	213-0146-00		4		SCR, TPG, THD FOR: 6-20 X 0.313 INCH, PNH STL (ATTACHING PARTS)	83385	OBD
-73	210-0774-02		5		CKT BOARD INCLUDES: EYELET, METALLIC: 0.152 OD X 0.219 L, BRS	80009	210-0774-02
-74	214-0579-00		4		TERM, TEST POINT: BRS CD PL	80009	214-0579-00
-75	-----		1		SWITCH PUSH: (SEE S30A, B, C REPL)		
-76	361-0385-00		4		SPACER, PB SW: 0.164 INCH LONG	80009	361-0385-00
-77	131-0566-00		2		BUS CONDUCTOR, DUMMY RES, 2.375, 22 AWG	55210	L-2007-1
-78	131-0608-00		8		TERMINAL, PIN: 0.365 L X 0.025 PH BRZ GOLD	22526	47357
-79	136-0514-00		4		SKT, PL-IN ELEC: MICROCIRCUIT, 8 DIP	73803	C89002-8
-80	214-1254-00		1		HEAT SINK, ELEC: 0.422 H X 1.240 INCH OD	05820	209-AB
-81	342-0324-00		1		INSULATOR, DISC: TO-5 TRANSISTOR	13103	7717-5N-BLUE
-82	-----		1		SWITCH, SLIDE: (SEE S190 REPL)		
-83	136-0263-04		15		SOCKET, PIN TERM: FOR 0.025 INCH SQUARE PIN	22526	75377-001

Replaceable Mechanical Parts—SG 504

Fig. & Index No.	Tektronix Part No.	Serial/Model No. Eff Dscont	Qty	1	2	3	4	5	Name & Description	Mfr Code	Mfr Part Number
-84	136-0269-02		1	.					SKT, PL-IN ELEK: MICROCIRCUIT, 14 DIP, LOW CLE	73803	CS9002-14
-85	344-0154-00		4	.					CLIP, ELECTRICAL: PUSE, CKT BD MT	80009	344-0154-00
-86	-----		3	.					CONNECTOR, BODY: (SEE J11, J12 AND J20 REPL)		
-87	136-0252-04		6	.					SOCKET, PIN TERM: G/W 0.016-0.018 DIA PINS	22526	75060-007
-88	129-0277-00		4	.					SPACER, POST: 0.18 L, W/4-40THD THRU, BRASS	80009	129-0277-00
-89	214-1061-00		1						SPRING, GROUND: FLAT	80009	214-1061-00
-90	426-0725-05		1						FR SECT, PLUG-IN: TOP	80009	426-0725-05
	386-3657-00	XB010570 B011009	2						SUPPORT, PLUG-IN:	80009	386-3657-00
	386-3657-01	B011010	2						SUPPORT, PLUG IN:	93907	OBD
	210-1270-00	XB010570	2						WASHER, FLAT: 0.141 ID X 0.04 THK, AL	80009	210-1270-00
-91	426-0724-04		1						FR SECT, PLUG-IN: BOTTOM	80009	426-0724-04
-92	352-0161-03		1						CONN BODY, PL, EL: 3 WIRE ORANGE	80009	352-0161-03
-93	352-0163-05		1						CONN BODY, PL, EL: 5 WIRE GREEN	80009	352-0163-05
-94	131-0707-00		8						CONNECTOR, TERM.: 22-26 AWG, BRS& CU BR GOLD	22526	47439
-95	175-0826-00		FT						WIRE, ELECTRICAL: 3 WIRE RIBBON	80009	175-0826-00
-96	175-0828-00		FT						WIRE, ELECTRICAL: 5 WIRE RIBBON	08261	SS-0526-710610C
-97	175-1871-00		1						CA ASSY, SP, ELEC: 50 OHM COAX, 9.5 L	80009	175-1871-00
	210-0774-00		2						EYELET, METALLIC: 0.152 OD X 0.245 INCH L, BRS	80009	210-0774-00
	210-0775-00		2						EYELET, METALLIC: 0.126 OD X 0.23 INCH L, BRS	80009	210-0775-00
-98	175-1872-00		1						CA ASSY, SP, ELEC: 50 OHM COAX, 8.5 L	80009	175-1872-00
	210-0774-00		2						EYELET, METALLIC: 0.152 OD X 0.245 INCH L, BRS	80009	210-0774-00
	210-0775-00		2						EYELET, METALLIC: 0.126 OD X 0.23 INCH L, BRS	80009	210-0775-00
-99	175-1870-00		2						CA ASSY, SP, ELEC: 50 OHM COAX, 2.687 L	80009	175-1870-00
	-----		-						EACH CABLE INCLUDES:		
	131-0375-00		2	.					CONNECTOR, PLUG, : RIGHT ANGLE	98291	051-328-3188-220

