

Technical Reference

Tektronix

**TDS 410A, TDS 420A & TDS 460A
Digitizing Oscilloscope
Performance Verification and Specifications
070-9218-00**

Copyright © Tektronix, Inc. 1995. All rights reserved.

Tektronix products are covered by U.S. and foreign patents, issued and pending. Information in this publication supercedes that in all previously published material. Specifications and price change privileges reserved.

Printed in the U.S.A.

Tektronix, Inc., P.O. Box 1000, Wilsonville, OR 97070-1000

TEKTRONIX and TEK are registered trademarks of Tektronix, Inc.

WARRANTY

Tektronix warrants that this product will be free from defects in materials and workmanship for a period of three (3) years from the date of shipment. If any such product proves defective during this warranty period, Tektronix, at its option, either will repair the defective product without charge for parts and labor, or will provide a replacement in exchange for the defective product.

In order to obtain service under this warranty, Customer must notify Tektronix of the defect before the expiration of the warranty period and make suitable arrangements for the performance of service. Customer shall be responsible for packaging and shipping the defective product to the service center designated by Tektronix, with shipping charges prepaid. Tektronix shall pay for the return of the product to Customer if the shipment is to a location within the country in which the Tektronix service center is located. Customer shall be responsible for paying all shipping charges, duties, taxes, and any other charges for products returned to any other locations.

This warranty shall not apply to any defect, failure or damage caused by improper use or improper or inadequate maintenance and care. Tektronix shall not be obligated to furnish service under this warranty a) to repair damage resulting from attempts by personnel other than Tektronix representatives to install, repair or service the product; b) to repair damage resulting from improper use or connection to incompatible equipment; or c) to service a product that has been modified or integrated with other products when the effect of such modification or integration increases the time or difficulty of servicing the product.

THIS WARRANTY IS GIVEN BY TEKTRONIX WITH RESPECT TO THIS PRODUCT IN LIEU OF ANY OTHER WARRANTIES, EXPRESSED OR IMPLIED. TEKTRONIX AND ITS VENDORS DISCLAIM ANY IMPLIED WARRANTIES OF MERCHANTABILITY OR FITNESS FOR A PARTICULAR PURPOSE. TEKTRONIX' RESPONSIBILITY TO REPAIR OR REPLACE DEFECTIVE PRODUCTS IS THE SOLE AND EXCLUSIVE REMEDY PROVIDED TO THE CUSTOMER FOR BREACH OF THIS WARRANTY. TEKTRONIX AND ITS VENDORS WILL NOT BE LIABLE FOR ANY INDIRECT, SPECIAL, INCIDENTAL, OR CONSEQUENTIAL DAMAGES IRRESPECTIVE OF WHETHER TEKTRONIX OR THE VENDOR HAS ADVANCE NOTICE OF THE POSSIBILITY OF SUCH DAMAGES.

Table of Contents

General Safety Summary	v
Preface	vii
Performance Verification	
Performance Verification Procedures	1-1
Conventions	1-2
Brief Procedures	1-5
Self Tests	1-5
Functional Tests	1-7
Performance Tests	1-15
Prerequisites	1-15
Equipment Required	1-16
Test Record	1-18
Signal Acquisition System Checks	1-20
Time Base System Checks	1-34
Trigger System Checks	1-38
Output Signal Check	1-53
Sine Wave Generator Leveling Procedure	1-55
Specifications	
Specification	2-1
Nominal Traits	2-3
Warranted Characteristics	2-11
Typical Characteristics	2-17

List of Figures

Figure 1-1: Map of Display Functions	1-3
Figure 1-2: Verifying Adjustments and Signal Path Compensation .	1-6
Figure 1-3: Universal Test Hookup for Functional Tests	1-8
Figure 1-4: Initial Test Hookup	1-20
Figure 1-5: Initial Test Hookup	1-23
Figure 1-6: Initial Test Hookup	1-26
Figure 1-7: Measurement of Analog Bandwidth	1-29
Figure 1-8: Initial Test Hookup	1-31
Figure 1-9: Measurement of Channel Delay	1-33
Figure 1-10: Initial Test Hookup	1-34
Figure 1-11: Measurement of Accuracy — Long-Term and Delay-Time	1-37
Figure 1-12: Initial Test Hookup	1-38
Figure 1-13: Initial Test Hookup	1-41
Figure 1-14: Measurement of Trigger Sensitivity	1-43
Figure 1-15: Initial Test Hookup	1-45
Figure 1-16: Confirming Auxiliary Triggering at Maximum Triggering Frequency	1-46
Figure 1-17: Initial Test Hookup	1-47
Figure 1-18: Adjusting Sync Pulse Amplitude	1-49
Figure 1-19: Measurement of Video Sensitivity	1-50
Figure 1-20: Initial Test Hookup	1-52
Figure 1-21: Initial Test Hookup	1-54
Figure 1-22: Measurement of Probe Compensator Limits	1-55
Figure 1-23: Sine Wave Generator Leveling Equipment Setup	1-56
Figure 1-24: Equipment Setup for maximum Amplitude	1-57
Figure 2-1: TDS 400A Dimensional Drawing	2-9

List of Tables

Table 1–1: Test Equipment	1–16
Table 1–2: DC Offset Accuracy	1–22
Table 1–3: Analog Bandwidth (TDS 410A and TDS 420A)	1–27
Table 1–4: Analog Bandwidth (TDS 460A)	1–28
Table 2–1: Key Features of the TDS 400A Oscilloscopes	2–1
Table 2–2: Nominal Traits — Signal Acquisition System	2–3
Table 2–3: Nominal Traits — Time Base System	2–5
Table 2–4: Nominal Traits — Triggering System	2–5
Table 2–5: Nominal Traits — Display System	2–6
Table 2–6: Nominal Traits — Data Storage	2–6
Table 2–7: Nominal Traits — GPIB Interface, Video Output, and Power Fuse	2–6
Table 2–8: Nominal Traits — Mechanical	2–7
Table 2–9: Warranted Characteristics — Signal Acquisition System	2–11
Table 2–10: Warranted Characteristics — Time Base System	2–13
Table 2–11: Warranted Characteristics — Triggering System	2–14
Table 2–12: Warranted Characteristics — Probe Compensator Output	2–14
Table 2–13: Warranted Characteristics — Power Requirements ...	2–14
Table 2–14: Warranted Characteristics — Environmental, Safety, and Reliability	2–15
Table 2–15: Typical Characteristics — Signal Acquisition System ..	2–17
Table 2–16: Typical Characteristics — Time Base System	2–18
Table 2–17: Typical Characteristics — Triggering System	2–19
Table 2–18: Typical Characteristics — Data Handling	2–20

General Safety Summary

Review the following safety precautions to avoid injury and prevent damage to this product or any products connected to it.

Only qualified personnel should perform service procedures.

Injury Precautions

- | | |
|-----------------------------------------------|------------------------------------------------------------------------------------------------------------------------------------------------------------------------------------------------------------------------------------------------------------------------------------------|
| Use Proper Power Cord | To avoid fire hazard, use only the power cord specified for this product. |
| Avoid Electric Overload | To avoid electric shock or fire hazard, do not apply a voltage to a terminal that is outside the range specified for that terminal. |
| Ground the Product | This product is grounded through the grounding conductor of the power cord. To avoid electric shock, the grounding conductor must be connected to earth ground. Before making connections to the input or output terminals of the product, ensure that the product is properly grounded. |
| Do Not Operate Without Covers | To avoid electric shock or fire hazard, do not operate this product with covers or panels removed. |
| Use Proper Fuse | To avoid fire hazard, use only the fuse type and rating specified for this product. |
| Do Not Operate in Wet/Damp Conditions | To avoid electric shock, do not operate this product in wet or damp conditions. |
| Do Not Operate in Explosive Atmosphere | To avoid injury or fire hazard, do not operate this product in an explosive atmosphere. |

Product Damage Precautions

- | | |
|-----------------------------------|-----------------------------------------------------------------------------------------------|
| Use Proper Power Source | Do not operate this product from a power source that applies more than the voltage specified. |
| Provide Proper Ventilation | To prevent product overheating, provide proper ventilation. |

Do Not Operate With Suspected Failures

If you suspect there is damage to this product, have it inspected by qualified service personnel.

Safety Terms and Symbols

Terms in This Manual

These terms may appear in this manual:



WARNING. *Warning statements identify conditions or practices that could result in injury or loss of life.*



CAUTION. *Caution statements identify conditions or practices that could result in damage to this product or other property.*

Terms on the Product

These terms may appear on the product:

DANGER indicates an injury hazard immediately accessible as you read the marking.

WARNING indicates an injury hazard not immediately accessible as you read the marking.

CAUTION indicates a hazard to property including the product.

Symbols on the Product

The following symbols may appear on the product:



DANGER
High Voltage



Protective Ground
(Earth) Terminal



ATTENTION
Refer to
Manual



Double
Insulated

Preface

This is the Performance Verification for the TDS 410A, TDS 420A, and TDS 460A Oscilloscopes. It contains procedures suitable for determining if the oscilloscope functions, is adjusted properly, and meets the performance characteristics as warranted.

Also contained in this document are the specifications for the TDS 400A Digitizing Oscilloscopes.

Related Manuals

The following documents relate to the use or service of the digitizing oscilloscope.

- The *TDS 410A, TDS 420A & TDS 460A User Manual* describes how to operate your digitizing oscilloscope.
- The *TDS Family Programmer Manual* describes using a computer to control the digitizing oscilloscope through the GPIB interface.
- The *TDS 410A, TDS 420A & TDS 460A Reference* gives you a quick overview of how to operate your digitizing oscilloscope.
- The *TDS 410A, TDS 420A & TDS 460A Service Manual* provides information for maintaining and servicing your digitizing oscilloscope to the module level.
- The *TDS Family Option 2F Instruction Manual* describes use of the Advanced DSP Math option (for TDS oscilloscopes equipped with that option only).
- The *TDS Family Option 13 Instruction Manual* describes using the optional Centronics® and RS-232 interfaces for obtaining hard copies (for TDS oscilloscopes equipped with that option only).
- The *TDS Family Option 3P Instruction Manual* describes using the optional Printerpak (for TDS oscilloscopes equipped with that option only).

Performance Verification Procedures

Two types of Performance Verification procedures can be performed on this product: *Brief Procedures* and *Performance Tests*. You may not need to perform all of these procedures, depending on what you want to accomplish:

- To rapidly confirm that this oscilloscope functions and is adjusted properly, just do the procedures under *Self Tests*, which begin on page 1–5.

Advantages: These procedures are quick to do, require no external equipment or signal sources, and perform extensive functional and accuracy testing to provide high confidence that the oscilloscope will perform properly. Use these procedures as a quick check before making a series of important measurements.

- To further check functionality, first do the *Self Tests* just mentioned; then do the procedures under *Functional Tests* that begin on page 1–7.

Advantages: These procedures require minimal additional time to perform, require no additional equipment other than a standard-accessory probe, and more completely test the internal hardware of this oscilloscope. Use these procedures to quickly determine if the oscilloscope is suitable for putting into service, such as when it is first received.

- If more extensive confirmation of performance is desired, do the *Performance Tests*, beginning on page 1–15, after doing the *Functional* and *Self Tests* just referenced.

Advantages: These procedures add direct checking of warranted specifications. They require more time to perform and suitable test equipment is required. (See *Equipment Required* on page 1–16.)

Conventions

Throughout these procedures the following conventions apply:

- Each test procedure uses the following general format:

Title of Test

Equipment Required

Prerequisites

Procedure

- Each procedure consists of as many steps and substeps as required to do the test. Steps and substeps are sequenced as follows:

1. First Step

- a. First Substep

- b. Second Substep

2. Second Step

- In steps and substeps, the lead-in statement in italics instructs you what to do, while the instructions that follow tell you how to do it: in the example step below, “*Initialize the oscilloscope*” by doing “Press save/recall **SETUP**. Now, press the main-menu button... .”

Initialize the oscilloscope: Press save/recall **SETUP**. Now, press the main-menu button **Recall Factory Setup**; then the side-menu button **OK Confirm Factory Init**.

- Where instructed to use a front-panel button or knob, or select from a main or side menu, or verify a readout or status message, the name of the button or knob appears in boldface type: “press **SHIFT**; then **ACQUIRE MENU**,” “press the main-menu button **Coupling**,” or “verify that the status message is *Pass*.”

STOP. *This symbol is accompanied by information you must read to do procedures properly.*

- Refer to Figure 1–1: “Main menu” refers to the menu that labels the seven menu buttons under the display; “side menu” refers to the menu that labels the five buttons to the right of the display.

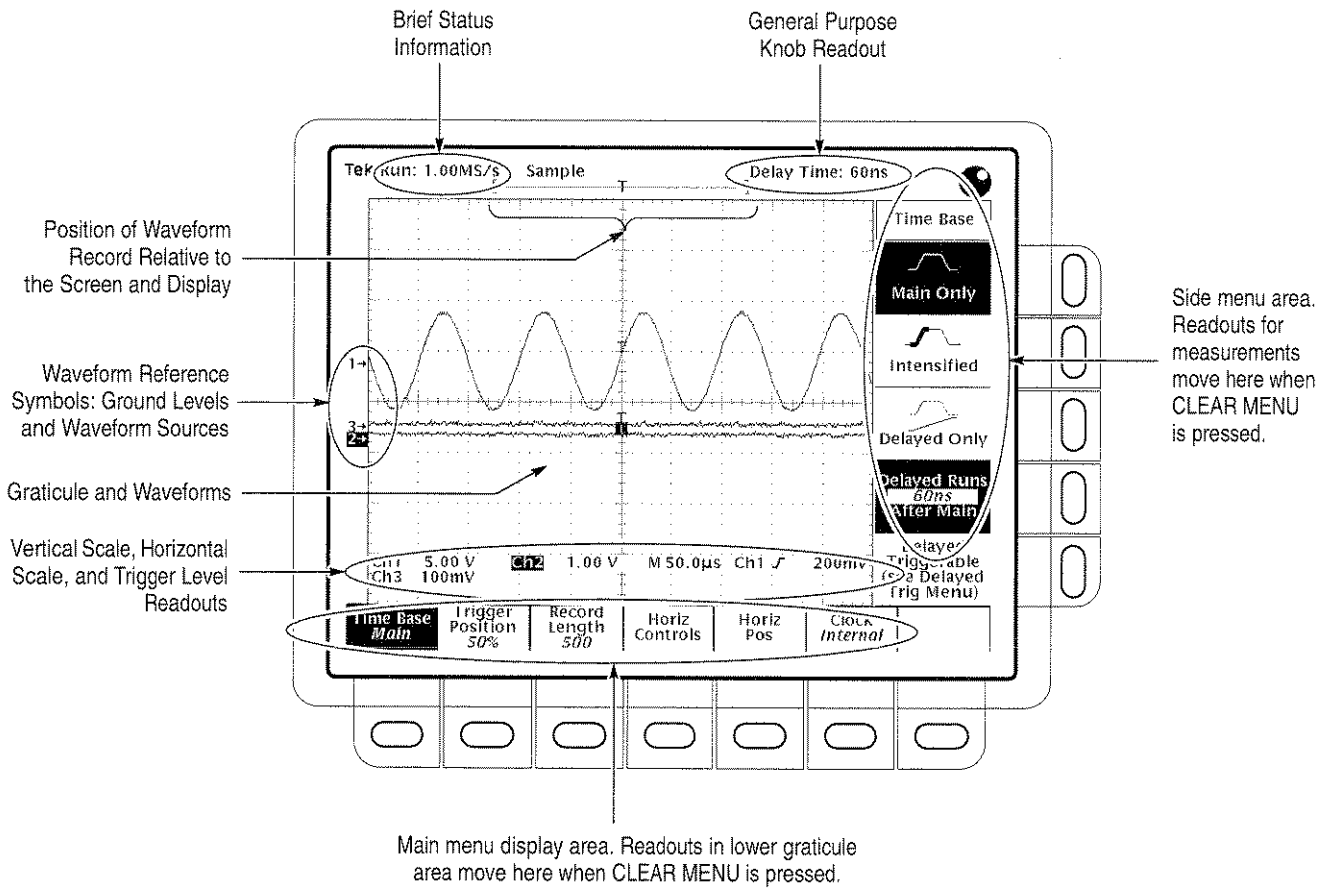

Figure 1-1: Map of Display Functions

Brief Procedures

The *Self Tests* use internal routines to confirm basic functionality and proper adjustment. No test equipment is required to do these test procedures.

The *Functional Tests* use the probe-adjust output at the front panel as a test-signal source for further verifying that the oscilloscope functions properly. A standard-accessory probe, included with this oscilloscope, is the only equipment required.

Self Tests

This procedure uses internal routines to verify that this oscilloscope functions and passes its internal self tests and signal path compensations. It also confirms that the oscilloscope was adjusted properly at the time it was last adjusted. No test equipment or hookups are required.

Verify Internal Adjustment, Self Compensation, and Diagnostics

Equipment Required	None
Prerequisites	Power on the digitizing oscilloscope and allow a 20 minute warm-up before doing this procedure.

1. *Verify that internal diagnostics pass:* Do the following substeps to verify that the internal diagnostics passed.
 - a. *Display the system diagnostics menu:*
 - Press **SHIFT**; then press **UTILITY**.
 - Repeatedly press the main-menu button **System** until **Diag/Err** is highlighted in the menu that pops up.
 - Repeatedly press the main-menu button **Area** until **All** is highlighted in the menu that pops up.
 - b. *Run the system diagnostics:* Press the main-menu button **Execute**; then press the side-menu button **OK Confirm Run Test**.
 - c. *Wait:* The internal diagnostics do an exhaustive verification of proper oscilloscope function. This verification takes up to two minutes. While it progresses, a variety of test patterns flash on screen. When finished, the resulting status appears on the screen.
 - d. *Confirm no failures are found:* Verify that no failures are found and reported on screen.

- e. Confirm the four adjustment sections have passed status:
 - Press **SHIFT**; then press **UTILITY**.
 - Press the main menu button **System** until **Cal** is highlighted in the pop-up menu.
 - Verify that the word **Pass** appears in the main menu under the following menu labels: **Voltage Reference**, **High Frequency Response**, **Low Frequency Response**, and **Trigger Skew**. (See Figure 1–2.)

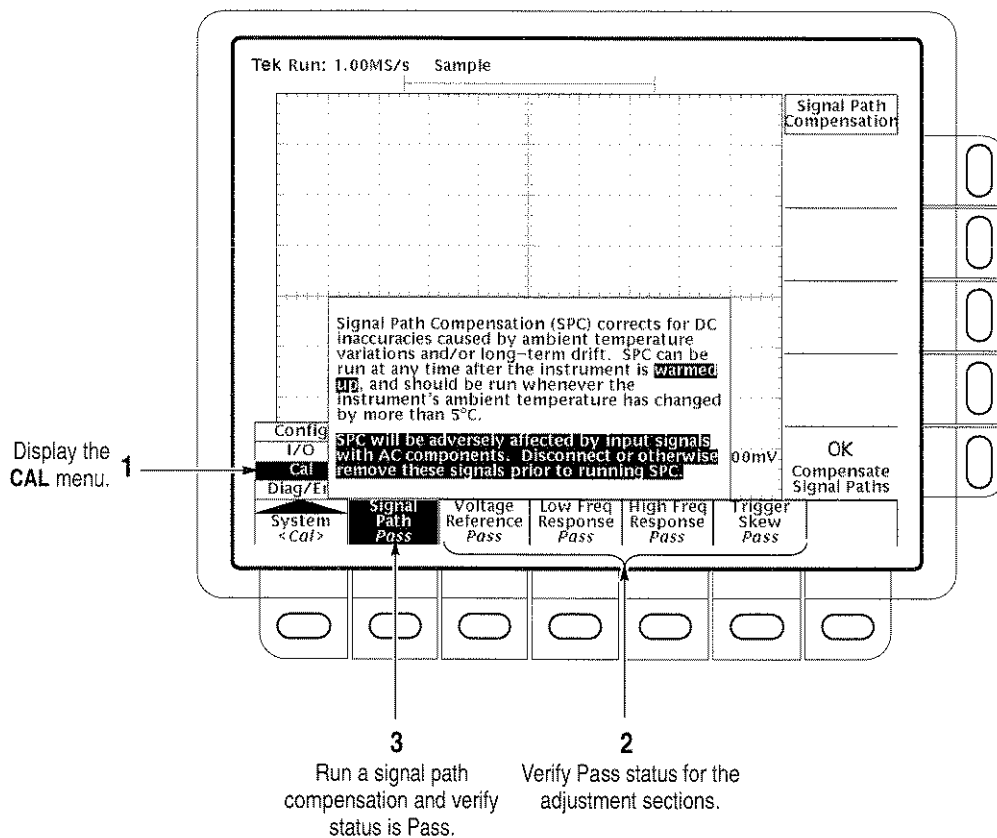

Figure 1–2: Verifying Adjustments and Signal Path Compensation

This oscilloscope lets you compensate the internal signal path used to acquire the waveforms you acquire and measure. By executing the signal path compensation feature (SPC), you optimize the oscilloscope capability to make accurate measurements based on the ambient temperature.

You *must* run an SPC anytime you wish to ensure that the measurements you make are made with the most accuracy possible. You should also run an SPC if the temperature has changed more than 5° C since the last SPC was performed.

- f. *Run the signal path compensation:* Disconnect all input signals. Press the main-menu button **Signal Path**; then press the side-menu button **OK Compensate Signal Paths**.

NOTE. *Failure to run the signal path compensation may result in the oscilloscope not meeting warranted performance levels.*



- g. *Wait:* signal path compensation runs in one to three minutes. While it progresses, a “clock” icon (shown at left) displays on screen. When compensation completes, the status message updates to *Pass* or *Fail* in the main menu (see step h).
 - h. *Confirm signal path compensation returns passed status:* Verify the word *Pass* appears under **Signal Path** in the main menu. (See Figure 1–2.)
2. *Return to regular service:* Press **CLEAR MENU** to exit the system menus.

Functional Tests

The purpose of these procedures is to confirm that this oscilloscope functions properly. The only equipment required is one of the standard-accessory probes and a 3.5", 720 K or 1.44 Mbyte floppy disk.

STOP. These procedures verify functions; that is, they verify that oscilloscope features operate. They do not verify that they operate within limits.

Therefore, when the instructions in the functional tests that follow call for you to verify that a signal appears on screen “that is about five divisions in amplitude” or “has a period of about six horizontal divisions,” and so forth., do **NOT** interpret the quantities given as limits. Operation within limits is checked in Performance Tests, which begin on page 1–15.

DO NOT make changes to the front-panel settings that are not called out in the procedures. Each verification procedure requires you to set the oscilloscope to certain default settings before verifying functions. If you make changes to these settings, other than those called out in the procedure, you may obtain invalid results. In this case, just redo the procedure from step 1.

When you are instructed to press a menu button, the button may already be selected (its label will be highlighted). If this is the case, it is not necessary to press the button.

Verify All Input Channels

Equipment Required	One P6138 probe
Prerequisites	None

1. Install the test hookup and preset the oscilloscope controls:

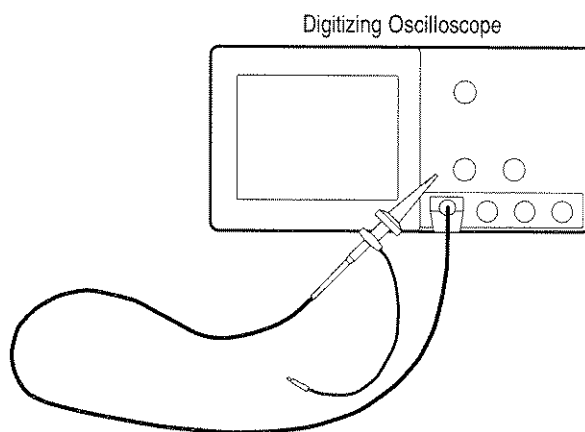

Figure 1–3: Universal Test Hookup for Functional Tests

- a. *Hook up the signal source:* Install the probe on **CH 1**. Connect the probe tip to **PROBE ADJ** on the front panel; leave the probe ground unconnected.

- b. Initialize the oscilloscope:*
 - Press save/recall **SETUP**.
 - Press the main-menu button **Recall Factory Setup**.
 - Press the side-menu button **OK Confirm Factory Init**.
 - 2. Verify that all input channels operate:* Do the following substeps — test CH 1 first, *skipping substep a since CH 1 is already set up for verification from step 1.*
 - a. Select an unverified channel:*
 - Press **WAVEFORM OFF** to remove from display the channel just verified.
 - Press the front-panel button that corresponds to the channel you are to verify.
 - Move the probe to the channel you selected.
 - b. Set up the selected channel:*
 - Press **AUTOSET** to obtain a viewable, triggered display in the selected channel.
 - Set the vertical **SCALE** to 100 mV. Use the vertical **POSITION** knob to center the waveform vertically on screen.
 - Set the horizontal **SCALE** to 200 μ s.
 - Press **TRIGGER MENU**.
 - Press the main-menu button **Coupling**; then press the side menu-button **HF Rej**.
 - c. Verify that the channel is operational:* Confirm that the following statements are true.
 - The vertical scale readout for the channel under test shows a setting of 100 mV, and a square-wave probe-compensation signal about five divisions in amplitude is on screen. (See Figure 1–1 on page 1–3 to locate the readout.)
 - The vertical **POSITION** knob moves the signal up and down the screen when rotated.
 - Turning the vertical **SCALE** knob counterclockwise decreases the amplitude of the waveform on-screen, turning the knob clockwise increases the amplitude, and returning the knob to 100 mV returns the amplitude to about five divisions.

- d. *Verify that the channel acquires in all acquisition modes:* Press **SHIFT**; then press **ACQUIRE MENU**. Use the side menu to select, in turn, each of the five hardware acquire modes and confirm that the following statements are true. Refer to the icons at the left of each statement as you confirm those statements.



- **Sample** mode displays an actively acquiring waveform on screen. (Note that there is noise present on the peaks of the square wave.)



- **Peak Detect** mode displays an actively acquiring waveform on screen with the noise present in Sample mode “peak detected.”



- **Hi Res** mode displays an actively acquiring waveform on screen with the noise that was present in Sample mode reduced.



- **Envelope** mode displays an actively acquiring waveform on screen with the noise displayed.



- **Average** mode displays an actively acquiring waveform on screen with the noise reduced like in Hi Res mode.

- e. *Test all channels:* Repeat substeps a through d until all input channels are verified.

3. *Remove the test hookup:* Disconnect the probe from the channel input and the probe-adjust terminal.

Verify the Time Base

Equipment Required	One P6138 probe
Prerequisites	None

1. *Install the test hookup and preset the oscilloscope controls:*
 - a. *Hook up the signal source:* Install the probe on **CH 1**. Connect the probe tip to **PROBE ADJ** on the front panel; leave the probe ground unconnected. (See Figure 1–3 on page 1–8.)
 - b. *Initialize the oscilloscope:*
 - Press save/recall **SETUP**.
 - Press the main-menu button **Recall Factory Setup**; then press the side-menu button **OK Confirm Factory Init**.
 - c. *Modify default settings:*
 - Press **AUTOSET** to obtain a viewable, triggered display.
 - Set the horizontal **SCALE** to 200 μ s.

- Press **VERTICAL MENU**.
 - Press the main-menu button **Bandwidth**. Then press the side-menu button **20 MHz**.
 - Press **CLEAR MENU** to remove the vertical menu from the screen.
2. *Verify that the time base operates:* Confirm the following statements.
 - a. One period of the square-wave probe-compensation signal is about five horizontal divisions on-screen for the 200 μ s horizontal scale setting (set in step 1c).
 - b. Rotating the horizontal **SCALE** knob clockwise expands the waveform on-screen (more horizontal divisions per waveform period), counter-clockwise rotation contracts it, and returning the horizontal scale to 200 μ s returns the period to about five divisions.
 - c. The horizontal **POSITION** knob positions the signal left and right on screen when rotated.
 3. *Remove the test hookup:* Disconnect the probe from the channel input and the probe-adjust terminal.

Verify the Main and Delayed Trigger Systems

Equipment Required	One P6138 probe
Prerequisites	None

1. *Install the test hookup and preset the oscilloscope controls:*
 - a. *Hook up the signal source:* Install the probe on **CH 1**. Connect the probe tip to **PROBE ADJ** on the front panel; leave the probe ground unconnected. (See Figure 1-3 on page 1-8.)
 - b. *Initialize the oscilloscope:*
 - Press save/recall **SETUP**.
 - Press the main-menu button **Recall Factory Setup**.
 - Press the side-menu button **OK Confirm Factory Init**.
 - c. *Modify default settings:*
 - Press **AUTOSET** to obtain a viewable, triggered display.
 - Set the horizontal **SCALE** for the **M** (main) time base to 200 μ s.
 - Press **VERTICAL MENU**.

- Press the main-menu button **Bandwidth**; then press the side-menu button **20 MHz**.
 - Press **TRIGGER MENU**.
 - Press the main-menu button **Mode & Holdoff**.
 - Press the side-menu button **Normal**.
 - Press **CLEAR MENU** to remove the menus from the screen.
2. *Verify that the main trigger system operates:* Confirm that the following statements are true.
- The trigger-level readout for the main trigger system changes when you rotate the trigger **MAIN LEVEL** knob.
 - The trigger-level knob can trigger and untrigger the square-wave signal as you rotate it. (Leave the signal *untriggered*.)
 - Pressing **SET LEVEL TO 50%** triggers the signal that you just left untriggered. (Leave the signal triggered.)
3. *Verify that the delayed trigger system operates:*
- a. *Select the delayed time base:*
 - Press **HORIZONTAL MENU**.
 - Press the main-menu button **Time Base**.
 - Press the side-menu button **Delayed Triggerable**; then press the side-menu button **Delayed Only**.
 - Set the horizontal **SCALE** for the **D** (delayed) time base to 200 μ s.
 - b. *Select the delayed trigger-level menu:*
 - Press **SHIFT**; then press **DELAYED TRIG**.
 - Press the main-menu button **Level**; then press the side-menu button **Level**.
 - c. *Confirm that the following statements are true:*
 - The trigger-level readout for the delayed trigger system changes when you rotate the general purpose knob.
 - The general purpose knob can trigger and untrigger the square-wave probe-compensation signal as you rotate it. (Leave the signal *untriggered*.)

- Pressing the side-menu button **Set to 50%** triggers the probe-compensation signal that you just left untriggered. (Leave the signal triggered.)
- d. *Verify the delayed trigger counter:*
- Press the main-menu button **Delay by Time**.
 - Press the side-menu button **Events**, just below the **Triggerable after Time** selection.
 - Use the General Purpose knob to enter an event count of 325 events.
 - Verify that the trigger **READY** indicator on the front panel flashes about once every second as the waveform is updated on screen.
4. *Remove the test hookup:* Disconnect the standard-accessory probe from the channel input and the probe-adjust terminal.

Verify the File System

Equipment Required	One 720 K or 1.44 Mbyte, 3.5 inch DOS compatible disk (formatted).
Prerequisites	None

1. *Preset the digitizing oscilloscope controls:*
- a. Insert the disk in the disk drive.
 - b. Press save/recall **SETUP**. Press the main menu button **Recall Factory Setup**; then press the side menu button **Ok Confirm Factory Init**.
 - c. Set the horizontal **SCALE** to 200 μ s (one click clockwise). Notice the horizontal readout now displays 200 μ s at the bottom of the screen.
2. *Verify the file system works:*
- a. Press save/recall **SETUP**. Press the main menu button **Save Current Setup**; then press the side menu button **To File**.
 - b. Turn the general purpose knob to select the file to save. Choose **TEK?????.SET**. With this choice, you will save a file starting with **TEK**, then containing five digits, and a **.SET** extension. For example, the first time you run this on a blank, formatted disk or on the Example Programs Disk, the digitizing oscilloscope will assign the name **TEK00000.SET** to your file. If you ran the procedure again, the digitizing oscilloscope would increment the name and call the file **TEK00001.SET**.
 - c. Press the side-menu button **Save To Selected File**.

- d. Set the horizontal **SCALE** to 500 μ s, and then use the vertical **POSITION** knob to place the channel 1 baseline trace two divisions above center screen.
 - e. Press the main menu button **Recall Saved Setup**; then press the side menu button **From File**.
 - f. Turn the general purpose knob to select the file to recall. For example, if you followed the instructions above and used a blank disk, you had the digitizing oscilloscope assign the name `TEK00000.SET` to your file.
 - g. Press the side-menu button **Recall From Selected File**.
 - h. Verify that the digitizing oscilloscope retrieved the saved setup from the disk. Do this by noting that the horizontal **SCALE** again reads 200 μ s and the channel 1 baseline waveform is again vertically positioned near center screens as when you saved the setup.
3. *Remove the test hookup:* Remove the disk from the disk drive.

Performance Tests

This section contains procedures for checking that the TDS 400A Digitizing Oscilloscopes perform as warranted.

The procedures are arranged in four logical groupings: *Signal Acquisition System Checks*, *Time Base System Checks*, *Triggering System Checks*, and *Output Ports Checks*. They check all the characteristics that are designated as checked in Chapter 2, *Specification*. (The characteristics that are checked appear in **boldface** type under *Warranted Characteristics* in Chapter 2.) You can use the form at the end of this section as a test record.

STOP. *These procedures extend the confidence level provided by the basic procedures described on page 1–5. The basic procedures should be done first, and then these procedures performed if desired.*

Prerequisites

The tests in this chapter comprise an extensive, valid confirmation of performance and functionality when the following requirements are met:

- The cabinet must be installed on the digitizing oscilloscope.
- You must have performed and passed the procedures under *Self Tests*, found on page 1–5, and those under *Functional Tests*, found on page 1–7.
- A signal-path compensation *must* have been done within the recommended calibration interval and at a temperature within $\pm 5^{\circ}$ C of the present operating temperature. (If at the time you did the prerequisite *Self Tests*, the temperature was within the limits just stated, consider this prerequisite met.)
- The digitizing oscilloscope must have been last adjusted at an ambient temperature between $+20^{\circ}$ C and $+30^{\circ}$ C, must have been operating for a warm-up period of at least 20 minutes, and must be operating at an ambient temperature between 0° C and $+50^{\circ}$ C. (The warm-up requirement is usually met in the course of meeting the prerequisites listed above.)

Related Information

Read *Performance Verification Procedures* and *Conventions* that start on page 1–1. Also, if you are not familiar with operating this digitizing oscilloscope, read *Operating Information* in Chapter 2 of the service manual or read the user manual before doing any of these procedures.

Equipment Required

These procedures use external, traceable signal sources to directly check warranted characteristics. The test equipment required is shown in Table 1–1.

Table 1–1: Test Equipment

Item Number and Description	Minimum Requirements	Example	Purpose
1. Attenuator, 10X (three required)	Ratio: 10X; impedance 50 Ω ; connectors: female BNC input, male BNC output	Tektronix part number 011-0059-02	Signal Attenuation
2. Attenuator, 5X (two required)	Ratio: 5X; impedance 50 Ω ; connectors: female BNC input, male BNC output	Tektronix part number 011-0060-02	Signal Attenuation
3. Termination, 50 Ω	Impedance 50 Ω ; connectors: female BNC input, male BNC output	Tektronix part number 011-0049-01	Checking delay match between channels
4. Termination, 75 Ω	Impedance 75 Ω ; connectors: female BNC input, male BNC output	Tektronix part number 011-0102-01	Used to test Video Option 05 equipped oscilloscopes only
5. Cable, Precision Coaxial (three required)	50 Ω , 36 in, male to male BNC connectors	Tektronix part number 012-0482-00	Signal Interconnection
6. Cable, Coaxial	75 Ω , 36 in, male to male BNC connectors	Tektronix part number 012-1338-00	Used to test Video Option 05 equipped oscilloscopes only
7. Connector, Dual-Banana (two required)	Female BNC to dual banana	Tektronix part number 103-0090-00	Various Accuracy Tests
8. Connector, BNC "T"	Male BNC to dual female BNC	Tektronix part number 103-0030-00	Checking Trigger Sensitivity
9. Coupler, Dual-Input	Female BNC to dual male BNC	Tektronix part number 067-0525-02	Checking Delay Match Between Channels
10. Generator, DC Calibration	Variable amplitude to ± 110 V; accuracy to 0.1%	Data Precision 8200, with 1 kV option installed	Checking DC Offset and Measurement Accuracy
11. Generator, Sine Wave	100 kHz to at least 400 MHz. Variable amplitude from 12 mV to 2 V_{p-p} . Frequency accuracy >2.0%	Rohde & Schwarz SMY ¹	Checking Analog Bandwidth, Trigger Sensitivity, Sample-rate, External Clock, and Delay-Time Accuracy
12. Meter, Level and Power Sensor	Frequency range: 10 MHz to 400 MHz. Amplitude range: 6 mV _{p-p} to 2 V_{p-p}	Rohde & Schwarz URV 35, with NRV-Z8 power sensor	Checking Analog Bandwidth and Trigger Sensitivity
13. Splitter, Power	Frequency range: DC to 1 GHz. Tracking: >2.0%	Rohde & Schwarz RVZ	Checking Analog Bandwidth
14. Generator, Function	Frequency range 5 MHz to 10 MHz. Square wave transition time ≤ 25 ns. Amplitude range: 0 to 10 V_{p-p} into 50 Ω	Tektronix CFG280	Checking External Clock
15. Adapter (four required)	Male N to female BNC	Tektronix 103-0045-00	Checking Analog Bandwidth
16. Adapter	Female N to male BNC	Tektronix 103-0058-00	Checking Analog Bandwidth

Table 1–1: Test Equipment (Cont.)

Item Number and Description	Minimum Requirements	Example	Purpose
17. Probe, 10X included with this oscilloscope	A PP6138 probe	Tektronix P6138	Signal Interconnection
18. Generator, Video Signal	Provides NTSC compatible outputs	Tektronix TSG 1001	Checking Video Trigger Sensitivity

¹ If available, items 11, 12, 13, and 15 can be replaced by a Tektronix SG 503 and SG 504. If available, a TG 501A may be used to check Sample-rate and Delay-time Accuracy. (A TM 500 or TM 5000 Series Power Module Mainframe is required.) If using a TG 501A, you may also need a 2X attenuator (50 Ω BNC), Tektronix part number 011-0069-02.

Test Record

Photocopy this and the next page and use them to record the performance test results for your oscilloscope.

TDS 400A Test Record

Oscilloscope Serial Number: _____	Certificate Number: _____
Temperature: _____	RH %: _____
Date of Calibration: _____	Technician: _____

Performance Test	Minimum	Incoming	Outgoing	Maximum
Offset Accuracy				
CH1 Offset	+1 V	995 mV	_____	+ 1.005 V
	+10 V	9.935 V	_____	+ 10.065 V
	+99.9 V	99.2505 V	_____	+ 100.5495 V
CH2 Offset	+1 V	995 mV	_____	+ 1.005 V
	+10 V	9.935 V	_____	+ 10.065 V
	+99.9 V	99.2505 V	_____	+ 100.5495 V
CH3 Offset (TDS 420A & TDS 460A)	+1 V	995 mV	_____	+ 1.005 V
	+10 V	9.935 V	_____	+ 10.065 V
	+99.9 V	99.2505 V	_____	+ 100.5495 V
CH4 Offset (TDS 420A & TDS 460A)	+1 V	995 mV	_____	+ 1.005 V
	+10 V	9.935 V	_____	+ 10.065 V
	+99.9 V	99.2505 V	_____	+ 100.5495 V
DC Voltage Measurement Accuracy (Averaged)				
CH1 100 mV	-20.8 mV	_____	_____	+20.8 mV
CH2 100 mV	-20.8 mV	_____	_____	+20.8 mV
CH3 100 mV (TDS 420A and TDS 460A)	-20.8 mV	_____	_____	+20.8 mV
CH4 100 mV (TDS 420A and TDS 460A)	-20.8 mV	_____	_____	+20.8 mV
Analog Bandwidth				
CH1 100 mV	424 mV	_____	_____	N/A
CH2 100 mV	424 mV	_____	_____	N/A
CH3 100 mV (TDS 420A and TDS 460A)	424 mV	_____	_____	N/A
CH4 100 mV (TDS 420A and TDS 460A)	424 mV	_____	_____	N/A
Time Base System				
Delay Between Channels	N/A	_____	_____	450 ps
Delta Time @ 20 ns (100 MHz)	9.7 ns	_____	_____	10.3 ns
Long Term Sample Rate/ Delay Time @ 10 ns/100 μs	1.5 Div 0.5 Div	_____	_____	1.5 Div 0.5 Div

TDS 400A Test Record (Cont.)

Oscilloscope Serial Number: _____ Certificate Number: _____
 Temperature: _____ RH %: _____
 Date of Calibration: _____ Technician: _____

Performance Test	Minimum	Incoming	Outgoing	Maximum
Trigger System (DC Coupled Threshold)				
Main Trigger	-18 mV	_____	_____	+18 mV
Main Trigger — Falling	-18 mV	_____	_____	+18 mV
Main Trigger	-18 mV	_____	_____	+18 mV
Delayed Trigger — Falling	-18 mV	_____	_____	+18 mV
Auxiliary Trigger		_____	_____	10 MHz
External Clock		_____	_____	10 MHz
Probe Compensator Output Signal				
Frequency	950 Hz	_____	_____	1050 Hz
Voltage	475 mV	_____	_____	525 mV

Signal Acquisition System Checks

These procedures check those characteristics that relate to the signal-acquisition system and are listed as checked under *Warranted Characteristics* in Chapter 2, *Specifications*.

Check Offset Accuracy

Equipment Required	Two dual-banana connectors (Item 7)
	One BNC T connector (Item 8)
	One DC calibration generator (Item 10)
	Two precision coaxial cables (Item 5)
Prerequisites	The oscilloscope must meet the prerequisites listed on page 1–15

1. *Install the test hookup and preset the instrument controls:*

a. *Hook up the test-signal source:*

- Set the output of a DC calibration generator to 0 volts.
- Connect the output of a DC calibration generator through a dual-banana connector followed by a 50 Ω precision coaxial cable to one side of a BNC T connector (see Figure 1–4).
- Connect the Sense output of the generator through a second dual-banana connector followed by a 50 Ω precision coaxial cable to the other side of the BNC T connector. Now connect the BNC T connector to **CH 1**.

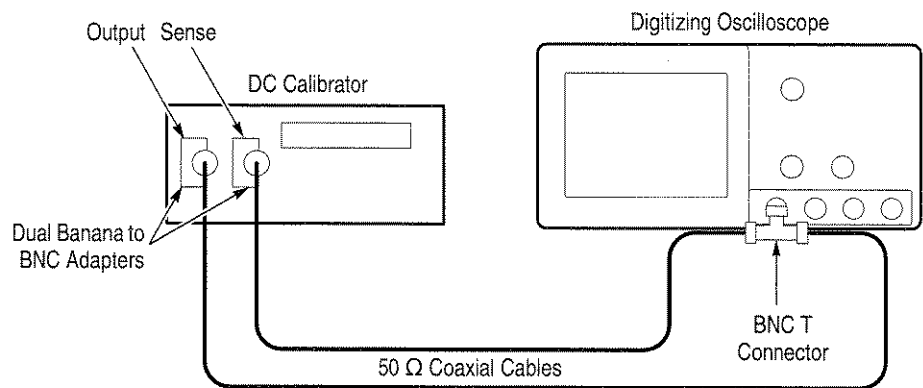

Figure 1–4: Initial Test Hookup

- b. *Initialize the oscilloscope:*
 - Press save/recall **SETUP**.
 - Press the main-menu button **Recall Factory Setup**.
 - Press the side-menu button **OK Confirm Factory Init**.
 - c. *Modify the default settings:*
 - Set the horizontal **SCALE** to 1 ms.
 - Press **SHIFT**; then **ACQUIRE MENU**.
 - Press the main-menu button **Mode**; then press the side-menu button **Hi Res**.
 - Press **DISPLAY**.
 - Press the main-menu button **Graticule**; then press the side-menu button **Frame**.
 - Press **MEASURE**.
 - Press the main-menu button **Select Measurement for CHx**; then press the side-menu button **Mean**. (You will have to press **MORE** several times to access the **Mean** measurement.)
 - Press **CLEAR MENU**.
2. *Confirm input channels are within limits for offset accuracy: Do the following substeps — test CH 1 first, skipping substep a since CH 1 is already set up to be checked from step 1.*



WARNING. High voltages are used in this procedure. Before doing this or any other procedure in this manual, read the Safety Summary found at the beginning of this manual.

- a. *Select an unchecked channel:*
 - Press **WAVEFORM OFF** to remove the channel just confirmed from the display. Then, press the front-panel button that corresponds to the channel you are to confirm.
 - Press **MEASURE**.
 - Press the main-menu button **Select Measurement for CHx**; then press the side-menu button **Mean**. (You will have to press **MORE** several times to access the **Mean** measurement.)

Table 1–2: DC Offset Accuracy

Vertical Scale Setting	Vertical Position	Offset Setting	Generator Setting	Offset Accuracy Limits
1 mV	0	+1 V	+1 V	±5 mV
100 mV	0	+10 V	+10 V	±65 mV
1 V	0	+99.9 V	+99.9 V	±649.5 mV

- b. *Set the vertical scale:* Set the vertical **SCALE** to one of the settings listed in Table 1–2 that is not yet checked. (Start with the first setting listed.)
 - c. *Set the offset:* Press the **VERTICAL MENU** button and then the **Offset** main-menu button. Using the **General Purpose** knob, set the offset as dictated by Table 1–2. (Start with the first setting listed.)
 - d. *Set the generator:* Set the DC calibration generator to match the vertical scale as dictated by Table 1–2. (Start with the first setting listed.)
 - e. *Check against limits:* Do the following subparts in the order listed.
 - Subtract the measured mean from the generator setting. The result is the offset accuracy
 - CHECK that the offset accuracy is within the limits listed for the current vertical scale setting.
 - Repeat substeps b through e until all vertical scale settings listed in Table 1–2 are checked for the channel under test.
 - f. *Test all channels:* Repeat substeps a through e for all input channels.
3. *Disconnect the hookup:*
 - a. *Set the generator output to 0 V.*
 - b. Then disconnect the cable from the generator output at the input connector of the channel last tested.

Check DC Voltage Measurement Accuracy (Averaged)

Equipment Required	Two dual-banana connectors (Item 7) One BNC T connector (Item 8) One DC calibration generator (Item 10) Two precision coaxial cables (Item 5)
Prerequisites	The oscilloscope must meet the prerequisites listed on page 1–15

1. *Install the test hookup and preset the instrument controls:*

a. *Hook up the test-signal source:*

- Set the output of a DC calibration generator to 0 volts.
- Connect the output of a DC calibration generator through a dual-banana connector followed by a 50 Ω precision coaxial cable to one side of a BNC T connector (see Figure 1–5).
- Connect the Sense output of the generator through a second dual-banana connector followed by a 50 Ω precision coaxial cable to the other side of the BNC T connector. Now connect the BNC T connector to **CH 1**.

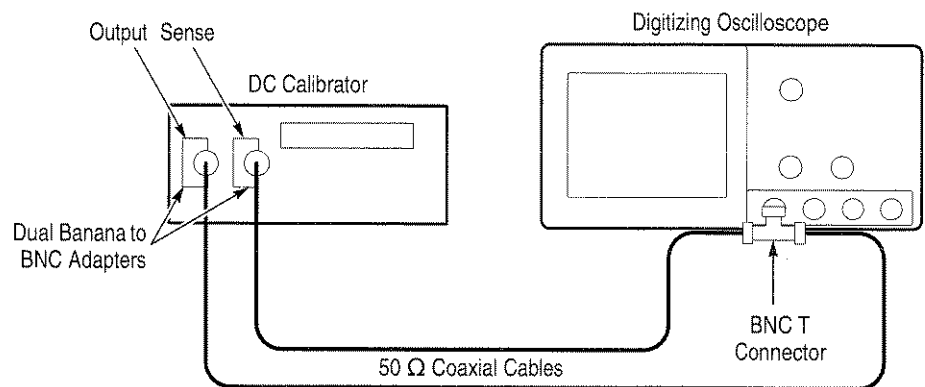

Figure 1–5: Initial Test Hookup

b. *Initialize the oscilloscope:*

- Press save/recall **SETUP**.
- Press the main-menu button **Recall Factory Setup**.
- Press the side-menu button **OK Confirm Factory Init**.

c. *Modify the default settings:*

- Press **SHIFT** and then **ACQUIRE MENU**.
- Press the main-menu button **Mode**; then press the side-menu button **Average 16**.
- Press **DISPLAY**.
- Press the main-menu button **Graticule**; then press the side-menu button **Frame**.

- Press **MEASURE**.
 - Press the main-menu button **Select Measurement for CHx**; then press the side-menu button **Mean**. (You will have to press **MORE** several times to access the **Mean** measurement.)
 - Set the vertical **SCALE** to 100 mV.
 - Press the **VERTICAL MENU** button and then the **Offset** main-menu button. Set the offset to 0 V.
 - Set the vertical **POSITION** to 0 V.
2. *Confirm input channels are within limits for DC delta voltage accuracy: Do the following substeps — test CH 1 first, skipping substep a since CH 1 is already selected from step 1.*
- a. *Select an unchecked channel:*
- Set the generator output to 0 V.
 - Press **WAVEFORM OFF** to remove the channel just confirmed from the display.
 - Press the front-panel button that corresponds to the next channel you are to confirm.
 - Press **MEASURE**.
 - Press the main-menu button **Select Measurement for CHx**; then press the side-menu button **Mean**. (You will have to press **MORE** several times to access the **Mean** measurement.)
 - Move the test hook up to the channel you select.
 - Set the vertical **SCALE** to 100 mV.
 - Set the vertical **POSITION** to 0 V.
 - Press the **VERTICAL MENU** button and then the **Offset** main-menu button. Set the offset to 0 V.
- b. *Set the generator:* Set the DC calibration generator to +0.35 V.
- c. *Record Measurement:* Read the mean at the measurement readout, and record this number on a piece of scratch paper.
- d. *Set the generator:* Set the DC calibration generator to -0.35 V.

- e. *Check against limits:* Do the following subparts in the order listed.
- Use this formula to calculate voltage measurement accuracy.

$$700 \text{ mV} - (\text{mean from step c} - (\text{present mean}))$$
For example:

$$700 \text{ mV} - (347 \text{ mV} - (-358 \text{ mV})) = -5 \text{ mV}$$
 - CHECK that the voltage measurement accuracy is within $\pm 20.8 \text{ mV}$.
- f. *Test all channels:* Repeat substeps a through e for all channels.
3. *Disconnect the hookup:*
- a. *Set the generator output to 0 V.*
 - b. Then disconnect the cable from the generator output at the input connector of the channel last tested.

Check Analog Bandwidth

Equipment Required	One sine wave generator (Item 11) One level meter and power sensor (Item 12) One power splitter (Item 13) One Female N to Male BNC Adapter (Item 16) Four Male N to Female BNC Adapters (Item 15) Two 50 Ω precision cables (Item 5) Two 10X attenuators (Item 1).
Prerequisites	See page 1-15

1. *Install the test hookup and preset the instrument controls:*
- a. *Initialize the oscilloscope:*
 - Press save/recall **SETUP**. Then press the main-menu button **Recall Factory Setup**.
 - Press the side-menu button **OK Confirm Factory Init**.
 - b. *Modify the default settings:*
 - Press **TRIGGER MENU**.
 - Press the main-menu button **COUPLING**; then press the side menu button **Noise Rej**.

- Press **SHIFT**; then **ACQUIRE MENU**.
- Press the main-menu button **Mode**; then press the side-menu button **Average 16**.
- Press **Measure**. Now press the main-menu button **High–Low Setup**; then press the side-menu button **Min–Max**.

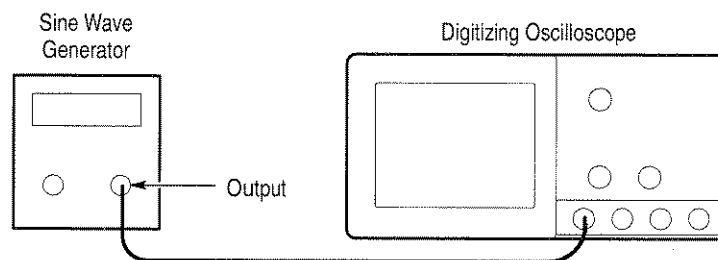

Figure 1–6: Initial Test Hookup

NOTE. Refer to the Sine Wave Generator Leveling Procedure on page 1–55 if your sine wave generator does not have automatic output amplitude leveling.

- c. *Hook up the test-signal source:*
 - Connect the sine wave output of a sine wave generator to **CH 1** (see Figure 1–6). Set the output of the generator to a reference frequency of 10 MHz or less.
 - Set the horizontal **SCALE** to 50 ns. (If using a reference other than 10 MHz, adjust the horizontal **SCALE** to display 4 to 6 cycles of the waveform.)
2. *Confirm the input channels are within limits for analog bandwidth:* Do the following substeps — test CH 1 first, *skipping substeps a and b since CH 1 is already set up for testing from step 1.*
 - a. *Select an unchecked channel:*
 - Press **WAVEFORM OFF** to remove the channel just confirmed from display.
 - Press the front-panel button that corresponds to the channel you are to confirm.
 - Move the leveled output of the sine wave generator to the channel you select.

- b. *Match the trigger source to the channel selected:*
- Press **TRIGGER MENU**.
 - Press the main-menu button **Source**.
 - Press the side-menu button that corresponds to the channel selected.
- c. *Set the input impedance of the channel:*
- Press **VERTICAL MENU**; then press the main-menu button **Coupling**.
 - Press the side-menu button **Ω** to toggle it to the 50 Ω setting.
- d. *Set the vertical scale:* Set the vertical **SCALE** to one of the settings listed in Table 1–3 (TDS 410A and TDS 420A) or Table 1–4 (TDS 460A) not yet checked. (Start with the 100 mV setting.)

Table 1–3: Analog Bandwidth (TDS 410A and TDS 420A)

Vertical Scale	Reference Amplitude	Horizontal Scale	Test Frequency	Limits
100 mV	600 mV (6 divisions)	5 ns	200 MHz	≥424 mV
1 V	2 V (2 divisions)	5 ns	200 MHz	≥1.414 V
500 mV	2 V (4 divisions)	5 ns	200 MHz	≥1.414 V
200 mV	1.2 V (6 divisions)	5 ns	200 MHz	≥848 mV
50 mV	300 mV (6 divisions)	5 ns	200 MHz	≥212 mV
20 mV	120 mV (6 divisions)	5 ns	200 MHz	≥84 mV
10 mV	60 mV (6 divisions)	5 ns	200 MHz	≥42 mV
5 mV	30 mV (6 divisions)	5 ns	200 MHz	≥21 mV
2 mV	12 mV (6 divisions)	5 ns	150 MHz	≥8.4 mV
1 mV	6 mV (6 divisions)	5 ns	95 MHz	≥4.2 mV

Table 1–4: Analog Bandwidth (TDS 460A)

Vertical Scale	Reference Amplitude	Horizontal Scale	Test Frequency	Limits
100 mV	600 mV (6 divisions)	2 ns	400 MHz	≥ 424 mV
1 V	2 V (2 divisions)	2 ns	400 MHz	≥ 1.414 V
500 mV	2 V (4 divisions)	2 ns	400 MHz	≥ 1.414 V
200 mV	1.2 V (6 divisions)	2 ns	400 MHz	≥ 848 mV
50 mV	300 mV (6 divisions)	2 ns	400 MHz	≥ 212 mV
20 mV	120 mV (6 divisions)	2 ns	400 MHz	≥ 84 mV
10 mV	60 mV (6 divisions)	2 ns	400 MHz	≥ 42 mV
5 mV	30 mV (6 divisions)	2 ns	400 MHz	≥ 21 mV
2 mV	12 mV (6 divisions)	2 ns	250 MHz	≥ 8.4 mV
1 mV	6 mV (6 divisions)	2 ns	100 MHz	≥ 4.2 mV

- e. *Display the test signal:* Do the following subparts to first display the reference signal and then the test signal.
- Press **MEASURE**; then press the main-menu button **Select Measurement for CHx**.
 - Now press the side menu button **more** until the menu label **Pk-Pk** appears in the side menu (its icon is shown at the left). Press the side-menu button **Pk-Pk**.
 - Press **CLEAR MENU**.
 - Set the sine wave generator output (if necessary, use 10X attenuators) so the CHx Pk-Pk readout equals the reference amplitude in Table 1–3 (TDS 410A and TDS 420A) or Table 1–4 (TDS 460A) that corresponds to the vertical scale set in substep d.
 - Press the front-panel button **SET LEVEL TO 50%** as necessary to trigger a stable display.
- f. *Measure the test signal:*
- Increase the frequency of the generator output (leveled output) to the test frequency in Table 1–3 (TDS 410A and TDS 420A) or Table 1–4 (TDS 460A) that corresponds to the vertical scale set in substep d.
 - Set the horizontal **SCALE** to 5 ns (TDS 410A and TDS 420A) or 2 ns (TDS 460A).
 - Press **SET LEVEL TO 50%** as necessary to trigger the display.



- Read the results at the CHx Pk-Pk readout, which automatically measures the amplitude of the test signal. (See Figure 1–7.)

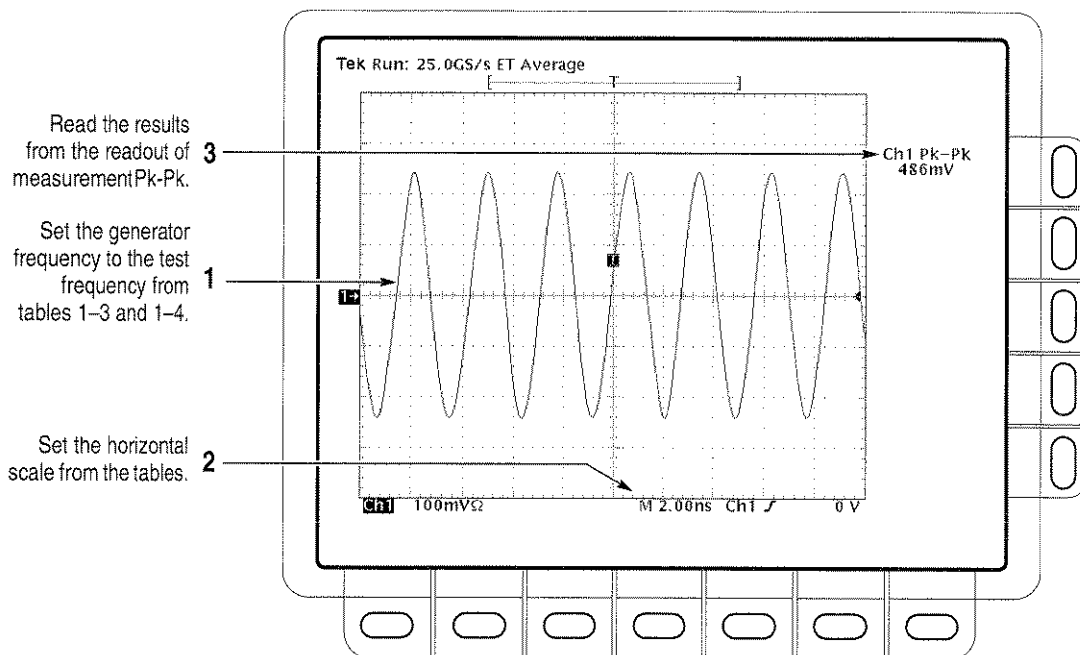

Figure 1–7: Measurement of Analog Bandwidth

g. Check against limits:

- CHECK that the **Pk-Pk** readout on screen is within the limits listed in Table 1–3 (TDS 410A and TDS 420A) or Table 1–4 (TDS 460A) for the current vertical scale setting.
- When finished checking, set the horizontal **SCALE** back to the 50 ns setting (the setting you used in step 1b).

STOP. Checking the bandwidth of each channel at all vertical scale settings is time consuming and unnecessary. You may skip checking the remaining vertical scale settings in Table 1–3 (TDS 410A and TDS 420A) or Table 1–4 (TDS 460A) (that is, skip the following substep, h) if this digitizing oscilloscope has performed as follows:

- Passed the 100 mV vertical scale setting just checked in this procedure.
- Passed the *Verify Internal Adjustment, Self Compensation, and Diagnostics* procedure found under *Self Tests*, on page 1–5.

NOTE. *Passing the signal path compensation confirms the signal path for all vertical scale settings for all channels. Passing the internal diagnostics ensures that the factory-set adjustment constants that control the bandwidth for each vertical scale setting have not changed.*

- h. *Check remaining vertical scale settings against limits (optional):*
 - If desired, finish checking the remaining vertical scale settings for the channel under test by repeating substeps d through g for each of the remaining scale settings listed in Table 1–3 (TDS 410A and TDS 420A) or Table 1–4 (TDS 460A) for the channel under test.
 - When doing substep e, skip the subparts that turn on the CHx Pk-Pk measurement until you check a new channel.
 - Install/remove 10X attenuators between the generator leveled output and the channel input as is needed to obtain the six division reference signals listed in the tables.
 - i. *Test all channels:* Repeat substeps a through g for all channels.
3. *Disconnect the hookup:* Disconnect the test hook up from the input connector of the channel last tested.

Check Delay Match Between Channels

Equipment Required	One sine wave generator (Item 11) One precision coaxial cable (Item 5) One 50 Ω terminator (Item 3) One dual-input coupler (Item 9)
Prerequisites	See page 1–15.

STOP. DO NOT use the vertical position knob to reposition any channel while doing this check. To do so invalidates the test.

- 1. *Install the test hookup and preset the oscilloscope controls:*
 - a. *Initialize the front panel;*
 - Press save/recall **SETUP**.
 - Press the main-menu button **Recall Factory Setup**.
 - Press the side-menu button **OK Confirm Factory Init**.

b. *Modify the initialized front-panel control settings:*

- Do *not* adjust the vertical position of any channel during this procedure.
- Set the horizontal **SCALE** to 1 ns.
- Press **SHIFT**; then press **ACQUIRE MENU**.
- Press the main-menu button **Mode**, and then press the side-menu button **Average 16**.

c. *Hook up the test-signal source:*

- Connect the sine wave output of a sine wave generator to a 50 Ω precision coaxial cable, a 50 Ω termination, and a dual-input coupler. (See Figure 1–8.)
- Connect the coupler to both **CH 1** and **CH 2**. *Ensure that the coupler cables are of equal length.*

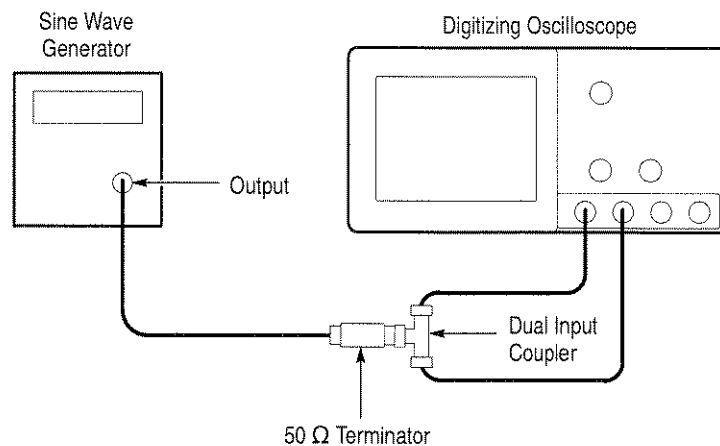

Figure 1–8: Initial Test Hookup

2. *Confirm all channels are within limits for channel delay:*

- a. *Set up the generator:* Set the generator frequency to 250 MHz and the amplitude for about five divisions in CH 1.

Hint: as you are adjusting the generator amplitude, push **SET LEVEL TO 50%** frequently to speed up the updating of the waveform amplitude on screen.

- b. *Save a CH 2 waveform:* Press **CH 2**; then press save/recall **WAVEFORM**. Now, press the main-menu button **Save Waveform**; then press the side-menu button **To Ref 2**.

- c. If you are testing a TDS 410A, skip to step h.
- d. *Save a CH 3 waveform:* Move the coupler from **CH 2** to **CH 3**, so that **CH 1** and **CH 3** are driven. Press **CH 3**; then press the side-menu button **To Ref 3**.
- e. *Display all test signals:*
 - Press **WAVEFORM OFF** twice to remove CH 2 and CH 3 from the display.
 - Move the coupler from **CH 3** to **CH 4**, so that CH 1 and CH 4 are driven. Press **CH 4** to display.
 - Now, press the front-panel button **MORE**. Press the main-menu buttons **Ref 2** and **Ref 3**.
- f. *Measure the test signal:*
 - Locate the point on the rising edge of the left-most waveform where it crosses the center horizontal graticule line. This is the *time reference point* for this waveform. Note the corresponding *time reference point* for the right-most waveform. See Figure 1–9.
 - Press **CURSOR**; then press the side-menu button **V Bars**.
 - Press **CLEAR MENU**.
 - Rotate the General Purpose knob to align one cursor to the *time reference point* of the left-most waveform edge and the other cursor to the *time reference point* of the right-most waveform edge. (Press **TOGGLE** to switch between the two cursors.) See Figure 1–9.
 - Read the measurement results at the Δ : cursor readout, not the @: readout on screen.
- g. *Check all channels against limit:* CHECK that the cursor readout on screen is ≤ 450 ps. If the cursor readout is ≤ 200 ps, skip substep h.

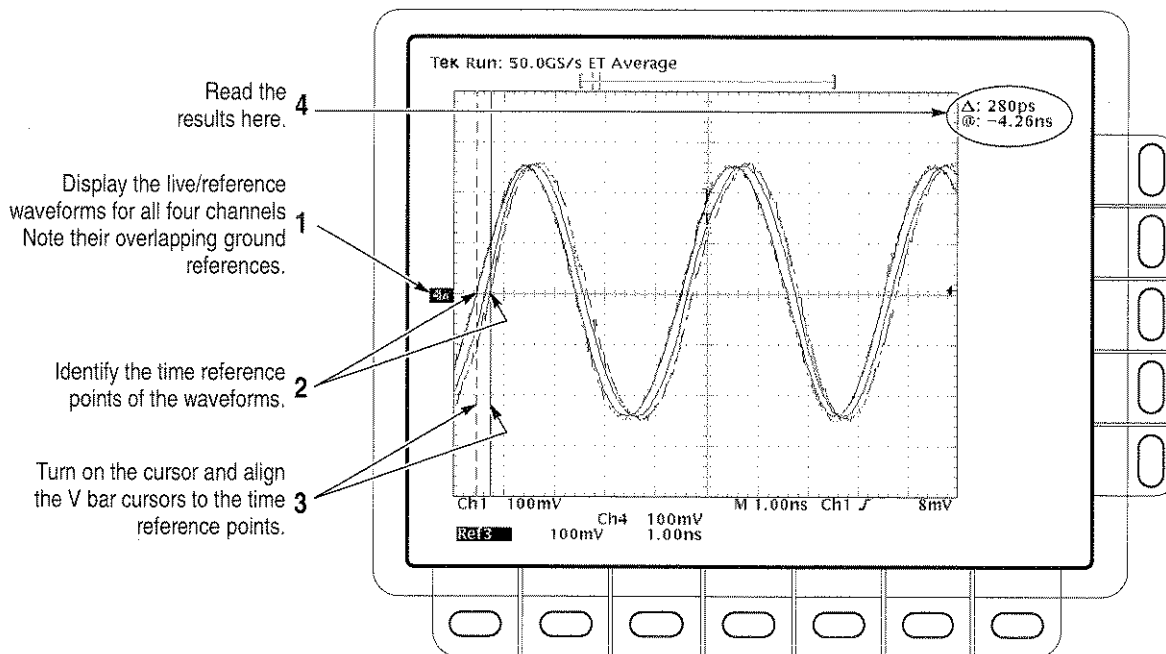

Figure 1-9: Measurement of Channel Delay

- h. Check CH 1 to CH 2 and CH 3 to CH 4 against limit:
- Press **WAVEFORM OFF** four times to remove all waveforms.
 - Press **CH 1**.
 - Press **MORE**; then press the main-menu button **Ref 2**.
 - Measure the delay between CH 1 and Ref 2 using the method described in substep f above.
 - CHECK that the cursor readout on screen is ≤ 200 ps.
 - If you are testing a TDS 410A, skip to step 3.
 - Press **WAVEFORM OFF** twice to turn off CH 1 and Ref 2; then press **CH 4** to turn on CH 4.
 - Press **MORE**; then press the main-menu button **Ref 3** to display the CH 3 waveform stored in Ref 3.
 - Measure the delay between Ref 3 and CH 4 using the method described in substep f above.
 - CHECK that the cursor readout on screen is ≤ 200 ps.

3. *Disconnect the hookup:* Disconnect the cable from the generator output at the input connectors of the channels.

Time Base System Checks

These procedures check those characteristics that relate to the Main and Delayed time base system and are listed as checked under *Warranted Characteristics* in Chapter 2, *Specifications*.

Check Accuracy for Long-Term Sample Rate, Delay Time, and Delta Time Measurements

Equipment Required	One time standard, frequency accurate sine wave generator or time marker generator (Item 11) Attenuators, 10X and 5X (Items 1 and 2) One precision coaxial cable (Item 5).
Prerequisites	See page 1–15.

1. *Install the test hookup and preset the oscilloscope controls:*
 - a. *Hook up the test-signal source:* Connect, through a 50 Ω precision coaxial cable, the output of a time standard to **CH 1** (see Figure 1–10). Set the output of the standard to 100 MHz (or a period of 10 ns).

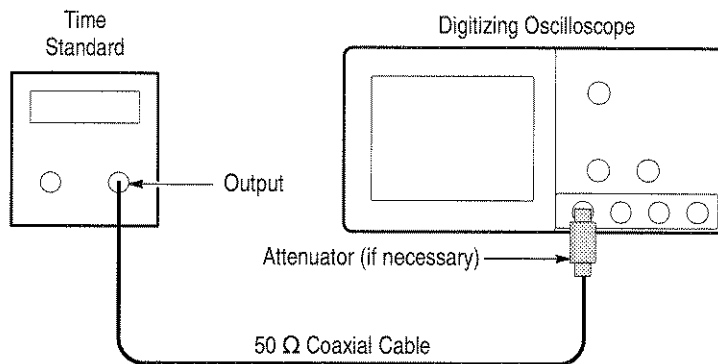

Figure 1–10: Initial Test Hookup

- b. *Initialize the oscilloscope:*
 - Press save/recall **SETUP**.
 - Press the main-menu button **Recall Factory Setup**.
 - Press the side-menu button **OK Confirm Factory Init**.

- c. *Modify the initialized front-panel control settings:*
 - Press **VERTICAL MENU**; then press the main-menu button **Coupling**. Press the side-menu button Ω to change the coupling setting to **50 Ω** .
 - If necessary, set the vertical **SCALE** to 100 mV per division.
 - Set the horizontal **SCALE** of the Main time base to 2.0 ns.
 - Using external attenuators if necessary, adjust the time standard amplitude for a 5 to 7 division display.
 - Rotate the vertical **POSITION** control to center the displayed waveform.
2. *Confirm Main and Delayed time bases are within limits for accuracies:*
 - a. *Check delta-time accuracy against limits:*
 - Press **SET LEVEL TO 50%**.
 - Press **SHIFT**; then **ACQUIRE MENU**. Now press the main-menu button **Mode**; then press the side-menu button **Average**.
 - Use the **General Purpose** knob to set the number of averages to 8.
 - Press **MEASURE**.
 - Press the main-menu button **High-Low Setup**; then press the side-menu button **Min-Max**.
 - Press the main-menu button **Select Measurement for Ch1**.
 - Press the side-menu button **–more–**, until **PERIOD** appears in the side menu. Press **PERIOD**.
 - Press **CLEAR MENU**.
 - CHECK that the readout for **CH 1 Per** is within 9.7 ns to 10.3 ns.
 - b. *Check long-term sample rate and delay time accuracies against limits:*
 - Press **SHIFT**; then **ACQUIRE MENU**. Now press the main-menu button **Mode**; then press the side-menu button **Sample**.
 - Press **MEASURE**.
 - Press the main-menu button **Remove Measurement**; then press the side-menu button **Measurement 1**.
 - Set the horizontal **SCALE** of the Main time base to 100 ns.

- Set the frequency of the time standard to 1.0 MHz (or a period of 1.00 μ s).
- Adjust the amplitude of the time standard for a 5 to 7 division display.
- Press **CLEAR MENU**.
- Press **SET LEVEL TO 50%**.
- Rotate the horizontal and vertical **POSITION** controls to move the rising edge of the waveform so that it crosses the center of both the horizontal and vertical graticule lines.
- Press **HORIZONTAL MENU**; then press the main-menu button **Time Base**. Press the side-menu button **Delayed Only**
- Use the horizontal **SCALE** knob to set the **D** (delayed) time base to 100 ns.
- Press the side-menu button **Delayed Runs After Main**; then use the **General Purpose** knob to set **Delayed Runs After Main** to 10.0 μ s.
- **CHECK** that the rising edge of the waveform crosses the center horizontal graticule line at a point within ± 0.5 divisions of the center graticule (see Figure 1-11).
- Use the horizontal **SCALE** knob to set the **D** (delayed) time base to 50 μ s. (The scale of the Main time base will also change.)
- Use the **General Purpose** knob to set **Delayed Runs After Main** to 100 μ s.
- Use the horizontal **SCALE** knob to set the **D** (delayed) time base to 100 ns.
- **CHECK** that the rising edge of the waveform crosses the center horizontal graticule line at a point within ± 0.5 divisions of the center graticule.

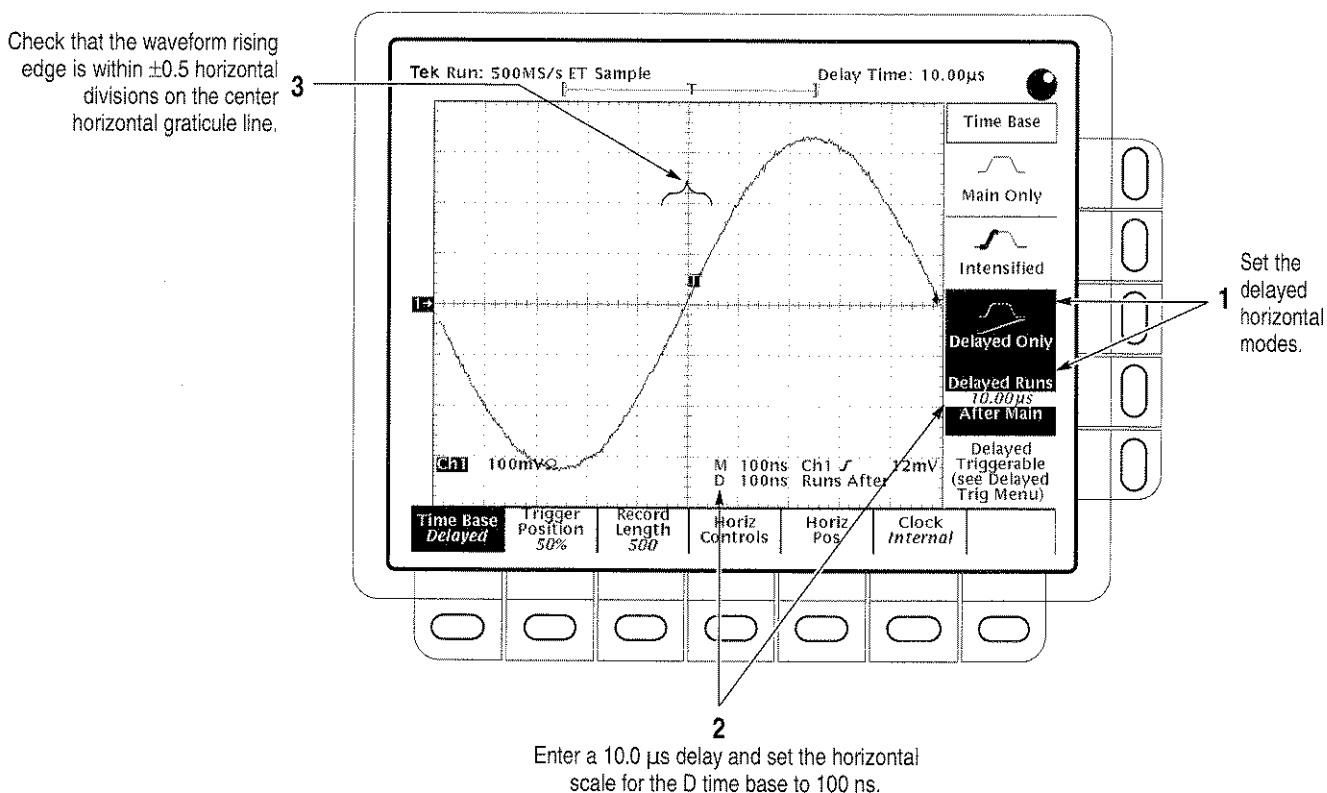

Figure 1–11: Measurement of Accuracy — Long-Term and Delay-Time

- Set the horizontal **SCALE** of the **D** (delayed) time base to 500 μ s. (The scale of the Main time base will also change.)
 - Use the **General Purpose** knob to set **Delayed Runs After Main** to 1.00 ms.
 - Use the horizontal **SCALE** knob to set the **D** (delayed) time base to 100 ns.
 - **CHECK** that the rising edge of the waveform crosses the center horizontal graticule line at a point within ± 1.5 divisions of the center graticule.
3. *Disconnect the hookup:* Disconnect the cable from the time standard at the input connector of **CH 1**.

Trigger System Checks

These procedures check those characteristics that relate to the Main and Delayed trigger systems and are listed as checked under *Warranted Characteristics* in Chapter 2, *Specifications*.

Check Accuracy, Trigger Level or Threshold, DC Coupled

Equipment Required	One DC calibration generator (Item 10)
	One BNC T connector (Item 8)
	Two precision coaxial cables (Item 5)
Prerequisites	The oscilloscope must meet the prerequisites listed on page 1–15

1. *Install the test hookup and preset the instrument controls:*

a. *Hook up the test-signal source:*

- Set the output of a DC calibration generator to 0 volts.
- Connect the output of a DC calibration generator through a dual-banana connector followed by a 50 Ω precision coaxial cable to one side of a BNC T connector.
- Connect the Sense output of the generator, through a second dual-banana connector followed by a 50 Ω precision coaxial cable, to the other side of the BNC T connector. Now connect the BNC T connector to **CH 1** (see Figure 1–12).

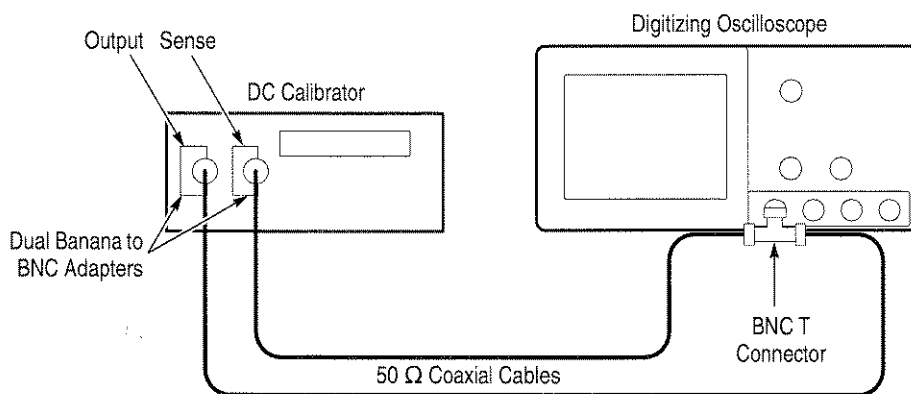

Figure 1–12: Initial Test Hookup

b. *Initialize the oscilloscope:*

- Press save/recall **Setup**.

- Press the main-menu button **Recall Factory Setup**.
 - Press the side-menu button **OK Confirm Factory Init**.
2. *Confirm Main trigger system is within limits for Trigger-level/Threshold accuracy:*
- a. *Display the test signal:*
 - Set the vertical **SCALE** to 50 mV.
 - Set the standard output of a DC calibration generator to +0.3 V.
 - b. *Measure the test signal:*
 - Press **SET LEVEL TO 50%**.
 - Press **TRIGGER MENU**.
 - Read the measurement results from the readout below the label **Level** in the menu rather than from the trigger readout in the graticule area.
 - c. *Check against limits:*
 - Subtract the trigger level readout from the DC calibration generator setting. The result is the trigger level accuracy.
 - CHECK that the trigger level is accurate to within ± 18 mV.
 - Press **TRIGGER MENU**. Press the main-menu button **Slope**; then press the side-menu button for negative slope. (See icon at left.) Repeat substep b.
 - Subtract the trigger level readout from the DC calibration generator setting. The result is the trigger level accuracy.
 - CHECK that the trigger level is accurate to within ± 18 mV.
3. *Confirm Delayed trigger system is within limits for Trigger-level/Threshold accuracy:*
- a. *Select the Delayed time base:*
 - Press **HORIZONTAL MENU**.
 - Press the main-menu button **Time Base**.
 - Press the side-menu buttons **Delayed Only** and **Delayed Triggerable**.
 - Set **D** (delayed) horizontal **SCALE** to 500 μ s.

- b. *Select the Delayed trigger system:*
 - Press **SHIFT**; then press the front-panel button **DELAYED TRIG**.
 - Press the main-menu button **Level**.
 - c. *Measure the test signal:* Press the side-menu button **SET TO 50%**. Read the measurement results in the side menu below the label **Level**.
 - d. *Check against limits:* Do the following subparts in the order listed.
 - Subtract the trigger level readout from the DC calibration generator setting. The result is the trigger level accuracy.
 - CHECK that the trigger level is accurate to within ± 18 mV.
 - Press **TRIGGER MENU**. Press the main-menu button **Slope**; then press the side-menu button for negative slope. (See icon at left.)
 - Subtract the trigger level readout from the DC calibration generator setting. The result is the trigger level accuracy.
 - CHECK that the trigger level is accurate to within ± 18 mV.
4. *Disconnect the hookup:*
- a. *First set the output of the DC calibration generator to 0 volts.*
 - b. Then disconnect the cable from the generator output at the input connector of **CH 1**.



**Sensitivity, Edge Trigger,
DC Coupled**

Equipment Required	One sine wave generator (Item 11) One precision 50 Ω coaxial cable (Item 5) One 10X attenuator (Item 1) One 5X attenuator (Item 2)
Prerequisites	See page 1-15

1. *Install the test hookup and preset the oscilloscope controls:*
- a. *Initialize the oscilloscope:*
 - Press save/recall **SETUP**.
 - Press the main-menu button **Recall Factory Setup**.
 - Press the side-menu button **OK Confirm Factory Init**.

- b. *Modify the initialized front-panel control settings:*
- Set the horizontal **SCALE** for the **M** (main) time base to 20 ns.
 - Press **HORIZONTAL MENU**; then press the main-menu button **Time Base**.
 - Press the side-menu button **Delayed Only**; then press the side-menu button **Delayed Triggerable**.
 - Set the horizontal **SCALE** for the **D** (delayed) time base to 20 ns; then press the side-menu button **Main Only**.
 - Press **TRIGGER MENU**; then press the main-menu button **Mode & Holdoff**. Now press the side-menu button **Normal**.
 - Press **VERTICAL MENU**; then press the main-menu button **Coupling**. Now press the side-menu button Ω to select the 50 Ω setting.
 - Press **SHIFT**; then press **ACQUIRE MENU**. Now press the main-menu button **Mode**; then press the side-menu button **Average 16**.
- c. *Hook up the test-signal source:* Connect, through a 50 Ω precision coaxial cable, the signal output of a sine wave generator to **CH 1** (see Figure 1–13).

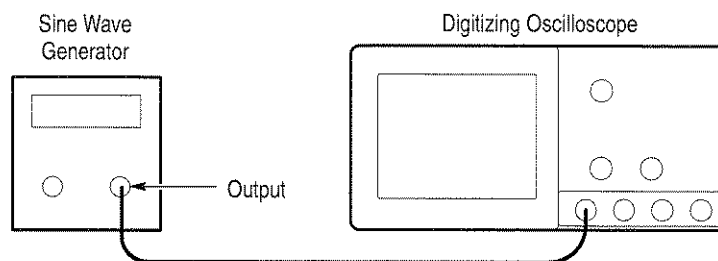

Figure 1–13: Initial Test Hookup

2. *Confirm Main and Delayed trigger systems are within sensitivity limits (50 MHz):*
- a. *Display the test signal:*
- Set the generator frequency to 50 MHz.
 - Press **MEASURE**.



- Press the main-menu button **High-Low Setup**; then press the side-menu button **Min-Max**.
 - Press the main-menu button **Select Measurement for Ch1**.
 - Press the side-menu button **–more–** until **Amplitude** appears in the side menu (its icon is shown at the left). Press the side-menu button **Amplitude**.
 - Adjust the trigger **MAIN LEVEL** knob to obtain stable triggered waveform.
 - Press **CLEAR MENU**.
 - Set the test signal amplitude for about three and a half divisions on screen. Now fine adjust the generator output until the **CH 1 Amplitude** readout indicates the amplitude is 350 mV. (Readout may fluctuate around 350 mV.)
 - Disconnect the 50 Ω precision coaxial cable at **CH 1** and reconnect it to **CH 1** through a 10X attenuator.
- b. *Check for Main trigger system for stable triggering at limits:*
- Read the following definition: A stable trigger is one that is consistent; that is, one that results in a uniform, regular display triggered on the selected slope (positive or negative). This display should *not* have its trigger point switching between opposite slopes, nor should it “roll” across the screen. At horizontal scale settings of 2 ms/division and faster, **TRIG’D** remains constantly lit. It flashes for slower settings.
 - Press **TRIGGER MENU**; then press the main-menu button **Slope**.
 - Press **SET LEVEL TO 50%**. CHECK that a stable trigger is obtained for the test waveform on both the positive and negative slopes. (Use the side menu to switch between trigger slopes; use the trigger **MAIN LEVEL** knob to stabilize the trigger if required.)
 - Leave the Main trigger system triggered on the positive slope of the waveform before continuing to the next step.

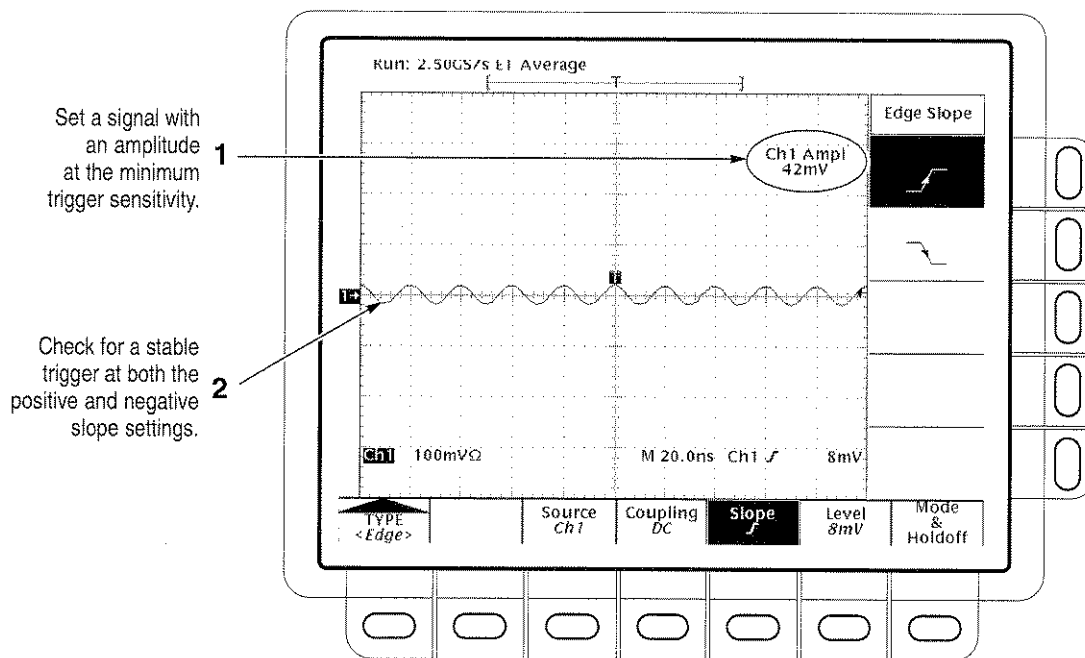

Figure 1-14: Measurement of Trigger Sensitivity

- c. *Check delayed trigger system for stable triggering at limits:* Do the following subparts in the order listed.
 - Press **HORIZONTAL MENU**; then press the main-menu button **Time Base**. Now press the side-menu button **Delayed Only**.
 - Press **SHIFT**; then press **DELAYED TRIG**. Press the main-menu button **Level**.
 - Press the side-menu button **SET TO 50%**. CHECK that a stable trigger is obtained for the test waveform for both the positive and negative slopes of the waveform. (Use the General Purpose knob to stabilize the trigger if required.) Press the main-menu button **Slope**; then use the side menu to switch between trigger slopes.
 - Leave the delayed trigger system triggered on the positive slope of the waveform before continuing to the next step. Also, return to the main time base: Press **HORIZONTAL MENU**; then press the main-menu button **Time Base**. Now press the side-menu button **Main Only**.
3. *Confirm that the Main and Delayed trigger systems are within sensitivity limits (at upper frequency limits):*
 - a. *Hook up the test-signal source:* Disconnect the hookup installed in step 1. Connect the signal output of a sine wave generator to **CH 1**.

- b. *Set the Main and Delayed Horizontal Scales:*
 - Set the horizontal **SCALE** to 5 ns for the **M** (Main) time base.
 - Press the side-menu button **Delayed Only**.
 - Set the horizontal **SCALE** to 2 ns for the **D** (Delayed) time base. Press the side-menu button **Main Only**.
 - c. *Display the test signal:*
 - Set the generator frequency to 350 MHz (TDS 410A and TDS 420A) or 500 MHz (TDS 460A).
 - Set the test signal amplitude for about five divisions on screen. Now fine adjust the generator output until the **CH 1 Amplitude** readout indicates the amplitude is 500 mV. (Readout may fluctuate around 500 mV.)
 - Disconnect the sine wave at **CH 1** and reconnect it to **CH 1** through a 5X attenuator.
 - d. Repeat step 2, substeps b and c only.
4. *Confirm that the Main and Delayed trigger systems couple trigger signals from all channels:* Doing the procedure *Check Analog Bandwidth*, which begins on page 1–25, checks coupling. If you have not done that procedure, do so after finishing this procedure. See the following note.

NOTE. Steps 1 through 3 confirmed trigger sensitivity for the Main and Delayed triggering systems using the CH 1 input. Doing the procedure *Check Analog Bandwidth* ensures that trigger signals are coupled from all channels.

- 5. *Disconnect the hookup:* Disconnect the cable from the generator output at the input connector of the channel last tested.

**Maximum Input
Frequency, Auxiliary
Trigger**

Equipment Required	One sine wave generator (Item 11)
	Two precision 50 Ω coaxial cables (Item 5)
	One BNC T connector (Item 8)
Prerequisites	See page 1–15

- 1. *Install the test hookup and preset the oscilloscope controls:*
 - a. *Initialize the oscilloscope:*
 - Press save/recall **SETUP**.

- Press the main-menu button **Recall Factory Setup**.
 - Press the side-menu button **OK Confirm Factory Init**.
- b. *Modify the initialized front-panel control settings:*
- Set the vertical **SCALE** to 1 volt; set the horizontal **SCALE** to 20 ns.
 - Press **VERTICAL MENU**.
 - Press the main-menu button **Coupling**. Press the side-menu button Ω to toggle it to the 50 Ω setting.
 - Press **TRIGGER MENU**. Press the main-button **SOURCE**; then press the side-menu button **–more–** until **Auxiliary** appears in the side menu. Press the side-menu button **Auxiliary**.
 - Press the **Coupling** main-menu button; then press the **AC** side-menu button.
- c. *Hook up the test-signal source:*
- Connect a BNC T connector to the output of the sine wave generator (see Figure 1–15).
 - Connect one 50 Ω cable to one side of the BNC T connector; connect a second 50 Ω cable to the other side of the BNC T connector.
 - Connect one of the cables just installed to **CH 1**; connect the other cable just installed to the **AUX TRIGGER** input at the rear panel.

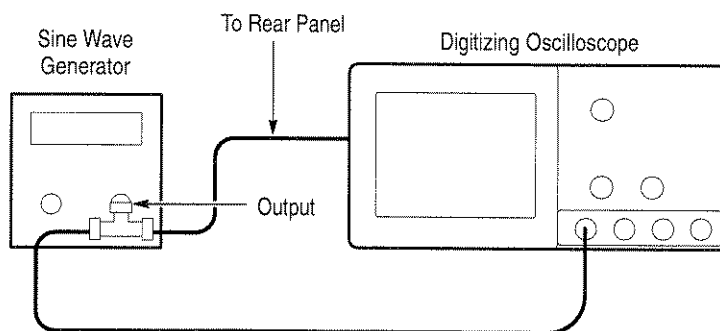

Figure 1–15: Initial Test Hookup

NOTE. Refer to the Sine Wave Generator Leveling Procedure on page 1-55 if your sine wave generator does not have automatic output amplitude leveling.

2. Confirm the Trigger input:
 - a. Display the test signal:
 - Set the generator for a 10 MHz, four division signal.
 - b. Check the Main trigger system for stable triggering at limits:
 - Read the following definition: A stable trigger is one that is consistent; that is, one that results in a uniform, regular display triggered on the selected slope (positive or negative). This display should *not* have its trigger point switching between opposite slopes, nor should it “roll” across the screen (see Figure 1-16).

1 Set a signal with a four division amplitude and a 10 MHz frequency.

2 Check for a stable trigger at both the positive and negative slope settings.

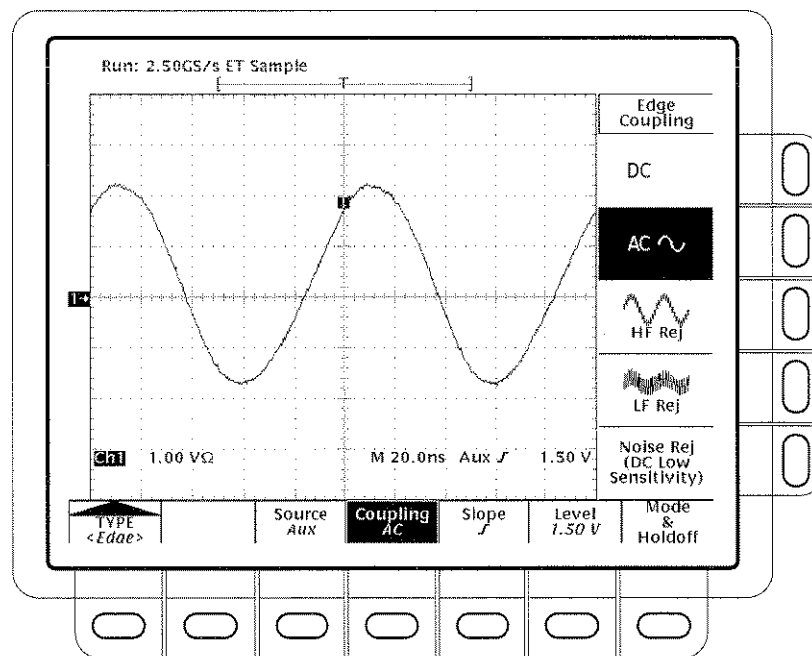

Figure 1-16: Confirming Auxiliary Triggering at Maximum Triggering Frequency

3. Disconnect the hookup: Disconnect the cable from the generator output at the input connector of the channel last tested.

**Check Video Trigger Sensitivity
(Option 05 Equipped Mode Is Only)**

Equipment Required	One NTSC format video generator (Item 18) One 75 Ω coaxial cable (Item 6) One 75 Ω terminator (Item 4)
Prerequisites	See page 1-15

1. *Install the test hookup and preset the oscilloscope controls:*
 - a. *Initialize the oscilloscope:*
 - Press save/recall **SETUP**.
 - Press the main menu button **Recall Factory Setup**.
 - Press the side menu button **OK Confirm Factory Init**.
 - b. *Modify the default setup:*
 - Set the vertical **SCALE** to 500 mV.
 - Set the horizontal **SCALE** to 20 μs.
 - Press **HORIZONTAL MENU**.
 - Press the main menu button **Record Length**.
 - Press the side menu button **5000 points in 100 divs**.
 - c. *Hook up the test-signal source:* Connect, through a 75 Ω precision coaxial cable, followed by a 75 Ω terminator, the output of a NTSC format video generator to CH 1 (see Figure 1-17).

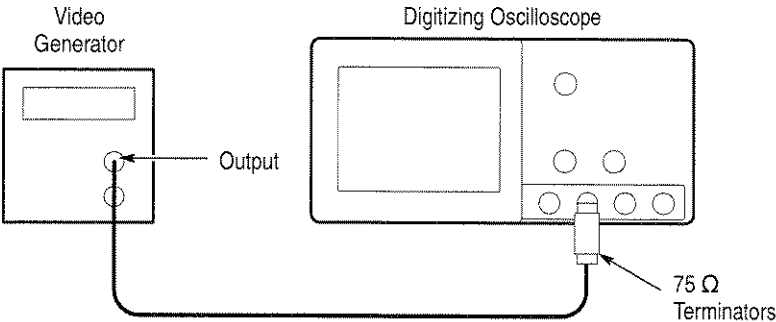

Figure 1-17: Initial Test Hookup

2. *Confirm the video trigger system is within limits:*

a. *Display the test signal:*

- Set video generator to NTSC format.
- Set the output of the generator for a five step ramp with color burst.
- Press **SET TO 50%**. Use the trigger **MAIN LEVEL** knob to stabilize the display as required.
- Press **TRIGGER MENU**.
- Press the main menu button **Mode & Holdoff**. Then press the side menu button **Normal**.

b. *Fine adjust the sync pulse amplitude:* The amplitude of the TV waveform should now be about 2 divisions pk-pk. Do the following subparts to fine adjust the vertical gain until the sync pulses measure exactly 0.6 divisions peak-to-peak using the graticule:

- Press **VERTICAL MENU**.
- Press the main menu button **Fine Scale**.
- Use the General Purpose knob, adjust the fine gain until the sync pulse amplitude is 0.6 divisions measured using the graticule (see Figure 1-18).

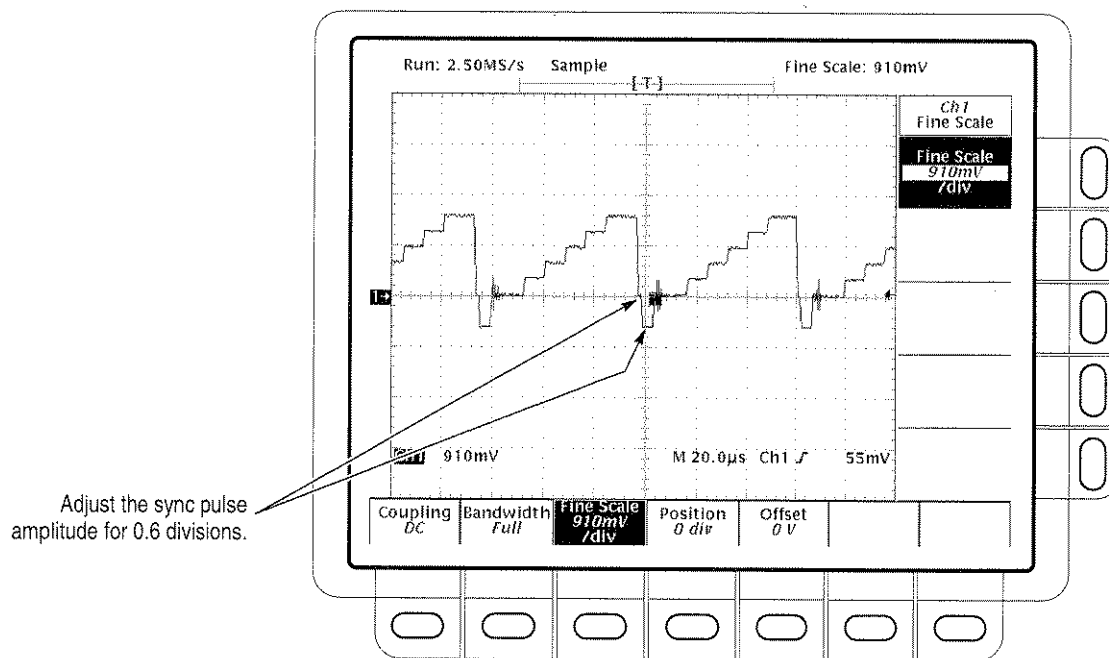

Figure 1-18: Adjusting Sync Pulse Amplitude

c. *Check for stable triggering against limits:*

- Read the following definition: A stable trigger is one that is consistent; that is, one that results in a uniform, regular display triggered on the selected slope (positive or negative). This display should *not* have its trigger point switching between opposite slopes, nor should it “roll” across the screen. At horizontal scale settings appropriate for viewing video waveforms, the **TRIG’D** light remains constantly lit.
- Press **TRIGGER MENU**. Press the main menu button **Type** twice — first to pop up its menu and then to toggle it to **Video**.
- Press the main menu button **Class** to pop up its menu. Press it again as needed to toggle it to **NTSC**.
- Press the main menu button **Scan** to pop up its menu.
- Press the side menu button **Odd**. Center the display at mid screen.
- CHECK that a stable trigger is obtained with the last two lines of TV field 2 and the beginning of TV field 1 displayed. (If the last line is a full TV line duration ($63.5 \mu\text{s}$), then it is the end of field 2 — see waveform R1 in Figure 1-19.)
- Press the side menu button **Even**. Center the display at mid screen.

- CHECK that a stable trigger is obtained with the last of TV field 1 and the beginning of TV field 2 displayed. (If the last line is $\frac{1}{2}$ of a TV line duration ($31.75 \mu\text{s}$), then it is the end of field 1 — see waveform R2 in Figure 1–19.)
- Press the side menu button **All**.
- Press the main menu button **Mode and Holdoff**. Then press the side menu button **Holdoff**.
- Use the **General Purpose** knob to set the holdoff to **1**.

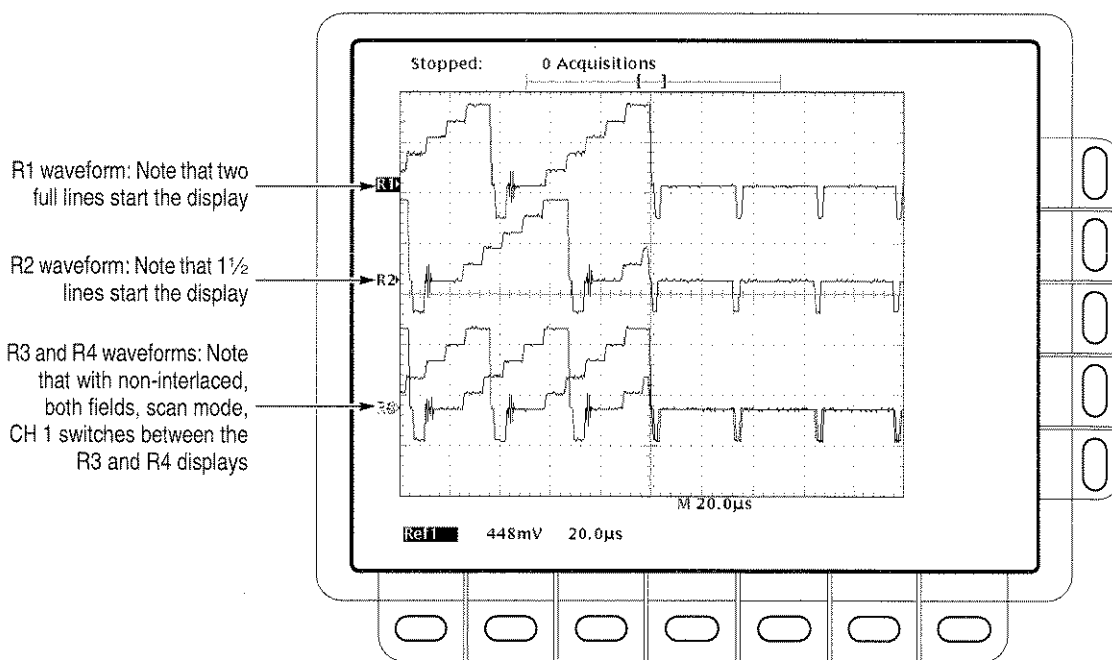

Figure 1–19: Measurement of Video Sensitivity

- Rotate the horizontal **POSITION** control clockwise to move the ends of both fields to the center of the display.
 - CHECK that a stable trigger is obtained while alternating between field 1 and field 2. (If the last line is alternating between a full TV line and $\frac{1}{2}$ a line in duration ($63.5 \mu\text{s}$ and $31.75 \mu\text{s}$ respectively), then triggering is occurring on both fields — see waveforms R3 and R4 in Figure 1–19.)
- d. Check delay by lines:
- Press the main-menu button **Scan**.

- Press the side-menu button **Odd**.
 - Rotate the horizontal **POSITION** control counter clockwise and align the trigger “**T**” to center screen
 - Press the main-menu button **TV Delay Mode**.
 - Press the side-menu button **Line**.
 - Use the General Purpose knob to set the line count to **10**.
 - **CHECK** that the selected line is the first line that has the color burst signal.
- e. *Check sync trigger:*
- Using the Vertical **POSITION** knob, move the video waveform from the top to the bottom of the display.
 - **CHECK** that the **TRIG'D** LED stays on and the waveform is stable.
 - Using the Vertical **POSITION** knob return the waveform to the center of the display.
3. *Disconnect the hookup:* Disconnect the cable from the generator output at the input connector of **CH 1**.

Check External Clock

Equipment Required	One Function generator (Item 14) One Sine Wave generator (Item 11) One 50Ω terminator (Item 3) One N to BNC adapter (Item 15) One BNC T connector (Item 8) Two precision coaxial cables (Item 5)
Prerequisites	The oscilloscope must meet the prerequisites listed on page 1-15

1. *Install the test hookup and preset the instrument controls:*
- a. *Initialize the oscilloscope:*
- Press save/recall **SETUP**.
 - Press the main-menu button **Recall Factory Setup**.
 - Press the side-menu button **OK Confirm Factory Init**.

b. *Hook up the test-signal source:*

- Set the Vertical **SCALE** to 1 Volt per division.
- Connect the output of a function generator through a 50 Ω precision coaxial cable and a 50 Ω terminator to the **CH 1** input.
- Set the output of the function generator for a 5 MHz, 0 to 4 Volt (4 division) square wave at the oscilloscope input.
- Move the setup from the **CH 1** input to the **AUX TRIGGER/EXT CLOCK** input on the rear panel of the oscilloscope (see Figure 1–20).
- Connect the output of the sine wave generator through an N-to-BNC adaptor, and a 50 Ω precision coaxial cable to the **CH 1** input of the oscilloscope.
- Set the Vertical **SCALE** to 100 mV.
- Press **VERTICAL MENU**, then press the **Coupling** main-menu button.
- Set the coupling to **50 Ω**
- Set the output of the sine wave generator for a 100 KHz 4 division sine wave.

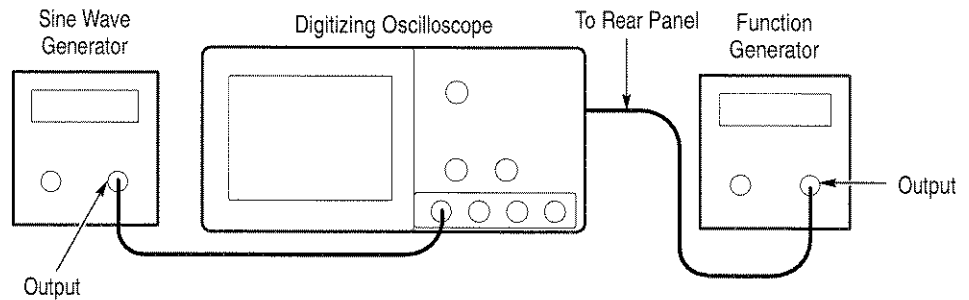

Figure 1–20: Initial Test Hookup

c. *Modify the default settings:*

- Press **HORIZONTAL MENU**, then press the **Clock** main-menu button.
- Press the side-menu button **External**.
- Set the **Max Ext Clock Rate** to 10.0 MHz.
- Press **CLEAR MENU**.

- d. *Check external clock:*
 - CHECK that the displayed sine wave has a one division period.
 - Slowly adjust the frequency of the function generator to 10 MHz while watching the display.
 - CHECK that the period of the displayed sine wave changes to two divisions.
 - Press **CLEAR MENU**.
2. *Disconnect the hookup:* Disconnect the cables from the generators at the **CH 1** and **AUX TRIGGER/EXT CLOCK** input connectors.

Output Signal Check

The procedure that follows checks the characteristics of the probe compensation signal that are listed as checked under *Warranted Characteristics* in Chapter 2, *Specifications*.

Check Probe Adjust Output

Equipment Required	One standard-accessory 10X probe (Item 17)
Prerequisites	See page 1–15. Also, this digitizing oscilloscope must have passed <i>Check Accuracy — Long-Term Sample Rate, Delay time, and Delta Time Measurement</i> on page 1–34, and <i>Check DC Voltage Measurement Accuracy (Averaged)</i> on page 1–22.

1. *Install the test hookup and preset the oscilloscope controls:*
 - a. *Hook up test-signal:* Install the standard-accessory probe on **CH 1**. Connect the probe tip to **PROBE ADJ** on the front panel; leave the probe ground unconnected (see Figure 1–21).

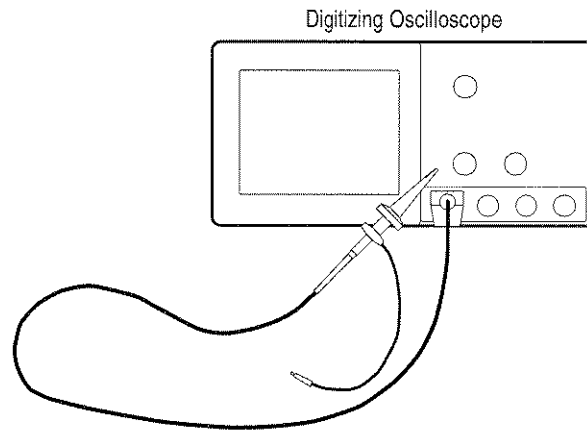

Figure 1-21: Initial Test Hookup

b. *Initialize the oscilloscope:*

- Press save/recall **SETUP**.
- Press the main-menu button **Recall Factory Setup**.
- Press the side-menu button **OK Confirm Factory Init**.

c. *Modify the initialized front-panel control settings:*

- Press **AUTOSET**. Set the horizontal **SCALE** to 200 μ s.
- Press **SHIFT**; then press **ACQUIRE MENU**.
- Press the main-menu button **Mode**; then press the side-menu button **Hi Res**.

2. *Confirm that the Probe Compensator signal is within limits for amplitude and frequency:*

a. *Measure the amplitude and frequency of the probe compensation signal:*

- Press **MEASURE**; then press the main-menu button **Select Measurement for Ch1**.
- Now repeatedly press the side-menu button **–more–** until **Amplitude** appears in the side menu (its icon is shown at the left). Press the side-menu button **Amplitude**.
- Repeatedly press the side-menu button **–more–** until **Frequency** appears in the side menu (its icon is shown at the left). Press the side-menu button **Frequency**.



- Press **CLEAR MENU** to remove the menus from the display. See Figure 1–22.

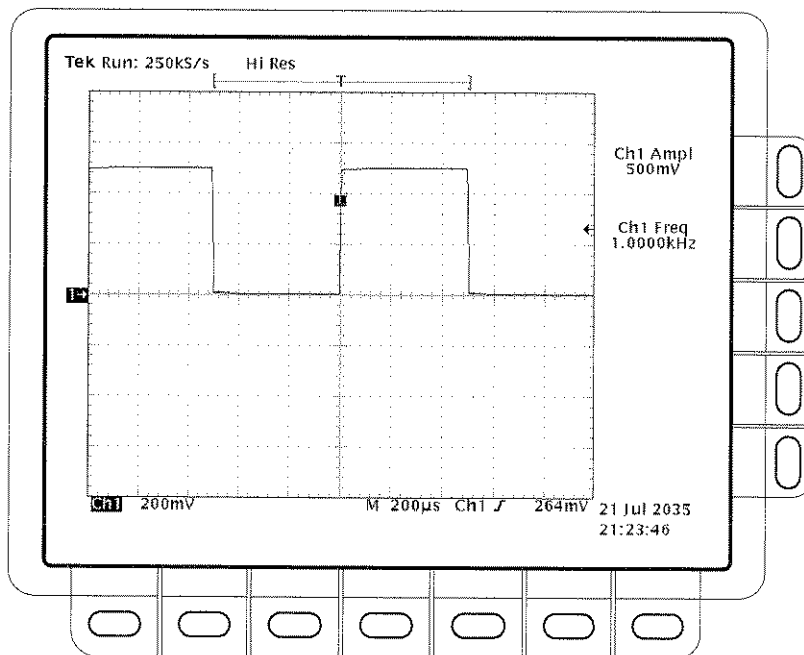

Figure 1–22: Measurement of Probe Compensator Limits

- Check against limits:* CHECK that the **CH 1 Freq** readout is within 950 Hz to 1.050 kHz, inclusive, and that the readout for **Ch1 Ampl** is within 475 mV to 525 mV, inclusive.
- Disconnect the test hookup:* Remove the test probe as desired.

Sine Wave Generator Leveling Procedure

Some procedures in this manual require a sine wave generator to produce the necessary test signals. If you do not have a leveled sine wave generator, use one of the following procedures to level the output amplitude of your sine wave generator.

Procedure for Best Accuracy

Equipment Required	Sine Wave Generator (Item 11) Level Meter and Power Sensor (Item 12) Power Splitter (Item 13) Two Male N to Female BNC Adapters (Item 15) One precision coaxial cable (Item 5)
Prerequisites	See page 1–15

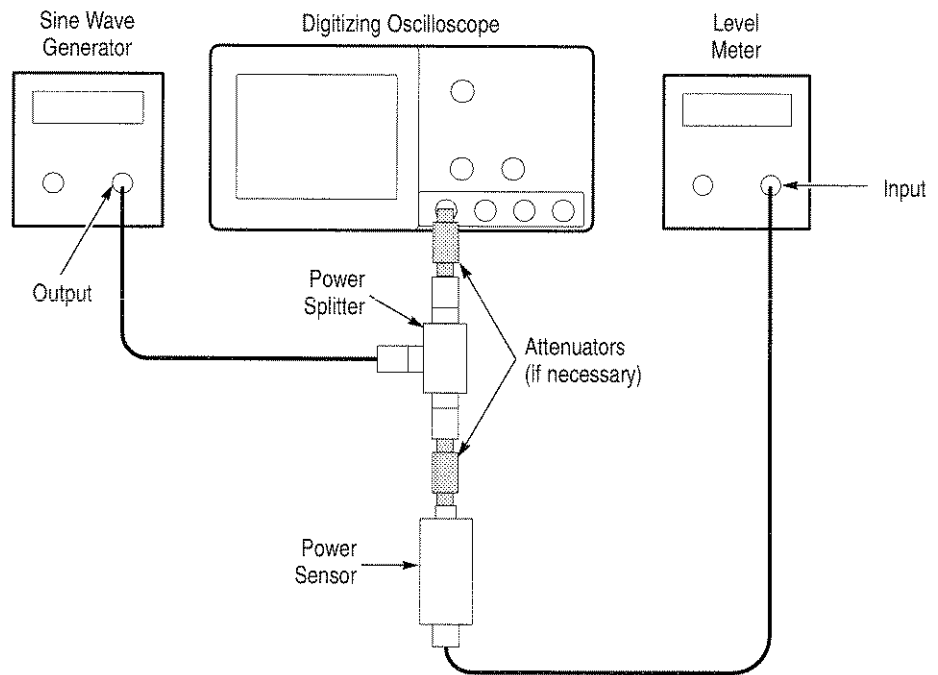

Figure 1–23: Sine Wave Generator Leveling Equipment Setup

1. *Install the test hookup:* Connect the equipment as shown in Figure 1–23.
2. *Set the Generator:*
 - Set the sine wave generator to a reference frequency of 10 MHz.
 - Adjust the sine wave generator amplitude to the required number of divisions as measured by the digitizing oscilloscope.
3. *Record the reference level:* Note the reading on the level meter.
4. *Set the generator to the new frequency and reference level:*
 - Change the sine wave generator to the desired new frequency.

- Input the correction factor for the new frequency into the level meter.
- Adjust the sine wave generator amplitude until the level meter again reads the value noted in step 3. The signal amplitude is now correctly set for the new frequency.

Alternate Procedure for Maximum Amplitude

Equipment Required	Sine Wave Generator (Item 11)
	Level Meter and Power Sensor (Item 12)
	Two Male N to Female BNC Adapters (Item 15)
	Two precision coaxial cables (Item 5)
Prerequisites	See page 1–15

1. *Install the test hookup:* Connect the equipment as shown in Figure 1–24 (start with the sine wave generator connected to the digitizing oscilloscope).

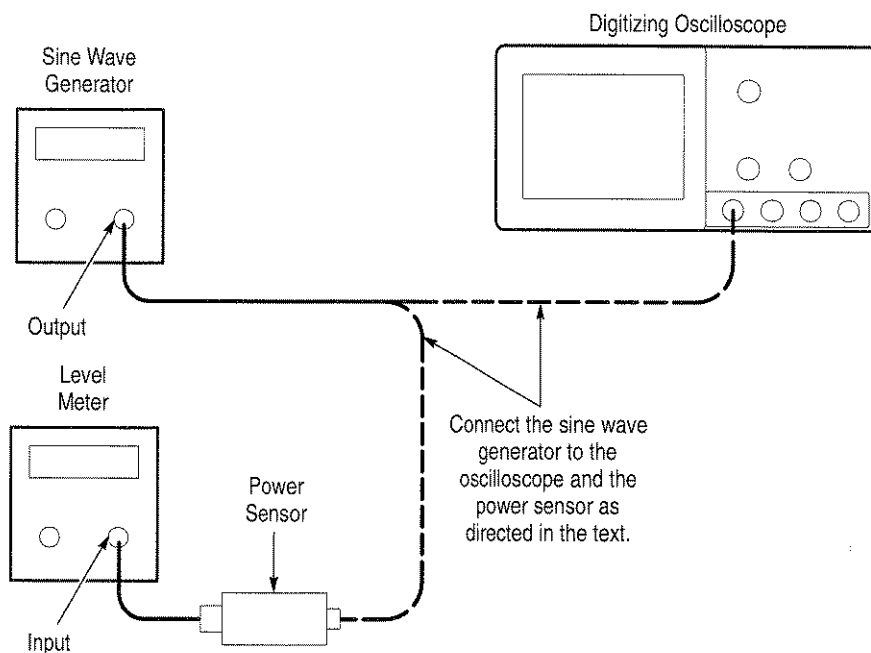

Figure 1–24: Equipment Setup for maximum Amplitude

2. *Set the Generator:*
 - Set the sine wave generator to a reference frequency of 10 MHz.
 - Adjust the sine wave generator amplitude to the required number of divisions as measured by the digitizing oscilloscope.

3. *Record the reference level:*

- Disconnect the sine wave generator from the digitizing oscilloscope.
- Connect the sinewave generator to the power sensor.
- Note the level meter reading.

4. *Set the generator to the new frequency and reference level:*

- Change the sine wave generator to the desired new frequency.
- Input the correction factor for the new frequency into the level meter.
- Adjust the sine wave generator amplitude until the level meter again reads the value noted in step 3. The signal amplitude is now correctly set for the new frequency.
- Disconnect the sine wave generator from the power sensor.
- Connect the sinewave generator to the digitizing oscilloscope.

Specification

This Chapter begins with a general description of the traits of the TDS 400A Digitizing Oscilloscopes. Three sections follow, one for each of three classes of traits: *nominal traits*, *warranted characteristics*, and *typical characteristics*.

General

The TDS 400A Digitizing Oscilloscopes are portable, four-channel instruments suitable for use in a variety of test and measurement applications and systems. Table 2-1 lists key features.

Table 2-1: Key Features of the TDS 400A Oscilloscopes

Feature	Description
Digitizing rate, maximum	100 MS/s on each channel simultaneously
Analog bandwidth	TDS 460A: 400 MHz TDS 420A: 200 MHz TDS 410A: 200 MHz
Channels	TDS 460A: Four, each with 8-bit resolution TDS 420A: Four, each with 8-bit resolution TDS 410A: Two, each with 8-bit resolution
Record lengths, maximum	30,000 samples (120,000 with option 1M)
Acquisition modes	Sample, envelope, average, high-resolution, and peak-detect
Trigger modes	Edge With Option 05, video trigger modes include: NTSC, SECAM, PAL, and Custom
Display Modes	Infinite and variable persistence, roll, fit to screen, and dual waveform zoom
Storage	NVRAM storage for saving waveforms, hardcopies, and setups With Option 1F, 1.44 Mbyte, 3.5 inch, DOS 3.3-or-later floppy disk
I/O	Full GPIB programmability Hardcopy output using GPIB and, with Option 13, RS-232 or Centronics ports
Math	Including: invert, add, subtract, multiply, and with Option 2F, integral, differential, and FFT
User interface	A graphical user interface, on-line help, and a logical front-panel layout

Nominal Traits

Nominal traits are described using simple statements of fact such as “Four, all identical” for the trait “Input Channels, Number of,” rather than in terms of limits that are performance requirements.

Table 2-2: Nominal Traits — Signal Acquisition System

Name	Description	
Bandwidth Selections	20 MHz, 100 MHz, and FULL (TDS 410A and TDS 420A: 200 MHz, TDS 460A: 400 MHz)	
Digitizers, Number of	TDS 410A: Two, both identical TDS 420A and TDS 460A: Four, all identical	
Digitized Bits, Number of	8 bits ¹	
Digitized Resolution, Hi Res Mode	Clock, Internal: $\text{Resolution}_{\text{HiRes}} \cong 8 \leq \left[8 + 0.5 \text{Log}_2 \left(\frac{\text{time/div}}{500 \cdot 10^{-9}} \right) \right] \leq 15 \text{ bits}$ Clock, External: $\text{Resolution}_{\text{HiRes}} \cong 8 \leq \left[8 + 0.5 \text{Log}_2 \left(\frac{100,000,000}{\text{ClockExternalMenu}} \right) \right] \leq 11.8 \text{ bits}$	
Bandwidth, Hi Res Mode	Clock, Internal: For $1\mu\text{s}/\text{div}$ and slower, $\text{BW}_{\text{HiRes}} \cong 0.44 \cdot \left(\frac{50}{\text{time/div}} \right) \text{ Hz}$ Clock, External: $\text{BW}_{\text{HiRes}} \cong 44 \cdot \left(\frac{\text{ClockExternalMenu}}{100} \right) \text{ Hz}$	
Input Channels, Number of	TDS 410A: Two, both identical, called CH 1 and CH 2 TDS 420A and TDS 460A: Four, all identical, called CH 1 through CH 4	
Input Coupling	DC, AC, or GND	
Input Resistance Selections	1 MΩ or 50Ω	
Ranges, Offset, All Channels	Volts/Div Setting	Offset Range
	1 mV/div to 99.5 mV/div	±1 V
	100 mV/div to 995 mV/div	±10 V
	1 V/div to 10 V/div	±100 V
Range, Position	±5 divisions	
Range, Sensitivity ²	1 mV/div to 10 V/div	

Table 2–2: Nominal Traits — Signal Acquisition System (Cont.)

Name	Description	
Rise Time ³ (TDS 410A and TDS420A)	Volts/Div Setting	Rise Time
	5 mV/div–10 V/div	1.75 ns
	2 mV/div–4.98 mV/div	2.33 ns
	1 mV/div–1.99 mV/div	3.68 ns
Rise Time ³ (TDS 460A)	Volts/Div Setting	Rise Time
	5 mV/div–10 V/div	875 ps
	2 mV/div–4.98 mV/div	1.4 ns
	1 mV/div–1.99 mV/div	3.5 ns

- 1 Displayed vertically with 25 digitization levels (DLs) per division and 10.24 divisions dynamic range with zoom off. A DL is the smallest voltage level change resolved by the 8-bit A-D Converter with the input scaled to the volts/division setting of the channel used. Expressed as a voltage, a DL is equal to 1/25 of a division times the volts/division setting.
- 2 The sensitivity ranges from 1 mV/div to 10 V/div in a 1–2–5 sequence of coarse settings. Between consecutive coarse settings, the sensitivity can be finely adjusted with a resolution of 1% of the more sensitive setting. For example, between 50 mV/div and 100 mV/div, the volts/division can be set with 0.5 mV resolution.
- 3 Rise time is defined by the following formula:
$$Rise\ Time\ (ns) = \frac{350}{BW\ (MHz)}$$

Table 2-3: Nominal Traits — Time Base System

Name	Description
Range, Sample-Rate ^{1,3}	2.5 Samples/s to 100 MSamples/s
Range, Equivalent Time or Interpolated Waveform Rate ^{2,3}	200 MSamples/s to 50 GSamples/s
Range, Seconds/Division	1 ns/div to 20 s/div
Range, Time Base Delay Time	0 to 20 seconds
Reference Frequency, Time Base	100 MHz
Record Length Selection	500, 1,000, 2,500, 5,000, 15,000, and 30,000 points. Record lengths of 60,000 and 120,000 points are available with Option 1M ⁴
Sampling Edge, External Clock	Negative edge, with TTL threshold and tolerances
Hi Res Averaging Period, External Clock	Hi Res averaging done over period $1/(\text{maximum external clock rate}^5)$, but within <100 ns to 2 μ s. External clock edge before this period ends, produces an invalid sample

- 1 The range of real-time rates, expressed in samples/second, at which a digitizer samples signals at its inputs and stores the samples in memory to produce a record of time-sequential samples.
- 2 The range of waveform rates for equivalent time or interpolated waveform records.
- 3 The Waveform Rate (WR) is the equivalent sample rate of a waveform record. For a waveform record acquired by real-time sampling of a single acquisition, the waveform rate is the same as the real-time sample rate; for a waveform created by interpolation of real-time samples from a single acquisition or by equivalent-time sampling of multiple acquisitions, the waveform rate is faster than the real time sample rate. For all three cases, the waveform rate is $1/(\text{Waveform Interval})$ for the waveform record, where the waveform interval (WI) is the time between the samples in the waveform record.
- 4 In Hi Res, the maximum Option 1M record length is 60,000 points.
- 5 You set the maximum external clock rate using the Horizontal Clock menu. The Hi Res samples are averaged over a 10 to 40 ns shorter period than shown by the readout.

Table 2-4: Nominal Traits — Triggering System

Name	Description	
Range, Events Delay	1 to 9,999,999	
Ranges, Trigger Level or Threshold	Source	Range
	Any Channel	± 12 divisions from center of screen
	Line	± 400 Volts

Table 2-5: Nominal Traits — Display System

Name	Description
Video Display Resolution	640 pixels horizontally by 480 pixels vertically in a display area of 5.04 inches horizontally by 3.78 inches vertically
Waveform Display Graticule	A single graticule 401 × 501 pixels (8 × 10 divisions, with divisions that are 1 cm by 1 cm)
Waveform Display Grey Scale	16 levels in variable-persistence display style

Table 2-6: Nominal Traits — Data Storage

Name	Description
Capacity, Nonvolatile Waveform Memory	Total capacity is 120,000 points (one to four waveforms acquired with any combination of record lengths that add up to 120,000 points). For available record lengths, see <i>Record Length Selection</i> on page 2-5 of this chapter
Capacity, Nonvolatile Setup Memory	Ten setups
Batteries ¹ Required	Two lithium poly-carbon monofluoride. Both are type BR2/3A, UL listed. Both are rated at 3.0 volt, 1.2 amp-hour

1 Batteries are not accessible from the outside of the instrument; therefore, a service technician must replace them.

Table 2-7: Nominal Traits — GPIB Interface, Video Output, and Power Fuse

Name	Description
Interface, GPIB	GPIB interface complies with IEEE Std 488.1-1987 and IEEE Std 488.2-1987
Interface, RS-232 (Option 13 only)	RS-232 interface complies with EIA/TIA 574
Interface, Centronics (Option 13 only)	Centronics interface complies with Centronics interface standard C332-44 Feb 1977, REV A
Power Supply, Printer (Option 13 only)	Supply Voltage: +6.5 VDC Maximum Current: 2 Amps, DC continuous 4 Amps DC maximum for durations < 10 msec
Output, Video	Provides a video signal ¹ , non-interlaced, with levels that comply with ANSI RS343A. Output is through a rear-panel DB-15 connector
Fuse Rating	Either of two fuses ² may be used: a 0.25" × 1.25" (UL 198.6, 3AG): 5 A FAST, 250 V, or a 5 mm × 20 mm, (IEC 127): 4 A (T), 250 V

1 VGA compatible at 30.6 kHz sync rate.

2 Each fuse type requires its own fuse cap.

Table 2-8: Nominal Traits — Mechanical

Name	Description
Cooling Method	Forced-air circulation with no air filter
Construction Material	Chassis parts constructed of aluminum alloy; front panel constructed of plastic laminate; circuit boards constructed of glass-laminate. Plastic parts are polycarbonate
Finish Type	Tektronix Blue textured vinyl finish on aluminum cabinet
Weight	<p>Standard digitizing oscilloscope</p> <ul style="list-style-type: none"> 8.6 kg (19.0 lbs), oscilloscope only 10.2 kg (22.5 lbs), with front cover, accessories, and accessories pouch installed 14.5 kg (32.0 lbs), when packaged for domestic shipment <p>Rackmount digitizing oscilloscope</p> <ul style="list-style-type: none"> 8.2 kg (18.0 lbs) plus the weight of rackmount parts, for the rackmounted digitizing oscilloscope (Option 1R) 16.3 kg (36.0 lbs), when the rackmounted digitizing oscilloscope is packaged for domestic shipment <p>Rackmount conversion kit</p> <ul style="list-style-type: none"> 4.5 kg (10.0 lbs), parts only; 7.9 kg (17.5 lbs), parts plus package for domestic shipping <p>Option 1F</p> <ul style="list-style-type: none"> 225 grams (0.5 lbs) Floppy Disk Drive only <p>Option 3P</p> <ul style="list-style-type: none"> 11.3 kg (25 lbs), for the instrument and Printer Pack; includes a pouch, a printer with a full roll of paper, all cables, and three additional rolls of paper 4.5 kg (10 lbs), for Printer Pack when packaged for domestic shipping; includes a pouch, a printer as received from the vendor, a Tektronix manual, cables, and five rolls of paper

Table 2-8: Nominal Traits — Mechanical (Cont.)

Name	Description
Overall Dimensions	<p>Standard digitizing oscilloscope</p> <p>Height 191 mm (7.5 in), when feet and accessories pouch are installed. 165 mm (6.5 in), without the accessories pouch installed</p> <p>Width 381 mm (15 in), with handle</p> <p>Depth 471 mm (18.55 in), oscilloscope only; 490 mm (19.28 in), with optional front cover installed; 569 mm (22.4 in), with handle fully extended</p> <p>Rackmount digitizing oscilloscope</p> <p>Height 178 mm (7.0 in)</p> <p>Width 483 mm (19.0 in)</p> <p>Depth 472 mm (18.6 in), without front-panel handles; 517 mm (20.35 in), with front-panel handles installed</p> <p>Option 3P</p> <p>Height 241 mm (9.5 in)</p> <p>Width 381 mm (15.0 in)</p> <p>Depth 569 mm (22.4 in)</p>

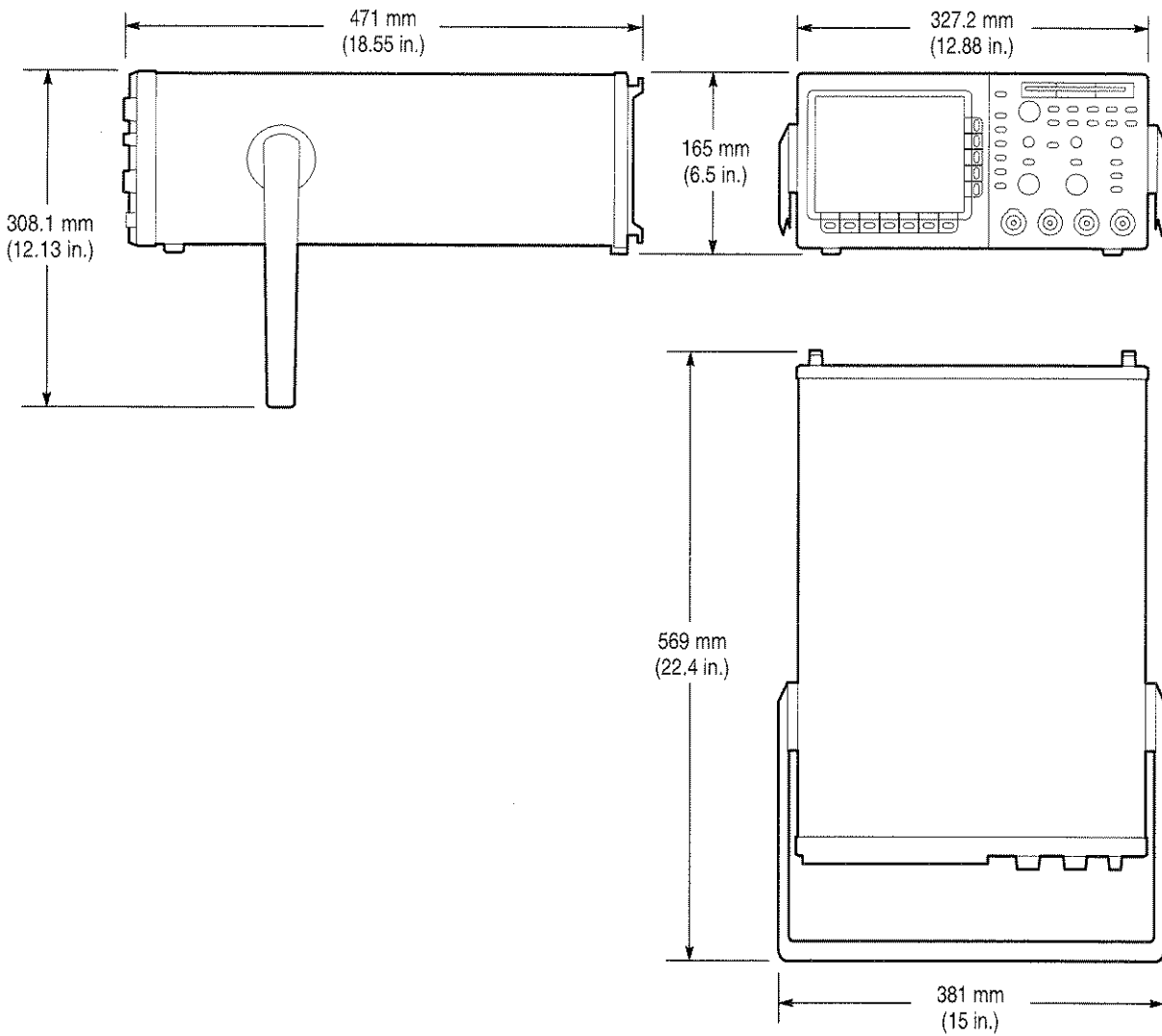

Figure 2-1: TDS 400A Dimensional Drawing

Warranted Characteristics

This section lists the various *warranted characteristics* that describe the TDS 400A Digitizing Oscilloscopes. Included are electrical and environmental characteristics.

Warranted characteristics are described in terms of quantifiable performance limits which are warranted. This section lists only warranted characteristics. A list of *typical characteristics* starts on page 2-17.

NOTE. In these tables, those warranted characteristics that are checked in the procedure Performance Tests, found in Section 1, appear in **boldface type** under the column **Name**.

Performance Conditions

The electrical characteristics found in these tables of warranted characteristics apply when the oscilloscope is adjusted at an ambient temperature between +20° C and +30° C, has had a warm-up period of at least 20 minutes, and is operating at an ambient temperature between 0° C and +50° C (unless otherwise noted).

Table 2-9: Warranted Characteristics — Signal Acquisition System

Name	Description	
Accuracy, DC Voltage Measurement, Averaged	Measurement Type	DC Accuracy
	Average of ≥16 waveforms	$\pm(1.5\% \times (\text{reading} - \text{Net Offset}^2) + \text{Offset Accuracy} + 0.06 \text{ div})$
	Delta volts between any two averages of ≥16 waveforms ³	$\pm(1.5\% \times \text{reading} + 0.1 \text{ div} + 0.3 \text{ mV})$
Accuracy, DC Gain⁴	±1.5%	
Accuracy, Offset	Volts/Div Setting	Offset Accuracy
	1 mV/div–9.95 mV/div	$\pm(0.4\% \times \text{Net Offset}^2 + (0.9 \text{ mV} + 0.1 \text{ div} \times \text{Vertical Scale}))$
	10 mV/div–99.5 mV/div	$\pm(0.4\% \times \text{Net Offset}^2 + (1.5 \text{ mV} + 0.1 \text{ div} \times \text{Vertical Scale}))$
	100 mV/div–995 mV/div	$\pm(0.4\% \times \text{Net Offset}^2 + (15 \text{ mV} + 0.1 \text{ div} \times \text{Vertical Scale}))$
	1 V/div–10 V/div	$\pm(0.4\% \times \text{Net Offset}^2 + (150 \text{ mV} + 0.1 \text{ div} \times \text{Vertical Scale}))$
Accuracy, Position⁵	$\pm(1.5\% \times (\text{Position} \times \text{Volts/div}) + \text{Offset Accuracy} + 0.04 \text{ div})$	

Table 2-9: Warranted Characteristics — Signal Acquisition System (Cont.)

Name	Description		
Analog Bandwidth, DC-50 Ω Coupled to BNC or to Recommended Active Probe and Bandwidth Selection is Full	Volts/Div	TDS 410A and TDS 420A Bandwidth⁶	TDS 460A Bandwidth⁶
	5 mV/div–10 V/div	DC–200 MHz	DC–400 MHz
	2 mV/div–4.98 mV/div	DC–150 MHz	DC–250 MHz
	1 mV/div–1.99 mV/div	DC–95 MHz	DC–100 MHz
Analog Bandwidth, DC-1 M Ω Coupled with Standard-Accessory Probe and Bandwidth Selection is Full	Volts/Div	TDS 410A and TDS 420A Bandwidth⁶	TDS 460A Bandwidth⁶
	5 mV/div–10 V/div	DC–200 MHz	DC–350 MHz ¹
	2 mV/div–4.98 mV/div	DC–150 MHz	DC–250 MHz
	1 mV/div–1.99 mV/div	DC–100 MHz	DC–100 MHz
Cross Talk (Channel Isolation)	Volts/Div	Isolation	
	> 500 mV/div	$\geq 40:1$ at 50 MHz for any two channels having equal volts/division settings	
	≤ 9.95 mV/div	$\geq 40:1$ at 50 MHz for any two channels having equal volts/division settings	
	10 mV/div–500 mV/div	$\geq 80:1$ at 100 MHz and $\geq 30:1$ at full bandwidth for any two channels having equal volts/division settings	
Delay Between Channels, Full Bandwidth, Equivalent Time	≤ 200 ps between CH 1 and CH 2 (all models) and between CH 3 and CH 4 (TDS 420A and TDS 460A) when both channels have equal volts/division and coupling settings		
	≤ 450 ps for any other combination of two channels with equal volts/division and coupling settings (TDS 420A and TDS 460A)		
Input Impedance, DC-1 M Ω Coupled	1 M Ω $\pm 0.5\%$ in parallel with 15 pF ± 2.0 pF. Matched between channels to within $\pm 1\%$ for resistance and ± 1.0 pF for capacitance		
Input Impedance, DC-50 Ω Coupled (TDS 410A and TDS 420A)	50 Ω $\pm 1\%$ with VSWR $\leq 1.2:1$ from DC–200 MHz		
Input Impedance, DC-50 Ω Coupled (TDS 460A)	50 Ω $\pm 1\%$ with VSWR $\leq 1.6:1$ from DC–400 MHz		
Input Voltage, Maximum, DC-1 M Ω , AC-1 M Ω , or GND Coupled	Volt/Div	Rating	
	0.1 V/div–10 V/div	± 400 V (DC + peak AC); derate at 20 dB/decade above 10 MHz until the minimum rating of ± 5 V (DC + peak AC) is reached	
	1 mV/div–99.9 mV/div	± 400 V (DC + peak AC); derate at 20 dB/decade above 10 kHz until the minimum rating of ± 5 V (DC + peak AC) is reached	
Input Voltage, Maximum, DC-50 Ω or AC-50 Ω Coupled	5 V _{RMS} , with peaks less than or equal to ± 30 V		

Table 2-9: Warranted Characteristics — Signal Acquisition System (Cont.)

Name	Description
Lower Frequency Limit, AC Coupled	≤ 10 Hz when AC-1 M Ω coupled; ≤ 200 kHz when AC-50 Ω coupled ⁷

- ¹ See *Analog Bandwidth* on page 2-17 for the typical analog bandwidth with the standard-accessory probe.
- ² Net Offset = Offset – (Position \times Volts/Div). Net Offset is the voltage level at the center of the A-D converter dynamic range. Offset Accuracy is the accuracy of this voltage level.
- ³ The samples must be acquired under the same setup and ambient conditions.
- ⁴ DC Gain Accuracy is confirmed in the Performance Verification Procedure by passing the checks for Offset Accuracy and DC Voltage Measurement Accuracy (Averaged).
- ⁵ Position Accuracy is confirmed in the Performance Verification Procedure by passing the checks for Offset Accuracy and DC Voltage Measurement Accuracy (Averaged).
- ⁶ The limits given are for the ambient temperature range of 0° C to +30° C. Reduce the upper bandwidth frequencies by 2.5 MHz for each °C above +30° C.
- ⁷ The AC Coupled Lower Frequency Limits are reduced by a factor of 10 when 10X, passive probes are used.

Table 2-10: Warranted Characteristics — Time Base System

Name	Description
Accuracy, Long Term Sample Rate and Delay Time	± 150 ppm over any ≥ 1 ms interval
Accuracy, Absolute Time and Delay Time Measurements ^{1,2}	For single-shot acquisitions using sample or high-resolution acquisition modes and a bandwidth limit setting of 100 MHz: $\pm(1 \text{ WI} + 150 \text{ ppm of } \text{Reading} + 450 \text{ ps})$ For single-shot acquisitions using sample or high-resolution acquisition modes and a bandwidth limit setting of 20 MHz: $\pm(1 \text{ WI} + 150 \text{ ppm of } \text{Reading} + 1.3 \text{ ns})$ For repetitive acquisitions using average acquisition mode with ≥ 8 averages and a bandwidth limit setting of FULL: $\pm(1 \text{ WI} + 150 \text{ ppm of } \text{Reading} + 200 \text{ ps})$
Accuracy, Delta Time Measurement ^{1,2}	For single-shot acquisitions using sample or high-resolution acquisition modes and a bandwidth limit setting of 100 MHz: $\pm(1 \text{ WI} + 150 \text{ ppm of } \text{Reading} + 650 \text{ ps})$ For repetitive acquisitions using average acquisition mode with ≥ 8 averages and a bandwidth limit setting of FULL: $\pm(1 \text{ WI} + 150 \text{ ppm of } \text{Reading} + 300 \text{ ps})$

¹ For input signals ≥ 5 divisions in amplitude and a slew rate of ≥ 2.0 divisions/ns at the delta time measurement points. Signal must have been acquired at a volts/division setting ≥ 5 mV/division and not in Events mode.

² The WI (waveform interval) is the time between the samples in the waveform record. Also, see the footnotes for *Sample Rate Range* and *Equivalent Time or Interpolated Waveform Rates* in Table 2-3 on page 2-5.

Table 2–11: Warranted Characteristics — Triggering System

Name	Description
Accuracy, Trigger Level or Threshold, DC Coupled	$\pm(2\% \text{ of } \text{Setting} - \text{Net Offset}^1 + 0.2 \text{ div} \times \text{volts/div setting} + \text{Offset Accuracy})$ for any channel as trigger source and for signals having rise and fall times $\geq 20 \text{ ns}$
Sensitivity, Edge-Type Trigger, DC Coupled ²	0.35 division from DC to 50 MHz, increasing to 1 division at 350 MHz (TDS 410A and TDS 420A) or 500 MHz (TDS 460A) for any channel as trigger source
Sensitivity, Video-Type, TV Field and TV Line ²	0.6 division of video sync signal
Pulse Width, minimum, Events-Delay	5 ns
Auxiliary Trigger Input, External Clock Input	Connector: BNC at rear panel Input Load: equivalent to three TTL gate loads Input Voltage (maximum): -5 VDC to $+10 \text{ VDC}$ (TTL levels recommended)
Auxiliary Trigger, Maximum Input Frequency	10 MHz Duty Cycle High and low levels must be stable for $\geq 50 \text{ ns}$
Frequency, External Clock	DC to 10 MHz High and low levels must be stable for $\geq 50 \text{ ns}$

¹ Net Offset = Offset – (Position × Volts/Div). Net Offset is the voltage level at the center of the A-D converter dynamic range. Offset Accuracy is the accuracy of this voltage level.

² The minimum sensitivity for obtaining a stable trigger. A stable trigger results in a uniform, regular display triggered on the selected slope. The trigger point must not switch between opposite slopes on the waveform, and the display must not “roll” across the screen on successive acquisitions. The TRIG'D LED stays constantly lighted when the SEC/DIV setting is 2 ms or faster but may flash when the SEC/DIV setting is 10 ms or slower.

Table 2–12: Warranted Characteristics — Probe Compensator Output

Name	Description	
Output Voltage and Frequency, Probe Compensator	Characteristic	Limits
	Voltage	0.5 V (base-top) $\pm 5\%$ into a 1 M Ω load
	Frequency	1 kHz $\pm 5\%$

Table 2–13: Warranted Characteristics — Power Requirements

Name	Description
Source Voltage and Frequency	90 to 132 VAC _{RMS} , continuous range, for 48 Hz through 62 Hz 100 to 132 VAC _{RMS} , continuous range, for 48 Hz through 440 Hz 180 to 250 VAC _{RMS} , continuous range, for 48 Hz through 440 Hz
Power Consumption	$\leq 240 \text{ Watts}$ (370 VA)

Table 2–14: Warranted Characteristics — Environmental, Safety, and Reliability

Name	Description
Atmospherics	<p>Temperature¹:</p> <p>Standard Instrument: Operating, 0° C to +50° C; Nonoperating, –40° C to +75° C</p> <p>Instrument with Option 1F: Operating, +4° C to +50° C; Nonoperating, –22° C to +60° C</p> <p>Option 3P: Operating, 0° C to +40° C; Nonoperating, –20° C to +60° C</p> <p>Relative humidity:</p> <p>Standard Instrument: 0 to 95%, at or below +30° C; 0 to 75%, +31° C to +50° C</p> <p>Instrument with Option 1F: Operating without disk, to 80%, at or below +29° C; to 20%, at or below +50° C; Operating with disk, 20% to 80% at or below +32° C; Nonoperating, 20% to 30% at +45° C; To 90%, at or below +40° C; to 50%, at or below +50° C</p> <p>Option 3P: Operating, 30% to 80%; Nonoperating, 95%, at +40° C</p> <p>Altitude:</p> <p>Operating, to 15,000 ft. (4570 m); Nonoperating, to 40,000 ft. (12190 m)</p>
Emissions ^{2,3}	<p>Meets or exceeds the requirements of the following standards:</p> <p>Vfg. 243/1991 Amended per Vfg 46/1992</p> <p>FCC 47 CFR, Part 15, Subpart B, Class A</p> <p>EN50081-1 European Community Requirements</p> <p>EN55022 Radiated Emissions Class B</p> <p>EN55022 Conducted Emissions Class B</p> <p>With Option 3P: VDE 0871, Category B, Vfg. 1046/1984 FCC Rules and Regulations, Part 15, Subpart B, Class A</p>

Table 2-14: Warranted Characteristics — Environmental, Safety, and Reliability (Cont.)

Name	Description
Susceptibility	<p>Meets or exceeds the requirements of the following standards:</p> <p>EN50082-1 European Community Requirements</p> <p>IEC 801-3 Radiated Susceptibility 3 V/meter from 27 MHz to 500 MHz unmodulated</p> <p>Performance Criteria: < + 0.2 division waveform displacement, or < 0.4 division increase in p-p noise when the oscilloscope is subjected to the EMI specified in the standard</p> <p>IEC 801-2 Electrostatic Discharge, Performance Criteria B</p> <p>Option 3P: The printer can withstand up to 5 kV with no change to settings or impairment of normal operations or up to 9 kV with no damage that prevents recovery of normal operations</p>
Dynamics	<p>Random vibration^{4,5}:</p> <p>0.31 g rms, from 5 to 500 Hz, 10 minutes each axis, operating;</p> <p>2.46 g rms, from 5 to 500 Hz, 10 minutes each axis, non-operating</p>
Third Party Certification	<p>Conforms to and is certified where appropriate to:</p> <p>UL 1244, Second Edition</p> <p>CAN/CSA-C22.2 No. 231-M89</p>

- ¹ Maximum operating temperature is decreased 1° C per 1000 feet (305 meters) above 5000 feet (1525 meters).
- ² To maintain emission requirements when connecting to the IEEE 488 GPIB interface of this oscilloscope, use only a high-quality, double-shielded (braid and foil) GPIB cable. The cable shield must have low impedance connections to both connector housings. Acceptable cables are Tektronix part numbers 012-0991-00, -01, and -02.
- ³ To maintain emission requirements when connecting to the VGA-compatible video output of this oscilloscope, use only a high-quality double-shielded (braid and foil) video cable with ferrite cores at both ends. The cable shield must have low impedance connections to both connector housings. An acceptable cable is LCOM part number CTL3VGAMM-5.
- ⁴ Does not apply to a rackmounted instrument.
- ⁵ Does not apply to an instrument with Option 1F.

Typical Characteristics

This section contains tables that list the various *typical characteristics* that describe the TDS 400A Digitizing Oscilloscopes.

Typical characteristics are described in terms of typical or average performance. Typical characteristics are not warranted.

This subsection lists only typical characteristics. A list of warranted characteristics starts on page 2-11.

Table 2-15: Typical Characteristics — Signal Acquisition System

Name	Description		
Accuracy, DC Voltage Measurement, Not Averaged	Measurement Type	DC Accuracy	
	Any Sample	$\pm(1.5\% \times (\text{reading} - \text{Net Offset}^1) + \text{Offset Accuracy} + 0.13 \text{ div} + 0.6 \text{ mV})$	
	Delta Volts between any two samples ²	$\pm(1.5\% \times \text{reading} + 0.26 \text{ div} + 1.2 \text{ mV})$	
Frequency Limit, Upper, 100 MHz Bandwidth Limited	100 MHz		
Frequency Limit, Upper, 20 MHz Bandwidth Limited	20 MHz		
Nonlinearity	< 1 DL, differential; ≤ 1 DL, integral, independently based ³		
Analog Bandwidth, DC-1 MΩ Coupled with Standard-Accessory Probe Attached	Volts/Div	TDS 410A and TDS 420A Bandwidth	TDS 460A Bandwidth
	5 mV/div–10 V/div	DC–200 MHz	DC–400 MHz
	2 mV/div–4.98 mV/div	DC–150 MHz	DC–250 MHz
	1 mV/div–1.99 mV/div	DC–100 MHz	DC–100 MHz

Table 2–15: Typical Characteristics — Signal Acquisition System (Cont.)

Name	Description				
	Volts/Div Setting	Step Amplitude	Settling Error (%) ⁴		
20 ns			500 ns	20 ms	
Step Response Settling Error	1 mV/div–99.5 mV/div	≤2 V	≤0.5	≤0.2	≤0.1
	100 mV/div–995 mV/div	≤20 V	≤2.0	≤0.5	≤0.2
	1 V/div–10 V/div	≤200 V	≤2.0	≤0.5	≤0.2

- ¹ **Net Offset = Offset – (Position x Volts/Div).** Net Offset is the voltage level at the center of the A-D converter dynamic range. Offset Accuracy is the accuracy of this voltage level.
- ² The samples must be acquired under the same setup and ambient conditions.
- ³ A DL (digitization level) is the smallest voltage level change that can be resolved by the 8-bit A-D Converter with the input scaled to the volts/division setting of the channel used. Expressed as a voltage, a DL is equal to 1/25 of a division times the volts/division setting.
- ⁴ The values given are the maximum absolute difference between the value at the end of a specified time interval after the mid-level crossing of the step and the value one second after the mid-level crossing of the step, expressed as a percentage of the step amplitude.

Table 2–16: Typical Characteristics — Time Base System

Name	Description
Aperture Uncertainty	For real-time or interpolated records having duration ≤1 minute: $\leq(50 \text{ ps} + 0.03 \text{ ppm} \times \text{Record Duration}) \text{ RMS}$ For equivalent time records: $\leq(50 \text{ ps} + 0.06 \text{ ppm} \times \text{WI}^1) \text{ RMS}$
Fixed Error in Sample Time	≤50 ps
External Clock sampling uncertainty	±8 ns
External Clock Edge to Sampling Time Delay	Sample –20 ns (Sample edge is delayed relative the the sample moment.) Hi Res Hi Res averaging starts within ± 8 ns of the clock edge. Averaging stops after 1/(maximum external clock rate ²) Peak Detect Runs continuously at 100 MS/s
External Clock Minimum Prerecord points	55 points before the first visible sample in the record at the maximum clock speed 35 points before the first visible sample in the record at slow clock speeds
External Clock Minimum Postrecord points	25 points after the last visible sample in the record

- ¹ The WI (waveform interval) is the time between the samples in the waveform record. Also, see the footnotes for *Sample Rate Range* and *Equivalent Time or Interpolated Waveform Rates* in Table 2–3 on page 2–5.
- ² You set the maximum external clock rate using the Horizontal Clock menu.

Table 2-17: Typical Characteristics — Triggering System

Name	Description		
Error, Trigger Position, Edge Triggering	Acquire Mode		Trigger-Position Error^{1,2}
	Sample, Hi-Res, Average		±(1 WI + 1 ns)
	Peak Detect, Envelope		±(2 WI + 1 ns)
Holdoff, Variable, Main Trigger, Internal Clock and non TV Trigger	Main Horizontal Scale	Minimum Holdoff	Maximum Holdoff
	≤100 ns/div	1 μs	5 × Min Holdoff
	≥100 ms/div	1 s	5 × Min Holdoff
	Otherwise	10 × sec/div	5 × Min Holdoff
Holdoff, Variable, External Clock	0 to 100 ms		
Lowest Frequency for Successful Operation of “Set Level to 50%” Function	20 Hz		
Sensitivity, Edge Trigger, Not DC Coupled ³	Trigger Coupling		Typical Signal Level for Stable Triggering
	AC		Same as DC-coupled limits ⁴ for frequencies above 60 Hz. Attenuates signals below 60 Hz
	Noise Reject		Three and one-half times the DC-coupled limits ⁴
	High Frequency Reject		One and one-half times the DC-coupled limits ⁴ from DC to 30 kHz. Attenuates signals above 30 kHz
	Low Frequency Reject		One and one-half times the DC-coupled limits ⁴ for frequencies above 80 kHz. Attenuates signals below 80 kHz
Video Mode (Option 05 Equipped Instruments Only)	<p>Line Rate Class: Four classes are provided as follows</p> <ul style="list-style-type: none"> ■ NTSC, which provides a default line rate compatible with the NTSC standard (525/60) ■ PAL, which provides a default line rate compatible with the PAL standard (625/50) ■ SECAM, which provides a default line rate compatible with the SECAM standard (625/50) ■ Custom, which provides user selectable line rate ranges (see <i>Custom Line Rate Ranges</i> below) <p>Custom Line Rate Ranges: 15 kHz–20 kHz, 20 kHz–25 kHz, 25 kHz–35 kHz, and 35 kHz–64 kHz</p> <p>Holdoff: Automatically adjusts to 58 ms (nominal) for NTSC class; to 150 ms (nominal) for PAL and SECAM</p> <p>Triggerable on Field Selections: Odd, Even, or Both</p> <p>Delayed Acquisition: Settable for delay by line number or runs after time delay</p>		
Frequency, Maximum for Events Delay ⁵	90 MHz		

Table 2–17: Typical Characteristics — Triggering System (Cont.)

Name	Description
Width, Minimum Pulse and Rearm, Events Delay ⁶	5 ns

- ¹ The trigger position errors are typically less than the values given here. These values are for triggering signals having a slew rate at the trigger point of ± 0.5 division/ns.
- ² The waveform interval (WI) is the time between the samples in the waveform record. Also, see the footnote for the characteristics *Sample Rate Range* and *Equivalent Time or Interpolated Waveform Rates* in Table 2–3 on page 2–5.
- ³ The minimum sensitivity for obtaining a stable trigger. A stable trigger results in a uniform, regular display triggered on the selected slope. The trigger point must not switch between opposite slopes on the waveform, and the display must not “roll” across the screen on successive acquisitions. The TRIG’D LED stays constantly lighted when the SEC/DIV setting is 2 ms or faster but may flash when the SEC/DIV setting is 10 ms or slower.
- ⁴ See the characteristic *Sensitivity, Edge-Type Trigger, DC Coupled* in Table 2–11, which begins on page 2–14.
- ⁵ The maximum frequency for a delaying events input.
- ⁶ The minimum pulse width and rearm width required for recognizing a delaying event.

Table 2–18: Typical Characteristics — Data Handling

Name	Description
Time, Data-Retention, Nonvolatile Memory ^{1,2}	Internal batteries, installed at time of manufacture, have a life of ≥ 5 years when operated and/or stored at an ambient temperature from 0° C to 50° C. Retention time of the nonvolatile memories is equal to the remaining life of the batteries
Nonvolatile Memory Save Time	10 seconds
Floppy Disk Drive Capacity, Opt 1F only	3.5 in. floppy disk, 720 KB or 1.44 MB, compatible with DOS 3.3 format for storing waveforms, hard copies, and instrument setups

- ¹ The time that reference waveforms, stored setups, and calibration constants are retained when there is no power to the oscilloscope.
- ² Data is maintained by lithium poly-carbon monofluoride.