

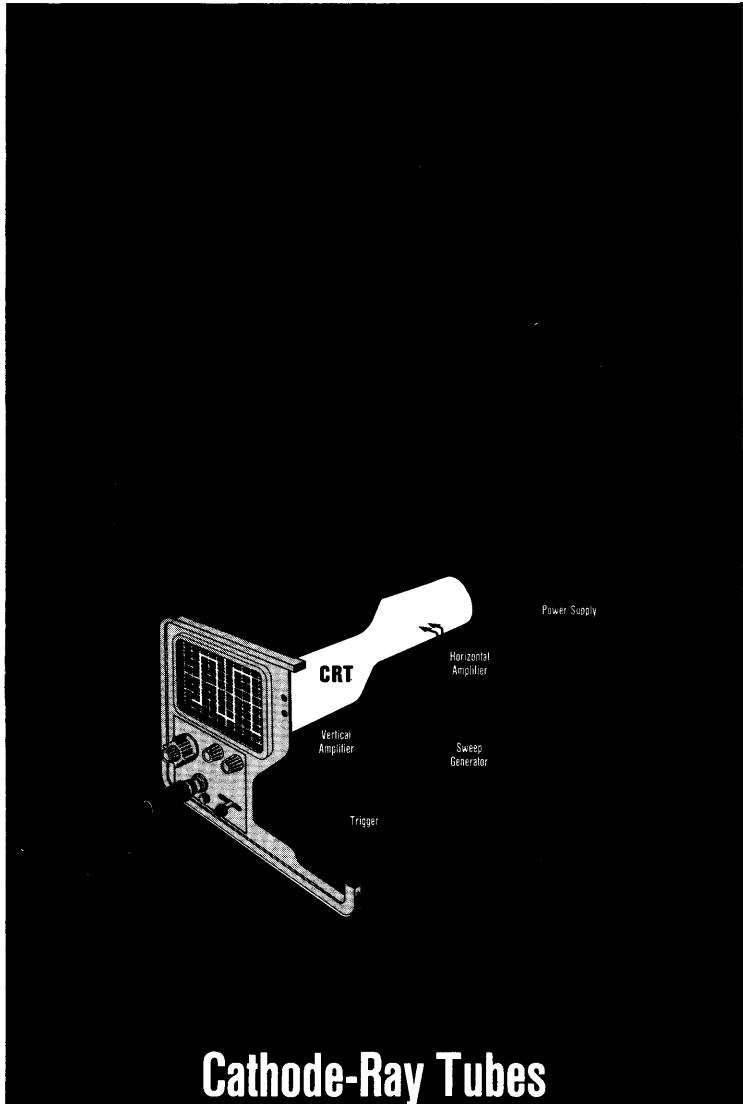

Circuit Concepts

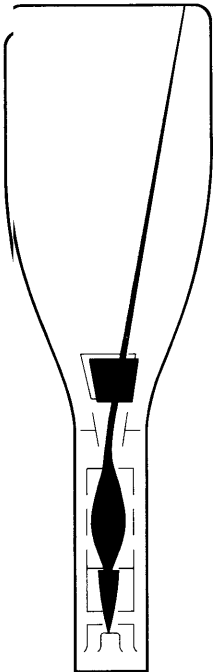

Cathode-Ray Tubes

CATHODE-RAY TUBES

BY
CHUCK DeVERE

Significant Contributions
by
BOB ORWILER



CIRCUIT CONCEPTS

SECOND EDITION
FOURTH PRINTING JULY 1969
062-0852-01
PRICE \$1.00

© 1967, TEKTRONIX, INC.
BEAVERTON, OREGON
ALL RIGHTS RESERVED

CONTENTS

1	INTRODUCTION	1
2	ELECTRON OPTICS	3
3	THE TRIODE SECTION	9
4	UNBLANKING	17
5	FOCUS AND ASTIGMATISM LENS	25
6	THE DEFLECTION SYSTEM	27
7	ACCELERATION SCHEMES	47
8	SPACE CHARGE REPULSION EFFECT AND TRACE WIDTH	55
9	PHOSPHORS	61
10	HUMAN EYE RESPONSE	63
11	LUMINANCE CHARACTERISTICS OF PHOSPHORS	67
12	SPECTRAL RESPONSE	71
13	WRITING SPEED	73
14	PHOSPHOR BURNING	77
15	ALUMINIZED TUBES	79
16	LIGHT FILTERS	81
17	GRATICULES	83
18	TRACE ALIGNMENT	87
19	DUAL BEAM	89
20	DUAL GUN	91
	INDEX	95
	CIRCUIT CONCEPTS BY INSTRUMENT	97

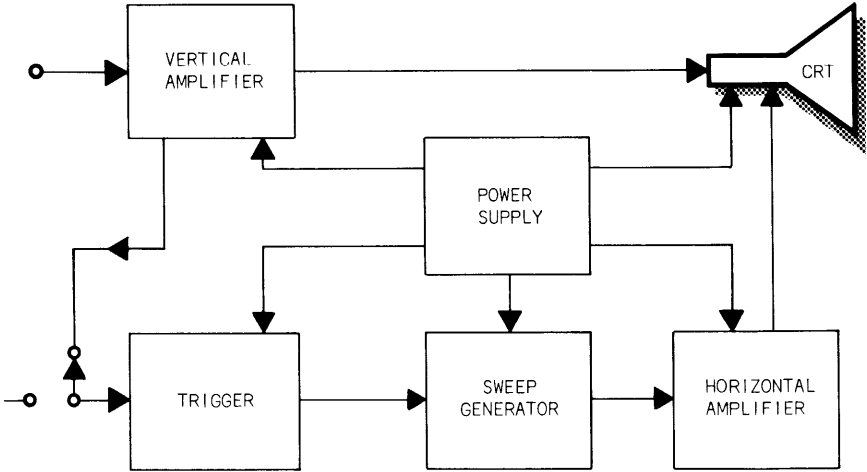

1

INTRODUCTION

The cathode-ray tube (CRT) is the output or display section of an oscilloscope and any study of oscillography must surely include the CRT. When trouble-shooting a malfunctioning oscilloscope, an understanding of the inner workings of the CRT will aid in isolating the section of the oscilloscope causing the problem. The design of the circuitry that interfaces with the CRT is dependent upon the requirements of the CRT and before these circuits can be fully analyzed the requirements of the CRT must be known. The proper operation of the various controls and adjustments directly associated with the display requires an understanding of the probable effect upon the CRT. The specifications, limitations, and capability of the CRT must be considered when selecting an oscilloscope for a particular application.

A CRT can be divided into five sections as shown in Fig. 1-1. The triode section furnishes a controllable source of electrons which the focus section forms into an electron beam. This beam is deflected vertically and horizontally in the deflection section and may be accelerated in the acceleration section. The beam strikes the phosphor-covered screen of the tube and light is produced. Each of these sections and their interrelationships will be covered in the following discussion.

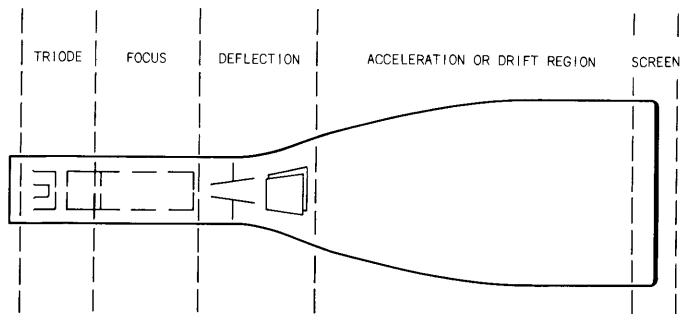

Fig. 1-1. CRT sections.

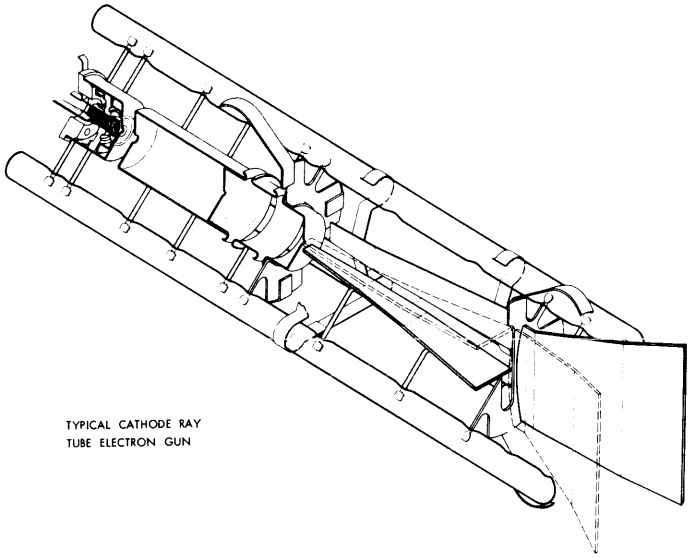

Fig. 1-2. CRT electron gun.

The first three sections of a CRT are shown in Fig. 1-2. A review of electron optics is needed in order to fully understand the operation of these CRT sections.

2

ELECTRON OPTICS

equipotential lines

The electrons emitted by the heated cathode are acted upon by the electric field between the cathode, grid, and first anode. This field can be represented by lines showing where the potential of the field is constant. These lines are called *equipotential lines* and their effect on an electron passing through them depends on their shape, the voltage difference between, their spacing, the velocity of the electron, and whether the electron is traveling in the direction of increasing or decreasing potential.

axial and radial velocity

The CRT axis is used as a reference for describing the path of an electron. This axis is the center line of the tube or, in other words, the shortest straight line from the cathode to the face plate. An electron's velocity can be separated into two components, *axial velocity* and *radial velocity*. Fig. 2-1 shows an electron with its velocity separated into these two components. Both components are referenced to the CRT axis. The *radial* component is *perpendicular* to the CRT axis and the *axial* component is *parallel* to the axis.

action of electron lens

The action of an electrostatic electron lens is based on the fact that the force acting upon an electron traveling in the field is in a direction *perpendicular or normal* to the lines of equal potential and in the direction of *increasing* potential.

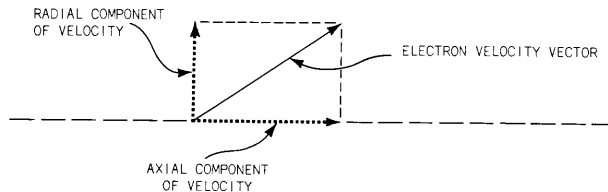

Fig. 2-1. Velocity components.

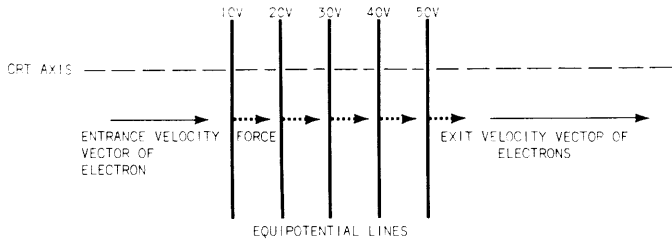

Fig. 2-2. Normal equipotential lines.

electron
velocity

Fig. 2-2 shows an electron passing through equipotential lines. The electron is traveling in the direction of increasing potential. The entrance velocity of the electron is normal to the equipotential lines and the force acting on the electron is normal to the lines in the same direction. Therefore, the velocity vectors add and the axial velocity of the electron is increased. The electron has no radial velocity before entering the field and the field imparts none.

decreasing
velocity

If the field in Fig. 2-2 were reversed so that the electron was traveling in the direction of decreasing potential, the force acting on the electron would still be normal to the equipotential lines but in the opposite direction than is shown. The exit velocity in such a case would be less than the entrance velocity.

Notice that there is no change in the *direction* of the electron in Fig. 2-2, only the velocity of the electron is changed. This will be true for all fields where an electron passes through an equipotential line normal to the line. The electron's velocity will be affected but not its direction.

radial
component

Fig. 2-3 shows an electron passing through a field with equipotential lines parallel to the CRT axis. The force acting on the electron is normal to the line and therefore perpendicular to the electron's entrance-velocity vector. These two vectors are shown in Fig. 2-3 and the final velocity vector is shown. The axial velocity of the electron has *not* changed, but a radial component has been added.

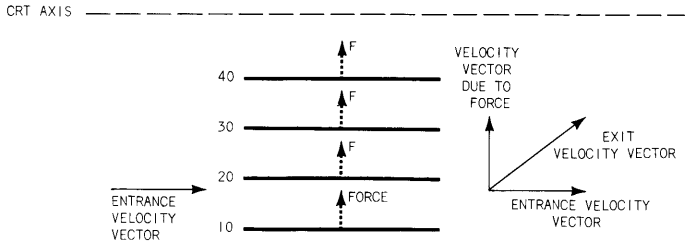

Fig. 2-3. Parallel equipotential lines.

An electron passing through equipotential lines at some angle, as shown in Fig. 2-4, will have a change in axial velocity but no change in radial velocity. This change in axial velocity will result in a change in direction and velocity. The force acting on the electron is parallel to the axis and therefore the radial component of the electron's velocity is not affected.

change in
direction

The approximate exit direction of an electron can be easily predicted by first resolving its entrance velocity into its axial and radial components and then adding the velocity vector due to the force of the equipotential lines.

exit
direction

Not all equipotential lines are straight. When the equipotential lines are curved, the question which needs answering is whether the lens is convergent or divergent. When determining whether a lens is convergent or divergent in nature, it must first be

field
gradient

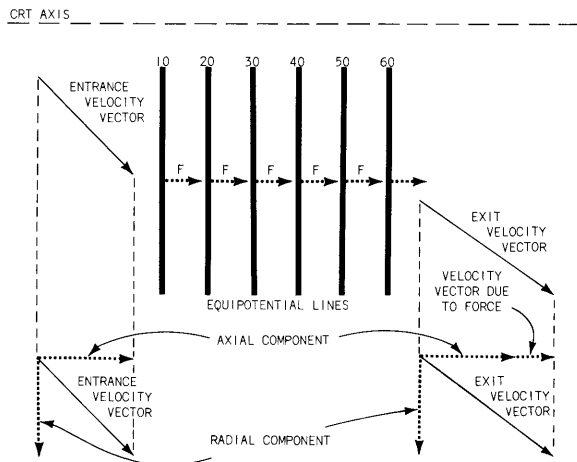

Fig. 2-4. Equipotential lines at an angle.

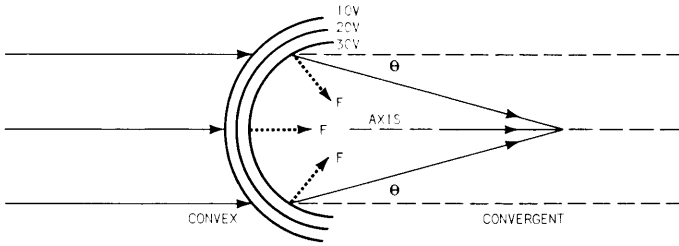

Fig. 2-5. Convergent lens.

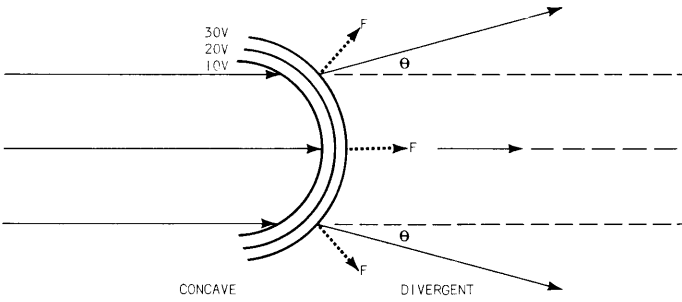

Fig. 2-6. Divergent lens.

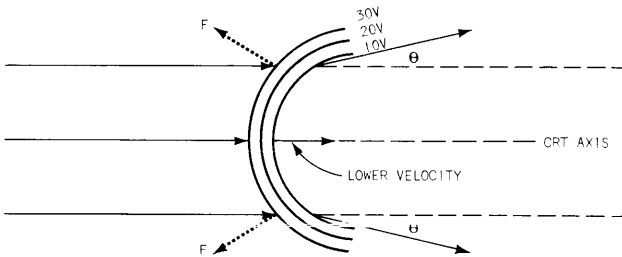

Fig. 2-7. Divergent lens.

determined whether the electron is traveling through an increasing or a decreasing potential. An increasing potential situation will be considered first.

lens
effect

An electron passing through a *convex* equipotential line will be bent toward the axis (Fig. 2-5). The effect of the field is *convergent*. An electron passing through a *concave* equipotential line will be bent *away* from the axis (Fig. 2-6). The effect of the field is *divergent*.

exit
direction

The assumption has been made that the electron is traveling in the direction of increasing potential. The size of the angle θ will depend upon the strength of the field, the initial velocity of the electron, and the curvature of the equipotential lines. If the initial electron velocity is *increased*, the angle will *decrease*. If the curvature of the field is increased (a smaller circle has a greater curvature), the angle will increase. If the strength of the field is increased the equipotential lines are closer together.

Notice that there is no change in direction of an electron for either field when the original direction of the electron is *normal* to the equipotential line. When the electron passes through the field normal to the equipotential lines there is no change in direction, only a change in velocity.

reversing
field

The effect of the two lenses is *reversed* if the electron is traveling in the direction of *decreasing* potential. Fig. 2-7 shows a convex lens that is divergent. The electron has an initial velocity and is passing through a decreasing potential. The velocity of the electron will decrease and the lens will be divergent as shown.

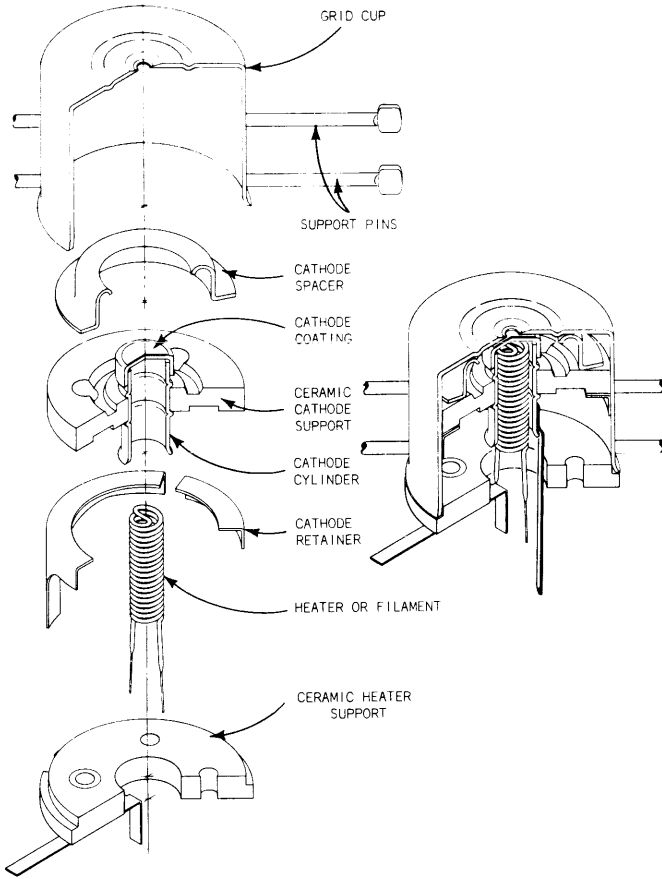

Fig. 3-1. CRT triode (physical).

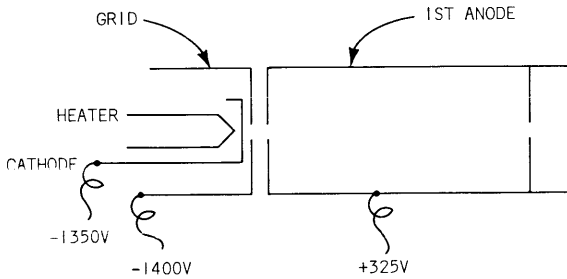

Fig. 3-2. CRT triode (electrical).

3

THE TRIODE SECTION

The gun section can be divided into two sub-sections, the triode and the focus lens. The triode section of a CRT provides a source of electrons, a means of controlling the number of electrons, and a means for shaping the electrons into a beam.

electron beam

cathode

The triode consists of the cathode, the grid, and the first anode. The cathode consists of a nickel cap coated with barium and strontium oxides. The cathode cylinder is mounted in a ceramic support with the heater held inside by metal leads attached to the ceramic heater mount. A spacer between the cathode assembly and grid cup maintains proper grid to cathode spacing.

The retainer below the cathode support holds the cathode assembly in place and attaches the ceramic heater support to the grid cup.

grid

heater

The cathode spacer and the cathode assembly are placed in the grid cup. The cathode retainer below the cathode is inserted into the grid cup and spot welded in place. The ceramic heater support is held in place by bending the tabs of the cathode retainer. The heater is inserted into the cathode cylinder and its leads welded to tabs mounted on the ceramic heater support.

first anode

The first anode (accelerator) is located in front of the grid and operated several thousand volts more positive than the grid. The grid, as in most triodes, is operated at a more negative voltage than the cathode. The support pins of the first anode and grid cups are pressed into glass rods to maintain proper spacing between the elements.

grid
aperture

The equipotential line pattern in the cathode-grid-first anode region of a CRT is shown in Fig. 3-3. Notice that in the grid opening or grid aperture region the lens is convex; therefore, convergent. The electrons emitted from the cathode have a low velocity and are strongly affected by this convergent action.

anode
aperture

The equipotential lines are almost straight in the center area and would tend to cause an electron to move parallel to the axis. In the area of the anode aperture the lens is concave; therefore, divergent. The electron velocity at this point is much greater than in the grid aperture and the effect of this divergent lens is slight. The lines are not curved as much as in the grid region so the lens is weaker.

The triode can be divided into three regions when considering the approximate trajectory of an electron through this lens. The first region is the grid-cathode region where the equipotential lines dip towards the cathode through the grid aperture. The second region is between the grid and the anode where the lines are parallel to the grid and anode surfaces. The third region is anode aperture region where the field penetrates the aperture.

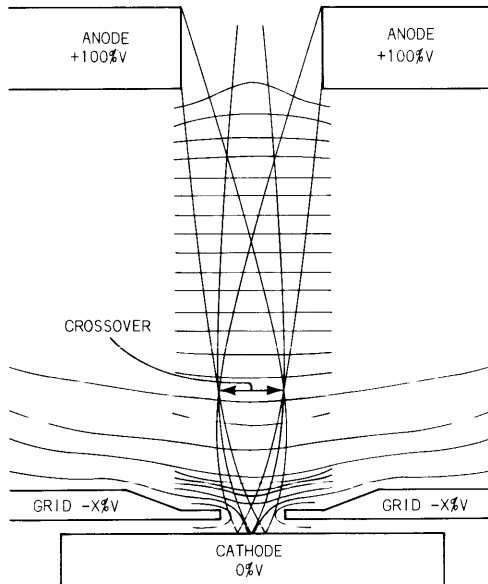

Fig. 3-3. Cathode/anode equipotential line plot.

- grid region
 An electron leaving the cathode at some angle less than 90° with respect to the axis and with some velocity due to thermal energy, would immediately experience a decrease in radial velocity and an increase in axial velocity. This would accelerate the electron and bend it toward the axis until it crossed the axis. The point of axis crossover is not the same for all electrons due to the difference in their thermal energy and the initial angle of emission.
- center region
 As the electron approaches the center region where the equipotential lines are straight (parallel to grid-anode surfaces), it has a radial velocity away from the axis. The axial velocity of the electron will be increasing as it passes through this region but the radial velocity will remain essentially constant. The increase in axial velocity causes the electron to arrive at a trajectory nearly parallel to the axis.
- anode region
 The axial velocity of the electron is higher on entering the anode aperture than it was in the first two regions. The effect of the field on the electron in this region is therefore reduced, but still apparent. The curvature of the field indicates a divergent effect or an increase in radial velocity away from the axis with continued increase in axial velocity (Fig. 3-3).
- electron trajectories
 The electrons emitted from a point on the surface of the cathode, which is off axis, will have a different trajectory and each will experience different forces. Also, one would expect the electrons emitted almost perpendicular to the axis of the triode to cross the axis at a different point than those emitted parallel to the axis.
- beam
 If the cathode is considered as an infinite number of point sources, the beam will be made up of many rays of electrons crossing the axis at different points (Fig. 3-3).
- crossover and spot size
 Electrons which leave different points of the cathode at the same angle, cross at a section of the beam called the *crossover*. This part of the beam has the least cross-sectional area. The final focused spot seen on the face of a CRT is the *image* of the *crossover* and the crossover *size* determines to a great extent the final spot *size*.

The size of the crossover and its location along the axis is dependent upon the triode dimensions and voltages. As the control grid voltage is changed to increase or decrease beam current the size and location of the crossover will change; therefore, the focus of the beam.

focus

Remember that the elements shown and the electron beam are three dimensional and are shown in a cross-sectional view. Remember also that the equipotentials represented by lines are actually surfaces.

The equipotential plots of the grid-cathode lens for several values of grid voltage are shown in Fig. 3-4. Notice in Fig. 3-4A the zero equipotential line does not reach through the grid aperture and touch the cathode. Electrons emitted from the cathode with only slight thermal velocity are prevented by a retarding field from reaching an equipotential line equal to or greater than the cathode potential. The voltage required to bring about this situation is the cutoff voltage (V_{CO} of the tube). Fig. 3-4A shows tube cutoff. Fig. 3-4B, C, and D show tubes in various stages of conduction, depending on the grid voltage.

V_{CO}

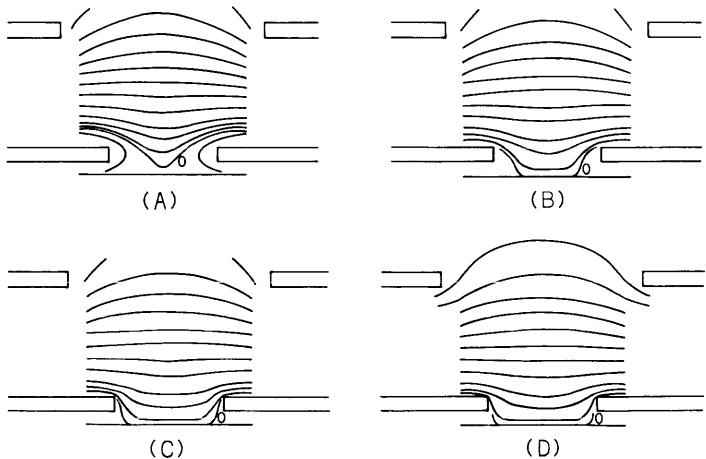

Fig. 3-4. Equipotential line plot for various grid bias.

field
intensity

Notice that the shape of the equipotential lines in each case is different and therefore the lens effect is different in each case. The factors affecting V_{c0} are the same as those affecting the equipotential lines: *Grid-cathode spacing, grid-material thickness, and anode and grid aperture diameter.* If the field increases near the cathode so does the cutoff voltage. The field can be increased by: (1) decreasing the grid-cathode spacing, (2) decreasing the grid-anode spacing, (3) decreasing the grid material thickness, or (4) increasing the grid aperture diameter.

When the grid-aperture diameter is reduced, the cutoff voltage is decreased. A reduction in anode voltage causes the field to decrease, and the cutoff decreases.

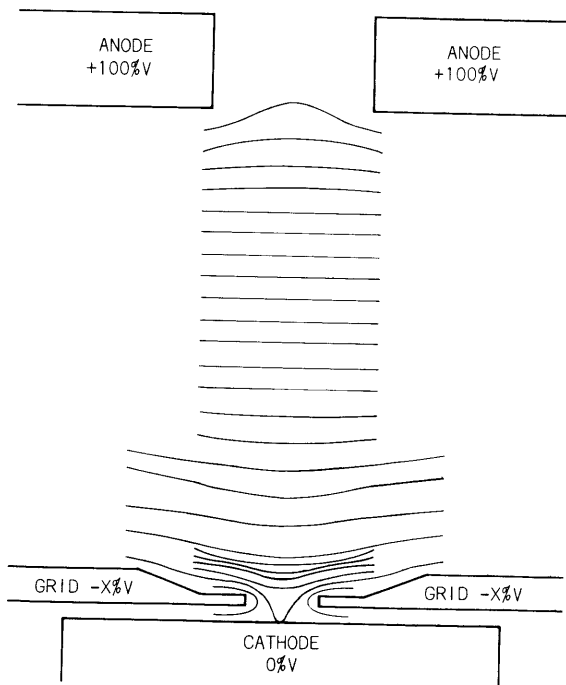
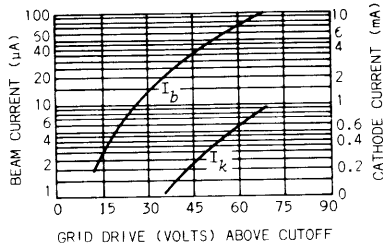
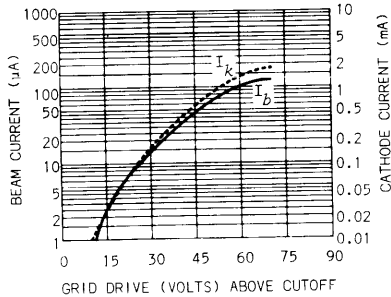

Fig. 3-5. Cathode/anode equipotential line plot.

T5030
 $V_{eo} = -57V$
 $V_A = 3000V$



T5470
 $V_{eo} = -76V$
 $V_A = 2000V$



T6470
 $V_{eo} = -92V$
 $V_A = 2250V$

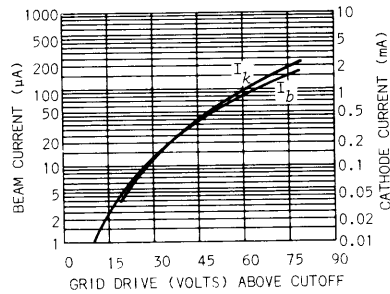

Fig. 3-6. Grid drive vs beam current and cathode current.

The voltage between the CRT cathode and control grid can be measured and with the graphs shown in Fig. 3-6, the cathode current and beam current can be estimated.

beam current

These graphs show the change in *beam current* and *cathode current* with respect to grid-drive voltage which is shown in *volts above cutoff*. The grid voltage in normal operation is the result of the setting of the intensity control and the unblanking pulse. Notice that on the left the vertical is calibrated in μA of beam current (I_b) while on the right in mA of cathode current (I_k). The horizontal is in volts above cutoff of the tube with the actual

cathode current

cutoff voltage (V_c) and the voltage on the acceleration anode (V_A) given. The curves are valid only for the given first anode acceleration voltage and are an average for a group of tubes.

From these graphs the beam current for any reasonable grid drive may be found. If the amount of beam current is known then trace width, light output, and relative writing speed may be approximated. These approximations will be shown later.

Fig. 3-7 shows that as the grid voltage changes for a particular triode, the equipotential line equal to the cathode potential will touch the cathode at different radii. In other words, as the grid drive changes the diameter of the cathode from which electrons originate also changes.

cathode
diameter

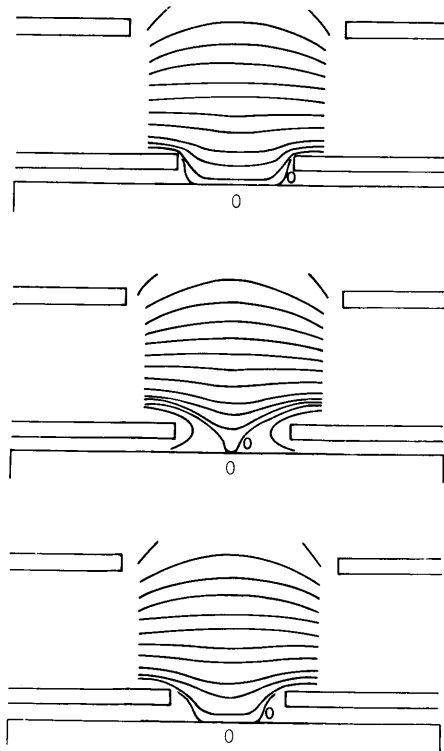

Fig. 3-7. Equipotential line plot for various grid bias.

cathode loading

As the emitting diameter changes, the cathode loading (current/unit area drawn from the cathode surface) changes. The cathode loading is not uniform across the emitting area but peaked as shown in Fig. 3-8.

peak current

Fig. 3-8 shows a high current density or loading present in the center of the emitting area and tapering off toward the edges. It also shows that the *peak* current density has a different value for different values of grid voltage. Curves showing the distribution of electrons within the beam would have the same shape as those shown in Fig. 3-8.

grid-cathode spacing

Grid-cathode spacing will also affect cathode loading. A decrease in spacing will cause an increase in cathode loading and therefore more current for a given grid voltage. As mentioned previously, this decrease in grid-cathode spacing causes a higher V_{co} .

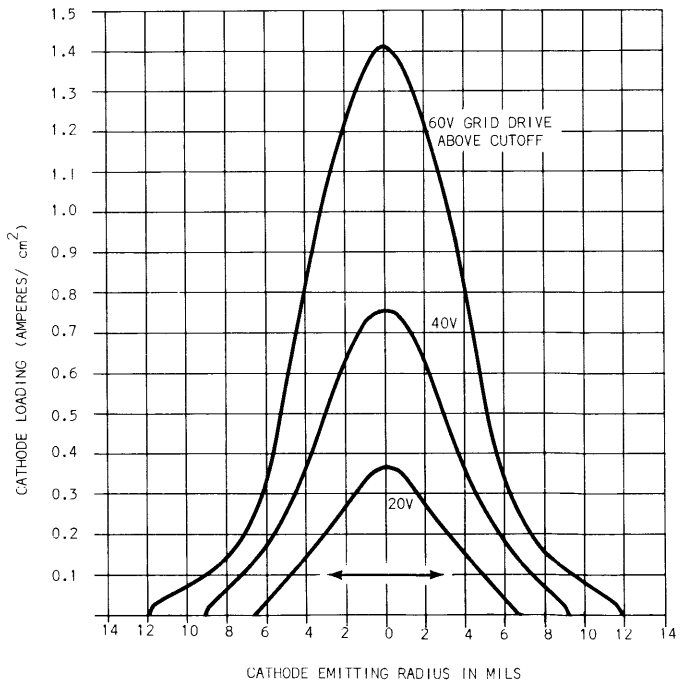

Fig. 3-8. Cathode loading curves.

4

UNBLANKING

beam
current
control

Some means of controlling the number of electrons is needed in the triode section of the CRT. In any triode the current may be controlled by changing the voltage on the grid with respect to the cathode. Similarly, a front panel control (Intensity) varies the grid voltage of the CRT and allows the operator to adjust the beam current.

grid
unblanking

In normal operation of the CRT the beam appears on the screen only after the sweep has been triggered. In most CRT's a positive pulse is applied to the control grid for the duration of the sweep. This method is called *grid unblanking*. The grid voltage is set by the intensity control below V_{c0} . As the sweep starts, the gun is turned on by a positive unblanking pulse applied to the grid. The gun is cutoff in the absence of an unblanking pulse (Fig. 4-1) when the intensity control is properly set.

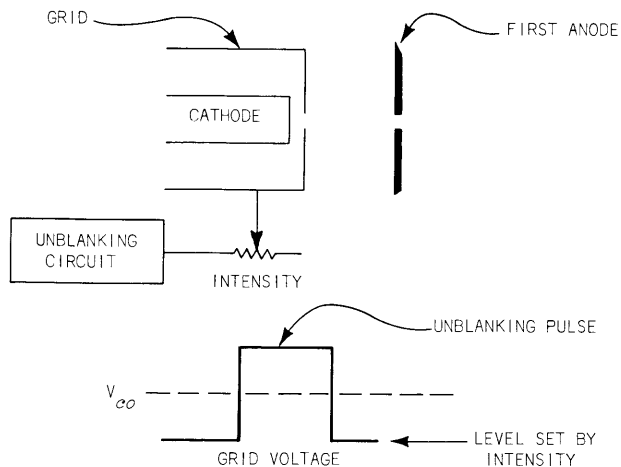

Fig. 4-1. Grid unblanking.

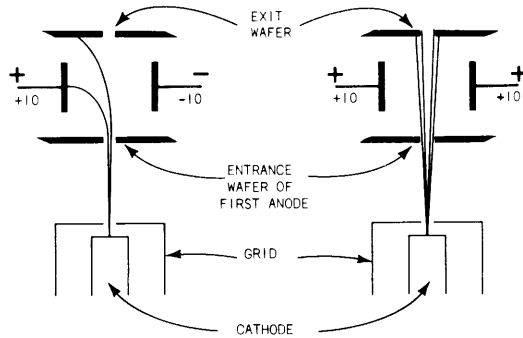

Fig. 4-2. Deflection unblanking.

deflection
plate
unblanking

Another method of controlling the beam is called *deflection plate unblanking*. This requires a set of plates immediately following the first anode which in this case is a plate rather than a barrel type anode. The deflection plates are positioned horizontally. A top view of this type of unblanking is shown in Fig. 4-2.

beam
deflection

The left plate, for example, may be connected to a fixed positive voltage such as 10 V. The right plate is connected to the unblanking circuit in the oscilloscope. When the sweep is not operating, the right plate is at a negative potential with respect to the left plate. The beam is deflected to the left and absorbed by the plate and exit wafer of the first anode. The beam is *still turned on* but is being deflected off axis and does not reach the screen of the CRT.

unblanking
pulse

When the sweep is triggered, a positive pulse is applied to the right plate. This brings it to approximately the same potential as the left plate and the beam is allowed to pass through the exit aperture.

grid
unblanking

When *grid* unblanking is used in a CRT, a spot may be obtained on the screen in the absence of an unblanking pulse by adjusting the intensity control. The grid voltage is raised above cutoff voltage V_{co} and beam current is present. The beam current is increased if an unblanking pulse is then applied to the grid, with the distinct possibility of burning the screen. The capability of overriding the unblanking and obtaining a spot may, however be of great aid in trouble shooting or in setting up the measurements.

Grid unblanking requires more power and stiffer power supply regulation. It is therefore used most often in oscilloscopes where power supply regulation and power conservation are not limiting factors.

The intensity control sets the voltage on the grid of the CRT even when deflection plate unblanking is used. The gun is usually turned on and beam current is present at all times with deflection-plate unblanking. When the tube is *blanked*, the beam is deflected and not allowed to reach the screen. In the absence of an unblanking pulse the spot is not seen on the screen even with maximum beam current. The beam is deflected and collected prior to reaching the screen.

single
event
photography

In some single-event photography applications it is necessary to monitor the screen for a long period with the shutter of the camera open before the occurrence of the event. Deflection-plate unblanking may cause spotting of the film due to the failure of the deflection unblanking system to collect all of the beam electrons.

cathode
life

The life of a tube is dependent on, among other things, the life of the cathode, which can be expressed as a function of beam current and the time this current is drawn from the cathode. When an unblanking pulse is absent in a tube using *grid unblanking*, beam current is usually not present. In a tube with *deflection unblanking*, the unblanking pulse controls beam deflection and not beam current. Unless the intensity control is turned down, the cathode is being consumed when unblanking is not present. This may reduce the useful life of the tube. Consequently, tubes with high cathode loading do not use deflection unblanking.

Fig. 4-3 shows a typical deflection plate unblanking system. Notice that two sets of plates are used and they are cross-connected in the drawing. (The lower left plate is the same voltage as the upper right plate.)

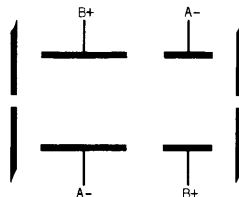

Fig. 4-3. Typical deflection unblanking plates.

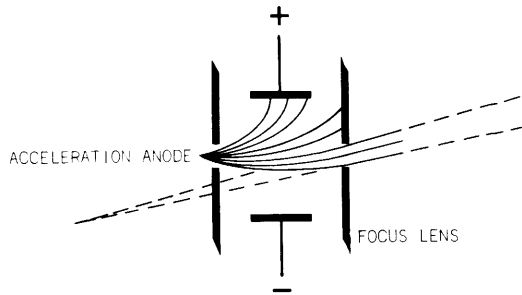

Fig. 4-4. Single deflection unblanking plate.

The need for this configuration is shown in Fig. 4-4 and 4-5. The electrons entering the first anode aperture are subjected to a slight divergent action due to the penetration of the equipotential lines through the aperture. Assuming that one plate is *slightly* negative with respect to the other plate, the electrons would have a path as shown in Fig. 4-4. Some of the electrons would be collected by the positive plate and others by the exit wafer. Some of the electrons, however, would pass through the aperture in the exit wafer and strike the screen. This causes a problem. These electrons have an apparent source off the axis of the tube. This is shown in Fig. 4-4 by drawing tangents to the different electron trajectories.

Fig. 4-5 shows that the apparently off-axis electrons will strike the screen at a different point than electrons from a source on the axis. When the tube is *blanked*, one plate is much more negative than the other and none of the electrons pass through the aperture. But when the unblanking pulse is applied to one plate, it drives the plate positive and during this change from blanked to unblanked the situation in Fig. 4-5 exists. The voltage on the driven plate will be slightly negative with respect to the undriven plate and will be changing until it reaches the same voltage. During the period of change the beam will

blanking
and
unblanking

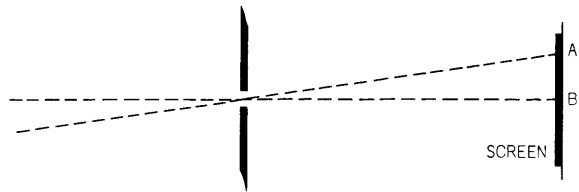

Fig. 4-5. Result of off-axis origin.

move on the screen from Point A to Point B (Fig. 4-5). The same situation in reverse will occur when the unblanking pulse drives the one plate negative in order to blank the tube. Beam movement on the screen during blanking and unblanking is undesirable.

beam
movement
correction

The problem can be solved by adding a second set of plates that will bend the beam back toward the axis as shown in Fig. 4-6. The tangents to the trajectories with the double plate system show the apparent source to be on axis at all times during blanking or unblanking. With this system there is no movement of the beam on the screen due to unblanking pulse action.

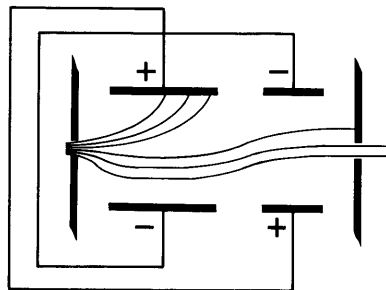

Fig. 4-6. Correction for single plate deflection unblanking problems.

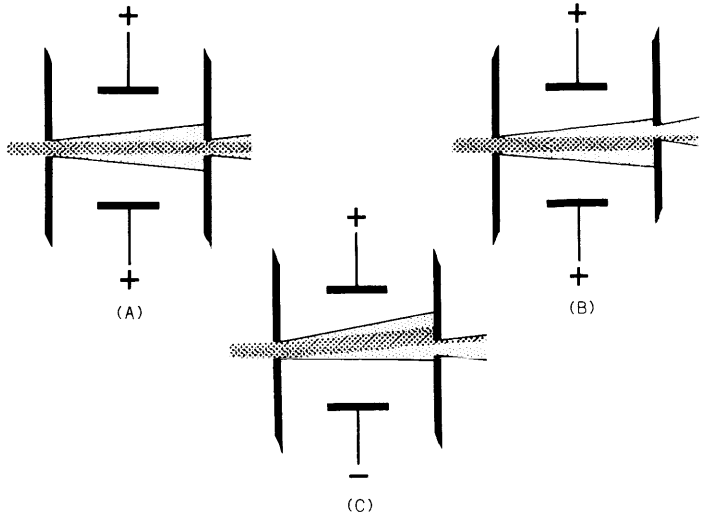

Fig. 4-7. Beam current variations due to deflection plate unblanking.

gun
misalignment

Another problem common to deflection plate unblanking is that the beam current may be less than optimum due to normal variations in plate to plate spacing or aperture alignment. An example is shown in Fig. 4-7 (only two plates are shown to simplify the drawing).

Case A shows both plates at the same potential. It would be expected that the beam would be centered, allowing the maximum amount of current to pass through the aperture because the maximum concentration of electrons is near the center of the beam. Toward the edge of the beam the density falls off.

Case B shows what might happen if the alignment is slightly off. The beam is slightly offset and beam current is not maximum. This situation might also arise if the peak amplitude of the unblanking pulse was not exactly equal to the voltage on the opposite plate, as shown in Case C.

The loss in beam current may be unimportant and thus no effort made to correct the situation. Where loss is important, an internal adjustment allows the voltage on one deflection plate to be adjusted for maximum beam current. This control is called the Blank Balance control or the Unblanking Center control. These controls are *not* front panel controls but are located inside the oscilloscope. Once they have been adjusted they need be checked only occasionally.

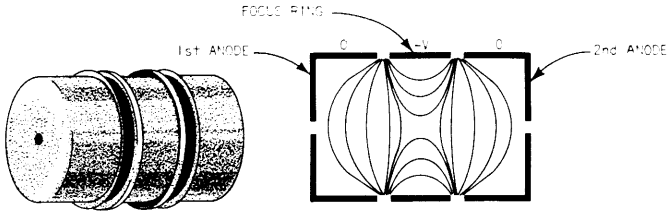

Fig. 5-1. Equipotential line plot within focus lens.

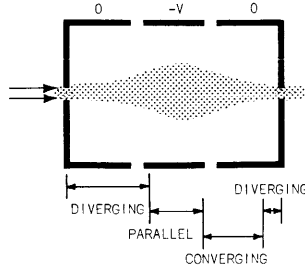

Fig. 5-2. Electron trajectory within focus lens.

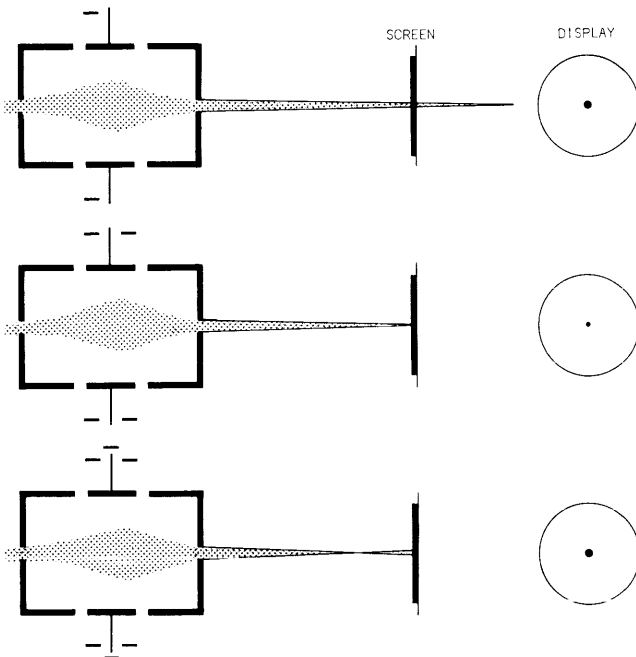

Fig. 5-3. Focus control effects.

5

FOCUS AND ASTIGMATISM LENS

When the electrons pass through the first anode exit aperture they are slightly divergent. The function of the focus lens is to converge these electrons and cause them to focus or cross the axis at the face plate or screen of the CRT. The focus lens consists of the *first anode*, the *focus ring*, and the *second anode*.

focus and
astigmatism

The size and shape of the spot seen on the screen of a CRT is controlled by two front panel controls, *Focus* and *Astigmatism*. These controls adjust the voltages on the elements comprising the focus lens.

lens
field

The equipotential line plot for this lens is shown in Fig. 5-1 and the electron trajectory is shown in Fig. 5-2. Notice that the lens is divergent at first, then the electrons move parallel to the axis, then the lens is convergent. Note that in the first section of the lens the electrons are passing through a decreasing field and are, therefore, decelerated. They are accelerated in the second half of the lens and exit with the same velocity as they had on entrance.

The Focus control on the oscilloscope front panel sets the voltage on the focus ring. The lens effect will become stronger as the voltage on the focus ring is made more negative with respect to the two outside electrodes. The increase in lens strength will shorten the focal length or distance from the lens at which the electrons will cross the axis. The beam is to be focused on the face of the CRT. By changing the focus voltage and thereby the focal length of the lens, the size of the spot on the screen can be adjusted for minimum size (Fig. 5-3).

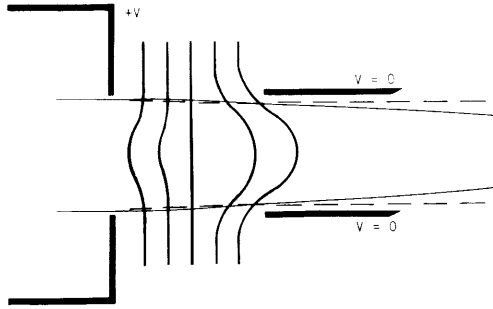

Fig. 5-4. Astigmatism lens.

astigmatism The Astigmatism control on the oscilloscope front panel sets the voltage on the second anode. Between the second anode and the deflection plates which follow, a cylindrical lens is formed (Fig. 5-4 and 5-5). The astigmatism voltage is adjusted for the *roundest* spot on the screen which indicates the lens is correcting for any defocusing that might be present.

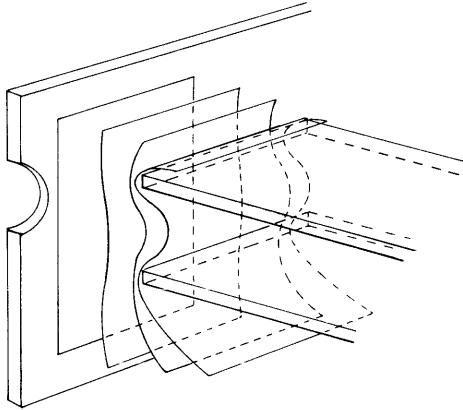

Fig. 5-5. Astigmatism lens.

6

THE DEFLECTION SYSTEM

The purpose of the CRT deflection system is to deflect the electron beam vertically and horizontally with minimum deflection factor and minimum distortion. (Minimum deflection factor is the same as maximum deflection sensitivity.) The system must be mechanically and electrically compatible with the other parts of the instrument.

Fig. 6-1 shows the second anode of the focus lens and a set of vertical deflection plates. (Several assumptions will be made in the following presentation to simplify the subject.) Notice that the potential on the two plates is equal and that they are approximately equal to the second anode potential. An electron's path is shown. After passing the deflection plates no other forces affect the direction or acceleration of the electron. The electron travels in a straight line and strikes the screen near the center.

electrical
center

The *electric center* of a CRT is the point that the beam strikes the screen when the two deflection plates are the same potential. The plates are operated at some DC potential near the second anode voltage. When checking a CRT for its electrical center, the plates should be shorted together (NOT TO GROUND) with a well insulated tool.

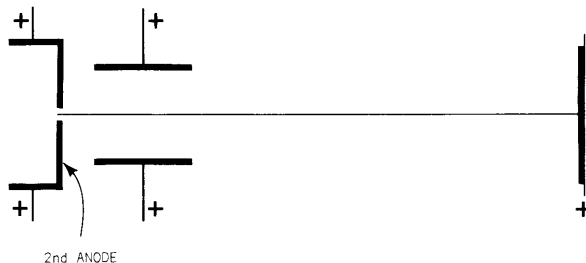

Fig. 6-1. CRT electrical center.

deflection
formula

The deflection above the axis (Y) is directly proportional to the deflection voltage (V_d), the plate length (ℓ), and the distance from the plates to the screen or throw (L). Y is inversely proportional to the distance between the plates (D) and the average deflection plate voltage (V). The formula is:

$$Y \approx \frac{V_d \ell L}{2DV}$$

This relationship is shown in Fig. 6-2.

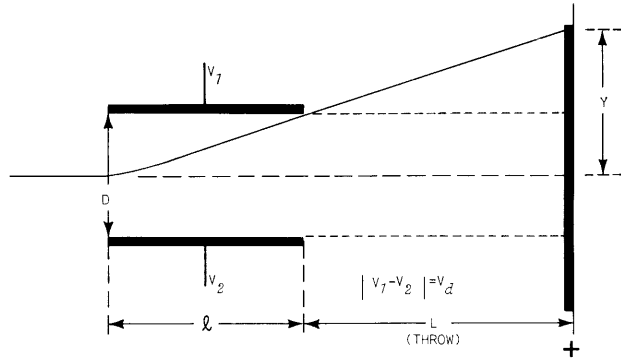

Fig. 6-2. Basic deflection.

deflection
factor

The *deflection factor* (DF) of a CRT is the voltage required for one division of deflection. Volts/cm usually expresses deflection factor. The *deflection sensitivity* (DS) is the number of divisions of deflection per volt difference between deflection plates. The ratio cm's/volt commonly expresses deflection sensitivity.

deflection
sensitivity

$$DF = \frac{1}{DS}$$

Both terms are in general use. However, Tektronix has standardized on the term deflection factor. A high deflection sensitivity and a low deflection factor is desired.

Taking the formula $Y \approx \frac{V_d \ell L}{2DV}$

we see that the deflection sensitivity is

equal to $\frac{Y}{V_d} \approx \frac{\ell L}{2DV}$

and the deflection factor is equal to $\frac{V_d}{Y} \approx \frac{2DV}{\ell L}$.

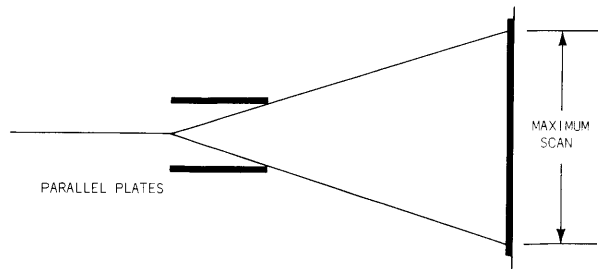

Fig. 6-3. Maximum scan using parallel plates.

scan
limitations

Fig. 6-3 shows a deflection system with parallel plates. The maximum deflection or scan before the beam strikes the plate for a given plate length is shown. The scan could be increased by decreasing the plate length but this would increase the deflection factor or the number of volts per cm of deflecting voltage. The scan could also be increased by increasing the plate spacing but this would also increase the deflection factor. Scan could also be increased by increasing the distance between the end of the deflection plates and the screen, but this would require a longer tube.

Bent plates as shown in Fig. 6-4 would increase the scan while holding most other factors constant. The actual section of the plates act in the same way as has been previously described. The bent section acts like sections of parallel plates with increasing plate spacing and therefore increasing deflection factor. The increased deflection factor can be

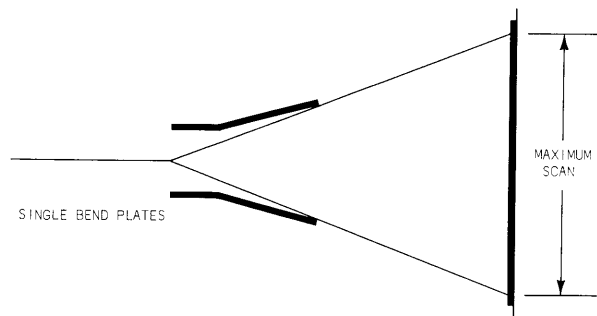

Fig. 6-4. Maximum scan using bent plates.

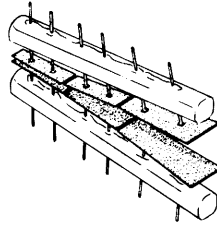

Fig. 6-5. Segmented plates.

overcome by an increase in plate length. In actual construction, the plates may be segmented for ease of construction (Fig. 6-5).

plate
notation

The first set of deflection plates after the focus lens is denoted $D_3 - D_4$ and usually deflects the beam vertically. The next set of plates is denoted $D_1 - D_2$ and usually deflects the beam horizontally. In some tubes horizontal deflection is done prior to vertical deflection but the notation is the same. ($D_3 - D_4$ near the focus lens, $D_1 - D_2$ nearer the screen.)

distributed
deflection

The capacitive load on the amplifier driving a set of deflection plates may be reduced by using distributed deflection. A segmented plate configuration is used with the segments connected by small sections of delay line (Fig. 6-6). The load is now the Z_0 of the delay line and not the total capacitance of the plates. The load is now a constant of about 900 ohms as compared to a regular deflection system where the capacitance is typically 12-15 pF and the load varies with frequency. Distributed deflection may be used in a CRT when it is to be operated at 100 MHz and above.

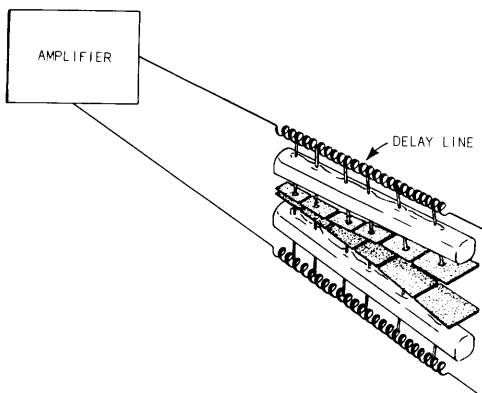

Fig. 6-6. Distributed deflection.

When conventional deflection is used in a CRT, transit-time effect may reduce deflection at higher signal frequencies. If an electron beam is between a set of plates for 2 units of time and the signal on the plates during this time changes from zero volts to ten volts and back to zero volts, the net effect on the beam is less than the ten volts applied. Distributed deflection may be used to reduce this effect by matching the propagation velocity of the delay line to the velocity of the electron beam between the plates. This matching increases the deflection obtained at higher frequencies because an electron passing between the plates is affected by the same signal for the entire transit time.

Consider both propagation velocity and electron beam velocity in a distributed deflection-CRT. For optimum performance the electron velocity (V_e) and signal velocity (V_s) match. The difference in potential between the vertical deflection assembly and the cathode determines electron velocity independent of frequency considerations. Conversely, deflection assembly fixes signal propagation velocity as a function of frequency. Signal velocity diminishes with frequency.

Fig. 6-7 charts the effects of electron beam velocity and signal velocity upon deflection. For both curves:

- (1) V_e greater than low-frequency V_s ;
- (2) V_e equal to low-frequency V_s ;
- (3) V_e slightly less than low-frequency V_s ;
- (4) V_e much less than low-frequency V_s .

Fig. 6-7A plots intercept points where electron beam velocity (V_e) and signal velocity (V_s) match. From these curves one plots Fig. 6-7B.

Curve 1: V_e exceeds V_s . A velocity mismatch occurs over the entire frequency spectrum. Electron beam deflection attenuation begins at a low frequency.

Curve 2: V_e and V_s equal. The mismatch begins at f_0 as the signal velocity curve rolls off.

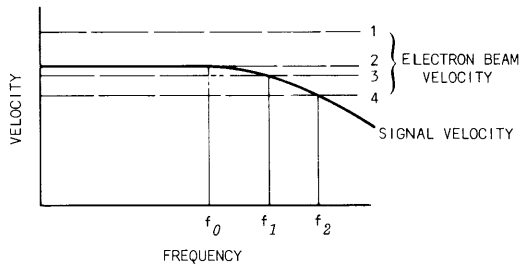

(A) VELOCITY VS. FREQUENCY

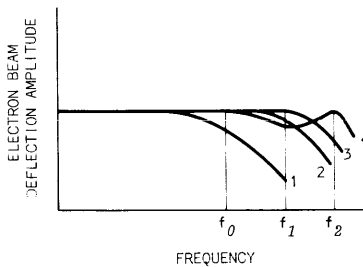

(B) AMPLITUDE VS. FREQUENCY

Fig. 6-7. Propagation velocity versus electron beam velocity in a distributed-deflection CRT.

Curve 3: V_e a little slower than V_s . Velocity match occurs at a higher frequency, f_1 . Consider electron beam deflection on this curve equal from DC to f_1 . Neglect the attenuation between f_0 and f_1 . (Fig. 6-7A shows this attenuation more clearly than Fig. 6-7B.)

Curve 4: V_e much slower than V_s . Velocities match at a much higher frequency, f_2 . However, beam deflection attenuates at frequencies both above *and* below f_2 .

Fig. 6-8 schematically represents the distributed-deflection assembly. Push-pull signal voltage, applied across R1 and R2, travels down the transmission line at a velocity determined by lumped L and C values. Signal energy dissipates in forward terminators R3 and R4. At some upper frequency limit, signal velocity becomes less than electron beam velocity, reducing deflection sensitivity.

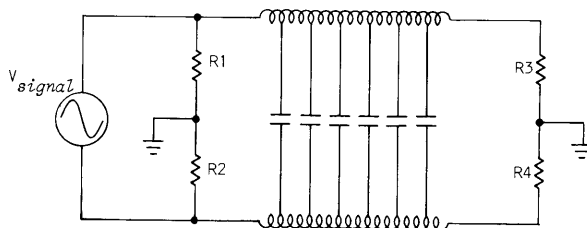

Fig. 6-8. Push-pull distributed deflection schematic.

A CRT capable of vertical response in the gigahertz range (0.35 nanosecond risetime) connects directly to the signal source of interest. Further, CRT construction allows only single-ended deflection. The generally preferred push-pull deflection is preempted by the high frequency response required. Most circuit measurements are taken single-ended. Circuitry, such as a vertical amplifier, then converts the single-ended input signal into push-pull CRT drive. Current state-of-the-art amplifiers do not extend to fractional nanosecond risetime response.

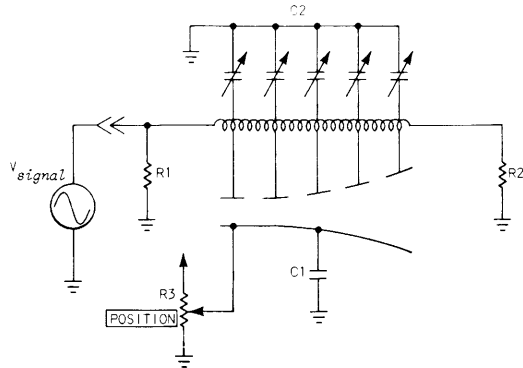

Fig. 6-9. Single-ended distributed deflection.

single-
ended
distributed
deflection

Fig. 6-9 schematically illustrates the single-ended distributed deflection system. Input signals transit the transmission line to dissipate in the forward termination, represented by R_2 . R_1 and R_2 must equal the characteristic impedance of the transmission line. The transmission line consists of a tapped inductance and parallel capacitance at each tap. Adjustable portions of C_2 parallel the upper vertical deflection plate segments.

The lower deflection plate is a single plate. C_1 bypasses the lower plate to ground, allowing application of positional voltages and the entire lower deflection plate surface to represent signal ground.

C_2 provides the capability of calibrating the vertical deflection system. At the frequencies involved, stray reactances become an appreciable portion of the lumped-component transmission line, and capacitance between deflection plates changes from election beam entrance and exit. At the point of beam entry the deflection plates are quite close. Deflection plate coupling then dominates transmission line capacitance. At the beam exit point, the widely separated plates constitute a minor capacitive component. Many upper deflection plate segments, more than shown, occur between electron beam entrance and exit. Each segment and associated inductance make up a short section of transmission line. Each line section must match all other sections. One adjusts C_2 for optimum display of known input waveforms. In practice one tunes the deflection assembly then encloses it in the CRT envelope.

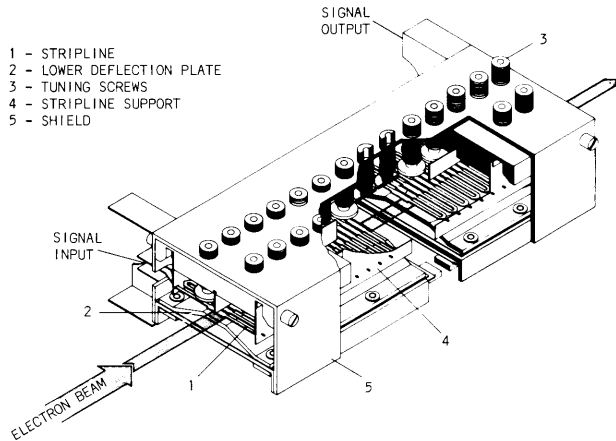

Fig. 6-10. Vertical deflection assembly.

Fig. 6-10 shows a cutaway drawing of this vertical deflection assembly. The upper vertical deflection plate and transmission line consist of a continuous, "S" shaped metal strip called a stripline (1). Stripline shape creates inductance and mechanical strength. Capacitive coupling occurs between the lower deflection plate and the stripline surface. The tuning screws also capacitively couple to the stripline surface, paralleling deflection plate capacitance.

single-
 ended
 drive

In Fig. 6-11 single-ended drive is shown with 6 volts on one plate and 0 volts on the other plate. An electron passing through the second anode aperture is accelerated by the +3 volt equipotential line before entering the deflection region. The electrons axial velocity is *increased* and it gains some radial velocity as it passes through the deflection system and strikes the screen; for example, 2 divisions

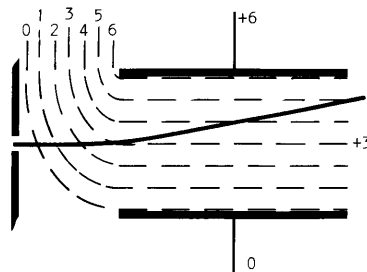

Fig. 6-11. Single-ended deflection.

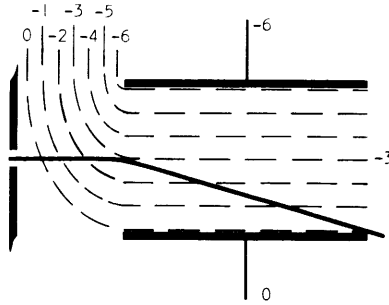

Fig. 6-12. Single-ended deflection.

above center. Fig. 6-12 shows the top plate at -6 volts and the lower plate still at zero. An electron passing through the 2nd anode aperture is *decelerated* by the -3 volt equipotential line before it enters the deflection region and picks up some radial velocity striking the screen; for example 3 divisions below center. This nonlinearity is unacceptable in oscilloscopes and push-pull drive is used to insure linear deflection.

push-
pull
drive

Most oscilloscopes have push-pull drive to both $D_1 - D_2$ and $D_3 - D_4$ because of the nonlinearity of single plate drive. Fig. 6-13 shows a push-pull drive, the voltage between the plates being 6 volts. An electron passing through the second anode aperture sees an equipotential line about equal to the anode voltage. The electron is not accelerated before passing through the deflection system where it gains some amount of deflection (3 volts worth). The beam has been deflected up, say 3 divisions, above center. If the upper plate voltage is changed to -3 volts and the lower plate to $+3$ volts, the beam will be deflected down 3 divisions.

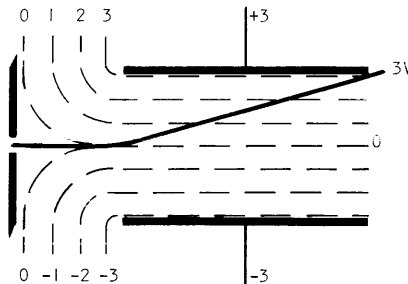

Fig. 6-13. Push-pull deflection.

deflection
linearity

The graphs in Fig. 6-14 show the deflection-linearity characteristics or change in deflection factor for three different CRT's with push-pull drive. The graphs show the percent difference in voltage required to deflect the beam one centimeter at any point on the screen, compared to that required to deflect the beam one centimeter at the axis. Notice that the T5470 has compression while the other two have expansion.

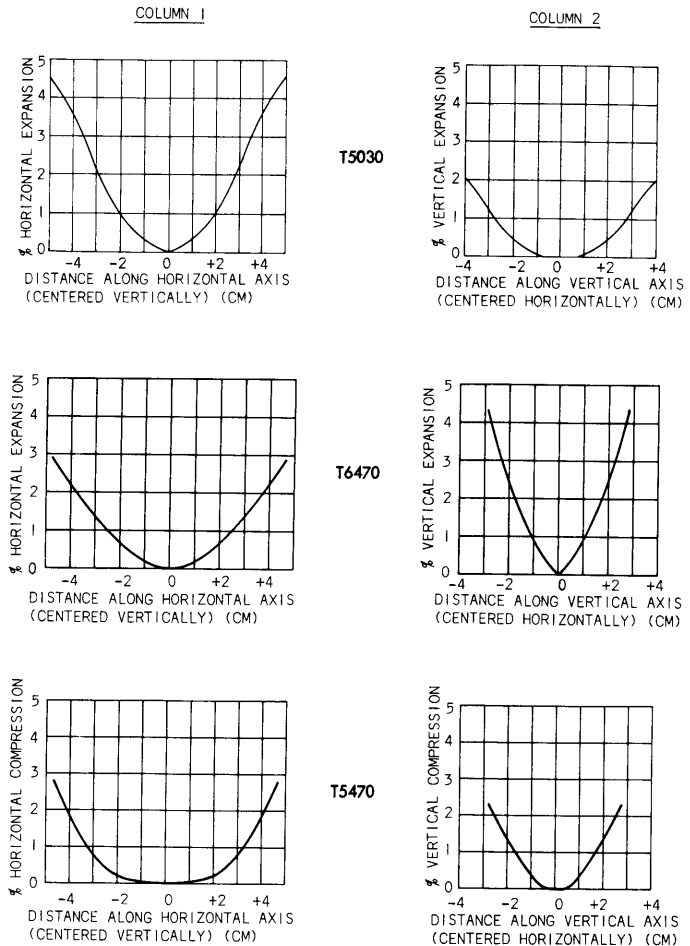

Fig. 6-14. Deflection-linearity characteristics.

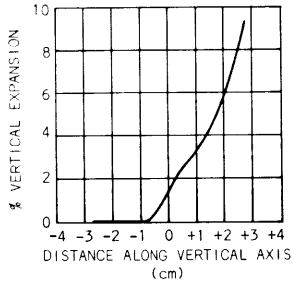

Fig. 6-15. T5470 single-ended deflection.

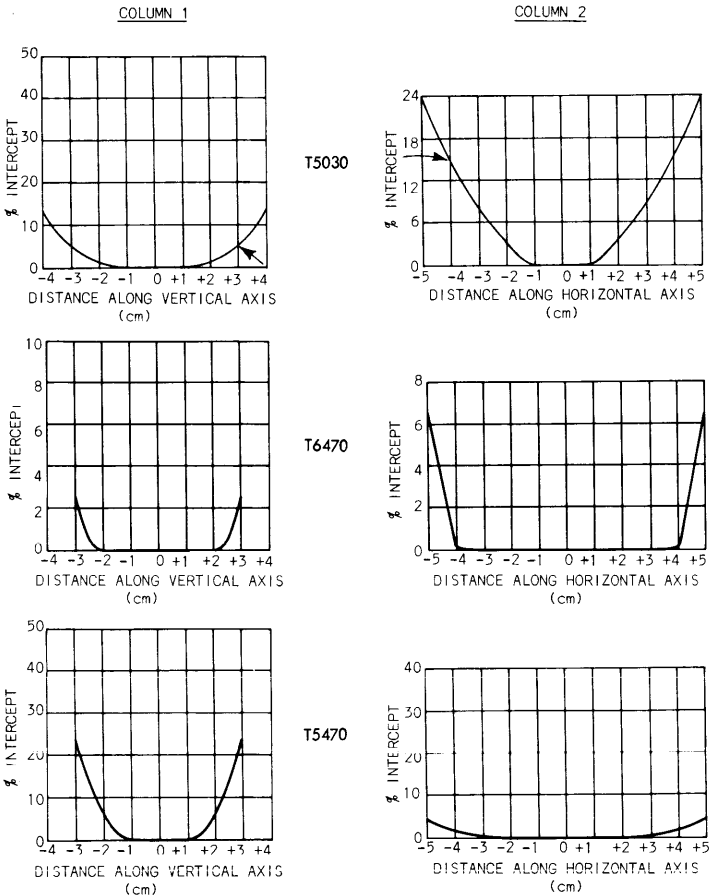

Fig. 6-16. Beam current intercept graphs.

Fig. 6-15 plots single-ended vertical deflection linearity of the T5470. Compare this graph to the T5470 plot of Fig. 6-14. One sees the linearity contrast between push-pull and single-ended deflection.

beam
current
intercept

When an electron beam is deflected near a deflection plate, some of the *beam* electrons are intercepted by the plate. This results in lower beam current reaching the screen and therefore a slight decrease in intensity. The percentage of beam current intercept is different for the vertical and horizontal so each axis must be measured (Fig. 6-16).

Fig. 6-16 column 1 shows the percentage of intercept vs distance along the *vertical* axis. Note that the center of the tube is considered zero, up is positive, and down is negative. Column 2 shows percentage of intercept vs distance along the *horizontal* axis. The center again is zero, left is negative, and right is positive.

These vertical and horizontal graphs *cannot* be easily combined to predict exactly the percentage of intercept for any given location on the screen off the vertical or horizontal axis. The percent of beam current reaching the screen at a given location may be approximated by using the information from the two graphs and the formula:

$$\%I_b \text{ to screen} \approx (100\% - \% \text{ horizontal intercept}) \\ (100\% - \% \text{ vertical intercept}) 0.01$$

A T5030's beam located 4 cm to the left and 3 cm up from center for a Tektronix T5030 would have 15% horizontal intercept and 5% vertical intercept or approximately 81% total beam current reaching the screen. Because of other factors, a 20% intercept does *not* yield a 20% decrease in visual intensity. The formula is less accurate as the percentage of both intercepts increases. The least accurate calculation would be for a beam located near the corner of the screen.

geometric
defocusing

There are two causes of defocusing associated with the deflection plates. *Geometric defocusing* occurs when the beam is focused in the center of the screen. It is focused for some distance and when the beam is deflected the distance to the screen increases but

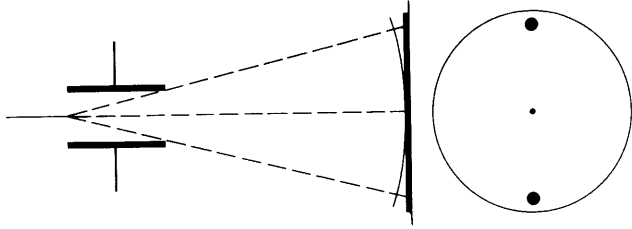

Fig. 6-17. Geometric defocusing.

the focus distance remains the same. The result is a defocusing of the spot. The size of the spot is larger at the top, bottom, and on the sides of the screen than it is at the center of the screen (see Fig. 6-17).

deflection
defocusing

Deflection defocusing is greater (by a factor of about 10) than geometric defocusing. An electron beam has a finite thickness and when it passes close to a deflection plate the electrons nearer the plate are accelerated more than those further from plate. The end product of this effect is defocusing of the beam when it is deflected off center (Fig. 6-18). Deflection defocusing changes the shape of the spot making it oblong vertically when deflected close to a vertical plate and oblong horizontally when deflected close to a horizontal plate.

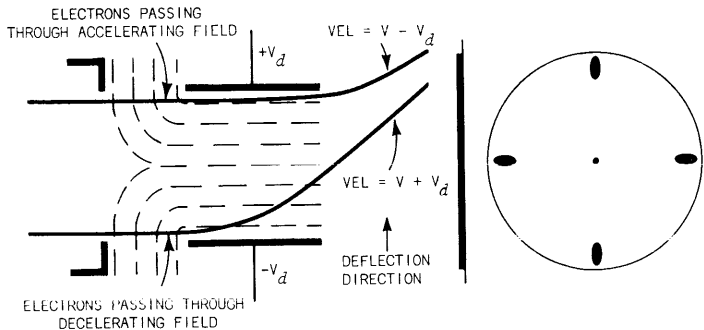

Fig. 6-18. Deflection defocusing.

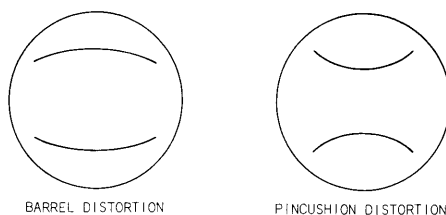

Fig. 6-19. Distortions.

Consider the upper section of the beam. These electrons pass through an accelerating field, increase in velocity, and are then deflected. Their velocity is $V + V_d$. The electrons on the lower side of the beam pass through a decelerating field, decrease in velocity ($V - V_d$), and are then deflected. The slower electrons are between the deflection-plates for a longer period of time and are therefore more affected by the deflecting field.

fringing
fields

geometry
control

The pattern distortion shown in Fig. 6-19 is caused by fringing fields between the deflection plates and the band of conducting Aquadag on the glass envelope of the tube in the region of the $D_1 - D_2$ plates. The geometry control sets the voltage on this neck Aquadag and on the isolation shield. (In some tubes the geometry control also sets the voltage on the deflection-plate shields which are indicated on the sides of the $D_1 - D_2$ plates. See Fig. 6-20.) The geometry control is adjusted for an unbowed display.

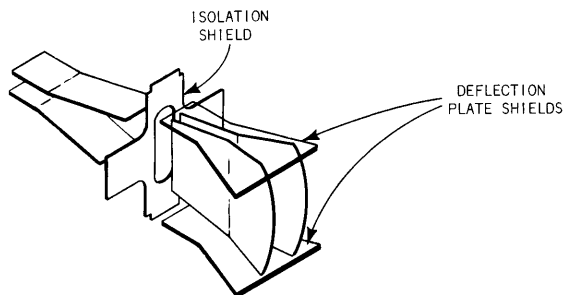

Fig. 6-20. Deflection system (physical).

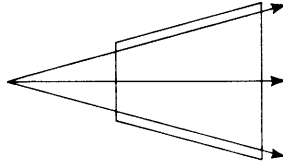

Fig. 6-21. Uncorrected plates.

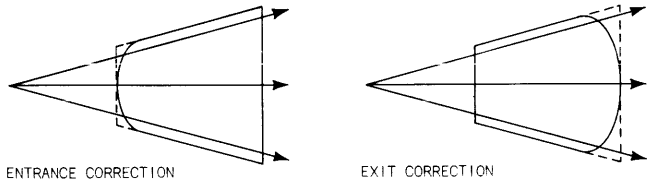

Fig. 6-22. Plate corrections.

path length
correction

The beam may be deflected prior to passing between the $D_1 - D_2$ plates (Fig. 6-21). The path length within the plates for a deflected beam is different than for an undeflected beam and if the shape of the plate is not altered, a geometric distortion results. Fig. 6-22 shows entrance and exit correction for this problem. With correction, a deflected beam is affected the same as an undeflected beam.

total
defocusing

The total amount of defocusing from geometric and deflection sources can be measured and shown graphically as in Fig. 6-23. Column 1 shows the increase in trace width with the beam centered vertically for a given amount of horizontal deflection. Note that the curves are for various beam currents.

The amount of defocusing is not the same for both the vertical and horizontal axis; therefore, separate graphs must be used. The graphs in column 2 are for beams centered horizontally and deflected vertically.

Recall that the deflection of an electron beam above or below the axis is a function of, among other things, the distance from the deflection plates to the screen. If the tube length must be short, the angle of deflection must be larger to yield a given scan.

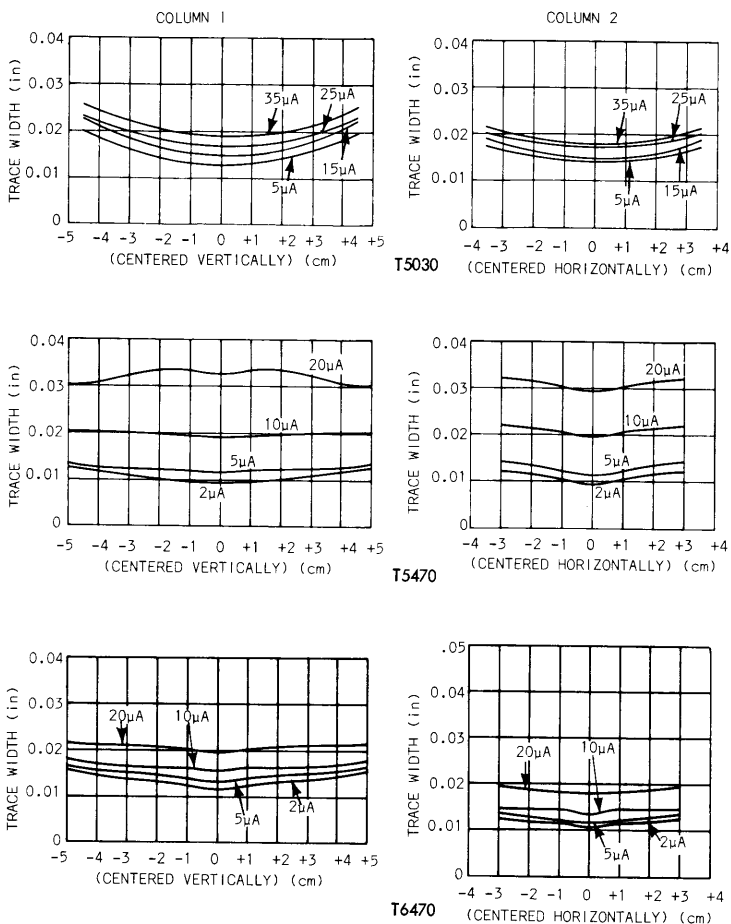

Fig. 6-23. Trace width graphs.

When an electron beam must be deflected through a wide angle, *electrostatic* deflection has limitations. These limitations are linearity and edge defocussing. These problems may be overcome by using magnetic deflection but the trade off of lower bandwidth is necessary.

magnetic
deflection

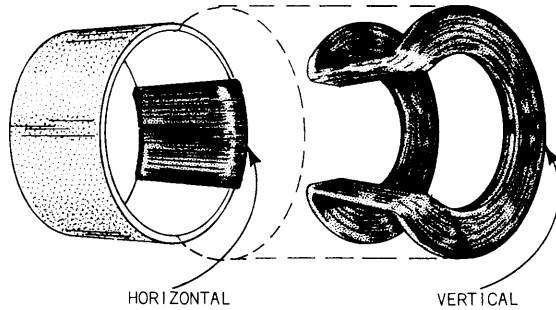

Fig. 6-24. Deflection yoke.

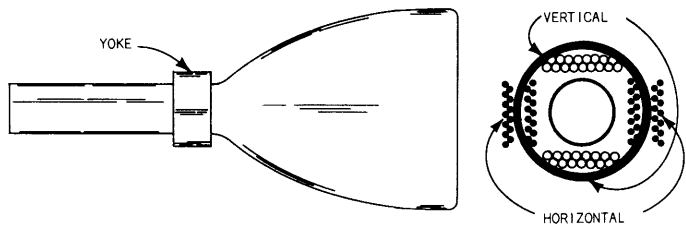

Fig. 6-25. Yoke position.

yoke
deflection
coils

Fig. 6-24 shows the deflection yoke used in the Tektronix 410 physiological monitor. The horizontal deflection coils are wound around the core. The vertical deflection coils are fitted inside the core. Magnetic deflection is used in this instrument to give the maximum amount of deflection with the shortest tube in length.

The yoke is positioned around the neck of the CRT as shown in Fig. 6-25.

The magnetic fields created when current is passed through these deflection coils is shown in Fig. 6-26.

If an electron is propelled through a magnetic field such as shown in Fig. 6-26, the electron will feel a force that is normal to the direction of the field. This force causes the deflection. The direction of the field determines the direction of deflection and the strength of the field determines the amount of deflection. The strength of the field is a function of the amount of current in the deflection coils, the number of turns in the coil, and the physical dimensions and location of the yoke. The direction of the field is a function of the direction of the current through the coils.

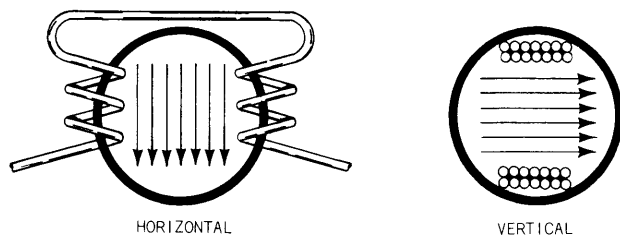

Fig. 6-26. Deflection coil magnetic fields.

direct
connection
to plates

Occasionally an oscilloscope user monitors signals by connecting circuits of interest to vertical deflection plates through a simple coupling network. He does this to extend his frequency measurement capabilities. Tektronix CRT vertical frequency response curves follow the general shape of Fig. 6-27. The coupling network included allows predictable displays. R_{out} , R_1 and R_2 match the voltage source impedance. Coupling capacitors C_1 and C_2 block DC since source voltage usually fails to match average deflection plate voltage.

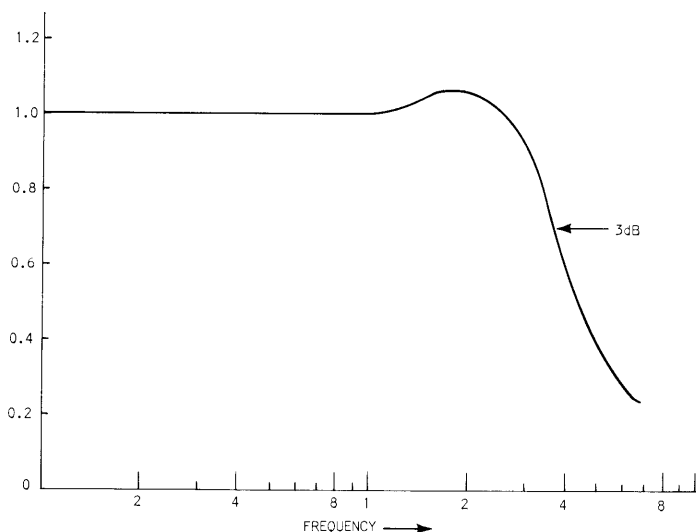

Fig. 6-27. Frequency response relative output vs. frequency.

Disturbing average deflection plate voltage creates geometry problems. Additionally, maximum voltage ratings between electrodes must be observed. Each type CRT has design maximum value ratings and the excerpt below is an example:

Average deflection plate voltage, 2000 volts DC maximum.

Astigmatism electrode voltage, 2000 volts DC maximum.

Peak voltage between astigmatism and/or any other deflection electrode, 500 volts DC maximum.

Notice the circuit of Fig. 6-28 indicates push-pull drive. Many measurements are single-ended, therefore not related to the response curve shown.

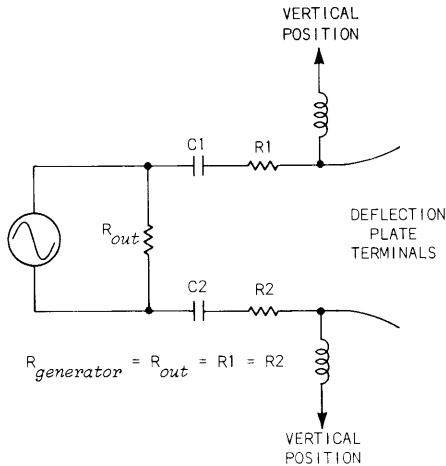

Fig. 6-28. Direct connection network.

7

ACCELERATION SCHEMES

- mono-accelerator In a monoaccelerator tube the electrons are accelerated between the cathode and the first anode. The focus lens decelerates and then accelerates the electrons back to their entrance velocity and its overall effect on acceleration is zero. Once the electrons have passed the second anode of the focus lens in a monoaccelerator, no other force is applied to change their axial velocity.
- light output versus accelerating voltage The light output from a phosphor increases approximately as the voltage through which the beam electrons have been accelerated. In a monoaccelerator CRT this is the voltage difference between the cathode and the first anode, or approximately 3-4 kV. Frequently the light output from the CRT screen in a tube of this type is too low to produce a visible display of a fast risetime or high frequency signal. The specification sheet for a CRT may not state that the tube is a monoaccelerator. If the acceleration voltage is only 3-4 kV, it is probably a monoaccelerator. The exception would be a CRT using a low helix-voltage.
- increasing light output The light output could be increased by increasing the gun voltages, but this would increase the deflection factor. An increase in plate length would decrease the deflection factor but for a 6 to 1 increase in the *acceleration potential*, the plates would protrude beyond the screen of the CRT. Other than the bulky size of the plates, the capacitance between the plates would increase enormously and the use at high frequencies would be lost.

post deflection acceleration

In order to overcome the problem of low light output, various schemes are used where the beam's electrons are kept at a relatively low voltage in the deflection region and then accelerated after deflection to a higher energy level. This concept of acceleration is called post deflection acceleration and is abbreviated PDA or just "post." Monoaccelerator tubes are referred to as just "mono." The main advantage of a post vs a mono is higher light output for viewing fast signals.

Aquadag accelerating bands

A monoaccelerator tube usually has a conductive coating or Aquadag on the inside of the tube from the deflection plates to the face plate. In some early PDA CRT's this coating was split into regions by an insulating gap (Fig. 7-1). Each band had a different potential and accelerated the electrons in what had been the electron drift region. Because the acceleration occurs after deflection, the tube's deflection factor is not as adversely affected as in a monoaccelerator which has the same overall accelerating potential. The equipotential lines in Fig. 7-1 show the lens action of this type tube. This type tube suffered from distortion and compression.

helix

An innovation by Tektronix was to make a continuous electron lens over the entire funnel by using a helically-wound resistive material in place of the Aquadag coated surface separated by insulated gaps. The type tube shown in Fig. 7-2 is called a helix PDA tube. This type of tube has compression but not as severe as the wall-band Aquadag type.

The helical post system allows the gun and deflection sections to be operated at lower voltages than a mono tube. The lower operating voltage reduces the velocity of the beam in the deflection region and is an aid to better deflection sensitivity. After the beam has been deflected it is then accelerated between the $D_1 - D_2$ plates and the screen.

compression

When a helix is used the electrons are accelerated after being deflected but compression reduces the scan and deflection sensitivity (Fig. 7-2). Notice the equipotential lines are convex from the $D_1 - D_2$ plates until over halfway to the screen. The electrons which do not enter perpendicular to the field lines, therefore, are bent toward the axis. Near the screen the electron velocity is such that the weak diverging field has little effect.

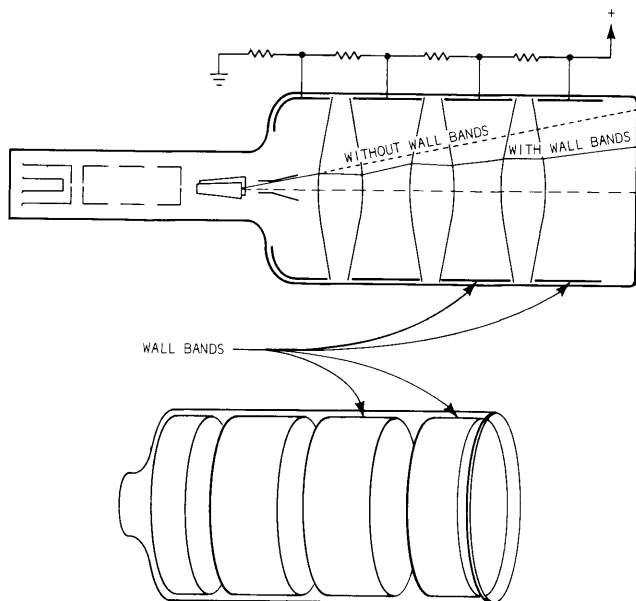

Fig. 7-1. Aquadag applied as wall bands.

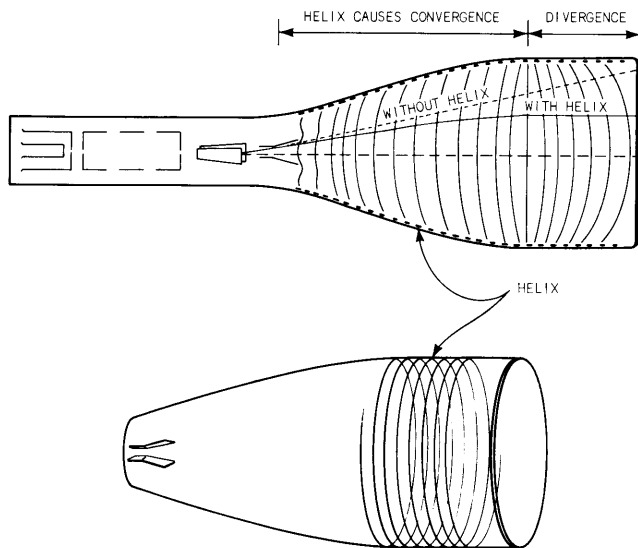

Fig. 7-2. Helix PDA tube.

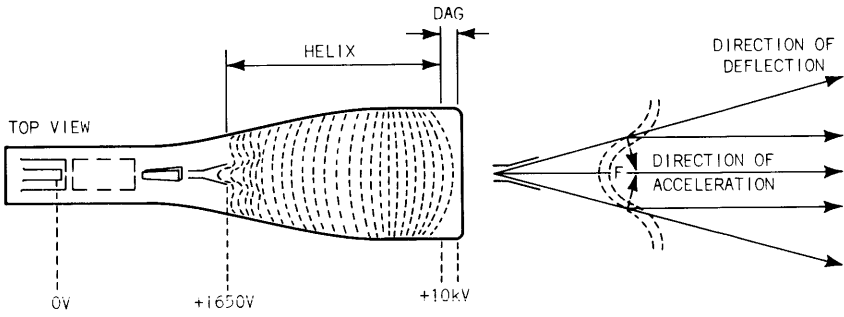

Fig. 7-3. Helix compression.

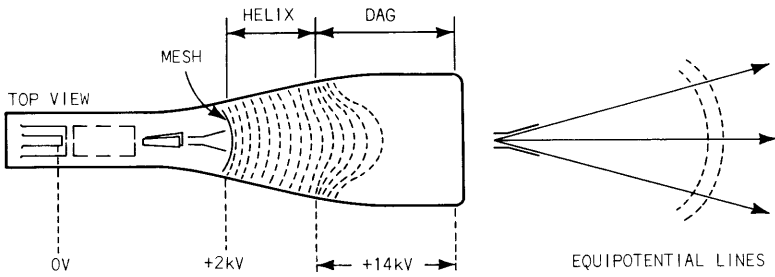

Fig. 7-4. Mesh-type CRT.

light output The overall acceleration potential using a helix PDA is usually 10 to 14 kV. The increase in light output more than offsets the disadvantage of compression. A typical tube might have a scan compression factor of 1.7:1 for the vertical and 2.1:1 for the horizontal deflection.

spot size Compression effects are not all bad. Since the beam passes through a convergent field, not only is scan reduced but also spot size.

mesh A helix PDA tube has compression due to the convergent action of the field (Fig. 7-3). This compression can be eliminated by a mesh located just past the $D_1 - D_2$ deflection plates. This mesh forms a radial accelerating field (Fig. 7-4). The combination of the mesh and the voltage distribution formed by the helix produce *concentric spherical* equipotential surfaces (Fig. 7-4).

The mesh is a field-forming electrode. The electric field is then radial from the center of the deflection plates and little compression takes place. (The electrons pass normal to the equipotential surfaces and therefore increase in velocity. The path of the electrons continue in a straight line.) This system allows electrons to be accelerated without helix compression. Since the electrons travel in a straight line after deflection, the scan and deflection factor are about the same as the monoaccelerator tube.

beam current reduced This system suffers, however, from part of the beam current being intercepted by the mesh. The mesh is at a positive voltage and since it is a conductor it will collect electrons when struck by the beam. This reduction in beam current offsets somewhat the hoped-for increase in light output. The mesh may intercept between 30-50% of the available beam current and since compression is no longer present, the spot size increases.

spot size increased

The advantage of lower deflection factor is traded for an increased spot size and decreased light output for the same accelerating potential. It is usual, though, to increase the accelerating voltage in a mesh tube to regain the light output lost to collection by the mesh, especially since little compression occurs as the voltage is increased.

magnifier
or scan
expansion
CRT

The need for shorter CRT with low deflection factor, motivated development of the magnifier or scan expansion tube. Reduced deflection factor (magnification) results from the effects of a mesh, or frame grid, on the force lines of a PDA CRT using a single, continuous, post deflection anode. The mesh distorts the normal force lines into a cone, creating a divergent lens (Fig. 7-5). This lens action causes expansion. Controlled expansion produces a CRT with lower deflection factor.

In Fig. 7-5A, conductive material surrounds the inner CRT wall, extending from the face plate to a point ahead of the deflection plates. The mesh appears in a plane between the deflection plates and conductive coating termination. Force lines emanate from the rear coating edges because the conductor completely surrounds the CRT bottle with equal voltage. Remove the mesh and this field develops approximately as the force lines nearest the deflection plates in Fig. 7-3. In place, the mesh shapes the field into a divergent lens.

Fig. 7-5B depicts the deflection magnification effect upon an electron beam. This technique reduces deflection factor to realize as much as X2 deflection magnification.

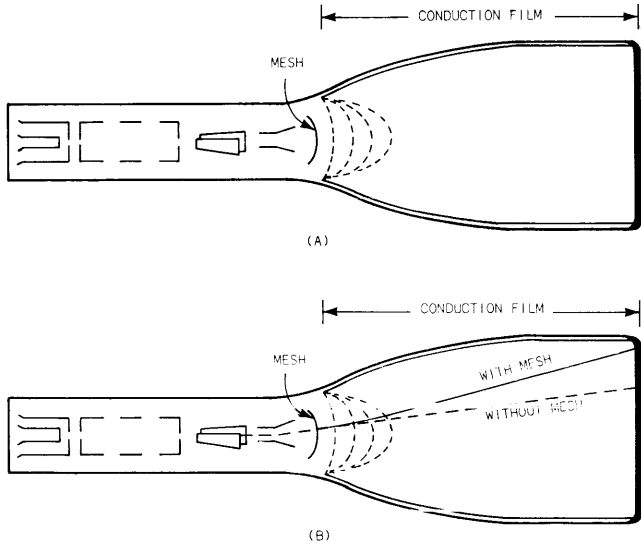

Fig. 7-5. Mesh-type PDA CRT.

mesh
shadow

In any tube using a mesh, a shadow pattern can be seen on the screen when the spot is defocused. This shadow is not seen when the scope is operated in the normal mode.

mesh
construction

The field-forming electrode configuration may be either *mesh* or *frame-grid*. The mesh tube has a structure with conductors running in both planes -- similar to wire gauze. Its chief advantage is that it may be curved in both planes to obtain the desired field curvature. The major disadvantage is that it intercepts more of the beam current (30-50%) and defocuses the spot in both X and Y axis. The frame-grid has conductors running in only one direction and intercepts substantially less beam current (15-30%).

frame-
grid

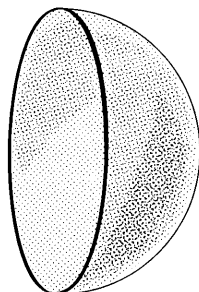

MESH

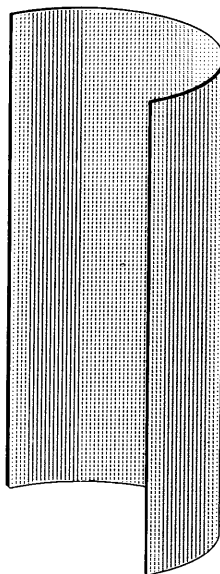

FRAME-GRID

Fig. 7-6. Mesh/frame-grid construction.

80

SPACE CHARGE REPULSION EFFECT AND TRACE WIDTH

charge
repulsion

Beam spot size on the CRT screen is affected by space charge repulsion in the beam. Electrons, being negative charges, tend to repel each other. When many electrons are formed into a beam, the higher charge density results in greater repulsion. As the current density increases, so does the repulsion effect.

charge
density

Fig. 8-1 shows a beam of electrons passing between two plates. From the cross section of the beam it may be seen that the electrons on the outer edges are being repelled by the electrons in the inner part of the beam. Fig. 8-1 shows the expansion that would occur for a given potential difference between the plates. The potential determines the velocity

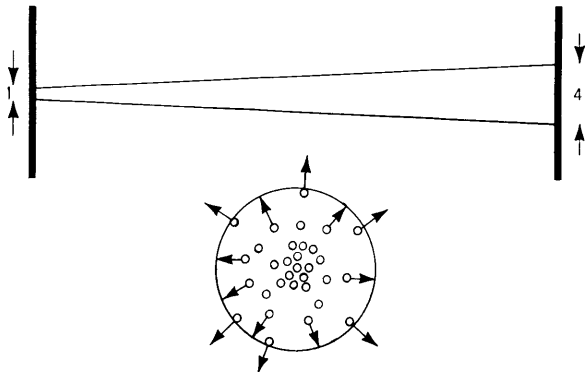

Fig. 8-1. Charge repulsion.

and therefore the time the beam is between the plates. If the potential difference is increased, the time is reduced and the space charge repulsion has less time to affect the beam (Fig. 8-2).

A monoaccelerator tube has a high space charge density in the drift region and the beam has a constant velocity. The spot size of the beam at the screen is large, due to space charge repulsion. In a PDA tube the beam electrons are accelerated after deflection. With the increase in electron velocity there is a reduction in the beam expansion due to space charge repulsion (Fig. 8-2).

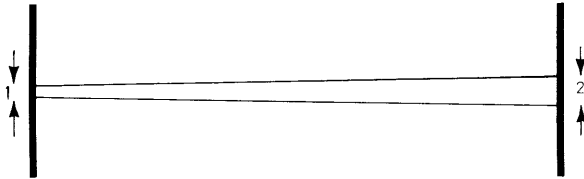

Fig. 8-2. Effects of charge repulsion.

beam
current
and
space
charge

An increase in grid drive also increases beam current, space charge density, and the effects of space charge repulsion. A change in grid drive changes the size of the crossover (between grid and acceleration anode). The spot on the screen is the image of the crossover and an increase in the size of the object (the crossover) will yield an increase in size of the image (the spot on the screen).

The graphs in Fig. 8-3 show the increase in trace width for increasing grid drive for three different tubes. The data used for these graphs is for a centered, best focused spot. At the low end, the increase in trace width for increasing grid drive is primarily due to the increase in crossover size. At higher grid drives, space charge repulsion within the beam between the gun and the screen is the prime cause.

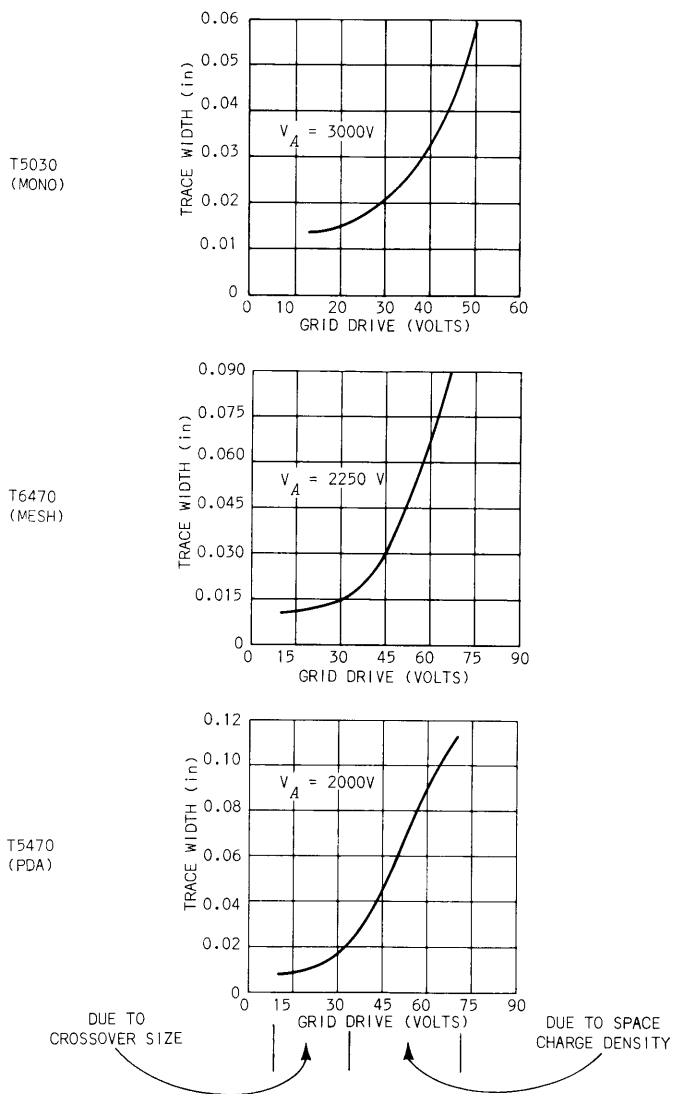

Fig. 8-3. Grid drive vs trace width.

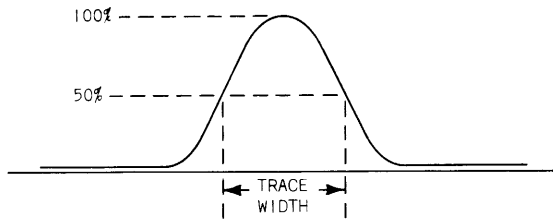

Fig. 8-4. Gaussian distribution of trace width.

trace
width

The term "trace width" has been used in a general sense without definition. A line or spot on a CRT is not uniform in brightness but is brightest in the center and decreases in brightness toward the edges. The distribution of the electrons in the beam causing the trace or spot are concentrated in the center and the density decreases toward the edges. This variation in brightness presents a problem in answering the question, "how wide is the trace?"

shrinking
raster
technique

A solution (though not the only one) is to assume the distribution is Gaussian (Fig. 8-4) and use a shrinking raster method of making the measurement. This method requires a raster (our example uses 11 lines -- Fig. 8-5). The measurement is made by shrinking the raster down until the 50% points of brightness on two adjacent lines merge. This 50% point is achieved when the dark line between the traces first disappears. The width of the raster

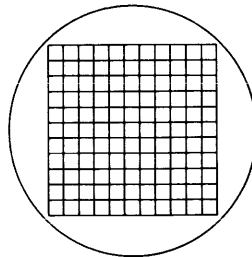

Fig. 8-5. Raster to measure trace width.

is measured and the resultant trace width is $1/11$ of the width. This yields a trace width measured between the 50% brightness points (Fig. 8-6). All CRT data is taken by this method.

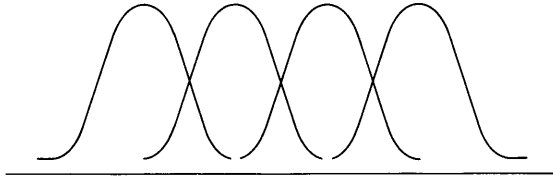

Fig. 8-6. Trace width measurement using 50% brightness points.

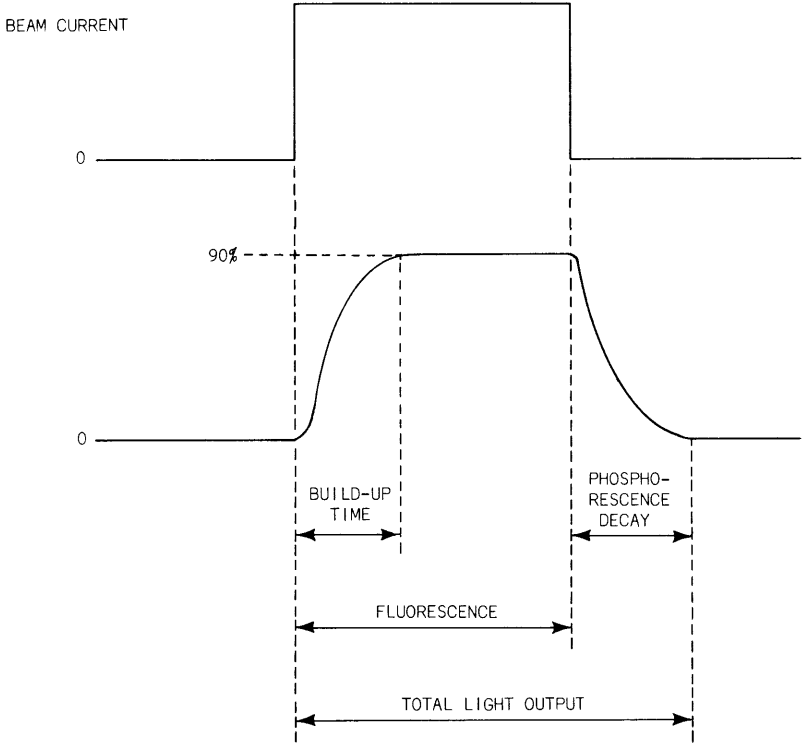

Fig. 9-1. Phosphor terms.

9

PHOSPHORS

The luminance or brightness of a phosphor is dependent upon the phosphor and the accelerating potential. When considering this characteristic, the measurement system's acceleration potential should be stated. All of the data presented here assumes a 10 kV acceleration potential, except where noted.

When the electron beam strikes the phosphor covered screen of a CRT, light and heat are emitted. The light is of primary interest, but the presence of heat and the possibility of burning the phosphor must also be considered.

luminescence The light output has several characteristics that should be considered. *Luminescence* is the production of light when a material, such as phosphor, is excited with a source of energy. The luminescence of a phosphor or its total light output is usually divided into two parts. Fig. 9-1 shows the waveform exciting a phosphor and the total light output. The light produced *while* the source of energy is applied is known as *fluorescence*. The light produced *after* the source of energy is removed is known as *phosphorescence*. A phosphor usually displays both fluorescence and phosphorescence. (The first 10 ns of phosphorescence is sometimes considered to be fluorescence.)

fluorescence,
phosphores-
cence

build-up
time If a phosphor is suddenly excited by an electron beam, it requires some finite time for the light output to reach a constant level. The time required to reach 90% of that constant level under specified excitation conditions is called the *build-up* time of the phosphor. The build-up time of some phosphors is dependent upon the conditions of excitation. Build-up time will be appreciably shorter if the beam current density is increased.

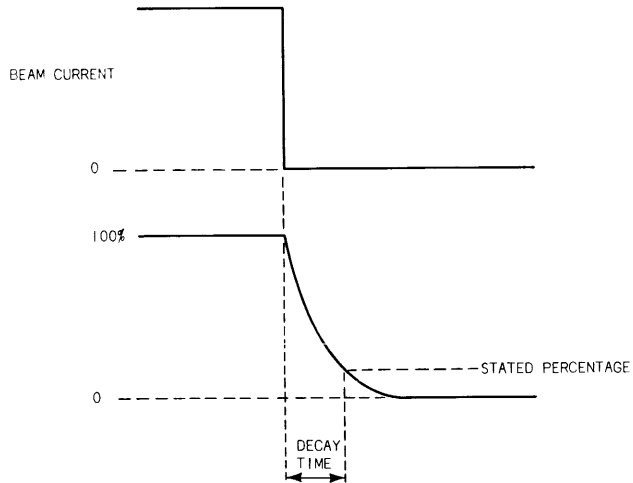

Fig. 9-2. Decay time.

decay
time

When the excitation is instantly removed from a phosphor, an interval of time is required for the light output to drop to a low level. This time is known as *decay* time and is usually expressed as the time required for the light output to drop to a certain percentage (usually 10%) of the original luminance level (Fig. 9-2). The decay characteristic is sometimes termed persistence.

The decay time of some phosphors is linear with respect to time and some follow an exponential decay. For this reason decay curves are available for each phosphor.

decay
considera-
tions

The decay time of a phosphor must be considered for both visual and photographic applications. When visually viewing a slow sweep, a long decay phosphor with its "after glow" (phosphorescence) will allow the observer to see what has gone on even after the sweep has past a given point. When a display is photographed, a long decay phosphor might fog the film, or the display from a previous sweep may still remain. For photographic use, a medium or medium-short decay phosphor is used for best results. For most applications a medium decay phosphor such as P31 is the best compromise. Oscilloscopes generally have P31 or P2 as a standard phosphor; however, many other phosphors are available on special order.

10

HUMAN EYE RESPONSE

wavelength
response

An important factor in selecting a phosphor is the color or radiant energy distribution of the light output. The human eye responds in varying degrees to light wave length from about 400 to 650 nanometers or from deep red (650 nanometers) to violet (400 nanometers). The human eye is peaked in its response in the yellow-green region at about 555 nanometers and falls off on either side in the orange-yellow area to the right and the blue-violet region to the left (Fig. 10-1). The eye is not very receptive to deep blue or red.

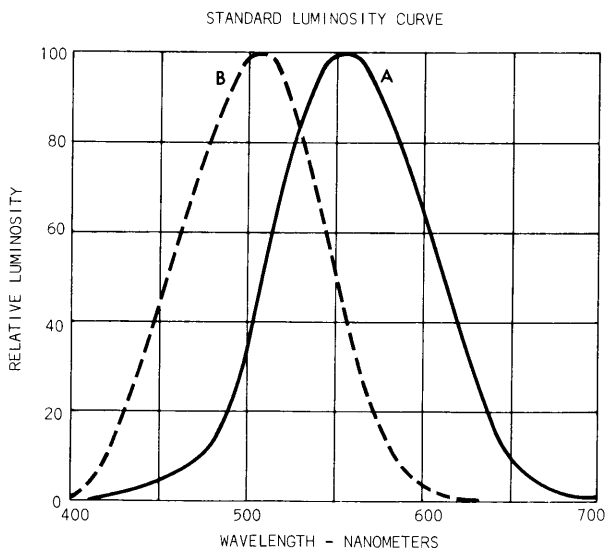

Curve A: 1924 CIE Photopic Luminosity function. Represents relative sensitivity of the average human eye to various wavelengths of radiant energy under good lighting conditions.

Curve B: 1951 CIE Scotopic luminosity function for young eyes (under 30 years of age). Represents relative sensitivity of the average young dark-adapted eye near the threshold of extrafoveal vision.

Optical Society of America, Committee on Colorimetry, "The Science of Color", Thomas Y. Crowell Company, 1953, p. 225.

Fig. 10-1. Standard luminosity curve.

eye response If the quantity of light falling on the eye is doubled, the brightness "seen" by the eye does *not* double. The brightness of a color tone as seen is approximately proportional to the log of energy of the stimulus.

The response of the eye to various colors is believed to be due to the construction of the eye. One theory is that the cones of the retina respond to color stimuli and that each cone consists of three receptors. Each receptor is believed to respond to a different wave length of visible light; a yellow-blue, a red-green and a black-white receptor. An average can be taken of the color response of many people and a "standard" response curve for an average person, as shown in Fig. 10-1, can be compiled.

CIE The term *luminance* is the photometric equivalent of brightness and is based upon measurements made with a sensor having a spectral sensitivity curve corrected to that of the average human eye. The unit commonly used for luminance measurements is the foot lambert. The term *luminance* implies that data has been measured in a manner, or has been so corrected, to incorporate the CIE standard eye response curve for the human eye. CIE is an abbreviation for "Commission Internationale de l'Eclairage" (International Commission on Illumination). The luminance graphs and tables are therefore useful *only* when the phosphor is being *viewed visually*.

standard chromaticity chart The color of a phosphor or any visible color may also be described by a standard chromaticity chart as shown in Fig. 10-2. The bounded area includes all real colors perceptible to the average human eye. The numbers indicated along the periphery are the wavelengths in nanometers of the spectral colors. The center area is white, with color purity (saturation) increasing toward the periphery. The point marked *CIE Illuminant "C"* is the standard representation of average daylight.

The transition from one color to the next is gradual rather than sharply defined as shown. The divisions used on the chart have been standardized to aid in designation of colors by name. Any visible color can be specified by an X and Y coordinate.

P7	P11	P15	P31
X = 0.191	X = 0.151	X = 0.205	X = 0.248
Y = 0.159	Y = 0.083	Y = 0.380	Y = 0.556

brightness The terms *brightness*, *hue*, and *saturation* are often used when referring to light or color. Hue indicates the wavelength of a color or its position in the color spectrum. Hue does not change with luminance, for no matter how dim or bright the light its hue remains the same. A saturated color or pure color is one that does not contain any white light. When white light is present the color is said to be desaturated (as a pastel color).

hue

saturation

On the standard chromaticity chart, the colors around the border are pure or saturated (contain no white light). The saturation decreases towards the center of the chart.

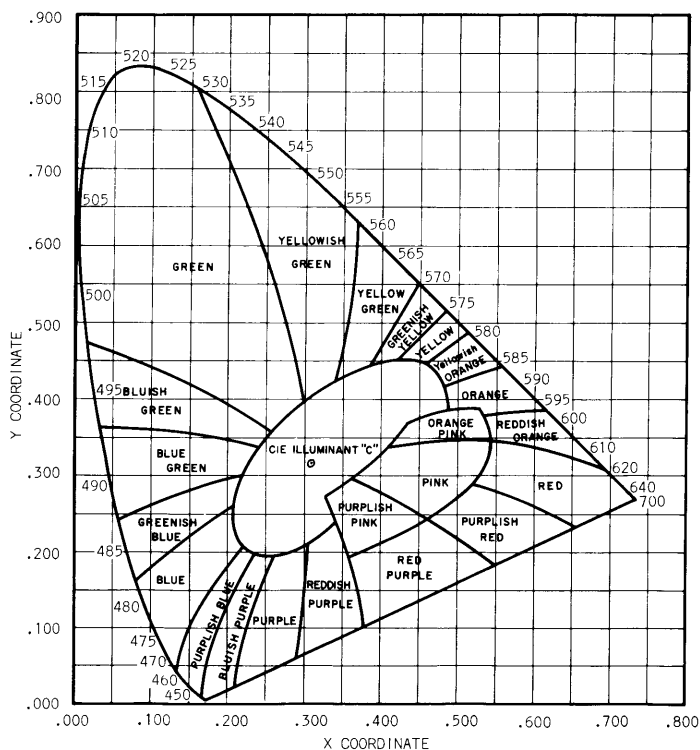

Fig. 10-2. Standard chromaticity chart.

LUMINANCE CHARACTERISTICS OF PHOSPHORS

factors
determining
luminance

The luminance of a phosphor is dependent on several variable factors. If beam current is increased or the same amount of beam current is concentrated in less area by reducing the spot size, there will be an increase in luminance. An increase in accelerating potential will yield an increase in luminance. The luminance is also a function of the time the beam strikes a particle of phosphor; therefore, sweep speed and repetition rate will affect this characteristic.

The graphs in Fig. 11-1 are compiled from measurements taken with a Spectra Brightness Spot Meter observing a 0.250 inch diameter area of a 2 x 2 cm, 135 line, focused raster. Notice that the horizontal scale of the graph is in average current density ($\mu\text{A}/\text{cm}^2$) and the vertical is in luminance (foot-lamberts). These graphs may be used for comparing the luminance of one phosphor with another when all other factors are equal.

Average beam current density can be found using the formula:

$$\text{average beam current density} = \frac{\text{beam current} \times \text{duty cycle}}{\text{trace length} \times \text{spot size}}$$

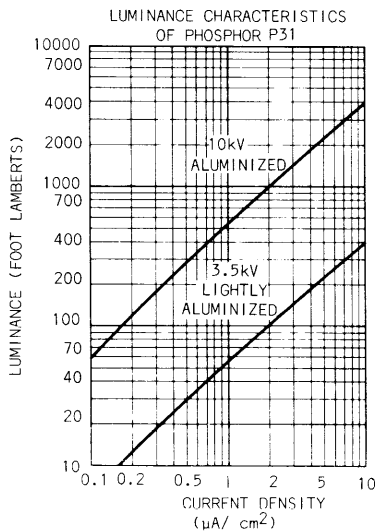
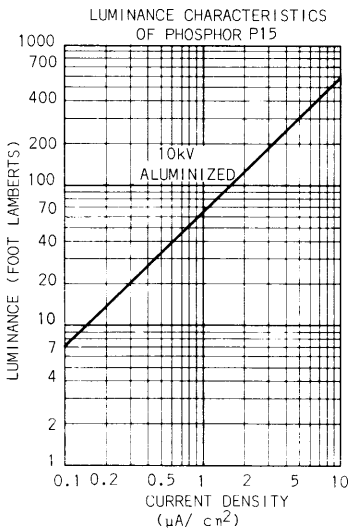
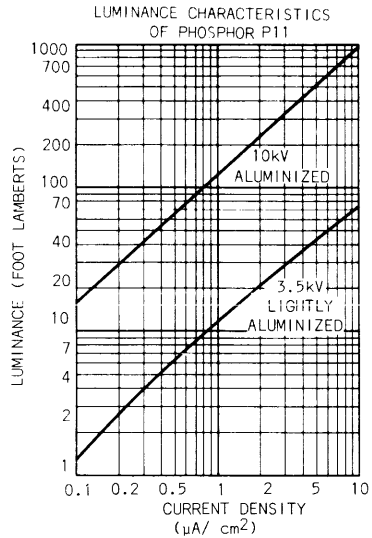
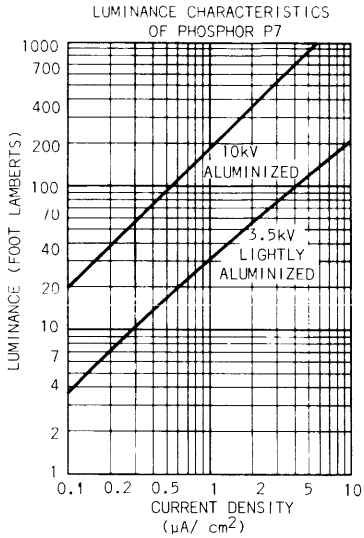
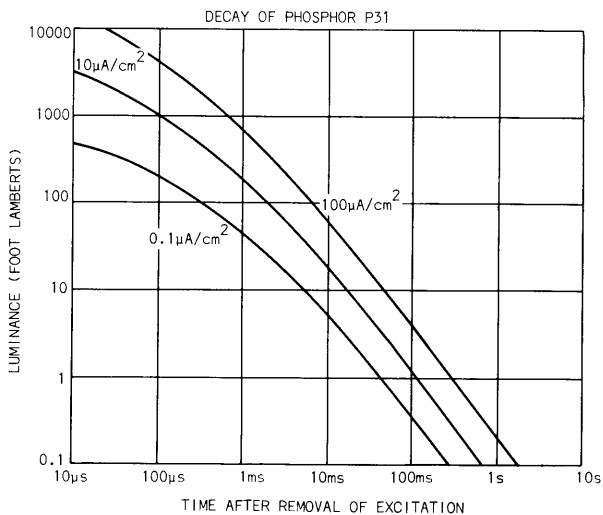

Fig. 11-1. Luminance graphs.

luminance
comparisons

When someone asks "how bright is the display on my oscilloscope?", the question can have two meaningful answers. The first answer is a relative one and is in terms of how much brightness there is as compared to another phosphor. P31, for example, is about 5 times as bright as P11 to the eye. But just *how* bright in quantitative terms requires an absolute answer which is difficult to arrive at due to the variables listed above. For this reason most luminance data is in relative terms.

The decay chart in Fig. 11-2 can be used to find the time required for a phosphor to decay to an *absolute luminance level* for a given beam current density. Notice that higher beam current density results in higher original luminance and longer decay times.



BUILD UP: Approximately 500 microseconds to 90% at $10\mu\text{A}/\text{cm}^2$.

DECAY: Essentially power law, somewhat dependent upon excitation conditions.
Measured using tube type T5470 at 10kV and 5ms excitation pulse.

Fig. 11-2. Luminance decay curves.

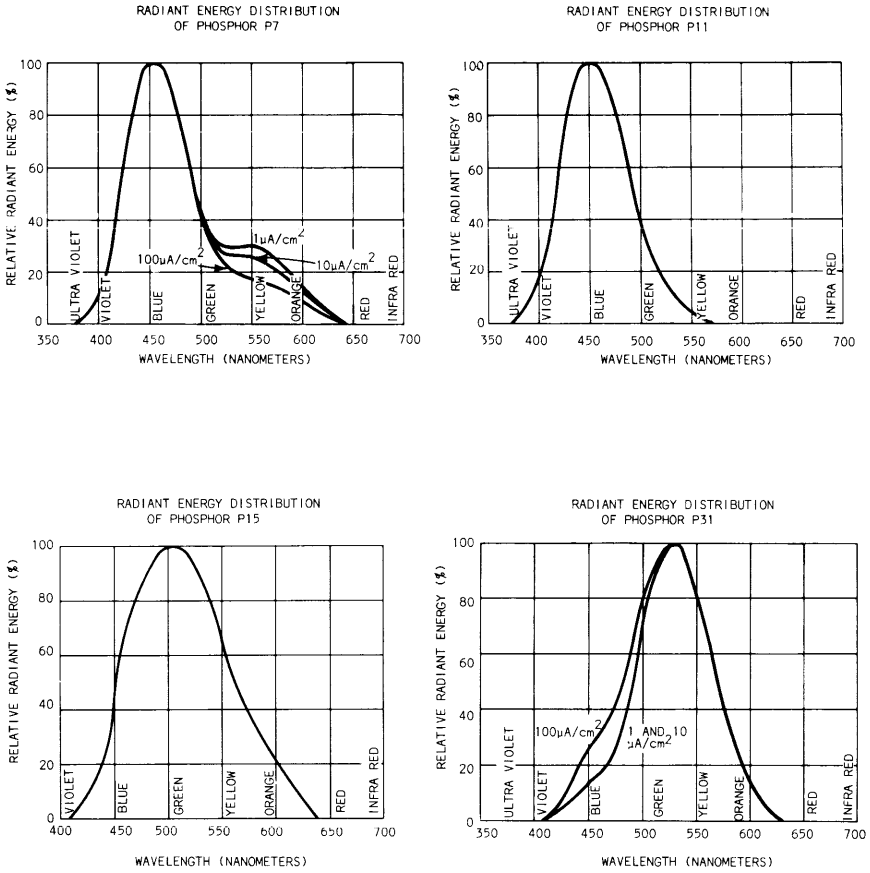

Fig. 12-1. Radiant energy distribution of P7, P11, P15, P31 phosphors.

12

SPECTRAL RESPONSE

emission
character-
istics

The color of the light output or radiant energy emission characteristics of several phosphors is shown in Fig. 12-1. Notice that P7 phosphor peaks in the blue-violet region along with P11 while P15 and P31 peak more in the green region. Since the eye is more responsive to yellow-green, P15 and P31 are better for visual observations. These graphs are NOT corrected for the color response of the human eye. They show the relative radiant energy as seen by a device with a flat response.

In some applications the display on a CRT will not be viewed with the human eye but with other light sensitive devices such as photographic film or photocells. Each of these devices have their own spectral response and the selection of the phosphor will therefore be dependent upon the device used.

Photographic film, for example, is more responsive to blue light and a phosphor peaked in this region, such as P7 or P11, will give better results than most others. (Decay time may cause problems when P7 is used.)

The radiant energy distribution of some phosphors will change for different beam-current densities. At $100 \mu\text{A}/\text{cm}^2$, P31 has more blue energy than when the beam current is 1 and $10 \mu\text{A}/\text{cm}^2$ (Fig. 12-1).

13

WRITING SPEED

definition The writing speed figure expresses the maximum single-shot spot velocity (in cm/ μ s) which may be recorded on film as a just-visible trace. Where the highest possible photographic writing rate is required, a phosphor having blue fluorescence such as P11 is generally used since most types of film are more sensitive to blue light. Because of the difference in spectral sensitivity of the human eye and film, a phosphor having high luminance will not necessarily have high photographic writing speed. Sometimes a trace may be visible to the eye in a darkened room but difficulty may be encountered in trying to photograph the display.

factors influencing writing speed The factors which influence writing speed may be divided into three groups: those attributed to the CRT, the instrument, and the camera (including film). The table below shows the groups and *some* of the factors involved.

CRT	INSTRUMENT	CAMERA
Spot size	Intensity setting	Beam-splitter transmission
Edge defocus	Unblanking pulse amplitude	Film fog level
Plate intercept	Heater regulation	Lens transmission
Phosphor efficiency	Graticule transmission	Film sensitivity
Uniformity	Accelerating potential	Film response
Decay		Film age
Spectral emission		Lens speed
Beam current		

relative
writing
speed

A *relative* writing speed figure may be used when comparing writing speeds of two different phosphors to be used in the *same* oscilloscope. The table in Fig. 13-1 shows the relative writing speed of the many phosphors along with relative luminance. (Remember, luminance is CIE-eye-response corrected.)

Notice that P11 has a *relative* writing speed of 100. This says that all other factors being the same, a CRT with P11 phosphor will have a higher writing speed than any other phosphor. How fast is that? That depends on all those factors previously listed.

Note that P31 has a relative luminance of 100 and a relative writing speed of 75. P31 is bright and has excellent (second only to P11 and P7) relative writing speed and is therefore the standard phosphor on most CRT's.

TYPE	FLUORESCENCE	PHOSPHORESCENCE ¹	RELATIVE ² LUMINANCE	RELATIVE ³ WRITING SPEED
P1	Yellowish-green		45	35
P2*	Bluish-green	Green	60	70
P3	Greenish-yellow		45	15
P4	White		50	75
P5	Blue		3	15
P6	White		70	25
P7*	Blue-white	Yellow-green	45	95
P8*	Obsolete -- Replaced by P7			
P9	JEDEC registration withdrawn			
P10	Dark trace storage - Not luminescent			
P11	Purplish-blue		25	100
P12*	Orange		18	3
P13	Reddish-orange		4	1
P14*	Purplish-blue	Orange	40	60
P15	Bluish-green		15	25
P16	Bluish-purple		0.1	25
P17*	Yellowish-green		30	15
P18	White		18	35
P19*	Orange		25	3
P20	Yellowish-green		85	70
P21*	Orange		25	8
P22	Three-color dot pattern for color television			
P23	White		80	35
P24	Greenish-blue		8	6
P25*	Yellowish-orange		12	4
P26*	Orange		17	3
P27	Reddish-orange		20	7
P28*	Yellowish-green		50	50
P29	Two-color stripe pattern			
P30	Not registered with JEDEC			
P31	Green		100	75
P32*	Blue-green	Yellowish-green	25	15
P33*	Orange		20	7
P34	Blue green	Green	17	15
P35	Blue-white		55	45

¹Where different than fluorescence.

²Taken with Spectra Brightness Spot Meter which incorporates a CIE standard eye filter. Representative of 10 kV aluminized screens.

³Taken with 10,000 ASA Polaroid film for 10 kV aluminized screens.

*Phosphors having low level decay lasting over one minute under conditions of low ambient illumination.

NOTE: Tektronix supplies CRT's with only those phosphors listed in the catalog.

Fig. 13-1. Relative writing speed and relative luminance.

absolute
writing
speed

An absolute writing speed number requires a *detailed* statement of all the factors affecting the measurement and how the measurement was made. Such a statement is made in Fig. 13-2.

The speed of the film used is 10,000. If the film were faster then the writing speed would be faster. Without changing any other factors an improvement by the film makers gives oscilloscopes a faster writing speed!

PHOSPHOR	PHOTOS	CRT's	Photo Writing Speed cm/μs		
			High	Low	Average
P1	30	6	333	258	290
P2	15	3	835	660	737
P7	60	12	1310	943	1160
P11	60	12	1260	1020	1120
P31	55	11	903	675	760

MEASUREMENT NOTES

OSCILLOSCOPE: Type 547

CRT: T5470 (with phosphors listed)

1. Accelerating potential: 10kV overall
2. Unblanking pulse amplitude: 60V peak
3. INTENSITY: In the absence of ambient light, the INTENSITY control was adjusted to the point of visual extinction of an undeflected spot. Photos do not show an undeflected spot.
4. FOCUS & ASTIGMATISM: Adjusted to produce a sharp trace on both vertical and horizontal axes during low repetition-rate displays of the test signal.
5. SCALE ILLUMINATION: Zero, to avoid prefogging of film.
6. Phosphor was dormant; maintained in total darkness for about five minutes before each test photo.

SIGNAL: Exponentially-decaying sinewave.

CAMERA: Frame: C-27
 Lens: f/1.3, 1:0.5
 Exposure: Single-shot. Shutter was left open for five seconds to make use of available decay.
 Film: Polaroid 410, 10,000 ASA; five exposures were made of each CRT.
 Prefogging: None.

INTERPRETATION: Prints are backlit with fluorescent light. Peaks of sinewaves are masked to avoid illusion of complete cycle.

CALCULATION: Writing speed (cm/μs) = $\pi f A$
 f = frequency (megahertz/second)
 A = peak-to-peak amplitude (centimeters) of the sinewave cycle whose center is just visible to the eye.

Fig. 13-2. Typical writing speeds by phosphor.

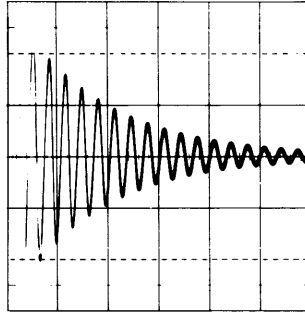

Fig. 13-3. Single-shot damped sinusoidal waveform used to measure writing speed.

writing
speed
approximation

Writing speed approximations result from measurement and computation of specific components. Usually one uses the damped sinewave technique. This results in a changing spot speed in which high amplitudes in the first part of the signal deflect the spot faster than those at the low amplitude end.

Horizontal velocity is negligible compared to vertical velocity. So one computes writing speed by comparing the amplitude where the first discernable trace crosses the X-axis -- the region of maximum velocity.

Fig. 13-3 shows the display used to measure writing speed. Apply the following formula:

$$WS = \pi fA$$

Where:

WS = writing speed (cm/ μ s)
 f = frequency of damped sinewave (mHz)
 A = vertical distance between peaks
of first discernable sinewave (cm)

Starting from the left, find the first rising or falling portion of the damped signal visible in its entirety. A is the distance between peaks connected by this portion. Ignore horizontal distance if A exceeds the horizontal dimension by three or more.

Consider this method as a close approximation only. *Absolute* writing speed depends upon variables not accounted for here.

14

PHOSPHOR BURNING

heat When a phosphor is excited by an electron beam having an excessively high current density, a permanent loss of phosphor efficiency may occur. The light output of the damaged phosphor will be reduced and in extreme cases complete destruction of the phosphor may result. Darkening or burning occurs when the heat developed by electron bombardment cannot be dissipated rapidly enough by the phosphor.

beam current density and time The two most important and controllable factors affecting the occurrence of burning are *beam-current density* (controllable with the Intensity, Focus and Astigmatism controls) and the length of *time* the beam excites a given section of the phosphor (controllable with the Time/Div control). Under normal conditions in CRT's with grid unblanking, the ambient voltage on the control grid will hold the tube in cutoff and no spot will be present on the screen.

inoperative sweep When the sweep is triggered, the unblanking pulse turns on the gun and if everything else is working properly the beam can be seen as it moves across the screen. But what if the horizontal amplifier is inoperative? The horizontal plates will not receive a signal under that condition and the beam will not be deflected but it will be turned on by the unblanking pulse. Result?- possibly a burn mark on the screen!

intensity
too high

The Intensity control can be adjusted to override the normal cutoff condition of the gun in the absence of an unblanking pulse in a CRT using grid unblanking. If this is done, a spot of reasonable intensity will be seen on the face of the CRT. If the sweep is now triggered, an unreasonably bright spot will occur. Result?- you guessed it - a burn mark.

Remember, burning is a function of intensity and time. Keeping intensity down or the time short will save the screen.

burn
resistance

Any phosphor can be burned but some more easily than others. Phosphors may be divided into three groups when considering their burn resistance:

Group 1	Low (easily burned)	P12, P19, P26, P33
Group 2	Medium (moderate)	P2, P4, P1, P7, P11
Group 3	High (hard to burn)	P31, P15

Group 1 phosphors are easily burned and should be used with care. Group 2 phosphors are about 10-100 times more difficult to burn than those in Group 1, so normal care should be exercised. Group 3 phosphors are about 100-1000 times more difficult to burn than those in Group 1. A P31 phosphor is quite difficult to burn. In fact, you really have to want to damage the phosphor even with a 10 kV tube.

light-heat
ratio

The typical phosphor is about 10% efficient. This means that of the total energy from the beam, 90% is converted to heat and 10% to light. A phosphor must radiate the light and dissipate the heat; or as any other substance, it will burn.

15

ALUMINIZED TUBES

When an electron beam excites a particle of phosphor, light is emitted in all directions. Therefore, only part of the light emitted is seen when viewing the CRT (Fig. 15-1). Some of the light is lost as it is emitted back into the tube. The lost light can be saved by coating the back of the phosphor with a thin coating of aluminum to act as a mirror. The electron beam will penetrate the aluminum coating and the emitted light that would usually be lost is reflected forward (Fig. 15-2).

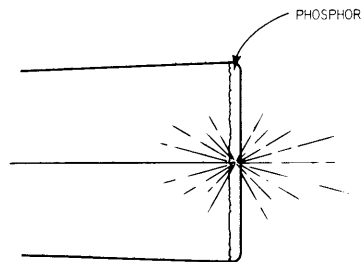

Fig. 15-1. Light scatter of non-aluminized CRT.

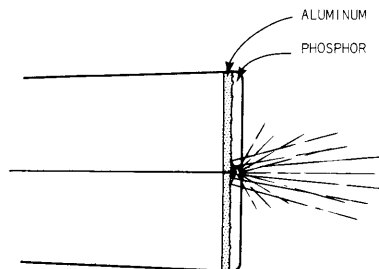

Fig. 15-2. Reduced light scatter of aluminized CRT.

brighter
trace

Some of the effective energy of the beam is used to penetrate the aluminum coating, reducing the effective acceleration potential. The effective deceleration of the beam depends on the thickness of the aluminum and may range from 1 kV to 3 kV or more. The overall result is, however, a brighter trace in an aluminized tube when accelerating potentials are well above the potential required to penetrate the aluminum.

reduced
burning

The aluminum coating also forms a heat sink for the phosphor, removing some of the heat which might otherwise cause burning. The effective reduction in acceleration potential also helps prevent burning.

16

LIGHT FILTERS

- ambient light
- A smoke-gray light filter is usually included with the accessories furnished with a Tektronix oscilloscope. Other filter colors are available on order. These filters are made of treated plexiglass and are used to enhance the visual trace-to-background contrast by attenuating ambient illumination of the phosphor. Light passing through these filters may have a loss as high as 75%. The ambient light that reflects from the screen has a broad spectrum and is attenuated. The light emitted from the phosphor by the trace is attenuated only once and thus contrast is enhanced.
- separate colors
- Filters also may be used to separate the long-decay component from the short-decay component of a phosphor which has a different color for each. P7, for example, is blue-white for its short-decay component and yellow-green for its long-decay component. An amber filter would enhance the slow component and a blue filter would enhance the fast component.
- photography
- Filters are usually not used in photographic applications since they absorb light even at their spectral peak. However, color filters may be used for the purpose of blocking long or short persistent components as discussed above or to prevent cathode-glow fogging of film when making long time exposures. The cathode glows red when heated and this light will fog film in a long time exposure, *if* the tube is not aluminized or a blue filter is not used to attenuate most of the red glow. In an aluminized tube the light from the cathode is reflected and causes little problem.

For general purpose improvement of trace-to-background contrast, the smoke-gray filter should be used.

Phosphor	Filter most useful <i>other than gray</i> for good general viewing contrast	To enhance the slow component	To enhance the fast component
P2	Green	Amber	Blue
P7	Green		
P11	Blue		
P15	Green		
P31	Green		

polarizing
filters

A polarizing filter also increases contrast ratio but uses a different principle than the color filters. This filter has the effect of a light trap for outside light. Incidental light entering the filter and reflecting from the face of the tube is phase changed in such a way that it cannot re-emit from the filter and is thus trapped and dissipated inside. Light emitting from the phosphor passes through the filter with attenuation of about 70-75%. The contrast ratio however is about 20:1, a vast improvement.

mesh
filters

The mesh filter also improves the contrast under higher ambient light conditions. This filter is a metal screen of subvisible mesh, with the surface treated for low reflectance. This filter works on the same principle as the colored filter. The screen is tautly mounted on a metal frame which can be placed over the CRT faceplate. The light transmission is approximately 28%.

RF shield

The mesh is grounded to the metal frame and effectively carries a large part of the CRT-emitted RF spectrum to chassis ground. The actual quantitative filtering ability depends upon the characteristics of the radiation, which varies between scope types.

17

GRATICULES

The display on the face of a CRT would be less meaningful if there were no markings to indicate divisions. In Fig. 17-1 the various time and amplitude characteristics of the display may be found by counting the number of divisions and multiplying by the appropriate switch setting. There are three types of graticules that can provide these division marks.

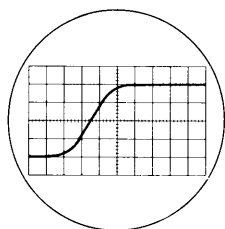

Fig. 17-1. Graticule.

external
graticule

An *external* graticule consists of a piece of scribed plexiglass mounted in front of the CRT (Fig. 17-2). Two graticule lamps illuminate the scribed lines and are controlled by the Scale Illumination Control on the front panel of the scope. This type of graticule has the advantage of being easily changed. Graticules marked in degrees for color-TV vector analysis, special risetime markings, or many other patterns may be quickly mounted on the scope.

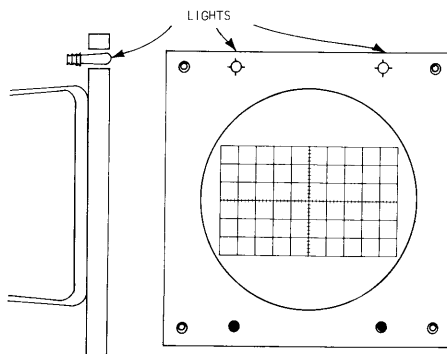

Fig. 17-2. External graticule and its illumination.

parallax

The external graticule has the major disadvantage of having parallax (Fig. 17-3). The scribed lines on the graticule are on a different plane than the trace. Therefore, the alignment of the trace and the graticule will vary with the viewing position.

Visual observation parallax can be overcome by always viewing the trace at one point at a 90% angle. Observing a second point requires moving the head and viewing the trace at the second point at a 90% angle. This will correct for parallax. A camera has similar parallax problems and cannot be shifted.

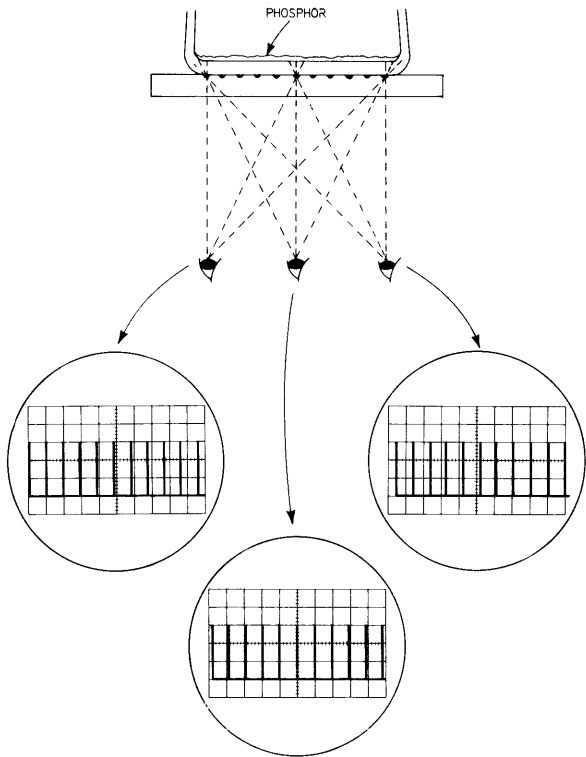

Fig. 17-3. Parallax.

internal graticule

A graticule on the inside surface of the face plate of the CRT is called an internal graticule. The trace and the graticule are in the same plane and there is no parallax (Fig. 17-4). This absence of parallax is a major advantage. This type of graticule

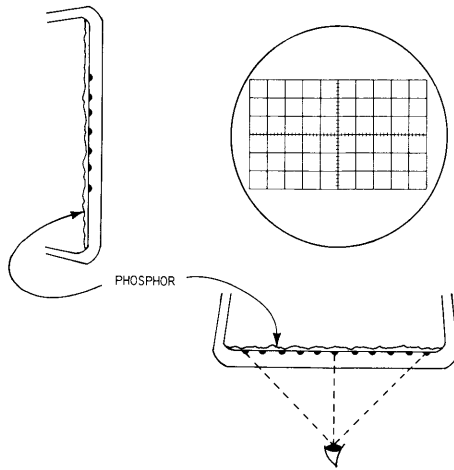

Fig. 17-4. Internal graticule.

is more costly to manufacture and cannot be changed without changing CRT's. Edge lighting the graticule lines is more difficult and illumination is not as bright as an external graticule. This type of graticule requires some means of trace alignment, which adds cost.

projected
graticule

The third graticule type is the projected graticule. It is limited to *camera-system applications*.

The projected graticule is diagrammed in Fig. 17-5. A light-splitting mirror is mounted in the camera housing. Light from the screen is split, part being reflected for visual observation and part passing through the mirror to the film. Below the mirror is a graticule on a transparency, much like a film slide.

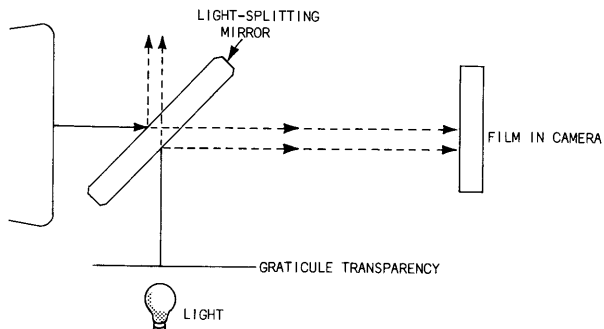

Fig. 17-5. Projected graticule.

The light from below the graticule is split by the mirror, part going through for visual observation and part being reflected to the film. With proper adjustment of the distance between the mirror and the graticule transparency, the face of the CRT and the graticule will appear to be in the same plane when viewed by the observer or the film in the camera and therefore parallax will not exist.

The projected graticule system is limited to camera applications. It has the advantage of graticule versatility. Any transparency can be used. Clear blank areas on the graticule transparency allow notes to be written which will show up on the photograph.

18

TRACE ALIGNMENT

When an *external* graticule is used, the trace and the graticule may be aligned by removing the side panel of the scope and adjusting the bracket which holds the neck of the CRT. This will turn the CRT until the trace and the graticule are aligned (Fig. 18-1).

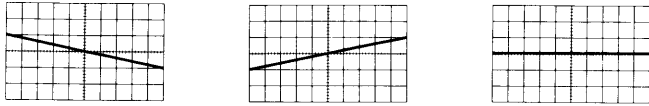

Fig. 18-1. Trace alignment.

When an *internal* graticule is used or the CRT envelope is rectangular a trace alignment control on the front panel of the scope is used (Fig. 18-2). The control sets the current through a coil around the outside of the front section of the CRT. The coil's electromagnetic field interacts with the electron beam to rotate the trace about the CRT axis. The *forces* acting on the electron beam are shown in Fig. 18-2.

electro
magnetic
beam
rotation

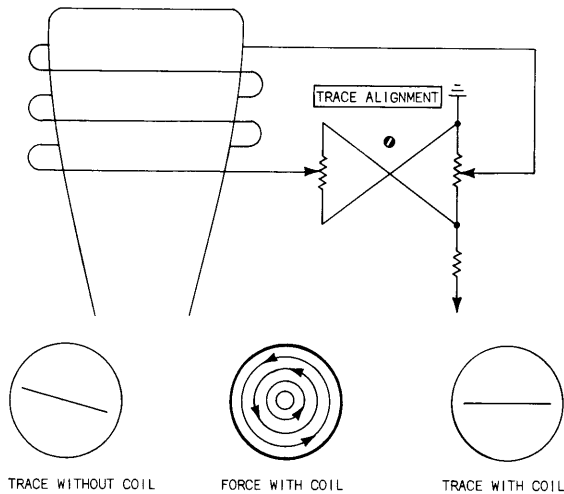

Fig. 18-2. Trace alignment control.

When a beam is deflected vertically the deflection should be perpendicular to the horizontal deflection. The orthogonality (perpendicularity) of the trace deflection may be affected by the trace rotation control. A vertically deflected beam may be more affected than a horizontally deflected beam in which case some correction is needed.

The Y-axis alignment control is shown in Fig. 18-3. This control is a second rotation coil located around the outside of the tube in the region of the vertical deflection plates. The trace rotation control is adjusted for the alignment of a horizontal trace and the Y-axis alignment control is adjusted for the alignment of a vertical trace.

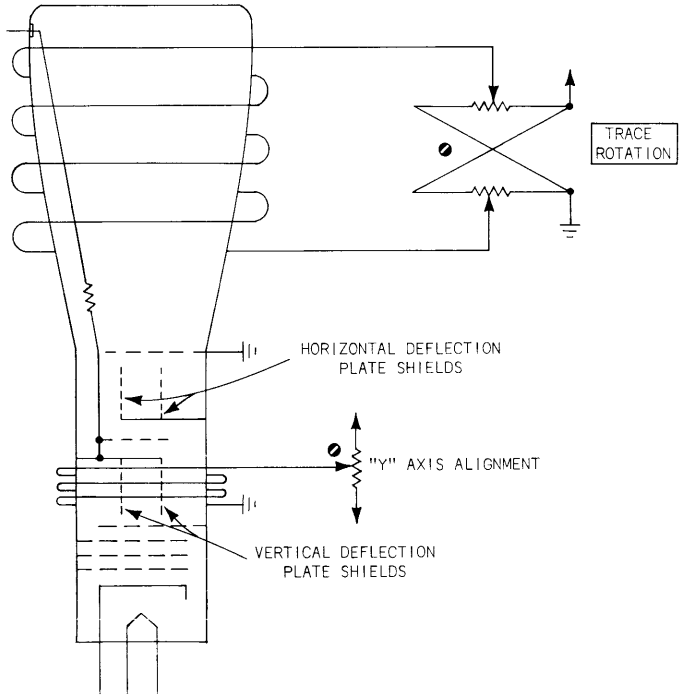

Fig. 18-3. Y-axis alignment control.

19

DUAL BEAM

An application which requires the viewing of two singularly occurring, simultaneous events would require a dual-beam scope. The dual-beam CRT has two independent beams.

The block diagram of a dual beam, single-horizontal scope is shown in Fig. 19-1. This type of CRT has two guns, two sets of vertical deflection plates, but only one set of horizontal deflection plates. The gun and deflection system is shown in Fig. 19-2. The two beams may be deflected vertically by two different signals but both beams are deflected horizontally by one set of horizontal plates.

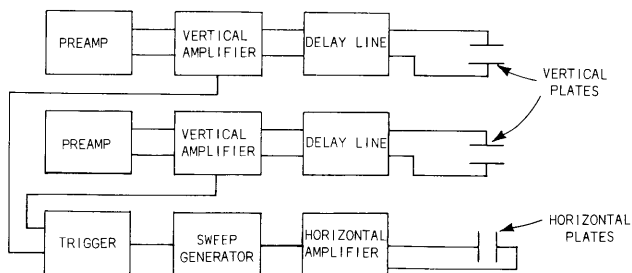

Fig. 19-1. Dual-beam oscilloscope block diagram.

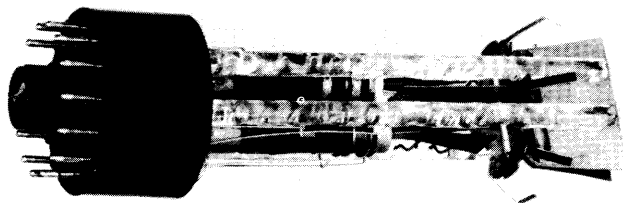

Fig. 19-2. Dual-beam gun.

20

DUAL GUN

Fig. 20-1 shows the block diagram of a dual-beam, dual-horizontal scope. Notice that each beam has an independent vertical *and* an independent horizontal. Each beam in this type CRT can be deflected horizontally at an independent sweep speed and vertically by an independent vertical signal. This type CRT is called a *dual-gun* CRT since each gun is complete by itself.

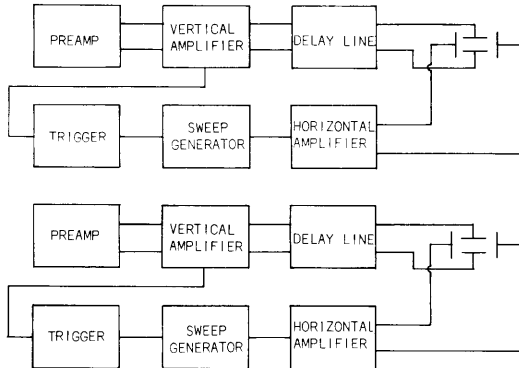

Fig. 20-1. Block diagram of dual-gun oscilloscope.

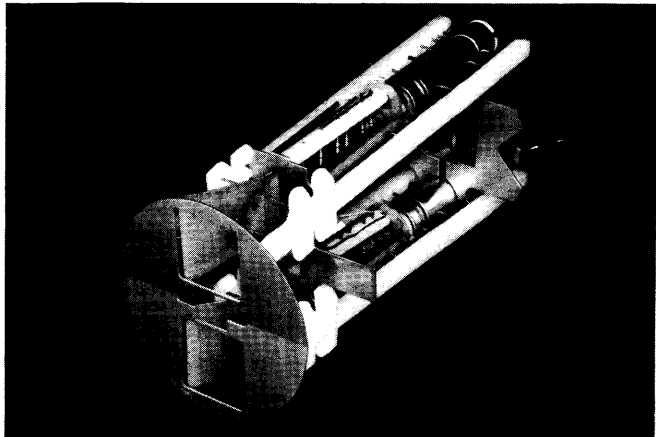

Fig. 20-2. Dual gun.

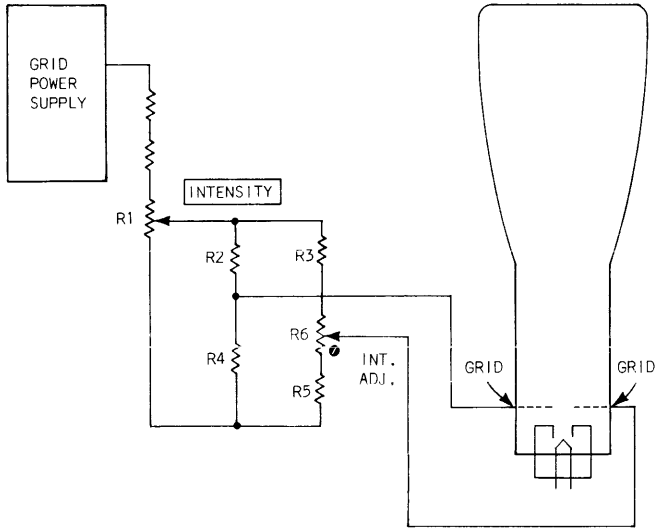

Fig. 20-3. Intensity Balance control.

intensity
balance
control

In a dual-beam, single-horizontal oscilloscope there is usually only one front panel Intensity control. This control sets the voltage on both CRT grids. Because of slight differences in the two gun structures some means of balancing the intensity of the two beams is needed. The Intensity Balance control or the Intensity Adjust perform this function (Fig. 20-3).

The Intensity control R1 sets the voltage at the top of R2 and R3. R2 and R4 form a fixed divider that sets the voltage on the grid of the bottom gun. R3, R5, and R6 form a similar adjustable divider for the grid of the top gun. By adjusting R6 the intensity of the two beams can be balanced. Once they are balanced the front panel Intensity can set the intensity of both beams.

A dual-beam, dual-horizontal oscilloscope has an intensity and focus control for each beam on the front panel of the scope and each beam can be positioned horizontally with its own horizontal positioning control.

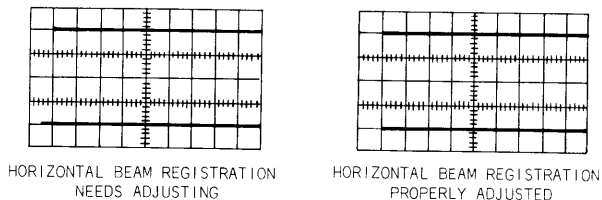

Fig. 20-4. Horizontal beam registration.

horizontal
beam
registration

Dual-gun oscilloscopes have independent horizontals. The horizontal position of each beam is adjustable from the front panel. A dual-beam oscilloscope with but one horizontal system requires another means to adjust the horizontal alignment of the beams (Fig. 20-4). This is done by splitting the first anode of these guns. The horizontal beam registration control sets the voltage on the second section of this anode.

In the section on deflection-plate unblanking it was noted that the horizontal position of the beam would be affected if the apparent source of the electrons was off axis. By adjusting the beam registration control, the apparent source of the beam electrons is adjusted until the horizontal position of the beams are aligned.

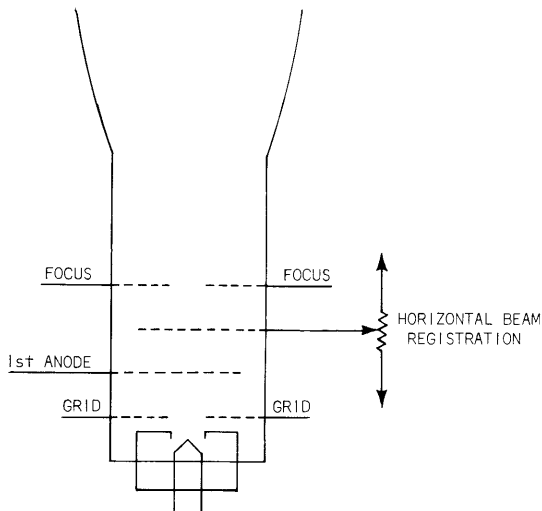

Fig. 20-5. Horizontal beam registration control.

INDEX

- Absolute writing speed, 75
- Acceleration schemes, 47-53
 - monoaccelerator, 47-48
 - post deflection, 48-53
- Aluminized tubes, 79-80
- Ambient light, 81
- Anode aperture, 10
- Anode, first, 9-24
- Anode region, 11
- Aquadag, 48-49
- Astigmatism and focus, 25-26
- Beam current, 14-16
 - and space charge, 56
 - control, 19
 - density and time 77
 - intercept, 38-39
- Beam registration, 93
- Beam rotation, electromagnetic, 87
- Blanking, 19-21
- Build-up time, 61
- Burn resistance, 78
- Cathode, 9
 - current, 14-15
 - diameter, 15
 - grid spacing, 16
 - life, 19
 - loading, 16
- Charge density, 55-56
- Charge repulsion, 55
- Chromaticity chart, 64-65
- CIE, 64
- Compression, 37-38, 48
- Crossover, 10-12, 56
- Decay time, 62
- Deflection, 27-52
 - coils, 42-45
 - defocusing, 40
 - distributed, 30-35
 - factor, 28, 48, 52
 - formula, 28
 - linearity, 37-38, 48
 - magnetic, 42-45
 - sensitivity, 28, 48
 - system, 27-47
 - yoke, 44
- Deflection plate, 19-42
 - notation, 30
 - path length correction, 42
 - unblanking, 19-23
- Distributed deflection, 30-35
- Dual beam, 89
- Dual gun, 91-93
- Electrical center, 27
- Electromagnetic beam rotation, 87-88
- Electron optics, 3-7
- Electron velocity, 3-52
- Equipotential lines, 3-16
- Eye response, 63-65
- First anode, 9-24
- Fluorescence, 61-62
- Focus, 13, 25-26, 39-41
 - and astigmatism, 25-26
 - and spot size, 25
 - lens function, 25
- Frame-grid, 53
- Fringing fields, 41
- Geometric defocusing, 39
- Geometry control, 41
- Graticules, 83-86
- Grid, 9-23
 - aperture, 10
 - cathode spacing, 16
 - region, 10
 - unblanking, 17-18
- Gun misalignment, 22
- Heater, 9
- Helix, 48-51
- Hue, 65
- Human eye response, 63-65
- Lens effect, 7
- Light filters, 81-82
- Light-heat ratio, 78
- Light output, 51, 61-82
- Linearity, deflection, 37-38, 43, 48
- Luminance, 67-70
- Luminescence, 61
- Magnetic deflection, 42-45
- Mesh, 50-53, 82
 - electrode, 50-53
 - RFI shield, 82

- Mesh construction, 53
- Mesh shadow, 53
- Monoaccelerator, 47-48, 56
- Orthogonality, 88
- Parallax, 84-86
- Phosphors, 61-80
 - burning, 77-78
 - emission, 71
 - luminance, 67-69
 - spectral response, 71
- Phosphorescence, 61
- Photography, 19, 81, 85-86
- Polarizing filter, 82
- Post deflection acceleration (PDA), 48-53
- Projected graticule, 85-86
- Push-pull drive, 36-38
- Registration, beam, 93
- Relative writing speed, 74, 76
- RF shield, 82
- Saturation, 65
- Scan limitations, 29
- Shrinking raster technique, 58-59
- Spectral response, 71
- Single-ended drive, 34-36, 38
- Space charge, 55-59
 - and beam current, 56
 - and trace width, 56
- Spot size, 12, 25, 51-59
- Trace alignment, 87-88, 93
- Trace width, 12, 25, 51-59
- Unblanking, 17-23
 - deflection plate, 19-23
 - grid, 17-18
 - pulse, 18
- Voltage cutoff (V_{CO}), 13
- Writing speed, 73-76
 - absolute, 75
 - definition, 73
 - factors influencing, 73
 - relative, 74, 76
- Yoke, 44

CIRCUIT CONCEPTS BY INSTRUMENT

Most concepts discussed in this book are applicable to all Tektronix products containing a cathode-ray tube. However, the concepts listed on the following pages are used in only certain products. Applicability is indicated by a ●.

CIRCUIT CONCEPTS:	INSTRUMENTS:										
	310A	317	321A	360	410	422	453	454	491	502A	503
Aluminization (p 79-80)			●			●	●	●	●		
Distributed Deflection (p 30-35)								●			
Deflection-Plate Unblanking (p 19-23)			●			●			●		
Dual-Beam Construction (p 89)										●	
Dual-Gun Construction (p 91-93)											
Grid-Cathode Unblanking (p 17-18)	●	●		●	●		●	●		●	●
Helix P.D.A. (p 48-51)		●	●		●	●	●	●			
Magnetic Deflection (p 42-45)					●						
Mesh-Grid Construction (p 50-53)						●	●				
Monoacceleration (p 47-48, 56)	●			●					●	●	●
Push-Pull Drive (p 36-38)	●	●	●	●		●	●	●	●	●	●
Single-Ended Drive (p 34-36, 38)											
Trace-Rotation Coil (p 87-88, 93)						●	●	●	●		

CIRCUIT CONCEPTS:	INSTRUMENTS:										
	564	565	567	568	575	581A	585A	601	611	647A	661
Aluminization (p 79-80)		•	•	•		•	•			•	
Distributed Deflection (p 30-35)						•	•				
Deflection-Plate Unblanking (p 19-23)	•	•									
Dual-Beam Construction (p 89)											
Dual-Gun Construction (p 91-93)		•									
Grid-Cathode Unblanking (p 17-18)			•	•	•	•	•			•	•
Helix P.D.A. (p 48-51)					•	•	•			•	
Magnetic Deflection (p 42-45)									•		
Mesh-Grid Construction (p 50-53)											
Monoacceleration (p 47-48, 56)	•	•	•	•							•
Push-Pull Drive (p 36-38)	•	•	•	•	•	•	•	•		•	•
Single-Ended Drive (p 34-36, 38)											
Trace-Rotation Coil (p 87-88, 93)	•	•	•	•		•	•			•	