

SPECTRUM ANALYSIS UTILIZING WAVEGUIDE MIXERS



CONTENTS:

I. Spectrum Analyzer Considerations Using External Waveguide Mixers	3
II. Broadband Harmonic Waveguide Mixers	5
III. Using the 490 Series Spectrum Analyzers in the External Mixer Mode	6
IV. Specific Measurement Examples:	
1. Gunn Oscillators	9
2. Klystrons	9
3. Impatt (avalanche) Diode Oscillators	9
V. Waveguide Mixer Characteristics	
1. Individual Mixer Electrical Characteristics	10
2. Performance Characteristics	10
3. Individual Mixer Mechanical Characteristics	11

Spectrum Analysis Utilizing Waveguide Mixers was written by Bob Alm, Design Engineer, and Len Garrett, Product Marketing Manager, Frequency Domain Instruments, Tektronix, Inc.

I. Spectrum Analyzer Considerations Using External Waveguide Mixers

Whether a measurement is made at audio frequencies or millimeter wavelengths, the spectrum analyzer is used to measure amplitude vs. frequency.

Typical measurements include the spectral energy distribution or signature of the energy source. This can be as simple as measuring harmonic levels of a continuous wave source to a more complicated occupied bandwidth measurement of a digital microwave transmission system.

Actual spectrum analyzer measurements at millimeter wavelengths differ from lower frequency measurements in the transition from coaxial cables to waveguides.

Most spectrum analyzers have an internal mixer upper frequency limit of 21 to 22 GHz, and utilize a type "N" RF input connector.

When the required measurement is above 22 GHz, some type of external mixing is required. Current techniques utilize harmonics of the spectrum analyzer first sweeping LO and an external harmonic waveguide mixer covering the desired frequency range.

Spectrum analyzers designed to operate in the waveguide bands of 18 GHz and higher must have sufficient LO power to drive the external mixer, an internal or external bias supply to optimize the mixer diode conduction angle for best sensitivity, and an external or internal diplexer to separate the LO signal and the desired IF signal. Suitable frequency calibration must also be available.

Additionally, some type of signal identification is needed to identify the desired IF response from images and other harmonic conversion products.

Spectrum measurements requiring detailed analysis of highly stable microwave and millimeter wave sources require that the spectrum analyzer residual FM (multiplied by the LO harmonic number) not exceed approximately one third of resolution bandwidth in use if a clean CRT trace is to be obtained. As LO FM'ing increases, the CRT trace width will increase.

The remaining paragraphs of Section One will cover in more detail some of the above mentioned requirements.

LO Power Output Requirements

Local oscillator power requirement is a key consideration in millimeter-wave conversion. Figure 1 shows the typical effects of conversion loss vs. LO drive level for a harmonic mixer, in this case operating at 50 GHz.

The 492 Spectrum Analyzer provides a drive level of +7.0 dBm minimum to +15 dBm maximum through a front panel SMA female connector and an external diplexer.

A 3 dB power divider inside the 492 splits the LO power between the internal first converter and the first LO front panel output connector used with external waveguide mixers or tracking generator. Figure 2 shows the location of this LO port on the 492 Spectrum Analyzer.



Figure 2. LO port

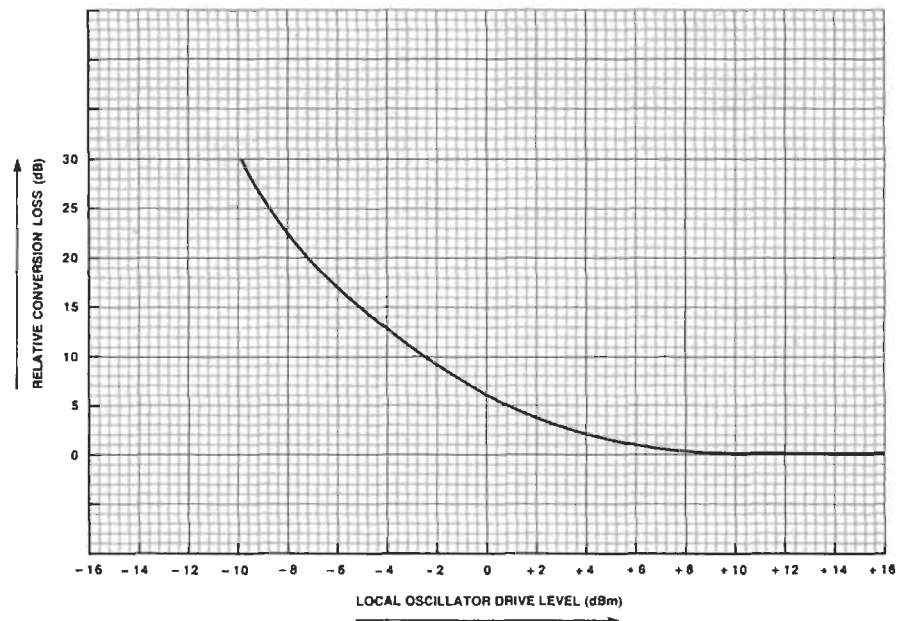

Figure 1. Effects of LO drive level vs. conversion loss.

Waveguide Mixer Bias

Mixer diode conduction angle is an important consideration in harmonic conversion loss, which translates to sensitivity. The optimum conduction angle varies with LO frequency, power, and harmonic number. A variable mixer bias supply was designed into the 492 Spectrum Analyzer to allow optimizing this conduction angle for each frequency of interest.

The mixer bias (+0.5 to -2.0 volts; 20 mA maximum) is supplied to the waveguide mixer through the 2.072 GHz IF input port on the 492 via the external diplexer. This input has a TNC fitting and is labeled external mixer (Figure 3).



Figure 3. External mixer input.

The peaking control is located next to the external mixer port and serves as a mixer bias control for external mixers and as a preselector peaking control (on option 01 instruments) for frequencies between 1.7 GHz and 21 GHz (internal mixer mode). The peaking control is addressable through the GPIB interface bus for automating measurements.

More than one value of peaking will typically occur for each frequency. The proper adjustment is always the maximum displayed signal amplitude.

Peaking at 1 GHz intervals will typically provide sensitivity within 1 to 2 dB of maximum over each waveguide mixer frequency range.

Diplexer Use

In the waveguide bands, spectrum analyzers often use a quadrature hybrid diplexer, a 4-port 3 dB coupler that divides the input signal into two mutually isolated quadrature phased (90 degree) outputs while maintaining isolation of the fourth port from the input. This prevents LO energy from reaching port (1) and IF energy from reaching port (2). Figure 4 represents this type of diplexer and its connections to the 492 Spectrum Analyzer and external waveguide mixer(s).

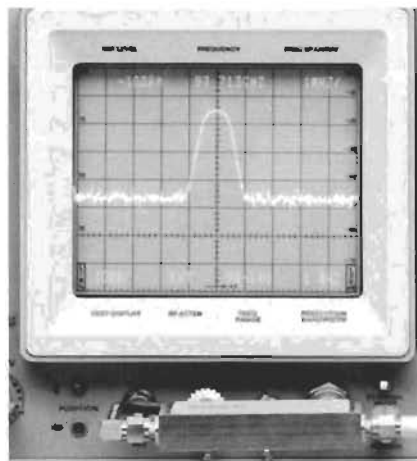

Figure 4. Quadrature hybrid diplexer.

True Signal Identification

The harmonic conversion process is not without its problems. Sum and difference frequencies due to each harmonic ("N" number) of the LO will be generated by the mixer, and many of these products will be passed through the diplexer to the IF input port as the LO sweeps over its full 2 to 6 GHz range. Dozens of on screen signals will appear in response to the many harmonic conversion products. (Figure 5).

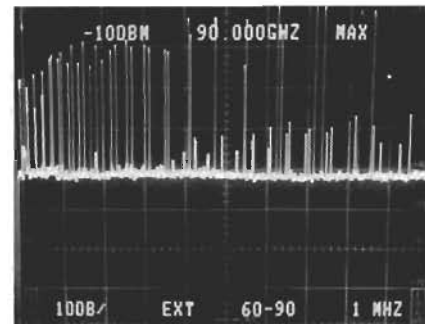

Figure 5. MAX SPAN display in response to ANY signal applied to ANY external mixer band.

Some means of true signal identification is very important. Only if the correct signal response is analyzed can we truly measure its correct frequency, amplitude and bandwidth characteristics.

The 492 Spectrum Analyzer uses an alternating LO offset method to identify the proper response. A zero horizontal offset in alternating sweeps while in the "identify" mode indicates a conversion product at the proper frequency.

Adjusting the span/div to 500 kHz/Div and pressing the signal identifier button will cause the display to alternately sweep with a 2-division vertical offset. If the displayed signal represents the conversion of interest, the signal on the CRT will move up and down in alternate sweeps with very little horizontal movement as shown in Figure 6. If the displayed signal represents any other conversion, there will be a significant offset in the horizontal position on alternate sweeps (Figure 7).

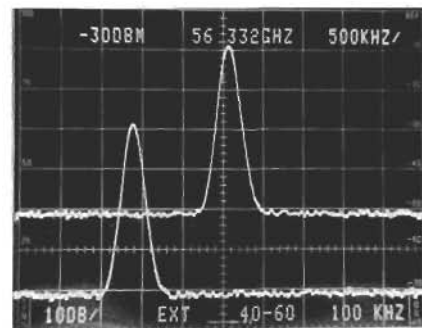

Figure 6. Spurious response display in the identifier mode.

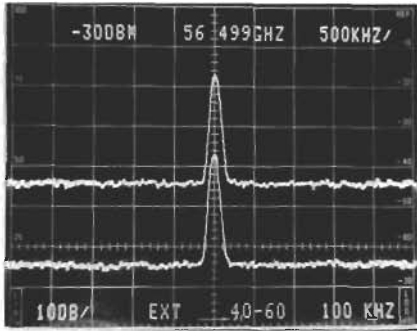

Figure 7. True signal display in the identifier mode.

Signal identification with the Tektronix 7L18 microwave Spectrum Analyzer is accomplished by turning the frequency Span/Div control to "identify." This sets the Span/Div to a value that will display two pairs of signals (Figure 8). Only the real response generates a dual pair of signals whose frequency separation within each pair is exactly two divisions. The real response is the left most signal of the left pair.

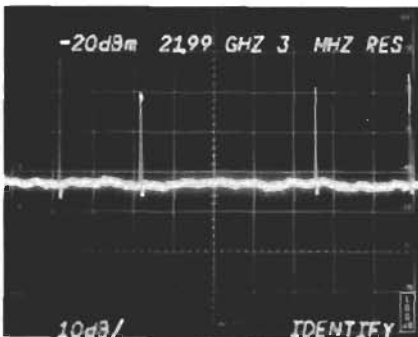
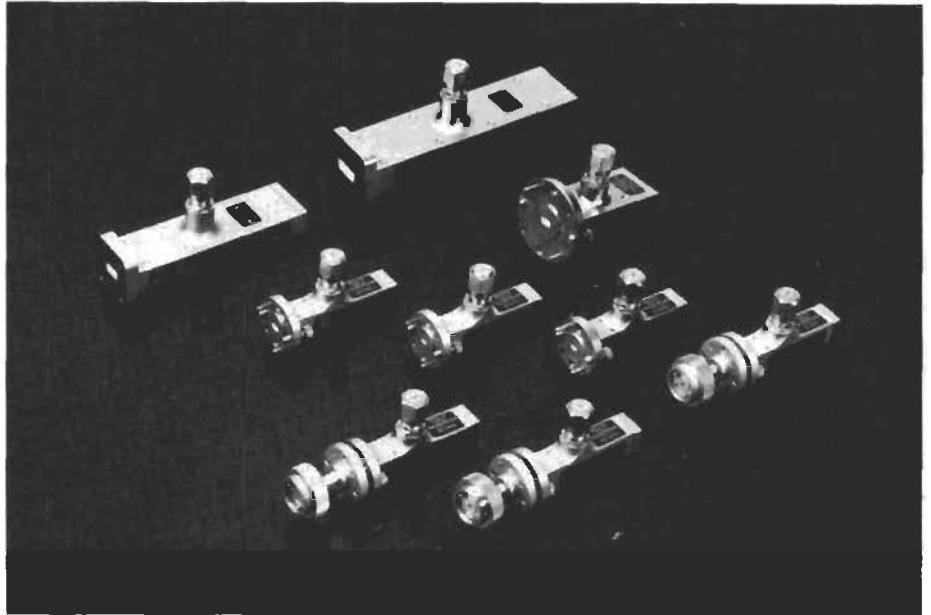

Figure 8. The proper signal is identified using the 7L18.



Millimeter wave test set-up using the 7L18 spectrum analyzer with external waveguide mixer.



Full set of Tektronix waveguide mixers covering both sets of overlapping bands from 18 GHz — 325 GHz.

II. Broadband Harmonic Waveguide Mixers

Unlike most lower-frequency counterparts, the harmonic waveguide mixers are two-port devices. The RF input signal to be analyzed is coupled to the mixer diode through a short section of waveguide. The LO input and IF output are connected to the mixer diode through a coaxial low-pass filter, a 3-mm coaxial connector and cable, and the external diplexer.

Key features in the design of the harmonic mixers that make them work well in the millimeter-wave frequency range are:

- Use of single-ridged waveguide in the vicinity of the mixer diode to concentrate energy at the diode junction for better sensitivity and lower conversion loss.
- An internal transition from rectangular to ridged waveguide eliminating the need for external adaptors and flange joints.

- A tapered RF load beyond the diode to eliminate reflections and enhance broadband performance.
- Careful design of the LO/IF port low-pass filter to prevent higher order modes and responses from propagating energy within the waveguide bandwidth and thereby decreasing performance. The low-pass filter design is selected on the basis of reasonable physical dimensions that place multiple resonances above or below, but not within the desired waveguide band. The low-pass cutoff frequency of the filter varies as required (within the electrical constraints of the mixer) to maintain realistic mechanical dimensions.

The physical arrangement of the filter provides a low-impedance point at the LO/IF interface where the mixer diode is mounted. The low impedance diode mount improves the waveguide port VSWR and matches impedance from the diode to the LO/IF port.

- The mixer chip is an array of GaAs shottky-barrier diodes, each $2\text{-}\mu\text{m}$ in diameter. The diode junction is probed by the etched point of a gold plated .026 mm (.001 in) diameter tungsten "Cat's Whisker." This design provides minimal junction capacitance and probe inductance, eliminating in-band resonances and minimizing reflections. A unique mechanical

clamp allows easy probing of a very small diode; tightening of the clamp secures the probe without threatening the delicate probe-to-junction contact. Figure 9 is a photo of the diode array magnified 240 times.

Figure 10 is a cross sectional view of the mixer construction detail with the low-pass filter shown in greater detail below.

III. Using the 490 Series Spectrum Analyzer in the External Mixer Mode

Spectrum analysis using external waveguide mixers requires connecting the diplexer to the spectrum analyzer, connecting the mixer LO cable to the diplexer, and lastly connecting to the waveguide mixer. Connecting the cable to the diplexer before attachment to the mixer reduces mixer damage potential by dissipating any cable stored charge.

The external mixer bands of any spectrum analyzer are not pre-selected, and signals will appear on screen in response to a single input frequency at every positive and negative conversion of every harmonic of the first local oscillator. A signal identifier must be used in these bands to locate the proper response for accurate signal analysis.

In the 492/492P system, the peak/average cursor must be BELOW the noise to avoid averaging all of the mixer responses into the noise in wide spans. The waveguide bands cover very large bandwidths and the signals can easily be lost — even in the maximum resolution bandwidth. The cursor can be moved back up after spanning down on the signal.

The mixer peaking control adjusts the DC bias to the mixers from +0.5 to -2.0 volts, with zero bias being at approximately 9 o'clock on the knob. It is a good idea to set the bias knob near this zero bias point when connecting and disconnecting the mixer cable to the mixers.

When the instrument is set into ANY of the external mixer bands above 21 GHz, the MAX SPAN setting takes on a different meaning. In the waveguide bands, the left edge of the screen represents a first LO frequency of 2 GHz, and the right edge is where the first LO frequency is 6 GHz. There is no out-of-band blanking, for nothing is out of band.

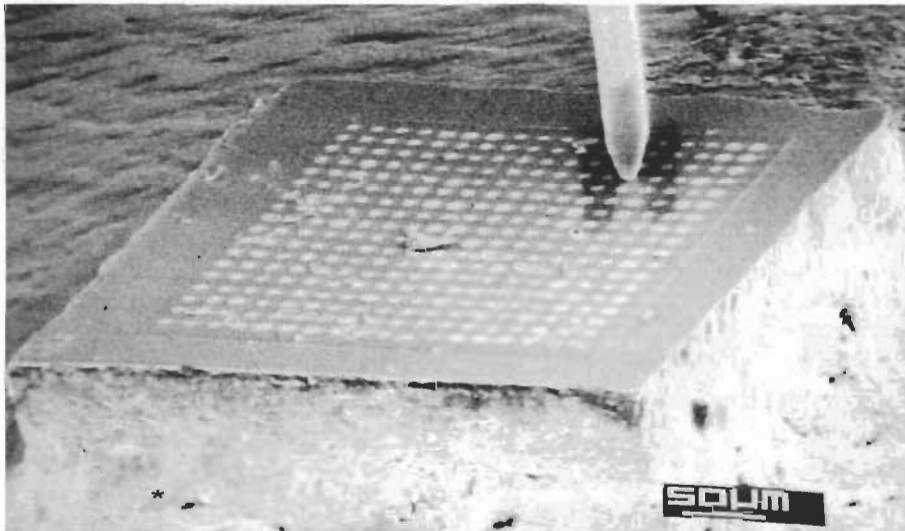

Figure 9. Millimeter mixer diode array.

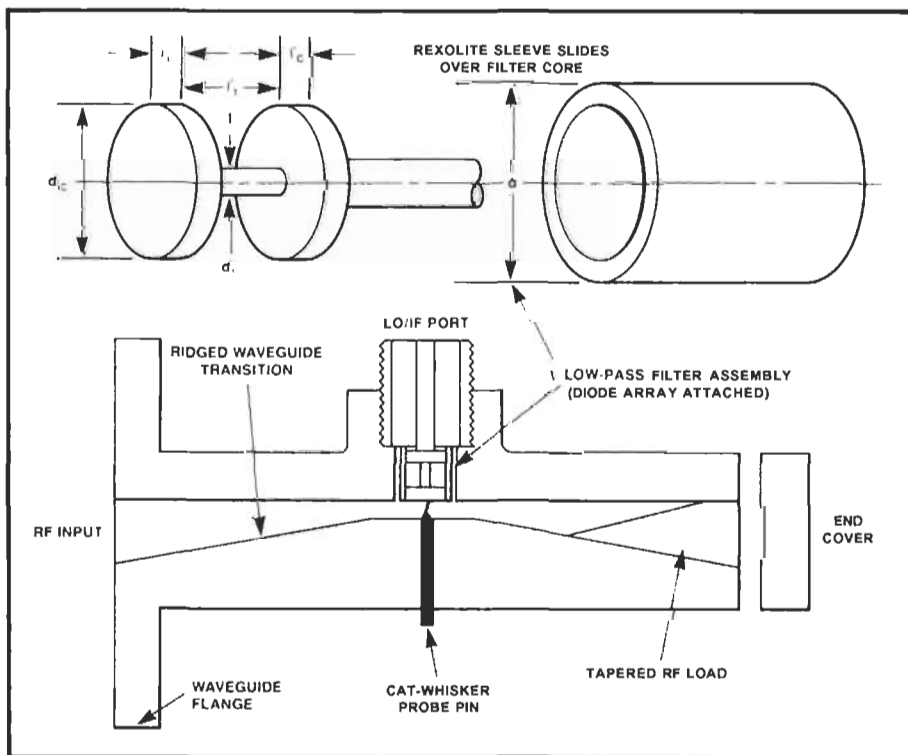

Figure 10. Millimetric mixer construction.

What appears on the screen are the responses due to ALL of the harmonics and conversions of the LO, as shown in Figure 5. Responses due to a 26 GHz signal will appear in this range as well as responses due to a 100 GHz signal, regardless of WHICH band is selected. The bands are there simply to allow the center frequency and signal identifier functions to work properly. Many of the generated responses are real, but the 492/492P signal identifier feature is designed to find the one response which exhibits the properties which correlate with the rest of the system design. Here is an example of what this means: The instrument is set to the 90-140 GHz band, and a 94 GHz signal applied to an F-band mixer. The 492 is tuned to 94 GHz and then spanned down to 500 kHz/div. The signal is then found, peaked and identified and the analyzer set at, perhaps, 50 MHz/div. The analyzer is then switched to the 140-220 GHz band. What happens? The signal does not move or change in amplitude, but the band readout and center frequency change. A slight change in the "width" of the signal may also be visible. This is because band changes preserve LO frequency, NOT center frequency. The signal displayed on the screen is in response to a 94 GHz signal mixing with the 23rd harmonic of the first LO ($N = 23$) in the waveguide mixer. It will be exactly there in all waveguide bands, but it will identify as "real" only when the 90-140 GHz band is selected so that the center frequency will be read out accurately. Therefore, in this example, the signal will identify as false in the 140-220 GHz band.

The signal identifier has its limits with large values of "N." This feature requires care in interpretation in the higher millimeter-wave bands. A real signal and a false conversion (for that band) may be adjacent harmonic numbers, and the offset difference on alternate sweeps in the

identify mode may be imperceptible. This is a fairly rare occurrence, but can happen, and that is why it is a good idea for a user to also have a wavemeter to confirm the frequency of the signal of interest.

Frequency Measurements

The 494 and 494P Spectrum Analyzers offer powerful contributions to microwave and millimeter waveguide band signal analysis.

Frequency measurement accuracy of stabilized sources is comparable to microwave counters, with +5 kHz being typical at 40 GHz and ± 10 kHz typical at 300 GHz.

A new signal identification routine operates on any span below 50 MHz/division and provides positive true signal identification even for large local oscillator harmonic numbers.

Positive true signal identification is made possible by a large displayed shift in false signals while a true signal remains virtually stationary during alternate sweeps.

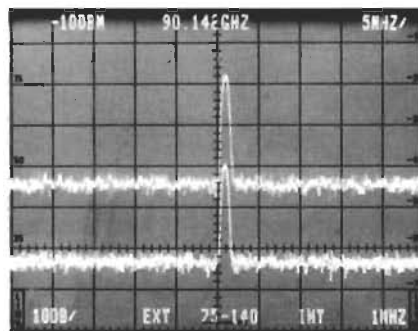

True signal identification at 90 GHz.

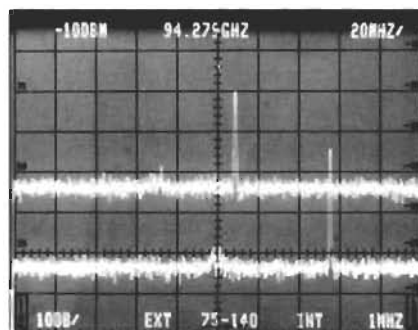

False signal identification at 94 GHz.

Connecting the Waveguide Mixer

The maximum input power to the waveguide mixer must be limited to +15 dBm CW or 1 watt peak to avoid mixer diode damage.

Mixer operating levels range from -20 dBm to 0 dBm for 1 dB compression depending on the frequency range. These levels are easily obtained from most sources. A waveguide attenuator and/or a directional coupler should be used to control the applied power level. Further, a pickup horn can be used in high radiated power setups.

Linear operation is best verified by changing the input power level to the mixer by a known amount and observing the change in amplitude on the spectrum analyzer display.

Mixer LO Cable Length

Waveguide mixers for the 492/492P Spectrum Analyzers are supplied with a 28 inch length of 50 ohm coaxial cable as standard. This length is selected to provide a minimum/maximum range of LO power to the mixer of +7 dBm to +15 dBm.

Operation at greater distances between the spectrum analyzer and waveguide mixer are possible with some degradation in sensitivity. For example, extending the 50 ohm connecting cable from its normal 28 inches to six feet will attenuate the LO power by approximately 2 dB at 4 GHz (RG 223/U) causing an increase in the mixer conversion loss of approximately 1 dB; additionally, further loss of 2 dB will occur due to the IF signal attenuation. The overall effect will be a 3 dB loss in sensitivity.

Dynamic Range

(Assume a 1 dB compression level as maximum for full screen)

The available on-screen dynamic range will depend on the signal input level available, the spectrum analyzer resolution bandwidth in use, and the residual FM of the signal to be measured. This latter factor will determine the narrowest resolution bandwidth that can be used for a particular measurement.

Typical dynamic range for the 492 and WM490F (90-140 GHz) waveguide mixer is 45 dB in 1 MHz resolution bandwidth and 75 dB in 1 kHz resolution bandwidth.

Coupling Hardware Considerations

Greatest measurement accuracy and repeatability is insured by smooth mating surfaces and proper alignment of the flange on the waveguide mixer and any external waveguide component.

Uniform pressure across the entire mating surface is important for best results.

Figure 11 is a photo of improper alignment caused by uneven pressure on the flange securing screws.

Note: The captive flange screws are equipped with pop-off heads to protect against over tightening

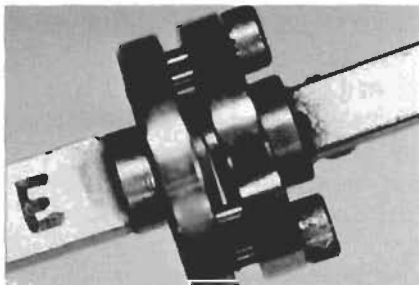

Figure 11. Improper alignment caused by uneven pressure on the flange securing screws.

An air gap, as shown here will result in increased system VSWR and decreased available power to the mixer due to radiation loss and reflection.

Mixer Diode Testing and Replacement

The DC response of the diode can best be checked using a curve tracer such as the Tektronix Model 576. The response curve shown in Figure 12 indicates a good diode. Proper curve tracer settings are shown on the curve tracer CRT. **Caution:** Do not use an ohmmeter to test for contact or polarity.

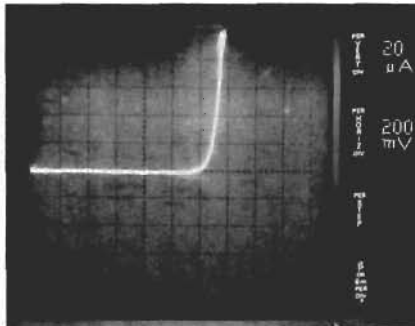

Figure 12. A properly working mixer diode.

The test for sensitivity requires a calibrated signal source at the operating frequency.

The mixer diode package is field replaceable in the Tektronix WM490K (18-26.5 GHz) and the WM490A (26.5-40 GHz) waveguide mixers. The diode replacement and sensitivity verification procedures are detailed in the waveguide mixer instruction manual. Tektronix Waveguide Mixers WM490U (40-60 GHz), WM490V (50-75 GHz), WM490E (60-90 GHz), WM490W (75-110 GHz), WM490F (90-140 GHz), WM490D (110-170 GHz), and WM490G (140-220 GHz) should be returned to the factory for repair.

Caution: Do not attempt to disassemble the mixer body.

Amplitude Measurement Considerations

When operating the 492 Spectrum Analyzer in the external mixer mode, notice that the reference level in the 18-26.5 GHz, 26.5-40 GHz, and 40-60 GHz bands is -30 dBm at the top of the screen. The input attenuator is not used, but the reference level can be set to -20 dBm in these bands by using the MIN NOISE setting. In the higher millimeter wave bands, however, the conversion loss of each mixer is higher due to the higher N-number, and the reference level is adjusted accordingly. This is done because as the conversion loss goes up, so does the input saturation level (3 dB compression). The 18-26.5 GHz mixer will saturate with -10 dBm into the waveguide port, but the 60-90 GHz mixer will not, for example. The reference level in the higher millimeter wave bands is adjusted to provide the maximum on-screen dynamic range before the mixer saturates. The reference level at the top of the screen then represents the RF level being applied to the mixer, and it should be remembered that this number is an average for each band.

Amplitude measurement accuracy is limited by the same constraints that apply when using the spectrum analyzer coaxial input.

The most important factors affecting amplitude accuracy in the waveguide bands is the frequency response of the individual waveguide mixers and the proper peaking of the mixer bias.

IV. Specific Measurement Examples

The following are examples of some typical millimeter wave sources as viewed on a 492 Spectrum Analyzer.

1. Gunn Oscillators

Figure 13 is a CRT photo of a Gunn oscillator operating in the CW mode at approximately 60 GHz. Note the well defined spectrum analyzer resolution bandwidth filter response, indicating residual FM less than 100 kHz.

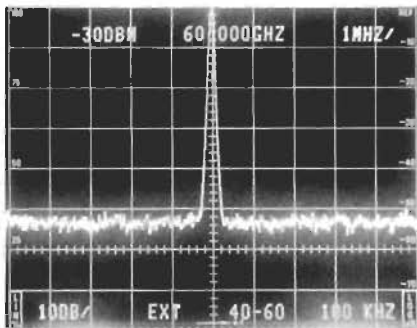

Figure 13. Gunn oscillator at 60 GHz. Note 100 kHz resolution can be used.

The mixer power level is indicated at -30 dBm and the on screen dynamic range is shown to be 50 dB for the 100 kHz resolution bandwidth filter.

2. Klystrons

Figure 14 is a CRT photo of a Klystron oscillator operating in the CW mode at approximately 142 GHz. The available on-screen dynamic range is shown to be 42 dB using the 1 MHz resolution bandwidth filter. Residual FM is not measurable at 5 MHz/Div frequency span.

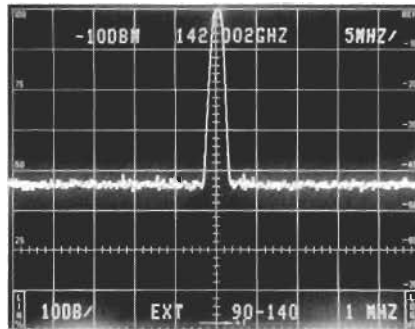

Figure 14. Klystron at 142 GHz. Wide video filter on.

Power supply ripple on the RF source becomes clearly visible in Figure 15 by using the narrower 500 kHz/Div span setting.

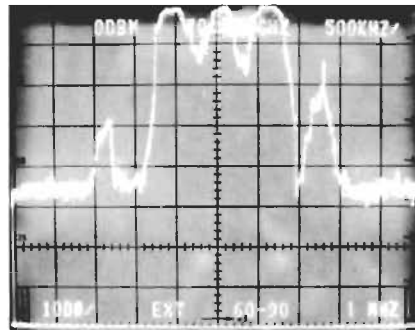

Figure 15. Typical power supply noise on a Klystron in a narrower span.

Figure 16 is a CRT photo of a Klystron oscillator operating in the CW mode at 184.7 GHz. The WM490F (90-140 GHz) waveguide mixer and 119-1729-00 tapered waveguide transition was used in making this measurement.

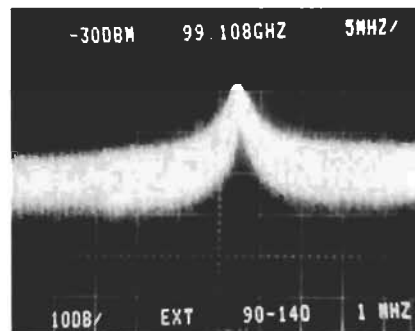

Figure 16. Typical Impatt diode oscillator. Accurate amplitude readings will be difficult.

3. Impatt (avalanche) Diode Oscillators

Figure 17 is a CRT photo of an Impatt Diode oscillator operating in the CW mode at 99.1 GHz. The Impatt oscillator's low "Q" results in a broad noise-like spectrum. Often the "Q" is so low in tunable Impatt oscillators that the output energy distribution is much wider than the maximum resolution bandwidth of the Spectrum Analyzer.

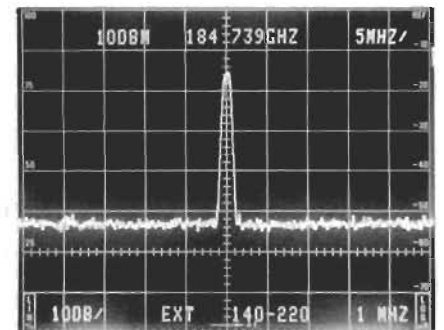

Figure 17. Klystron at 184 GHz. Available on-screen dynamic range is approximately 34 dB with mixer saturated.

The energy peak frequency appears as only a lump in the background noise even after careful adjustment of the mixer bias (peaking) control.

The displayed amplitude will not agree with a power meter due to the broadband noise property of the signal. A point to remember is that the spectrum analyzer plots energy per unit frequency while the power meter integrates all energy applied to the sensor head.

V. Waveguide Mixer Characteristics

1. Individual Mixer Electrical Characteristics

Frequency Range (GHz)	Tektronix Model No.	Band Designation	Sensitivity (dBm) ¹	Frequency Response ²	Amplitude Accuracy ³	3 dB Compression Point (Saturation)
18-26.5	WM490K	K	-100	± 3 dB	± 6 dB	- 10 dBm typical
26.5-40	WM490A	A	-95	± 3 dB	± 6 dB	- 10 dBm typical
40-60	WM490U	U	-95	± 3 dB	± 6 dB	- 10 dBm typical
50-75	WM490V	V	- 95 at 50 GHz - 90 at 75 GHz typical	± 3 dB typical ⁴		- 10 dBm at 50 GHz - 10 dBm at 75 GHz typical
60-90	WM490E	E	- 95 at 60 GHz - 85 at 90 GHz typical	± 3 dB typical ⁴		- 10 dBm at 60 GHz - 5 dBm at 90 GHz typical
75-110	WM490W	W	- 90 at 75 GHz - 80 at 110 GHz typical	± 3 dB typical ⁴		- 10 dBm at 75 GHz 0 dBm at 110 GHz typical
90-140	WM490F	F	- 85 at 90 GHz - 75 at 140 GHz typical	± 3 dB typical ⁴		-5 dBm at 90 GHz 0 dBm at 140 GHz typical
110-170	WM490D	D	- 80 at 110 GHz - 70 at 170 GHz typical	± 3 dB typical ⁴		0 dBm at 110 GHz + 5 dBm at 170 GHz typical
140-220	WM490G	G	- 75 at 140 GHz -65 at 220 GHz typical	± 3 dB typical ⁴		0 dBm at 140 GHz + 10 dBm at 220 GHz typical
220-325	119-1728-007	J	- 65 at 220 GHz - 50 at 325 GHz typical ⁵	± 3 dB		+ 10 dBm at 220 GHz typical ⁶

Notes:

- 1 Equivalent average noise level at 1 kHz bandwidth.
2. Maximum amplitude variation across each waveguide mixer band (with peaking control optimized at each frequency in response to a - 30 dBm CW input signal to the mixer).
3. Maximum reference level error with respect to the internal calibrator. Amplitude accuracy can be improved 3 dB by measuring amplitude with respect to a known external (waveguide) reference signal.
4. Over any 5 GHz bandwidth for millimeter wave mixers above 60 GHz.
5. Value estimated at 325 GHz.
6. Saturation level exceeds burnout at 325 GHz.
7. Tapered waveguide transition allowing WM490G to cover this range.

2. Performance Characteristics for all WM490 Series Waveguide Mixers

Maximum CW Input Level: + 15 dBm (32 mW).

Maximum Pulsed Input Level: 1 W peak with .001 maximum duty factor and 1 μs maximum pulse width.

LO Requirements: + 7 dBm minimum; + 15 dBm maximum; + 10 dBm typical.

Bias Requirements: - 2.0 to + 0.5 volts with respect to the mixer body, 20 mA maximum current.

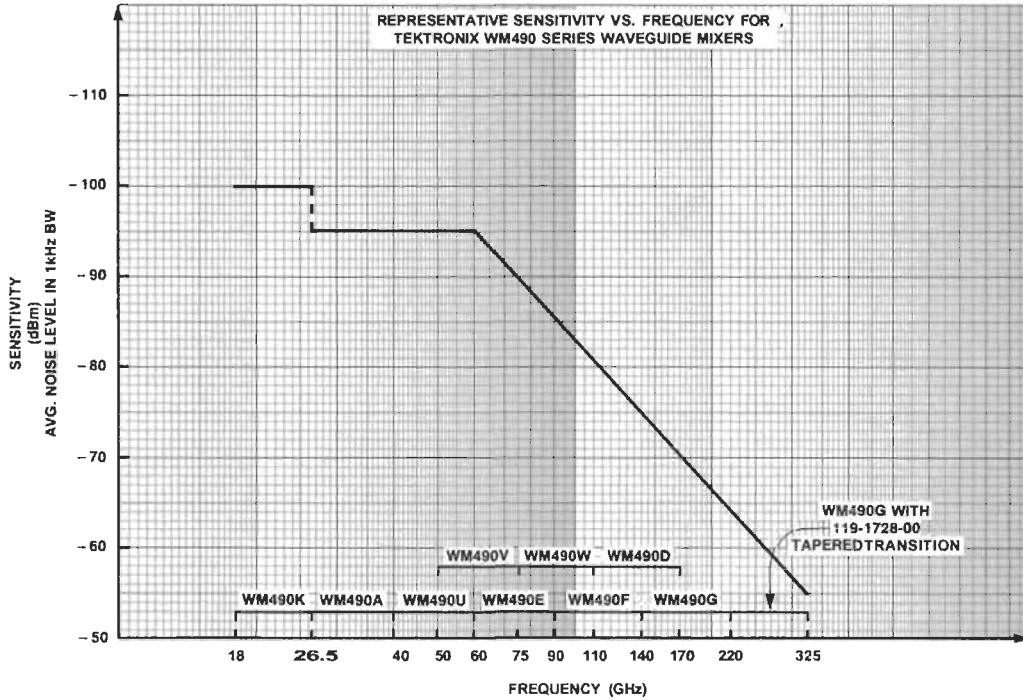

3. Individual Mixer Mechanical Characteristics

Frequency Range (GHz)	Tektronix Model No.	Waveguide (EIA)	Flange (JAN)	Length	Width ¹	Height ¹	Weight
18-26.5	WM490K	WR-42	UG-595/U	8.97 cm (3.53 in)	2.22 cm (.875 in)	3.68 cm (1.45 in)	180 g (6.5 oz)
26.5-40	WM490A	WR-28	UG-599/U	6.93 cm (2.73 in)	1.90 cm (.750 in)	3.35 cm (1.32 in)	100 g (3.7 oz)
40-60	WM490U	WR-19	UG-383/U-M	4.52 cm (1.78 in)	1.84 cm ¹ (.725 in ¹)	2.45 cm (.980 in)	80 g (2.9 oz)
50-75	WM490V	WR-15	UG-385/U	4.31 cm (1.70 in)	0.89 cm (.350 in)	2.29 cm (.900 in)	40 g (1.5 oz)
60-90	WM490E	WR-12	UG-387/U	4.31 cm (1.70 in)	0.89 cm (.350 in)	2.29 cm (.900 in)	40 g (1.5 oz)
75-110	WM490W	WR-10	UG-387/U-M	4.31 cm (1.70 in)	0.89 cm (.350 in)	2.29 cm (.900 in)	40 g (1.5 oz)
90-140	WM490F	WR-08	UG-387/U-M2	4.31 cm (1.70 in)	0.89 cm (.350 in)	2.29 cm (.900 in)	40 g (1.5 oz)
110-170	WM490D	WR-06	UG-387/U-M2	4.31 cm (1.70 in)	0.89 cm (.350 in)	2.29 cm (.900 in)	40 g (1.5 oz)
140-220	WM490G	WR-05	UG-387/U-M2	4.31 cm (1.70 in)	0.89 cm (.350 in)	2.29 cm (.900 in)	40 g (1.5 oz)
220-325	119-1728-00 G-J Band flange transition	WR-05 WR-03	74-003 74-005	—			—

Notes:

- ¹ Physical dimensions exclude contribution due to the diameter of round waveguide flanges in U, V, E, W, F, D and G bands.
2. All mixers are equipped with standard UG-XXX/U type flanges as indicated. Flange adaptors to standard MIL-F-3922 type flanges are provided in F, D, and G bands at no additional charge.
3. All mixers include a protective flange cover, an LO/IF port protective shorting cap, and two captive flange screws for round flange mixers.

For further information, contact:

U.S.A., Asia, Australia, Central &
South America, Japan
Tektronix, Inc.
P.O. Box 1700

Beaverton, Oregon 97075
For additional literature, or the
address and phone number of the
Tektronix Sales Office nearest you,
contact:

Phone: 800/547-1512
Oregon only 800/452-1877
TWX: 910-467-8708
TLX: 15-1754
Cable: TEKTRONIX

Europe, Africa,
Middle East
Tektronix Europe B.V.
European Headquarters
Postbox 827
1180 AV Amstelveen
The Netherlands
Phone: (20) 471146
Telex: i8312 - 18328

Canada
Tektronix Canada Inc.
P.O. Box 6500
Barrie Ontario L4M 4V3
Phone: 705/737-2700

Tektronix sales and service
offices around the world:

Albania, Algeria, Angola, Argentina,
Australia, Austria, Bangladesh,
Belgium, Bolivia, Brazil, Canada,
Peoples Republic of China, Chile,
Colombia, Costa Rica,
Czechoslovakia, Denmark, East
Africa, Ecuador, Egypt, Federal
Republic of Germany, Finland,
France, Greece, Hong Kong,
Hungary, Iceland, India, Indonesia,
Ireland, Israel, Italy, Ivory Coast,
Japan, Jordan, Korea, Kuwait,
Lebanon, Malaysia, Mexico,
Morocco, The Netherlands, New
Zealand, Nigeria, Norway, Pakistan,
Panama, Peru, Philippines, Poland,
Portugal, Qatar, Republic of South
Africa, Romania, Saudi Arabia,
Singapore, Spain, Sri Lanka,
Sudan, Sweden, Switzerland, Syria,
Taiwan, Thailand, Turkey, Tunisia,
United Kingdom, Uruguay, USSR,
Venezuela, Yugoslavia, Zambia,
Zimbabwe.

Copyright is 1983, Tektronix, Inc. All
rights reserved. Printed in U.S.A.
Tektronix products are covered by U.S.
and foreign patents, issued and
pending. Information in this publication
supersedes that in all previously
published material. Specification and
price change privileges reserved.
TEKTRONIX, TEK, SCOPE-MOBILE,
TELEQUIPMENT, and  are
registered trademarks. For further
information, contact: Tektronix, Inc.,
P.O. Box 500, Beaverton, OR 97077.
Phone: (503) 627-7111; TWX 910-467-
8708; TLX: 15-1754; Cable:
TEKTRONIX Subsidiaries and
distributors worldwide.

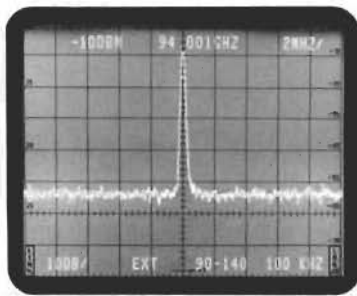

Spectral purity of 94 GHz
signal using Tektronix
external waveguide mixers.

**Performance
worth the
name**

Tektronix
COMMITTED TO EXCELLENCE