

Service Manual



TSG 95 PAL/NTSC Signal Generator

070-8917-04

Warning

The servicing instructions are for use by qualified personnel only. To avoid personal injury, do not perform any servicing unless you are qualified to do so. Refer to all safety summaries prior to performing service.

Copyright © Tektronix, Inc. All rights reserved.

Tektronix products are covered by U.S. and foreign patents, issued and pending. Information in this publication supercedes that in all previously published material. Specifications and price change privileges reserved.

Printed in the U.S.A.

Tektronix, Inc., P.O. Box 1000, Wilsonville, OR 97070-1000

TEKTRONIX and TEK are registered trademarks of Tektronix, Inc.

WARRANTY

Tektronix warrants that the products that it manufactures and sells will be free from defects in materials and workmanship for a period of one (1) year from the date of shipment. If a product proves defective during this warranty period, Tektronix, at its option, either will repair the defective product without charge for parts and labor, or will provide a replacement in exchange for the defective product.

In order to obtain service under this warranty, Customer must notify Tektronix of the defect before the expiration of the warranty period and make suitable arrangements for the performance of service. Customer shall be responsible for packaging and shipping the defective product to the service center designated by Tektronix, with shipping charges prepaid. Tektronix shall pay for the return of the product to Customer if the shipment is to a location within the country in which the Tektronix service center is located. Customer shall be responsible for paying all shipping charges, duties, taxes, and any other charges for products returned to any other locations.

This warranty shall not apply to any defect, failure or damage caused by improper use or improper or inadequate maintenance and care. Tektronix shall not be obligated to furnish service under this warranty a) to repair damage resulting from attempts by personnel other than Tektronix representatives to install, repair or service the product; b) to repair damage resulting from improper use or connection to incompatible equipment; c) to repair any damage or malfunction caused by the use of non-Tektronix supplies; or d) to service a product that has been modified or integrated with other products when the effect of such modification or integration increases the time or difficulty of servicing the product.

THIS WARRANTY IS GIVEN BY TEKTRONIX IN LIEU OF ANY OTHER WARRANTIES, EXPRESS OR IMPLIED. TEKTRONIX AND ITS VENDORS DISCLAIM ANY IMPLIED WARRANTIES OF MERCHANTABILITY OR FITNESS FOR A PARTICULAR PURPOSE. TEKTRONIX' RESPONSIBILITY TO REPAIR OR REPLACE DEFECTIVE PRODUCTS IS THE SOLE AND EXCLUSIVE REMEDY PROVIDED TO THE CUSTOMER FOR BREACH OF THIS WARRANTY. TEKTRONIX AND ITS VENDORS WILL NOT BE LIABLE FOR ANY INDIRECT, SPECIAL, INCIDENTAL, OR CONSEQUENTIAL DAMAGES IRRESPECTIVE OF WHETHER TEKTRONIX OR THE VENDOR HAS ADVANCE NOTICE OF THE POSSIBILITY OF SUCH DAMAGES.



DECLARATION OF CONFORMITY

We

Tektronix, Inc.
Television Products Division
P.O. Box 500
Beaverton, Oregon U.S.A.

declare under our sole responsibility that the

TSG 95 PAL/NTSC Signal Generator

to which this declaration relates is in conformity with the following standards:

EN50081-1, Generic Emission Standard
EN50082-1, Generic Immunity Standard
EN60555-2, Power Line Harmonics Standard

following the provisions of the Directive(s) of the Council of the European Union:

EMC Directive 89/366/EEC.

Original Declaration Of Conformity is on file with:
Tektronix Holland N.V.
Marktweg 73A
8444 AB Heerenveen
The Netherlands

Table of Contents

List of Figures	ii
List of Tables	iii
General Safety Summary	v
Service Safety Summary	vii
Specifications	1-1
Introduction	1-1
Reference Documentation	1-1
Performance Conditions	1-2
Safety Standard Compliance	1-2
EMI Compliance	1-2
Specification Tables	1-3
PAL Waveform Diagrams	1-14
NTSC Waveform Diagrams	1-28
Operating Information	2-1
Getting Started	2-1
Supplying Power	2-2
Connecting the TSG 95	2-4
Keypad and Display Conventions	2-4
Definitions	2-5
Preliminary Settings	2-5
Other Settings	2-6
Using Your TSG 95	2-7
Theory of Operation	3-1
Circuit Description	3-1
Performance Verification and Adjustment Procedures	4-1
Required Test Equipment	4-1
Performance Verification Checklist	4-3
Performance Verification Procedures	4-4
Adjustment Checklist	4-22
Adjustment Procedures	4-24
Maintenance	5-1
Battery Hints	5-1
Preventive Maintenance	5-2
Troubleshooting Aids	5-3
The Utility Menu	5-4
Corrective Maintenance	5-11
Replacing Assemblies	5-12
Replaceable Electrical Parts	6-1
Parts Ordering Information	6-1
Using the Replaceable Electrical Parts List	6-1
Column Descriptions	6-2
Cross Index – Mfr. Code Number To Manufacturer	6-3

Replaceable Electrical Parts	6-4
Diagrams and Circuit Board Illustrations	7-1
Replaceable Mechanical Parts	8-1
Parts Ordering Information	8-1
Using the Replaceable Mechanical Parts List	8-1
Column Descriptions	8-2
Cross Index – Mfr. Code Number To Manufacturer	8-3
Replaceable Mechanical Parts	8-3

List of Figures

Figure 1-1: PAL 75% Color Bars	1-14
Figure 1-2: PAL 100% Color Bars	1-14
Figure 1-3: PAL 75% Red and Red Field	1-15
Figure 1-4: PAL 100% Red	1-15
Figure 1-5: PAL Green Field	1-16
Figure 1-6: PAL Blue Field	1-16
Figure 1-7: PAL 50% Flat Field	1-17
Figure 1-8: PAL 100% Flat Field	1-17
Figure 1-9: PAL 0% Flat Field	1-18
Figure 1-10: PAL Convergence (vertical lines)	1-18
Figure 1-11: PAL Convergence (horizontal lines)	1-19
Figure 1-12: PAL 5 Step (Gray Scale)	1-19
Figure 1-13: PAL Modulated 5 Step	1-20
Figure 1-14: PAL Multiburst	1-20
Figure 1-15: PAL Reduced Sweep	1-21
Figure 1-16: PAL Pluge	1-21
Figure 1-17: PAL Matrix Signal — CCIR 17	1-22
Figure 1-18: PAL Matrix Signal — CCIR Line 330	1-22
Figure 1-19: PAL Matrix Signal — CCIR Line 331	1-23
Figure 1-20: PAL Matrix Signal — CCIR 18	1-23
Figure 1-21: PAL Matrix Signal — (Sin x)/x	1-24
Figure 1-22: PAL Matrix Signal — 15 kHz Square Wave	1-24
Figure 1-23: PAL Matrix Signal — Shallow Ramp	1-25
Figure 1-24: PAL Matrix Signal — UK ITS 1	1-25
Figure 1-25: PAL Matrix Signal — UK ITS 2	1-26
Figure 1-26: PAL Safe Area	1-27
Figure 1-27: SMPTE (NTSC) Color Bar Components	1-28
Figure 1-28: SMPTE (NTSC) Color Bars, Zero Setup	1-29
Figure 1-29: NTSC 75% Color Bars	1-30
Figure 1-30: NTSC 75% Color Bars, Zero Setup	1-30

Figure 1–31: NTSC Red Field	1–31
Figure 1–32: NTSC Red Field, Zero Setup	1–31
Figure 1–33: NTSC (Sin x)/x	1–32
Figure 1–34: NTSC 5 Step Staircase (Gray Scale)	1–32
Figure 1–35: NTSC 0 IRE No Burst	1–33
Figure 1–36: NTSC 30 IRE and 50 IRE Flat Fields	1–33
Figure 1–37: NTSC Black Burst	1–34
Figure 1–38: NTSC Black Burst, Zero Setup (and Bounce, Low)	1–34
Figure 1–39: NTSC 100 IRE, Field Square Wave (and Bounce, High) ..	1–35
Figure 1–40: NTSC Multiburst	1–35
Figure 1–41: NTSC Convergence Components	1–36
Figure 1–42: NTC7 (NTSC) Composite	1–37
Figure 1–43: NTC7 (NTSC) Combination	1–37
Figure 1–44: FCC (NTSC) Composite	1–38
Figure 1–45: NTSC Cable Multiburst	1–38
Figure 1–46: NTSC Cable Sweep	1–39
Figure 1–47: NTSC Matrix	1–39
Figure 1–48: NTSC Safe Area	1–40
Figure 3–1: TSG 95 Block Diagram	3–1
Figure 4–1: XLR Female to Mini XLR Male Adapter Cable/Pinout ..	4–2
Figure 4–2: A Setup for Verifying the Oscillator Frequency	4–8
Figure 4–3: VM700A Horizontal Timing Measurement Screen	4–9
Figure 4–4: VM700A Luminance “Non Linearity” Measurement Screen	4–10
Figure 4–5: VM700A “Multi Burst” Measurement Screen	4–12
Figure 4–6: VM700A Horizontal Timing Measurement Screen	4–14
Figure 4–7: VM700A Luminance “Non Linearity” Measurement Screen	4–16
Figure 4–8: VM700A Bar Level Measurement Screen	4–17
Figure 4–9: VM700A “Multi Burst” Measurement Screen	4–19
Figure 4–10: VM700A Level Meter Screen	4–25

List of Tables

Table 1–1: General PAL Test Signal Characteristics	1–3
Table 1–2: Unique PAL Test Signal Characteristics	1–4
Table 1–3: PAL Vertical Interval Test Signals (VITS)	1–6
Table 1–4: General NTSC Test Signal Characteristics	1–7
Table 1–5: Unique NTSC Test Signal Characteristics	1–8
Table 1–6: NTSC and NTSC JAPAN VITS	1–12
Table 1–7: Character Identification	1–12
Table 1–8: Audio Tone	1–12

Table of Contents

Table 1-9: Physical Characteristics	1-12
Table 1-10: Power Supply	1-13
Table 1-11: Environmental Characteristics	1-13
Table 2-1: TSG 95 Video Test Signals	2-8
Table 4-1: Required Test Equipment	4-1

General Safety Summary

Review the following safety precautions to avoid injury and prevent damage to this product or any products connected to it. To avoid potential hazards, use this product only as specified.

Only qualified personnel should perform service procedures.

To Avoid Fire or Personal Injury

Observe All Terminal Ratings. To avoid fire or shock hazard, observe all ratings and markings on the product. Consult the product manual for further ratings information before making connections to the product.

Replace Batteries Properly. Before replacing batteries, turn the instrument off and disconnect the AC adapter.

Use only the size and type of batteries specified for this product. Be sure to install the batteries in the proper polarity. Use care not to short battery terminals together when replacing batteries.

When replacing alkaline batteries, all batteries should be replaced at the same time.

Recharge Batteries Properly. Do not attempt to recharge alkaline batteries.

Do not attempt to recharge alkaline batteries.

Recharge NiCad batteries only in accordance with the instructions provided in this manual. Do not continue recharging for longer periods than recommended in the instructions.

Replace the NiCad battery pack if the batteries do not recharge within the recommended time, or if the operating time from a full charge seems significantly shortened.

Use Proper AC Adapter. Use only the specified AC adapter provided with this product to connect it to the mains (local AC) supply.

Use Proper Fuse. Use only the fuse type and rating specified for this product.

Do Not Operate in Wet/Damp Conditions.

Do Not Operate in an Explosive Atmosphere.

Symbols and Terms

Terms in this Manual. These terms may appear in this manual:



WARNING. *Warning statements identify conditions or practices that could result in injury or loss of life.*



CAUTION. *Caution statements identify conditions or practices that could result in damage to this product or other property.*

Terms on the Product. These terms may appear on the product:

DANGER indicates an injury hazard immediately accessible as you read the marking.

WARNING indicates an injury hazard not immediately accessible as you read the marking.

CAUTION indicates a hazard to property including the product.

Symbols on the Product. The following symbols may appear on the product:



CAUTION
Refer to Manual



Double
Insulated

Battery Recycling

This product contains a Nickel Cadmium (NiCd) battery, which must be recycled or disposed of properly. For the location of a local battery recycler in the U.S. or Canada, please contact:

RBRC
Rechargeable Battery Recycling Corp.
P.O. Box 141870
Gainesville, Florida 32614

(800) BATTERY
(800) 227-7379
www.rbrc.com



Service Safety Summary

Only qualified personnel should perform service procedures. Read this *Service Safety Summary* and the *General Safety Summary* before performing any service procedures.

Use the Proper Fuse

Use only the type and rating fuse specified for this product.

Specifications

Introduction

The material in this section is organized into two main groupings: the specification tables and the supporting figures. The specification tables include:

- General signal characteristics and specifications.
- Signal level specifications.
- Power supply, physical, and environmental specifications.

The supporting figures (waveform diagrams and related data) follow the specification tables.

Reference Documentation

The following documents were used as references in the preparation of this specification:

Product Classification Environmental Test Summary, 13 June 1977;
Tektronix Standard 062-2853-00

Electromagnetic Compatibility Environmental Test, 31 March 1977;
Tektronix Standard 062-2866-00

Recommendations and reports of the CCIR, 1978; Transmission of Sound
Broadcasting and Television Signals Over Long Distances (CMTT)

IEEE Standard Dictionary of Electrical Terms, Second Edition (1977); IEEE
Standard 100-1977

Safety Standard for Electrical and Electronic Test, Measuring, Controlling,
and Related Equipment, February 1988; ANSI/ISA-S82.01

International Electrotechnical Commission Standard "Safety Requirements
for Electronic Measuring Apparatus"; IEC 348

Canadian Standards Association Electrical Standard for Electrical and
Electronic Measuring and Testing Equipment; CAN/CSA C22.2 No. 231

Standard for Electrical and Electronic Measuring and Testing Equipment,
Second Edition, July 21, 1980

Performance Conditions

The Performance Requirements are valid if the instrument has been adjusted at approximately 25° C, is being operated within environmental limits (see Table 1–11), and has had a minimum warm-up of 20 minutes.

Safety Standard Compliance

The following safety standards apply to the TSG 95:

- ANSI S82 — Safety Standard for Electrical and Electronic Test, Measuring, Controlling, and Related Equipment, 1988.
- CAN/CSA C22.2 No. 231 M89 — CSA Safety Requirements for Electrical and Electronic Measuring and Test Equipment.
- IEC1010-1 — Safety Requirements for Electrical Equipment for Measurement, Control, and Laboratory Use (1990).
- UL1244 — Standard for Electrical and Electronic Measuring and Testing Equipment, Second Edition (1980).

EMI Compliance

The following electromagnetic interference (EMI) regulatory requirements are applicable to the TSG 95:

- 47 CFR, Chapter 1 (FCC Rules), Part 15, Class A
- EN 50 081-1 Generic Emission Standard. Part 1: Residential, commercial and light industry.
- EN 50 082-1 Generic Immunity Standard. Part 1: Residential, commercial and light industry.

NOTE. *Shielded cables were used in the certification of this instrument; therefore, shielded cables are recommended to be used when operating. (EC 92)*

Specification Tables

Table 1–1: General PAL Test Signal Characteristics

Characteristic	Performance Requirements	Supplemental Information
Luminance Amplitude Accuracy	$\pm 1\%$ of 700 mV	
Chrominance-to-Luminance Gain	$\pm 2\%$ of 700 mV	1% typical
Blanking Level	0 V \pm 50 mV	
Rise Time Accuracy	$\pm 10\%$	Except where otherwise specified
Burst Amplitude	300 mV \pm 2% of 700 mV	
Sync Amplitude	300 mV \pm 2% of 700 mV	
Sync Rise Time	250 ns	
Output Impedance		75 Ω
Return Loss		≥ 36 dB at 4.2 MHz
Subcarrier Stability	4.43361875 MHz \pm 10 Hz	Over a temperature range of 0 to +40° C. Annual adjustment required.
Signal-to-Noise Ratio		≥ 60 dB; signal passed through a continuous random noise measurement low pass filter, $F_c=5$ MHz.
Chrominance-to-Luminance Delay	≤ 10 ns	≤ 5 ns typical
SCH Phase	0° \pm 5°	
Frequency Response	Flat within $\pm 2\%$ to 4.8 MHz, $\pm 3\%$ to 5.8 MHz	(Sin x)/x ± 1 dB to 5 MHz
Field Tilt	$\leq 0.5\%$	
Line Tilt	$\leq 0.5\%$	
5 Step Linearity Error	$\leq 1\%$	Relative step matching.
Differential Gain	$\leq 1\%$	$\leq 0.5\%$ typical
Differential Phase	$\leq 1^\circ$	
2T Pulse K-Factor	$\leq 0.5\%$	Ringings $\leq 1.5\%$ peak.
Luminance Rise Time	Digitally derived	250 ns \pm 50 ns, except where otherwise specified.
Chrominance Rise Time	Digitally derived	350 ns \pm 50 ns, except where otherwise specified.
Burst Rise Time	Digitally derived	350 ns \pm 50 ns. Greater than BBC specifications to avoid ringing.
Line Timing	Digitally derived	All signals comply with PAL timing specifications; see Figures 1–1 through 1–25.
Front Porch Duration	Digitally derived	1.55 μ s minimum
Line Blanking Interval	Digitally derived	12.0 μ s \pm 0.15 μ s Measured at the 50% point of active video.
Breezeway Duration	Digitally derived	900 ns \pm 50 ns
Line Sync Duration	Digitally derived	4.7 μ s \pm 50 ns at half-amplitude
Vertical Serration Duration	Digitally derived	4.7 μ s \pm 50 ns at half-amplitude

Table 1-1: General PAL Test Signal Characteristics (Cont.)

Characteristic	Performance Requirements	Supplemental Information
Equalizing Pulse Duration	Digitally derived	2.35 μ s \pm 50 ns at half-amplitude
Burst Delay from Sync Duration	Digitally derived	5.6 μ s \pm 50 ns from Sync half-amplitude point 2.25 μ s \pm 0.1 μ s (10 cycles of subcarrier)

Table 1-2: Unique PAL Test Signal Characteristics

Characteristic	Information		
<i>75% Bars</i> Luminance Rise Times	See Figure 1-1. 150 ns		
Packet Characteristics	Luminance Amplitude (Pedestal, mV)	Subcarrier Amplitude (mV _{p-p})	Subcarrier Phase (degrees)
White	700.0	0.0	0.0
Yellow	465.1	470.5	167.1
Cyan	368.0	663.8	283.5
Green	308.2	620.1	240.7
Magenta	216.8	620.1	60.7
Red	157.0	663.8	103.5
Blue	59.9	470.5	347.1
<i>100% Bars</i> Luminance Rise Times	See Figure 1-2. 150 ns		
Packet Characteristics	Luminance Amplitude (Pedestal, mV)	Subcarrier Amplitude (mV _{p-p})	Subcarrier Phase (degrees)
White	700.0	0.0	0.0
Yellow	620.2	627.3	167.1
Cyan	490.7	885.1	283.5
Green	410.9	826.8	240.7
Magenta	289.1	826.8	60.7
Red	209.3	885.1	103.5
Blue	79.8	627.3	347.1
<i>75% Bars over Red</i> Luminance Rise Times	See Figures 1-1 and 1-3. 150 ns		
Field Timing			
Color Bars	Lines 24-166 & 336-478		
Red	Lines 167-310 & 479-622		
Packet Characteristics	See 75% Bars, above.		

Table 1-2: Unique PAL Test Signal Characteristics (Cont.)

Characteristic	Information
<i>100% Bars over Red</i> Luminance Rise Times Field Timing Color Bars Red Bars Packet Characteristics Red Luminance Pedestal Red Chrominance Amplitude Red Chrominance Phase	See Figures 1-2 and 1-4. 150 ns Lines 24-166 & 336-478 Lines 167-310 & 479-622 See 100% Bars, above. 209.3 mV 885.1 mV _{p-p} 103.5°
<i>Convergence</i> Amplitude Pattern Pulse HAD	See Figures 1-10 and 1-11. 525.0 mV 19 vert. lines and 14 horiz. lines per field 225 ns
<i>Pluge</i> Pluge Levels Lum Ref Levels	See Figure 1-16. -14 mV and +14 mV 700 mV, 450 mV, 200 mV, and 110 mV
<i>Safe Area</i> Amplitude	See Figure 1-26. 525 mV
<i>Green Field</i> Luminance Pedestal Chrominance Amplitude Chrominance Phase	See Figure 1-5. 308.2 mV 620.1 mV _{p-p} 240.7°
<i>Blue Field</i> Luminance Pedestal Chrominance Amplitude Chrominance Phase	See Figure 1-6. 59.9 mV 470.5 mV _{p-p} 347.1°
<i>Red Field</i> Luminance Pedestal Chrominance Amplitude Chrominance Phase	See Figure 1-4. 157.0 mV 663.8 mV _{p-p} 103.5°
<i>Flat Field</i> 50% 100% 0%	350 mV; see Figure 1-7. 700 mV; see Figure 1-8. 0 mV; see Figure 1-9.
<i>5 Step (Gray Scale)</i> Amplitude	See Figure 1-12. 700 mV
<i>Modulated 5 Step</i> Luminance Amplitude Chrominance Amplitude Chrominance Phase	See Figure 1-13. 700, 560, 420, 280, and 140 mV 280.0 mV _{p-p} 60.7°
<i>Multiburst</i> White Reference Bar Amplitude Packet Amplitudes Pedestal Burst Frequencies Packet Rise Time	See Figure 1-14. 420 mV _{p-p} 420 mV _{p-p} (equal width packets) 350 mV 0.5, 1.0, 2.0, 4.0, 4.8, and 5.8 MHz 350 ns typical

Table 1-2: Unique PAL Test Signal Characteristics (Cont.)

Characteristic	Information
<i>60% Reduced Line Sweep</i> Frequency Amplitude Markers	See Figure 1-15. 500 Hz to 6.5 MHz 420 mV _{p-p} 1, 2, 3, 4, 5, and 6 MHz
<i>Bounce</i> Amplitude Rate	See Figures 1-9 and 1-8. 0 or 700 mV flat field ≈ 1.0 second high, ≈ 1.0 second low
<i>Matrix (Signal)</i> CCIR 17 CCIR 330 CCIR 331 CCIR 18 75% Color Bars (Sin x)/x 75% Red Field 15 kHz Square Wave 50% Flat Field Shallow Ramp UK ITS 1 UK ITS 2	(Lines) 24-47 & 336-359; see Figure 1-17. 48-71 & 360-383; see Figure 1-18. 72-95 & 384-407; see Figure 1-19. 96-119 & 408-431; see Figure 1-20. 120-143 & 432-455; see Figure 1-1. 144-166 & 456-478; see Figure 1-21. 167-190 & 479-502; see Figure 1-3. 191-214 & 503-526; see Figure 1-22. 215-238 & 527-550; see Figure 1-9. 239-262 & 551-574; see Figure 1-23. 263-286 & 575-598; see Figure 1-24. 287-310 & 599-622; see Figure 1-25.
<i>Field Square Wave</i> Field Timing Lines (White) Lines at Blanking Amplitude	Lines 89-244 (and 401-556); see Figure 1-8. All remaining active lines; see Figure 1-9. 700 mV

Table 1-3: PAL Vertical Interval Test Signals (VITS)

Waveform	Line(s)
CCIR 17	17
CCIR 18	18
ITS 1	19 and 332
ITS 2	20 and 333
CCIR 330	330
CCIR 331	331

Table 1-4: General NTSC Test Signal Characteristics

Characteristic	Performance Requirements	Supplemental Information
Luminance Amplitude Accuracy	$\pm 1\%$ of 714.3 mV (± 1 IRE)	
Chrominance-to-Luminance Gain	$\pm 2\%$ of 714.3 mV (± 2 IRE)	1% typical
Blanking Level	0 V \pm 50 mV	
Rise Time Accuracy	$\pm 10\%$	Except where otherwise specified.
Burst Amplitude	285.7 mV (40 IRE) $\pm 2\%$ of 100 IRE	
Sync Amplitude	285.7 mV (40 IRE) $\pm 2\%$ of 100 IRE	
Sync Rise Time	140 ns \pm 20 ns	
Output Impedance		75 Ω
Return Loss		≥ 36 dB at 4.2 MHz
Subcarrier Stability	3.579545 MHz \pm 10 Hz	Over a temperature range of 0 to +40° C. Annual adjustment required.
Signal-to-Noise Ratio		≥ 60 dB; signal passed through a continuous random noise measurement low pass filter, $F_c=5$ MHz.
Chrominance-to-Luminance Delay	≤ 15 ns	10 ns typical. Measured with the NTC7 Composite signal.
SCH Phase	0° \pm 5°	
Frequency Response	Flat within $\pm 2\%$ to 4.2 MHz	(Sin x)/x ± 1 dB to 4.2 MHz
Field Tilt	$\leq 0.5\%$	
Line Tilt	$\leq 0.5\%$	
5 Step Linearity Error	$\leq 1\%$	Relative step matching.
Differential Gain	$\leq 1\%$	$\leq 0.5\%$ typical
Differential Phase	$\leq 1^\circ$	
2T Pulse K-Factor	$\leq 0.5\%$	Ringings $\leq 1.5\%$ peak
Luminance Rise Time	Digitally derived	250 ns
Chrominance Rise Time	Digitally derived	400 ns
Burst Rise Time	Digitally derived	400 ns
Line Timing	Digitally derived	See Figures 1-27 through 1-48.
Front Porch Duration	Digitally derived	1.5 μ s \pm 0.1 μ s
Line Blanking Interval	Digitally derived	10.9 μ s \pm 0.2 μ s Measured at the 20 IRE point of active video.
Breezeway Duration	Digitally derived	600 ns \pm 100 ns
Line Sync Duration	Digitally derived	4.7 μ s \pm 100 ns Half-amplitude duration (HAD)
Vertical Serration Duration	Digitally derived	4.7 μ s \pm 100 ns HAD
Equalizing Pulse Duration	Digitally derived	2.3 μ s \pm 100 ns HAD
Burst		
Delay from Sync	Digitally derived	5.308 μ s \pm 35 ns (19 cycles of subcarrier)
Duration		2.51 μ s \pm 0.1 μ s (9 cycles of subcarrier)

Table 1-5: Unique NTSC Test Signal Characteristics

Characteristic	Information		
<i>SMPTE Bars</i>	See Figure 1-27.		
Rise Times			
Luminance	140 ns		
Chrominance			
-I	250 ns		
Q	833 ns		
Field Timing			
Color Bars	Lines 21-182; see Figure 1-27a.		
Reverse Blue Bars	Lines 183-202; see Figure 1-27b.		
IYQB	Lines 203-262; see Figure 1-27c.		
Packet Characteristics	Luminance Amplitude (Pedestal, mV)	Subcarrier Amplitude (mV _{p-p})	Subcarrier Phase (degrees)
White	549.1	00.0	00.0
Yellow	492.6	443.3	167.1
Cyan	400.9	626.6	283.5
Green	344.5	585.2	240.7
Magenta	258.2	585.2	60.7
Red	201.7	626.6	103.5
Blue	110.1	443.3	347.1
-I	53.6	285.7	303.0
Q	53.6	285.7	33.0
<i>SMPTE Bars, Zero Setup</i>	See Figure 1-28.		
Rise Times			
Luminance	140 ns		
Chrominance			
-I	250 ns		
Q	833 ns		
Field Timing			
Color Bars	Lines 21-182; see Figure 1-28.		
Reverse Blue Bars	Lines 183-202; see Figure 1-28b.		
IYQB	Lines 203-262; see Figure 1-28c.		
Packet Characteristics	Luminance Amplitude (Pedestal, mV)	Subcarrier Amplitude (mV _{p-p})	Subcarrier Phase (degrees)
White	535.1	00.0	00.0
Yellow	476.8	479.3	167.1
Cyan	375.0	677.5	283.5
Green	316.1	632.6	240.7
Magenta	219.6	632.6	60.7
Red	160.7	677.5	103.5
Blue	58.9	479.3	347.1
-I	0.0	285.7	303.0
Q	0.0	285.7	33.0

Table 1-5: Unique NTSC Test Signal Characteristics (Cont.)

Characteristic	Information
<i>SNG Bars (Matrix), Zero Setup Only</i> 30 IRE Flat Field SMPTE Bars, Zero Setup IYQB	Field Lines (inclusive): 21-162 and 209-262; see Figure 1-36. 163-197; see Figure 1-28a. 198-208; see Figure 1-28c.
<i>75% Color Bars</i>	Full Field Color Bars; 75% Amplitude, 7.5% Setup with a 100 IRE White Flag. See Figure 1-29
<i>75% Color Bars, Zero Setup</i>	Full Field Color Bars; 75% Amplitude, Zero Setup with a 100 IRE White Flag. See Figure 1-30.
<i>Red Field</i> Luminance Pedestal Chrominance Amplitude Chrominance Phase	See Figure 1-31. 201.74 mV (28.3 IRE) 626.66 mV _{p-p} (87.8 IRE) 103.5°
<i>Red Field, Zero Setup</i> Luminance Pedestal Chrominance Amplitude Chrominance Phase	See Figure 1-32. 160.14 mV (22.4 IRE) 677.08 mV _{p-p} (94.8 IRE) 103.5°
<i>(Sin x)/x</i> Spectrum	See Figure 1-33. -3 dB at 4.75 MHz
<i>5 Step Staircase</i> Amplitude	See Figure 1-34. 714.3 mV (100 IRE)
<i>0 IRE No Burst</i>	0 mV; see Figure 1-35.
<i>50 IRE Flat Field</i> Amplitude	See Figure 1-36. 357.2 mV
<i>100 IRE Flat Field</i> Amplitude	See Figure 1-39. 714.3 mV
<i>Black Burst</i> Amplitude	See Figure 1-37. 53.57 mV (7.5 IRE)
<i>Black Burst, Zero Setup</i>	0 mV (0 IRE); see Figure 1-38.
<i>Bounce</i> Amplitude Rate	See Figures 1-38 and 1-39. 0 or 100 IRE flat field ≈ 1.0 second high, ≈ 1.0 second low
<i>Field Square Wave</i> Field Timing Lines (White) Lines at Blanking Amplitude	See Figure 1-39. Lines 70-213 All remaining active lines 714.3 mV (100 IRE)

Table 1-5: Unique NTSC Test Signal Characteristics (Cont.)

Characteristic	Information
<i>Multiburst</i>	See Figure 1-40.
Amplitudes	
White Reference Bar	500 mV (70 IRE)
Packets	428.6 mV _{p-p} (60 IRE), Equal width packets
Pedestal	285.7 mV (40 IRE)
Burst Frequencies	0.5, 1.0, 2.0, 3.0, 3.58, and 4.2 MHz
Packet Rise Time	
0.5 MHz	140 ns typical (sine-squared packets)
All Other Packets	400 ns typical (sine-squared packets)
<i>Convergence</i>	See Figure 1-41.
Amplitude	549.3 mV (76.9 IRE)
Pattern	Crosshatch: 14 horiz./17 vert. lines per field
Pulse HAD	225 ns
<i>NTC7 Composite</i>	See Figure 1-42.
Bar	
Amplitude	714.3 mV (100 IRE)
Rise Time	125 ns
2T Pulse	
Amplitude	714.3 mV (100 IRE)
HAD	250 ns
Modulated Sin ² Pulse	
Phase	60.8° ± 1°
Amplitude	714.3 mV (100 IRE) at peak amplitude
HAD	1.563 μs
Modulate 5 Step Staircase	
Luminance	642.9 mV (90 IRE)
Chrominance	285.7 mV (40 IRE)
<i>NTC7 Combination</i>	See Figure 1-43.
Multiburst	
Amplitudes	
White Bar	714.3 mV (100 IRE)
Packets	357.2 mV (50 IRE)
Pedestal	357.2 mV (50 IRE)
Burst Frequencies	0.5, 1.0, 2.0, 3.0, 3.58, and 4.2 MHz
Packet Rise Times	
0.5 and 1.0 MHz	140 ns typical (sine-squared packets)
All Other Packets	400 ns typical (sine-squared packets)
Modulated Pedestal	
Pedestal Amplitude	357.2 mV (50 IRE)
Chrominance Amplitudes	142.9 mV (20 IRE), 285.7 mV (40 IRE), and 571.4 mV (80 IRE)
Phase	90°
Rise Time	400 ns

Table 1-5: Unique NTSC Test Signal Characteristics (Cont.)

Characteristic	Information
<i>FCC Composite</i>	See Figure 1-44.
Bar	
Amplitude	714.3 mV (100 IRE)
Rise Time	250 ns
2T Pulse	
Amplitude	714.3 mV (100 IRE)
HAD	250 ns
Modulated Sin ² Pulse	
Phase	60.8° ± 1°
Amplitude	714.3 mV (100 IRE)
HAD	1.563 μs
Modulate 5 Step Staircase	
Luminance	571.4 mV (80 IRE)
Chrominance	285.7 mV (40 IRE)
Rise Time	375 ns
<i>Cable Multiburst</i>	See Figure 1-45.
Amplitudes	
White Reference Bar	428.6 mV (60 IRE)
Packets	428.6 mV _{p-p} (60 IRE), equal width packets
Pedestal	214.3 mV (30 IRE)
Burst Frequencies	0.5, 1.25, 2.0, 3.0, 3.75, and 4.0 MHz
Packet Rise Time	
0.5 MHz	140 ns typical (sine-squared packets)
All Other Packets	400 ns typical (sine-squared packets)
<i>Cable Sweep</i>	See Figure 1-46.
Frequency	100 Hz to 4.2 MHz, lines 21-202
Amplitude	714.28 mV _{p-p} (100 IRE)
Markers	.5, 1, 2, 3, 3.75, and 4 MHz, lines 203-263
<i>Matrix</i>	Field Lines (inclusive, see Figure 1-47):
NTC7 Composite	21-69
NTC7 Combination	70-117
Color Bars	118-165
(Sin x)/x	166-213
50 IRE Flat Field	214-262
<i>Safe Area</i>	See Figure 1-48.
Amplitude	549.1 mV (76.9 IRE)
Safe Title	
Horizontal Bar	Lines 45 and 238
Vertical Timing	14.925 and 56.525 μs
Safe Action	
Horizontal Bar	Lines 33 and 250
Vertical Timing	12.325 and 59.125 μs

Table 1-6: NTSC and NTSC JAPAN VITS

Waveform	Line(s)
NTC7 Composite	17
NTC7 Combination	280

Table 1-7: Character Identification

Characteristic	Information
Number of Characters Displayed	Two lines of up to 16 characters per line
Display Position	Movable within the Safe Action area of the picture. One line (the first) may be in the Vertical Blanking Interval.
Character Amplitude, PAL Character Amplitude, NTSC	Black: 105 mV; White: 630 mV Black: 85.7 mV (12 IRE); White: 585.7 mV (82 IRE)

Table 1-8: Audio Tone

Characteristic	Performance Requirements	Supplemental Information
Amplitude	-10, 0, +4, or +8 dBu into 600 Ω	Default Values. May be recalibrated by qualified technicians.
Amplitude Accuracy	± 0.25 dBu	
Connector Polarity		Pin 1 = GND; Pin 2 = POS (+); Pin 3 = NEG (-)
Output Impedance		50 Ω
Frequency		50, 63, 125, 250, and 400 Hz; 1, 2, 4, 8, 10, 12.5, 16, and 20 kHz; Sweep; Three User frequencies with 1 Hz resolution.
Frequency Accuracy		± 0.5 Hz
Sweep		1 kHz for 5 s followed by 0.5 s at each of the following frequencies: 50, 63, 80, 100, 125, 160, 200, 250, 315, 400, 500, 630, and 800 Hz; then 1, 1.25, 1.6, 2, 2.5, 3.15, 4, 5, 6.3, 8, 10, 12.4, 16, and 20 kHz.
Distortion (THD)	$\leq 1\%$ (20 kHz bandwidth)	$\leq 0.4\%$ typical
Audio ID "click" (click ON)	Channel 1, 1 click Channel 2, 2 clicks	Channel click outputs are offset for positive channel identification.

Table 1-9: Physical Characteristics

Characteristic	Information
Height	5.6 cm (2.2 in)
Width	9.1 cm (3.6 in)
Depth	19.1 cm (7.5 in)

Table 1–9: Physical Characteristics (Cont.)

Characteristic	Information
Net Weight	
TSG 95	0.48 kg (1.06 lb)
TSG 95 with battery pack	0.68 kg (1.5 lb)
Shipping Weight (with AC adapter)	1.50 kg (3.31 lb)

Table 1–10: Power Supply

Characteristic	Performance Requirements	Supplemental Information
DC Input Range	9 to 15 VDC	
Fuse		2 A, 32 V min
Power Limit		
without adapter		3.25 W
with adapter		5.25 W
Power Consumption		Typical (not charging):
Audio and Back light off		2.0 W
Audio and Back light on		2.5 W
Peak Inrush Current		1.95 A @230 VAC, Environment E2

Table 1–11: Environmental Characteristics

Characteristic	Information
Temperature	
Operating	0° C to +50° C (32 to +122° F); IEC 1010-1 compliance to +40° C
Storage	-30° C to +65° C (-22 to +149° F)
Altitude	
Operating	to 15,000 feet (4572 m); IEC 1010-1 compliance to 2000 m
Storage	to 50,000 feet (15420 m)
Equipment Type	Test
Equipment Class	Class III (as defined in IEC 1010-1, Annex H)
Installation Category	Category II (as defined in IEC 1010-1, Annex J) Note: Rated for indoor use only.
Pollution Degree	Pollution Degree 2 (as defined in IEC 1010-1)
Transportation	Meets the requirements of NTSB Test Procedure 1A, category II (24 inch drop)

PAL Waveform Diagrams

NOTE. Time references in the following waveform diagrams apply to the signal half-amplitude points or pulse peaks, unless indicated otherwise.

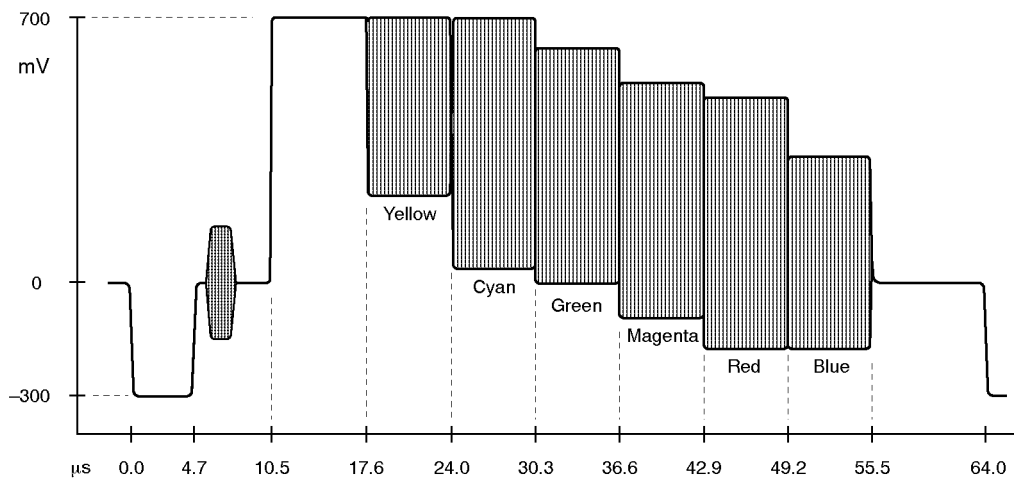

Figure 1-1: PAL 75% Color Bars

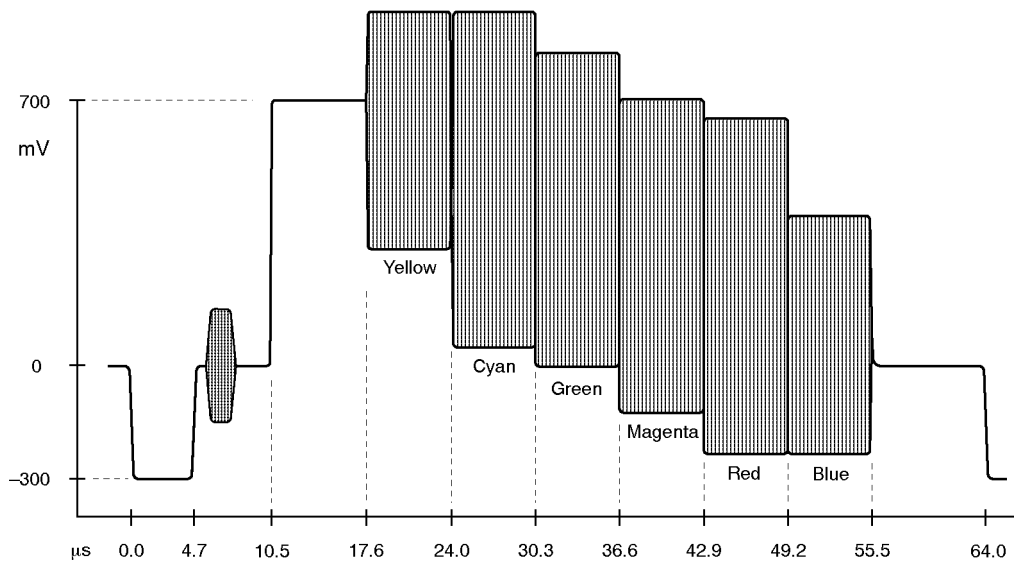

Figure 1-2: PAL 100% Color Bars

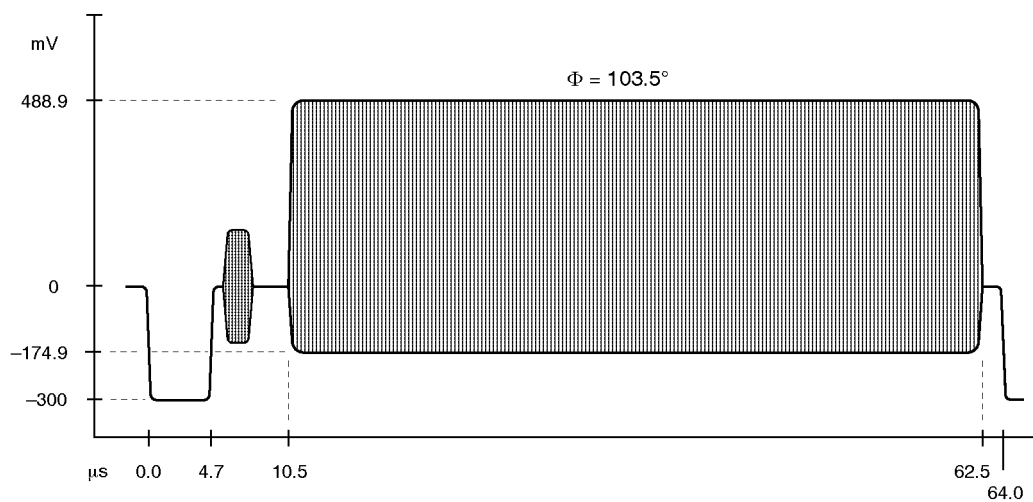

Figure 1-3: PAL 75% Red and Red Field

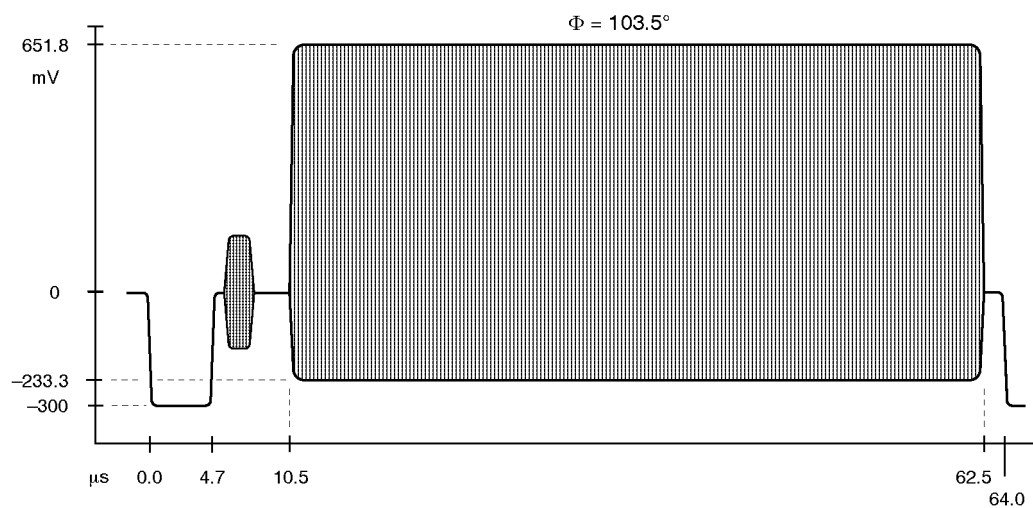

Figure 1-4: PAL 100% Red

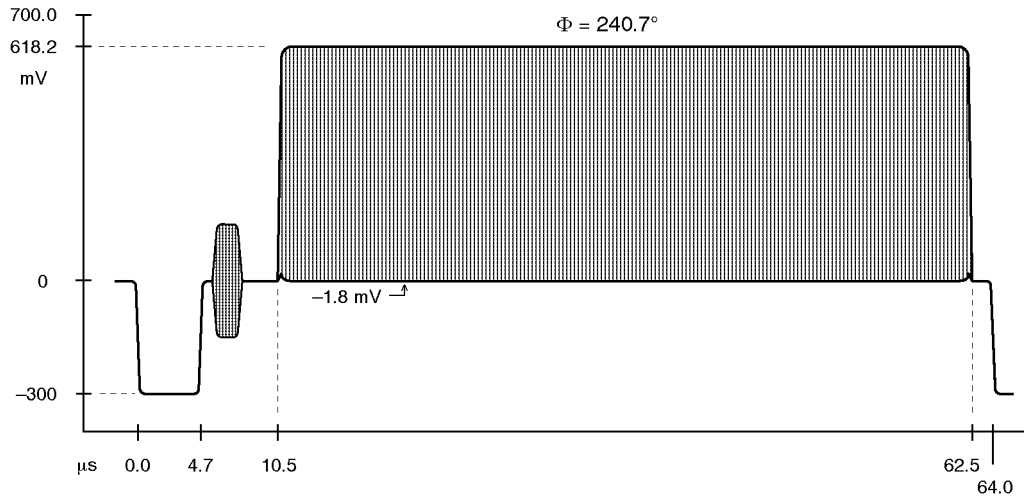

Figure 1-5: PAL Green Field

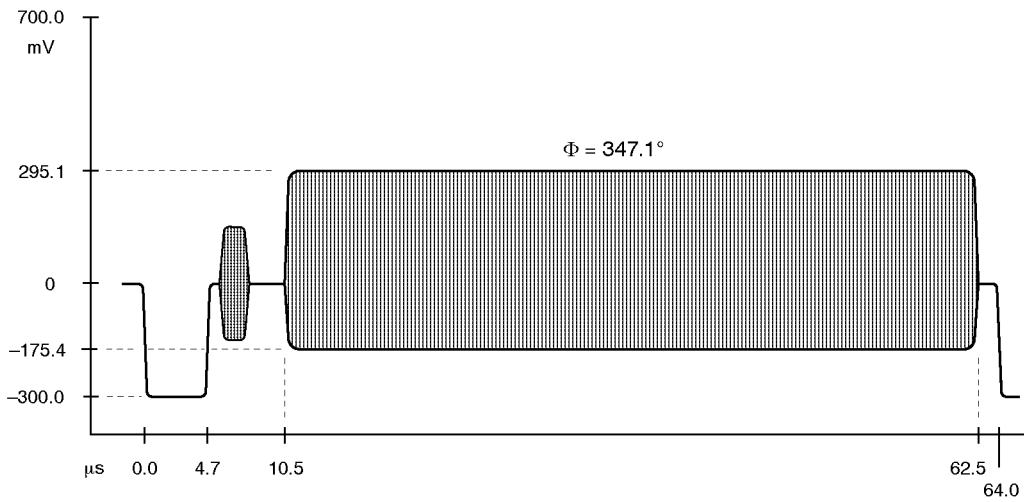

Figure 1-6: PAL Blue Field

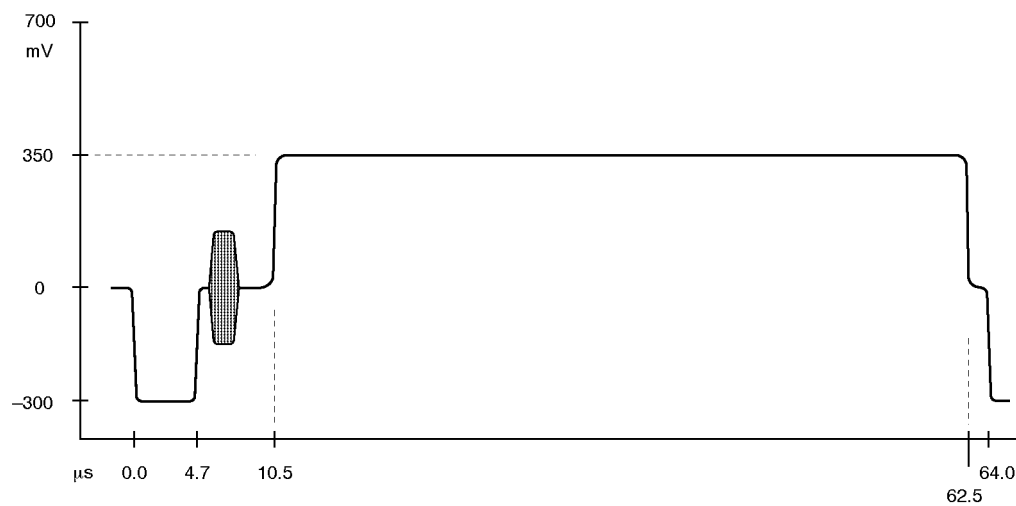

Figure 1-7: PAL 50% Flat Field

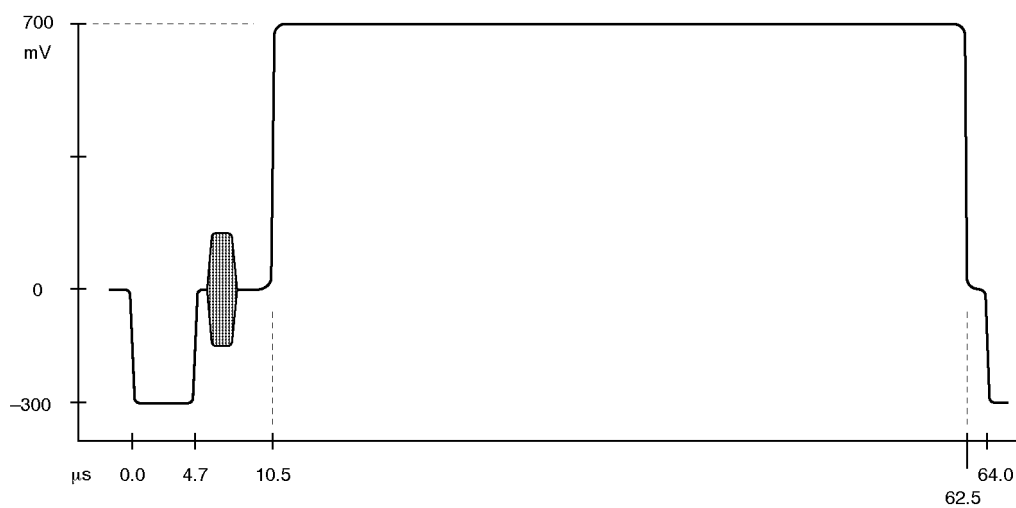

Figure 1-8: PAL 100% Flat Field

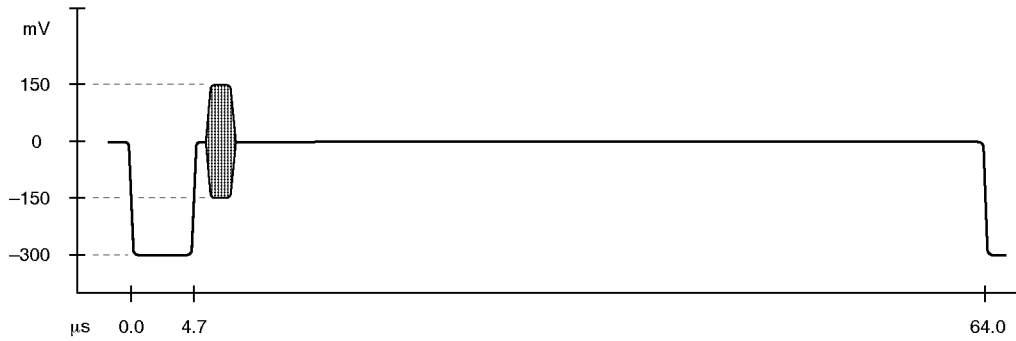

Figure 1-9: PAL 0% Flat Field

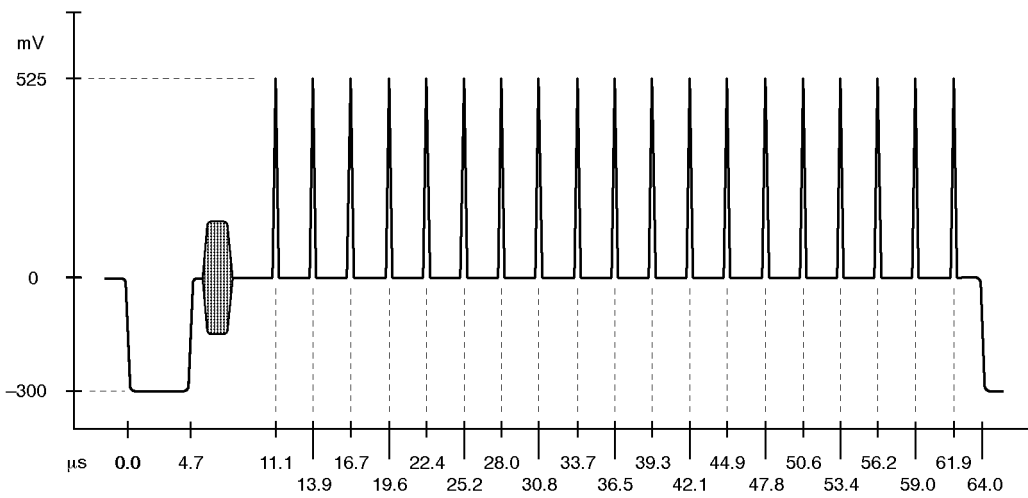

Figure 1-10: PAL Convergence (vertical lines)

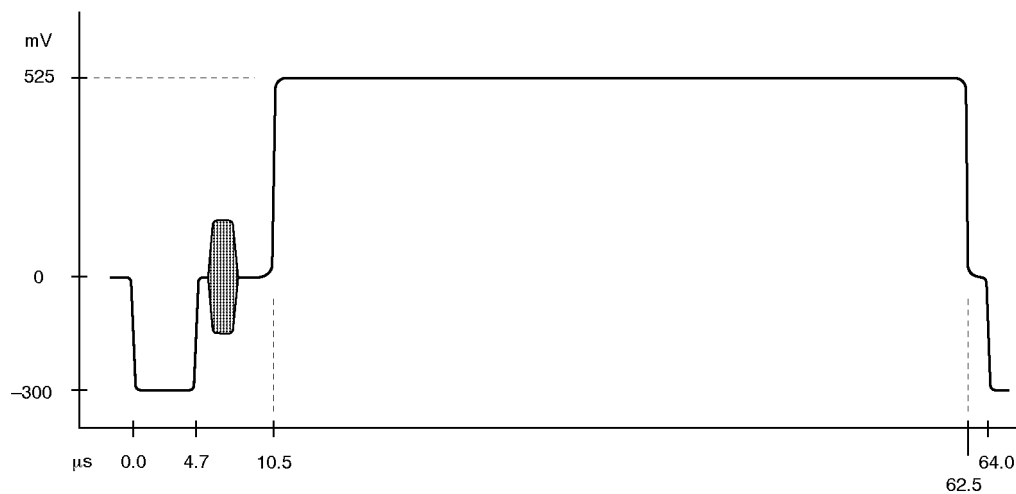

Figure 1-11: PAL Convergence (horizontal lines)

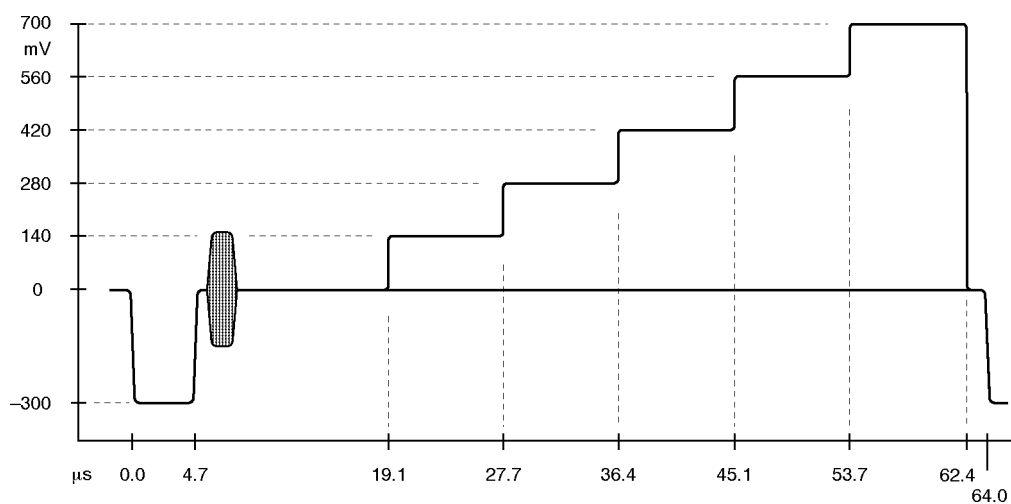

Figure 1-12: PAL 5 Step (Gray Scale)

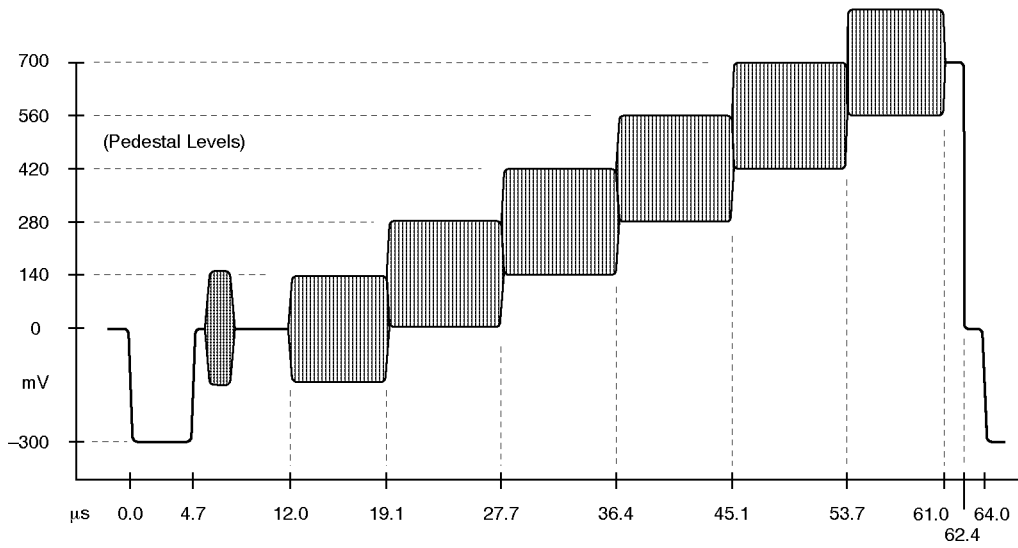

Figure 1-13: PAL Modulated 5 Step

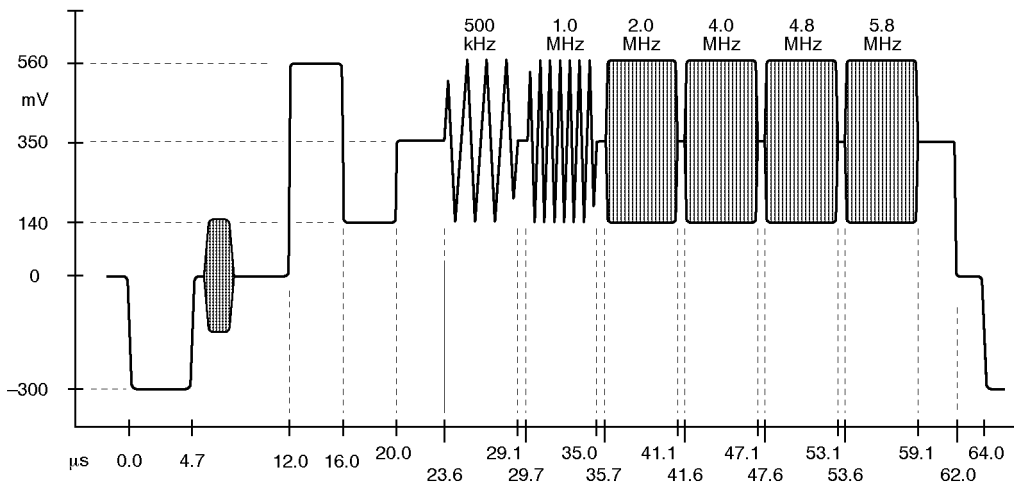

Figure 1-14: PAL Multiburst

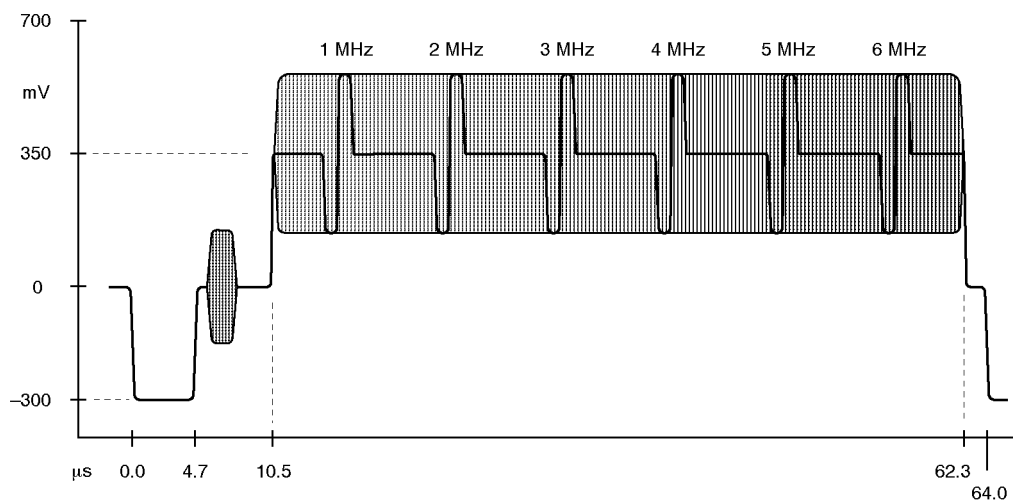

Figure 1-15: PAL Reduced Sweep

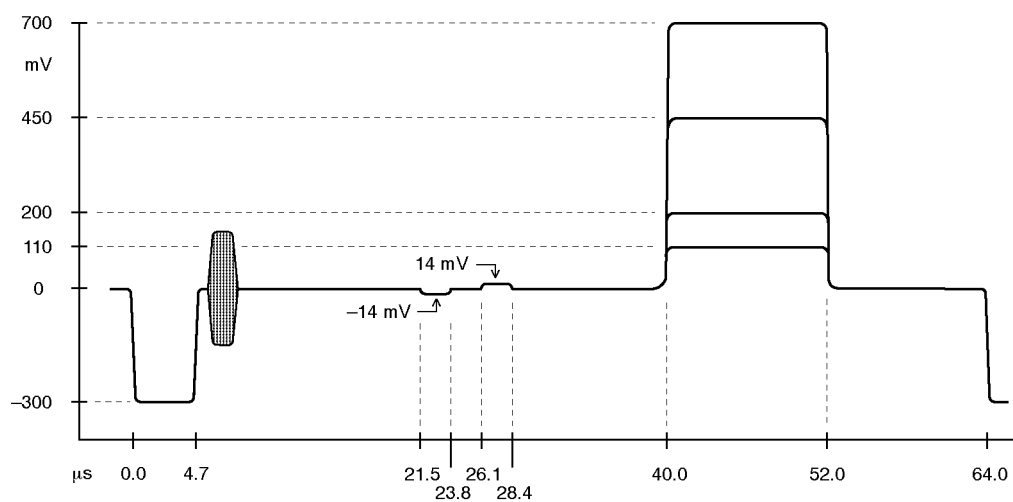

Figure 1-16: PAL Pluge

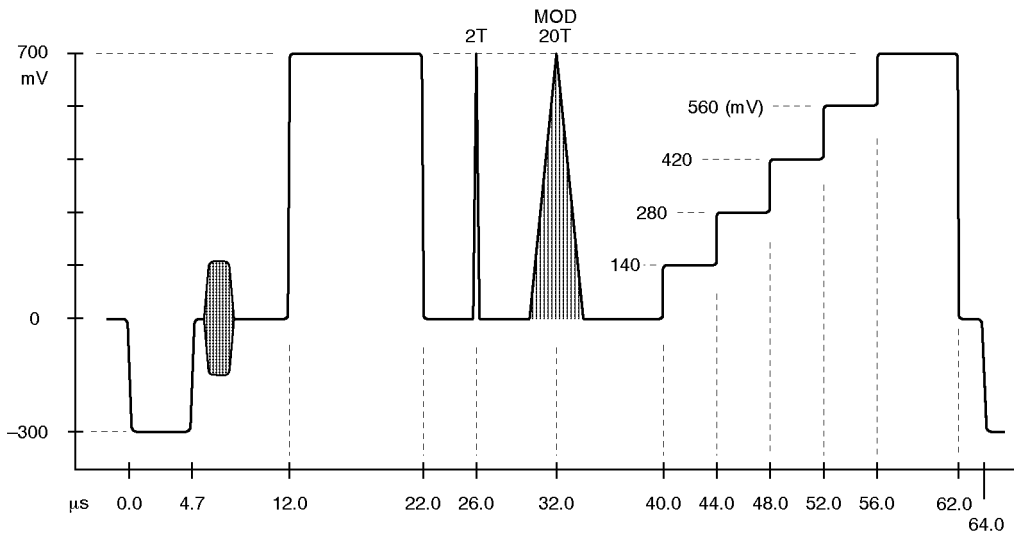

Figure 1-17: PAL Matrix Signal — CCIR 17

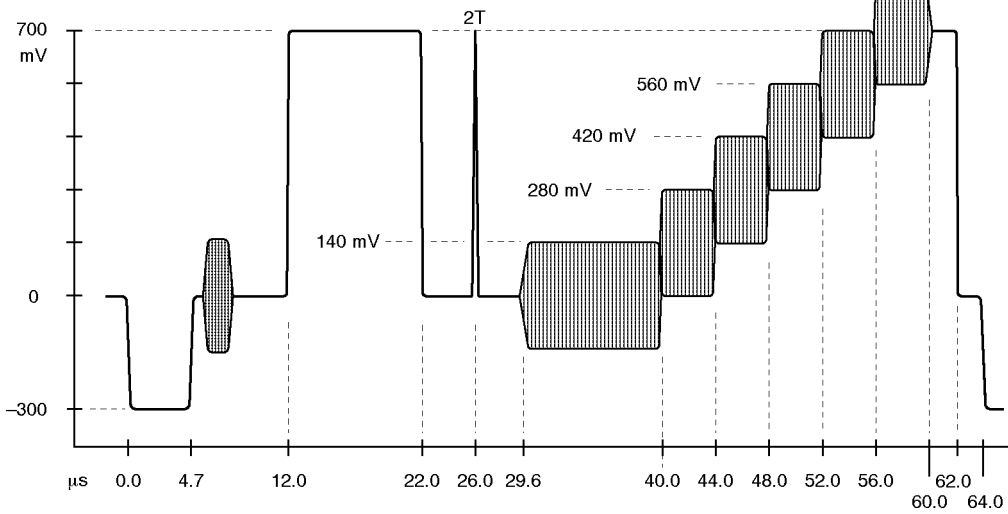

Figure 1-18: PAL Matrix Signal — CCIR Line 330

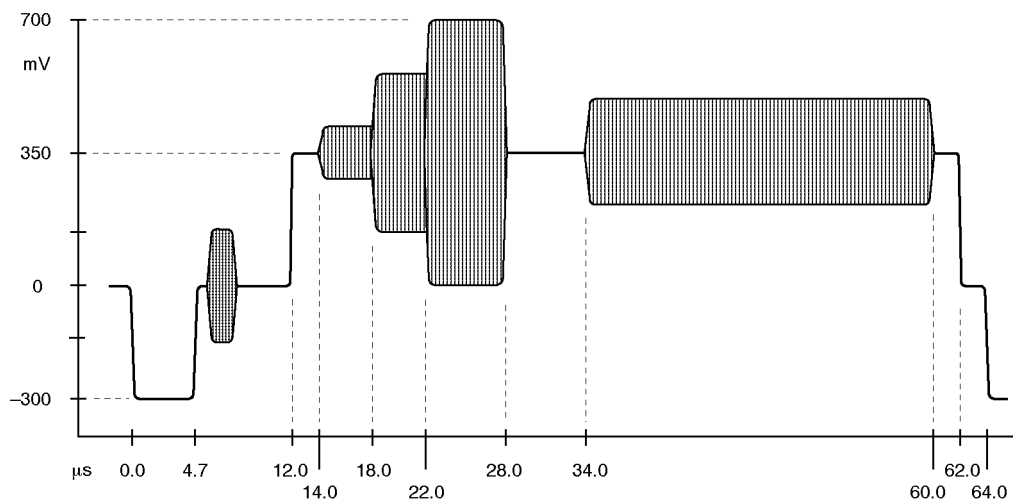

Figure 1-19: PAL Matrix Signal — CCIR Line 331

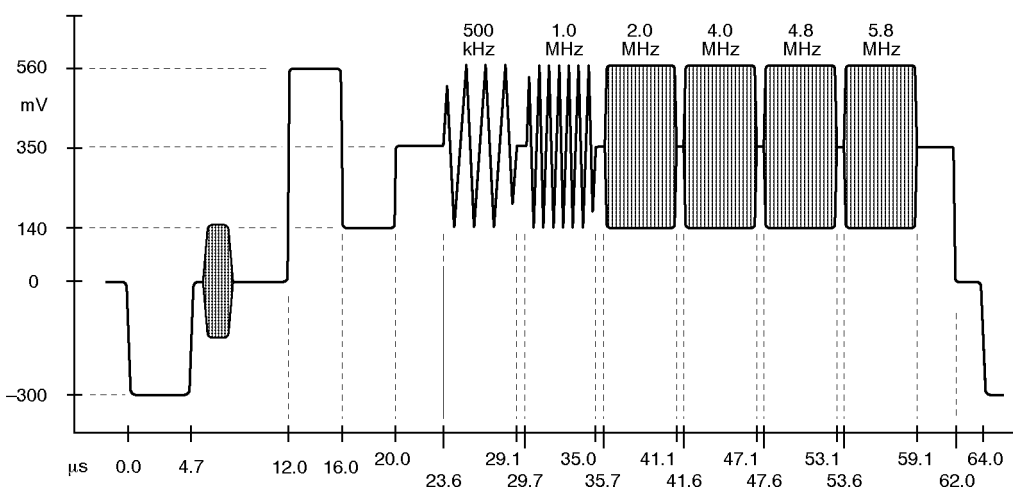

Figure 1-20: PAL Matrix Signal — CCIR 18

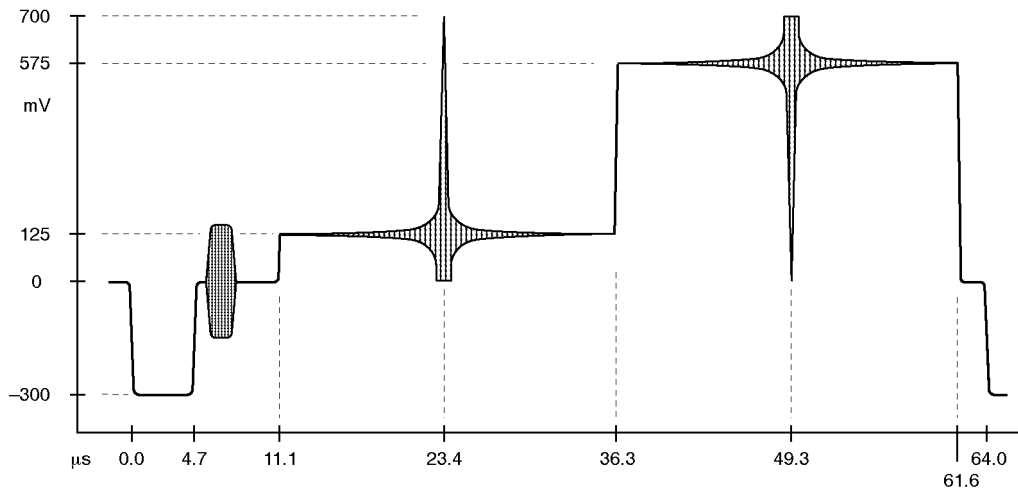

Figure 1-21: PAL Matrix Signal — $(\sin x)/x$

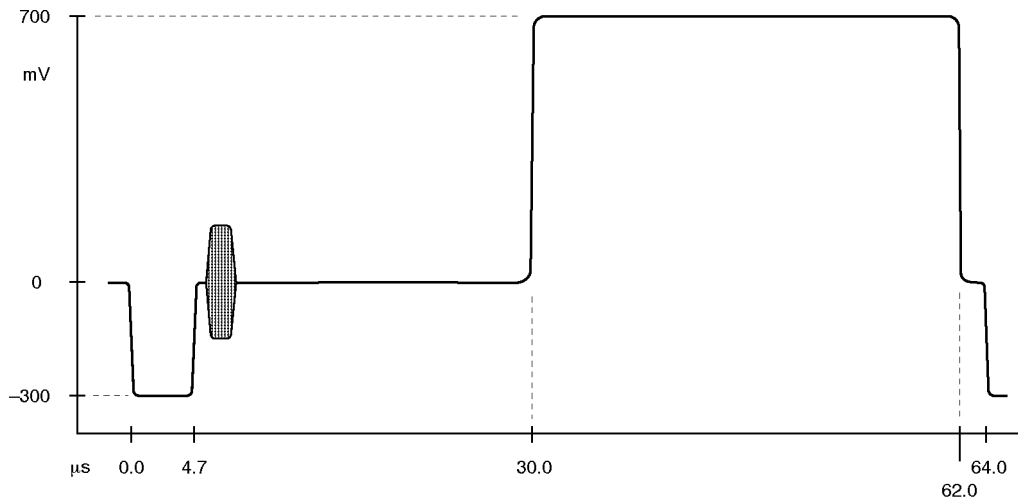

Figure 1-22: PAL Matrix Signal — 15 kHz Square Wave

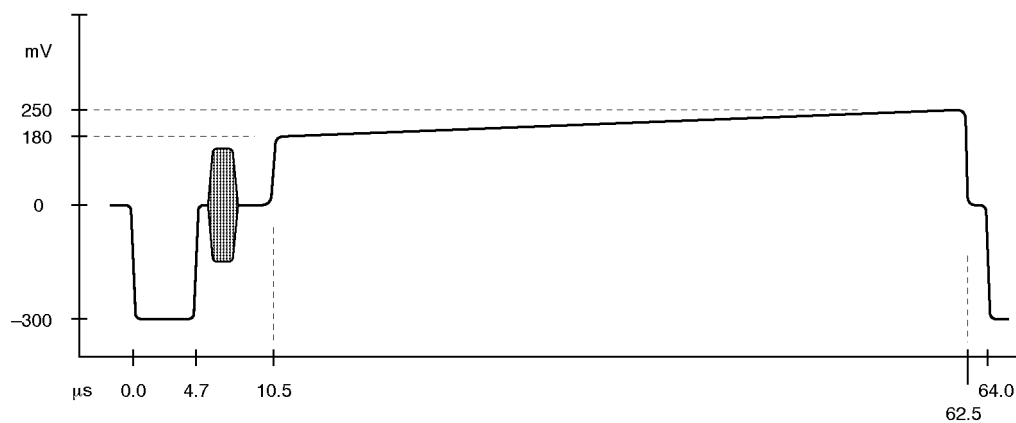

Figure 1-23: PAL Matrix Signal — Shallow Ramp

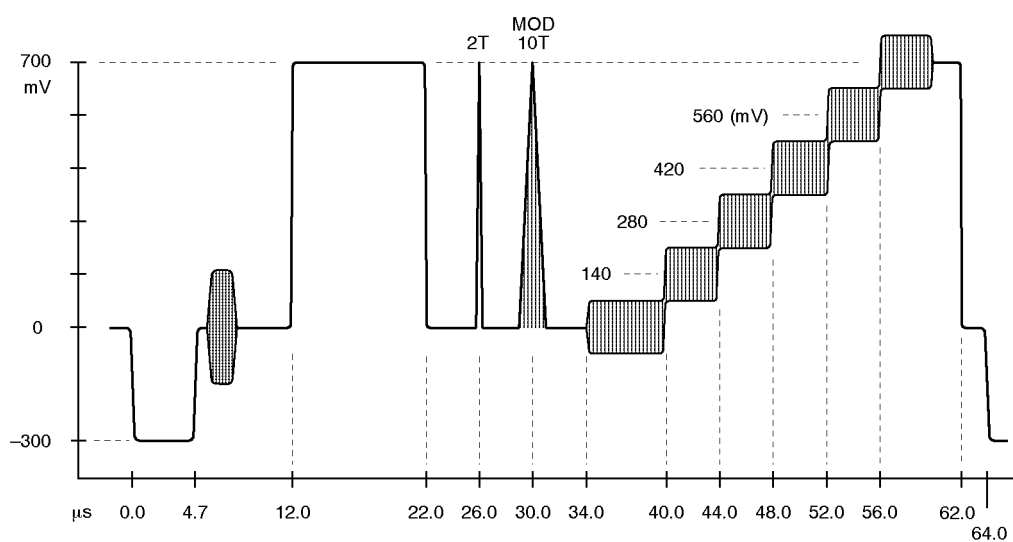

Figure 1-24: PAL Matrix Signal — UK ITS 1

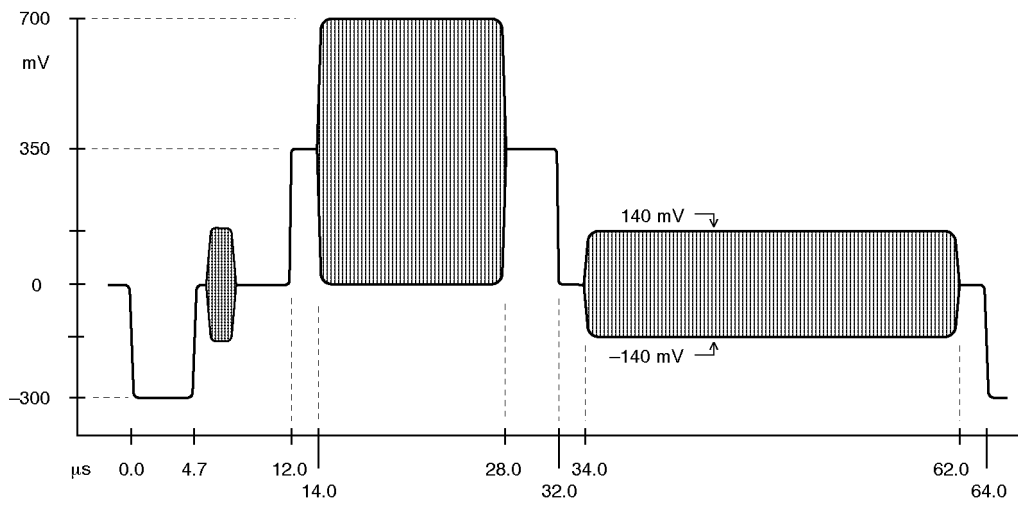
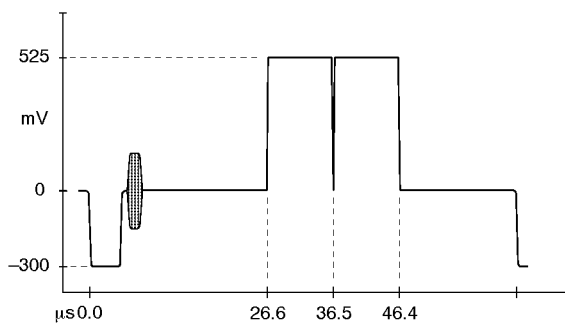
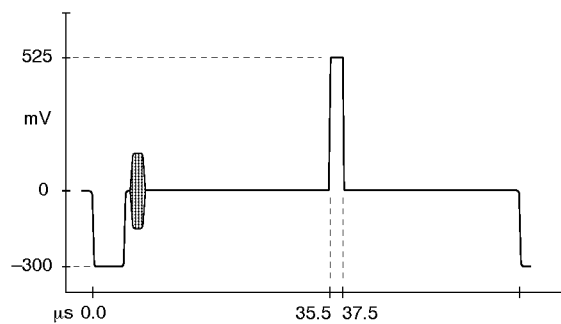

Figure 1-25: PAL Matrix Signal — UK ITS 2



Lines 52 and 282



Line 167

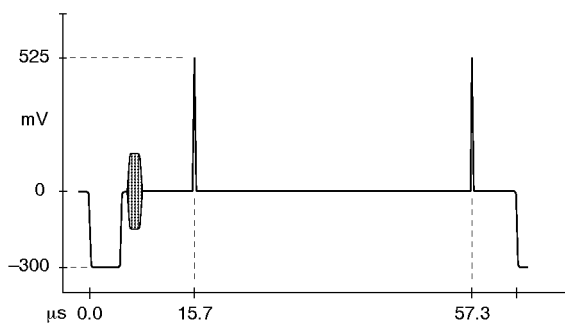

Lines 113-159 and 175-221

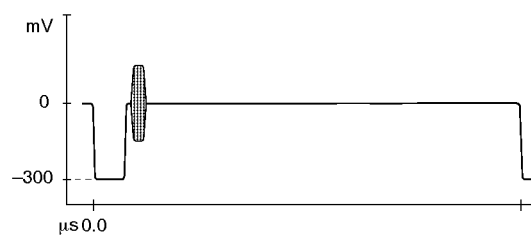

All remaining lines

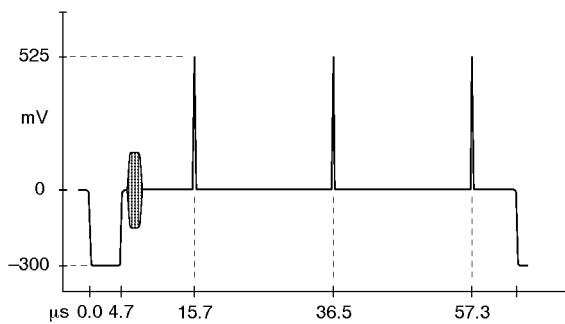

Lines 160-166 and 168-174

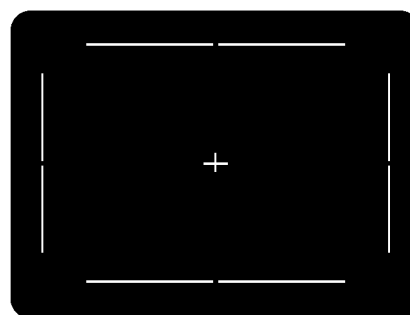

Safe Area display

Figure 1-26: PAL Safe Area

NTSC Waveform Diagrams

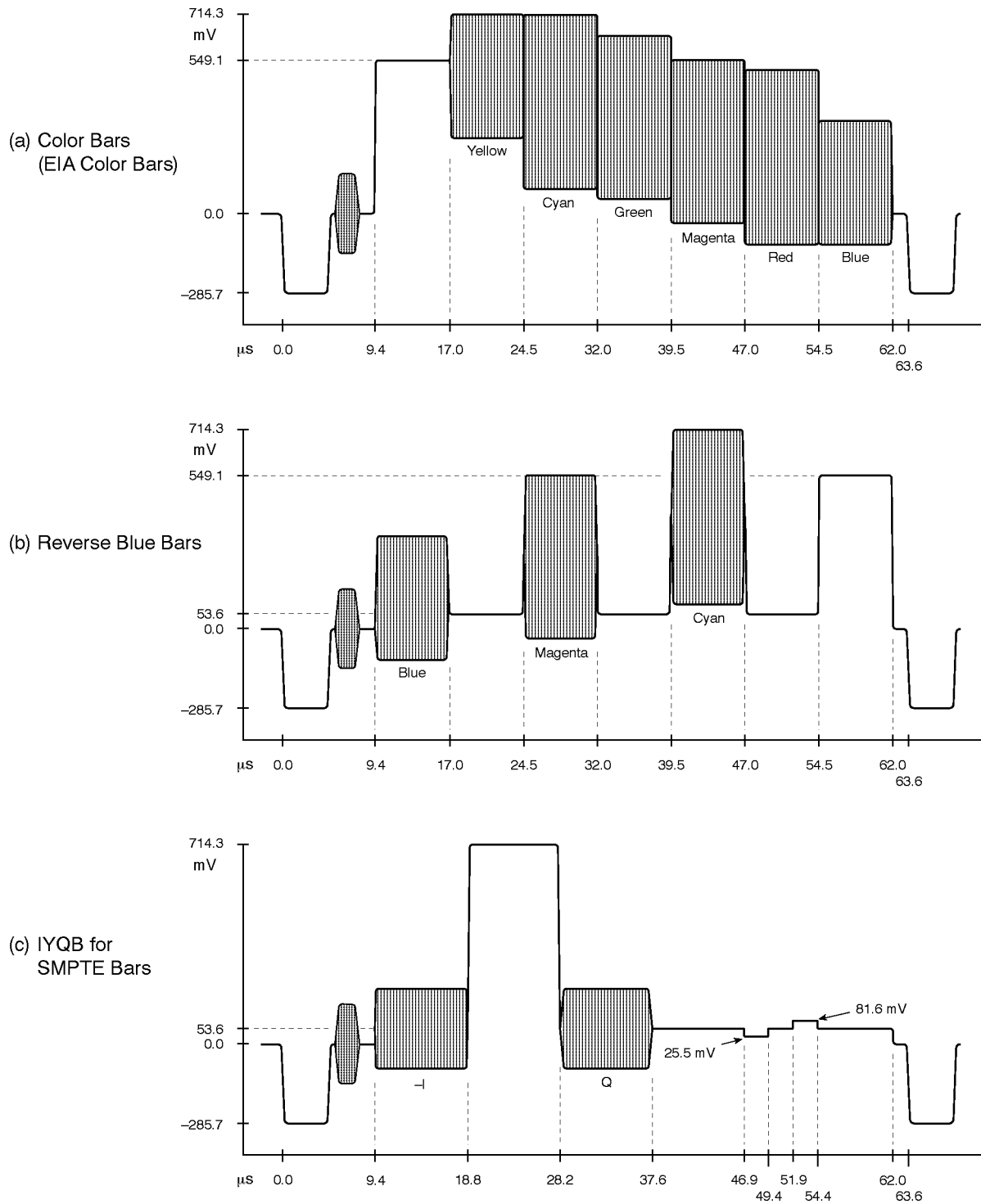
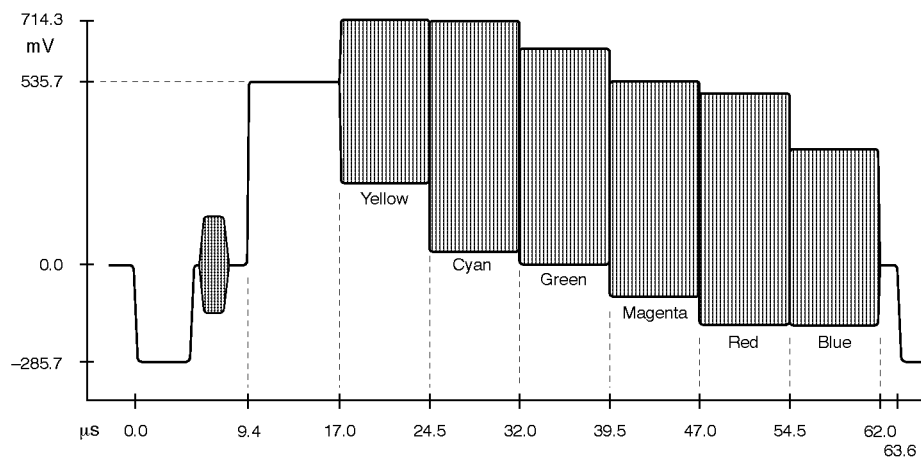
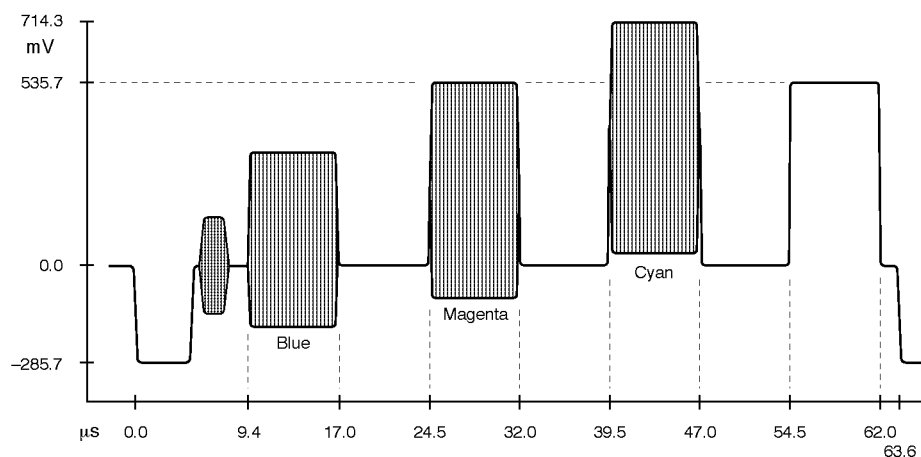

Figure 1-27: SMPTE (NTSC) Color Bar Components

(a) Color Bars, lines 21–182



(b) Reverse Blue Bars, lines 183–202



(c) IQB for SMPTE Bars, lines 203–262

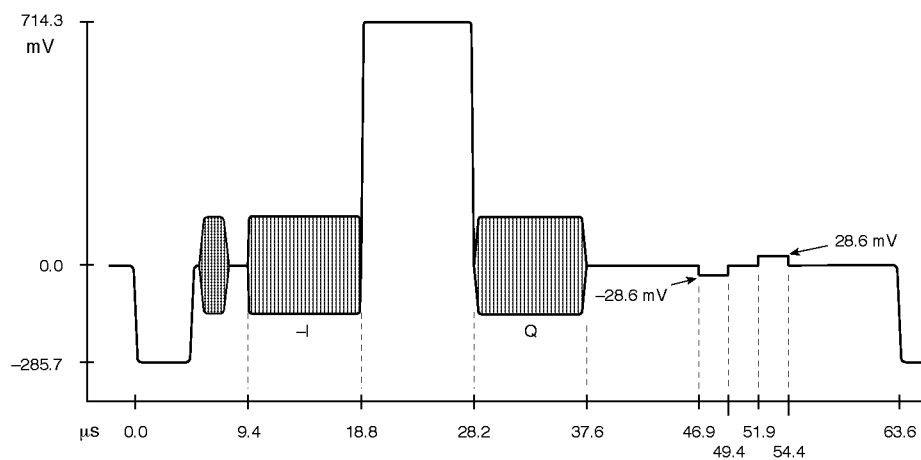

Figure 1-28: SMPTE (NTSC) Color Bars, Zero Setup

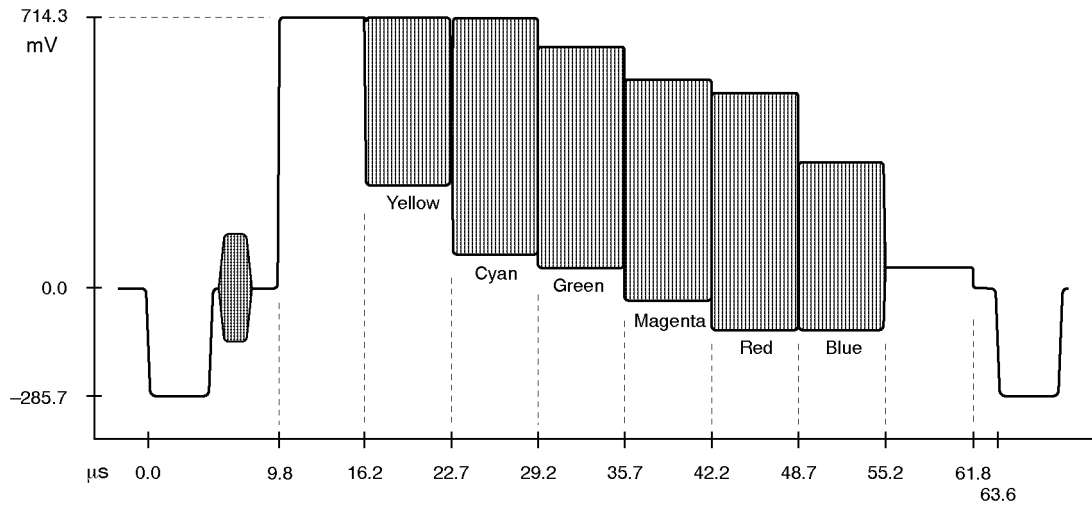

Figure 1-29: NTSC 75% Color Bars

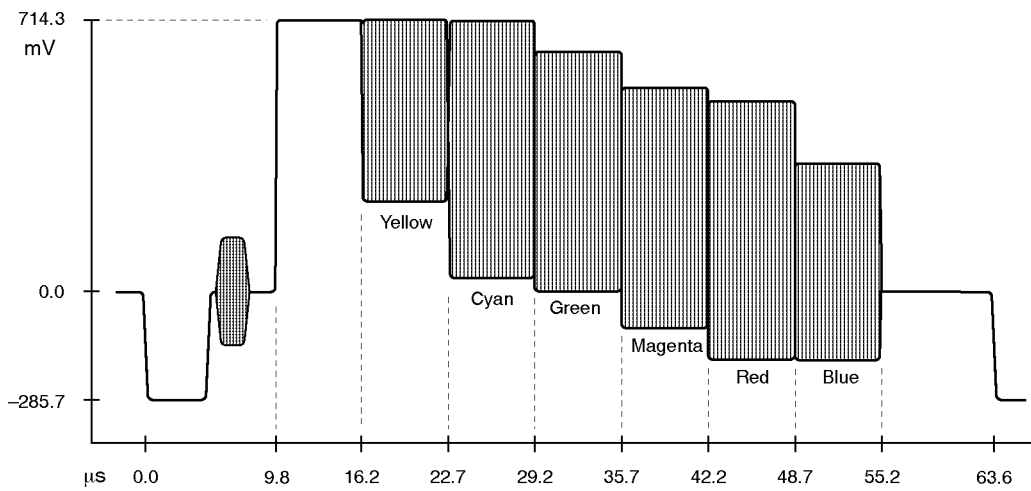

Figure 1-30: NTSC 75% Color Bars, Zero Setup

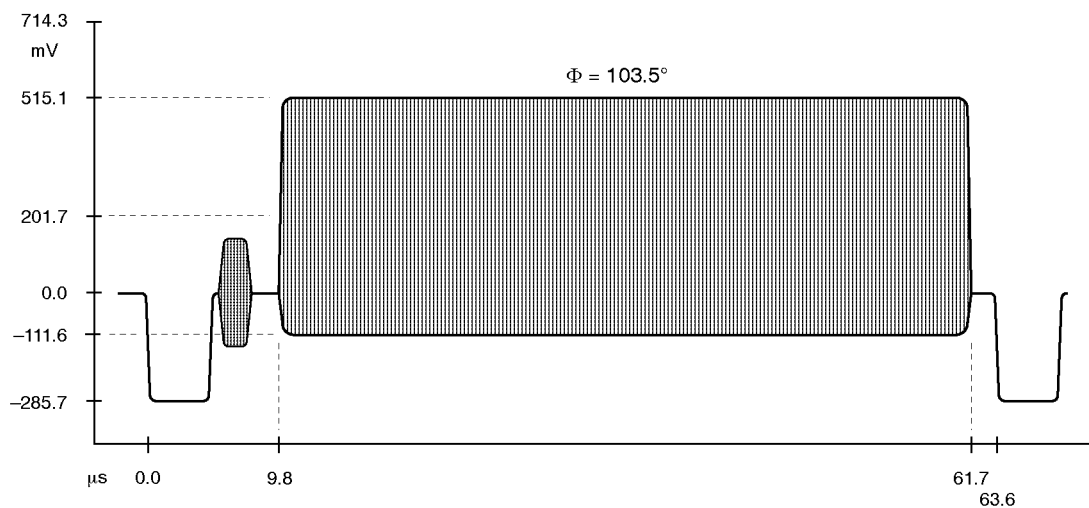

Figure 1-31: NTSC Red Field

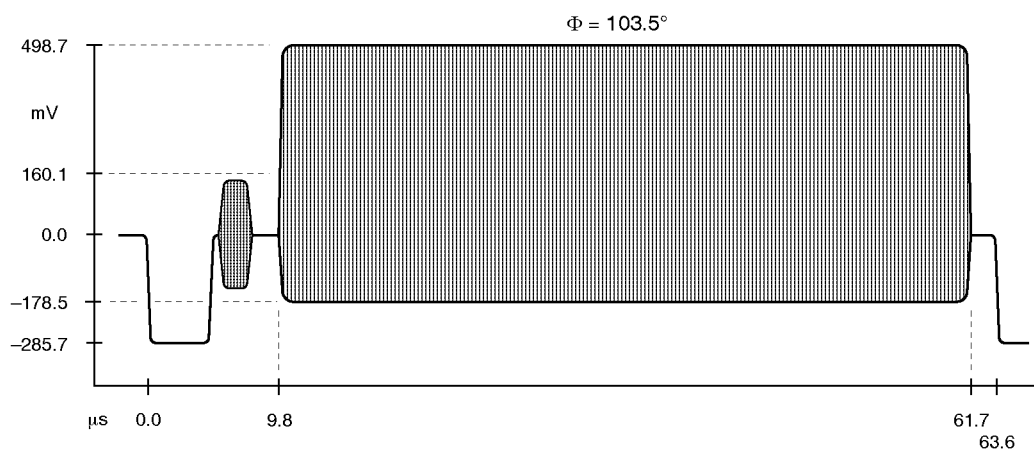

Figure 1-32: NTSC Red Field, Zero Setup

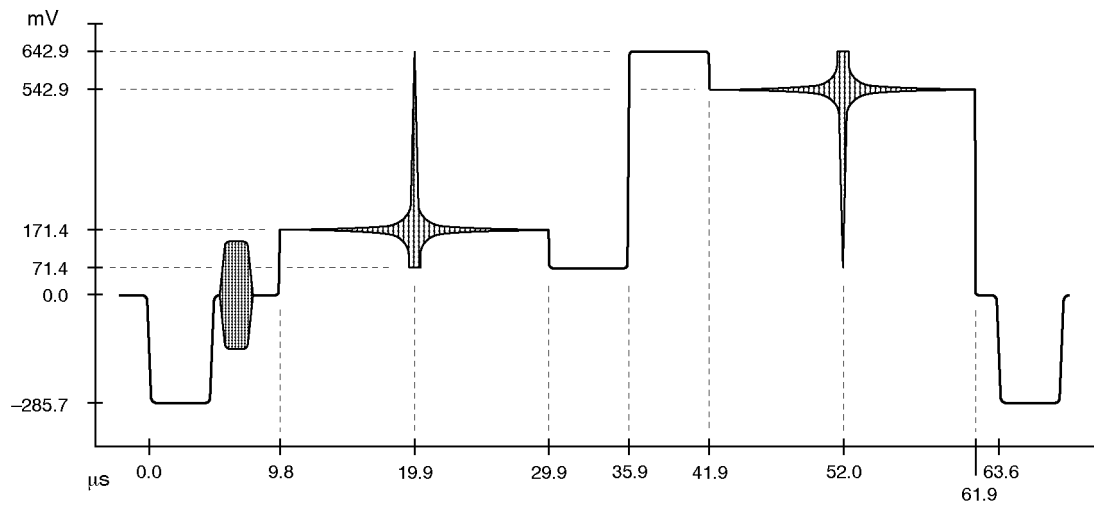

Figure 1-33: NTSC (Sin x)/x

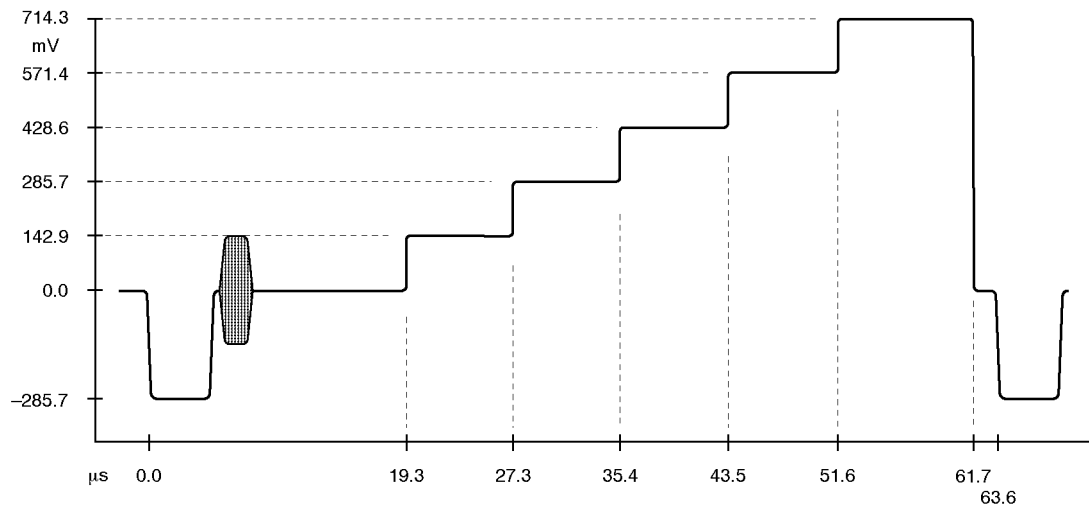

Figure 1-34: NTSC 5 Step Staircase (Gray Scale)

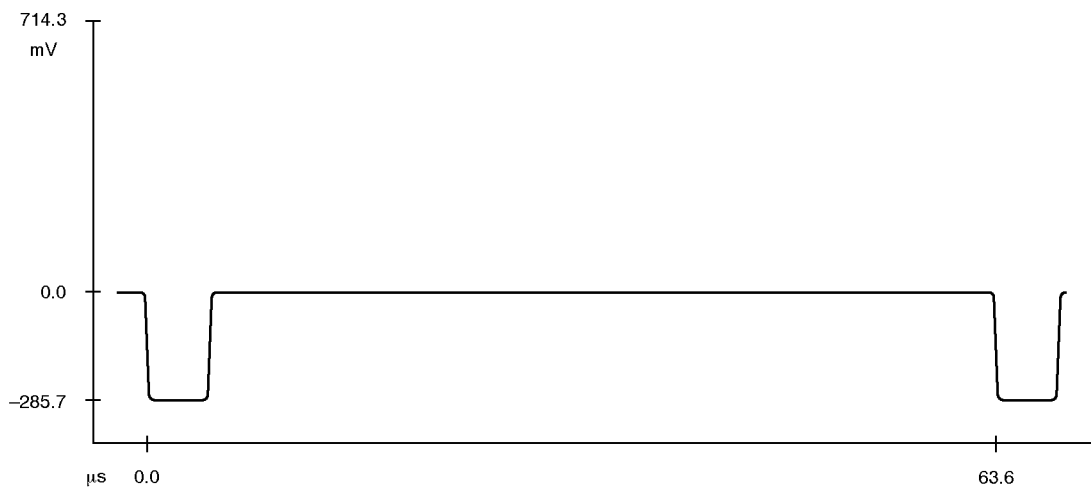

Figure 1-35: NTSC 0 IRE No Burst

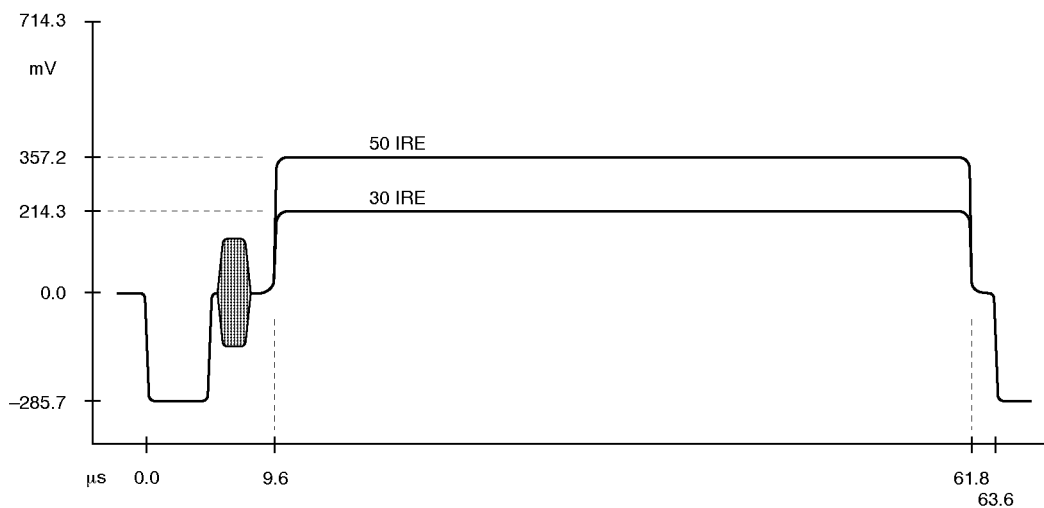

Figure 1-36: NTSC 30 IRE (Zero Setup) and 50 IRE Flat Fields

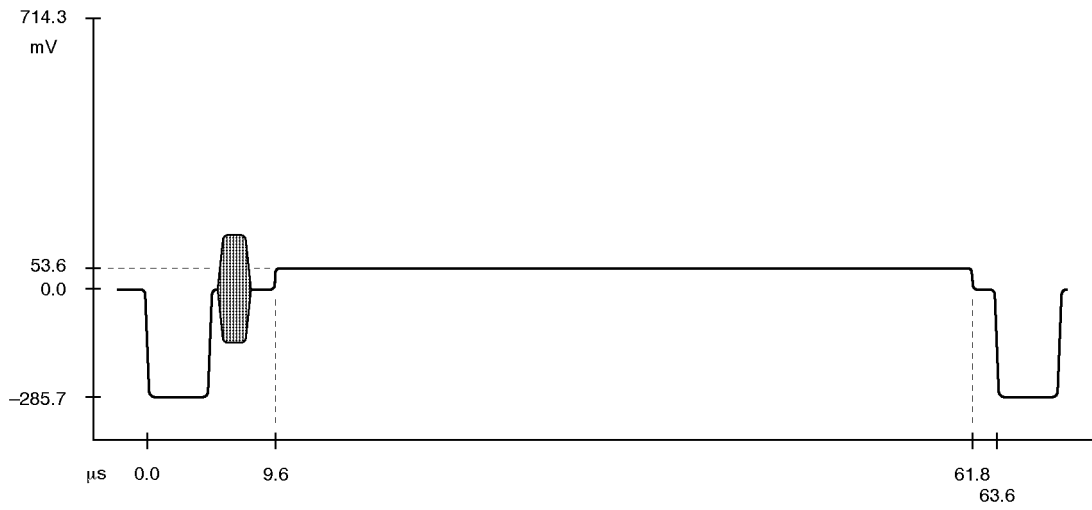

Figure 1-37: NTSC Black Burst

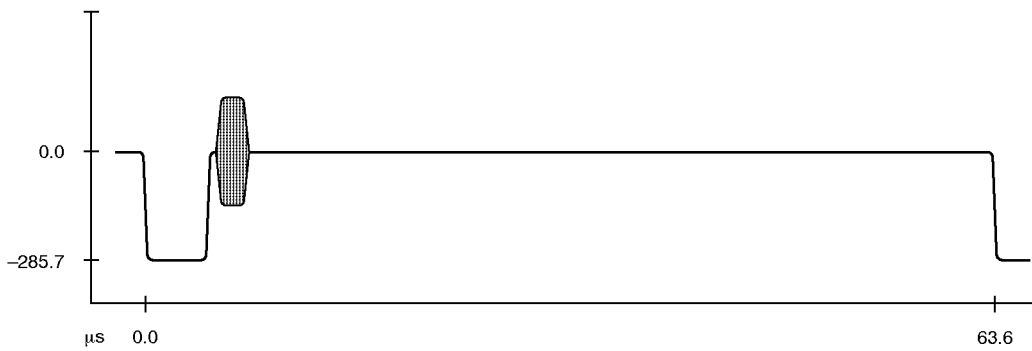

Figure 1-38: NTSC Black Burst, Zero Setup (and Bounce, Low)



Figure 1-39: NTSC 100 IRE, Field Square Wave (and Bounce, High)

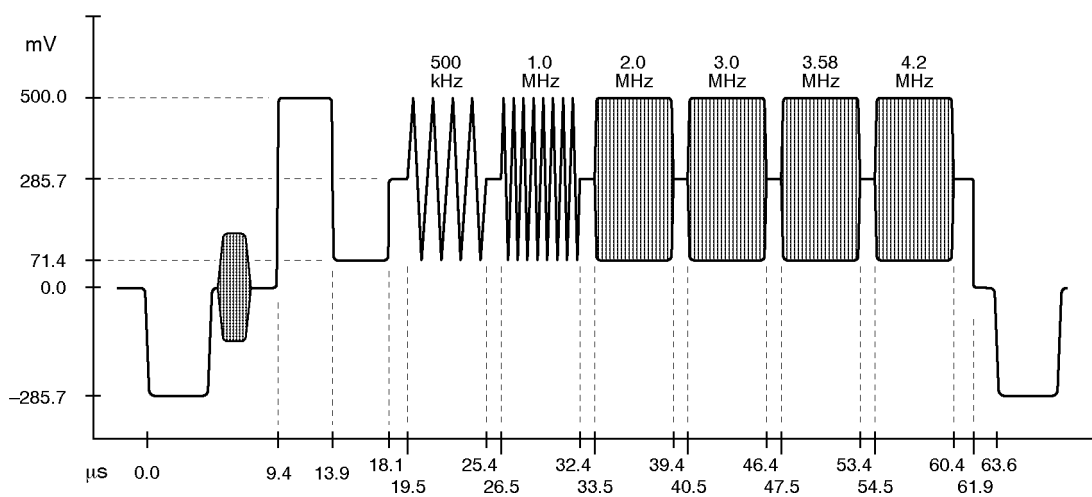

Figure 1-40: NTSC Multiburst

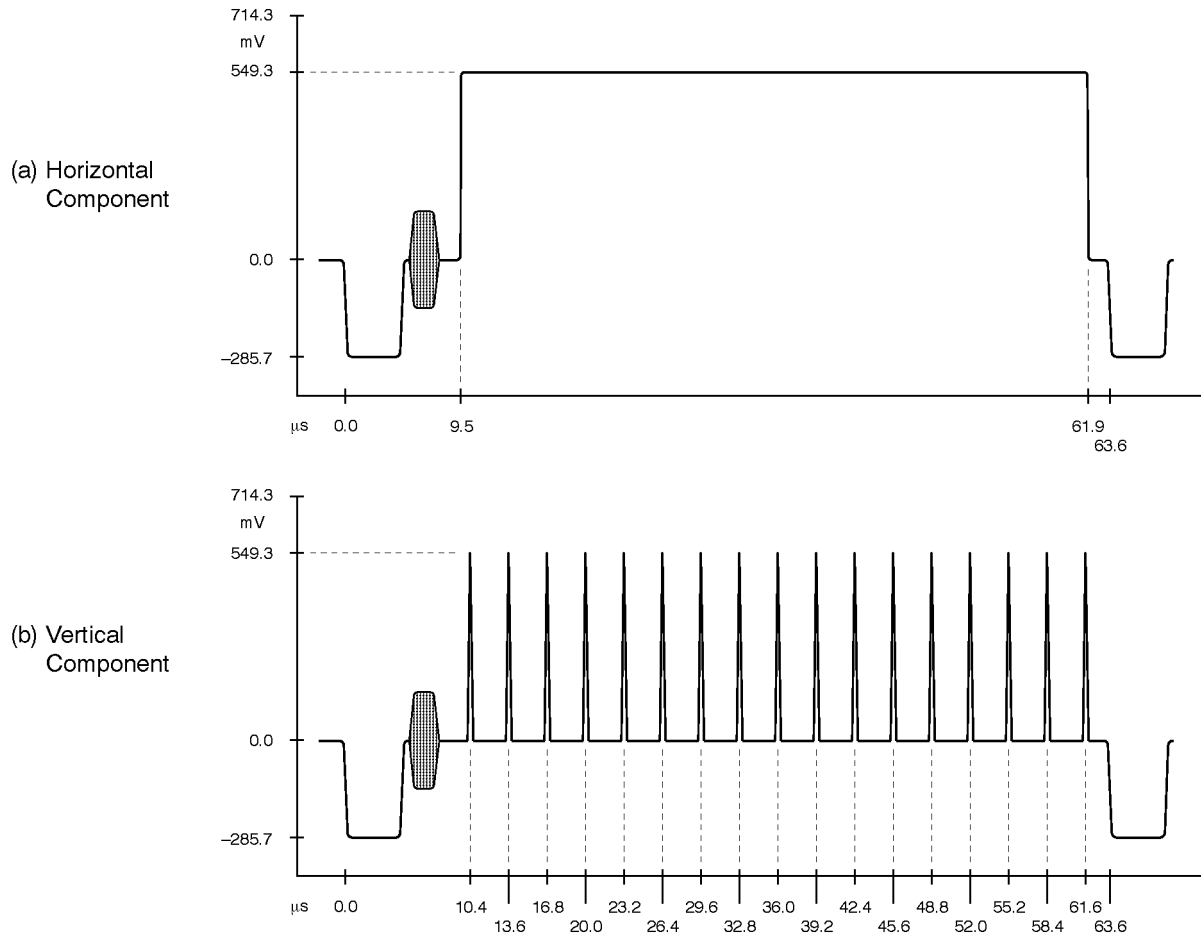

Figure 1-41: NTSC Convergence Components

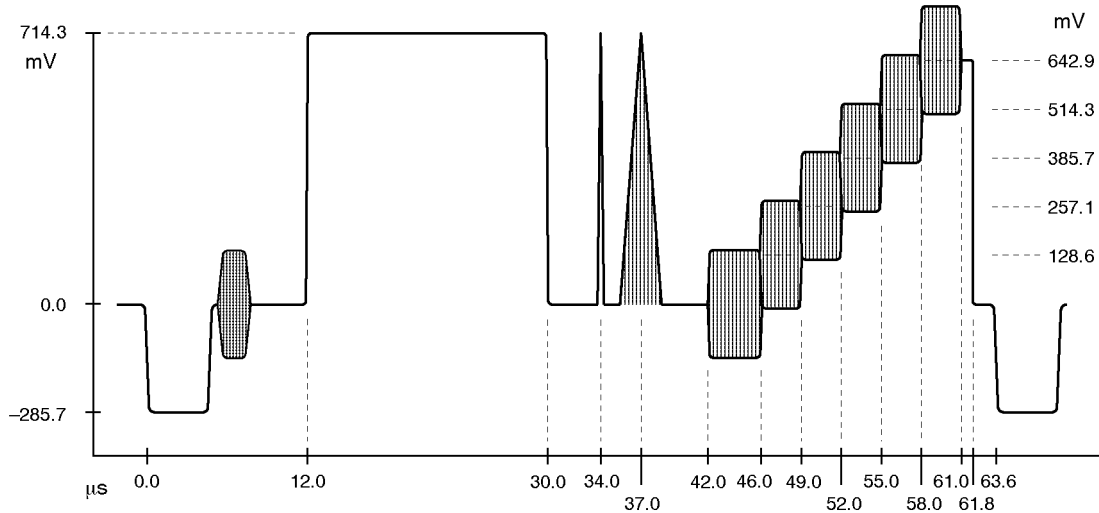

Figure 1-42: NTC7 (NTSC) Composite

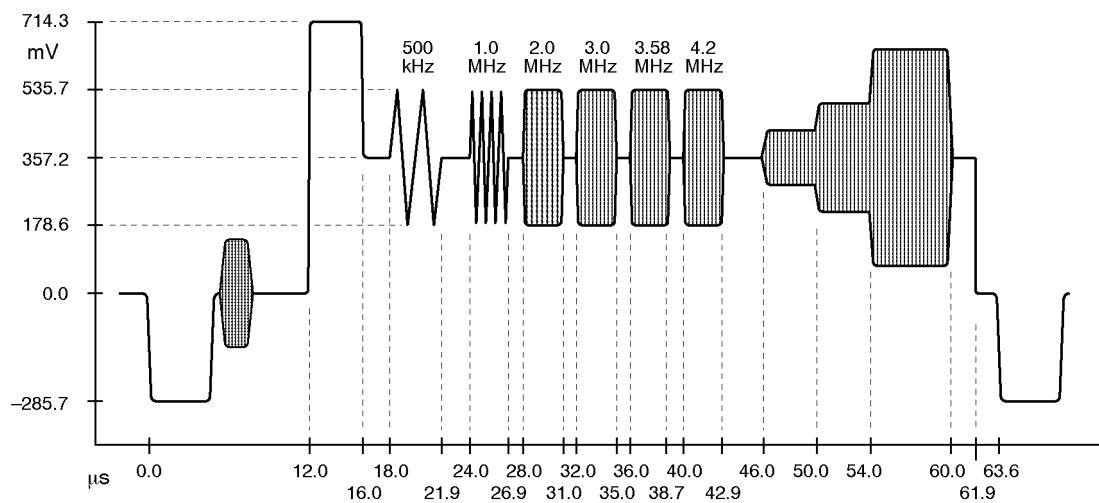

Figure 1-43: NTC7 (NTSC) Combination

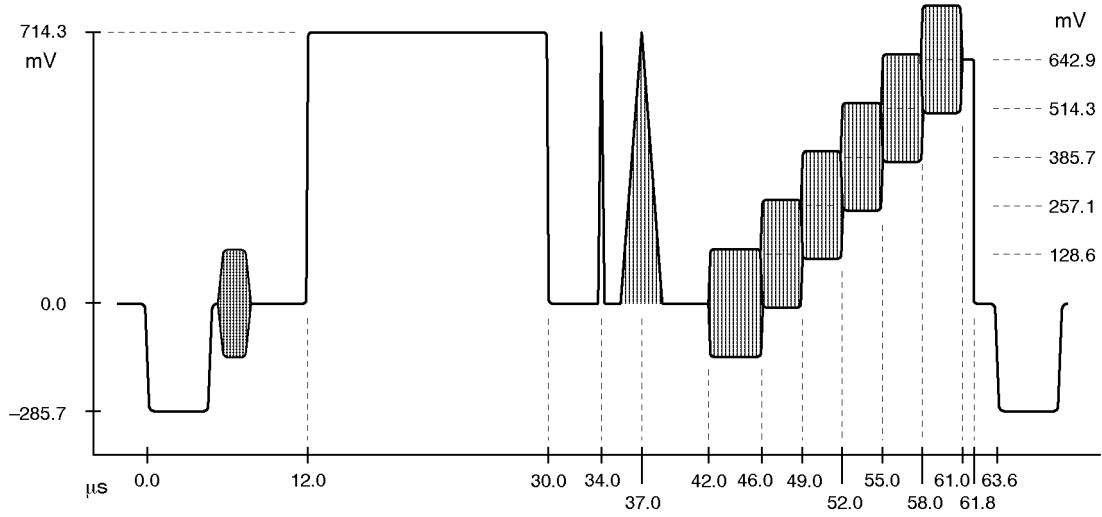

Figure 1-44: FCC (NTSC) Composite

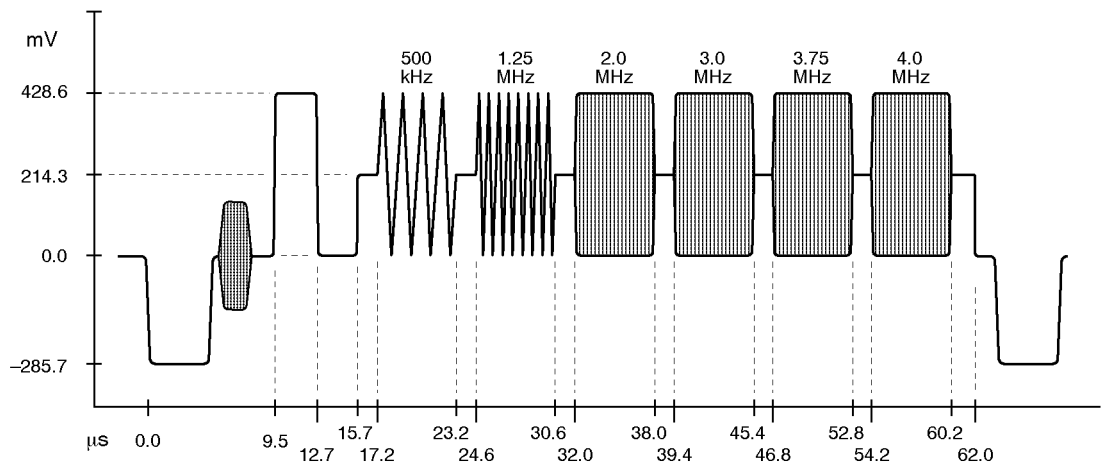

Figure 1-45: NTSC Cable Multiburst

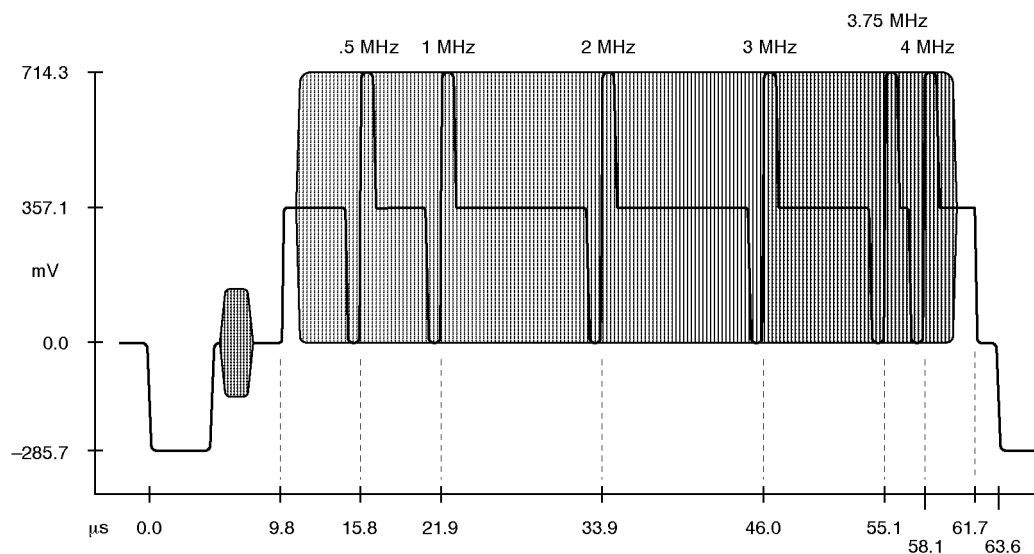
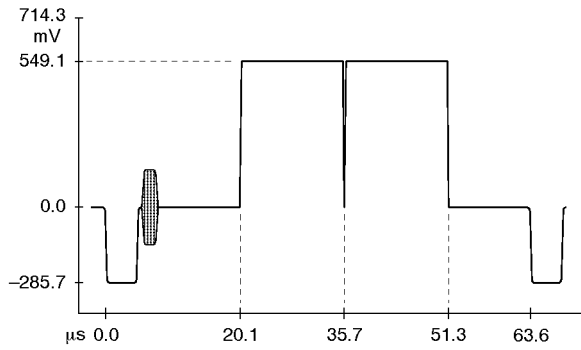

Figure 1-46: NTSC Cable Sweep

Lines:

21	NTC7 Composite
69	
70	NTC7 Combination
117	
118	Color Bars
165	
166	SIN(x)/x
213	
214	50 IRE Flat Field
262	

Figure 1-47: NTSC Matrix



Lines 33, 45, 238, and 250

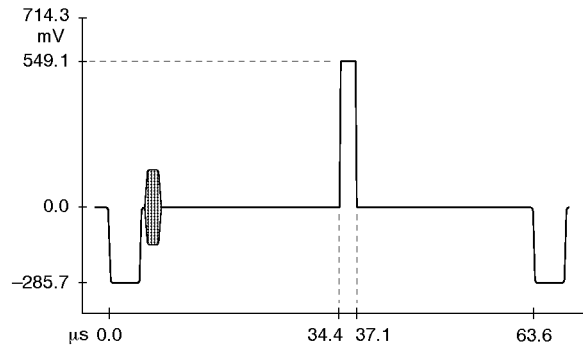

Line 141

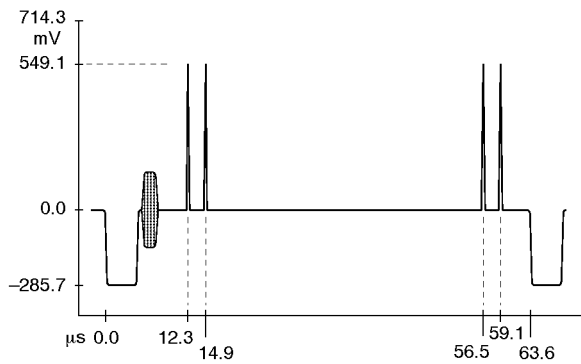

Lines 69–132 and 149–213

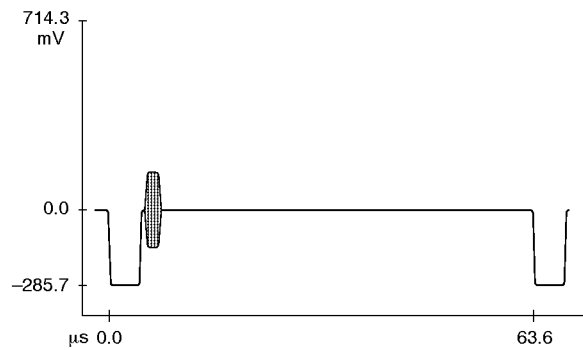

All remaining lines

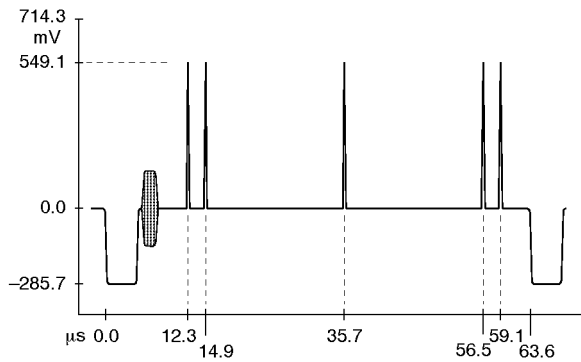

Lines 133–140 and 142–148

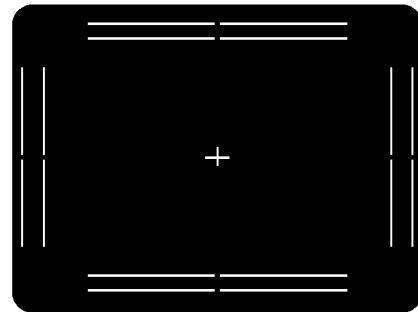

Safe Area display

Figure 1-48: NTSC Safe Area

Operating Information

This section duplicates material contained in the TSG 95 User manual (Tektronix part number 070-8916-XX). This material is included for your convenience. Please check the User manual if you need additional information on any topic.

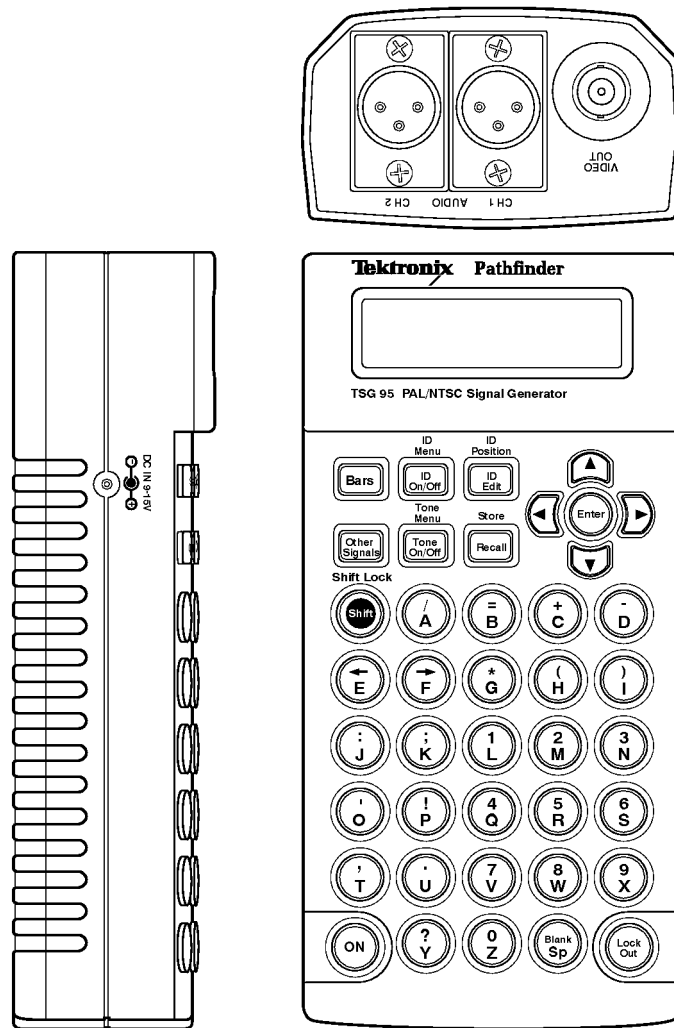

Getting Started

Please read the following statements before using your new TSG 95, then see the rest of the section for tips on supplying power, making preliminary settings, and connecting the instrument.



CAUTION. Attempting to operate the TSG 95 with an improper AC adapter can result in damage to the instrument. To avoid damage, **USE ONLY AN APPROPRIATE DC POWER SOURCE:** Voltage must be 9 to 15 VDC; the connector must have the **NEGATIVE** contact in the center; and open-circuit voltage of the power source must not exceed 18 VDC.

For best results, use the AC adapter that is supplied with the instrument. If the supplied adapter is incorrect for the local AC power supply, contact your nearest Tektronix representative.



WARNING. Install or replace batteries only with the instrument switched **OFF** and the AC adapter disconnected.

Replace the batteries only with standard AA batteries (1.2–1.5 V, nominal), or with a Tektronix rechargeable battery pack (p/n 119-4488-00).

If you use NiCad AA batteries or the optional battery pack, be sure to set the battery type to “rechargeable” through the Utility menu (see page 2–6). Failure to do so can result in damage to the batteries.

NOTE. Do not disconnect the AC adapter when the TSG 95 is switched on. Some user settings may be lost, perhaps causing unexpected results the next time the instrument is switched on.

If you have any questions regarding the operation of this instrument, please contact your nearest Tektronix representative or field office. In the United States and Canada, you may also call the Tektronix information number, 1-800-TEK-WIDE (1-800-835-9433), between 8:00 am and 5:00 pm Pacific time.

Supplying Power

The TSG 95 is DC powered. You may power it with the standard AC adapter, the optional 9.6 V NiCad battery pack, eight standard AA batteries, or a “BP” type battery pack with the correct voltage and polarity. The external DC power connector is on the left side of the instrument.

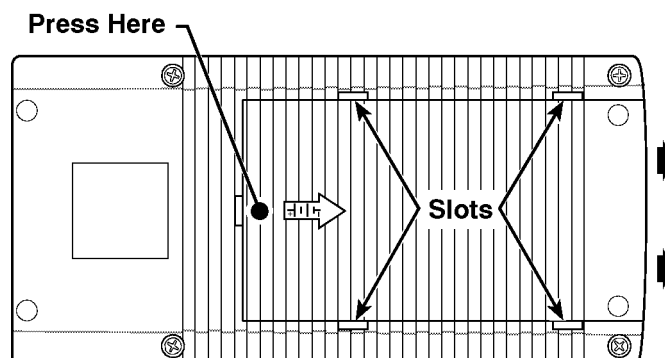

To install AA batteries or the battery pack, open the battery compartment of the TSG 95 by pressing down on the cover and sliding it in the direction of the inscribed arrow, as shown above. When the cover tabs line up with the slots in the case, lift the cover away from the instrument. Install batteries in alternating directions as indicated by the graphic molded into the “floor” of the battery compartment. If using the optional battery pack, take the time to identify both contacts and install the pack properly.

When selecting a power source for your TSG 95, please remember:

- Attempting to use an improper AC adapter can damage the instrument. See the Caution statement on the previous page.
- There is no need to remove the optional NiCad battery pack for recharging. The TSG 95 will “trickle charge” the battery pack whenever the standard AC adapter is used. Recharging the battery pack fully can take up to 16 hours.

NOTE. Charging will occur only if the adapter supplies at least 12V; make sure that the adapter you use is appropriate for the local AC supply.

- AA batteries are not included with the instrument; obtain them locally. Rechargeable AA batteries may be used, but they will NOT be recharged automatically by the AC adapter. To recharge AA batteries, remove them from the instrument and use an appropriate battery charger. For safety, read and follow the battery charger instructions. Do NOT attempt to recharge standard alkaline batteries. Remove Alkaline batteries when the instrument will be stored or powered with the AC adapter for more than 30 days.
- After a minute with no key press, the TSG 95 will automatically switch to lock out mode (as if you had pressed the Lock Out key); the display back light will shut off to conserve battery charge. When you want to resume keypad input, press **Lock Out** to exit lock out mode.
- To guard against battery discharge if you forget to turn the TSG 95 off after use, enable Auto Power Down through the Utility menu (see page 2–6).

- The TSG 95 can sense low battery voltage. It will warn you when the charge is sufficient for approximately ten more minutes of operation. The instrument will shut itself down when the battery voltage becomes too low for reliable operation. For proper function of these features, the Battery Type must be set correctly in the Utility menu. Please see “Setting the Battery Type,” below.

The **ON** key toggles instrument power On and Off.

Connecting the TSG 95

Connect the instrument to your equipment as you would any television test signal generator. Use 75Ω coaxial cable (for video) and be sure that the signal path is properly terminated.

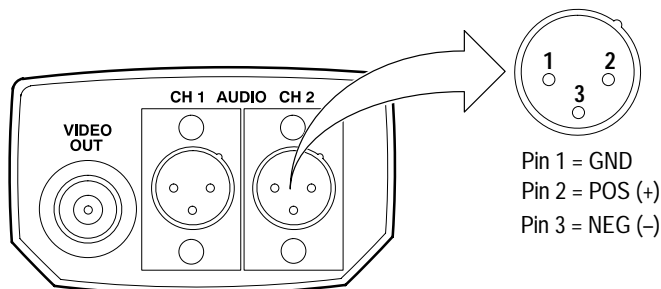

You may wish to confirm proper operation of your TSG 95—and gain familiarity with it—by first connecting it directly to a video or waveform monitor.

Keypad and Display Conventions

Please see the Instruction card (p/n 070-8915-XX) supplied with your TSG 95 for a “tour” of the keypad and an explanation of the display symbols. For your convenience, the following panels are excerpted from the card.

Display Symbols	
	= Auto power-down enabled (symbol “rotates”). Disable through the Configuration menu: see the reverse side of this card for instructions.
	= Shift (Press Shift again to Shift Lock)
	= Shift Lock (Press Shift again to unlock)
	= Lockout enabled (press Lock Out to unlock)
	= Blank ID Position; will not obscure test signal

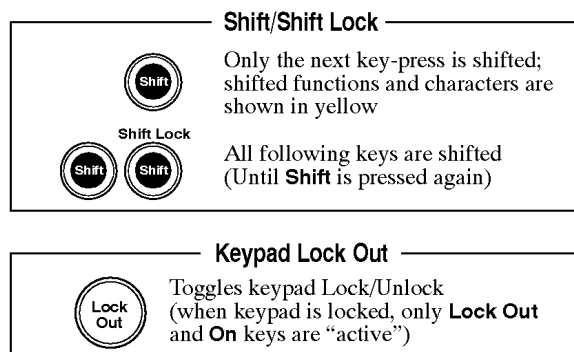

Definitions

There are two terms used in this manual that deserve a little explanation:

Signal Set. The group of signals that can be selected through the TSG 95 keypad at a given time. In the pre-programmed signal sets, all of the signals are the same video standard. You may create a “User” signal set, however, that contains any combination of PAL and NTSC signals assigned to the letter keys that you find most convenient.

Tone Level. One of four pre-defined audio output amplitudes that may be selected through the Tone menu. The levels (1 through 4) are “named” –10, 0, +4, and +8 dBu and calibrated to those amplitudes when the TSG 95 is manufactured. Qualified personnel with the appropriate equipment can rename and readjust the levels within the ranges of –10 to –3 dBu and 0 to +10 dBu. See page 4–29, in the *Performance Verification and Adjustment* section of this manual, for instructions.

Preliminary Settings

Once the TSG 95 is up and running, you should make some settings that depend on how the instrument will be used. These settings are made through the Utility menu. Invoke the Utility menu by holding **Lock Out** down while pressing the ON key—then make the following configuration selections.

Choose the Video Standard/Signal Set

1. Use the ▲ and ▼ keys to scroll to the SELECT STNDRD menu item.
2. Select, with the ◀ and ▶ keys, the signal standard or “signal set” that is appropriate to your application. The choices are: PAL; NTSC; NTSC JAPAN (which includes NTSC signals with 0% Setup); and USER SIG SET (the user-configurable signal set that can contain up to 26 signals of your choice—see the User manual for more information).
3. When the name of the desired signal set is displayed, continue to the Battery Type, or press any rectangular key to exit the Utility menu and return to normal operation.

Set the Battery Type

While still in the Utility menu, use the ▲ and ▼ keys to scroll to the BATTERY TYPE item.

1. Toggle to the selection that matches the type of battery you have installed in your TSG 95 by pressing either ◀ or ▶. The choices are “rechargeable” and “disposable.” Select rechargeable when using NiCad AA cells or the optional battery pack; choose disposable when you are using common Alkaline AA batteries, which cannot be recharged.
2. When the correct battery type is displayed, continue to Auto Power Down, or press any rectangular key to exit the Utility menu and return to normal operation.

Enable (Disable) Auto Power Down

“Auto Power Down” will switch the instrument off when ten minutes have passed without a key press. Enable this feature when using battery power and operating in an environment in which unplanned shutdown of the TSG 95 is permissible.

1. While still in the Utility menu, use the ▲ and ▼ keys to scroll to the AUTO PWR DOWN item.
2. Disable/enable Auto Power Down by pressing either ◀ or ▶. The new state will be in effect when you return to normal operation. Enabled Auto Power Down is indicated by a “rotating line” symbol in the upper-right corner of the instrument LCD.
3. Use the ▲ and ▼ keys to access other Utility menu items, or press any rectangular key to exit the menu and resume normal operation.

Other Settings

There are other, less important TSG 95 settings that are configured through the Utility menu and its Calibration submenu. See “The Utility Menu,” beginning on page 5–4 for more information.

Using Your TSG 95

Here is a list of what you can do with your TSG 95. Instructions for each use begin on the indicated page.

- Output either PAL or NTSC video test signals (page 2–8). You can configure the instrument to generate:
 - PAL signals
 - NTSC signals
 - “NTSC JAPAN” signals that have 0 IRE (instead of 7.5 IRE) setup
 - A “User Signal Set” that can contain any combination of PAL, NTSC or NTSC JAPAN signals that you find convenient.

See page 2–5 for information on choosing a video standard/signal set. Directions for creating (or editing) your own User signal set appear in the User manual.

- Generate audio tones (page 2–9). You may:
 - Choose one of 13 discrete “factory” frequencies, or select a frequency sweep that sweeps continuously from 50 Hz to 20 kHz (page 2–9)
 - Designate three “User Tones” between 50 Hz and 20 kHz with a resolution of 1 Hz (page 5–7), and later output one of these frequencies
 - Select a factory-calibrated audio output level of –10, 0, +4, or +8 dBu (page 2–9)
 - Recalibrate the audio output to permit selection of any whole dB level within the ranges of –10 to –3 dBu and 0 to +10 dBu (*qualified service technicians only*—see page 4–29)
 - Include channel-ID “clicks” in the audio output (page 2–10)
- Add an ID message to the video signal (pages 2–10), edit it (page 2–10), and place it in the vertical interval or position it where desired in the active video (page 2–10)
- Store up to eight ID messages for later use (page 2–11)
- Create a sequence of (up to four) stored ID messages that will cycle continuously in the output (page 2–12)
- Save all the current instrument settings as a “Preset” for later recall (page 2–13)

Outputting Test Signals

1. Connect the TSG 95 to your system and make the appropriate preliminary settings as described in the Getting Started section of this manual.
2. Switch the instrument on or return to normal operation by pressing either the Bars or Other Signals key. By default, the instrument “powers up” with the settings that were in effect when it was last switched off.

Table 2-1: TSG 95 Video Test Signals

PAL Signal Set	NTSC Signal Set	NTSC JAPAN Signal Set	Key
75% Bars	SMPTE Bars	SMPTE Bars*	A
100% Bars	75% Bars	75% Bars*	B
75% Bars/Red	Convergence	SNG Bars*	C
100% Bars/Red	Safe Area	Convergence	D
Convergence	Red Field	Safe Area	E
Pluge	50 IRE Flat Field	Red Field*	F
Safe Area	100 IRE Flat Field	50 IRE Flat Field	G
Green Field	Black Burst	100 IRE Flat Field	H
Blue Field	5-Step	Black Burst*	I
Red Field	Multiburst	5-Step	J
100% Flat Field	NTC7 Composite	Multiburst	K
50% Flat Field	NTC7 Combination	NTC7 Composite	L
0% Flat Field	FCC Composite	NTC7 Combination	M
Multiburst	Cable Multiburst	FCC Composite	N
60% Sweep	Cable Sweep	Cable Multiburst	O
5-Step	SIN X/X	Cable Sweep	P
Mod. 5-Step	Matrix	SIN X/X	Q
Matrix	0 IRE, no Burst	Matrix*	R
Field Square Wave	Field Square Wave	0 IRE, no Burst	S
Bounce	Bounce	Field Square Wave	T
—	—	Bounce	U

* These signals have 0 IRE setup and differ from the signals with the same name in the NTSC signal set.

3. Select the desired test signal one of four ways:
 - Press the Bars key repeatedly to select among the available color bars signals. The signal will be output as soon as the name is displayed on the TSG 95 LCD.
 - Press the Other Signals key repeatedly to select among the “non-bars” signals. Again, the signal will be output as soon as its name is displayed on the LCD.

- Use the ▲ and ▼ keys to scroll through the full list of signals until you get to the desired signal.
- Press the appropriate letter key (A through U) to “direct-select” the signal. The available signals and their corresponding keys are listed in Table 2–1.

Outputting Audio Tones

- Toggle the audio output On/Off by pressing the **Tone On/Off** key.⁴

Selecting the Audio Frequency

1. Enter the Tone menu (press **Shift**, then **Tone On/Off**). The first menu item is TONE FREQ.
2. Use the ◀ and ▶ keys to select the desired frequency. The choices are:
50, 63, 125, 250, and 400 Hz;
1, 2, 4, 8, 10, 12.5, 16, and 20 kHz;
USER1, USER2, USER3; and
SWEEP 50–20K (a 50 Hz–20 kHz sweep)

You may specify the USER# frequencies through the Utility/Calibration menu; see page 5–7. (Note that there is no default value for USER3; therefore, the USER3 choice will not appear in a new—or reset—instrument.)

You can pause a sweep at any of its 27 frequency steps (listed in Table 1–8 in the Characteristics section) by pressing **Enter** when in the TONE FREQ menu item and SWEEP 50–20K is selected. The message SWEEP PAUSED will appear on the display. You may find this capability useful for checking a problem noticed at a particular frequency while sweeping. Press **Enter** a second time to resume the frequency sweep.

3. Tone frequencies are in effect as soon as they are indicated on the display. Scroll down to other Audio menu items with the ▼ key, or exit the menu by pressing any rectangular key.

Setting the Audio Tone Level (Amplitude)

1. In the Audio menu, use the ▼ or ▲ key to reach the TONE LEVEL item.
2. Use the ◀ and ▶ keys to select the desired level. When manufactured, the four TSG 95 tone levels are designated as –10, 0, +4, and +8 dBu and calibrated to those amplitudes. Qualified technicians may rename and recalibrate the tone levels to any integer value within the ranges of –10 to –3 dBu and 0 to +10 dBu. See page 4–29 for instructions.
3. The new tone level will be in effect immediately. Scroll to other Audio menu items with the ▼ or ▲ key, or exit the menu by pressing any rectangular key.

Inserting Channel-ID Clicks in the Audio

When click is enabled, the instrument will insert a single click into channel 1, and a double click into channel 2.

1. In the Audio menu, use the ▼ or ▲ key to reach the CLICK item.
2. Use the ◀ and ▶ keys to toggle the ID clicks On/Off.
3. Scroll to other Audio menu items with the ▼ or ▲ key, or exit the menu by pressing any rectangular key.

Inserting ID Messages

- Toggle the ID message or cycle on and off by pressing the **ID On/Off** key. The status of the ID—on, off, or cyc (cycle)—is indicated on the second line of the TSG 95 display, as shown in the next illustration.

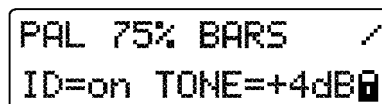

Editing ID Messages

Only the current ID message may be edited in the TSG 95.. The “current” message is the ID that will appear in the output if ID=on. (The current ID will not appear in the output when ID=off, and may not appear in the output if ID=cyc, but it can still be edited and saved in either case.)

1. Press **ID Edit**. The current ID message will appear on the LCD.
2. Use the arrow keys to position the blinking underline cursor and enter text with the alphanumeric keys.
3. Press **Enter** or one of the rectangular keys to terminate the ID edit; the new ID will become the current ID. If ID=on, the new ID will be inserted into the video output.

Positioning ID Messages

The current ID can be positioned within the safe area of active video, or the first line can be placed in the vertical interval.

1. Press **Shift**, then **ID Edit**. The LCD will look something like this:

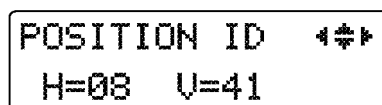

2. Change the horizontal (H) position with the ◀ / ▶ keys and the vertical (V) position with the ▲ / ▼ keys.

The H position can range from 00 (left edge of safe area) to 69–3*n*, where *n* is the number (1–16) of the right-most character position occupied by the message. Note that, when editing a short message (*n*<16) that has been

placed as far to the right as possible, the end character positions will be occupied by ■ symbols. You will not be able to put characters in those positions until the message is repositioned to the left.

The V setting can range from 00 (top of safe area) to 41 (bottom). The vertical interval is indicated by V=vert; it is one ▲ key press above V=00. Only the first ID message line will fit into the vertical interval.

3. When the ID message is in the desired position, press any rectangular key to resume normal operation. Note that unless the ID is saved (see “Saving ID Messages,” below), changes to the ID position will be lost when the instrument is switched off.

Saving ID Messages⁴

The contents and position of the current ID can be stored in one of eight ID# locations for later recall or inclusion in an ID cycle.

1. Press **Shift**, then **Recall**. The display will change to resemble this illustration:

```

STORE ID# 1◀▶
CURRENT MESSAGE▶

```

The first line of the current message will occupy the bottom half of the display. You may scroll between the first and second lines of the message with the ▼ and ▲ keys.

2. Use the ◀ and ▶ keys to select the ID# location (1 through 8) in which the current message is to be stored. Note that the previous contents of that location will be overwritten.
3. When the desired storage number is displayed, press **Enter** to save the message; press any rectangular key to abort the operation and return the instrument to normal operation.

Recall the message later with the **Recall** key, as described next.⁴

Recalling ID Messages

1. Press the **Recall** key.
2. Use the ◀ and ▶ keys to select one of the ID message numbers, ID# 1 through ID# 8. The first line of the message will appear on the second display line; press the ▼ key to see the second line of the message. For exam-

ple, if the saved ID#1 is "TEKTRONIX TSG95 PAL/NTSC" The display will first look like this:

```

Recall ID# 1◀▶
Tektronix TSG95█
    
```

Pressing the ▼ key will change it to this:

```

Recall ID# 1◀▶
█PAL/NTSC█
    
```

Note that an empty character position will show as a black space in the video, while the █ symbol indicates a "Blank." Underlying video will show through a Blank.

3. Press **Enter** to recall the ID message.
4. Press any rectangular key to exit the Recall menu and resume normal operation.

Setting up an ID Cycle

An ID cycle is a sequence of up to four stored ID messages. Once you set up a cycle, it will be inserted in the video output if: ID is toggled On with the **ID On/Off** key, and the ID CYCLE item of the ID menu is set to "on." When those two conditions are met, the TSG 95 display will indicate ID=cyc during normal operation.

1. Edit and save the ID messages that you want to cycle (see "Editing ID messages," page 2–10). Note the numbers of the IDs, and the order in which they should appear.
2. Enter the ID menu by pressing **Shift**, then **ID On/Off**.
3. Press ▼ twice to reach the CYCLE SETUP item, then press **Enter**. The display will resemble the following illustration.

```

CycSeq #1 2 3 4
LINE1 OF ID# 1█
    
```

4. Use the ◀/▶ keys to move the underline cursor to one of the four sequence "time intervals." The IDs will appear in the order that their numbers appear—from left to right—on the display.

5. Use the ▲ / ▼ keys to select the number of the ID to appear during each interval. Choose the hyphen (it's below #1) to eliminate the interval. If you want a blank interval (that is, a time gap between ID messages, which will create the impression of “blinking” messages), you must create an all-blank ID to put in that time interval.
6. When the correct ID numbers occupy all four time interval positions, press a rectangular key to exit the ID menu. The cycle sequence information will be written to the instrument memory.

Note that the TSG 95 “remembers” the ID#, not the actual message. Therefore, if you save a new message as ID# 1, the new message will appear the next time an ID cycle comes to a time interval in which ID# 1 is displayed.

7. To set the duration of each cycle time interval, re-enter the ID menu (by pressing **Shift**, then **ID On/Off**), then press the ▼ key to reach the CYCLE TIME menu item. Use the horizontal arrow keys to select the duration between one and nine seconds.
8. To insert the ID cycle instead of the current ID, scroll up the ID menu to the ID CYCLE (on/off) selection. Press ◀ or ▶ to toggle the selection. The cycle will appear in the picture if toggled on with the **ID On/Off** key.

Saving (Storing) Presets

To save the current instrument settings as a preset:

1. Press **Shift** and then **Recall**.
2. Scroll through the “STORE ID” (#1 through #8) and “STO PRESET” (#1 through #4) locations with the ◀ / ▶ keys. The first line of the current ID will be displayed on the second line of the LCD.
3. When the desired storage number is displayed, press **Enter** to save the current instrument settings. Remember that storing the current settings will overwrite the contents of the selected PRESET# location.
4. Press any rectangular key to exit the Store function.

A preset includes all of the instrument settings in effect when the preset is saved, including the current output format (signal set), test signal, audio tone settings, ID, and ID cycle setup. Note that while the *current* ID is saved, the particular messages used in a saved cycle are *not* stored. Thus, if the cycle stored with a preset “remembers” to display ID# 4 (for example), the *latest* message in ID# 4 will appear whenever that preset is recalled.⁵⁶

Recalling Presets

1. Press **Recall**.
2. Scroll through the “RECALL ID” (#1 through #8) and “RCL PRESET” (#1 through #4) locations with the ◀ / ▶ keys. The first line of the preset “cur-

rent” ID message will occupy the bottom line of the display; use the ▼ key to see the second line.

3. When the desired storage number is displayed, press **Enter** to recall the preset. The video and audio output of the TSG 95 will return to the signal and tone that was selected when the preset was stored.
4. Press any rectangular key to exit the Recall menu.

Theory of Operation

This section contains a description of the TSG 95 circuitry based on the block diagram shown in Figure 3-1.

Circuit Description

This document describes the circuits of the TSG 95. The instrument consists of a keyboard, LCD, microprocessor, clock oscillator, character ID generator, digital timing and signal generation, video DAC and output, audio tone generation, and power supply. Refer to the schematics of the instrument for references to parts and signal labels.

Microprocessor The microprocessor (μP , U2) interfaces with several parts of the instrument. Most of this interfacing is done through the ASIC (U26). See schematic diagram A1 <2>.

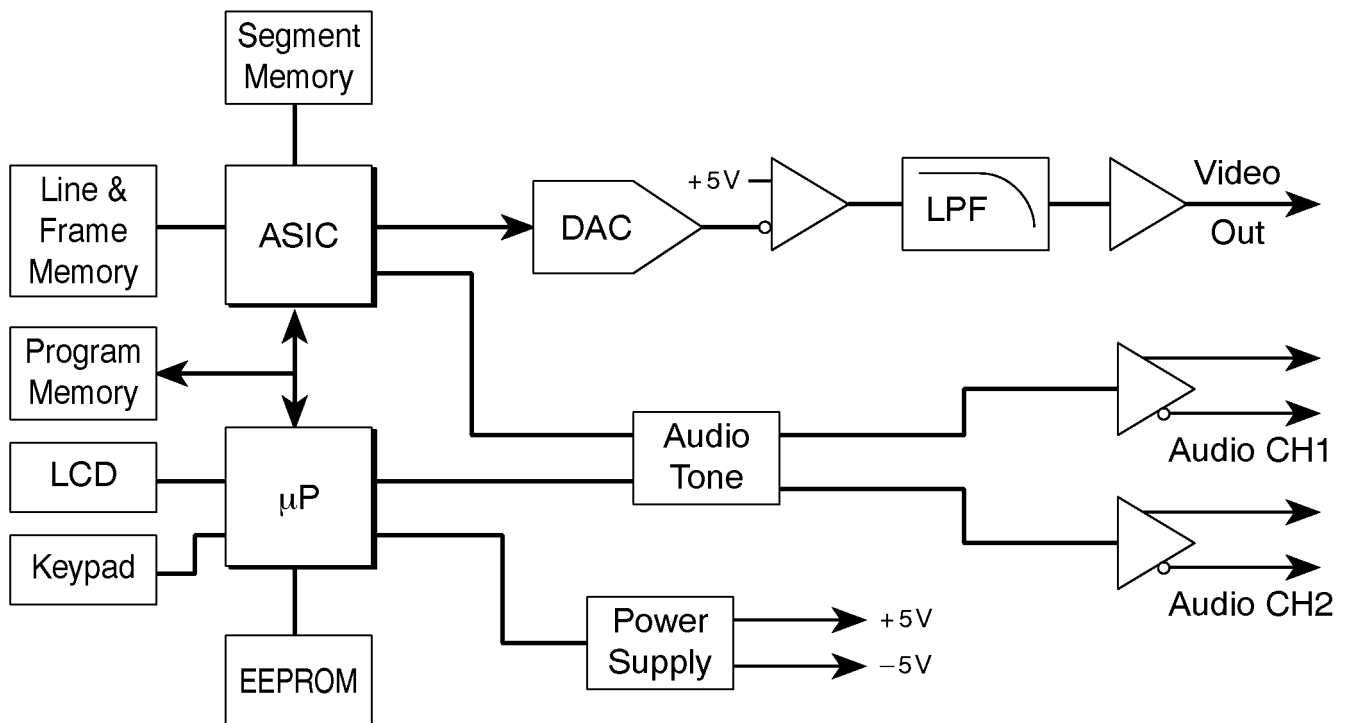

Figure 3-1: TSG 95 Block Diagram

The program memory is stored in the ROM (U24). The ROM is accessed with the help of the ASIC. Since the lower address information and the data are multiplexed on port D of the μ P, the ASIC is used to latch the lower eight bits of the address. This lower address byte is available on pins AO7..AO0 of the ASIC. The upper byte of the address comes from the μ P port F. The ASIC also decodes the address and the read, write, and address latch enable.

Ports A and B of U2 are used to interface with the keyboard (A2) through J2. The keyboard is configured in a row and column format. The row lines are inputs to U2 that are pulled up to +5 V by R2. A key press connects a row to a column. U2 drives the column lines low (0 V) one by one; reading the row lines each time to decode a key press. Only single key presses are decoded. If two or more keys are pressed simultaneously they are ignored. U2 poles the keyboard every 25 ms checking for key presses.

The upper two bits of port B are used to interface with a serial EEPROM (U4). U4 contains stored IDs, user presets and power-up configuration information. NVSCL is a serial clock generated by U2. NVSDA is a bi-directional serial data bus. Information is passed from U2 to U4 through these lines.

Bit 5 of port B is used to toggle the watch dog (U23) input. U23 must be toggled every 500 ms or it may reset the μ P. U23 will also reset the μ P if the power supply voltage drops below 4.5 V. When the instrument is powered up, U23 holds the μ P in reset until the power supply stabilizes.

Port C has several functions. Bits 3..0 are used as a 4-bit data bus. This bus is used for communications with the LCD and a digitally controlled pot (EEPOT, U16, A1 <3>). The EEPOT is used to change the tone levels. Bits 6..4 are used to control communications with the LCD. Bit 7 is used to control communications with the EEPOT.

Portions of the circuitry are also controlled by the μ P via the ASIC. The ASIC contains registers that can be written to that control output pins. An 8-bit port labeled PORT1, and a 4-bit port labeled PORT2 are available. PORT1 bits 1..0 (AUDLAT, AUDSID) are used for communications with the tone chip (U12, A1 <3>). Bit 2 (LCDBL) is used to turn the LCD backlight on and off. Bit 3 (PWRDN) is used to turn the instrument off through the power supply controller. Bit 7 (DACGAIN) is used to change the gain of the DAC to adjust scaling for PAL(HIGH) or NTSC(LOW) signals. PORT2 is used for turning the tone on and off (AUDON), clicking the tone channels separately (ACH1_OFF and ACH2_OFF), and attenuating the tone for a -10 dBu level (ANEG10DB).

There are also two pins that generate strobes when they are addressed. STRBHI generates an active high strobe when addressed, and is used as the data clock (AUDSCK) for the tone chip (U12, A1 <3>). STRBLOW is an active low strobe that is used to reset counters in the ASIC.

Two of the analog-to-digital converter (ADC) inputs on the μ P are used. One monitors the battery or input voltage (VIN). A resistive divider (R28 and R29)

applies 0.2315 times V_{IN} to the ADC input. The ADC reference voltage is 2.5 V from (U20, A1 <3>).

Another ADC input is used to monitor the ON key. Power is turned on by the hardware without μP interaction; however, power is always turned off by the μP . When the ON key is pressed, V_{IN} is applied to the gate of Q2, which is normally pulled down by R30. This causes Q2 to pull the input of the ADC down which is normally pulled to +5 V through R2.

The MODE0, MODE1, STOP, and NMI pins are pulled up by R2.

LCD Display

The LCD is controlled by the microprocessor (U2) through connector J1, which serves as a 4-bit data bus (UPD3..0) and control lines LCDE, Lcdr/W, and LCDRS. LCDE enables the LCD interface; Lcdr/W selects whether a read or write operation is being performed; and LCDRS selects whether an instruction or data is being sent to the LCD.

R1 and R25 set the display contrast.

The LCD backlight power is applied through J6 by Q1 and R26. The on resistance of Q1 and R26 sets the amount of current, and therefore brightness, of the backlight.

Character Generation

Character generation is performed by the ASIC (U26). The character information is loaded into U26 by the microprocessor (μP , U2).

Clock Generation

The 27 MHz, temperature-compensated oscillator (TCXO) Y1 is the source of all clocks in the system. U21 is used to buffer the output of the oscillator. The buffered clock drives only the ASIC (U26). The ASIC generates a divide-by-two clock (UPCLK) and its complement (\overline{UPCLK}) to act as the clock for the μP . The ASIC also generates a divide-by-eight clock (AUDCLK) for the tone chip (U12). The DAC (U14, A1 <3>) is driven by a delayed version of the 27 MHz clock.

Digital Timing and Signal Generation

The heart of the digital timing and signal generation is an ASIC (U26); see schematic A1 <2>. This chip generates addresses for the signal memory (U5 & U7), processes data from that memory, generates characters, latches and decodes μP addresses, acts as a μP interface, and generates a clock for the tone chip (U12, A1 <3>).

The test signals are broken down into eight point data segments. These segments are stored in the RAM (U5). The eight segments are put together to form the test signal. The ASIC gets the information to form video lines and frames from U7. The lower four address lines of U5 are constantly addressed by the lower four bits of the YC/horizontal counter. Counting off Cb, Y, Cr, Y to form eight points of Y data in segments of multiplexed Y and C data. The lsb does the toggling between Y and C data, while the next three bits count off the eight points.

Once the signal data has been processed by the ASIC it is output to the DAC (U14, A1 <3>, D0..9).

The ASIC provides a divide-by-eight (3.375 MHz) clock to the tone chip (U12).

Video DAC and Output

The digital-to-analog converter (DAC, U14, A1 <3>) takes 10-bit data from the ASIC (U26, A1 <2>) and converts the data to an analog signal. U14 gets its 27 MHz clock, which is a delayed and buffered version of the oscillator (Y1, A1 <2>) output, from the ASIC. U14 provides its own band-gap reference voltage. This reference voltage is decreased when transistor Q8 is switched on with a low level on DACGAIN. R66 is used to adjust the decrease in gain. Q8 is off (DACGAIN high) for PAL and on (DACGAIN low) for NTSC to maintain correct scaling for both standards. The power supply for U14 is +5 V filtered through R16 and C11.

The output of U14 is applied to an op-amp (U15) which is configured as a differential amplifier (diff amp). The output of the DAC is referenced to +5 V and varies between +3 V and +5 V. The diff amp has a gain of 0.487 and references the signal to ground. This gives a voltage range of 0 V to 0.975 V. R32 and R33 form the noninverting input of the diff amp, and are connected to +5 V. R34 and R35 form the inverting input, and are connected to the DAC output. The difference between +5 V and the DAC output voltage is amplified by 0.487 and referenced to ground. Note that the output of the DAC is an inverted video signal which is then inverted by the diff amp.

The output of the diff amp (U15) is applied to R6. R6 serves as a source termination of 75 Ω for the output filter. The combination of R6 and R14 causes the amplitude of the video signal to be halved.

The output filter is formed by L4–L6 and C36–C43. It serves as an antialiasing filter for the DAC output.

The output filter is terminated into 75 Ω (R14) and applied to the op-amp U11. U11 is configured as a noninverting amplifier. The gain of this amplifier is determined by R52, R11, R10, R8, and R7.

The gain of the amplifier is set by varying a potentiometer, R52. The amplifier gain is used to establish a 1 V video output level. The offset voltage is set by R8, R7, R52, R11, R10, and the 2.5 V reference (U20). The offset can be varied by potentiometer R7. The offset is used to obtain the negative voltage required for horizontal sync.

A $\sin x/x$ correction for the digitally constructed signal is performed by R9, R71, C6, and C7; C7 and R71 are used to vary the amount of correction.

The output of the op-amp (U11) is connected to R13, which is the 75 Ω output resistance of the TSG 95.

Tone Generation

A programmable sine wave generator, U12, generates audio tones. U12 receives a serial data stream from the microprocessor (U2) through pins 6, 7, and 8. This data sets the tone frequency. Pin 3 of U12 is used by U2 to power down the tone generator. A 3.375 MHz input clock is applied to U12–16 from the ASIC (U26).

A reference voltage is applied by a digitally controlled potentiometer (U16) to U12. Pins 1, 2, and 7 of U16 interface with the μ P (U2). The 2.5 V reference (U20) sets the high voltage of U16, and potentiometer R53 sets the low voltage. The wiper, U16–5, is connected to the reference input of U12. The minimum tone level is set with R53, then the output levels are set through the keypad input to the μ P.

The tone output of U12 is filtered through R50, L10, and C58. C12 is used to AC-couple the tone to avoid DC offset.

U13 provides output amplification for the channel 1 tone. U13A is an inverting amplifier with a gain of 1.3 set by R22, R36, and R18. Q3 pulls the input of the amplifier to ground when a high level is applied, by U22, to the base of Q3. Q3 is used to apply an identifying click to the signal. Q10 causes an attenuation of the signal allowing output of -10 dBu. Fine tuning of the -10 dBu level is done through the keypad using U16. U13B is an inverting amplifier that inverts the output of U13A to create the other half of a balanced output. R20 and R21 form a $50\ \Omega$ balanced output impedance. U13 is a special op-amp that goes into a low power “sleep” mode when either a low-load current is required, or the input voltage is low. R54 is used to keep U13 from going into this sleep mode for high impedance loads.

U17 provides output amplification for the channel 2 tone in the same manner.

Power Supply

Power is applied to the TSG 95 either through a DC input jack on the side of the instrument, or through batteries in the battery compartment. The input voltage should be limited to 15 V to avoid a higher than suggested charge rate for the NiCad battery pack.

The battery compartment is designed to accept eight alkaline batteries, or a Ni-Cad battery pack. The NiCad pack applies its positive voltage and accepts its charge from special contacts in the battery compartment. The special contacts are used to prevent the application of charging current to alkaline batteries. The + side of the Nicad pack uses a special contact to prevent the application of a reverse voltage in the event that a battery pack is installed incorrectly.

The charging of the NiCad pack is done through Q6. The current through Q6 is set by resistors R57 and R58. The voltage across R57/R58 is the voltage of CR3 minus the base-emitter voltage of Q6. CR3 and R56 set the base bias voltage for Q6.

The battery voltage passes through the DC input connector J5 before it is applied to the power supply. This allows J5 to disconnect the batteries from the power

supply when a DC input voltage is applied to J5. F1 is a fuse used for safety purposes. C64 helps with EMI. Q7 is on during normal operation. If a reverse voltage is applied to the DC input, Q7 shuts off to protect the power supply circuit. VR1 limits the gate-source voltage of Q7. C57 and C56 control ripple on the input voltage.

U22 allows the microprocessor (U2) to turn off the power supply. The power supply for U22 is connected to a regulator (U25), which is connected to the input voltage. This allows U22 to stay powered up even when the instrument is switched off. When the ON key is pressed U22-10 gets pulled high; normally it is pulled low by R30. U22B is connected to act as an inverter pulling U22A-4 low. This sets U22A-6 low, enabling the power supply controller (U27) through U27-5. When the ON key is pressed again, U2 detects the key press, stores information for power up, and then drives the gate of Q5 high and then low. This causes the drain of Q5 to be pulled low and then high, clocking the flip-flop U22A. Since the \bar{Q} output of U22A is tied to its input, the flip-flop toggles its \bar{Q} output high. This disables the power supply, shutting the instrument off. R70 and C78 keep the instrument from coming on automatically when an adapter is plugged in or new batteries are put in the instrument.

The -5 V supply voltage is generated off the +5 V supply through transformer L9. CR1 and CR2 keep the current from flowing on the inactive parts of the switching cycle for each supply. L9 also helps to filter the +5 V and -5 V supplies along with C53, C54, and C77. L2 and L3 are used to filter the supplies which are used in analog portions of the circuitry.

Performance Verification and Adjustment Procedures

This section consists of a detailed performance verification procedure to verify the operation of the TSG 95, and an adjustment procedure to return the instrument to in-spec operation.

The order of these procedures has been chosen to minimize changes in equipment setup. Performance parameters may be checked in any order. As some of the calibration steps are interactive, care must be taken when adjusting individual parameters to ensure that all others remain within specification.

A performance verification checklist begins on page 4–3.

Performance verification procedure instructions begin on page 4–4.

An adjustment checklist appears on page 4–22.

Adjustment instructions begin on page 4–24.

Required Test Equipment

The following list of equipment represents the minimum required for the Performance Verification and Adjustment procedures. While alternate equipment may be used, it is not recommended. Alternate equipment must meet the minimum specifications for the listed equipment. Use of inadequate equipment may result in faulty measurements or calibration.

Table 4–1: Required Test Equipment

Item	Information/Requirements	Example
PAL/NTSC Video Measurement Set	For measuring and displaying line and field-rate waveforms. Must be capable of making differential phase and gain measurements.	Tektronix VM700A Video Measurement Set, Option 01/11.
Audio Measurement Set	Must be capable of measuring Total Harmonic Distortion.	Tektronix VM700A with Audio Option 40.
Frequency Counter	Must be accurate to within 2.5 Hz out of 5 MHz.	Tektronix DC503A; plugs into a TM503 power mainframe.
PAL or NTSC Video Signal Generator	Must be capable of being genlocked to the TSG 95 Video output, and must have a Sub-carrier output.	Tektronix TSG-170A (NTSC), Tektronix TSG-271 (PAL).

Table 4-1: Required Test Equipment (Cont.)

Item	Information/Requirements	Example
Audio Cables (2)	Female XLR to male Mini XLR with 600 Ω load on cable or audio measurement set.	Figure 4-1 shows cable suitable for use with VM700A option 40.
BNC Coaxial Cable	75 Ω impedance.	Tektronix p/n 012-0074-00.
End-Line Termination	75 Ω , 0.025% termination with BNC connector.	Tektronix p/n 011-0102-01.

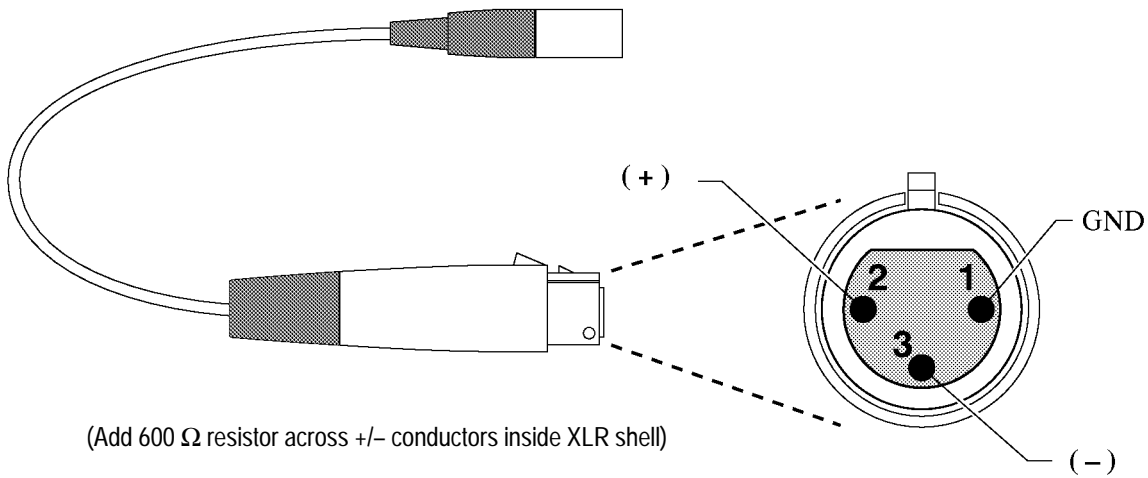

Figure 4-1: XLR Female to Mini XLR Male Adapter Cable/Pinout

Performance Verification Checklist

Use the following checklist if you are familiar with the operation of the TSG 95 as well as video and audio performance verification techniques. Step-by-step instructions for all of the procedures begin on page 4–4.

Oscillator Frequency

NOTE. After initial delivery or long storage, allow a two-hour warm-up time to re-age the crystal. Thereafter, 20 minute warm-up time is sufficient.

1. Check Subcarrier Frequency
Subcarrier of genlocked generator =
 PAL: 4.43361875 MHz \pm 10 Hz
 NTSC: 3.579545 MHz \pm 10 Hz

Test Signals

2. Check Blanking Level
 PAL and NTSC: 0 V \pm 50 mV
3. Check Sync Amplitude
 PAL: 300 mV \pm 14 mV
 NTSC: 285.7 mV \pm 14.28 mV (40 IRE \pm 2 IRE)
4. Check Burst Amplitude
 PAL: 300 mV \pm 14.0 mV
 NTSC: 285.7 mV \pm 14.28 mV (40 IRE \pm 2 IRE)
5. Check Sync Rise Time
 PAL: 250 ns \pm 25 ns, 10% to 90%
 NTSC: 140 ns \pm 20 ns, 10% to 90%
6. Check 5-Step Linearity
 PAL and NTSC: Max diff step difference \leq 1%
7. Check Luminance Amplitude Accuracy
 PAL: 700 mV \pm 7.0 mV
 NTSC: 714 mV \pm 7.14 mV (100 IRE \pm 1 IRE)
8. Check Chrominance-to-Luminance Delay and Gain
 PAL: Delay \leq 10 ns, Gain \leq 2% (14 mV)
 NTSC: Delay \leq 15 ns, Gain \leq 2% (14.28 mV)

9. Check Differential Gain and Phase
 - PAL and NTSC: Diff gain $\leq 1\%$
 - PAL and NTSC: Diff phase $\leq 1^\circ$
10. Check Multiburst Frequency Response
 - PAL: $\pm 2\%$ to 4.8 MHz, $\pm 3\%$ to 5.8 MHz
 - NTSC: Flat Packets, equal amplitude $\pm 2\%$ to 4.2 MHz
11. Check Line Tilt
 - PAL: ≤ 3.5 mV
 - NTSC: ≤ 3.57 mV (0.5 IRE)
12. Check K-Factor
 - PAL and NTSC: 2T pulse K-Factor $\leq 0.5\%$
13. Check SCH Phase
 - PAL and NTSC: SCH Phase = $0^\circ \pm 5^\circ$
14. Check Field Tilt
 - PAL: ≤ 3.5 mV
 - NTSC: ≤ 3.57 mV (0.5 IRE)

Audio Outputs

1. Check Total Harmonic Distortion (20 kHz bandwidth)
 - Channel 1 $\leq 1\%$
 - Channel 2 $\leq 1\%$
2. Check Audio Output Amplitude
 - -10 dBu = -10 dBu ± 0.25 dBu at 1 kHz, both channels
 - 0 dBu = 0 dBu ± 0.25 dBu at 1 kHz, both channels
 - 4 dBu = 4 dBu ± 0.25 dBu at 1 kHz, both channels
 - 8 dBu = 8 dBu ± 0.25 dBu at all frequencies, both channels
3. Check Audio ID Click

Performance Verification Procedures

This procedure uses the following convention to differentiate between front-panel hard keys and displayed soft keys; hard keys are displayed in bold, and soft keys are bold enclosed with < > symbols. For example: **Measure** hard key, and <**H_Timing**> soft key.

Preparation

The VM700A Auto Measure mode is used in this procedure. If you cannot find a specific measurement in Auto mode, check that the measurement is selected in

the Selected Measurements file. See your VM700A Operators manual for additional information on selecting measurements.

VM700A Auto Mode Configuration. The following procedure sets up the VM700A so that the Auto Measurements mode can be used.

1. Turn on the VM700A.
2. Press the following VM700A keys: **Configure**, **<Configure Files>**, and **<Measurement Locations>**.
3. If you are not in the NTSC directory, press the **<Switch NTSC/PAL>** key.
4. Create a new NTSC Measurements Location file.
 - a. Press **<Create File>** and then **<System Default>**.
 - b. Enter “pv” for a file name then press **<Done>**.

NOTE. *At this point you will be in the pv file and will be able to edit it.*

- c. Rotate the knob until the Auto Mode “Composite X XX” line is highlighted, where XX is a number from 10 to 262.
 - d. Press your finger on the screen over the “XX” readout; a box should now appear around the readout.
 - e. Rotate the knob until “30” appears on the readout.
 - f. Press the following keys: **<Accept Input>**, **<Update & Exit>**, and **<Leave Directory>**.
5. Create a new NTSC Video_Source file.
 - a. Press the following keys: **<Video_Source Files>**, **<Create File>**, and **<System Default>**.
 - b. Enter “pvfile” for a file name, then press **<Done>**.
 - c. Rotate the knob until the “Measurements Location File: XXXXX” line is highlighted. XXXXX will be the name of the measurements location file currently in use.
 - d. Record the currently used measurements location file so that when you have finished testing the TSG 95 you can return the VM700A to the original settings.
 - e. Press your finger over the “XXXXX” readout; a box should now appear around the readout.

- f. Rotate the knob until the readout displays “pv”.
 - g. Press <Accept Input>, <Update & Exit>, and <Leave Directory>.
6. Create a new PAL Video_Source file.
- a. Press the <Switch NTSC/PAL> key to bring up the PAL Configure files.
 - b. Press the following keys: <Video_Source Files>, <Create File>, and <System Default>.
 - c. Enter “pvfile” for a file name, then press <Done>.
 - d. Rotate the knob until the “Measurements Location File: XXXXX” line is highlighted. XXXXX will be the name of the measurements location file currently in use.

NOTE: If the XXXXX is “System~Default” press <No Change & Exit> and <Leave Directory> then go to step 7.
 - e. Record the currently used measurements location file so that when you have finished testing the TSG 95 you can return the VM700A to the original settings.
 - f. Press your finger over the “XXXXX” readout; a box should now appear around the readout.
 - g. Rotate the knob until the readout displays “System~Default”.
 - h. Press <Accept Input>, <Update & Exit>, and <Leave Directory>.
7. Change the Source Selection file currently used.
- a. Press <Source_Selection Video>, and then rotate the knob until the “Source A:” line is highlighted.
 - b. Record the video source files that are currently used in both video standards (from the ”Source A: ...” line). When you have finished testing the TSG 95 you can return the VM700A to the original video source files using this recorded data.
 - c. Press your finger on the screen over the NTSC video source file name; a box should now appear around the file name.
 - d. Rotate the knob until the readout displays “pvfile”.
 - e. Press <Accept Input>.
 - f. Repeat steps c through e for the PAL video source file, then press <Update & Exit>.

Oscillator Frequency

NOTE. After initial delivery or long storage, allow a two-hour warm-up time to re-age the crystal. Thereafter, a 20 minute warm-up time is sufficient.

1. Check Subcarrier Frequency

- a. Connect the TSG 95 Video output to the genlock input of the NTSC test signal generator with a 75 Ω coaxial cable as shown in Figure 4–2. Terminate the genlock input in 75 Ω , if required.
- b. Connect the NTSC test signal generator subcarrier output to the frequency counter A input, using a 75 Ω coaxial cable.
- c. Connect a reference, such as WWV, to the B input of the frequency counter.
- d. Set the frequency counter for a ratio of A/B, and set the AVG to 106.
- e. If the TSG 95 is not set to generate NTSC signals perform the following steps, otherwise continue on at step **f**.
 - Press and hold the **Lock Out** key down, then press the **ON** key.
 - Select the NTSC video standard by pressing either the ◀ or ▶ key until the standard is displayed.
 - Press the ▲ key to move to EXIT MENU, then press **Enter** to leave the Utility menu.
 - To change the VM700A video standard, press the **Measure** and <**Video Standard**> keys.
- f. CHECK — that the measured oscillator frequency is 3.579545 MHz \pm 10 Hz.
- g. Repeat steps **a** through **e** for PAL by substituting “PAL” where ever “NTSC” is called out.
- h. CHECK — that the measured oscillator frequency is 4.43361875 MHz \pm 10 Hz.

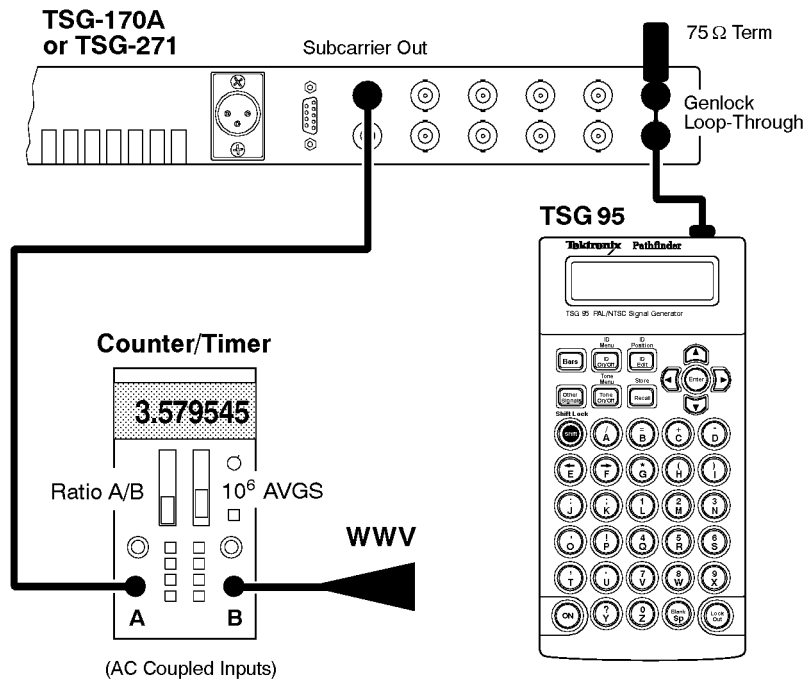

Figure 4-2: A Setup for Verifying the Oscillator Frequency

PAL Test Signals

Complete the following steps to verify PAL performance of the TSG 95.

1. Check Blanking Level

- a. Connect the TSG 95 Video output to the VM700A Channel A Input and terminate the loophrough in 75 Ω .
- b. Select the Matrix signal from the TSG 95 (press **R**).
- c. View Ch. A, line 265 on the VM700A.
- d. Press the following VM700A keys: **Measure**, **<Level Meter>**, **Menu**, **<Measure Position>**, **<DC Cpl. ABS. Meas>**, and **<Pos. (b)>**.
- e. Position the cursor on the color back porch.
- f. Press the **Average** key.
- g. CHECK — that Level (b) = 0 V \pm 50 mV.

2. Check Sync Amplitude

- a. Select the Matrix signal from the TSG 95 (press **R**).
- b. Press the following VM700A keys: **Measure**, **<Bar LineTime>**, and **Average**.

- c. CHECK — that Sync Level is $300\text{ mV} \pm 14\text{ mV}$.
 3. Check Burst Amplitude
 - a. Select the Matrix signal from the TSG 95 (press **R**).
 - b. Press the following keys: **Measure**, **<H_Timing>**, and **Average**.
 - c. CHECK — that the Burst Amplitude is $300\text{ mV} \pm 14\text{ mV}$. See Figure 4-3.
 4. Check Sync Rise Time
 - Check the VM700A display to verify that the Sync Rise Time is $250\text{ ns} \pm 25\text{ ns}$. See Figure 4-3.

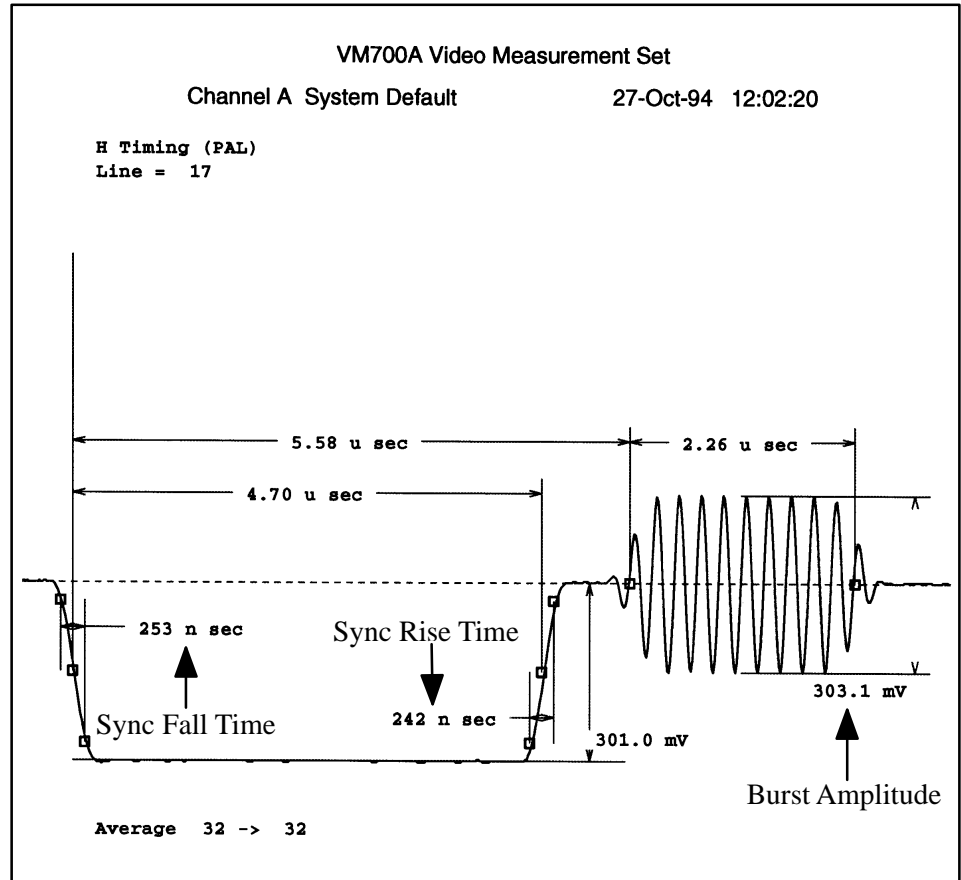

Figure 4-3: VM700A Horizontal Timing Measurement Screen

5. Check 5-Step Linearity

- a. Select the Matrix signal from the TSG 95 (press **R**).
- b. Press the following VM700A keys: **Measure**, **<Luminance NonLinearity>**, and **Average**.
- c. CHECK — that Luminance Non Linearity is $\leq 1\%$ (99 <Lum Non-Linearity> 101). See Figure 4-4.

*NOTE. The Luminance Non Linearity measurement on the VM700A is equivalent to the 5-Step Linearity specification called out in the **Specifications** section of this manual.*

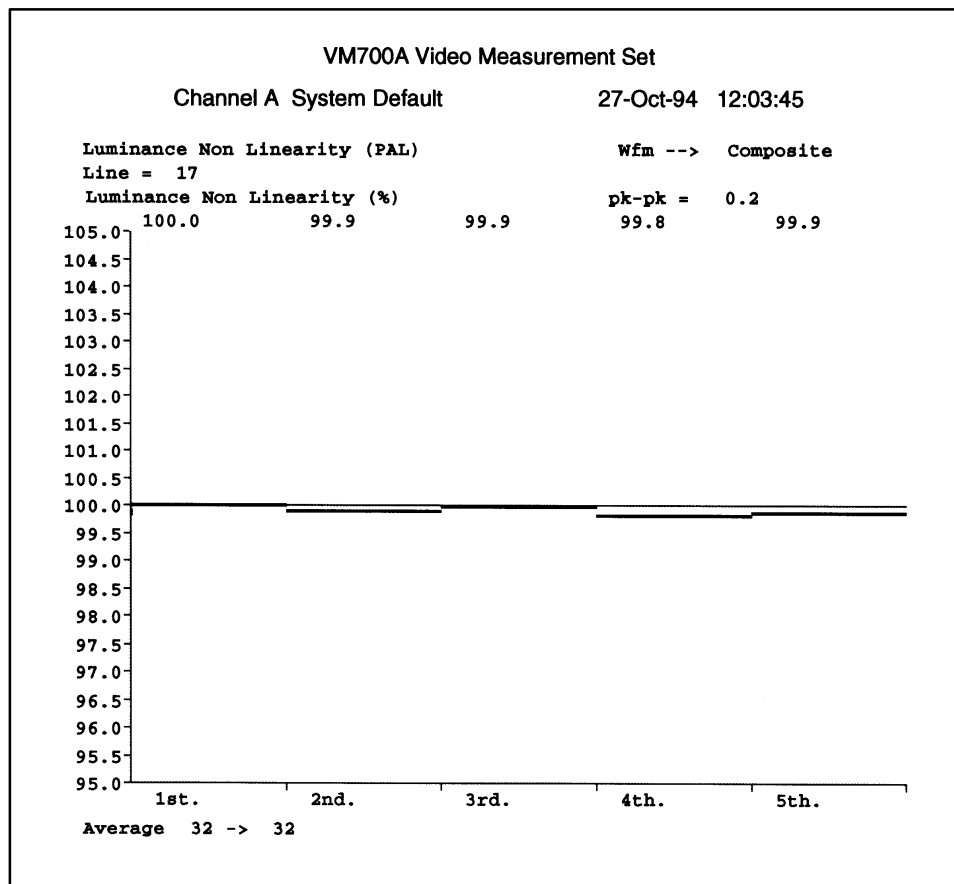

Figure 4-4: VM700A Luminance “Non Linearity” Measurement Screen

6. Check Luminance Amplitude Accuracy

- a. Select the Matrix signal from the TSG 95 (press **R**).
- b. Press the following VM700A keys: **Measure**, **<Bar LineTime>**, and **Average**.
- c. Use the VM700A front-panel knob to select line 265.
- d. CHECK — that Bar Level is $700 \text{ mV} \pm 7 \text{ mV}$.

NOTE. *The Bar Level measurement on the VM700A is equivalent to the Luminance Amplitude specification called out in the **Specifications** section of this manual.*

7. Check Chrominance-to-Luminance Gain and Delay

- a. Select the Matrix signal from the TSG 95 (press **R**).
- b. Press the following VM700A keys: **Measure**, **<ChromLum GainDelay>**, **Average**, and **Line Select**.
- c. Use the VM700A front-panel knob to select line 19.
- d. CHECK — that the Chroma Gain is $100\% \pm 2\%$.
- e. CHECK — that the Chroma Delay is $\leq 10 \text{ ns}$.

8. Check Differential Gain and Phase

- a. Select the Matrix signal from the TSG 95 (press **R**).
- b. Press the following VM700A keys: **Measure**, **<DGDP>**, **Select Line**, **<Line 330>**, and **Average**.
- c. CHECK — that each packet has a Gain $\leq 1\%$.
- d. CHECK — that each packet has a Phase $\leq 1^\circ$.

9. Check Multiburst Frequency Response

- a. Select the Multiburst signal from the TSG 95 (press **N**).
- b. Press the following VM700A keys: **Measure**, **<MultiBurst>**, **Select Line**, and **Average**.
- c. Use the VM700A front-panel knob to select line 24.
- d. CHECK — that the variance out to 4.8 MHz is $\pm 0.17 \text{ dB}$. The sixth packet (5.8 MHz) is allowed a variance of $\pm 0.25 \text{ dB}$. See Figure 4–5.

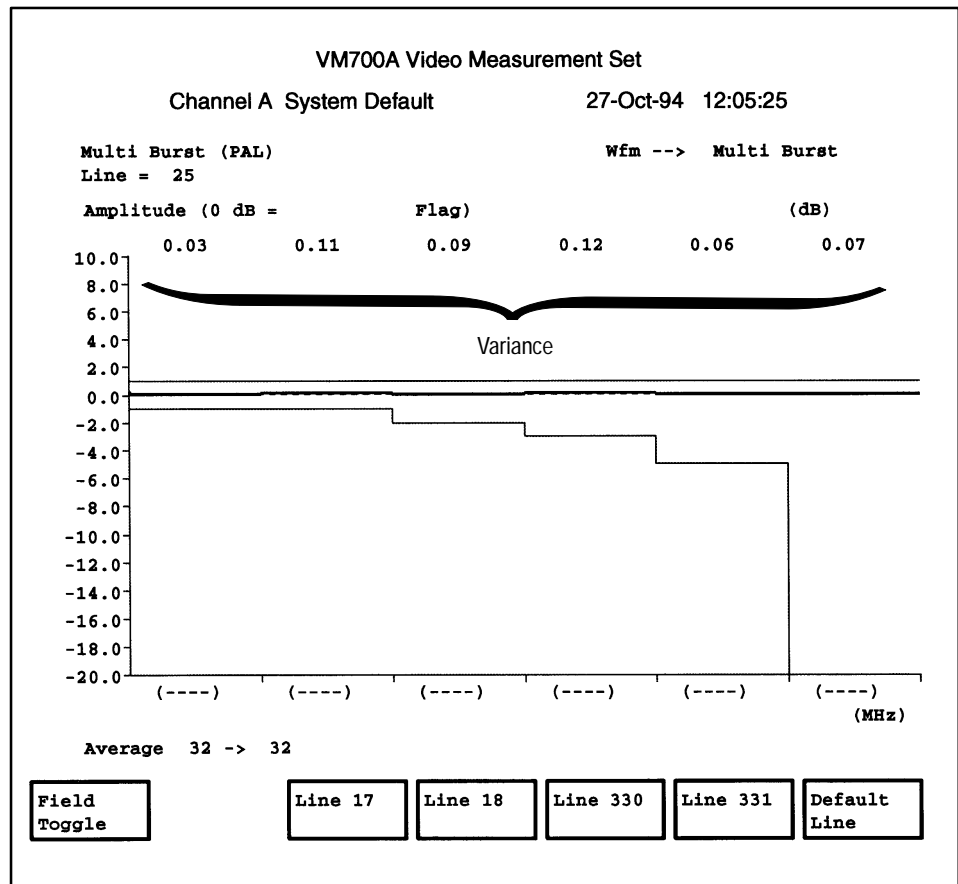

Figure 4-5: VM700A "Multi Burst" Measurement Screen

NOTE. The **Preparation** section, starting on page 4-4, has a procedure for configuring the VM700A so that the following checks can be made in Auto mode.

10. Line Tilt

- a. Select the Matrix signal from the TSG 95 (press **R**), then press the VM700A **Auto** key.
- b. Check the VM700A display to verify that Line Time Distortion is no greater than 0.5%.

NOTE. The VM700A Line Time Distortion measurement is equivalent to the Line Tilt characteristic called out in the *Specifications* section of this manual.

11. 2T Pulse K-Factor

- Check the VM700A display to verify that the 2T Pulse K-Factor is no greater than 0.5%.

12. SCH Phase

- CHECK — the VM700A display to verify that SCH Phase is $0^\circ \pm 5^\circ$.

13. Field Tilt Distortion

- a. If the TSG 95 ID is on, turn it off by pressing the **ID On/Off** key.
- b. Select the Field Square Wave from the TSG 95 (Press **S**) then press the VM700A **Auto** key.
- c. CHECK — that Field Time Distortion is $\leq 0.5\%$.

NOTE. The VM700A Field Time Distortion measurement is equivalent to the Field Tilt characteristic called out in the **Specifications** section of this manual.

NTSC Test Signals

To convert the TSG 95 to the NTSC signal set and to change the video standard of the VM700A, follow these steps:

- Press and hold the **Lock Out** key down, then press the **ON** key.
- Select the NTSC video standard by pressing the **▶** key.
- Press the **▲** key to move to EXIT MENU, then press **Enter** to leave the Utility menu.
- To change the VM700A video standard, press the **Measure** and **<Video Standard>** keys.

Complete the following steps to verify NTSC performance of the TSG 95.

1. Check Blanking Level

- a. Connect the TSG 95 Video output to the VM700A Channel A Input and terminate the loopthrough in 75Ω .
- b. Select the NTC7 Composite signal from the TSG 95 (press **K**).
- c. Press the following VM700A keys: **Measure**, **<Level Meter>**, **Menu**, **<Measure Position>**, **<DC Cpl. ABS. Meas>**, and **<Pos. (b)>**.
- d. View Ch. A line 21 on the VM700A.
- e. Position the cursor on the color back porch.

- f. Press the **Average** key.
 - g. CHECK — that Level (b) = $0\text{ V} \pm 50\text{ mV}$.
2. Check Sync Amplitude
- a. Select the NTC7 Composite signal from the TSG 95 (press **K**).
 - b. Press the following VM700A keys: **Measure**, **<Bar LineTime>**, and **Average**.
 - c. CHECK — that Sync Amplitude is $285.7\text{ mV} \pm 14.28\text{ mV}$ (40 IRE ± 2 IRE).

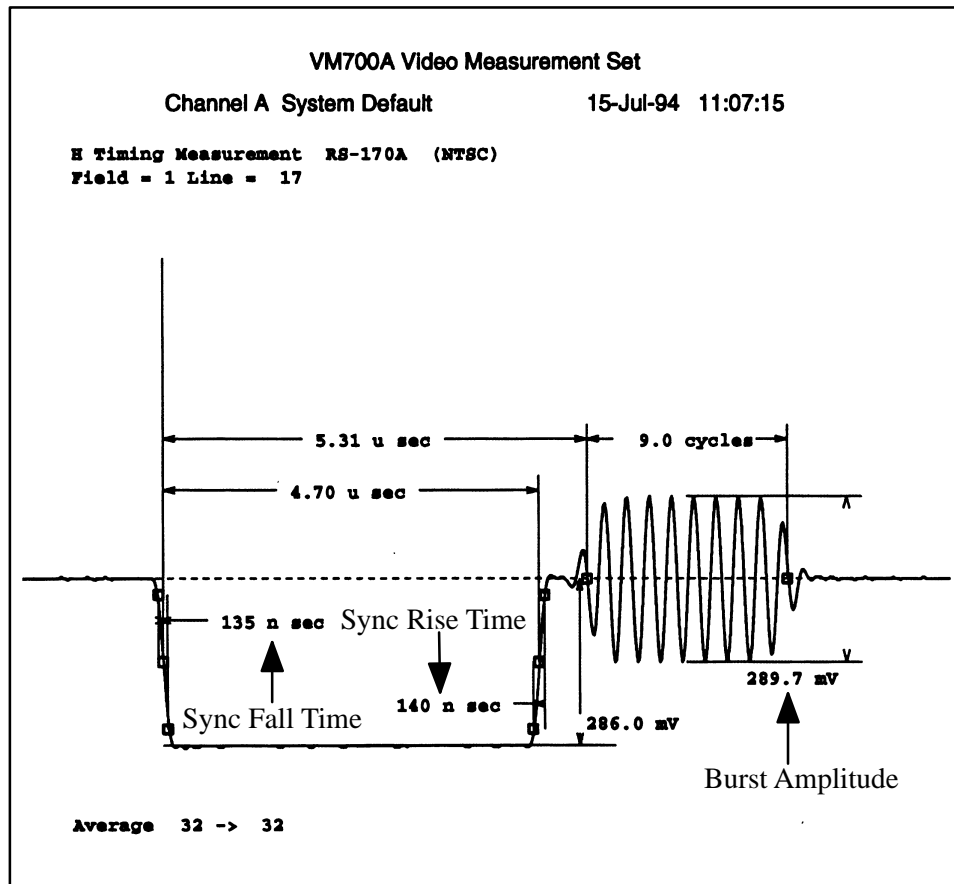

Figure 4-6: VM700A Horizontal Timing Measurement Screen

3. Check Burst Amplitude
- a. Select the NTC7 Composite signal from the TSG 95 (press **K**).

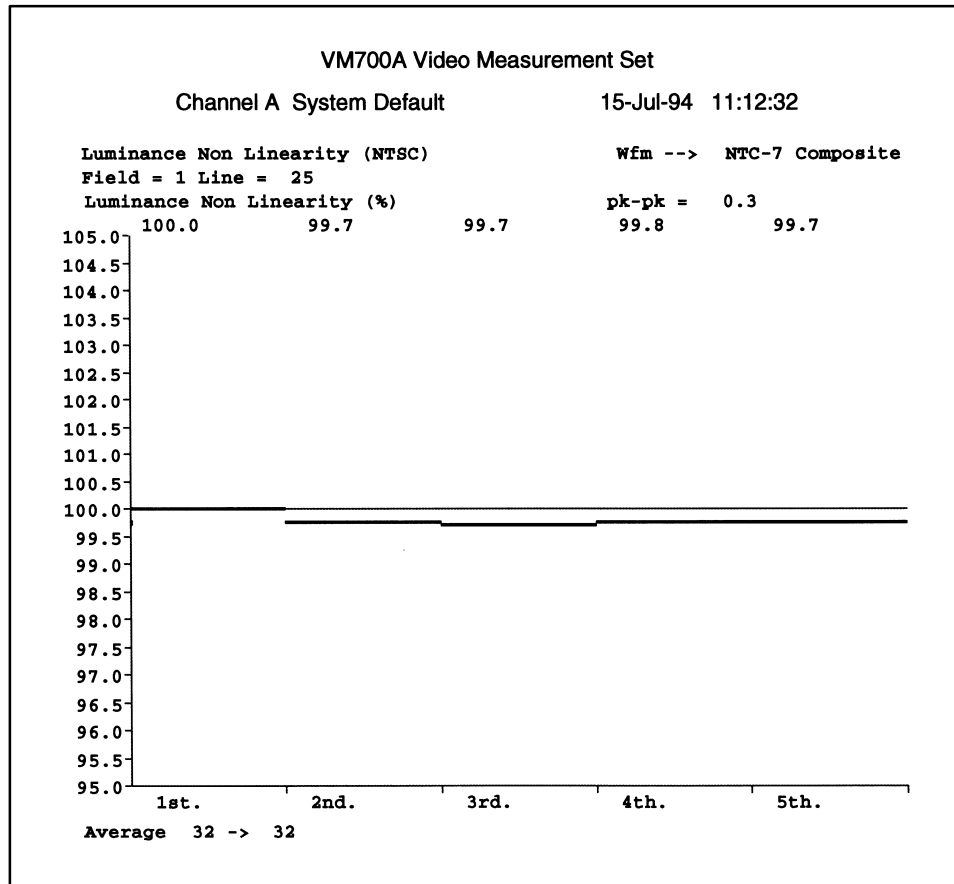

Figure 4-7: VM700A Luminance “Non Linearity” Measurement Screen

6. Check Luminance Amplitude Accuracy

- a. Select the NTC7 Composite signal from the TSG 95 (press **K**).
- b. Press the following VM700A keys: **Measure**, **<Bar LineTime>**, and **Average**.
- c. CHECK — that Bar Level is $714.3 \text{ mV} \pm 7.143 \text{ mV}$ ($100 \text{ IRE} \pm 1 \text{ IRE}$). See Figure 4-8.

NOTE. The Bar Amplitude measurement on the VM700A is equivalent to the Luminance Amplitude specification called out in the **Specifications** section of this manual.

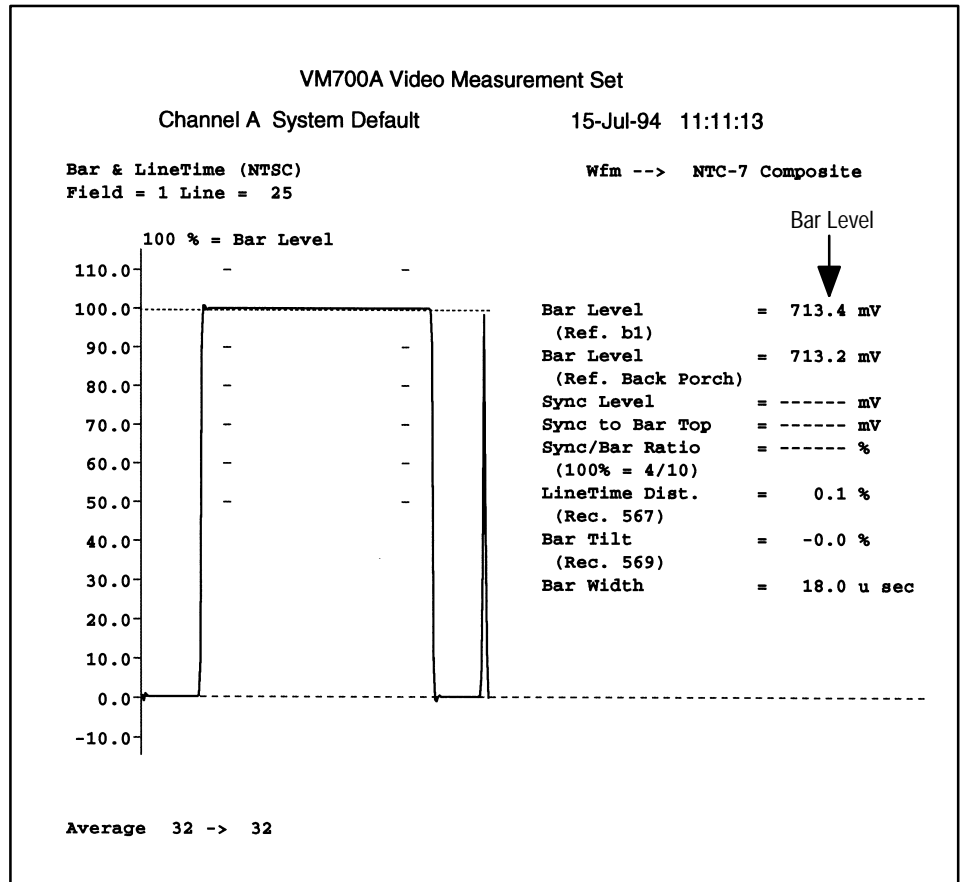

Figure 4-8: VM700A Bar Level Measurement Screen

NOTE. The **Preparation** section, starting on page 4–4, has a procedure for configuring the VM700A so that the following checks can be made in Auto mode.

7. Chrominance-to-Luminance Delay and Gain

- a. Select the NTC7 Composite signal (press **K**).
- b. Press the VM700A **Auto** key.
- c. CHECK — the VM700A display to verify that Chroma-Lum Delay is no greater than 15 ns, and Chroma-Lum Gain is $\pm 2\%$ of 714.3 mV (between 700.014 and 728.586).

8. Differential Phase and Gain

- Check the VM700A display to verify that Differential Phase is $\leq 1^\circ$, and Differential Gain is $\leq 1\%$.

9. Check Frequency Response

- a. Select the Multiburst signal from the TSG 95 (press **J**).
- b. Press the following VM700A keys: **Measure**, **<MultiBurst>**, **Select Line**, and **Average**.
- c. Use the VM700A front-panel knob to select line 100.
- d. CHECK — that the variance of each packet is $0 \text{ dB} \pm 0.17 \text{ dB}$. See Figure 4–9.

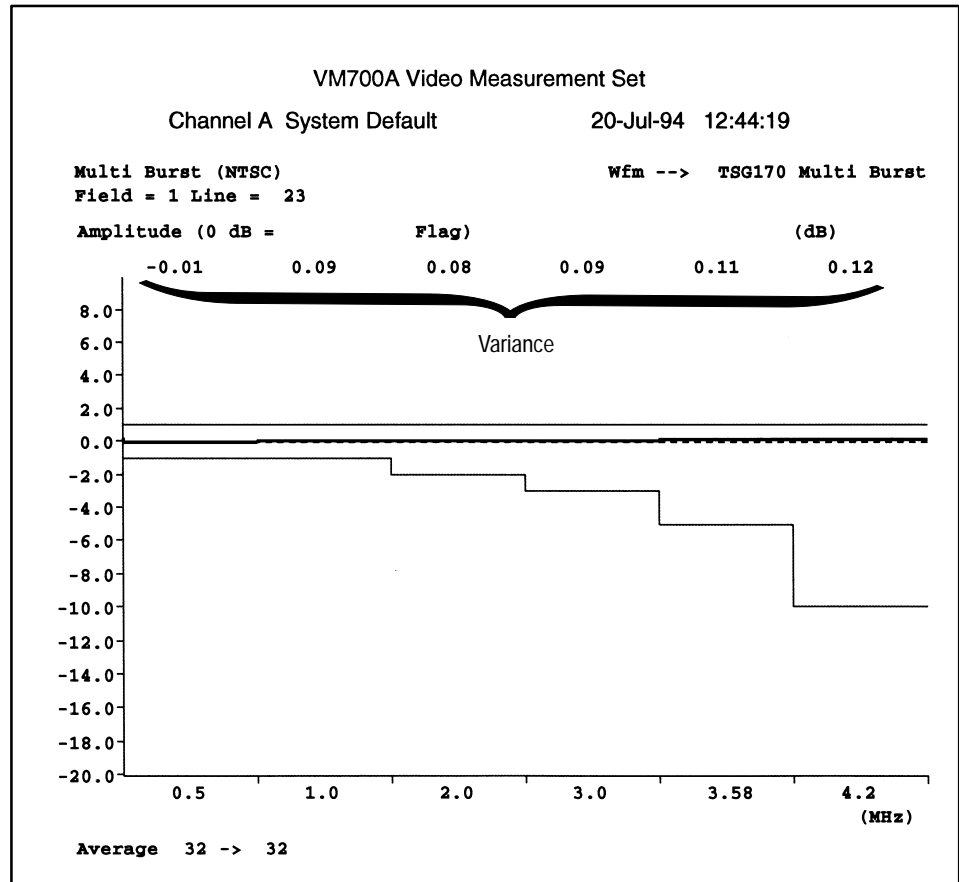

Figure 4-9: VM700A "Multi Burst" Measurement Screen

10. Line Tilt

- a. Select the NTC7 Composite signal (press **K**).
- b. Press the VM700A **Auto** key.
- c. Check the VM700A display to verify that Line Time Distortion is no greater than 0.5%.

NOTE. The VM700A Line Time Distortion measurement is equivalent to the Line Tilt characteristic called out in the **Specifications** section of this manual.

11. 2T Pulse K-Factor

- Check the VM700A display to verify that the 2T Pulse K-Factor is no greater than 0.5%.

12. SCH Phase

- CHECK — the VM700A display to verify that SCH Phase is $0^\circ \pm 5^\circ$.

13. Field Tilt Distortion

- a. If the TSG 95 ID is on, turn it off by pressing the **ID On/Off** key.
- b. Select the Field Square Wave from the TSG 95 (Press **S**) then press the VM700A **Auto** key.
- c. CHECK — that Field Time Distortion is $\leq 0.5\%$.

***NOTE.** The VM700A Field Time Distortion measurement is equivalent to the Field Tilt characteristic called out in the **Specifications** section of this manual.*

Audio Outputs

1. Check Total Harmonic Distortion (THD)

- a. Connect the TSG 95 Audio outputs to the VM700A Audio inputs.
- b. Press the following VM700A keys: **Measure**, **<Audio>**, **<Audio Analyzer>**.
- c. Set the Tone Frequency, Amplitude, and ID Click with these steps:
 - If the Pathfinder tone is off, turn it on by pressing the **Tone On/Off** key.
 - Open the Tone menu by pressing **Shift–Tone On/Off**.
 - Use the **◀** and **▶** keys to set the TONE FREQ to 50 Hz.
 - Move to the TONE LEVEL selection with the **▼** key.
 - Use the **◀** and **▶** keys to set the TONE LEVEL to 0 dBu.
 - Move to the CLICK ON/OFF selection with the **▼** key.
 - If necessary use the **◀** and **▶** keys to turn the Click off.
- d. CHECK — that both channels have a $\text{THD+N} \leq 1\%$.
- e. Use the **▲** key to move back up to the TONE LEVEL selection. Change the Pathfinder Tone Amplitude to +4 dBu (use the **◀** and **▶** keys).
- f. CHECK — that both channels have a $\text{THD} \leq 1\%$.
- g. Change the TONE LEVEL to 8 dBu.
- h. CHECK — that both channels have a $\text{THD} \leq 1\%$.
- i. Change the TONE LEVEL to –10 dBu.

- j. CHECK — that both channels have a THD $\leq 1\%$.
2. Check Audio Output Amplitude
- a. Set the TSG 95 Frequency to 1 kHz and the Audio Level to 0 dBu with these steps (as necessary):
 - Open the Tone menu by pressing **Shift–Tone On/Off**.
 - Use the ◀ and ▶ keys to set the TONE FREQ to 1 kHz.
 - Move to the TONE LEVEL selection with the ▼ key.
 - Use the ◀ and ▶ keys to set the TONE LEVEL to 0 dBu.
 - b. CHECK — (VM700A) that the Audio Level of both channels is 0 dBu ± 0.25 dBu.
 - c. Set the TSG 95 Audio Level to +4 dBu (use the ◀ and ▶ keys).
 - d. CHECK — (VM700A) that the Audio Level of both channels is +4 dBu ± 0.25 dBu.
 - e. Set the TSG 95 Audio Level to +8 dBu.
 - f. Go back up to the TONE FREQ menu item (press the ▲ key) and select the appropriate frequencies in turn to CHECK — that the Audio Level is +8 dBu ± 0.25 dBu at each of the following frequencies:
 - 50 Hz 63 Hz 125 Hz 250 Hz
 - 400 Hz 1 kHz 2 kHz 4 kHz
 - 8 kHz 10 kHz 12.5 kHz 16 kHz
 - 20 kHz
 - g. Set the TSG 95 Audio Level to –10 dBu (use the ◀ and ▶ keys).
 - h. CHECK — (VM700A) that the Audio Level of both channels is –10 dBu ± 0.25 dBu.
3. Check Audio ID Click
- a. Set the TSG 95 for a Tone Frequency of 400 Hz.
 - b. Go to the CLICK menu and turn the Audio ID “click” on.
 - c. Go to the VM700A Audio Measurements window and press <**Audio Monitor**>.
 - d. CHECK — for one click on the slanted axis, and two clicks on the opposite axis.

This completes the Performance Verification Procedure.

Adjustment Checklist

Use the following checklist if you are familiar with TSG 95 operation and adjustment. Step-by-step instructions for all of the procedures begin on page 4–24.

1. Adjust LCD Contrast
 - Adjust R1 so that unused LCD segments are just barely turned off
2. Adjust Subcarrier Frequency
 - Set frequency as close to 3.579545 MHz as possible (± 0.5 Hz).
3. Adjust Test Signal Gain and Blanking Level
 - PAL Matrix signal
 - VM700A to Measure mode — Signal Level Meter
 - Adjust R52 so Level (b–a) = 700 mV \pm 2 mV
 - Adjust DC Offset, R7, so the blanking level is 0 V \pm 20 mV
4. Adjust NTSC Gain
 - NTSC NTC7 Composite signal
 - VM700A to Measure mode — Signal Level Meter
 - Adjust R66 for Level (b–a) = 714.3 mV \pm 2 mV
5. Adjust PAL Multiburst
 - Multiburst signal
 - VM700A to Measure mode —Multiburst, line 265
 - Adjust filters C6, L7, and R71 so that the first five packets (from left) are flat within ± 0.14 dB, and sixth packet is ± 0.18 dB
6. Adjust PAL Chrominance-to-Luminance Gain and Delay
 - Matrix signal
 - Adjust filters C6 and L7 to get: Gain = 100% \pm 1.5% and Delay ≤ 5 ns
7. Adjust PAL 2T Pulse K-Factor
 - Matrix signal
 - VM700A to Measure mode —K_Factor
 - Adjust L7, C6, and R71 so that K-2T is $\leq 0.4\%$
8. Adjust PAL SCH Phase
 - Matrix signal
 - VM700A to Measure mode —SCH_Phase
 - Check that SCH Phase is $0^\circ \pm 4^\circ$
 - Adjust L7 only if SCH Phase is not within specification
9. Repeat steps 5–8 until no readjustments are necessary.

NOTE. The following NTSC adjustments are interactive with the PAL adjustments. Make the NTSC adjustments only if they are out of specification.

10. Adjust NTSC Multiburst

- Multiburst signal
- VM700A to Measure mode —MultiBurst
- Check that all packets have a variance within ± 0.14 dB
- Adjust L7, C6, and R71 if specification is not met

11. Adjust NTSC Chrominance-to-Luminance Gain and Delay

- NTC7 Composite signal
- VM700A to Measure mode —ChromLum_GainDelay, line 25
- Check that Gain is $100 \pm 1.5\%$, and Delay is ≤ 10 ns
- Adjust L7 and C6 if the specifications are not met

12. Adjust NTSC SCH Phase

- NTC7 Composite signal
- VM700A to Measure mode —SCH_Phase
- Check that SCH Phase is $0^\circ \pm 4^\circ$
- Adjust L7 if specification is not met

13. If any adjustments were made in steps 10 – 12 then repeat those steps until no adjustments are necessary.

14. If any adjustments were made in step 13, then repeat steps 5 – 13 until no adjustments are necessary.

15. Adjust Audio Tone Level

- Click — off; Calibration menu, 0 dBu
- Adjust Tone Level, R53, for 0 dBu ± 0.1 dBu
- Change Calibration menu to -10 dBu
- Adjust to -10 dBu ± 0.1 dBu with the ◀ and ▶ keys
- Change Calibration menu to 4 dBu
- Adjust to 4 dBu ± 0.1 dBu with the ◀ and ▶ keys
- Change Calibration menu to 8 dBu
- Adjust to 8 dBu ± 0.1 dBu with the ◀ and ▶ keys

Adjustment Procedures

Remove the TSG 95 back cover before proceeding; see the instructions on page 5–12. Power the instrument with the AC adapter while making adjustments.

1. Adjust LCD Contrast

- a. Press the **Lock Out** button, to make sure that the LCD backlight is on.
- b. ADJUST — LCD Contrast, R1, counterclockwise until the unused LCD segment rectangles appear, then adjust R1 clockwise until they just disappear. Stop adjusting R1 before the intensity of the displayed LCD characters is affected.

2. Adjust Subcarrier Frequency

- a. Connect the TSG 95 Video Output to the PAL/NTSC test signal generator genlock input with a 75 Ω coaxial cable. Terminate the genlock input in 75 Ω , if necessary.
- b. Connect the PAL/NTSC test signal generator subcarrier output to the frequency counter A input, using a 75 Ω coaxial cable.
- c. Connect a reference, such as WWV, to the B input of the frequency counter.
- d. Set the frequency counter for a ratio of A/B, and set the AVG to 106.
- e. ONLY IF NECESSARY, remove the tape cover from the adjustment hole on the oscillator, Y1.
- f. ADJUST — the subcarrier frequency to 3.579545 MHz \pm 0.5 Hz (NTSC) or 4.43361875 MHz \pm 0.5 Hz (PAL).

NOTE. *The subcarrier frequency specification is \pm 10 Hz, but it is recommended that this adjustment be made as close to the “exact” frequency as possible to maximize performance.*

The crystal may drift after adjustment. Leave the Pathfinder powered up for 20 minutes after adjustment, then check the frequency a second time to verify that it has remained within spec.

- g. Reinstall the tape cover on the oscillator.

3. Adjust PAL DC Gain and Blanking Level

- a. Connect the TSG 95 Video output to the VM700A Channel A Input and terminate the loophrough in 75 Ω .
- b. Select the PAL Matrix signal from the Pathfinder (press **R**).

- c. View Ch. A line 21 on the VM700A.
- d. Press the following VM700A keys: **Measure**, **<Level Meter>**, **Menu**, **<Measure Position>**, and **<Pos. (a)>**.
- e. Use the VM700A front-panel knob to position the “a” cursor on the color back porch. See Figure 4–10.

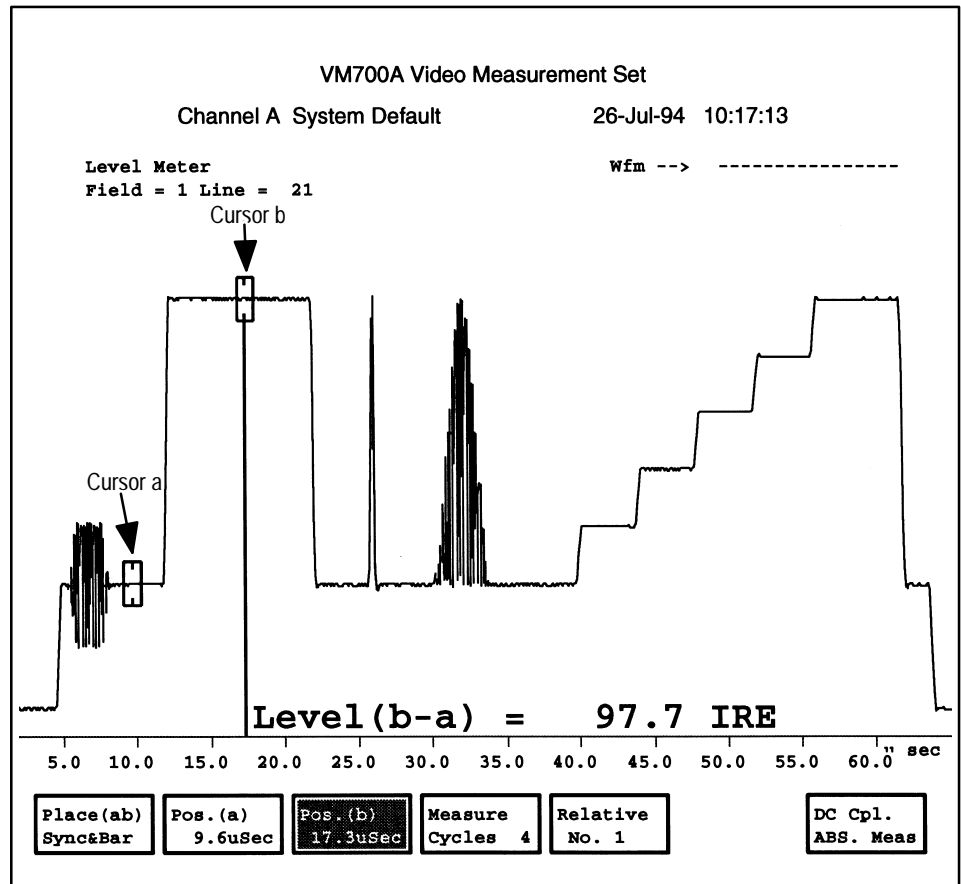

Figure 4–10: VM700A Level Meter Screen

- f. Press the **<Pos. (b)>** key, and position the “b” cursor on top of the white bar. See Figure 4–10.
- g. Press the **Average** key.
- h. **ADJUST** — R52 for Level (b-a) = 700 mV ± 2 mV.
- i. Press the **<DC Cpl. ABS. Meas>** and **<Pos. (b)>** keys.
- j. Position the cursor on the back porch.

- PAL Video Filter Adjustments**
- k.** Press the **Average** key twice.
 - l.** ADJUST — R7 for Level (b) = 0 mV ± 20 mV.
 - m.** Repeat steps **d.** through **l.**
- 4.** Adjust NTSC Gain
- a.** Change the TSG 95 video standard to NTSC and select the NTC7 Composite signal (Press **K**).
 - b.** Press the following VM700A keys: **Measure**, **<Video Standard>**, **<Level Meter>**, **Menu**, **<Measure Position>**, and **Select Line**.
 - c.** Select line 25 with the VM700A front-panel knob, then press **Select Line**.
 - d.** Position the cursors as in Figure 4–10, then press the **Average** key.
 - e.** ADJUST — R66 for Level (b–a) = 714.3 mV ± 2 mV (100 IRE ± 0.25 IRE).
- 5.** Adjust PAL Multiburst
- a.** Change the TSG 95 video standard to PAL and select the Multiburst signal (Press **N**).
 - b.** Press the following VM700A keys: **Measure**, **<Video Standard>**, **<MultiBurst>**, and **Select Line**.
 - c.** Select line 25 with the VM700A front-panel knob, then press **Select Line**.
 - d.** Press the **Move-Expand** key. Expand the signal by rotating the knob clockwise until the VM700A “clicks.” Press the **Move-Expand** button again.
 - e.** Rotate the knob counterclockwise to bring the Multiburst packets to center screen.
 - f.** Press the **Average** key.
 - g.** ADJUST — L7, R71, and C6 so that the first five packets (from the left) have a variance within ± 0.14 dB, and the last packet is within ± 0.18 dB.
- 6.** Adjust PAL Chrominance-to-Luminance Gain and Delay
- a.** Select the Matrix signal from the TSG 95 (press **R**).
 - b.** Press the following VM700A keys: **Measure**, **<ChromLum GainDelay>**, **Average**, and **Select Line**.

- c. Select line 270 with the VM700A front-panel knob, then press **Select Line**.
- d. ADJUST — L7 and C6 to adjust the gain and delay within the following specifications:
Gain = $100\% \pm 1.5\%$
Delay = ± 5 ns

NOTE. These two adjustments are interactive, but L7 mostly affects the delay and C7 the gain.

7. Adjust 2T Pulse K-Factor

- a. Select the Matrix signal from the TSG 95 (press **R**).
- b. Press the following VM700A keys: **Measure**, **<K_Factor>**, **Menu**, **<Graticule>**, and **<Graticule Gain>**.
- c. Use the VM700A front-panel knob to set the Graticule Gain to 0.5%
- d. Press the **Move-Expand** key. Expand the signal by rotating the knob clockwise until the VM700A “clicks.” Press the **Move-Expand** button again.
- e. Rotate the knob counterclockwise to bring the bottom of the signal to center screen.
- f. Press the **Average** key.
- g. ADJUST — L7, R71, and C6 so that K-2T is $\leq 0.4\%$ and that no part of the signal touches the graticule envelope.

8. Adjust SCH Phase

- a. Select the Matrix signal from the TSG 95 (press **R**).
- b. Press the following VM700A keys: **Measure**, **<SCH_Phase>**, and **Average**.
- c. CHECK — that the SCH Phase is $0^\circ \pm 4^\circ$.
ADJUST — L7 ONLY if SCH Phase is not within specification.

9. Recheck steps 5 through 8 until no readjustments are necessary.

NTSC Video Filter Adjustments

The following three adjustments are typically within spec if the entire adjustment procedure has been followed. The adjustments that can be made in the next three steps are interactive with the PAL adjustments, and therefore should only be readjusted if they are out of specification.

10. Adjust NTSC Multiburst

- a. Change the TSG 95 video standard to NTSC and select the Multiburst signal (Press **J**).
- b. Press the following VM700A keys: **Measure**, **<Video Standard>**, and **<MultiBurst>**.
- c. Press the **Move-Expand** key. Expand the signal by rotating the knob clockwise until the VM700A “clicks.” Press the **Move-Expand** button again.
- d. Rotate the knob counterclockwise to bring the Multiburst packets to center screen.
- e. Press the **Average** key.
- f. CHECK — that all packets have a variance within ± 0.14 dB.
ADJUST — L7, C6, and R71 only if the specification is not met.

11. Adjust NTSC Chrominance-to-Luminance Gain and Delay

- a. Select the NTC7 Composite signal from the TSG 95 (press **K**).
- b. Press the following VM700A keys: **Measure**, **<ChromLum GainDelay>**, **Average**, and **Select Line**.
- c. Select line 25.
- d. CHECK — that Gain is $100 \pm 1.5\%$, and Delay is ≤ 10 ns.
ADJUST — L7 and C6 only if the specifications are not met.

12. Adjust NTSC SCH Phase

- a. Select the NTSC Composite signal from the TSG 95 (press **K**).
- b. Press the following VM700A keys: **Measure**, **<SCH_Phase>**, and **Average**.
- c. CHECK — that the SCH Phase is $0^\circ \pm 4^\circ$.
ADJUST — L7 only if SCH Phase is not within specification.

13. If any adjustments were made in steps 10 through 12 then repeat those three steps until no adjustment is necessary.

14. If any readjustments were made in step 13 then repeat steps 5 through 14 until no readjustments are necessary.

Audio Adjustments**15. Adjust Audio Tone Level**

- a. Connect the TSG 95 Audio outputs to the VM700A Option 40 audio inputs.
- b. Enter the TSG 95 Calibration menu with the following steps:
 - Press and hold the **Lock Out** key and then press the **ON** key.
 - Press the **▲** key three times to get to the Calibration menu.
 - Press **Enter**.
- c. If the TSG 95 indicates that the Calibration menu is locked, press either the **◀** or **▶** key to unlock the menu.
- d. Press the **▼** key four times to reach the TONE MIN LEVL item.
- e. At the VM700A, enter Audio Measurement mode and press the **<Audio Analyzer>** key.
- f. ADJUST — R53 so that Level = 0 dBu \pm 0.05 dBu (both channels).
- g. Press the TSG 95 **▼** key to reach the NAME TONE LV1 item.
- h. If desired, use the **◀** and **▶** keys to rename Tone Level 1. Level 1 is set to -10 dBu during factory calibration; the possible selections are -10 to -3 dBu and 0 to +10 dBu.

NOTE. Step **h** changes only the level name that will appear in the TSG 95 Tone menu. The actual amplitude must be adjusted (in step **j**) to match the name.

- i. Press the **▼** key again to move to the CAL TONE LV1 selection.
- j. ADJUST — Tone Level 1 with the **◀** and **▶** keys until the VM700A measures the tone level within \pm 0.1 dBu of the name set in step **h**. If you did not change the name from the factory setting, adjust Tone Level 1 to -10 dBu \pm 0.1 dBu.
- k. Continue down the Calibration menu with the **▼** key and repeat steps **h** through **j** to NAME and CAL Tone Levels 2, 3, and 4 as necessary. The factory setting for Tone Level 2 is 0 dBu; for Tone Level 3, +4 dBu; and for Tone Level 4, +8 dBu.
- l. Use the **▼** key to move to FACTORY RESET, and press **Enter**.

This completes the Adjustment Procedure.

Maintenance

This section contains information regarding maintenance of the TSG 95. It also contains tips that may help in troubleshooting and repair in the unlikely event that the instrument should fail to operate correctly.

Battery Hints

For optimal battery life and capacity, use the rechargeable NiCad battery pack (Tektronix p/n 119-4488-00) in full charge/discharge cycles. In other words, fully discharge the battery pack before recharging, and then charge the battery pack until fully charged, approximately 16 hours. A new battery pack will take a few charge/discharge cycles to reach full capacity.



WARNING. *Install or replace batteries only with the instrument switched OFF and the AC adapter disconnected.*

Replace the batteries only with standard AA batteries (1.2–1.5 V, nominal), or with a Tektronix rechargeable battery pack (p/n 119-4488-00).

Setting the Auto Power Down (page 5–5) and Battery Type (page 5–6) functions in the Utility menu also have an impact on battery life. The battery types are disposable (Alkaline) or rechargeable (NiCad). Setting the battery type changes the voltage thresholds for both the BATTERY LOW display message and low-battery shutdown.

The BATTERY LOW Message

The warning “BATTERY LOW” will appear on the second line of the TSG 95 display when the battery voltage drops below a predetermined level. The level depends on the Battery Type set in the Diagnostic menu (see page 5–6). The TSG will operate for approximately ten minutes after the message first appears. For best results, replace or recharge the batteries when you first see this warning.

Low Battery Shutdown

To prevent erratic operation at very low power levels, the TSG 95 will shut itself down if the battery voltage drops below a second, lower threshold that also depends on the Battery Type setting.

Low-battery shutdown can happen with little or no warning if, for instance, the instrument has been left on by mistake with Auto Power Down disabled. In such cases, the TSG 95 is likely to shut itself down almost immediately the next time you switch it on. If this happens:

- Install fresh batteries or operate the instrument with the AC adapter, and

- Confirm that the Utility menu Battery Type setting is appropriate.

The shutdown threshold is higher for rechargeable batteries than for disposable. Therefore, you will receive a false BATTERY LOW message and may experience premature shutdown if using Alkaline batteries when the Battery Type is set to “rechargeable.” On the other hand, NiCad batteries may be damaged—they can lose their “rechargeability”—if they are discharged to the TSG 95 threshold for disposable batteries. Be sure to select the correct Battery Type.

Preventive Maintenance

Under average conditions, the TSG 95 should have preventive maintenance performed about every 2000 hours. This is approximately one year of operation. Preventive maintenance includes cleaning, visual inspection, a performance verification and, if necessary, adjustment. See the previous section for performance verification and adjustment procedures.

Cleaning

Clean the instrument often enough to prevent dust and dirt from accumulating in or on it. Dirt can provide high-resistance electrical leakage paths between conductors or components in a humid environment.



CAUTION. *The TSG 95 case is made of molded plastic. Do not allow water to get inside of any enclosed assembly or component. Do not clean any plastic materials with organic cleaning solvents, such as benzene, toluene, xylene, acetone, or similar compounds, because they may damage the plastic.*

Static-Sensitive Components

The TSG 95 contains electrical components that are susceptible to damage from static discharge. Static voltages of 1 kV to 30 kV are common in unprotected environments.



CAUTION. *Static discharge can damage any semiconductor component in this instrument.*

Observe the following precautions to avoid static damage:16

- Minimize handling of static-sensitive components.
- Transport and store static-sensitive components or assemblies in their original containers, on a metal rail, or on conductive foam. Label any package that contains static-sensitive assemblies or components.

- Discharge the static voltage from your body by wearing a wrist strap while handling these components. Servicing static-sensitive assemblies or components should only be performed at a static-free workstation by qualified personnel.
- Nothing capable of generating or holding a static charge should be allowed on the workstation surface.
- Keep the component leads shorted together whenever possible.
- Pick up components by the body, never by the leads.
- Do not slide the components over any surface.
- Avoid handling components in areas that have a floor or work surface covering capable of generating a static charge.
- Use a soldering iron that is connected to earth ground.
- Use only special antistatic, suction-type or wick-type desoldering tools.

Troubleshooting Aids

The following is miscellaneous information about schematics, circuit board illustrations, component numbering, and assembly numbering.

NOTE. *No repair should be attempted during the warranty period. Instead, contact your nearest Tektronix representative or field office.*

Diagnostic Utilities

The TSG 95 has a number of built-in diagnostic utilities, accessed through the Utility/Diagnostic submenu. A discussion of the Utility menu begins on page 5-4 of this manual; the Diagnostic submenu is explained on pages 5-9 through 5-11.

Foldout Pages

The foldout pages at the back of the manual contain block and schematic diagrams and circuit board illustrations.

Diagrams

The circuit number and electrical value of each component is shown on the schematic diagrams. The first page in the Diagrams section explains the schematic symbols and notations found on the diagrams. The Replaceable Electrical Parts list gives a complete description of each component. Circuit boards and assemblies are shown with a heavy border, for identification. If the border does not completely encircle the schematic then that schematic only portrays part of the circuitry on that board or assembly. The name and assembly number of the cir-

cuit board are shown along the border as well as the serial number range that the schematic represents.

NOTE. Check the *Change Information* section at the rear of the manual for inserts describing corrections and modifications to the instrument and manual.

Circuit Board Illustrations

Electrical components, connectors, and test points are identified on circuit board illustrations located on the inside fold of the corresponding circuit diagram or the back of a preceding diagram.

Numbering

The circuit board assemblies are assigned assembly numbers starting with A1.

Circuit boards have been assigned an assembly number so that they may be ordered from Tektronix, Inc. They are as follows:

- A1 Main Board Assembly
- A2 Keypad Board Assembly
- A3 LCD Board Assembly

The part numbers for ordering these boards are listed first in Section 6, the Replaceable Electrical Parts list (EPL).

The EPL is arranged in assembly-by-assembly order, as designated in ANSI Standard Y32.16-1975. Each component is assigned a circuit number according to its location within a circuit, which is shown in the parts list by combining the assembly number and the circuit number.

EXAMPLE: R123 on assembly A2 would be listed in the EPL as A2R123.

In the EPL, assemblies are listed first, followed by circuit board-mounted parts in alphanumeric order. Parts mounted on the chassis are listed at the end of the EPL.

NOTE. The complete part number shown in the parts list should be used when ordering replacement parts.

The Utility Menu

To enter the Utility menu, hold the **Lock Out** button down while pressing the ON button. To exit the Diagnostic menu and resume normal operation, press any

of the rectangular buttons at the top of the keypad, or scroll to the **EXIT MENU** item and press **Enter**.

“Top Level” Utility Menu Items

The Utility menu items are listed below. Use the up (▲) and down (▼) arrow keys to scroll up and down the list. Note that there are two submenus: Calibration (**CALIB**) and Diagnostic (**DIAGN**). These submenus are discussed in separate sections, below.

```
1 ⚡ SELECT STNDRD
  PAL          ◀▶
```

1. Standard/Signal Set select; use the ◀ or ▶ key to select the desired set of signals. The choices are: PAL, NTSC, NTSC JAPAN (which includes NTSC signals with 0% Setup), and USER SIG SET.

```
2 ⚡ SEL USER SIGS
  Press Enter
```

2. Select User Signals is used to configure the User signal set. See the User manual for complete instructions and a list of the available signals.

```
3 ⚡ VITS SIGNALS
  VITS SIGNALS ◀▶
```

3. VITS (Vertical Interval Test Signal) insertion; use the left (◀) or right (▶) arrow key to toggle between VITS SIGNALS and NO VITS SIGS. This utility applies to the Flat Field and Matrix signals in the PAL, NTSC, and NTSC JAPAN signal sets *only*. It is disabled when the User signal set is active (the User signal set may be configured to include both VITS and NO VITS signal—please see the User Manual for more information).

```
4 ⚡ AUTO POWR DOWN
  disable    ◀▶
```

4. Auto power down; use the left (◀) or right (▶) arrow key to toggle between enabled and disabled.

The Auto Power Down function shuts the TSG 95 off to conserve battery charge when there has been no key press for approximately 10 minutes. The Auto Power Down symbol (a rotating line) appears in the upper-right corner of the LCD display when the function is enabled.

5 ◆ BATTERY TYPE
disposable ◀▶

5. Battery type; use the ◀ or ▶ key to toggle between disposable (Alkaline AA cells) or rechargeable (NiCad cells or the optional battery pack). For best results when operating the TSG 95 under battery power, this setting must match the installed type of battery.

6 ◆ CALIB SUBMENU
Press Enter

6. Press Enter to “drop into” the Calibration submenu. This submenu includes items for specifying the User tone frequencies, choosing and calibrating audio tone amplitudes, and performing a “Factory Reset.” Please see “The Calibration Submenu,” which begins immediately after this discussion of top level items.

7 ◆ DIAGN SUBMENU
Press Enter

7. Press Enter to “drop into” the Diagnostic submenu. This submenu includes items that are used during instrument manufacture and service. Please see “The Diagnostic Submenu,” beginning on page 5–9, for more information.

◆ EXIT MENU
Press Enter

8. To exit the Utility menu, scroll to this item and press Enter. The instrument will resume normal operation (notice that changes made through the Utility menu items and submenus will take effect immediately).

The Calibration Submenu

Items 2 through 4 are used to specify the three User tone frequencies. Items 5 through 13 are used for calibrating the various preset tone levels; please see the *Performance Verification and Adjustment* section of this manual for instructions.

1 ◆ CALIBRATION
UNLOCKED ◀▶

1. Toggle calibration from UNLOCKED to LOCKED with the ◀ or ▶ key. When calibration is locked, only this and the EXIT SUBMENU menu items will be visible; when unlocked, all items in the Calibration submenu will be available.

```

2 ◆ SET USR1 TONE
  10395 Hz ◀▶

```

2. Set the “USER1” tone frequency with either the ◀ and ▶ keys, or through direct input from the keypad. The keypad is automatically shifted when in this menu item, and only the number keys, 0–9, are active. The selection range is 50 through 20000 Hz; the factory default is 10395 Hz.

```

3 ◆ SET USR2 TONE
  7867 Hz ◀▶

```

3. Set the “USER2” tone frequency, again with either the ◀ and ▶ keys, or through direct input from the keypad. Factory default is 7867 Hz.

```

4 ◆ SET USR3 TONE
  - Hz ◀▶

```

4. Set the “USER3” tone frequency, again with either the ◀ and ▶ keys, or through direct input from the keypad. Factory default is no selection, as illustrated.

```

5 ◆ TONE MIN LEVL
  ADJUST POT

```

5. Used to set tone level DC offset. Please see the audio adjustment procedure, beginning on page 4–29 of this manual, for instructions.

```

6 ◆ NAME TONE LV1
  -10dBu ◀▶

```

6. Name tone level 1: Combined with the next menu item, this lets you change tone level 1 from the factory default value of –10 dBu to any integer value from –10 to –3 dBu or 0 to +10 dBu. Note that this item changes only the *name* of the level as it appears in the Tone menu; the actual amplitude of tone level 1 is adjusted through the next menu item.



CAUTION. Do not change a tone level name (menu items 6, 8, A, and C) without recalibrating the amplitude through the following menu item. Please see the next Caution statement before proceeding.

```

7 ◆ CAL TONE LV1
  -10dB: Low 17 ◀▶

```

7. Calibrate tone level 1: Use this item to readjust the tone amplitude to accurately reflect the level name chosen in the previous menu item. Use an ap-

appropriate instrument (such as the Tektronix VM700A, option 40/41) to measure the tone level, and adjust it to within 0.25 dBu of its “name” with the ◀ and ▶ keys. The range of adjustment is Low 00 to Hgh (high) 99.



CAUTION. Changing the “CAL TONE LV#” settings (menu items 7, 9, B, and D) will affect the audio tone amplitude and can give inaccurate results unless proper equipment and procedures are used. The audio adjustment procedure begins on page 4–29 (in the Performance Verification and Adjustment section) of this manual. A FACTORY RESET will NOT restore these settings to their original values. It is a good idea, then, to record the original settings before changing a tone level from its as-manufactured value.

To ensure your ability to restore the original factory tone calibration settings in the case of inadvertent changes, please record the following information:

TSG 95 serial number:

Original –10 dB setting: _____ (e.g., Low 17)

Also take the time to record the settings for the remaining tone levels in menu (list) items 9, B (11), and D (13).

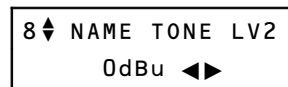

8. Name tone level 2: use—with the next menu item—to change tone level 2 from the factory default value of 0 dBu to a value of your choice. See menu item 6, above.

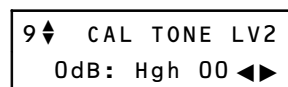

9. Calibrate tone level 2: please see menu item 7, above.

Original 0 dB setting: _____ (e.g., High 00)

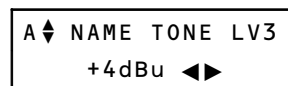

10. Name tone level 3: use—with the next menu item—to change tone level 3 from the factory default value of +4 dBu to a value of your choice. See menu item 6, above.

```

B ◆ CAL TONE LV3
+4dB: Hgh 25 ◀▶

```

11. Calibrate tone level 3: please see menu item 7, above.

Original +4 dB setting: _____ (e.g., Hgh 25)

```

C ◆ NAME TONE LV4
+8dBu ◀▶

```

12. Name tone level 4: combined with the next menu item, this permits qualified users with the appropriate equipment to change tone level 4 from the factory default value of +8 dBu to a value of their choice. See menu item 6, above.

```

D ◆ CAL TONE LV4
+8dB: Hgh 65 ◀▶

```

13. Calibrate tone level 4: please see menu item 7, above.

Original +8 dB setting: _____ (e.g., Hgh 65)

```

E ◆ VIDEO CAL SIG
NORMAL SIG ◀▶

```

14. This item selects special output signals used during manufacture.

```

F ◆ FACTORY RESET

```

15. Press Enter to restore most of the original “as manufactured” instrument settings. **WARNING:** All user selections, ID Messages, and Presets will be lost.

```

◆ EXIT SUBMENU
Press Enter

```

16. To exit the Calibration submenu, scroll to this item and press **Enter**. The instrument will return to the “CALIB SUBMENU” item in the Utility menu. To exit the entire Utility menu from this point, and resume normal instrument operation, press any rectangular key.

The Diagnostic Submenu

```

1 ◆ LCD Diag ◀▶
Press Enter

```

1. LCD Diagnostic. Despite what the second display line may say, pressing **Enter** will get you nowhere in this diagnostic. Instead, press the ◀ key to

turn all segments on, and press the ► key to turn all segments off. Exit this diagnostic with the ▲ and ▼ keys as usual.

```

2◆ SHOW OSD CHAR
  Press Enter
    
```

2. This diagnostic confirms the ability of the TSG 95 to create an on-screen character display (OSD). First connect the instrument output to a video monitor, then press **Enter**. The OSD characters will be superimposed on the video signal. As usual, exit this diagnostic by pressing the ▲ or ▼ key.

```

3◆ KEYPAD TEST
  Press Enter
    
```

3. To test the action of any or all of the keys, press **Enter**, then press any key that you wish to test. If the key is working properly, its unshifted “name” will be written to the second line of the display as long as you hold the key down. For instance, the display should look something like this when you press the **Tone On/Off** key down:

```

  Press any Key
    Tone On/Off
    
```

“Enter to Quit” will appear when you release the key. When you have checked all the keys of interest, press **Enter**. to quit this diagnostic.

```

4◆ PROG ROM CSUM
  Press Enter
    
```

4. Press **Enter**. The instrument will take a few seconds to calculate the Program ROM Checksum and write it to the lower display line. The correct value of the sum will depend on the version of the software in the instrument. Exit this diagnostic by pressing the ▲ or ▼ key, as usual.

```

5◆ SIGL ROM CSUM
  Press Enter
    
```

5. Press **Enter**. The instrument will take several seconds to calculate the Signal ROM Checksum and write it to the lower display line. The correct value of

the sum will depend on the version of the signal set in the instrument. Exit this diagnostic by pressing the ▲ or ▼ key, as usual.

```
6◆ SIGL RAM TEST
Press Enter
```

6. This test automatically checks the integrity of the Signal RAM, which is used to hold portions of the signal data that must be accessed at high speed. “All Tests Passed” will appear on the second display line on successful completion of the tests. Exit this diagnostic by pressing the ▲ or ▼ key, as usual.

```
7◆ ASIC REG TEST
Press Enter
```

7. This test automatically checks the integrity of communication between the μ P and the ASIC. “All Tests Passed” will appear on the second display line on successful completion of the tests. Exit this diagnostic by pressing the ▲ or ▼ key, as usual.

```
◆ EXIT SUBMENU
Press Enter
```

8. To exit the Diagnostic submenu, scroll to this item and press **Enter**. The instrument will return to the “DIAGN SUBMENU” item in the Utility menu. To exit the entire Utility menu from this point, and resume normal instrument operation, press any rectangular key.

Corrective Maintenance

Corrective maintenance deals with obtaining replacement parts, torque specifications, and component replacement.

Obtaining Replacement Parts

Replacement parts are available from or through the nearest Tektronix field office or representative.

When ordering parts be sure to include the following information in your order:

10. Instrument type (and option numbers, if any).
11. Instrument serial number.
12. Description of the part, as it appears in the electrical or mechanical parts list.
13. The Tektronix part number.

If a part that has been ordered is replaced with a new or improved part, the local Tektronix field office or representative will contact you concerning any change in the part number. After repair, the circuits may need readjustment.

Torque Specifications

Only #4 screws are used in the TSG 95 to secure the case halves together. **DO NOT USE MORE THAN 3 INCH POUNDS (0.34 N·m) OF TORQUE ON THESE SCREWS.**

Replacing Assemblies



WARNING. *Disconnect the AC adapter and batteries before replacing any components.*

Back Cover Removal and Replacement

Follow this procedure to remove and replace the back cover of the TSG 95:

1. Remove the four screws securing the back cover to the front cover.
2. Gently separate the back cover about 1 inch from the TSG 95, taking care to not pull the rear panel (connector panel) away with it.
3. Disconnect the battery cable from J10. Make sure to pull on the connector housing to do this, not the wires. The back cover is now free and may be moved away from the instrument.
4. Replacement is the reverse of removal.

Connector Panel Removal and Replacement

Follow this procedure to remove and replace the connector (“rear”) panel of the instrument:

1. With the back cover removed, disconnect the VIDEO and both AUDIO connector cables from J7, J8, and J9. Again, pull on the connector housing, not on the wires.
2. Slide the connector assembly up away from the front panel.
3. Replacement is the reverse of removal.

Main Board/LCD Removal and Replacement

Follow this procedure to remove and replace the TSG 95 Main board and LCD:

1. After removing the rear panel, use a pair of needle-nose pliers to gently pull the J2 housing up away from the instrument. Pull straight up, lifting the Main board at the same time. Do NOT bend the connector housing.

2. When J2 pulls free, lift the Main board and the LCD display away from the case.
3. To separate the Main board and LCD display module, disconnect the LCD display cable from J6, and gently pull the two assemblies apart at J1. The rubber board spacers should remain attached to the LCD display.
4. Replacement is the reverse of removal.

Keypad Removal

Follow this procedure to remove the TSG 95 keypad:

1. Once the Main board is out of the way, lift the plastic spacer board out of the instrument. This is held in place only by a friction fit.
2. Lift the Keypad board out of the instrument. This too is held in place by a friction fit.
3. Peel the rubber keypad out of the front panel.

Keypad Replacement

Follow this procedure to replace the TSG 95 keypad:

1. Place the Keypad board with the pins of the connector towards the workbench.
2. Place the rubber keypad on top of the Keypad board, positioning it so that the ON button is in the corner closest the connector.
3. Adjust the rubber keypad so that the fingers on its back side fit through the corresponding holes in the Keypad board.
4. Holding the keypad and Keypad board with the buttons up, slide the front case onto them, aligning the rubber buttons with the holes for them in the front case as you do so. The Keypad board is a friction fit in the front case half, so you must apply some slight pressure to fully seat the assemblies into the case.
5. Place the assembled front case and keypad face down on the workbench and press the plastic spacer board into place. Align the cutout in the spacer board with the connector. The plastic fingers will be facing up.

Replaceable Electrical Parts

This section contains a list of the components that are replaceable for the TSG 95. Use this list to identify and order replacement parts. There is a separate Replaceable Electrical Parts list for each instrument.

Parts Ordering Information

Replacement parts are available from or through your local Tektronix, Inc., Field Office or representative.

Changes to Tektronix instruments are sometimes made to accommodate improved components as they become available and to give you the benefit of the latest circuit improvements. Therefore, when ordering parts, it is important to include the following information in your order.

- Part number
- Instrument type or model number
- Instrument serial number
- Instrument modification number, if applicable

If a part you have ordered has been replaced with a new or improved part, your local Tektronix, Inc., Field Office or representative will contact you concerning any change in part number.

Change information, if any, is located at the rear of this manual.

Using the Replaceable Electrical Parts List

The tabular information in the Replaceable Electrical Parts list is arranged for quick retrieval. Understanding the structure and features of the list will help you find all of the information you need for ordering replaceable parts.

Cross Index–Mfr. Code Number to Manufacturer

The Mfg. Code Number to Manufacturer Cross Index for the electrical parts list is located immediately after this page. The cross index provides codes, names, and addresses of manufacturers of components listed in the electrical parts list.

Abbreviations

Abbreviations conform to American National Standards Institute (ANSI) standard Y1.1.

List of Assemblies

A list of assemblies can be found at the beginning of the electrical parts list. The assemblies are listed in numerical order. When the complete component number of a part is known, this list will identify the assembly in which the part is located.

Column Descriptions

Component No. (Column 1)

The component circuit number appears on the diagrams and circuit board illustrations, located in the diagrams section. Assembly numbers are also marked on each diagram and circuit board illustration, in the Diagram section and on the mechanical exploded views, in the mechanical parts list. The component number is obtained by adding the assembly number prefix to the circuit number.

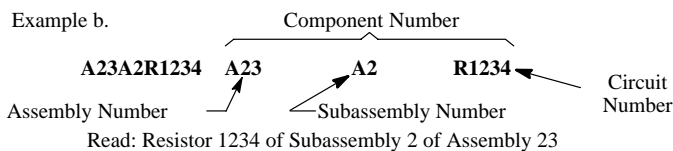
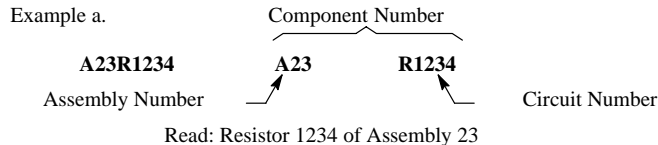

The electrical parts list is arranged by assemblies in numerical sequence (A1, with its subassemblies and parts, precedes A2, with its subassemblies and parts).

Mechanical subparts to the circuit boards are listed in the electrical parts list. These mechanical subparts are listed with their associated electrical part (for example, fuse holder follows fuse).

Chassis-mounted parts and cable assemblies have no assembly number prefix and are located at the end of the electrical parts list.

Tektronix Part No. (Column 2)

Indicates part number to be used when ordering replacement part from Tektronix.

Serial/Assembly No. (Column 3 and 4)

Column three (3) indicates the serial or assembly number at which the part was first used. Column four (4) indicates the serial or assembly number at which the part was removed. No serial or assembly number entered indicates part is good for all serial numbers.

Name and Description (Column 5)

An item name is separated from the description by a colon (:). Because of space limitations, an item name may sometimes appear as incomplete. Use the U.S. Federal Catalog handbook H6-1 for further item name identification.

The mechanical subparts are shown as *ATTACHED PARTS* / *END ATTACHED PARTS* or *MOUNTING PARTS* / *END MOUNTING PARTS* in column five (5).

Mfr. Code (Column 6)

Indicates the code number of the actual manufacturer of the part. (Code to name and address cross reference can be found immediately after this page.)

Mfr. Part No. (Column 7)

Indicates actual manufacturer's part number.

Cross Index – Mfr. Code Number To Manufacturer

Mfr. Code.	Manufacturer	Address	City, State, Zip Code
TK1920	TOKIN AMERICA INC	155 NICHOLSON LANE	SAN JOSE CA 95134
TK2058	TDK CORPORATION OF AMERICA	1600 FEEHANVILLE DRIVE	MOUNT PROSPECT, IL 60056
TK2073	TOKYO AMERICA INC	565 W GULF ROAD	ARLINGTON HEIGHTS IL 60005
TK2469	UNITREK CORPORATION	3000 LEWIS & CLARK WAY SUITE #2	VANCOUVER WA 98601
TK2519	ALLIANCE SEMICONDUCTOR	1930 ZANKER ROAD	SAN JOSE CA 95112
0AGS1	MICRO LINEAR CORPORATION	2092 CONCOURSE DRIVE	SAN JOSE CA 95131
0JR03	ZMAN MAGNETICS INC	7633 S 180th	KENT WA 98032
0JR04	TOSHIBA AMERICA INC ELECTRONICS COMPONENTS DIV	9775 TOLEDO WAY	IRVINE CA 92718
0LXM2	LZR ELECTRONICS INC	8051 CESSNA AVENUE	GAITHERSBURG MD 20879
01295	TEXAS INSTRUMENTS INC SEMICONDUCTOR GROUP	13500 N CENTRAL EXPY PO BOX 655303	DALLAS TX 75262-5303
04222	AVX/KYOCERA	PO BOX 867	MYRTLE BEACH, SC 29577
04713	MOTOROLA INC SEMICONDUCTOR PRODUCTS SECTOR	5005 E MCDOWELL RD	PHOENIX AZ 85008-4229
1ES66	MAXIM INTEGRATED PRODUCTS INC	120 SAN GABRIEL DRIVE	SUNNYVALE CA 94086
13919	BURR-BROWN RESEARCH CORP	6730 S TUCSON BLVD P O BOX 11400	TUCSON AZ 85734
17856	SILICONIX INC	2201 LAURELWOOD RD	SANTA CLARA CA 95054-1516
18796	MURATA ELECTRONICS N AMERICA	1900 WEST COLLEGE AVE.	STATE COLLEGE, PA 16801-2723
22526	BERG ELECTRONICS INC (DUPONT)	857 OLD TRAIL RD	ETTERS PA 17319
27014	NATIONAL SEMICONDUCTOR CORP	2900 SEMICONDUCTOR DR	SANTA CLARA CA 95051-0606
31433	KEMET ELECTRONICS CORP NATIONAL SALES HEADQUARTERS	PO BOX 5928	GREENVILLE SC 29606
32997	BOURNS INC	TRIMPOT DIVISION 1200 COLUMBIA AVE	RIVERSIDE, CA 92507-2114
34335	ADVANCED MICRO DEVICES	901 THOMPSON PL PO BOX 3453	SUNNYVALE CA 94086-3413
4T165	NEC ELECTRONICS USA INC ELECTRON DIV	475 ELLIS ST PO BOX 7241	MOUNTAIN VIEW CA 94039
50139	ALLEN-BRADLEY COMPANY INC	ELECTRONIC COMPONENTS DIVISION 1414 ALLEN BRADLEY DRIVE	EL PASO, TX 79936
51406	MURATA ELECTRONICS NORTH AMERICA INC HEADQUARTERS AND GEORGIA OPERATIONS	2200 LAKE PARK DR	SMYRNA GA 30080
53387	3M COMPANY ELECTRONIC PRODUCTS DIV	3M AUSTIN CENTER	AUSTIN TX 78769-2963
55322	SAMTEC INC	810 PROGRESS BLVD PO BOX 1147	NEW ALBANY IN 47150-2257
55680	NICHICON /AMERICA/ CORP	927 E STATE PKY	SCHAUMBURG IL 60195-4526
56845	DALE ELECTRONICS INC	2300 RIVERSIDE BLVD PO BOX 74	NORFOLK NE 68701-2242
57668	ROHM CORPORATION	15375 BARRANCA PARKWAY SUITE B207	IRVINE CA 92718
60395	XICOR INC	851 BUCKEYE CT	MILPITAS CA 95035-7408
61271	FUJITSU MICROELECTRONICS INC	2985 KIFER RD	SANTA CLARA CA 95051-0802
61857	SAN-O INDUSTRIAL CORP	91-3 COLIN DRIVE	HOLBROOK NY 11741
62712	SEIKO INSTRUMENTS USA	2990 W LOMITA BLVD	TORRANCE CA 90505-5102
64155	LINEAR TECHNOLOGY CORP.	1630 MCCARTHY BOULEVARD	MILPITAS, CA 950357487
75915	LITTELFUSE INC	800 E NORTHWEST HWY	DES PLAINES, IL 60016-3049
80009	TEKTRONIX INC	14150 SW KARL BRAUN DR PO BOX 500	BEAVERTON, OR 97077-0001
82567	DYNAMICS CORP OF AMERICA REEVES-HOFFMAN DIV	400 W NORTH ST	CARLISLE PA 17013-2248
91637	DALE ELECTRONICS INC	2064 12TH AVE PO BOX 609	COLUMBUS NE 68601-3632

Replaceable Electrical Parts

Component Number	Tektronix Part Number	Serial / Assembly Number Effective	Discontinued	Name & Description	Mfr. Code	Mfr. Part Number
A1	671-3353-00	B010100	B010137	CIRCUIT BD ASSY:MAIN,TSG95	80009	671335300
A1	671-3353-01	B010138	B010667	CIRCUIT BD ASSY:MAIN,TSG95	80009	671335301
A1	671-3353-02	B010668	B023901	CIRCUIT BD ASSY:MAIN,TSG95	80009	671335302
A1	671-3353-03	B023902	B024124	CIRCUIT BD ASSY:MAIN,TSG95	80009	671335303
A1	671-3353-04	B024125	B026893	CIRCUIT BD ASSY:MAIN,TSG95	80009	671335304
A1	671-3353-05	B026894	B027113	CIRCUIT BD ASSY:MAIN,TSG95	80009	671335305
A1	671-3353-06	B027114	B027286	CIRCUIT BD ASSY:MAIN,TSG95	80009	671335306
A1	671-3353-07	B027287		CIRCUIT BD ASSY:MAIN,TSG95	80009	671335307
A2	671-2586-01			CIRCUIT BD ASSY:KEYBOARD	80009	671258601
A3	119-4506-00			DISPLAY,MODULE:LCD:16 CHARACTERS X 2 LINES,5 X 7 DOT MATRIX,TRANSFLECTIVE,YEL/GRN LED	62712	M16327JY
A1	671-3353-00	B010100	B010137	CIRCUIT BD ASSY:MAIN,TSG95	80009	671335300
A1	671-3353-01	B010138	B010667	CIRCUIT BD ASSY:MAIN,TSG95	80009	671335301
A1	671-3353-02	B010668	B023901	CIRCUIT BD ASSY:MAIN,TSG95	80009	671335302
A1	671-3353-03	B023902	B024124	CIRCUIT BD ASSY:MAIN,TSG95	80009	671335303
A1	671-3353-04	B024125		CIRCUIT BD ASSY:MAIN,TSG95	80009	671335304
A1C4	283-5114-00			CAP,FXD,CERAMIC:MLC;0.1UF,10%,50V,X7R,1206	04222	12065C104KAT(1A
A1C5	283-5267-00			CAP,FXD,CERAMIC:MLC;1UF,+80%-20%,25V,Y5V,1206	04222	12063G105ZAT1A
A1C6	281-0271-00			CAP,VAR,CER DI:7-50PF,50V	51406	TZBX4R500BA110T
A1C7	283-5201-00	671-3353-02		CAP,FXD,CERAMIC:MLC;33PF,5%,100V,NPO,1206,SMD,8MM T&R	04222	12061A330JAT1A
A1C8	283-5267-00			CAP,FXD,CERAMIC:MLC;1UF,+80%-20%,25V,Y5V,1206	04222	12063G105ZAT1A
A1C9	283-5267-00			CAP,FXD,CERAMIC:MLC;1UF,+80%-20%,25V,Y5V,1206	04222	12063G105ZAT1A
A1C10	283-5267-00			CAP,FXD,CERAMIC:MLC;1UF,+80%-20%,25V,Y5V,1206	04222	12063G105ZAT1A
A1C11	283-5267-00			CAP,FXD,CERAMIC:MLC;1UF,+80%-20%,25V,Y5V,1206	04222	12063G105ZAT1A
A1C12	283-5260-00			CAP,FXD,CERAMIC:MLC;10UF,+80%-20%,25V,Z5U,5.9X2.7MM,SM2210,SMD,T&R	TK1920	1E106ZY5U-C205M
A1C15	283-5267-00			CAP,FXD,CERAMIC:MLC;1UF,+80%-20%,25V,Y5V,1206	04222	12063G105ZAT1A
A1C16	283-5267-00			CAP,FXD,CERAMIC:MLC;1UF,+80%-20%,25V,Y5V,1206	04222	12063G105ZAT1A
A1C17	283-5267-00			CAP,FXD,CERAMIC:MLC;1UF,+80%-20%,25V,Y5V,1206	04222	12063G105ZAT1A
A1C18	283-5267-00			CAP,FXD,CERAMIC:MLC;1UF,+80%-20%,25V,Y5V,1206	04222	12063G105ZAT1A
A1C29	283-5267-00			CAP,FXD,CERAMIC:MLC;1UF,+80%-20%,25V,Y5V,1206	04222	12063G105ZAT1A
A1C31	283-5267-00			CAP,FXD,CERAMIC:MLC;1UF,+80%-20%,25V,Y5V,1206	04222	12063G105ZAT1A
A1C32	283-5267-00			CAP,FXD,CERAMIC:MLC;1UF,+80%-20%,25V,Y5V,1206	04222	12063G105ZAT1A
A1C34	283-5203-00		671-3353-01	CAP,FXD,CERAMIC:MLC;1000PF,10%,100V,X7R,1206	04222	12061C102KAT1A
A1C34	283-5185-00	671-3353-02		CAP,FXD,CERAMIC:MLC;1000PF,5%,50V,NPO,1206,SMD,8MM T&R	04222	12065A102JAT1A
A1C35	283-5108-00		671-3353-01	CAP,FXD,CERAMIC:MLC;68PF,5%,100V,NPO,1206	04222	12061A680JAT1A
A1C35	283-5196-00	671-3353-02		CAP,FXD,CERAMIC:MLC;47PF,5%,100V,NPO,1206,SMD,8MM T&R	04222	12061A470JAT1A
A1C37	283-5188-00	671-3353-00	671-3353-00	CAP,FXD,CERAMIC:MLC;100PF,5%,100V,NPO,1206	04222	12061A101JAT1A
A1C37	283-5238-00	671-3353-01		CAP,FXD,CERAMIC:MLC;150PF,5%,100V	80009	283-5238-00
A1C38	283-5188-00		671-3353-01	CAP,FXD,CERAMIC:MLC;100PF,5%,100V,NPO,1206	04222	12061A101JAT1A
A1C38	283-5108-00	671-3353-02		CAP,FXD,CERAMIC:MLC;68PF,5%,100V,NPO,1206,SMD,8MM T&R	04222	12061A680JAT1A
A1C39	283-5049-00	671-3353-00	671-3353-00	CAP,FXD,CERAMIC:MLC;180PF,5%,50V,NPO,1206	TK2058	C3216C0G1H181J-
A1C39	283-5238-00	671-3353-01		CAP,FXD,CERAMIC:MLC;150PF,5%,100V	80009	283-5238-00
A1C40	283-5197-00			CAP,FXD,CERAMIC:MLC;330PF,5%,100V,NPO,1206	04222	12061A331JAT1A
A1C41	283-5189-00			CAP,FXD,CERAMIC:MLC;220PF,5%,100V,NPO,1206	04222	12061A221JAT1A
A1C43	283-5026-00	671-3353-00	671-3353-00	CAP,FXD,CERAMIC:MLC;390PF,5%,50V,NPO,1206	TK2058	C3216C0G1H391J-
A1C43	283-5197-00	671-3353-01		CAP,FXD,CERAMIC:MLC;330PF,5%,100V	80009	283-5197-00
A1C44	283-5267-00			CAP,FXD,CERAMIC:MLC;1UF,+80%-20%,25V,Y5V,1206	04222	12063G105ZAT1A
A1C45	283-5267-00			CAP,FXD,CERAMIC:MLC;1UF,+80%-20%,25V,Y5V,1206	04222	12063G105ZAT1A
A1C53	290-5049-00			CAP,FXD,TANT:DRY;150UF,20%,10V,ESR=0.7 OHM(100KHZ,25C),0.287 X 0.169 (EXTENDED D CASE)	31433	T491X157M010AS

Replaceable Electrical Parts

Component Number	Tektronix Part Number	Serial / Assembly Number		Name & Description	Mfr. Code	Mfr. Part Number
		Effective	Discontinued			
A1C54	290-5049-00			CAP,FXD,TANT:DRY;150UF,20%,10V,ESR=0.7 OHM(100KHZ,25C),0.287 X 0.169 (EXTENDED D CASE)	31433	T491X157M010AS
A1C56	290-0943-02			CAP,FXD,ELCTLT:47UF,20%,25VTAPED & REELED	55680	UVV1E470MDA1TD
A1C57	283-5114-00			CAP,FXD,CERAMIC:MLC;0.1UF,10%,50V,X7R,1206	04222	12065C104KAT(1A
A1C58	283-5211-00			CAP,FXD,CERAMIC:MLC;4700PF,10%,50V,X7R	04222	12065C472KAT2A
A1C59	283-5187-00			CAP,FXD,CERAMIC:MLC;15PF,5%,100V,NPO,1206	04222	12061A150JAT1A
A1C63	283-5267-00			CAP,FXD,CERAMIC:MLC;1UF,+80%-20%,25V,Y5V,1206	04222	12063G105ZAT1A
A1C64	283-5114-00			CAP,FXD,CERAMIC:MLC;0.1UF,10%,50V,X7R,1206	04222	12065C104KAT(1A
A1C65	283-5017-00			CAP,FXD,CERAMIC:MLC;1PF,+/-0.25PF,50V,NPO,1206	TK2058	C3216C0G1H010C-
A1C66	283-5267-00			CAP,FXD,CERAMIC:MLC;1UF,+80%-20%,25V,Y5V,1206	04222	12063G105ZAT1A
A1C67	283-5267-00			CAP,FXD,CERAMIC:MLC;1UF,+80%-20%,25V,Y5V,1206	04222	12063G105ZAT1A
A1C68	283-5267-00			CAP,FXD,CERAMIC:MLC;1UF,+80%-20%,25V,Y5V,1206	04222	12063G105ZAT1A
A1C69	283-5267-00			CAP,FXD,CERAMIC:MLC;1UF,+80%-20%,25V,Y5V,1206	04222	12063G105ZAT1A
A1C70	283-5267-00			CAP,FXD,CERAMIC:MLC;1UF,+80%-20%,25V,Y5V,1206	04222	12063G105ZAT1A
A1C71	283-5267-00			CAP,FXD,CERAMIC:MLC;1UF,+80%-20%,25V,Y5V,1206	04222	12063G105ZAT1A
A1C72	283-5267-00			CAP,FXD,CERAMIC:MLC;1UF,+80%-20%,25V,Y5V,1206	04222	12063G105ZAT1A
A1C73	283-5114-00			CAP,FXD,CERAMIC:MLC;0.1UF,10%,50V,X7R,1206	04222	12065C104KAT(1A
A1C74	283-5114-00			CAP,FXD,CERAMIC:MLC;0.1UF,10%,50V,X7R,1206	04222	12065C104KAT(1A
A1C75	283-5267-00			CAP,FXD,CERAMIC:MLC;1UF,+80%-20%,25V,Y5V,1206	04222	12063G105ZAT1A
A1C76	283-5267-00			CAP,FXD,CERAMIC:MLC;1UF,+80%-20%,25V,Y5V,1206	04222	12063G105ZAT1A
A1C77	290-5049-00			CAP,FXD,TANT:DRY;150UF,20%,10V,ESR=0.7 OHM(100KHZ,25C),0.287 X 0.169 (EXTENDED D CASE)	31433	T491X157M010AS
A1C78	283-5267-00			CAP,FXD,CERAMIC:MLC;1UF,+80%-20%,25V,Y5V,1206	04222	12063G105ZAT1A
A1C79	283-0159-02	671-3353-06	671-3353-06	CAP,FXD,CER DI:18PF,5%,50V TAPE & REEL	18796	RPE121-911C0G181 J50V
A1C79	283-0168-00	671-3353-07		CAP,FXD,CER DI:12PF,5%,100V SQUARE	04222	SR151A120JAA
A1CR1	152-5027-00			DIODE,RECT:SCHTKY;40V,1A	04713	MBRS140T3
A1CR2	152-5027-00			DIODE,RECT:SCHTKY;40V,1A	04713	MBRS140T3
A1CR3	152-5018-00			DIODE,SIG:ULTRA FAST;100V,0.74VF,4NS,2.0PF,SER-PAIR	27014	MMBD1203-HIGH
A1CR7	152-0832-00	671-3353-04		SEMICON DVC,DI:SW,S1,50V,0.12A,DO-34	80009	152-0832-00
A1F1	159-0208-00		671-3353-01	FUSE,WIRE LEAD:2A,125V,5 SEC	61857	SP5-2A
A1F1	159-0378-00	671-3353-02		FUSE,WIRE LEAD:2.0A,125V,1 SEC MIN - 60 SEC MAX AT 200%,SLOW BLOW,273002,T&R	75915	R473 002-T1R
A1J1	131-5542-01			CONN,BOX:PCB,BTM ENTRY:FEM,STR,2 X 7,0.1 CTR,0.235 H X 0.125 TAIL,30 GOLD,SLDR MASKPOSTS,DUAL ENTRY	53387	929842-01-07-30
A1J2	131-5543-01			CONN,BOX:PCB,BTM ENTRY:FEM,STR,2 X 10,0.1 CTR,0.235 H X 0.125 TAIL,30 GLD,SLDRMASK POST,DUAL ENTRY	53387	929842-01-10-30
A1J5	131-5527-00			JACK,POWER DC:PCB;MALE,RTANG,2MM PIN,11MMH (0.433) X 3.5MM(0.137) TAIL,9MM(0.354) W,TIN,W/SW,DC PWR JACK	0LXM2	DJ005A
A1J6	131-4794-00			CONN,HDR::PCB:MALE,STR,1 X 2,0.1 CTR,0.235	53387	2402-6112 UB
A1J7	131-4794-00			CONN,HDR::PCB:MALE,STR,1 X 2,0.1 CTR,0.235	53387	2402-6112 UB
A1J8	131-2919-01			CONN,HDR:PCB;MALE,STR,1 X 4,0.1 CTR,0.235MLG X 0.112 TAIL,30GOLD,0.035 DIA PCB	53387	2404-6112TB
A1J9	131-2919-01			CONN,HDR:PCB;MALE,STR,1 X 4,0.1 CTR,0.235MLG X 0.112 TAIL,30GOLD,0.035 DIA PCB	53387	2404-6112TB
A1J10	131-5240-00			CONN,HDR:PCB;MALE,STR,1 X 5,0.1 CTR,0.230MLG X 0.120 TAIL,30GOLD	22526	68001-105
A1L2	108-5051-00			INDUCTOR,FXD:POWER;10UH,10%,I<0.25A,RDC<1.6	TK2058	NL453232T-100K
A1L3	108-5051-00			INDUCTOR,FXD:POWER;10UH,10%,I<0.25A,RDC<1.6	TK2058	NL453232T-100K
A1L4	108-5122-00			COIL,RF:INDUCTOR;FXD,1.8UH,10%,Q=60,SRF=120MHZ,DCR=0.64 OHM,IMAX=330MA	TK2058	ACL3225S-1R8K-T
A1L5	108-5119-00			COIL,RF:INDUCTOR;FXD,1.5UH,10%,Q=60,SRF=130MHZ,DCR=0.59 OHM,IMAX=360MA	TK2058	ACL3225S-1R5K-T
A1L6	108-5122-00			COIL,RF:INDUCTOR;FXD,1.8UH,10%,Q=60,SRF=120MHZ,DCR=0.64 OHM,IMAX=330MA	TK2058	ACL3225S-1R8K-T
A1L7	120-1941-00			TRANSFORMER:Z-92079	0JR03	Z-92079A
A1L8	108-5121-00			COIL,RF:INDUCTOR;FXD,560NH,10%,Q=50,SRF=180MHZ,DCR=0.51 OHM,IMAX=440MA	TK2058	ACL3225S-R56KT

Replaceable Electrical Parts

Component Number	Tektronix Part Number	Serial / Assembly Number		Name & Description	Mfr. Code	Mfr. Part Number
		Effective	Discontinued			
A1L9	120-1938-00			TRANSFORMER:Z-91389E	OJR03	Z-91389E (120-1
A1L10	108-5015-00			INDUCTOR,FXD:POWER;100UH,10%,I<0.11A,RDC<8.0 OHM,Q>40,SRF>8.0 MHZ	TK2058	NL453232T-101K
A1Q1	151-5066-00			TRANSISTOR,SIG:MOS,N-CH;60V,0.115A,7.5 OHM	04713	2N7002LT1
A1Q2	151-5066-00			TRANSISTOR,SIG:MOS,N-CH;60V,0.115A,7.5 OHM	04713	2N7002LT1
A1Q3	151-5066-00			TRANSISTOR,SIG:MOS,N-CH;60V,0.115A,7.5 OHM	04713	2N7002LT1
A1Q4	151-5066-00			TRANSISTOR,SIG:MOS,N-CH;60V,0.115A,7.5 OHM	04713	2N7002LT1
A1Q5	151-5066-00			TRANSISTOR,SIG:MOS,N-CH;60V,0.115A,7.5 OHM	04713	2N7002LT1
A1Q6	151-5044-00			TRANSISTOR,PWR:BIPOLAR,PNP;100V,3.0A,3.0MHZ,AMPL	04713	MJD32CT4
A1Q7	151-5088-00			TRANSISTOR,PWR:MOS,P-CH;30V,4.6A,0.07/0.135	17856	SI9435DY
A1Q8	151-5075-00			TRANSISTOR,SIG:MOS,P-CH;60V,0.12A,10 OHM	17856	TP0610T
A1Q9	151-5066-00			TRANSISTOR,SIG:MOS,N-CH;60V,0.115A,7.5 OHM	04713	2N7002LT1
A1Q10	151-5066-00			TRANSISTOR,SIG:MOS,N-CH;60V,0.115A,7.5 OHM	04713	2N7002LT1
A1R1	311-5036-00			RES,VAR,TRMR:CERMET;5K OHM,25%,0.25W,4MM SQ,TOP ADJ	TK2073	G4DT502E
A1R2	307-5041-01			RES,NTWK FXD:FILM;(15),4.7K OHM,2%,0.08W EA,50PPM	91637	SOMC-1601-472G-
A1R6	321-5113-00			RES,FXD:THICK FILM;75 OHM,1%,0.125W,TC=100PPM	56845	CRCW1206-75ROFT
A1R7	311-5036-00		671-3353-01	RES,VAR,TRMR:CERMET;5K OHM,25%,0.25W,4MM SQ,TOP ADJ	TK2073	G4DT502E
A1R7	311-5034-00	671-3353-02		RES,VAR,TRMR:CERMET;2K OHM,25%,0.25W,4MM SQ,TOP ADJ,SMD,T&R	32997	3314J-1-202E
A1R8	321-5027-00		671-3353-01	RES,FXD:THICK FILM;5.62K OHM,1%,0.125W,TC=100 PPM	50139	BCK5621FT
A1R8	321-5022-00	671-3353-02		RES,FXD:THICK FILM;2.21K OHM,1%,0.125W,TC=100 PPM,1206,T&R	50139	BCK2211FT
A1R9	321-5017-00		671-3353-01	RES,FXD:THICK FILM;825 OHM,1%,0.125W,TC=100	50139	BCK8250FT
A1R9	321-5009-00	671-3353-02		RES,FXD:THICK FILM;182 OHM,1%,0.125W,TC=100 PPM,1206,T&R	50139	BCK1820FT
A1R10	321-5015-00		671-3353-01	RES,FXD:THICK FILM;562 OHM,1%,0.125W,TC=100	50139	BCK5620FT
A1R10	321-5010-00	671-3353-02		RES,FXD:THICK FILM;221 OHM,1%,0.125W,TC=100 PPM,1206,T&R	50139	BCK2211FT
A1R11	321-5022-00		671-3353-01	RES,FXD:THICK FILM;2.21K OHM,1%,0.125W,TC=100 PPM	50139	BCK2211FT
A1R11	321-5017-00	671-3353-02		RES,FXD:THICK FILM;825 OHM,1%,0.125W,TC=100 PPM,1206,T&R	50139	BCK8250FT
A1R13	321-5113-00			RES,FXD:THICK FILM;75 OHM,1%,0.125W,TC=100PPM	56845	CRCW1206-75ROFT
A1R14	321-5113-00			RES,FXD:THICK FILM;75 OHM,1%,0.125W,TC=100PPM	56845	CRCW1206-75ROFT
A1R16	321-5000-00			RES,FXD:THICK FILM;10 OHM,1%,0.125W,TC=100PPM	91637	CRCW120610R0FT
A1R18	321-5034-00			RES,FXD:THICK FILM;22.1K OHM,1%,0.125W,TC=100 PPM	50139	BCK2212FT
A1R20	321-5315-00			RES,FXD,FILM:24.9 OHM,1%,0.125W,SMD,1206	91637	CRCW1206-24R9F
A1R21	321-5315-00			RES,FXD,FILM:24.9 OHM,1%,0.125W,SMD,1206	91637	CRCW1206-24R9F
A1R22	321-5031-00			RES,FXD:THICK FILM;12.1K OHM,1%,0.125W,TC=100 PPM	50139	BCK1212FT
A1R23	321-5030-00			RES,FXD:THICK FILM;10.0K OHM,1%,0.125W,TC=100 PPM	50139	BCK1002FT
A1R24	321-5030-00			RES,FXD:THICK FILM;10.0K OHM,1%,0.125W,TC=100 PPM	50139	BCK1002FT
A1R25	321-5022-00			RES,FXD:THICK FILM;2.21K OHM,1%,0.125W,TC=100 PPM	50139	BCK2211FT
A1R26	321-5000-00			RES,FXD:THICK FILM;10 OHM,1%,0.125W,TC=100PPM	91637	CRCW120610R0FT
A1R28	321-5048-00			RES,FXD:THICK FILM;332K OHM,1%,0.125W,TC=100 PPM	57668	MCR18FXEA332K
A1R29	321-5047-00			RES,FXD:THICK FILM;100K OHM,1%,0.125W,TC=100 PPM	50139	BCK1003FT
A1R30	321-5030-00			RES,FXD:THICK FILM;10.0K OHM,1%,0.125W,TC=100 PPM	50139	BCK1002FT
A1R32	321-5027-00			RES,FXD:THICK FILM;5.62K OHM,1%,0.125W,TC=100 PPM	50139	BCK5621FT
A1R33	321-5023-00			RES,FXD:THICK FILM;2.74K OHM,1%,0.125W,TC=100 PPM	50139	BCK2741FT
A1R34	321-5023-00			RES,FXD:THICK FILM;2.74K OHM,1%,0.125W,TC=100 PPM	50139	BCK2741FT
A1R35	321-5027-00			RES,FXD:THICK FILM;5.62K OHM,1%,0.125W,TC=100 PPM	50139	BCK5621FT
A1R36	321-5020-00			RES,FXD:THICK FILM;1.5K OHM,1%,0.125W,TC=100 PPM	50139	BCK1501FT
A1R37	321-5020-00			RES,FXD:THICK FILM;1.5K OHM,1%,0.125W,TC=100 PPM	50139	BCK1501FT
A1R38	321-5031-00			RES,FXD:THICK FILM;12.1K OHM,1%,0.125W,TC=100 PPM	50139	BCK1212FT
A1R39	321-5034-00			RES,FXD:THICK FILM;22.1K OHM,1%,0.125W,TC=100 PPM	50139	BCK2212FT
A1R40	321-5030-00			RES,FXD:THICK FILM;10.0K OHM,1%,0.125W,TC=100 PPM	50139	BCK1002FT
A1R41	321-5315-00			RES,FXD,FILM:24.9 OHM,1%,0.125W,SMD,1206	91637	CRCW1206-24R9F
A1R42	321-5030-00			RES,FXD:THICK FILM;10.0K OHM,1%,0.125W,TC=100 PPM	50139	BCK1002FT
A1R43	321-5315-00			RES,FXD,FILM:24.9 OHM,1%,0.125W,SMD,1206	91637	CRCW1206-24R9F

Replaceable Electrical Parts

Component Number	Tektronix Part Number	Serial / Assembly Number		Name & Description	Mfr. Code	Mfr. Part Number
		Effective	Discontinued			
A1R45	321-5030-00			RES,FXD:THICK FILM;10.0K OHM,1%,0.125W,TC=100 PPM	50139	BCK1002FT
A1R50	321-5010-00			RES,FXD:THICK FILM;221 OHM,1%,0.125W,TC=100	50139	BCK221FT
A1R51	321-5030-00			RES,FXD:THICK FILM;10.0K OHM,1%,0.125W,TC=100 PPM	50139	BCK1002FT
A1R52	311-5033-00			RES,VAR,TRMR:CERMET;500 OHM,25%,0.25W,4MM SQ, TOP ADJ	TK2073	G4DT501M
A1R53	311-5036-00			RES,VAR,TRMR:CERMET;5K OHM,25%,0.1W,4MM SQ, TOP ADJ,SMD,T&R	32997	3314J-1-502E
A1R54	321-5019-00			RES,FXD:THICK FILM;1.21K OHM,1%,0.125W,TC=100 PPM	50139	BCK1211FT
A1R55	321-5019-00			RES,FXD:THICK FILM;1.21K OHM,1%,0.125W,TC=100 PPM	50139	BCK1211FT
A1R56	321-5015-00			RES,FXD:THICK FILM;562 OHM,1%,0.125W,TC=100	50139	BCK5620FT
A1R57	321-5001-00			RES,FXD:THICK FILM;12.1 OHM,1%,0.125W,TC=100 PPM	91637	CRCW120612R1FT
A1R58	321-5000-00			RES,FXD:THICK FILM;10 OHM,1%,0.125W,TC=100PPM	91637	CRCW120610R0FT
A1R63	321-5030-00			RES,FXD:THICK FILM;10.0K OHM,1%,0.125W,TC=100 PPM	50139	BCK1002FT
A1R65	321-5030-00			RES,FXD:THICK FILM;10.0K OHM,1%,0.125W,TC=100 PPM	50139	BCK1002FT
A1R66	311-5041-00			RES,VAR,TRMR:CERMET;100K OHM,25%,0.25W,4MMSQ, TOP ADJ	TK2073	G4DT104-M
A1R67	321-5013-00			RES,FXD:THICK FILM;392 OHM,1%,0.125W,TC=100	50139	BCK3920FT
A1R68	321-5013-00			RES,FXD:THICK FILM;392 OHM,1%,0.125W,TC=100	50139	BCK3920FT
A1R70	321-5021-00			RES,FXD:THICK FILM;1.82K OHM,1%,0.125W,TC=100 PPM	50139	BCK1821FT
A1R71	311-5033-00			RES,VAR,TRMR:CERMET;500 OHM,25%,0.25W,4MM SQ, TOP ADJ	TK2073	G4DT501M
A1R75	313-1102-00	671-3353-03		RES,FXD:FILM;1K OHM,5%,0.2W TAPED AND REELED	57668	TR20JE01K0
A1U2	156-6174-00			IC,PROCESSOR:CMOS,MICROPROCESSOR;16-BIT,15MHZ, 8-BIT/8-CH A/D	4T165	UPD78C10L
A1U4	156-6751-01			IC,MEMORY:CMOS,EEPROM;2K X 8,SERIAL	60395	X24C16
A1U5	156-6805-00			IC,MEMORY:CMOS,SRAM;32K X 8,25NS,ICC=85MA	TK2519	AS7C256L-25JC
A1U7	163-0241-00			IC,MEMORY:CMOS,EPROM;256K X 8,150NS	80009	163-0241-00
A1U11	156-6560-00			IC,LINEAR:BIPOLAR,OP-AMP;CURRENT FEED-BACK,100MHZ,HIGH OUTPUT CURRENT	13919	OPA603AU
A1U12	156-6518-00			IC,MISC:CMOS,WAVEFORM GENERATOR;DIGITALLY PROGRAMMABLE SINE WAVE GENERATORDC-50KHZ	0AGS1	ML2036CS
A1U13	156-6519-00		671-3353-03	IC,LINEAR:BIPOLAR,OP-AMP;DUAL,AUTOSWITCH MICROPOWER/FULL POWER (SLEEPMODE)	04713	MC33102D
A1U13	156-6852-00	671-3353-04		IC,LINEAR:BIPOLAR,OP-AMP;DUAL,0.6MV VOS,50NA IB,3MHZ,200V/US,DRIVES ALL CAP LOADS,LOW NOIS	64155	LT1352CS8#TR
A1U14	156-6561-00			IC,CONVERTER:BIPOLAR,D/A;10 BIT,60MHZ,CURRENT OUT,LATCHED,LOW POWER,W/REFERENCE	61271	MB40760PF
A1U15	156-6560-00			IC,LINEAR:BIPOLAR,OP-AMP;CURRENT FEED-BACK,100MHZ,HIGH OUTPUT CURRENT	13919	OPA603AU
A1U16	156-6562-00			IC,MEMORY:X9C103S8	60395	X9C103S8
A1U17	156-6519-00		671-3353-03	IC,LINEAR:BIPOLAR,OP-AMP;DUAL,AUTOSWITCH MICROPOWER/FULL POWER (SLEEPMODE)	04713	MC33102D
A1U17	156-6852-00	671-3353-04		IC,LINEAR:BIPOLAR,OP-AMP;DUAL,0.6MV VOS,50NA IB,3MHZ,200V/US,DRIVES ALL CAP LOADS,LOW NOIS	64155	LT1352CS8#TR
A1U20	156-5588-01			IC,LINEAR:BIPOLAR,V REF;POS,2.5V,1.0%,40PPM,SERIES	04713	MC1403DR2
A1U21	156-5155-01		671-3353-02	IC,DIGITAL:HCMOS,GATE;HEX INV	0JR04	TC74HC04AFN(ELP
A1U21	156-6253-00	671-3353-03	671-3353-06	IC,DIGITAL:HCMOS,GATE;HEX INVERTER,SCHMITT TRIG,74HC14,SO14,150,TUBE	01295	SN74HC14D
A1U21	156-5155-01	671-3353-07		IC,DIGITAL:HCMOS,GATE;HEX INV	0JR04	TC74HC04AFN(ELP
A1U22	156-5074-02			IC,DIGITAL:HCMOS,FLIP FLOP;DUAL D-TYPE	01295	SN74HC74DR
A1U23	156-6665-00			IC,MISC:CMOS,PWR SPLY SUPERVISOR;MPU RESET GENERATOR,5V SPLY SENSING,MPU WATCHDOGTIMER	1ES66	MAX1232CSA (C74
A1U24	163-0242-00			IC,MEMORY:CMOS,EPROM;64K X 8,150NS	80009	163-0242-00
A1U25	156-5441-01			IC,LIN:BIPOLAR,VR;POS,ADJ,100MA,2%MICROPWR	27014	LP2951CMX
A1U26	156-6905-00			IC,ASIC:CMOS,CUSTOM;PAL ENCODER,ADG313	27014	MM9423-VUL
A1U27	156-6714-00			IC,LINEAR:BIPOLAR,SW-REGULATOR;STEP-DOWN/BU-CK,5.0V,500MA,4%,SHUTDOWN	27014	LM2574M-5.0
A1VR1	152-5046-00			DIODE,ZENER;20V,5%,225MW	04713	MMBZ5250BLT1
A1Y1	158-0449-00			OSCILLATOR:TCXO;27MHZ,1PPM,5PPM MIN ADJUSTIBL-ITY;3 PIN PACKAGE,DIP14 COMPATIBLE	82567	03-33336-001

Replaceable Electrical Parts

Component Number	Tektronix Part Number	Serial / Assembly Number		Name & Description	Mfr. Code	Mfr. Part Number
		Effective	Discontinued			
A2	671-2586-01			CIRCUIT BD ASSY:KEYBOARD	80009	671258601
A2J1	131-5781-00			CONN,HDR:PCB;MALE,STR,2 X 10,0.1 CTR,0.380	55322	MTLW-110-08-S-D
A3	119-5566-01			DISPLAY,MODULE:LCD;16 CHARACTERS X 2 LINES,5 X 7 DOT MATRIX,TRANSFLECTIVE,YEL/GRN LED	62712	L1672B1P000
W1	174-3002-00			CABLE ASSY:WITH/XLR 131-3207-00	TK2469	174-3002-00
W2	174-3002-00			CABLE ASSY:WITH/XLR 131-3207-00	TK2469	174-3002-00
W3	174-3001-00			CABLE ASSY:WITH/BNC 131-0955-00	TK2469	174-3001-00

Diagrams and Circuit Board Illustrations

This section contains the troubleshooting procedures, block diagrams, circuit board illustrations, component locator tables, waveform illustrations, and schematic diagrams.

Symbols

Graphic symbols and class designation letters are based on ANSI Standard Y32.2-1975. Abbreviations are based on ANSI Y1.1-1972.

Logic symbology is based on ANSI/IEEE Standard 91-1984 in terms of positive logic. Logic symbols depict the logic function performed and can differ from the manufacturer's data.

The tilde (~) preceding a signal name indicates that the signal performs its intended function when in the low state.

Other standards used in the preparation of diagrams by Tektronix, Inc., include the following:

- Tektronix Standard 062-2476 Symbols and Practices for Schematic Drafting
- ANSI Y14.159-1971 Interconnection Diagrams
- ANSI Y32.16-1975 Reference Designations for Electronic Equipment
- MIL-HDBK-63038-1A Military Standard Technical Manual Writing Handbook

Component Values

Electrical components shown on the diagrams are in the following units unless noted otherwise:

Capacitors: Values one or greater are in picofarads (pF).
Values less than one are in microfarads (μF).

Resistors: Values are in Ohms (Ω).

Graphic Items and Special Symbols Used in This Manual

Each assembly in the instrument is assigned an assembly number (for example A5). The assembly number appears in the title on the diagram, in the lookup table for the schematic diagram, and corresponding component locator illustration. The Replaceable Electrical Parts list is arranged by assembly in numerical sequence; the components are listed by component number.

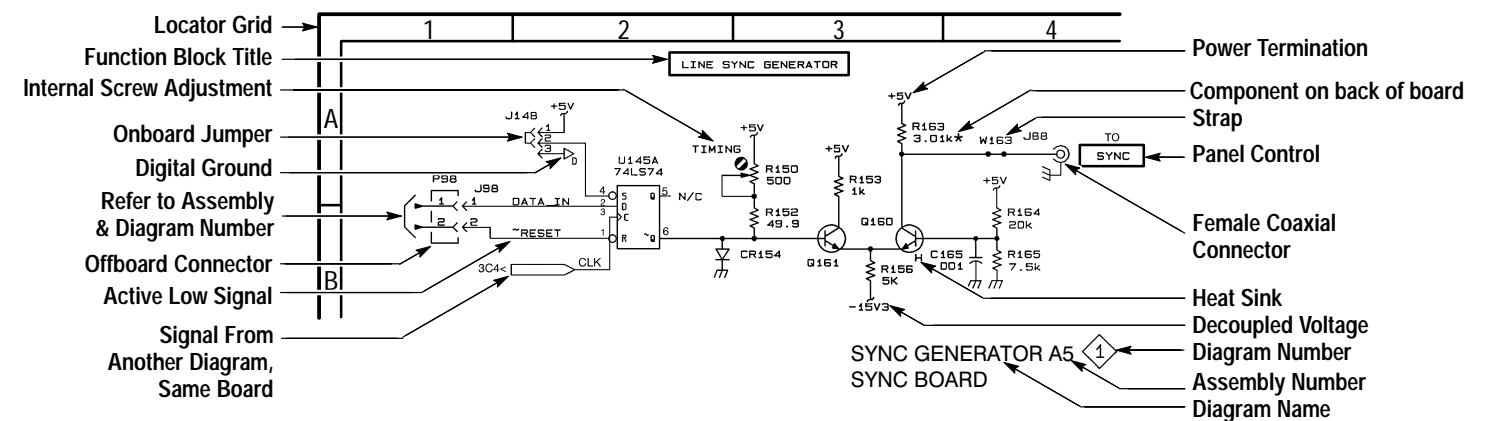

Component Locator Diagrams

The schematic diagram and circuit board component location illustrations have grids marked on them. The component lookup tables refer to these grids to help you locate a component. The circuit board illustration appears only once; its lookup table lists the diagram number of all diagrams on which the circuitry appears.

Some of the circuit board component location illustrations are expanded and divided into several parts to make it easier for you to locate small components. To determine which part of the whole locator diagram you are looking at, refer to the small locator key shown below. The gray block, within the larger circuit board outline, shows where that part fits in the whole locator diagram. Each part in the key is labeled with an identifying letter that appears in the figure titles under component locator diagrams.

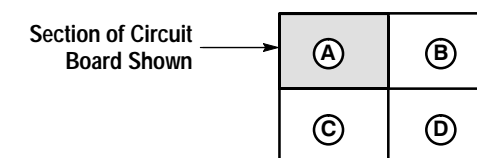

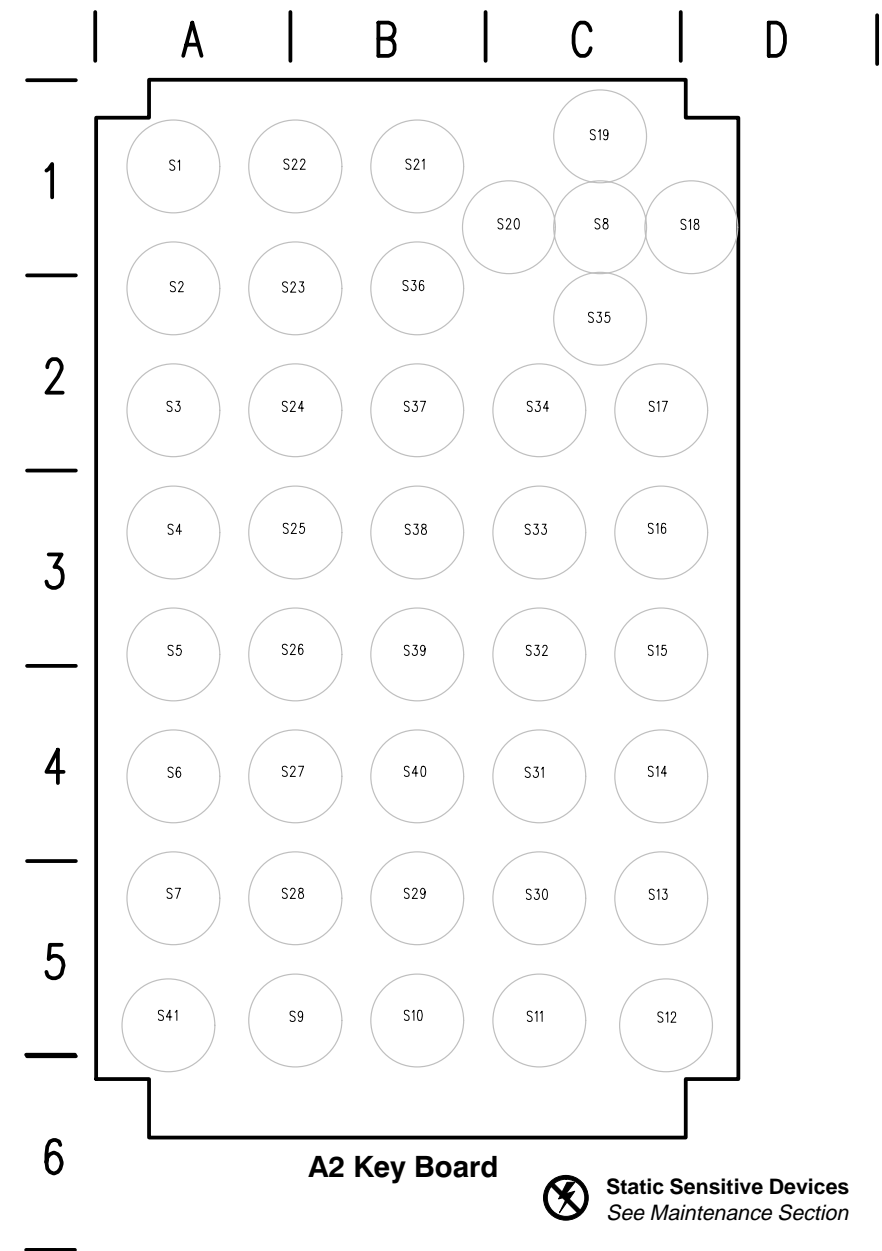

A2 Key Board and Diagram <1> Component Locator

The schematic diagram has an alphanumeric grid to assist in locating parts.

Assembly A2.

Comp No	Diag Loc	Bd Loc	Comp No	Diag Loc	Bd Loc	Comp No	Diag Loc	Bd Loc	Comp No	Diag Loc	Bd Loc
J1	H1	B6	S11	D4	C5	S22	B1	A1	S33	D2	C3
S1	A1	A1	S12	D4	C5	S23	B1	A1	S34	D2	C2
S2	A1	A1	S13	D4	C5	S24	B2	A2	S35	D1	C2
S3	A2	A2	S14	D3	C4	S25	B2	A3			
S4	A2	A3	S15	D3	C3				S36	C1	B1
S5	A3	A3	S16	D2	C3	S26	B3	A3	S37	C2	B2
			S17	D2	C2	S27	B3	A4	S38	C2	B3
S6	A3	A4	S18	D1	C1	S28	B4	A5			
S7	A4	A5	S19	D1	C1	S29	C4	B5	S39	C3	B3
S8	A4	C1	S20	D1	B1	S30	D4	C5	S40	C3	B4
S9	B4	A5							S41	G2	A5
S10	C4	B5	S21	C1	B1	S31	D3	C4			
						S32	D3	C3			

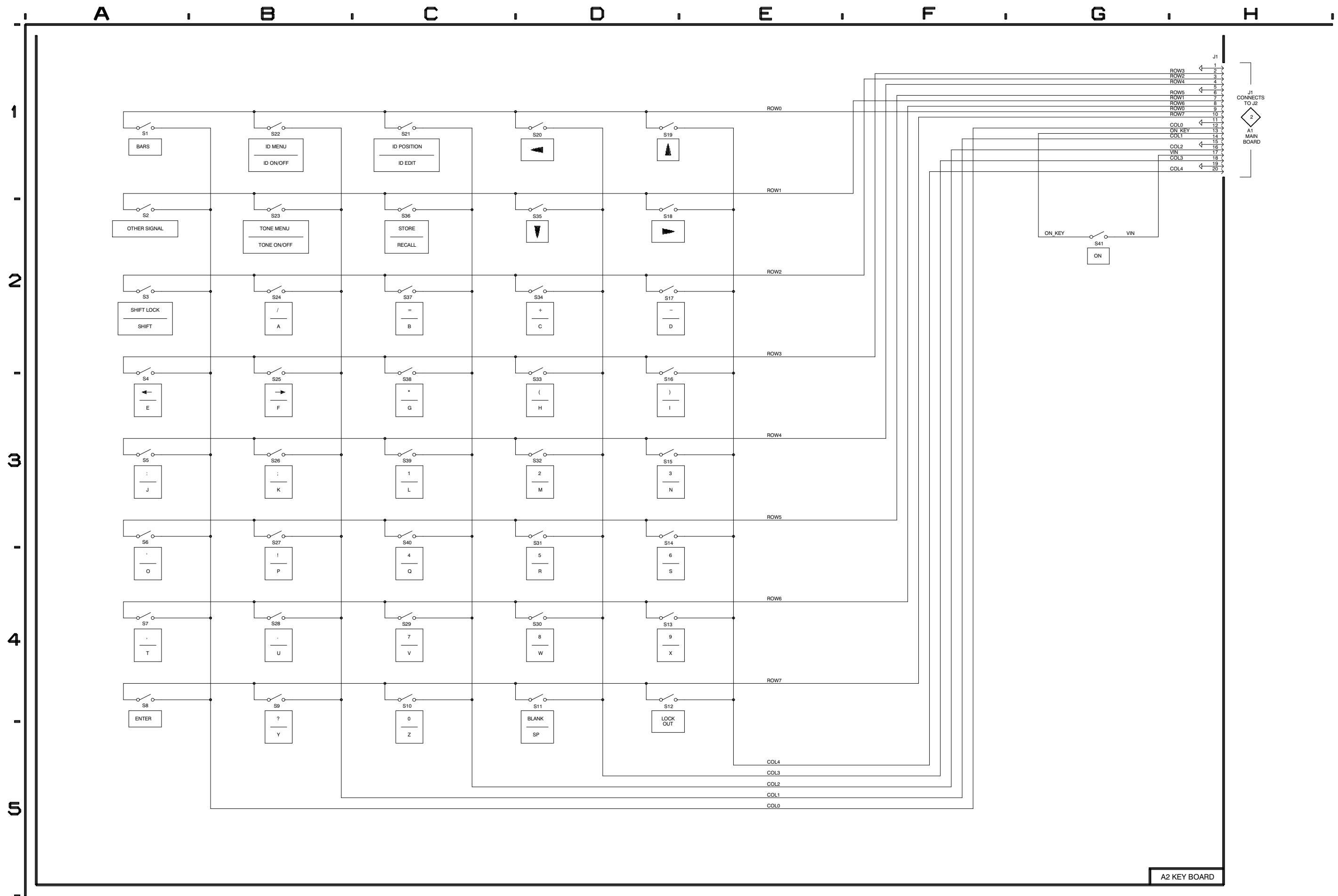

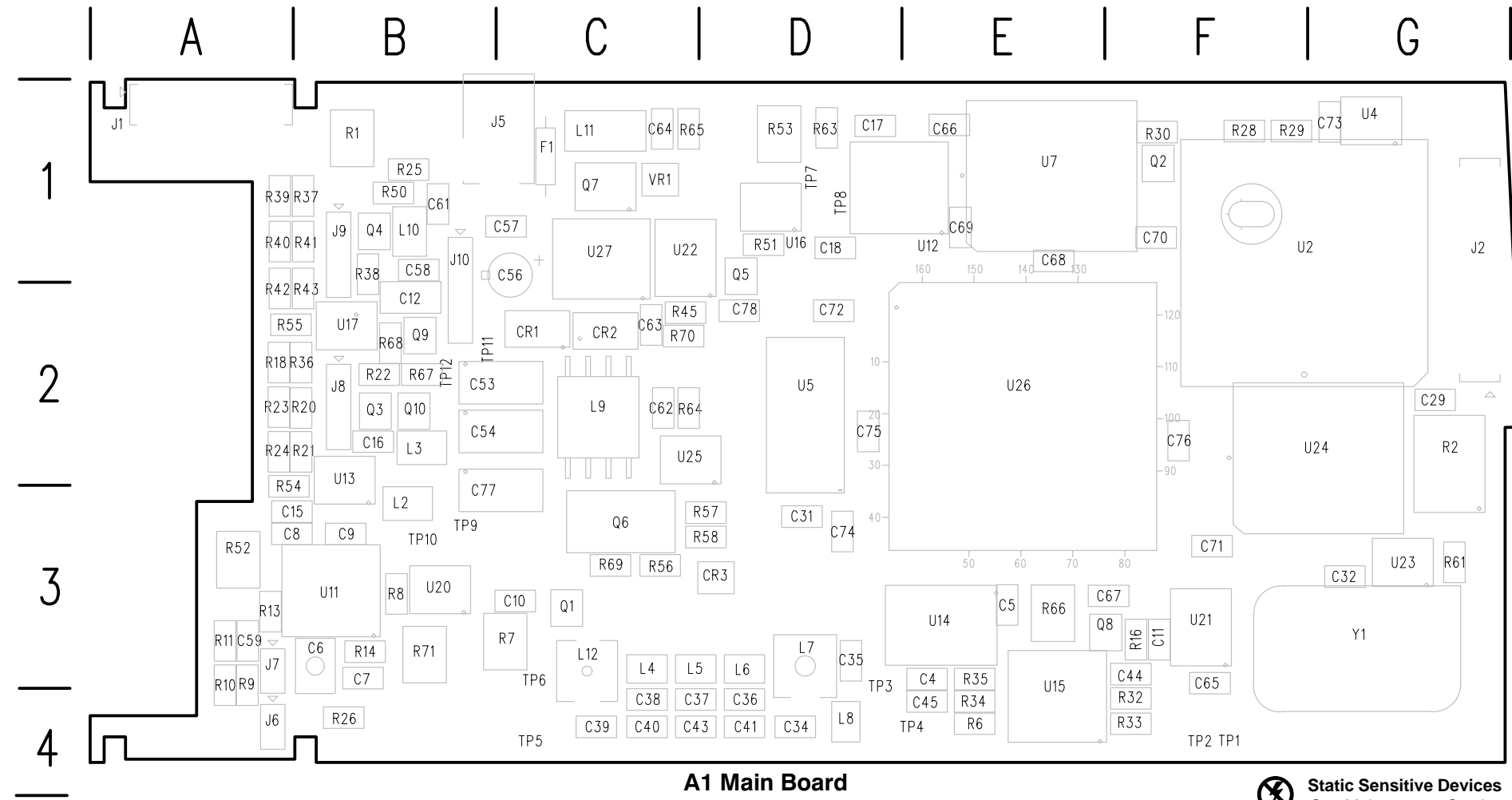

A1 Main Board

Static Sensitive Devices
See Maintenance Section

A1 Main Board and Diagrams <2> and <3> Component Locator

Comp No	Diag No	Diag Loc	Bd Loc	Comp No	Diag No	Diag Loc	Bd Loc	Comp No	Diag No	Diag Loc	Bd Loc	Comp No	Diag No	Diag Loc	Bd Loc	Comp No	Diag No	Diag Loc	Bd Loc	Comp No	Diag No	Diag Loc	Bd Loc	Comp No	Diag No	Diag Loc	Bd Loc				
C4	3	C2	E3	C43	3	E1	C4	C75	2	C5	D2	L7	3	D1	D3	R11	3	G2	A3	R40	3	G4	A1	R71	3	G2	B4	U15	3	D1	F4
C5	3	C2	E3	C44	3	D1	F3	C76	2	C5	F2	L8	3	D2	D4	R13	3	G1	A3	R41	3	G3	B1	R75	2	E4		U16	3	B3	D1
C6	3	G2	B3	C45	3	D1	E4	C77	3	F4	C3	L9	3	F5	C2	R14	3	F1	B3	R42	3	G4	A2	TP1	2	E4	F4	U17A	3	F3	B2
C7	3	G2	B3	C53	3	F5	C2	C78	3	D5	D2	L10	3	D3	B1	R16	3	C1	F3	R43	3	G4	B2	TP2	2	E4	F4	U17B	3	G4	B2
C8	3	G1	A3	C54	3	F4	C2					L11	3	B5	C1	R18	3	F2	A2	R45	3	D5	C2	TP3	3	D1	D4	U20	3	A2	B3
C9	3	G2	B3	C55	3	D5	C1	CR1	3	F5	C2	L12	3	F1	C3	R20	3	G3	B2	R50	3	D3	B1	TP4	3	D2	D4	U21A	2	E4	F3
C10	3	B2	C3	C56	3	D5	C1	CR2	3	F5	C2	Q1	2	H2	C3	R21	3	G3	B2	R51	3	D5	D1	TP5	3	F2	C4	U21B	2	B4	F3
C11	3	C1	F3	C57	3	C5	B1	CR3	3	C5	D3	Q2	2	B2	F1	R22	3	E3	B2	R52	3	G2	A3	TP6	3	F1	C3	U21C	2	B4	F3
C12	3	E3	B2	C58	3	E3	B1	CR7	3	B5		Q3	3	E3	B2	R23	3	G3	A2	R53	3	B3	D1	TP7	3	D3	D1	U21D	2	B5	F3
C15	3	F3	A3	C59	3	H1	A3					Q4	3	E4	B1	R24	3	G3	A2	R54	3	G3	A3	TP8	3	D3	D1	U21E	2	B5	F3
C16	3	F3	B2	C61	3	D3	B1	F1	3	B5	C1	Q5	3	D5	D2	R25	2	G1	B1	R55	3	G4	A2	TP9	3	G4	B3	U21F	2	B5	F3
C17	3	D3	D1	C62	3	F5	C2	J1	2	H1	A1	Q6	3	B5	C3	R26	2	H1	B4	R56	3	B5	C3	TP10	3	G4	B3	U22A	3	D5	C1
C18	3	D3	D1	C63	3	C4	C2	J2	2	A1	G2	Q7	3	B4	C1	R28	2	A2	F1	R57	3	C5	C3	TP11	3	G5	B2	U22B	3	D4	C1
C29	2	C3	G2	C64	3	B5	C1	J5	3	A5	C1	Q8	3	C2	E3	R29	2	A2	F1	R58	3	C5	C3	TP12	3	G5	B2	U23	2	B3	G3
C31	2	H3	D3	C65	2	E4	F4	J6	2	H1	A4	Q9	3	F4	B2	R30	2	A2	F1	R61	2	A3	G3	U2	2	C2	F1	U24	2	E1	F3
C32	2	D4	G3	C66	2	H5	E1	J7	3	H1	A3	Q10	3	F3	B2	R32	3	C1	F4	R63	3	B3	D1	U4	2	D3	G1	U25	3	C4	D2
C34	3	D2	D4	C67	2	D5	E3	J8	3	H3	B2	R1	2	G1	B1	R33	3	C1	F4	R64	3	F5	C2	U5	2	G2	D3	U26	2	F2	D3
C35	3	D1	D3	C68	2	D5	E1	J9	3	H3	B1	R2	2	C1	G2	R34	3	D1	E4	R65	3	B5	C1	U7	2	G4	E1	U27	3	F2	C2
C36	3	E1	D4	C69	2	D5	E1	J10	3	A5	B1	R6	3	D1	E4	R35	3	C1	E3	R66	3	C2	E3	U11	3	G1	B3	U12	3	C3	E1
C37	3	E1	C4	C70	2	D5	F1	L2	3	G5	B2	R7	3	G2	C3	R36	3	F3	A2	R67	3	F3	B2	U13A	3	F3	B3	VR1	3	B5	C1
C38	3	F1	C4	C71	2	D5	F3	L3	3	G5	B2	R8	3	G2	B3	R37	3	F3	B1	R68	3	F4	B2	U13B	3	G3	B3	Y1	2	D4	G3
C39	3	F1	C4	C72	2	E5	D2	L4	3	F1	C3	R9	3	G2	A4	R38	3	E3	B1	R69	3	B5	C3	U14	3	B1	E3				
C40	3	E1	C4	C73	2	E5	G1	L5	3	E1	C3	R10	3	G2	A4	R39	3	F3	A1	R70	3	D5	C2								
C41	3	E1	D4	C74	2	E5	D3	L6	3	E1	D3																				

Schematic Diagram A1<3> Component Locator Chart

The schematic diagram has an alphanumeric grid to assist in locating parts within that diagram.

Assembly A1.

Comp No	Diag Loc	Bd Loc	Comp No	Diag Loc	Bd Loc	Comp No	Diag Loc	Bd Loc	Comp No	Diag Loc	Bd Loc
C4	C2	E3							R65	B5	C1
C5	C2	E3	CR1	F5	C2	R11	G2	A3			
C6	G2	B3	CR2	F5	C2	R13	G1	A3	R66	C2	E3
C7	G2	B3	CR3	C5	D3	R14	F1	B3	R67	F3	B2
C8	G1	A3	CR7	B5		R16	C1	F3	R68	F4	B2
						R18	F2	A2	R69	B5	C3
C9	G2	B3	F1	B5	C1				R70	D5	C2
C10	B2	C3				R20	G3	B2	R71	G2	B4
C11	C1	F3	J5	A5	C1	R21	G3	B2			
C12	E3	B2	J7	H1	A3	R22	E3	B2	TP3	D1	D4
C15	F3	A3	J8	H3	B2	R23	G3	A2	TP4	D2	D4
			J9	H3	B1	R24	G3	A2	TP5	F2	C4
C16	F3	B2	J10	A5	B1				TP6	F1	C3
C17	D3	D1				R32	C1	F4	TP7	D3	D1
C18	D3	D1	L2	G5	B2	R33	C1	F4			
C34	D2	D4	L3	G5	B2	R34	D1	E4	TP8	D3	D1
C35	D1	D3	L4	F1	C3	R35	C1	E3	TP9	G4	B3
			L5	E1	C3	R36	F3	A2	TP10	G4	B3
C36	E1	D4	L6	E1	D3				TP11	G5	B2
C37	E1	C4				R37	F3	B1	TP12	G5	B2
C38	F1	C4	L7	D1	D3	R38	E3	B1			
C39	F1	C4	L8	D2	D4	R39	F3	A1	U11	G1	B3
C40	E1	C4	L9	F5	C2	R40	G4	A1	U12	C3	E1
			L10	D3	B1	R41	G3	B1	U13A	F3	B3
C41	E1	D4	L11	B5	C1				U13B	G3	B3
C43	E1	C4	L12	F1	C3	R42	G4	A2	U14	B1	E3
C44	D1	F3				R43	G4	B2			
C45	D1	E4	Q3	E3	B2	R45	D5	C2	U15	D1	F4
C53	F5	C2	Q4	E4	B1	R50	D3	B1	U16	B3	D1
			Q5	D5	D2	R51	D5	D1	U17A	F3	B2
C54	F4	C2	Q6	B5	C3				U17B	G4	B2
C56	D5	C1	Q7	B4	C1	R52	G2	A3	U20	A2	B3
C57	C5	B1				R53	B3	D1			
C58	E3	B1	Q8	C2	E3	R54	G3	A3	U22A	D5	C1
C59	H1	A3	Q9	F4	B2	R55	G4	A2	U22B	D4	C1
			Q10	F3	B2	R56	B5	C3	U25	C4	D2
C61	D3	B1							U27	E5	C2
C62	F5	C2	R6	D1	E4	R57	C5	C3			
C63	C4	C2	R7	G2	C3	R58	C5	C3	VR1	B5	C1
C64	B5	C1	R8	G2	B3	R63	B3	D1			
C77	F4	C3	R9	G2	A4	R64	F5	C2			
C78	D5	D2	R10	G2	A4						

1

2

3

4

5

TEST SIGNAL DAC

TEST SIGNAL OUTPUT FILTER

TEST SIGNAL OUTPUT AMPLIFIER

AUDIO

POWER SUPPLIES

NOTE: SEE PARTS LIST FOR EARLIER VALUES AND SERIAL NUMBER RANGES.

PART OF A1 MAIN BOARD

TEST SIGNAL, AUDIO OUT, AND POWER SUPPLY

Replaceable Mechanical Parts

This section contains a list of the components that are replaceable for the TSG 95. Use this list to identify and order replacement parts. There is a separate Replaceable Mechanical Parts list for each instrument.

Parts Ordering Information

Replacement parts are available from or through your local Tektronix, Inc., Field Office or representative.

Changes to Tektronix instruments are sometimes made to accommodate improved components as they become available and to give you the benefit of the latest circuit improvements. Therefore, when ordering parts, it is important to include the following information in your order.

- Part number
- Instrument type or model number
- Instrument serial number
- Instrument modification number, if applicable

If a part you have ordered has been replaced with a new or improved part, your local Tektronix, Inc., Field Office or representative will contact you concerning any change in part number.

Change information, if any, is located at the rear of this manual.

Using the Replaceable Mechanical Parts List

The tabular information in the Replaceable Mechanical Parts list is arranged for quick retrieval. Understanding the structure and features of the list will help you find all of the information you need for ordering replaceable parts.

Cross Index–Mfr. Code Number to Manufacturer

The Mfg. Code Number to Manufacturer Cross Index for the mechanical parts list is located immediately after this page. The cross index provides codes, names, and addresses of manufacturers of components listed in the mechanical parts list.

Abbreviations

Abbreviations conform to American National Standards Institute (ANSI) standard Y1.1.

Chassis Parts

Chassis-mounted parts and cable assemblies are located at the end of the Replaceable Electrical Parts list.

Column Descriptions

Figure & Index No. (Column 1)	Items in this section are referenced by figure and index numbers to the illustrations.																																																												
Tektronix Part No. (Column 2)	Indicates part number to be used when ordering replacement part from Tektronix.																																																												
Serial No. (Column 3 and 4)	Column three (3) indicates the serial number at which the part was first used. Column four (4) indicates the serial number at which the part was removed. No serial number entered indicates part is good for all serial numbers.																																																												
Qty (Column 5)	This indicates the quantity of mechanical parts used.																																																												
Name and Description (Column 6)	<p>An item name is separated from the description by a colon (:). Because of space limitations, an item name may sometimes appear as incomplete. Use the U.S. Federal Catalog handbook H6-1 for further item name identification.</p> <p>Following is an example of the indentation system used to indicate relationship.</p> <table border="0" style="margin-left: 20px;"> <tr> <td style="padding-right: 5px;">1</td> <td style="padding-right: 5px;">2</td> <td style="padding-right: 5px;">3</td> <td style="padding-right: 5px;">4</td> <td style="padding-right: 5px;">5</td> <td>Name & Description</td> </tr> <tr> <td></td> <td></td> <td></td> <td></td> <td></td> <td>Assembly and/or Component</td> </tr> <tr> <td></td> <td></td> <td></td> <td></td> <td></td> <td>Mounting parts for Assembly and/or Component</td> </tr> <tr> <td></td> <td></td> <td></td> <td></td> <td></td> <td>*MOUNTING PARTS*/*END MOUNTING PARTS*</td> </tr> <tr> <td></td> <td></td> <td></td> <td></td> <td></td> <td>Detail Part of Assembly and/or Component</td> </tr> <tr> <td></td> <td></td> <td></td> <td></td> <td></td> <td>Mounting parts for Detail Part</td> </tr> <tr> <td></td> <td></td> <td></td> <td></td> <td></td> <td>*MOUNTING PARTS*/*END MOUNTING PARTS*</td> </tr> <tr> <td></td> <td></td> <td></td> <td></td> <td></td> <td>Parts of Detail Part</td> </tr> <tr> <td></td> <td></td> <td></td> <td></td> <td></td> <td>Mounting parts for Parts of Detail Part</td> </tr> <tr> <td></td> <td></td> <td></td> <td></td> <td></td> <td>*MOUNTING PARTS*/*END MOUNTING PARTS*</td> </tr> </table> <p>Mounting Parts always appear in the same indentation as the Item it mounts, while the detail parts are indented to the right. Indented items are part of and included with, the next higher indentation. Mounting parts must be purchased separately, unless otherwise specified.</p>	1	2	3	4	5	Name & Description						Assembly and/or Component						Mounting parts for Assembly and/or Component						*MOUNTING PARTS*/*END MOUNTING PARTS*						Detail Part of Assembly and/or Component						Mounting parts for Detail Part						*MOUNTING PARTS*/*END MOUNTING PARTS*						Parts of Detail Part						Mounting parts for Parts of Detail Part						*MOUNTING PARTS*/*END MOUNTING PARTS*
1	2	3	4	5	Name & Description																																																								
					Assembly and/or Component																																																								
					Mounting parts for Assembly and/or Component																																																								
					MOUNTING PARTS/*END MOUNTING PARTS*																																																								
					Detail Part of Assembly and/or Component																																																								
					Mounting parts for Detail Part																																																								
					MOUNTING PARTS/*END MOUNTING PARTS*																																																								
					Parts of Detail Part																																																								
					Mounting parts for Parts of Detail Part																																																								
					MOUNTING PARTS/*END MOUNTING PARTS*																																																								
Mfr. Code (Column 7)	Indicates the code number of the actual manufacturer of the part. (Code to name and address cross reference can be found immediately after this page.)																																																												
Mfr. Part Number (Column 8)	Indicates actual manufacturer's part number.																																																												

Cross Index – Mfr. Code Number To Manufacturer

Mfr. Code	Manufacturer	Address	City, State, Zip Code
TK0435	LEWIS SCREW CO	4300 S RACINE AVE	CHICAGO IL 60609-3320
TK1155	QUALITY PLASTIC INJECTION MOLDING	3910 INDUSTRIAL AVE	COEUR D'ALENE ID 83814
TK1572	RAN-ROB INC	631 85TH AVE	OAKLAND CA 94621-1254
TK2469	UNITREK CORPORATION	3000 LEWIS & CLARK WAY SUITE #2	VANCOUVER WA 98601
0DWW6	MICRO POWER ELECTRONICS	7973 SW CIRBUS DRIVE BLDG. #22	BEAVERTON OR 97005
0VG90	GLOBTEK INC	186 VETERANS DRIVE	NORTHVALE, NJ 07647
06090	RAYCHEM CORP	300 CONSTITUTION DRIVE	MENLO PARK CA 94025-1111
24931	SPECIALTY CONNECTOR CO INC	2100 EARLYWOOD DR PO BOX 547	FRANKLIN IN 46131
62712	SEIKO INSTRUMENTS USA	2990 W LOMITA BLVD	TORRANCE CA 90505-5102
73743	FISCHER SPECIAL MFG CO	111 INDUSTRIAL RD	COLD SPRING KY 41076-9749
80009	TEKTRONIX INC	14150 SW KARL BRAUN DR PO BOX 500	BEAVERTON OR 97077-0001

Replaceable Mechanical Parts

Fig. & Index No.	Tektronix Part No.	Serial Number Effective	Dscont	Qty	12345	Name & Description	Mfr. Code	Mfr. Part No.
1-1	614-0913-00			1		KIT ASSEMBLY:BATTERY HOLDER SUB ASSEMBLY *MOUNTING PARTS*	80009	614091300
-2	211-0097-00			4		SCREW,MACHINE:4-40 X 0.312,PNH,STL *END MOUNTING PARTS*	TK0435	ORDER BY DESC
-3	348-1347-00			4		PAD,CUSHIONING:TSG90	80009	348134700
-4	200-4075-00			1		DOOR,BATTERY:POLYCARBONATE	TK1155	200-4075-00
-5	333-4065-00			1		PANEL,REAR:POLYCARBONATE	80009	333406500
-6	-----			1		CABLE ASSY:WITH/BNC (SEE W3 REPL) *ATTACHED PARTS*		
-7	210-0590-00			1		NUT,PLAIN,HEX:0.375-32 X 0.438 BRS CD PL	73743	28269-402
-8	210-0255-00			1		TERMINAL,LUG:0.391 ID,LOCKING,BRS CD PL	TK1572	ORDER BY DESC
	162-0561-00			1		INSUL SLVG,ELEC:HT SHRINK,0.093ID,POLYOLEFI- N,BLACK,0.02 WALL THICKNESS *END ATTACHED PARTS*	06090	VERSAFIT
-9	-----			2		CABLE ASSY:WITH/XLR (SEE W1 AND W2 REPL) *MOUNTING PARTS*		
-10	211-0101-00			4		SCREW,MACHINE:4-40 X 0.25,FLH,100 DEG,STL	TK0435	ORDER BY DESC
-11	210-0586-00			4		NUT,PL,ASSEM WA:4-40 X 0.25,STL CD PL *END MOUNTING PARTS*	TK0435	ORDER BY DESC
-12	-----			1		CKT BD ASSY:MAINTSG95 (SEE A1 REPL)		
-13	426-2408-00			1		SPACER,BOARD:POLYCARBONATE	80009	426240800
-14	-----			1		CIRCUIT BD ASSY:KEYBOARD (SEE A2 REPL)		
-15	119-4487-01			1		KEYPAD:SILICONE RUBBER	80009	119448701
-16	361-1636-00			2		SPACER:SANTOPREN	80009	361163600
-17	-----			1		DISPLAY,MODULE:LCD:16 CHARACTERS X 2 LINES,5 X 7 DOT MATRIX,TRANSFLECTIVE,YEL/GRN LEDBACK- LIGHT,WIDE TEMP RANGE (SEE A3 REPL)		

Replaceable Mechanical Parts

Fig. & Index No.	Tektronix Part No.	Serial Number Effective	Dscont	Qty	12345	Name & Description	Mfr. Code	Mfr. Part No.
-18	614-0925-00			1		SUBASSY KIT:	80009	614092500
						STANDARD ACCESSORIES		
	016-1229-00			1		CASE, CARRYING: TSG90	80009	016122900
	070-8915-00			1		MANUAL, TECH: INSTRUCTION, CARD	80009	070891500
	070-8916-03			1		MANUAL, TECH: USER	80009	070891603
-19	119-4538-01			1		POWER SUPPLY: WALL MOUNT, 12W, 120VAC 60HZ IN, 12VDC 1.0A OUT, UNREG, USA, 183CM CABLE, RT ANG CONN, W/NOISE, FILTER (STD ONLY)	8009	119-4538-01
-20	386-6787-00	B011406				STAND: 0.01/0.015 THK BLACK VINYL PLASTIC COATING	80009	386-6787-00
						OPTIONAL ACCESSORIES		
-21	119-4488-00			1		BAT PACK ASSY:	0DWW6	101-147-1
	070-8917-02			1		MANUAL, TECH: SERVICE, TSG95	80009	070891702
	119-4540-02			1		POWER SUPPLY: WALL MOUNT, 12W, 220 VAC 50HZ IN, 12VDC 1.0A OUT, UNREG, EUROPEAN, 183CM CABLE, RT ANG CONN, W/NOISE, FILTER (EUROPEAN OPTION A1 ONLY)	80009	119-4540-02
	119-4541-02			1		POWER SUPPLY: WALL MOUNT, 12W, 240VAC 50HZ IN, 12VDC 1.0A OUT, UNREG, UK, 183CM, CABLE, RT ANG CONN, W/NOISE, FILTER (UNITED KINGDOM OPTION A2 ONLY)	80009	119-4541-02
	119-4542-02			1		POWER SUPPLY: EXTERNAL, WALL MOUNT, 12W 240VAC 50HZ IN, 12VDC 1.0A OUT, UNREG, AUSTRALIAN, 183CM CABLE, RT ANG CONN, W/NOISE, FILTER (AUSTRALIAN OPTION A3 ONLY)	80009	119-4542-02
	119-4539-01			1		POWER SUPPLY: WALL MOUNT, 12W, 100VAC 50HZ IN, 12VDC 1.0A OUT, UNREG, JAPAN TYPE, 183CM CABLE, RT ANG CONN, W/NOISE, FILTER (JAPANESE OPTION A6 ONLY)	80009	119-4539-01

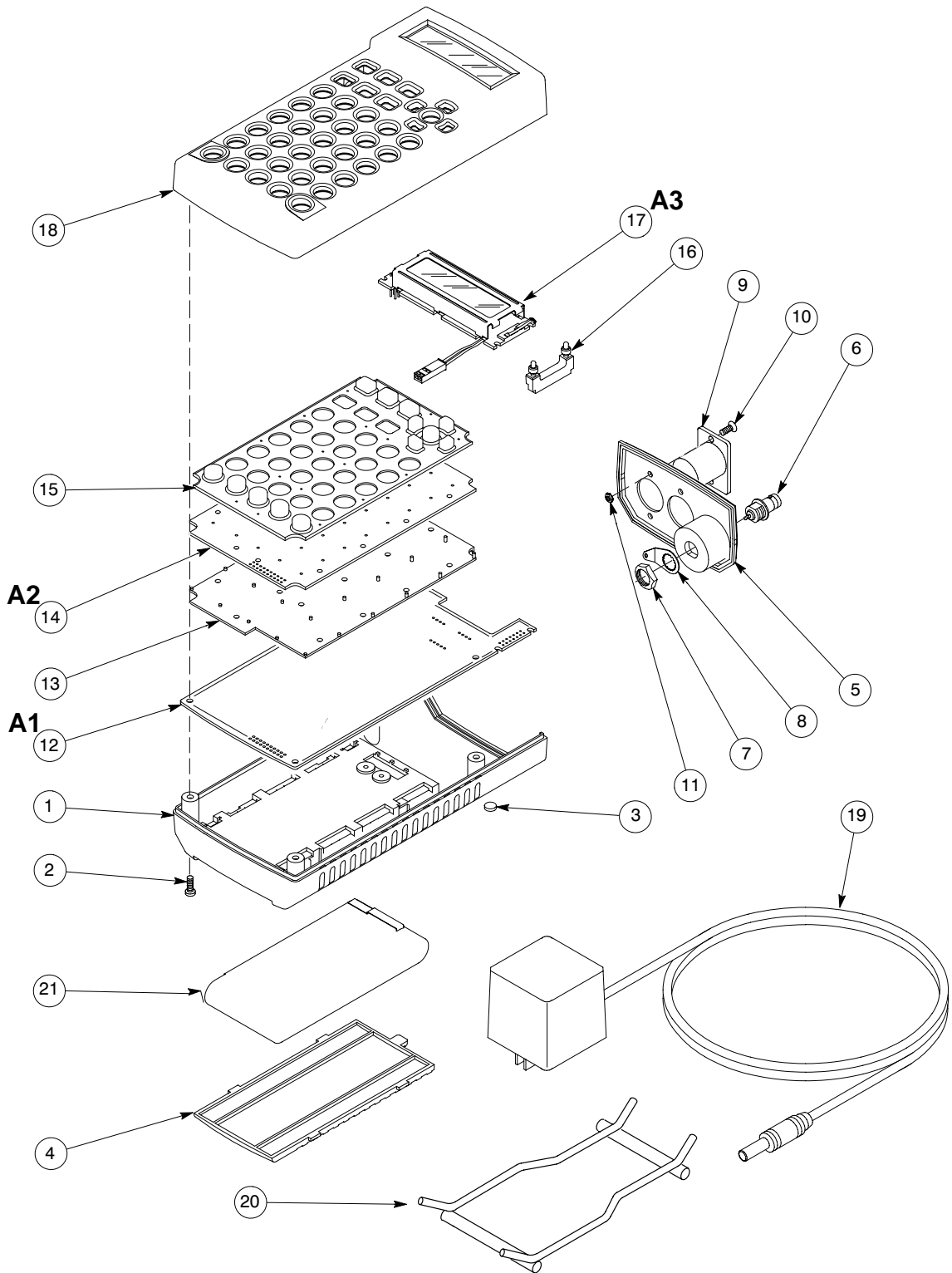

Figure 1 Exploded View

