

# INSTRUCTION MANUAL



TYPE  
7  
PLUG-IN

*Tektronix, Inc.*

S.W. Millikan Way ● P. O. Box 500 ● Beaverton, Oregon ● Phone MI 4-0161 ● Cables: Tektronix

*Tektronix International A.G.*

Terrassenweg 1A ● Zug, Switzerland ● PH. 042-49192 ● Cable: Tekintag, Zug Switzerland ● Telex 53.574

070-251



## WARRANTY

All Tektronix instruments are warranted against defective materials and workmanship for one year. Tektronix transformers, manufactured in our own plant, are warranted for the life of the instrument.

Any questions with respect to the warranty mentioned above should be taken up with your Tektronix Field Engineer.

Tektronix repair and replacement-part service is geared directly to the field, therefore all requests for repairs and replacement parts should be directed to the Tektronix Field Office or Representative in your area. This procedure will assure you the fastest possible service. Please include the instrument Type and Serial number with all requests for parts or service.

Specifications and price change privileges reserved.

Copyright © 1960 by Tektronix, Inc., Beaverton, Oregon. Printed in the United States of America. All rights reserved. Contents of this publication may not be reproduced in any form without permission of the copyright owner.



## CONTENTS

Warranty

- Section 1 Specifications
- Section 2 Operating Instructions
- Section 3 Circuit Description
- Section 4 Maintenance
- Section 5 Calibration
- Section 6 Accessories
- Section 7 Parts List and Diagrams



Type Z

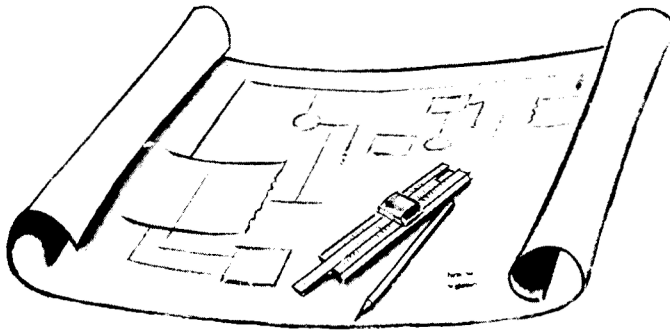

# SECTION 1

## SPECIFICATIONS

### General Information

The Type Z Plug-In Unit is a calibrated differential comparator preamplifier designed for use in all Tektronix Type 530-, 540-, 550-, or 580-Series Oscilloscopes. The unit may be used for three different modes of operation: (1) as a conventional plug-in preamplifier, (2) as a differential input preamplifier, or (3) as a calibrated differential comparator.

As a conventional preamplifier, the Z Unit alone has a risetime of 24 nanoseconds and a maximum sensitivity of 0.05 volt per centimeter of deflection. Table 1-1 summarizes the risetimes and bandwidths available when the Z Unit is used in combination with various types of Tektronix oscilloscopes.

TABLE 1-1

Z Unit and Type:	Risetime in Nanoseconds*	Bandwidth, -3 db, Megacycles/Second*
532	70	5
531 or 535	39	9
536	40	9
531A, 533, or 535A	35	10
541, 543, 545, 541A, 545A, 551, or 555	27	13
581 or 585**	27	13

\*For signals which do not overscan the graticule.

\*\*Type 81 Adapter must be used.

In differential input mode of operation, the dynamic range of  $\pm 100$  volts allows the application of common-mode signals up to 100 volts to be applied to the unit without attenuation. The common-mode rejection ratio of 40,000 to 1 at dc or low frequencies allows measurement of differential signals less than 50 mv in amplitude on  $\pm 100$ -volt common-mode signals.

As a calibrated differential comparator, the Z Unit has an effective screen height of  $\pm 2000$  cm at maximum sensitivity. Within the dynamic range of  $\pm 100$  volts, calibrated  $\pm$ DC comparison voltages can be added differentially to the input waveform to permit a maximum of 0.005% or 5 mv per mm to be accurately resolved.

### Vertical Deflection Factors

0.05 to 25 volts per centimeter in nine calibrated steps; also continuously variable (uncalibrated) between steps and up to 60 volts per centimeter.

### Input Impedance

1 megohm  $\pm 1\%$  paralleled by 24 pf.

### Maximum Allowable Combined DC and Peak AC Input

600 volts, ac-coupled.

### Maximum Common-Mode Signal

$\pm 100$  volts at 0.05 volt per centimeter. Higher voltages are permissible with larger vertical deflection factors.

### Common-Mode Rejection Ratio

40,000 to 1 at 0.05 volt per centimeter with a 1-kc sine wave, lower at other sensitivities and higher frequencies.

At 0.05 volt per centimeter, a 200-volt (p-p) 1-kc common-mode signal produces less than 1 mm of vertical deflection.

### Comparison Voltages Available

Three voltage ranges are provided: 0 to  $\pm 1$  volt, 0 to  $\pm 10$  volts, and 0 to  $\pm 100$  volts. An accurate 10-turn potentiometer is used to select the comparison voltages over these ranges.

### Comparison Voltage Regulator

A regulator circuit maintains comparison voltages essentially constant and independent of normal power supply voltages supplied by the oscilloscope.

## Specifications — Type Z

### Comparison Voltage Accuracy

- Within 5 millivolts (0.5%) on the  $\pm 1$ -volt range.
- Within 20 millivolts (0.2%) on the  $\pm 10$ -volt range.
- Within 150 millivolts (0.15%) on the  $\pm 100$ -volt range.

### Maximum Trace Shift

- 2 mm due to input grid or gas current.

### Comparison Voltage Drift

- Less than 0.1% per 100 hours operation.
- Temperature compensated over normally expected temperature range. Air filter in oscilloscope should be maintained clean, particularly when using the Z Unit.

### 10-Turn Potentiometer Linearity

- 0.05%

### Measurement Resolution

- Resolution accuracy, at 100-volts comparison voltage—0.005%.
- Maximum resolution—5 millivolts per millimeter.

### Transient Response and Permissible Signal Voltage Rate of Change

- Rate of rise—1 volt per 6 nsec, maximum. If this rate is exceeded, grid current will flow in the input stages.
- Rate of fall—1 volt in 5 nsec, maximum. If this rate is exceeded, the amplifier will momentarily cut off. If overdriven by a sufficiently fast pulse, the amplifier will "run down" linearly at the above rate.
- Because of the wide dynamic amplitude capabilities of the Z Unit, transient response is a function of signal amplitude.

### Mechanical Specifications

- Construction—Aluminum-alloy chassis.
- Front panel—Photo-etched.
- Net weight—6 pounds.

### Accessories

- 2—Instruction Manuals

# OPERATING INSTRUCTIONS

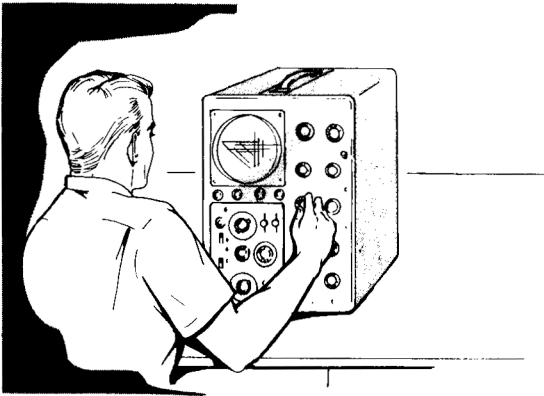

**Front Panel**

A front-panel view of the Type Z Unit is shown in Fig. 2-1. In addition, a brief functional description is given of the front-panel controls, input connectors, Securing Rod, and Mechanical Lock.

## Connecting the Z Unit to the Oscilloscope

Connect the Z Unit to the associated oscilloscope by inserting the unit into the plug-in compartment and tightening the Securing Rod. With the Intensity control of the oscilloscope turned fully counterclockwise, switch on the oscilloscope power. Normally it is necessary to wait a few minutes for the oscilloscope and plug-in to warm up and stabilize. Then turn up the intensity and set the oscilloscope triggering controls to produce a free-running sweep. Position the trace on the screen using the POSITION control and the oscilloscope beam-position indicators.

## Preliminary Operational Adjustments

After the Z Unit has warmed up and stabilized, check its operation to see if adjustment of one or more of the following controls is necessary. Be sure that the oscilloscope used in conjunction with the Z Unit is correctly calibrated in the vertical-deflection circuit, and that the calibrator output voltage is correct.

### 1. Amplifier DC Balance

If the trace cannot be centered on the screen when the POSITION control is set near midrange, the AMP DC BAL adjustment (see Fig. 2-2) must be checked. Need for this adjustment arises mostly when the Z Unit is transferred from one oscilloscope to another. To make the adjustment, set the POSITION control to midrange, remove the left side panel from the oscilloscope, and adjust the AMP DC BAL control to position the trace behind the horizontal centerline of the graticule.

### 2. Differential Balance

Differential balance may be quickly checked by applying 100 volts of calibrator signal to both input connectors. Set both VOLTS/CM switches to .05, the AC-DC switches to DC, and the Mode switch to A-B DIFF. Ignoring the positive and negative spikes, adjust the DIFF. BAL. control to elimin-

ate any square-wave response (that is, to obtain a straight-line appearance of the trace).

### 3. Variable Attenuator Balance

Any vertical shift of the oscilloscope trace when the VAR. ATTEN. control is rotated, with no input signal applied, indicates need for adjustment of the variable attenuator balance. This adjustment must be made in conjunction with the differential balance adjustment (step 2) due to interaction between the circuits. Repeat the two adjustments until both are correct.

Set the Mode switch to A ONLY and remove any input signals. Adjust the VAR. ATTEN. BALANCE control to eliminate any vertical shift of the crt trace as the VAR. ATTEN. control is rotated. Check to see if the trace can be centered as described in step 1 (Amplifier DC Balance). If not, repeat step 1.

### 4. Gain

The gain adjustment should be checked periodically to assure correct vertical deflection factors. It should also be checked when the Z Unit is transferred from one oscilloscope to another. The adjustment is made using the calibrator signal from the oscilloscope.

Set the Mode switch to A ONLY and apply 200 millivolts of calibrator signal to the A input connector. Make sure the VAR. ATTEN. control is set fully clockwise. Set the A VOLTS/CM switch to .05 and rotate the GAIN ADJUST control for exactly 4 centimeters of vertical deflection.

## Input Signal Connections

It is often possible to make signal connections to the Z Unit with short-length, unshielded test leads. This is particularly true for high-level, low-frequency signals. When such test leads are used, you must also use a ground connection between the oscilloscope and the chassis of the signal source. (Note: Excessively long test leads may cause parasitic oscillations.)

In many applications, however, unshielded leads are unsatisfactory for making signal connections because of pickup resulting from magnetic fields. In such cases, shielded cables should be used. You must be sure that the ground conductors of the cables are connected to the chassis of both the oscilloscope and the signal source.

In high-frequency work it is usually necessary to terminate signal sources and connecting cables in their characteristic

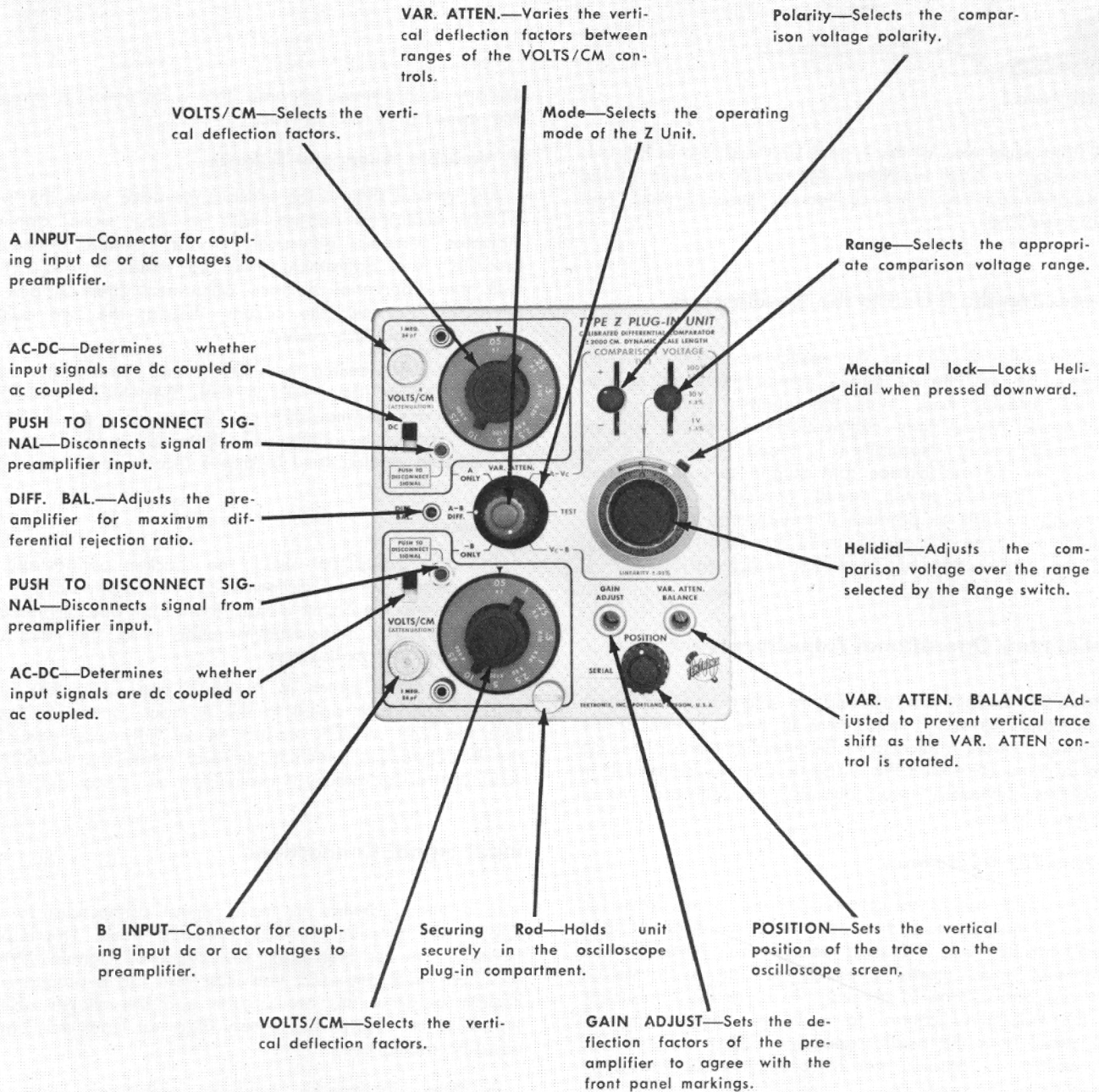

Fig. 2-1. Functions of front-panel controls, input connectors, Securing Rod, and Mechanical Lock.



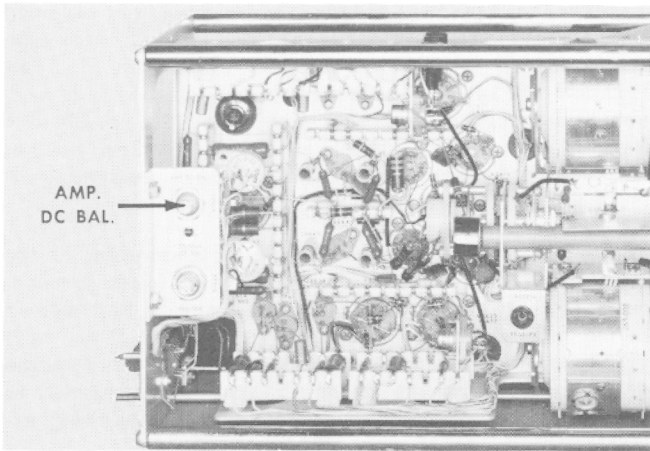

Fig. 2-2. Left rear side view of the Z Unit showing location of the AMP DC BAL adjustment.

impedances. Unterminated connections result in reflections in the cables and cause distortion of the displayed waveforms.

When input signal connections are made, consider the effect of loading upon the signal source due to the input circuit of the Z Unit. The input resistance of the Z Unit is 1 megohm which is generally adequate to limit low-frequency loading to a negligible value. At high frequencies, however, the input capacitance of the Z Unit and the distributed capacitance of cables become important. Capacitive loading at high frequencies may be sufficient to adversely affect both the displayed waveform and the operation of the signal source. Both capacitive and resistive loading can usually be limited to negligible values through use of attenuator probes.

### Use of Probes

Attenuator probes reduce loading of the signal source. However, in addition to providing isolation of the oscilloscope from the signal source, an attenuator probe also decreases the amplitude of the displayed waveform by the attenuation factor of the probe. When making amplitude measurements with an attenuator probe, be sure to multiply the observed amplitude by the attenuation of the probe. (Additional information concerning probe attenuation will be found under Differential Preamp Operation and Attenuator Test Point portions of this section of the manual.)

An adjustable capacitor in the probe body compensates for variations in input capacitance from one instrument to another. To assure the accuracy of pulse and transient measurements, this adjustment should be checked frequently.

To make this adjustment, set the oscilloscope calibrator controls for a calibrator output signal of suitable amplitude. Touch the probe tip to the calibrator-output connector and adjust the oscilloscope controls to display several cycles of the waveform. If the probe cable is connected to the A input connector on the Z Unit, adjust the probe capacitor for flat tops on the calibrator square wave. If it is connected to the B input connector, adjust for a flat bottom on the square wave.

### Conventional Preamp Operation

When the Z Unit is used for conventional preamp operation, the Mode switch should be placed in either the A ONLY or the —B ONLY position. Input signals should then be connected to the corresponding input connector. Operation of the unit in the two positions is essentially the same except that signals applied to the B input connector are inverted on the display. Positive voltages produce an upward deflection when applied to the A input connector and a downward deflection when applied to the B input connector (see Fig. 2-3).

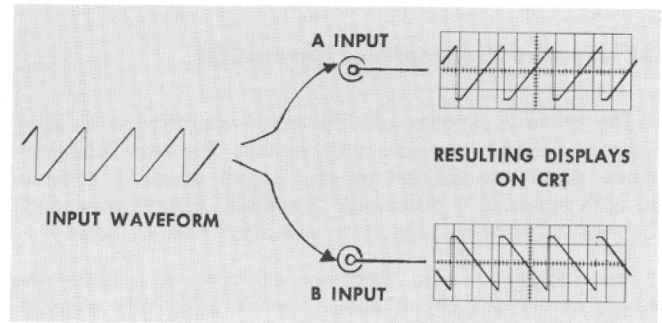

Fig. 2-3. Waveforms applied to the A Input connector produce an upright display, while waveforms applied to the B Input are inverted.

The amount of vertical deflection produced by a signal is determined by the settings of the VAR. ATTN. control and the VOLTS/CM switch. Calibrated deflection factors indicated by the settings of the VOLTS/CM switch apply only when the VAR. ATTN. control is set fully clockwise. Serious errors in display measurements may result if the setting of this control is inadvertently moved away from the fully clockwise position.

The range of the VAR. ATTN. control is approximately 2.5 to 1 to provide continuously variable (uncalibrated) vertical-deflection factors between calibrated settings of the VOLTS/CM switches.

Voltage measurements may be made directly from the oscilloscope screen by noting the deflection factor on the appropriate VOLTS/CM switch dial, and the amount of deflection on the screen. Then multiply the deflection on the screen by the setting of the VOLTS/CM switch and the attenuation factor, if any, of the probe.

Placing the AC-DC switch in the AC position inserts a dc blocking capacitor in series with the input circuit. In the AC position, the input time constant is 0.1 second and the low-frequency response is  $-3$  db at 2 cps. Thus some attenuation exists even at 60 cps. Because the input dc signal may be suppressed by means of the calibrated comparison voltage feature, there are few occasions where the ac-coupling mode will be needed. Two principle occasions are: (1) When it is desired to get a quick look at the ac component of a signal which has a large dc component and (2) where there is a difference in dc levels of the two signals to be observed during differential mode of operation.

The tolerances of the input circuit time constants (at  $-3$  db frequency) are nominally  $\pm 2\%$ . When tighter

## Operating Instructions — Type Z

matching between A and B input circuits is necessary, one input dc blocking capacitor may be "padded" with a small additional capacitance, generally less than 0.001  $\mu$ fd.

The PUSH TO DISCONNECT SIGNAL buttons allow the signal to be momentarily removed from the input without the bother of disconnecting the probe or coaxial input connector. This provides an easy method for finding the base-line of zero voltage level on the crt. (When utmost accuracy in measurement is required, trace deviation from exact zero due to gas or grid current must be considered.) The POSITION control may then be adjusted to make the zero level lie at any graticule mark desired.

### Differential Preamplifier Operation

The primary purpose of differential operation is to eliminate undesirable common-mode signals. The term "common-mode signal" is defined as that signal which is common to both inputs of a differential amplifier. It most commonly, but not necessarily, represents unwanted hum or noise.

This feature can be used, for example, to observe the signal across one circuit element while effectively eliminating the remainder of the circuit from the observations. This is accomplished by connecting the signal at one end of the element to one input of the Z Unit and the signal at the other end of the element to the other input of the unit.

Differential operation between the two inputs is obtained when the Mode switch is in the A-B DIFF. position. Maximum common-mode rejection is obtained when both input attenuators are set to X1. Common-mode rejection is a function of frequency in practical amplifiers. It is 40,000 to 1 for dc common-mode signals in the Z Unit and remains near that value through audio frequencies, decreasing as the frequency increases.

The differential or common-mode rejection ratio of the Z Unit describes the ability of the unit to reject common-mode signals. Common-mode rejection ratio is best defined as the ratio of amplifier response to that part of the input signal not common to both, with respect to the response of the amplifier to any input signal which is common to both inputs. It is defined numerically in the following example.

If an input signal consists of 100 volts (p-p) of 60-cps hum and 0.1 volt of desired signal, the 100-volt hum would cause

$$\frac{1}{.05 \text{ volts/cm}} \text{ times } 100 \text{ volts or } 2000 \text{ cm of deflection, and}$$

the signal would cause an additional 2 cm of deflection. If conventional preamplifier operation were used, the desired signal would be deflected off the screen and could not be observed. However, if differential operation is used and common-mode rejection were 2000 to 2 or 1000 to 1, then the hum and desired signal would each produce 2 cm of deflection. The resulting combined wave-

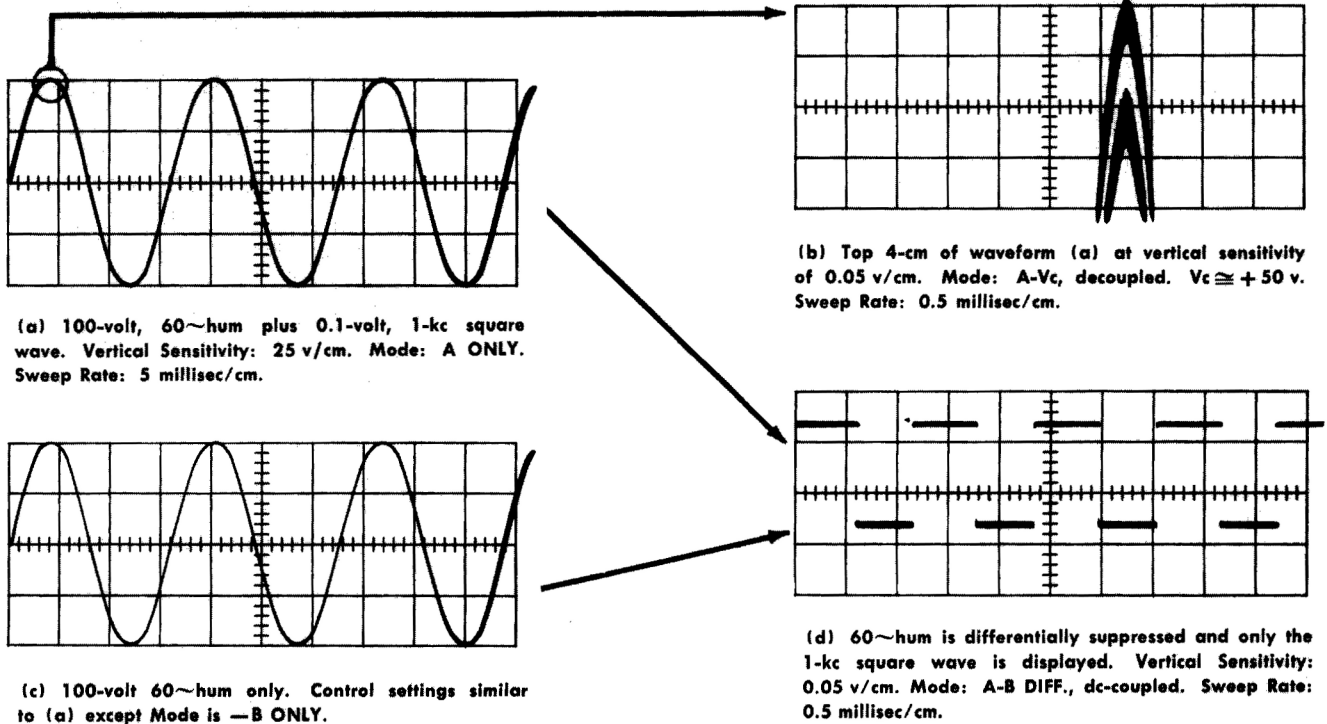

Fig. 2-4. Common-mode rejection by the Z Unit.

form could be seen but not easily measured. With a common-mode rejection of 40,000 to 1, the hum would be reduced to 0.5 mm and the desired signal alone could be accurately observed and measured.

The preceding example is shown pictorially in the series of waveform photographs shown in Figs. 2-4(a), (c), and (d). A combined 100-volt hum and 0.1-volt square-wave signal is shown in Fig. 2-4(a). Although the square wave does not seem to be present, it can be made visible by increasing the sensitivity of the Z Unit to 0.05 volts/cm, which increases the effective height of the waveform to 2000 cm. A dc comparison voltage (using differential comparator operation explained later in this section) of approximately 50 volts is used to bring the top 4-cm portion of the combined signals into view, shown by the waveform photograph in Fig. 2-4(b). The 2-cm high square-wave signal, riding on top of the hum but not synchronized with it, causes the separated appearance of the hum signal. Fig. 2-4(c) shows the 100-volt (p-p) hum signal which, by itself, is applied to the B input connector. The resulting display using common-mode rejection is shown in Fig. 2-4(d).

The following five operational notes provide helpful information to obtain optimum performance from the Z Unit using this mode of operation.

1. Large signal response of the Z Unit as a differential amplifier is shown in Table 2-1.

TABLE 2-1

Signal Handling Capabilities of the Z Unit				
Attenuation	Maximum Calibrated Sensitivity (volts/cm)	Minimum Uncalibrated Sensitivity (volts/cm)	Maximum Signal or Common Mode (volts)	Magnification Factor
X1	.05	.12	100	2000X
X2	.1	.24	200	1000X
X5	.25	.6	500	400X
X10	.5	1.2	1000*	200X
X20	1	2.4	1000*	100X
X50	2.5	6	1000*	40X
X100	5	12	1000*	20X
X200	10	24	1000*	10X
X500	25	60	1000*	5X

\*Maximum continuous dc input level with AC-DC switch set to DC: 800 volts; momentary maximum dc level should not exceed 1000 volts.

2. Any difference in attenuation factors of the two attenuators (VOLTS/CM switches) will decrease the differential capabilities of the Z Unit to the extent shown in Table 2-2.

3. Both AC-DC switches should be in the DC position if possible as explained under Conventional Preamplifier Operation.

4. Differential balance may decrease slightly as the VAR. ATTEN. control is adjusted away from the calibrated (clockwise) position.

5. Either input signal alone may be viewed without switching back to the A ONLY or —B ONLY positions of the Mode switch by depressing the PUSH TO DISCONNECT SIGNAL button of the other input channel.

TABLE 2-2

Attenuator Performance		
Attenuation	Attenuator Accuracy, ± %	Input Resistance Tolerance, ± %
X1	0	1
X2	1	1
X5	1.5	1
X10 and up	2	1

If conventional probe is used, the probe resistor tolerance of 1% decreases the Z Unit attenuator accuracy. These inaccuracies can be accurately measured as explained later under Attenuator Test Point.

### Calibrated Differential Comparator Operation

When the Mode switch is in the A-Vc or Vc-B position, the Z Unit is a calibrated differential comparator or slide-back voltmeter. The calibrated comparison voltage, which has a range of 0 to 100 volts, may be added (differentially) to either input signal.

In this mode a calibrated dc voltage is internally applied to cancel out any unwanted dc component in the applied signal, thereby allowing accurate measurements of relatively small ac signals riding on top of relatively large dc signals.

When the Mode switch is in the A-Vc position, the comparison voltage is applied internally to the amplifier input where the B signal is ordinarily applied during differential mode of operation. The switches and input connector in the —B ONLY section of the front panel are not used. Signals applied to the B input connector will not be observed.

In Vc-B position of the Mode switch, the comparison voltage is applied to the amplifier input where the A input signal is normally applied during differential mode of operation. All switches and the input connector in the A ONLY section of the front panel are not used.

The dc comparison voltage is set by 3 controls: the COMPARISON VOLTAGE Polarity, Range, and Helidial. The Range control has ranges of 0 to 1, 0 to 10, and 0 to 100 volts. The Helidial varies the comparison voltages over this range and indicates the precise comparison voltage at any particular setting.

#### NOTE

The regulator circuit in the Z Unit maintains constant, accurate, comparison voltages as long as the oscilloscope —150- and +225-volt power supplies are in regulation and within their output voltage tolerance ratings. Be sure these and other regulated power supplies in the oscilloscope are operating properly.

Differential comparator mode of operation may be used to make the following voltage measurements: (1) dc voltage measurements, (2) ac signal measurements superimposed on dc, and (3) high-amplitude ac signal measurements.

## Operating Instructions — Type Z

### 1. DC Voltage Measurements.

When the Z Unit is used to make any dc voltage measurements, it is first necessary to establish a reference line on the screen of the oscilloscope. This line will usually be the horizontal centerline of the graticule. To establish the reference, set the COMPARISON VOLTAGE Polarity switch to 0 and press the appropriate PUSH TO DISCONNECT SIGNAL button to disconnect the input signal. (As noted previously under Conventional Preamplifier Operation, slight trace deviation from exact zero must be taken into account to obtain best accuracy.) Use the POSITION control to set the oscilloscope trace at the centerline of the graticule.

To measure a dc voltage component of  $\pm 100$  volts or less, apply the input signal to one of the connectors. For example, suppose the signal is applied to the A input connector, then proceed as follows:

(a) Place the A VOLTS/CM switch to .05 and the Mode switch to the A-Vc position.

(b) If the dc voltage component to be measured is positive, place the COMPARISON VOLTAGE Polarity switch to the + position. If it is between 10 and 100 volts, set the COMPARISON VOLTAGE Range switch to 100 V.

(c) Rotate the COMPARISON VOLTAGE Helidial to bring the desired portion of the trace onto the screen. Set the trace exactly on the reference line with the Helidial.

(d) Recheck the reference as described in the first paragraph.

(e) When the zero reference line and signal trace appear at the same place on the screen, the input voltage and the comparison voltage are equal.

### 2. AC Signal Measurements Superimposed on DC

Small ac signals superimposed on a dc component can be measured accurately by first using the comparison voltage to effectively eliminate the dc component. The ac signal can then be measured in the same manner as in conventional preamplifier operation. The VAR. ATTEN. control must be kept clockwise to obtain correct results.

### 3. High-Amplitude AC Signal Measurements.

High-amplitude ac signals, subject to the rise rate and fall rate limitations listed in the Specifications section, can also be measured with the Z Unit at maximum sensitivity. This type of measurement is very similar to dc measurements except that it is not necessary to establish a zero voltage reference line unless measurements of both ac and dc voltage levels are to be made. To measure the voltage difference between two points on the waveform, proceed as follows:

(a) Set the Helidial to zero and position one point on the waveform to the horizontal centerline of the graticule.

(b) Use the Helidial and Range controls to bring the other desired point to the centerline.

(c) The voltage difference between the two points is read from the Helidial and the setting of the Range switch.

### AC-DC Voltage Measurements Exceeding $\pm 100$ Volts.

If ac, dc, or both ac and dc voltage components are greater than  $\pm 100$  volts, the .05 settings of the VOLTS/CM switches cannot be used. It will be necessary to use a lower sensitivity in order to prevent overdriving the preamplifier and to prevent exceeding the comparison voltage available. To obtain the correct voltage measurement, use the multiplication factor which appears below the volts per centimeter setting on the VOLTS/CM knob. The product of the multiplication factor times the comparison voltage used is the input signal voltage.

### ATTENUATOR TEST POINT

Two applications included here show how the ATTEN TEST PT connector, located on the left side of the Z Unit, can be used to make attenuation factor or ratio checks on probes used with the Z Unit and on the internal attenuators of the unit. The test point, when connected to a voltage divider network under test, forms a bridge circuit as shown in Fig. 2-5. The crt is the null indicator and the Helidial reading is used to determine the attenuation factor or ratio of the divider resistors.

A third application describes how the unit may be used to measure external resistors.

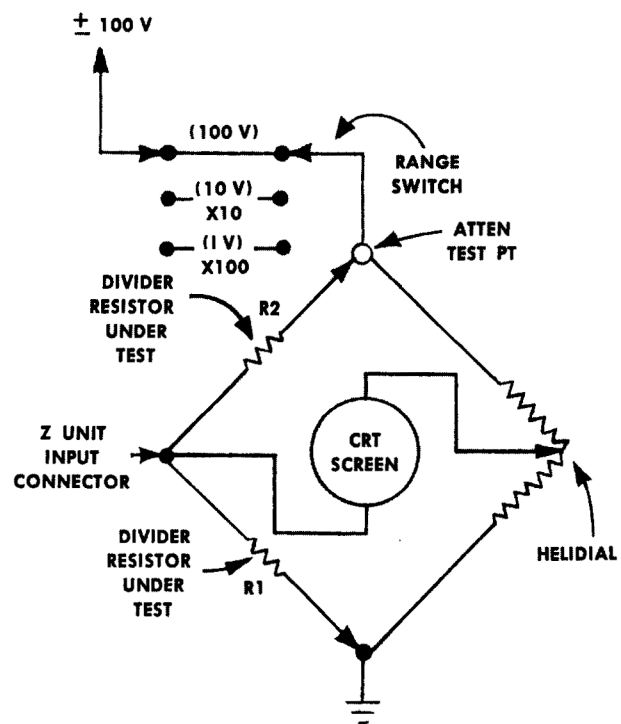

Fig. 2-5. Simplified diagram of the bridge circuit formed during use of the ATTEN TEST PT connector.

## Checking Attenuation Accuracy of VOLTS/CM Switches

The attenuation accuracy of the X2, X5, X10, and X20 positions of the VOLTS/CM switches can be determined by utilizing the 100-volt comparison voltage available at the ATTEN TEST PT connector. The following procedure explains how to check the X2 position of the A VOLTS/CM switch. The other positions are checked in the same manner.

1. Set the A VOLTS/CM switch to X2, the AC-DC switch to DC, and the Mode switch to A-Vc.
2. Place the COMPARISON VOLTAGE Polarity switch to 0 and position a free-running trace to the center of the screen for reference.
3. Remove the left side panel from the oscilloscope. Connect a test lead from the A input connector to the ATTEN TEST PT connector (see Fig. 2-6).

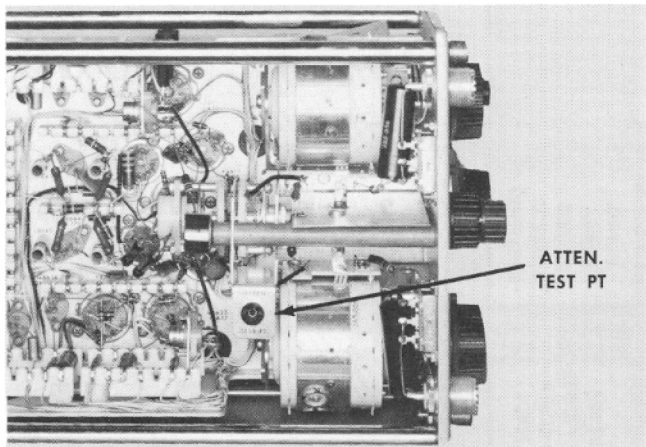

Fig. 2-6. Left side view of the Z Unit showing the location of the ATTEN TEST PT.

### CAUTION

Use care in making the test lead connections to prevent shorting the 100 volts at the ATTEN TEST PT to ground. An accidental short circuit may damage the CAL. 4 adjustment (R7684).

4. Set the COMPARISON VOLTAGE Polarity switch to + and the Range switch to 100 V.
5. Rotate the Helidial to return the trace to the reference level obtained in step 2. Use the vertical trace indicator lights to aid in returning the trace. In this example the Helidial should end up in the vicinity of 5.00 (or 50 volts).
6. Divide the Helidial reading into 10 to obtain the attenuation factor. (Assume the Helidial reading to be 5.02. 5.02 divided into 10 is 1.99 or an attenuation factor of X1.99. The attenuation ratio is 1.99 to 1).

## Checking Attenuation Accuracy of Probes

Passive attenuator probes can be checked for attenuation accuracy by a method similar to that used for determining the VOLTS/CM attenuation accuracy. Referring to Fig. 2-5,

divider resistor R1 is the 1-meg input resistor in the oscilloscope, R2 is the resistor in the probe. The procedure which follows describes a method for checking a 10X attenuator probe.

1. Set the A VOLTS/CM switch to X1, the AC-DC switch to DC, and the Mode switch to A-Vc.
2. Place the COMPARISON VOLTAGE Polarity switch to 0 and position a free-running trace to the center of the screen for reference.
3. Remove the left side panel from the oscilloscope (if not already removed). Connect the probe cable connector to the A input connector on the Z Unit and connect the probe tip to the ATTEN TEST PT.
4. Set the COMPARISON VOLTAGE Polarity switch to + and the Range switch to 100 V.
5. Rotate the Helidial to return the trace to the reference level obtained in step 2. In this example the Helidial should end up near a reading of 10 volts.
6. Divide the Helidial reading into 100 to obtain the attenuation factor of the probe.

## Checking External Resistors

External resistors can be checked for value against the 1-megohm input resistance of the unit by using the bridge circuit of Fig. 2-5. In this application, R2 is the resistance to be measured and R1 is the internal 1-megohm resistor.

The following procedure can be used:

1. Set the A VOLTS/CM switch to X1, the AC-DC switch to DC, and the Mode switch to A-Vc.
2. Place the COMPARISON VOLTAGE switches to 0 and 100 V. Position a free-running trace to the center of the screen for reference.
3. Remove the left side panel of the oscilloscope. Connect one end of R2 to the A input connector and the other end to the ATTEN TEST PT (see Fig. 2-6) by using a jumper wire.
4. Set the COMPARISON VOLTAGE Polarity switch to +.
5. Adjust the Helidial to return the trace to the reference level obtained in step 2. Use the vertical trace indicator lights to aid you in returning the trace.
6. Let H be the Helidial reading. Then use the following equation to find the value of R2.

$$R2 = R1 \frac{10 - H}{H} = \frac{10 - H}{H} \text{ Megohms.}$$

If R2 is small compared to 1 megohm, the Helidial reading will be very close to 10.00 making it difficult to obtain an accurate measurement. When this occurs, R1 can be shunted by an accurate external resistor which will permit Helidial readings around 5.00. The only restriction on the shunting is that the total resistance to ground from the ATTEN TEST PT should not be less than 20 k. This limits the current drawn from the test point to a maximum of 5 ma. If the 1-megohm resistor is shunted, R1 in the equation will have to be changed to the new value of the 1-megohm and shunt resistors in parallel.

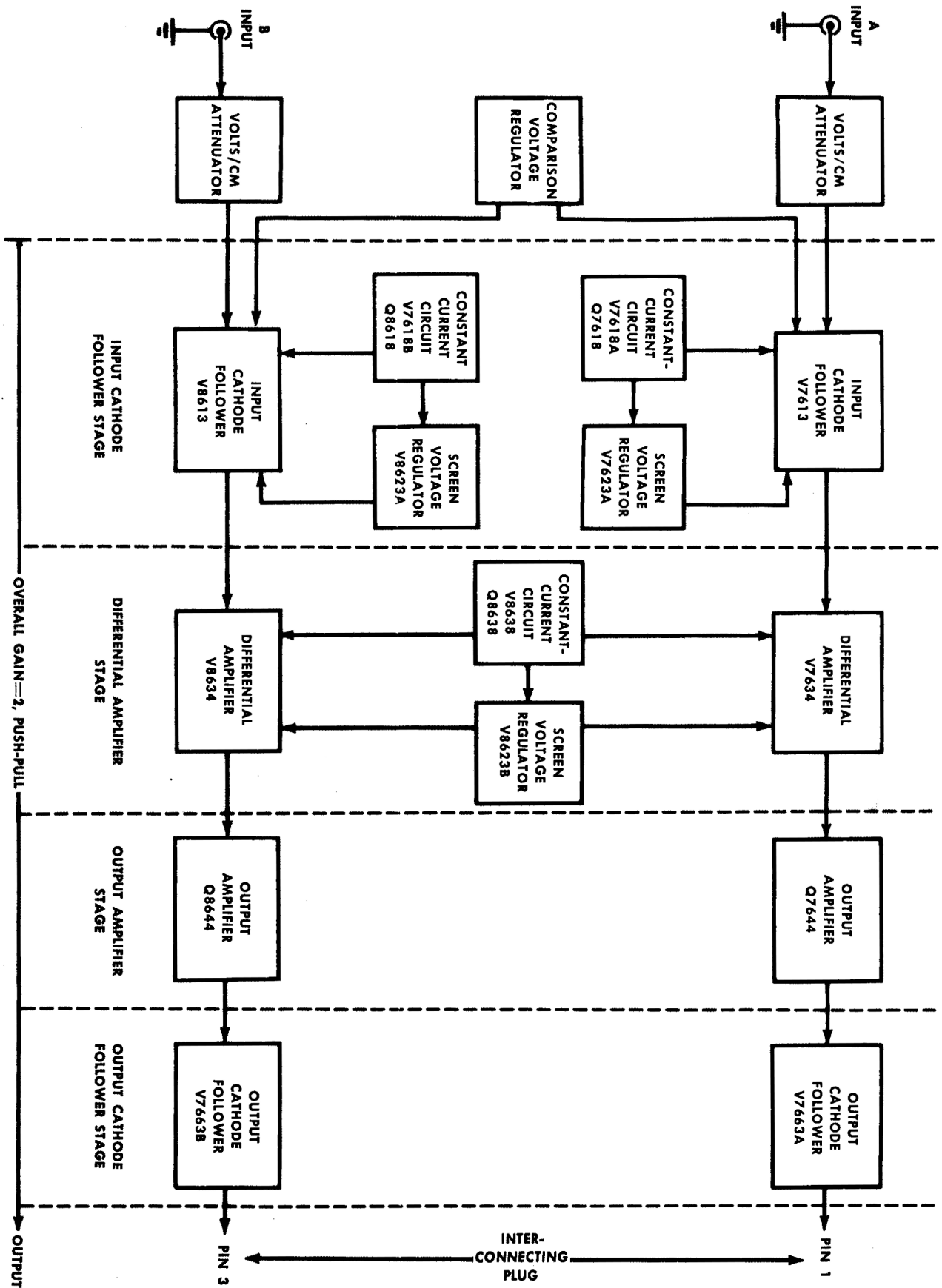
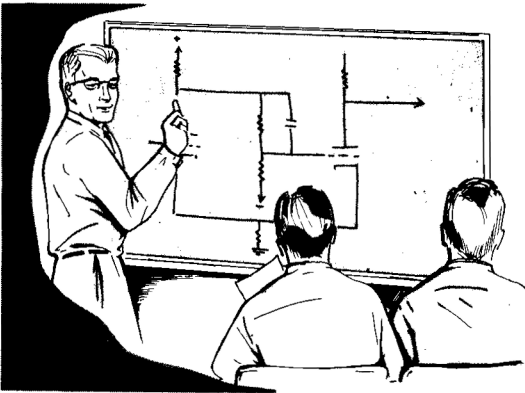

Fig. 3-1. Type Z Plug-In Unit block diagram.

CIRCUIT  
DESCRIPTION

## BLOCK DIAGRAM DESCRIPTION

Fig. 3-1 shows the block diagram for the Type Z Unit. Signals applied to A Input and B Input connectors pass through the VOLTS/CM Attenuator switches to the grids of the tubes in the Input Cathode Follower stage. The VOLTS/CM switches insert frequency-compensated attenuators into the circuit. When properly adjusted the input resistance and capacitance of the unit remains unchanged as the attenuators are inserted.

Accurate  $\pm$ DC comparison voltages are obtained from the Comparison Voltage Regulator. These can be applied to the grid of either Input Cathode Follower stage by means of a Mode switch. These voltages add differentially to the signal applied to the other Input Cathode Follower when differential-comparator mode of operation is used.

The low-capacitance, high-impedance input of the Cathode Follower stage isolates the input circuitry from the amplifier stages. The Input Cathode Followers are required to handle input signal voltages as great as  $\pm 100$  volts, without distorting. Special Constant-Current circuits prevent the cathode followers from cutting off or drawing grid current with large signals. Screen Voltage Regulator circuits maintain a constant voltage between the cathode and screen grid of the cathode followers. The Constant-Current and Screen-Regulator circuits permit the cathode followers to handle large signals without operating nonlinearly.

The output of the Input Cathode Followers is applied to the control grids of the Differential Amplifier stage. This stage also employs a Constant-Current circuit and a screen Voltage Regulator to permit the stage to handle large signals without distortion.

The output of the Differential Amplifier stage is applied to the bases of the transistors in the Output Amplifier stage.

Signals from the Output Amplifier stage are applied through voltage dividers to the Output Cathode Follower stage. The voltage dividers provide the proper dc operating voltages at the grids of the Output Cathode Follower stage. Output signals from this stage are then applied to the input of the oscilloscope main vertical amplifier through pins 1 and 3 of the interconnecting plug. Overall gain of the preamplifier is 2, push-pull.

You may wish to refer to the schematic diagram located near the rear of the manual and the block diagram of Fig. 3-1 during the following discussion.

## DETAILED CIRCUIT DESCRIPTION

## Comparison Voltage Regulator

Regulation of both the + and - comparison voltages is necessary to maintain specified voltage accuracy. This regulation system makes the comparison voltage independent of differences in regulated power supply voltages from one oscilloscope to another.

The comparison voltage is developed across V7689, a highly stable gas tube, type OG3. Because the drop across the tube is less than 100 volts, three zener diodes are placed in series to increase the reference voltage to slightly more than 100 volts. In addition to increasing the total voltage drop in the circuit, the zener diodes provide temperature compensation for V7689.

A constant-current source of 6 ma is required to maintain a constant voltage across the gas tube, V7689. For the -100-volt comparison voltage reference the 6 ma is provided by a constant-current transistor, Q8674, which operates as a common-base amplifier. The base voltage is established with respect to the -150-volt supply by zener diode D8679. Since the base-to-emitter voltage of Q8674 is essentially constant, the current through the transistor is determined and maintained constant by the voltage across resistors R8673 and R8674. By adjusting R8674, the current through V7689 is set to the specified 6 ma. Transistor Q8672, a diode-operated 2N1102, provides temperature compensation for Q8674.

For the +100-volt reference, a constant current of 6 ma is furnished by Q7674 in conjunction with zener diode D7675 and resistors R7670 and R7671. This circuit operates similar to the -100-volt reference previously explained.

As the COMPARISON VOLTAGE Polarity switch is moved from + position to - position, it is important that the load on transistors Q8674 and Q7674 remain the same. In the + and 0 positions, the current from the negative current regulator, Q8674, passes through R8670 instead of the gas tube and associated zener diodes. In the - position, the current from the positive current regulator, Q7674, passes through R8670. In calibration, the voltage at Test Point A is set equal to the voltage at Test Point B in all positions of the polarity switch, so that a constant load is always presented to Q7674 and Q8674. The voltage is then applied across the COMPARISON VOLTAGE potentiometer, R7686.

The voltage applied across potentiometer R7686 must be exactly 100 volts. Since the voltage obtained by the

## Circuit Description — Type Z

drop across V7689 and the zener diodes is slightly more than 100 volts, R7684 and R7685 (if needed) reduce the potential to the exact amount required.

The precision voltage dividers consisting of R7687A and R7687B (X10), and R7687C and R7687D (X100), reduce the comparison voltage from 100 volts to either 10 volts or 1 volt by means of the COMPARISON VOLTAGE Range switch.

## Input Cathode Follower Stage

Signals applied to input connectors A and B of the Type Z Unit go to the AC-DC switches which either include, or short across, the coupling capacitors. The signals then pass through the PUSH TO DISCONNECT SIGNAL switches, the VOLTS/CM switches, and the Mode switch, SW7611. The signals are then impressed upon the grids of the input cathode followers, V7613 and V8613.

The wide dynamic range of the Type Z Unit requires constant-current operation of both the Input Cathode Follower stage and the Differential Amplifier stage. Another requirement is that screen-to-cathode voltages remain constant in both stages. Transistor Q7618 is the constant-current source for both V7618A and input cathode follower V7613. This transistor operates as a common-base amplifier. Its base is held approximately 6 volts above the  $-150$ -volt supply by zener diode D8679 (see Note, below).

### NOTE

When reference to the  $-150$ -volt supply is made, the actual typical voltage measurement is  $-144$  volts at pin 9 of the interconnecting plug in all oscilloscopes using a decoupling network in the main oscilloscope.

The base-to-emitter voltage is essentially constant, the base being a few tenths of a volt more positive. With base and emitter voltages fixed, Q7618 operates at a constant current. Note that a variation in the  $-150$ -volt supply has little or no effect on the transistor bias. Thus no change occurs in either the base-to-supply drop or the base-to-emitter drop. Only the base-to-collector drop varies.

The voltage drop across zener diode D8679 sets the voltage drop between emitter and the  $-150$ -volt supply. A decrease in emitter resistance would require a greater current to establish the same fixed drop. Hence R7619 is the current control for Q7618, the constant-current source.

The collector current of Q7618 is slightly less than the emitter current, very nearly constant, and independent of the base-to-collector voltage. Such a circuit is very stable with respect to transistor parameters and temperature.

To describe the constant-current circuit of the Input Cathode Follower stage during peak operation, assume that an input voltage swing from  $-100$  to  $+100$  volts is applied to the grid of V7613. The cathode of V7613 and plate of V7618A follow the 200-volt swing. The cathode

of V7618A varies  $\frac{1}{\mu + 1}$  times the plate swing. In this

circuit, the cathode swings about 1/30 of the plate swing. Therefore the grid-cathode swing of V7618A is approximately 6.6 volts. The voltage swing is now low enough for direct coupling to the collector of Q7618 whose function is to provide the constant-current source for this half of the input stage. The voltage swing of 6.6 volts is easily handled by the transistor at its operating current of approximately 8 ma.

The effect of a transistor "long-tail" in the cathode circuit of V7618A is shown in Fig. 3-2. The top curve displays the constant-current characteristics of a 2N1302 transistor when connected similar to Q7618. The lower curve displays the constant-current characteristics of V7618A with Q7618 connected in its cathode circuit to control the current. For practical purposes, no measurable change in current occurs during these voltage excursions.

The grid of V7618A returns to the zener diode D8679 through a temperature-compensating diode-connected tran-

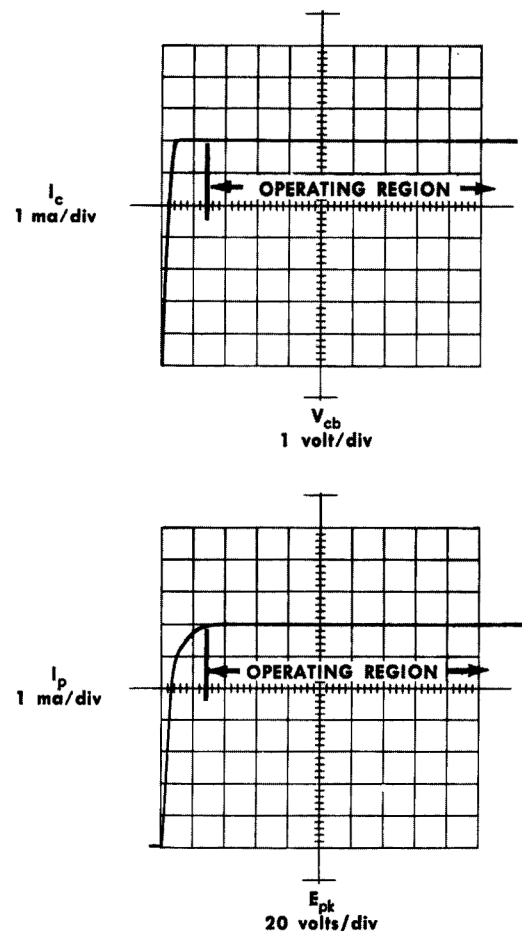

Fig. 3-2. Top: constant-current collector characteristics of 2N1302 transistor having a 1-k resistor in the emitter circuit; bottom: constant-current plate characteristics of 6DJ8 triode connected similar to V7618A. (Transistor display obtained from Tektronix Type 575 Transistor-Curve Tracer; triode display obtained from Type 570 Characteristic-Curve Tracer.)



sistor, Q8672. The bias of V7618A is the collector-to-base voltage of Q7618 plus the drop across Q8672.

The screen of the input cathode follower V7613 is connected back to its cathode through another cathode follower, V7623A, and zener diode, D7621. The screen voltage of V7613 will therefore follow variations in the cathode voltage (because it is "bootstrapped" to the cathode), approximately 105 volts above the cathode. Capacitor C7626 bypasses high-frequency components of the signal directly to the screen. C7621 and R7622 form a low-pass filter to remove zener noise from the screen of V7613.

The gain of the input CF's (V7613 and V8613) approaches unity because the impedance of the constant-current cathode "long-tail" approaches infinity, and because of the high and constant grid-screen  $\mu$ . The grid-screen  $\mu$  remains constant because of the constant screen-cathode potential. The most significant factor which reduces the gain of the stage below unity is the cathode-load resistors R7620, R7621, and R8621.

Slight circuit imbalances, principally in triode  $\mu$  and zener diode impedance, necessitate a balance control R7620. For all practical purposes, this control, plus R7621 and R8621, form the cathode load for the input cathode followers.

## Differential Amplifier Stage

Signals from the input cathode followers are applied to the grids of the Differential Amplifier stage, V7634 and V8634. The cathode circuitry of the stage consists of a constant-current circuit and a gain adjustment network. The constant-current circuit is formed by Q8638 and V8638 and is identical in principle, with one exception, to the operation of the circuits in the Input Cathode Follower stage. The exception is that one constant-current circuit supplies both tubes in this stage.

The amount of current supplied by the constant-current circuit is determined by the setting of the GAIN ADJUST control R8639. As screen-to-cathode voltage is maintained constant, R8639 controls the transconductance of V7634 and V8634, thereby controlling the gain of the stage. The control is set to provide the correct vertical deflection factors when the VAR. ATTEN. control R7633 is set fully clockwise. The VAR. ATTEN. control varies the gain of the Differential Amplifier stage by varying the cathode degeneration.

To prevent trace shift as the VAR. ATTEN. control R7633 is adjusted, the cathode potentials must remain equal. This is accomplished by proper adjustment of the VAR. ATTEN. BALANCE control R7619. Adjustment of R7619 varies the grid (and the cathode) voltage of V7634 and V8634 in opposite directions to compensate for slight differences in operating characteristics of the two tubes. Proper adjustment of R7619 will result in equal voltages at the cathodes of V7634 and V8634 for all positions of the VAR. ATTEN. controls.

As in the Input Cathode Follower stage, the screen voltage for the Differential Amplifier stage is "bootstrapped" 140 volts above the cathode. Because total cathode current, screen-to-cathode voltage, and the plate-to-screen current ratio remain constant, the plate currents of the Differential Amplifier stage respond only to differential signals.

The high-frequency response of the Differential Amplifier stage is improved by the use of series-shunt peaking in the plate circuits. This peaking is provided by L7632 and L8632.

The AMPLIFIER DC BAL. control R7640 adjusts the base voltage of Q7644 by forcing a small current through R7632. The control is used to dc balance the Output Amplifier Stage. Adjustment of R7640 forces the base of Q7644 to be at the same voltage as the base of Q8644 when no signal is applied to the unit.

## Output Amplifier Stage

Output signals from the Differential Amplifier stage are applied to the bases of Q7644 and Q8644, the Output Amplifier stage. This stage has a gain of slightly more than two. A large common emitter resistance provides a large amount of emitter degeneration and a high degree of stability and linearity. Transistors used in this stage have an advantage over a vacuum tube stage in two respects. The dc level is lowered instead of raised, and the swing of the amplifier in the oscilloscope is limited to no more than 12 centimeters deflection on the crt screen. The latter is important since rapid recovery from very large input voltages is essential. Series-shunt peaking in the collector circuit improves the high-frequency response of the amplifier.

## Output Cathode Follower Stage

Output signals from the Output Amplifier stage and positioning voltages from the POSITION control are applied to the grid circuits of the Output Cathode Followers. Compensated voltage divider networks at the input to the cathode followers lower dc levels to the proper level for driving the vertical amplifier of the oscilloscope. The dividers consist of resistors R7655 and R7656, R8655 and R8656; capacitors C7655 and C8655 compensate the attenuators for high frequencies.

The OUTPUT CF BAL. adjustment R7658 is used to provide dc balance for the output cathode followers. This insures that the input signals to the push-pull sides of the vertical amplifier of the oscilloscope are at equal average dc potentials.

The output cathode followers provide the necessary low impedance to drive the capacitance of the interconnecting plug and the input of the oscilloscope vertical amplifier. In addition, this stage isolates the plug capacitance from the Output Amplifier stage. The signal from the Output Cathode Follower stage is applied through the interconnecting plug to the input of the oscilloscope vertical amplifier.

## MAINTENANCE

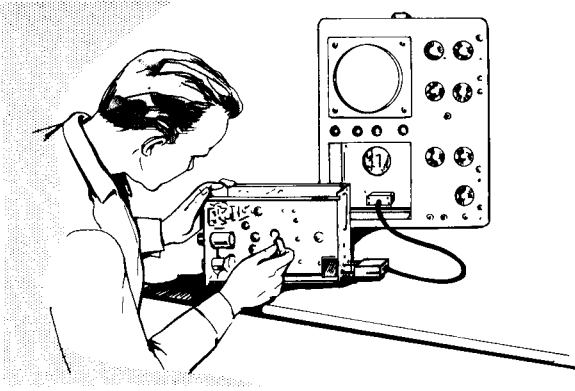

## PREVENTIVE MAINTENANCE

The Z Unit is a stable instrument, and will require complete calibration very infrequently. However, to be certain that the unit is operating properly at all times, the calibration of the unit should be checked after each 500-hour period of operation (or every six months if the unit is used intermittently). A complete step-by-step procedure for calibrating the unit and checking its operation is given in the Calibration section of this manual.

## Visual Inspection

Many potential and existent troubles can be detected by a visual inspection of the unit. For this reason, a complete visual check should be performed every time the unit is inoperative, needs repairs, or needs recalibration. Apparent defects may include loose or broken connections, damaged connectors, improperly seated tubes or transistors, scorched or burned parts, and broken terminal strips. The remedy for these troubles is readily apparent except in the case of heat-damaged parts. Damage to parts due to heat is often the result of other less apparent troubles in the unit. It is essential that the cause of overheating be found before replacing the damaged parts.

## COMPONENT REPLACEMENT

## General

Useful information concerning the replacement of important parts in the Z Unit is given in this portion of the manual. Because of its precision design, replacement of close tolerance components will require calibration of the unit to assure proper operation. Refer to the Calibration section of this manual for a complete procedure. If the steps in the procedure are to be performed out of sequence to get the repaired portion of the Z Unit calibrated, refer to the preceding portion of the procedure for more information about control panel settings and test equipment used.

## Switches

If a switch is found to be defective and needs to be repaired or replaced, use normal care in unsoldering and

disconnecting leads from the terminals. To remove some switches, such as the AC-DC, Polarity, and Range, the front overlay panel must be removed first to obtain access to the switch mounting screws.

Single wafers on wafer-type switches are not normally replaced. If a wafer is defective, the entire switch should be replaced. Some switches may be ordered from the factory either unwired or with parts wired in place, as desired. Refer to the Parts List to find the wired and unwired part numbers.

When soldering the leads to a wafer-type switch, do not let solder flow around and beyond the rivet on the switch terminal. Otherwise the spring tension of the switch contact may be destroyed.

## Turret Attenuators

To remove or to replace a component inside one of the VOLTS/CM turret attenuators, the following instructions are given:

1. To remove the turret, loosen the 0.050" allen set screw (see Fig. 4-1). Grasp the knob and pull it outward far enough to let the shaft free the turret. Do not pull the shaft too far out or it will not hold the detent wheel in position.
2. Remove the turret. Remove the end caps from the body of the turret to obtain access to the components.

## NOTE

When replacing any of the components inside the turret, the lead lengths and parts placement are **critical**. Duplicate the original lead lengths and the exact part placement. Use parts ordered from the factory to assure correct physical size and tolerance accuracy. Do not use excessive heat or let the soldering iron touch the white plastic part of the turret body. No attempt should be made to replace button capacitors C413E, C414E, or C415E. These parts are sweat-soldered in the outer metal ring to secure a low inductance grounding path. The ring is fitted to the body of the turret before the inside components are soldered into place. It is extremely unlikely that these capacitors will become defective. However, if a button capacitor needs to be replaced, order a replacement wired turret body from the factory.

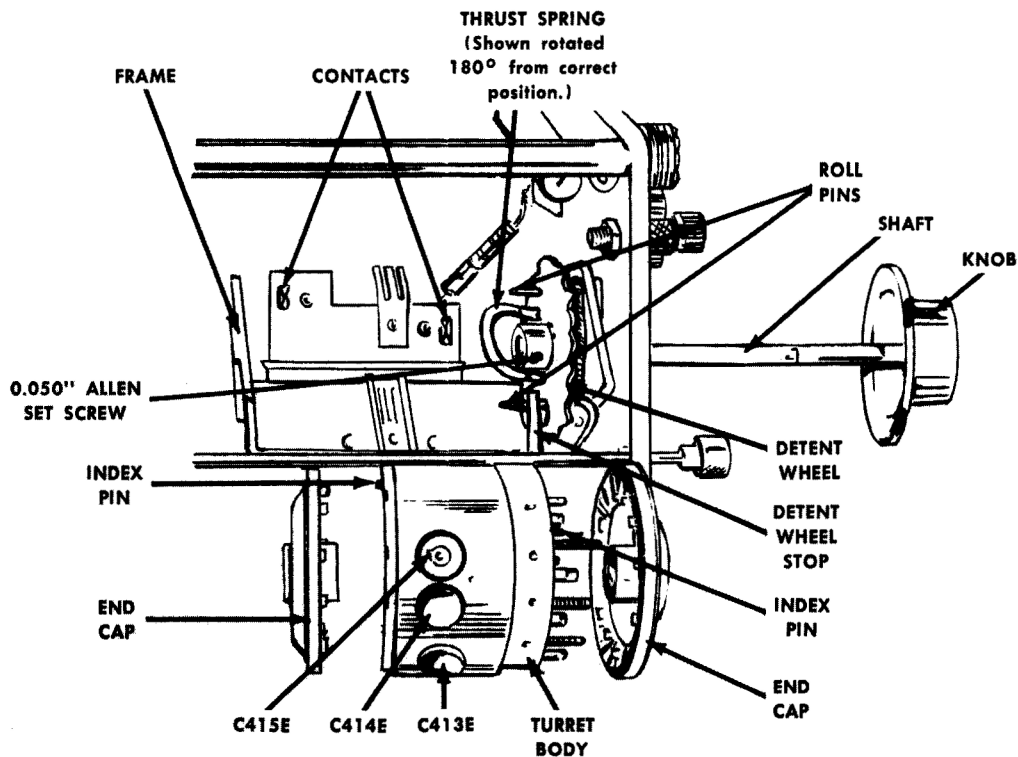

Fig. 4-1. B VOLTS/CM turret attenuator removed from the Z Unit.

3. To remount the turret body, align the holes in the end caps with the index pins. Fit the end caps to the turret body.
4. Note the setting of the knob and then rotate the knob so the bent ends rather than the open ends of the thrust spring will accept the turret.
5. Slide the turret into the frame. Make sure the contacts (indicated in Fig. 4-1) are aligned with the contacts on the turret.
6. Rotate the knob to its original setting. Slide the shaft through the turret and through the rear hole in the frame. Check alignment of contacts while carefully rotating the turret. Tighten the set screw.
7. If the bent ends of the thrust spring are not located between the roll pins, rotate the thrust spring around the shaft until it is properly positioned. When this is done, the bent ends of the spring will not strike the detent wheel stop as the turret is rotated.

If the entire VOLTS/CM turret attenuator is to be removed or replaced, the complete switch can be removed as a unit the same as a conventional rotary switch. When ordering a replacement switch, refer to the Parts List for the wired switch part number.

### Ceramic Terminal Strips

Damaged ceramic terminal strips are most easily removed by unsoldering all connections and then using a plastic

or hard rubber mallet to knock the yokes out of the chassis. This can be done by tapping on the ends of the yokes protruding through the chassis. When a new strip is ordered, the yokes are furnished with and are attached to the strip. New spacers need not be ordered because the original spacers can be used two or three times before they become too loose to hold the yokes securely.

When the damaged strip and yoke assembly have been removed, place the spacers for the new strip assembly into the holes in the chassis. Using a plastic or hard rubber mallet, tap the ceramic strip lightly above the yokes to drive the yoke pins down through the spacers. Be certain that the yoke pins are driven completely through. Using a pair of diagonal cutters, cut off the excess length of the yoke pins. Fig. 4-2 illustrates the way that the parts fit together.

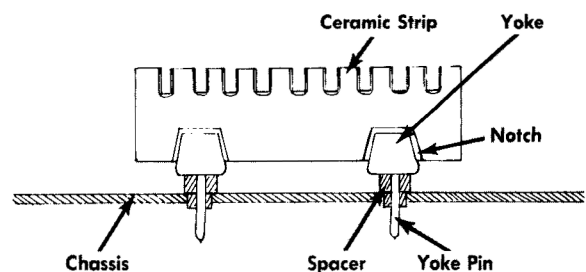

Fig. 4-2. Installation of ceramic terminal strips.

## Soldering Precautions

In the production of Tektronix instruments, a special silver-bearing solder is used to establish a bond to the ceramic terminal strips. This bond may be broken by the repeated use of ordinary tin-lead solder, or by the application of too much heat. Occasional use of ordinary solder will not break the bond however, if too much heat is not applied.

If continued maintenance work is to be performed on Tektronix instruments, it is advisable to have a stock of solder containing about 3% silver. This type of solder is used often for work on etched-circuit boards and should be readily available. It may also be purchased directly from Tektronix in one pound rolls (part number 251-514).

Because of the shape of the terminals on the ceramic terminal strips, the soldering iron should have a wedge-shaped tip. A tip such as this allows the heat to be applied directly to the solder in the terminals and reduces the amount of heat required. It is important to use as little heat as is possible. Do not use force or twist the tip in the slot as this may chip or break the ceramic strip.

## REPLACEMENT PARTS

### Standard Parts

Replacement for all parts used in the Type Z Unit can be purchased directly from Tektronix at current net prices. Many of the components, however, are standard electronic parts that can generally be obtained locally in less time than required to obtain them from the factory. Before purchasing a part, be sure to consult the Parts List to determine the tolerances and rating required. The Parts List gives the values, tolerances, ratings, and Tektronix part number of all components used in the instrument.

### Special Parts

In addition to the standard electronic components mentioned in the previous paragraph, special parts are also used. These parts are manufactured or selected by Tektronix to satisfy particular requirements, or are manufactured especially for Tektronix by other companies. These parts and most mechanical parts should be ordered directly from Tektronix since they are normally difficult or impossible to obtain from other sources. All parts may be obtained through your local Tektronix Field Engineering Office.

## TROUBLESHOOTING

### General Information

This portion of the manual will aid you in troubleshooting the Z Unit in the event that trouble develops. During troubleshooting work, the information contained in this

section should be correlated with information in other sections of the manual.

No attempt is made to give complete step-by-step procedures for finding the cause of each possible type of trouble. Instead, an attempt is made to outline a general troubleshooting guide. This guide provides a means for determining the probable cause of a trouble from symptoms observed before detailed checks are made.

A schematic diagram of the Z Unit is contained at the rear of this manual. The reference designation of each component is shown on the circuit diagram.

All wiring used in the Z Unit is color coded. This greatly simplifies circuit tracing in the instrument.

### Preliminary Troubleshooting

Before attempting any troubleshooting work, check all front-panel controls for proper settings. If in doubt as to the settings of the controls, refer to the Operating Instructions section.

#### 1. Visual Operational checks

A good procedure to follow when trouble occurs in the Z Unit is to make a careful visual check of the instrument and the input connections. A source of trouble can often be detected by visual means. If no trouble is visible, apply an input signal and observe the CRT for proper wave-shapes. Adjust the front-panel controls to see the effect of each. The normal or abnormal operation of each control will indicate what sort of trouble is encountered. Once the symptoms are clearly established, the faulty circuit can usually be isolated more readily.

#### 2. Oscilloscope or Z Unit

When following a troubleshooting procedure, it is assumed that the oscilloscope used with the Z Unit is operating normally. This is not always the case. If in doubt, check the operation of the oscilloscope before attempting to troubleshoot the Z Unit. Troubles occurring in the oscilloscope can usually be detected by substituting another plug-in unit for the Z Unit and checking for proper operation.

### Troubleshooting Procedures

The troubleshooting procedures that follow are divided into sections according to trouble symptoms. When a trouble occurs in the unit, the proper troubleshooting section can be quickly found.

#### 1. Incorrect Gain

Improper gain may be caused by any of several conditions in the unit. However, as a first check, see if the GAIN ADJUST control will correct the gain. Refer to the Operating Instructions section which describes how to make the adjustment. Then, if necessary, check the tubes and

## Maintenance — Type Z

transistors in all cathode follower and amplifier stages, preferably by substitution. After substituting a part, various adjustments are affected. Use the Preliminary Procedure in the Calibration section for a guide in setting up the front-panel controls, and perform steps 2, 5, 6 and 7 in the Calibration procedure to determine if any of the adjustments given in those steps require readjustment.

When a tube or transistor is replaced in a stage, imbalance may occur. Choose matched components or use Tektronix parts to get the trace onto the screen. To aid in determining how well the stage balances, refer to the Calibration section for the appropriate balance step to perform and the location of jumper-connection test points (see Fig. 5-3) to use.

If the trouble has still not been corrected, apply a known input signal and use a test oscilloscope to check the gain of each stage. The overall gain of the unit as measured at the cathode of each output cathode follower should be 1 (single-ended); the push-pull gain should be 2. The input cathode followers should have a single-ended gain of approximately 0.99, the differential amplifier a gain of approximately 0.7, the output amplifier a gain of approximately 2.6, and the output cathode follower measured from the input grid to output a gain of approximately 0.98. The single-ended gain of the entire output cathode follower stage when measured from the collector of the output amplifier to the cathode of the output cathode follower is approximately 0.6.

It should be remembered when measuring the gain that the input of the differential amplifier is single-ended while the output is push-pull. The input of the differential amplifier is measured at the grid of either V7634 or V8634, as applicable. Output of the stage is measured at the plate of each tube. Then the single-ended gain of each half of successive push-pull stages should be checked for proper gain as given in the previous paragraph. At the same time check to see if the gain for each half of the push-pull stage is approximately the same.

When the defective stage has been found, use voltage and resistance measurements to determine the exact cause of the trouble.

### 2. Nonlinearity

An improper setting of the OUTPUT CF BAL. adjustment causes nonlinear operation and the trace to be deflected off the screen. An operator can easily correct for the deflected trace symptom if the OUTPUT CF BAL. adjustment had not been moved more than about 20° from either side of the correct setting. As stated in the Operating Instructions section for centering the trace, the AMP. DC BAL. adjustment is used to position the trace behind the horizontal centerline of the graticule when the POSITION control is set to midscale. However, the nonlinearity will not be corrected unless the OUTPUT CF BAL. is brought back to its correct setting.

To check if nonlinearity exists, proceed as follows:

Apply a 100-mv calibrator signal to the A input connector. Set the A AC-DC switch to DC, the A VOLTS/CM switch to .05, and the Mode switch to A-Vc. Set the Polarity switch to +, the Range switch to 1 V, the Helidial

control to 0.00, and the POSITION control to midscale. Set the oscilloscope triggering controls to produce a stable display. Rotate the Helidial slowly clockwise to position the signal to the center of the graticule. Note the exact amplitude of the signal (should be about 2 cm high.)

Rotate the Helidial slowly clockwise to position the signal to the bottom 2 cm of the graticule. Note the amplitude of the signal. Place the Polarity switch to — and position the signal to the top 2 cm of the graticule. Note the amplitude again. If changes in signal amplitude are noted which are greater than any slight inherent compression (if any) due to the main oscilloscope vertical amplifier or crt, then the Z Unit is operating in a nonlinear region.

To restore the Z Unit to proper operation, perform steps 2, 5 and 6 in the Calibration procedure. Use the Preliminary (Calibration) Procedure for a guide in presetting the front-panel controls prior to making the adjustments.

### 3. Low Differential Rejection Ratio

The differential rejection ratio is highest on the .05 settings of the VOLTS/CM switches; the ratio is lower on other settings due to slight imbalances in the input attenuators. If the differential rejection ratio seems normal on the .05 settings of the VOLTS/CM switches but abnormal on one or more of the other ranges, the input turret attenuators should be checked.

If the differential rejection ratio (.05 volts/cm) is less than the specified 40,000 to 1, check the setting of the DIFF. BAL. potentiometer. Then check the tubes and transistors in all cathode follower and amplifier stages (by substitution). Apply the same signal first to one and then the other input connector of the unit. The vertical deflection produced should be the same in either case with only the polarity reversed. If the deflection produced by the signal applied to one input is different than the deflection produced by the same signal applied to the other input, a difference in gain exists between the two sides of the amplifier. Use a test oscilloscope to determine where this gain imbalance is introduced. When the defective stage has been determined, use voltage and resistance measurements to find the cause of the trouble.

### 4. Large DC Imbalance

A large dc imbalance in the preamplifier will cause the oscilloscope trace to deflect off the screen, and the POSITION control may not have sufficient range to bring the trace back on the screen. If this occurs, set the Mode switch to TEST, center the POSITION control, and use the AMP. DC BAL. adjustment to attempt to bring the trace back on the screen. If the trace does not appear, perform steps 2 through 6 in the Calibration section of the manual.

When the adjustments and jumper connections are made as instructed in the previous paragraph, there may be one jumper-connection checkpoint where the trace cannot be made to return to the screen. When this occurs, the stage following the jumper (looking toward the output of the unit) is producing the imbalance. Substitution of tubes and transistors, whichever apply, plus voltage and resistance measurements will determine the cause of the imbalance. When substitutions are made, repeat steps 2 through 6 as

stated previously. Where necessary, use matched and selected parts obtained from the factory.

**5. Waveform Distortion**

If waveform distortion occurs, first check to see which ranges of the VOLTS/CM switch have distortion. If the distortion only occurs on one or two ranges, check the compensation of the input turret attenuators. If the distortion occurs on all ranges, first check the compensation of the probe used. Use a calibrated, 30-mc-bandwidth, test oscilloscope for signal tracing through the unit. The test oscilloscope aids in determining which stage (or stages) is introducing the distortion. In signal tracing for high-frequency distortion, consider the loading effect of the probe. When the defective stage has been determined, check tubes and transistors (by substitution). Then check the settings of frequency compensation components such as L7632, L8632, L7645, L8645, C7655, and C8655. If none of these checks determines the cause of the trouble, use voltage and resistance checks on the defective stage.

**6. Incorrect Comparison Voltages**

This trouble can be detected only with a high precision, infinite-impedance voltmeter such as described in the Calibration section under Equipment Required. To check these voltages, connect the voltmeter from test point C to ground, set the Helidial at 10.000 and set the Range switch at 100 V. The voltage measured should be 100 ( $\pm 0.15$ ) volts in both the + and - positions of the Polarity switch. If both the + and - voltages are correct, check for 10 ( $\pm 0.02$ ) volts with the Range switch set at 10 V and 1 ( $\pm 0.005$ ) volt with the Range switch set at 1 V. If either the 10 V or 1 V ranges are incorrect, check the Range switch contacts and rotors, the precision attenuators, and the setting of R7689 (CAL. 5 adjustment).

If voltages obtained on both the + and - 100 V ranges are incorrect, check the settings of the CAL. 1, CAL. 2, CAL. 3, and CAL. 4 adjustments. If only one polarity is incorrect, check the settings of CAL. 1 or CAL. 2 as applicable, and the voltages on Q7674 or Q8674.

Poor regulation of the comparison voltage may be caused by defects in any of the following: D8679, Q8672, Q8674, D7675, Q7672, Q7674, D7686, D7687, D7688, or V7689.

**7. Short Circuit**

If the oscilloscope must be turned off because the Z Unit is the cause of resistors overheating in the oscilloscope power supply, and possibly in the unit as well, remove the unit from the plug-in compartment. Place the COMPARISON VOLTAGE switch in the + Position. Make the following resistance-to-ground checks at the 16-pin interconnecting plug. The measurements listed in Table 4-1 are typical values obtained using a 20,000  $\Omega/V$  VOM.

When the trouble is corrected, replace the overheated resistors in the oscilloscope and check the Z Unit for any other troubles under operating conditions. It may be desirable to perform steps 1 through 11 in the Calibration section of the manual. These steps provide a systematic approach to important voltage measurements, balancing each stage, and making operational checks.

**TABLE 4-1**

CIRCUIT	INTERCONNECTING SOCKET PIN NUMBER	RESISTANCE TO GROUND
Output	1 & 3	9.8 k
Ground	2	0
No Connection	4, 5, 6, 7, 8, and 16	Infinite
-150 V	9	10.7 k *17.0 k
+100 V	10	8.7 k *7.7 k
+225 V	11	19.0 k *14.0 k
+350 V	12	60 to 80 k
6DJ8 Filament Transformer Primary	13 and 14	Infinite
Series Filament String	15	72 $\Omega$

\*With COMPARISON VOLTAGE Polarity switch at - position.

## CALIBRATION

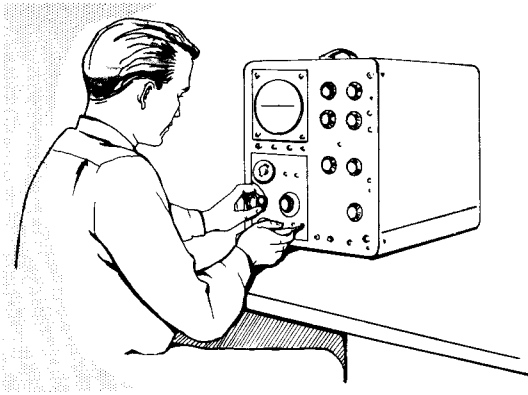

## INTRODUCTION

A complete procedure for checking the operational standards and calibration of the Type Z Plug-In Unit is provided in this section of the manual. The steps in the procedure are arranged in correct sequence to avoid unnecessary repetition.

The step-by-step instructions also furnish an orderly approach for isolation of malfunctions which may develop. Consequently, this procedure should be used in conjunction with any maintenance and troubleshooting system.

If an abnormal indication is obtained at some point in the procedure, it is not usually necessary to locate its cause before continuing to the next step. Additional symptoms revealed by performing further steps will frequently simplify the task of locating trouble. Obscure symptoms, if any, usually show up when performing the first eleven steps of the procedure.

For this procedure, the Z Unit should be used in conjunction with a properly calibrated Tektronix Type 540-Series oscilloscope. Oscilloscope control settings for a Type 541A Oscilloscope are listed in the procedure; corresponding control settings should be used if a different oscilloscope is used.

Test equipment used in a particular step should be left connected at the end of that step unless instructions state otherwise. Similarly, controls not mentioned are assumed to be in the positions they were in at the conclusion of the preceding step.

If information explaining the normal operation of front-panel controls is needed before starting the procedure, consult the Operating Instructions section of this manual.

## EQUIPMENT REQUIRED

The following equipment or its equivalent is required to perform a complete calibration of the Type Z Plug-In Unit.

1. Square-wave generator, Tektronix Type 105 or equivalent. Required specifications are: 13-nsec risetime or less; output frequencies of approximately 1 kc and 10 kc; output amplitude variable from 10 to 100 volts across 600-ohm internal load.
2. Square-wave generator, Tektronix Type 107 or equivalent. Required specifications are: 3 nsec risetime or less; output frequency of approximately 1 mc; output amplitude variable to at least 0.35 volt.

3. Sine-wave generator, Tektronix Type 190A Constant-Amplitude Signal Generator or equivalent. Required specifications are: frequency range of 50 kc to 13 mc; output amplitude of 0.14 volt or more; output must be adjustable (manually or automatically) for constant amplitude within the above frequency range.

4. Precision dc voltmeter. Required specifications are: accuracy of 0.05% or better; resolution of 50  $\mu$ volts or less; must be of the nulling type with infinite impedance at null. If a John Fluke Differential Voltmeter is available, use Model 803 or equivalent.

5. Calibrated volt-ohm meter (VOM). Sensitivity of 20,000  $\Omega/v$  at full deflection.

6. 24- $\mu$ mf Input Capacitance Standardizer, Tektronix Type CS24 (Part No. 011-029) or equivalent.

7. Plug-in cable extension, Tektronix Part No. 012-038.

8. Plug-in extension, Type EP54, Tektronix Part No. 013-019.

9. 52-ohm coaxial cable, Tektronix Part No. 012-001.

10. 52-ohm 5-to-1 "L" attenuator, Tektronix Part No. 011-002.

11. 52-ohm cable termination, Tektronix Part No. 011-001.

12. Suggested tools: screwdriver, shank 2" long x 1/8" dia.; 0.050" allen wrench; low-capacitance screwdriver, Tektronix Part No. 003-000; alignment tool consisting of a handle (Tektronix Part No. 003-007), a low-capacitance screwdriver insert with a metal bit (Tektronix Part No. 003-334, and a hexagonal core insert (Tektronix Part No. 003-310).

## PRELIMINARY PROCEDURE

**NOTE**—Make certain the —150-, +100-, +225-, and +350-volt power supplies in the oscilloscope are regulating and within rated voltage tolerances before attempting to calibrate the Z Unit.

Preset the Type 541A Oscilloscope (or equivalent) front-panel controls as follows:

Horizontal Display	Normal
Time/cm	.5 Millisec
Variable Time/cm	Fully Clockwise
Triggering Mode	AC
Trigger Slope	+ Internal
Stability	Fully Clockwise

## Calibration — Type Z

Preset the Z Unit front-panel controls as follows:

POSITION	Midrange
A VOLTS/CM	.05
B VOLTS/CM	.05
Both AC-DC switches	DC
Mode	TEST
VAR. ATTEN.	Fully Clockwise
COMPARISON VOLT-AGE Polarity	0
COMPARISON VOLT-AGE Range	100 V

Check to see that the COMPARISON VOLTAGE Helidial reads exactly zero when the control is rotated fully counter-clockwise. Rotate the control fully clockwise. The dial should read about one half a minor division over 10.000 or a reading of 10.005. If the Helidial does not read exactly as described, loosen the set screw with 0.050" allen wrench and set the Helidial for correct readings. Tighten set screw.

Remove the left side panel from the oscilloscope. Connect the plug-in cable extension between the Z Unit and the oscilloscope vertical plug-in connector. Connect the oscilloscope power cord to the nominal voltage source for which it is wired and turn on the power.

### WARNING

Do not touch transistors! Dangerous potentials exist on transistor cases. If a transistor needs to be replaced, turn off the power.

## CALIBRATION PROCEDURE

### 1. Check Voltage Measurements.

Use the VOM to make the following measurements:

(a) Measure the voltage drops across the 105-volt zener diodes, D7621 and D8621 (see Fig. 5-1). The drops must be

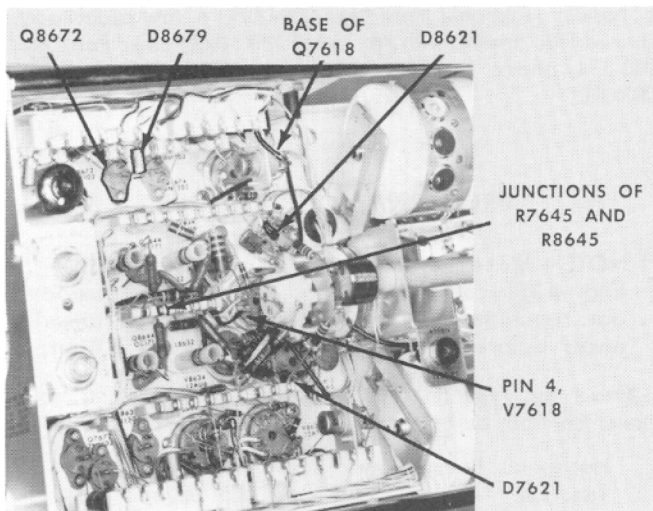

Fig. 5-1. Location of components and test points where some of the step 1 voltage measurements are made.

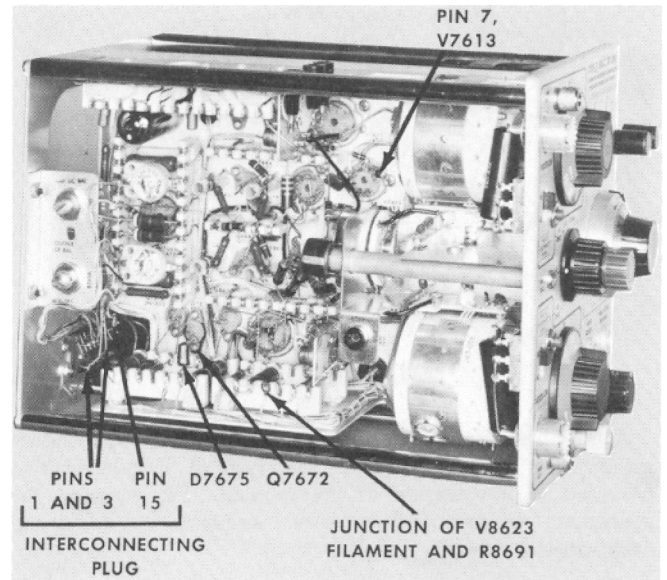

Fig. 5-2. Another view of the Z Unit showing location of remaining components and test points described in step 1.

within the range of 95-115 volts and within 3 volts of each other.

(b) Connect the VOM between pin 7 of V7613 (see Fig. 5-2) and ground. Place the COMPARISON VOLTAGE Polarity switch to the + position. The meter should read approximately 100 volts. Place the COMPARISON VOLTAGE Polarity switch to the - position. The meter should now be reading approximately -100 volts. Set the COMPARISON VOLTAGE Polarity switch back to 0.

(c) Check the voltage readings listed in Table 5-1. Those listed from +12.2 volts and on are obtained by connecting the VOM between the given location and ground.

TABLE 5-1

READ	LOCATION	FIG. NO.
0.3 to 0.6 V	Emitter-to-base drop across Q7672.	5-2
0.3 to 0.6 V	Emitter-to-base drop across Q8672.	5-1
5.7 to 6.7 V	Drop across RT-6 zener diode D7675.	5-2
5.7 to 6.7 V	Drop across RT-6 zener diode D8679.	5-1
+12.2 V	Junction of V8623 filament lead (blue and orange tracer) and R8691.	5-2
+65 to +70 V	Terminals 1 and 3, interconnecting plug.	5-2
+75 V	Terminal 15, interconnecting plug.	5-2
-98 V	Pin 4 of V7618.	5-1
-138 V	Base of Q7618.	5-1
+210 V	Junction of R7645 and R8645.	5-1



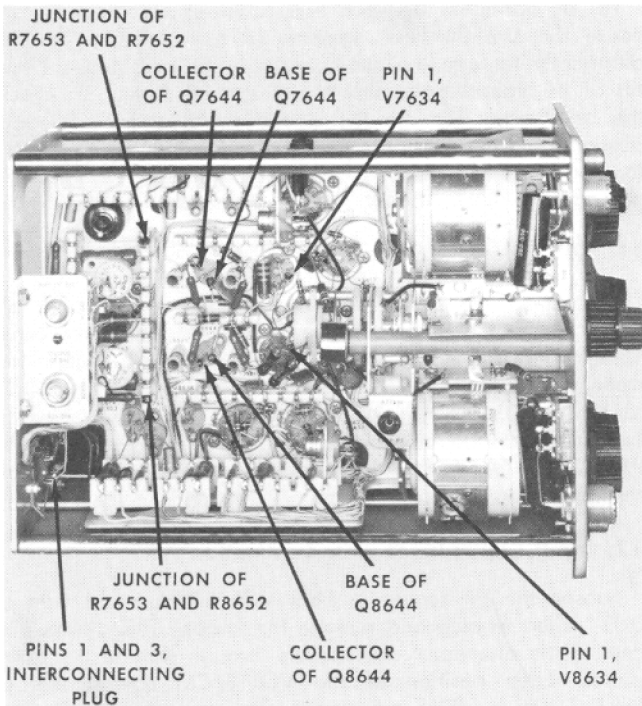

Fig. 5-3. Location of jumper test points used for making steps 2, 3, and 4 push-pull balance checks.

## 2. Output Cathode Follower Balance

Remove the plug-in cable extension and insert the Z Unit directly into the oscilloscope plug-in compartment. Tighten the securing rod to hold the unit fully plugged in.

(a) Connect a short jumper between pins 1 and 3 at the interconnecting plug (see Fig. 5-3 for location). The position of the free-running trace on the crt is the "vertical-system electrical center". Note the position of the trace for future reference in the procedure. Remove the jumper.

(b) Connect the VOM between the wiper arms of the POSITION control (R7653) and adjust the control for a zero reading on the meter. Connections can be made at the junction of R7653 and R7652 and the junction of R7653 and R8652 (see Fig. 5-3). Disconnect the VOM.

### CAUTION

Use care when connecting jumper leads in the following steps. An incorrect connection can quickly damage transistors. Also, if parasitics are produced when a jumper is connected, they can be suppressed with a ferrite toroid. Wind the jumper lead through the toroid two or three times.

(c) Connect a jumper between the collectors of Q7644 and Q8644 (see Fig. 5-3). Rotate the OUTPUT CF BAL adjustment (R7658) to bring the trace back to the "vertical-system electrical center" position established in step 2 (a). Remove the jumper.

Fig. 5-4 shows all internal adjustments not accessible from the front of the unit.

## 3. Output Amplifier Balance

Connect the jumper between the bases of Q7644 and Q8644 (Fig. 5-3). With balanced transistors the trace will not shift more than 1 cm from the "vertical-system electrical center" position. Disconnect the jumper.

## 4. Differential Amplifier Tube Balance Test

Connect the jumper between pins 1 of V7634 and V8634 (Fig. 5-3). The trace should not shift more than 3 cm from "vertical-system electrical center". Disconnect the jumper.

## 5. Variable Attenuator Balance

Position the trace onto the screen using the POSITION, AMP DC BAL, and VAR. ATTEN. BALANCE controls. Set the VAR. ATTEN. BALANCE control so the trace no longer shifts as the VAR. ATTEN. control is rotated. During adjustment of the VAR. ATTEN. BALANCE control, it may be necessary to reposition the trace to keep it centered on the crt by using the POSITION and AMP DC BAL controls.

## 6. Amplifier DC Balance

Set the POSITION control to midrange and adjust the AMP DC BAL control to position the trace directly behind the center horizontal graticule line.

## 7. Gain

Set the Mode switch to A Only. Apply a 0.2-volt square-wave signal from the oscilloscope calibrator to both input

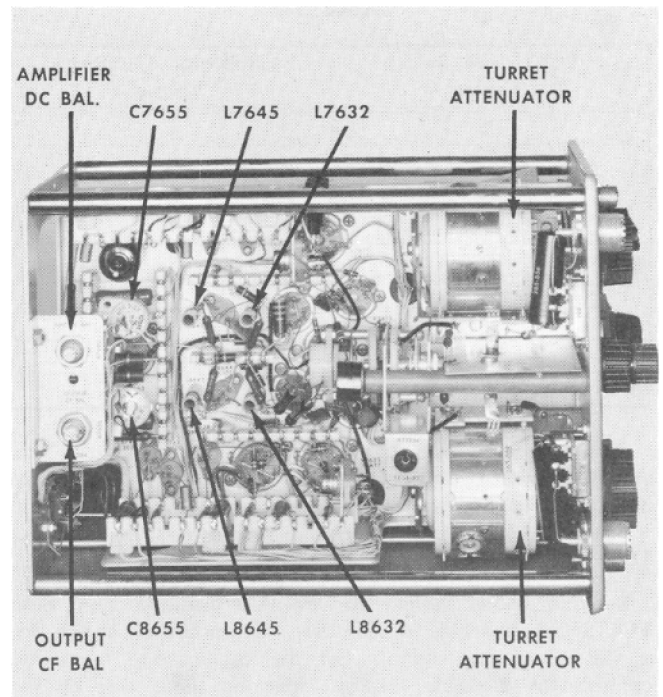

Fig. 5-4. Location of internal adjustments accessible from left side of Z Unit. Turret attenuator compensation adjustments are accessible through front panel after outer VOLTS/CM knobs are removed.

## Calibration — Type Z

connectors. Make certain the VAR. ATTEN. control is set fully clockwise. Set the GAIN ADJUST control (R8639) to obtain exactly 4 cm of vertical deflection. Place the Mode switch to —B ONLY. Check to see that there are exactly 4 cm of vertical deflection.

### 8. Operational Checks

Perform the following Z Unit operational checks:

(a) Disconnect the calibrator signal from the input connectors. Check to see that the baseline does not shift more than 2 mm after switching the Mode switch from A ONLY to —B ONLY. Reconnect the calibrator signal to the input connectors.

(b) With the Mode switch at —B ONLY, check the operation of the B AC-DC switch by setting it to the AC position. Observe the signal to see that it shifts to its average voltage level. The shifting of the signal indicates that the AC-DC switch and the blocking capacitor function properly. Set the Mode switch to A ONLY and check the A AC-DC switch for the same waveform shift indication. Place both AC-DC switches back to the DC position.

(c) Check operation of the VAR. ATTEN. control. When the control is rotated fully counterclockwise, the vertical deflection of the signal should not exceed 1.6 cm. Rotate the control back to the fully clockwise position.

### 9. Turret Attenuation Ratios

With the Mode switch at A ONLY, check for 2 cm of vertical deflection at each position of the A VOLTS/CM switch by following the information in Table 5-2.

TABLE 5-2

VOLTS/CM Switch Setting	Calibrator Output Volts
.05	.1
.1	.2
.25	.5
.5	1
1	2
2.5	5
5	10
10	20
25	50

After checking the A VOLTS/CM turret attenuator, set the Mode switch to —B ONLY and check the B VOLTS/CM attenuator in the same manner.

### 10. Differential Balance

Set the Mode switch to the A-B position and both VOLTS/CM switches to .05. Set the calibrator switch for a 100-volt output signal. Set the oscilloscope triggering controls for a stable display. Ignoring the spikes on the waveform, adjust the DIFF. BAL. control for minimum square-wave amplitude. The maximum allowable amplitude is 0.5 mm. When the control is correctly adjusted and the Z Unit balances properly, the waveform appears as a straight line with positive and negative spikes.

An ac mismatch between two tubes or components can cause the straight line segments of the waveform to tilt diagonally to form a zigzag pattern. The amplitude of the tilt at its highest point should not exceed 1 mm. To check the amplitude, free run the sweep at 20 millise/cm and observe the width of the trace. It should not exceed 1.5 mm (amplitude of tilt and square wave together). After completing this check, repeat step 5. Then go on to step 11.

### 11. Characteristic Unbalance

Disconnect the signal from the Z Unit inputs, and set the Mode switch to the TEST position. Set the oscilloscope Time/cm switch to .5 millise/cm. While observing the trace, move the COMPARISON VOLTAGE Polarity switch to the +, 0, and — positions several times. The overall baseline shift should not exceed 1 cm. Leave the COMPARISON VOLTAGE Polarity switch in the 0 position at the conclusion of this step.

### 12. Input-Capacitance Standardization

Loosen the set screws in both VOLTS/CM knobs with a .005" allen wrench and remove the knobs. This allows access to the attenuator adjustments through slots in the front panel. Each position of the VOLTS/CM control has a SHUNT and a SERIES adjustment. The only exception is the .05 position which has only an input-capacitance trimmer accessible through the SERIES side of the slot.

Connect the 52-ohm cable to the Type 105 Square-Wave Generator, or equivalent. Connect the other end of the cable to the 5-to-1 "L" pad. Connect the other end of the "L" pad through the 24- $\mu$ f capacitance standardizer to the A input connector on the Z Unit. Set the Mode switch to A ONLY and both VOLTS/CM switches to .05.

To make this adjustment, set the square-wave generator to produce about 3.5 cm of deflection at a frequency of 1 kc. Set the oscilloscope front-panel controls for "double triggering" as follows:

Triggering Mode	AC Fast
Trigger Slope	+ Internal
Trigger Level	0
Stability	Fully clockwise
Time/cm	.5 Millise/cm

Rotate the Variable Time/cm control slowly counterclockwise until you obtain a stable display of overlapping square waves as shown in Fig. 5-5.

Adjust the input-capacitance trimmer in the A VOLTS/CM attenuator for best flat top on the displayed waveform (see Fig. 5-5), disregarding any fast-rise leading edge spikes.

Set the Mode switch to —B ONLY. Disconnect the signal from the A input connector and connect it to the B input. Adjust the input-capacitance trimmer in the B VOLTS/CM attenuator for best flat bottom, disregarding the spikes.

### 13. Output Voltage Divider Compensation

Increase the square-wave generator frequency to 10 kc. Set the oscilloscope Time/cm switch to 50  $\mu$ sec and readjust the Variable Time/cm control to obtain a stable display of several overlapping waveforms. Adjust the output voltage divider compensations C7655 and C8655 for

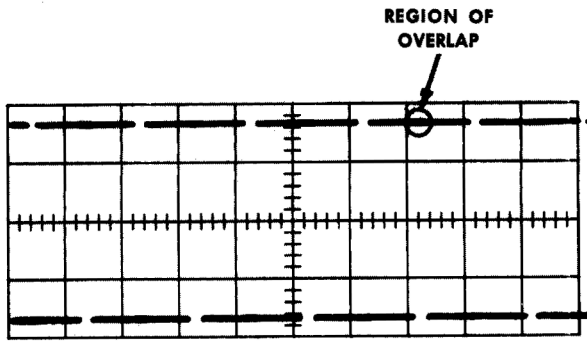

Fig. 5-5. "Double triggering" the waveform permits attenuator compensation adjustments to be made quickly and accurately. Waveform photograph shows result when the A VOLTS/CM input-capacitance trimmer is correctly adjusted.

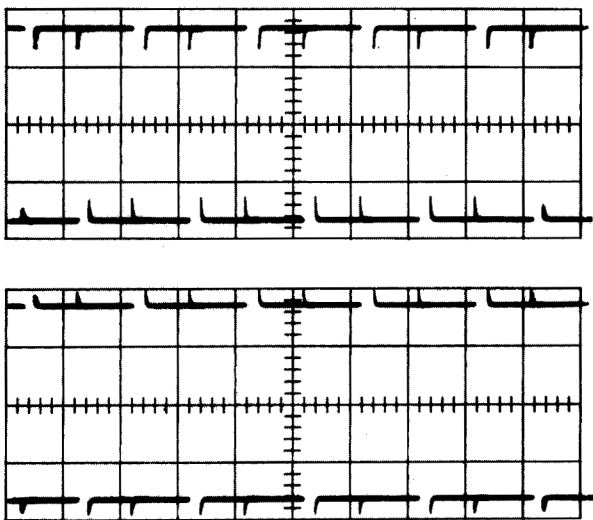

Fig. 5-6. Effect of the output voltage divider compensation adjustments when incorrectly adjusted. When adjustments are correct, waveform should appear similar to Fig. 5-5.

adjust the Variable Time/cm control to obtain a stable display of several overlapping waveforms. Adjust the output voltage divider compensations C7655 and C8655 for best square leading corner at the bottom side of the square wave. The capacitors should be adjusted in equal increments so they will be at approximately the same physical setting. Fig. 5-6 shows typical appearance of waveforms when C7655 and C8655 are not correctly adjusted. When adjustments are set correctly, the waveform should look like Fig. 5-5. Set the Mode switch to A ONLY. Disconnect the signal from the B input connector and connect it to the A input. Check to see if C7655 and C8655 are adjusted to give the best possible square leading corner at the top of the displayed square waves. If the capacitors need to be readjusted, adjust them for the best compromise between the two displays. Keep the capacitors at approximately the same physical settings in relation to each other. Be-

cause of adjustment interaction, repeat steps 12 and 13 before going on to step 14.

#### 14. Turret Attenuator Compensation

Place the A VOLTS/CM control to the .1 position. Set the oscilloscope Time/cm switch to .5 millisecc. Decrease the square-wave generator frequency to 1 kc and adjust the generator output amplitude for approximately 3.5 cm deflection on the crt. Adjust the SERIES trimmer for the most nearly square corner on the leading edge. Then adjust the SHUNT trimmer to make the flat tops of the waveform as level as possible. Recheck the SERIES adjustment for the best square leading corner. Set the attenuator to the next position. Continue in this manner until the rest of the attenuator positions have been adjusted. Throughout this step, adjust the generator output amplitude to keep about 3.5 cm of deflection for each position of the attenuator as long as sufficient output can be obtained. Remove the "L" pad for more amplitude during the higher attenuation positions of the turret. After completing all the turret adjustments, check each position again to see if any "touching up" is necessary. Place the turret attenuator in its most clockwise position and remount the outer knob to read .05.

Disconnect the signal from the A input connector and apply it to the B input connector. Set the Mode switch to -B ONLY and repeat the above procedure to adjust the B VOLTS/CM attenuator compensation. Disconnect the generator cable, "L" pad, and capacitance standardizer.

#### 15. Amplifier High-Frequency Compensations

Connect the 52-ohm cable to the Type 107 Square-Wave Generator (or equivalent) output connector. Connect the other end of the cable through a 52-ohm termination to the B input connector on the Z Unit. Set the generator output frequency to approximately 1 mc and adjust the amplitude for about .35 cm of vertical deflection. Set the oscilloscope Time/cm switch to .1  $\mu$ sec. Display the nega-

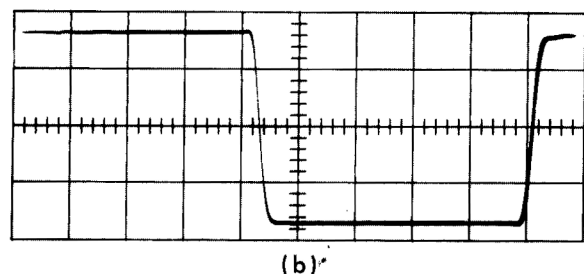
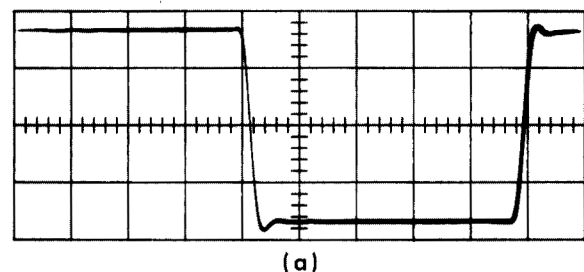

Fig. 5-7. (a) Appearance of input B waveform when L7632 and L8632 are improperly adjusted. (b) Appearance of waveform when all high-frequency compensations are correctly made.

## Calibration — Type Z

tive half cycle of the waveform by using the + Internal position of the Triggering Mode switch. Adjust L7645, L8645, L7632, and L8632 to obtain the sharpest negative leading corner on the displayed waveform without introducing any overshoot (see Fig. 5-7). Adjust each pair of variable inductors (for example, L7645 and L8645) in equal increments so the slugs are positioned the same depth in the coil forms.

Disconnect the signal from the B input connector and apply it to the A input connector. Set the Mode switch to A ONLY. Set the oscilloscope Trigger Slope switch to —Internal to display the positive half cycle of the waveform. Check to see if the leading corner of the positive-going waveform is as square as possible without overshoot. If it is not, adjust the coil slugs for a compromise between the best display obtained with signal applied to the B input connector and that obtained when connected to the A input connector. The compromise setting assures that the best possible high-frequency differential operation will be attained.

Disconnect the square-wave generator cable and the termination.

### 16. Bandwidth Measurement

Apply a 50-kc sine-wave from the Type 190A Constant-Amplitude Signal Generator (or equivalent) to B input connector. Set the oscilloscope Time/cm switch to the .1 millisecc position and free run the sweep. Adjust the generator amplitude control so that the signal produces exactly 28 mm (2.8 cm) of deflection on the crt. Center the display vertically on the screen.

Increase the sine-wave generator frequency to 13 mc, keeping the generator output level constant. (The Type 190A Generator maintains a constant-amplitude signal automatically.)

After the generator frequency has been increased to 13 mc, (3 db point), there should be at least 20 mm (2 cm) of deflection.

If another type of Tektronix oscilloscope is being used with the Z Unit to make a bandwidth check, consult the Specifications section of this manual for the upper frequency limit. That is the frequency at which 20 mm of deflection or more should be obtained. For instance, if a Type 535A Oscilloscope is used in conjunction with the Z Unit, 20 mm or more should be obtained with the sine-wave generator set at 10 mc.

Disconnect the generator from the B input connector and apply the signal to the A input connector. Set the Mode switch to A ONLY and repeat this step. Disconnect the sine-wave generator.

### 17. Precision Voltage Adjustments

Remove the Z Unit and connect an EP54 plug-in extension between the unit and oscilloscope. Set the COMPARISON VOLTAGE Polarity switch to +. Make certain the COMPARISON VOLTAGE Range switch is set to 100 V. Before proceeding with this step, be sure the regulated power supply voltages measured in the oscilloscope are within specifications as noted in the preliminary calibration instructions. Refer to Fig. 5-8 for locations of all test points and internal adjustments given in this step.

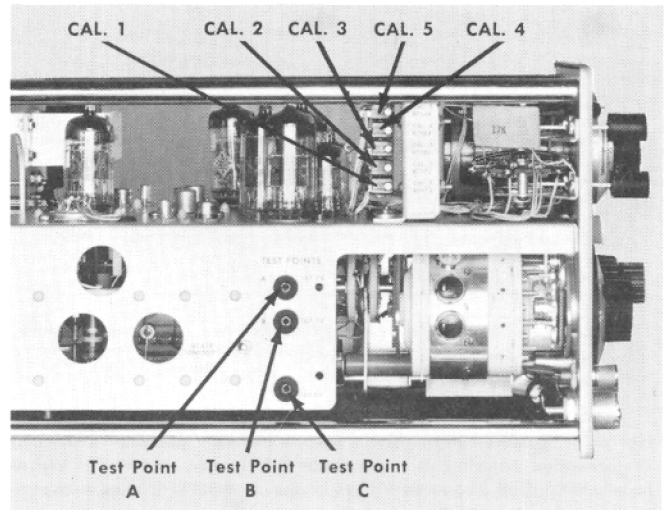

Fig. 5-8. Top view of the Z Unit showing location of step 17 test points and internal adjustments.

(a) Adjust CAL. 1: Set the precision voltmeter for —107.70 volts and connect it between Test Point A and ground. Adjust CAL. 1 (R8674) for a null reading on the meter.

(b) Adjust CAL. 2: Set the precision voltmeter for +107.70 volts. Place the COMPARISON VOLTAGE Polarity switch in the — position. Adjust CAL. 2 (R7671) for a null reading on the meter.

#### NOTE

When adjusting CAL. 1 and CAL. 2 wirewound controls, it is more important that the voltage readings be identical, than that they be exactly 107.7 volts. For instance, readings of —107.90 and +107.95 are better than —107.70 and +107.85. Keep the two voltage readings within the range of 107.3 to 108.1 volts, however.

(c) Adjust CAL. 3: With the precision voltmeter set for +107.7 volts, connect it between Test Point B and Ground. Set the COMPARISON VOLTAGE Polarity switch to the + position. Adjust CAL. 3 (R7681) for a null indication on the meter. (If CAL. 1 and CAL. 2 adjustments are set at 107.9 or any other voltage reading within limitations given in step 17b, then CAL. 3 should set at the same voltage).

(d) Adjust CAL. 4: Set the precision voltmeter for +100.00 volts and connect it between Test Point C and ground. Adjust CAL. 4 (R7684) for a null reading on the meter.

(e) Adjust CAL. 5: Set the COMPARISON VOLTAGE Range switch to 10 V and the precision voltmeter for 10.000 volts. Adjust CAL. 5 (R7689) for a null reading on the meter. Because of interaction between CAL. 4 and CAL. 5, repeat these adjustments until readjustment is no longer necessary.

(f) Check 1 Volt Range: Set the COMPARISON VOLTAGE Range switch to 1 V and the precision voltmeter for 1.0000 volts. The meter should be within 5 millivolts of null. Or conversely, null the voltmeter by turning the

COMPARISON VOLTAGE Helidial. At null, the Helidial dial reading should not be further than  $\frac{1}{2}$  minor division (which is 5 millivolts) from the 10.000 position.

Disconnect the voltmeter, remove the plug-in extension and insert the Z Unit directly into the oscilloscope plug-in compartment. Install the left side panel on the oscilloscope.

## **HOW TO ORDER PARTS**

Replacement parts are available through your local Tektronix Field Office.

Improvements in Tektronix instruments are incorporated as soon as available. Therefore, when ordering a replacement part it is important to supply the part number including any suffix, instrument type, serial number, plus a modification number where applicable.

If the part you have ordered has been improved or replaced, your local Field Office will contact you if there is a change in part number.

# PARTS LIST *and*

# DIAGRAMS

Part Number	Quantity	Description	Value	Notes	Reference Part Number
C141	1	Capacitor	100 pF		701-018
C142	1	Capacitor	100 pF		701-018
C143	1	Capacitor	100 pF		701-018
C144	1	Capacitor	100 pF		701-018
C145	1	Capacitor	100 pF		701-018
C146	1	Capacitor	100 pF		701-018
C147	1	Capacitor	100 pF		701-018
C148	1	Capacitor	100 pF		701-018
C149	1	Capacitor	100 pF		701-018
C150	1	Capacitor	100 pF		701-018
C151	1	Capacitor	100 pF		701-018
C152	1	Capacitor	100 pF		701-018
C153	1	Capacitor	100 pF		701-018
C154	1	Capacitor	100 pF		701-018
C155	1	Capacitor	100 pF		701-018
C156	1	Capacitor	100 pF		701-018
C157	1	Capacitor	100 pF		701-018
C158	1	Capacitor	100 pF		701-018
C159	1	Capacitor	100 pF		701-018
C160	1	Capacitor	100 pF		701-018
C161	1	Capacitor	100 pF		701-018
C162	1	Capacitor	100 pF		701-018
C163	1	Capacitor	100 pF		701-018
C164	1	Capacitor	100 pF		701-018
C165	1	Capacitor	100 pF		701-018
C166	1	Capacitor	100 pF		701-018
C167	1	Capacitor	100 pF		701-018
C168	1	Capacitor	100 pF		701-018
C169	1	Capacitor	100 pF		701-018
C170	1	Capacitor	100 pF		701-018
C171	1	Capacitor	100 pF		701-018
C172	1	Capacitor	100 pF		701-018
C173	1	Capacitor	100 pF		701-018
C174	1	Capacitor	100 pF		701-018
C175	1	Capacitor	100 pF		701-018
C176	1	Capacitor	100 pF		701-018
C177	1	Capacitor	100 pF		701-018
C178	1	Capacitor	100 pF		701-018
C179	1	Capacitor	100 pF		701-018
C180	1	Capacitor	100 pF		701-018
C181	1	Capacitor	100 pF		701-018
C182	1	Capacitor	100 pF		701-018
C183	1	Capacitor	100 pF		701-018
C184	1	Capacitor	100 pF		701-018
C185	1	Capacitor	100 pF		701-018
C186	1	Capacitor	100 pF		701-018
C187	1	Capacitor	100 pF		701-018
C188	1	Capacitor	100 pF		701-018
C189	1	Capacitor	100 pF		701-018
C190	1	Capacitor	100 pF		701-018
C191	1	Capacitor	100 pF		701-018
C192	1	Capacitor	100 pF		701-018
C193	1	Capacitor	100 pF		701-018
C194	1	Capacitor	100 pF		701-018
C195	1	Capacitor	100 pF		701-018
C196	1	Capacitor	100 pF		701-018
C197	1	Capacitor	100 pF		701-018
C198	1	Capacitor	100 pF		701-018
C199	1	Capacitor	100 pF		701-018
C200	1	Capacitor	100 pF		701-018

**ABBREVIATIONS**

Cer.	Ceramic	n	Nano or 10 <sup>-9</sup>
Comp.	Composition	Ω	ohm
EMC	Electrolytic, metal cased	p	Pico or 10 <sup>-12</sup>
f	Farad	PTB	Paper, "Bathtub"
G	Giga, or 10 <sup>9</sup>	PMC	Paper, metal cased
GMV	Guaranteed minimum value	Poly.	Polystyrene
h	Henry	Prec.	Precision
K or k	Kilohms or kilo (10 <sup>3</sup> )	PT	Paper Tubular
M/Cer.	Mica or Ceramic	T	Terra or 10 <sup>12</sup>
M or meg	Megohms or mega (10 <sup>6</sup> )	v	Working volts DC
μ	Micro, or 10 <sup>-6</sup>	Var.	Variable
μμ	Micromicro or 10 <sup>-12</sup>	w	Watt
m	milli or 10 <sup>-3</sup>	WW	Wire-wound

**SPECIAL NOTES AND SYMBOLS**

- + and up
- † Approximate serial number.
- X000 Part first added at this serial number.
- 000X Part removed after this serial number.
- \* 000-000 Asterisk preceding Tektronix Part Number indicates manufactured by or for Tektronix, also reworked or checked components.
- (Mod. w/) Simple replacement not recommended.
- Modify to value for later instruments and change other parts to match.



# PARTS LIST

## Capacitors

Values fixed unless marked variable.

Tolerances  $\pm 20\%$  unless otherwise indicated.

						Tektronix Part Number
C7600 †		.1 $\mu$ f	PTM	600 v		*295-054
C7601	X1950-up	1.5 pf	Cer.	500 v	$\pm .5 \mu$ f	281-526
C7602		.2 $\mu$ f	Cer.	25 v		283-026
C7614		.2 $\mu$ f	Cer.	25 v		Use 283-026
C7621		.01 $\mu$ f	Cer.	250 v		283-005
C7626		.001 $\mu$ f	Cer.	500 v		283-000
C7631		.005 $\mu$ f	Cer.	500 v		283-001
C7635		.01 $\mu$ f	Cer.	250 v		283-005
C7655		3-12 pf	Cer.	Var.		281-007
C7686	101-1149	.01 $\mu$ f	Cer.	150 v	GMV	283-003
C7686	1150-up	.1 $\mu$ f	PTM	200 v		285-572
C8600 †		.1 $\mu$ f	PTM	600 v		*295-054
C8601	X1950-up	1.5 pf	Cer.	500 v	$\pm .5 \mu$ f	281-526
C8602		.2 $\mu$ f	Cer.	25 v		283-026
C8614		.2 $\mu$ f	Cer.	25 v		Use 283-026
C8621		.01 $\mu$ f	Cer.	250 v		283-005
C8626		.001 $\mu$ f	Cer.	500 v		283-000
C8655		3-12 pf	Cer.	Var.		281-007

† Note: C7600 and C8600 matched within 1% each other. Furnished as a unit.

## Diodes

D7621 †	105Z10	Selected		*153-003
D7635	140Z10	Selected		Use *153-006
D7675	RT-6			152-016
D7686	1N753			152-034
D7687	1N753			152-034
D7688	RT-6			152-016
D8621 †	105Z10	Selected		*153-003
D8679	RT-6			152-016

† D7621 & D8621 are a matched pair, furnished as a unit.

## Inductors

L7632	2-2.7 $\mu$ h	Var.	core 276-506	*114-085
L7645	5.2-8.3 $\mu$ h	Var.	core 276-506	*114-056
L7664	.18 $\mu$ h	Fixed		*108-009
L8632	2-2.7 $\mu$ h	Var.	core 276-506	*114-085
L8645	5.2-8.3 $\mu$ h	Var.	core 276-506	*114-056
L8664	.18 $\mu$ h	Fixed		*108-009

## Resistors

Resistors are fixed, composition,  $\pm 10\%$  unless otherwise indicated.

R7604	101-260X	47 $\Omega$	$\frac{1}{2}$ w			302-470
R7608		1 meg	$\frac{1}{2}$ w	Prec.	1%	309-148
R7610		47 $\Omega$	$\frac{1}{4}$ w			316-470
R7614		330 $\Omega$	$\frac{1}{4}$ w			316-331
R7615		47 $\Omega$	$\frac{1}{4}$ w			316-470
R7618	101-2509	750 $\Omega$	$\frac{1}{2}$ w	Prec.	1%	309-327
R7618	2510up	700 $\Omega$	$\frac{1}{2}$ w	Prec.	1%	309-083



## Resistors (continued)

Tektronix  
Part Number

R7619		100 $\Omega$		Var.		VAR. ATTEN. BAL.	311-003	
R7620		500 k	.2 w	Var.		DIFF. BAL.	311-068	
R7621		470 k	$\frac{1}{2}$ w	Fixed	Comp.	5%	301-474	
R7622		100 k	$\frac{1}{4}$ w				316-104	
R7623		47 $\Omega$	$\frac{1}{4}$ w				316-470	
R7626		1 k	$\frac{1}{4}$ w				316-102	
R7630		47 $\Omega$	$\frac{1}{4}$ w				316-470	
R7631		47 $\Omega$	$\frac{1}{2}$ w				302-470	
R7632		500 $\Omega$	$\frac{1}{2}$ w	Fixed	Prec.	1%	309-250	
R7633		1.3 k		Var.	WW	VARIABLE	Use *311-289	
R7634		1.582 k	$\frac{1}{2}$ w	Fixed	Prec.	1%	309-029	
R7635		470 k	$\frac{1}{2}$ w	Fixed	Comp.	5%	301-474	
R7636		100 k	$\frac{1}{4}$ w				316-104	
R7637		47 $\Omega$	$\frac{1}{4}$ w				316-470	
R7640		500 k		Var.		Vert. Pos. Range	311-229	
R7641		220 k	$\frac{1}{2}$ w	Fixed	Comp.	5%	301-224	
R7645		600 $\Omega$	$\frac{1}{2}$ w	Fixed	Prec.	1%	309-097	
R7648		220 $\Omega$	$\frac{1}{2}$ w	Fixed	Comp.	5%	301-221	
R7649		33 k	1 w	Fixed	Comp.	5%	303-333	
R7650	X770-up	5.6 k	$\frac{1}{2}$ w	Fixed	Comp.	5%	301-562	
R7652		10 meg	$\frac{1}{2}$ w	Fixed	Prec.	1%	309-095	
R7653		2 x 500 k		Var.		Vert. Position	311-152	
R7655	101-383	100 k	$\frac{1}{2}$ w	Fixed	Prec.	1%	309-045	
R7655	384-up	100 k	$\frac{1}{2}$ w	Fixed	Prec.	1%	309-334	
R7656	101-383	143 k	1 w	Fixed	Prec.	1%	310-088	
R7656	384-up	143 k	1 w	Fixed	Prec.	1%	310-582	
R7658		5 k		Var.	WW	Output CF Bal.	311-203	
R7660		47 $\Omega$	$\frac{1}{4}$ w				316-470	
R7662		47 $\Omega$	$\frac{1}{4}$ w				316-470	
R7664		9.1 k	1 w	Fixed	Comp.	5%	303-912	
R7670	101-2509	808 $\Omega$	$\frac{1}{2}$ w	Fixed	Prec.	1%	309-103	
R7670	2510-up	750 $\Omega$	$\frac{1}{2}$ w	Fixed	Prec.	1%	309-327	
R7671		500 $\Omega$		Var.		Cal Adj. #2	311-214	
R7672		15 k	2 w	Fixed	Comp.	5%	305-153	
R7678		470 $\Omega$	$\frac{1}{2}$ w	Fixed	Comp.	5%	301-471	
R7679		12 k	2 w	Fixed	Comp.	5%	305-123	
R7681		2 k		Var.	WW	Cal. Adj. #3	311-209	
R7682		3.3 k	$\frac{1}{2}$ w				302-332	
R7684		10 k		Var.	WW	Cal. Adj. #4	311-204	
R7685		14 k	3 w			1%	*310-577	
R7686		400 k		Var.	WW	COMPAR. VOLTS	311-205	
R7687A		270 k	} Encapsulated					
R7687B		33.33 k						
R7687C		297 k					1%	307-067
R7687D		3.0303 k						
R7688		990 k	1 w	Fixed	Prec.	1%	310-098	
R7689		500 k		Var.	WW	Cal. Adj. #5	311-210	
R8604	101-260X	47 $\Omega$	$\frac{1}{2}$ w				302-470	
R8608		1 meg	$\frac{1}{2}$ w	Fixed	Prec.	1%	309-148	
R8610		47 $\Omega$	$\frac{1}{4}$ w				316-470	
R8614		330 $\Omega$	$\frac{1}{4}$ w				316-331	
R8615		47 $\Omega$	$\frac{1}{4}$ w				316-470	
R8618	101-2509	750 $\Omega$	$\frac{1}{2}$ w	Fixed	Prec.	1%	309-327	
R8618	2510-up	700 $\Omega$	$\frac{1}{2}$ w	Fixed	Prec.	1%	309-083	
R8621		470 k	$\frac{1}{2}$ w	Fixed	Comp.	5%	301-474	
R8622		100 k	$\frac{1}{4}$ w				316-104	
R8623		47 $\Omega$	$\frac{1}{4}$ w				316-470	

**Resistors (continued)**

Tektronix  
Part Number

R8626		1 k	1/4 w					316-102
R8630		47 Ω	1/4 w					316-470
R8632		500 Ω	1/2 w	Fixed	Prec.	1%		309-250
R8634		1.582 k	1/2 w	Fixed	Prec.	1%		309-029
R8635		47 Ω	1/4 w					316-470
R8636		47 Ω	1/4 w					316-470
R8638	101-2509	470 Ω	1/2 w	Fixed	Comp.	5%		301-471
R8638	2510-up	430 Ω	1/2 w	Fixed	Comp.	5%		301-431
R8639		500 Ω		Var.			GAIN ADJUST	311-005
R8640		220 k	1/2 w	Fixed	Comp.	5%		301-224
R8645		600 Ω	1/2 w	Fixed	Prec.	1%		309-097
R8648		220 Ω	1/2 w	Fixed	Comp.	5%		301-221
R8652		10 meg	1/2 w	Fixed	Prec.	1%		309-095
R8655	101-383	100 k	1/2 w	Fixed	Prec.	1%		309-045
R8655	384-up	100 k	1/2 w	Fixed	Prec.	1%		309-334
R8656	101-383	143 k	1 w	Fixed	Prec.	1%		310-088
R8656	384-up	143 k	1 w	Fixed	Prec.	1%		310-582
R8660		47 Ω	1/4 w					316-470
R8662		47 Ω	1/4 w					316-470
R8664		9.1 k	1 w	Fixed	Comp.	5%		303-912
R8670		17 k	3 w	Fixed	Mica Plate	1%		*310-578
R8672		3.6 k	1/2 w	Fixed	Comp.	5%		301-362
R8673	101-2509	808 Ω	1/2 w	Fixed	Prec.	1%		309-103
R8673	2510-up	750 Ω	1/2 w	Fixed	Prec.	1%		309-327
R8674		500 Ω		Var.	WW		Cal. Adj. #1	311-214
R8676		12 k	2 w	Fixed	Comp.	5%		305-123
R8677		4.7 k	1 w					304-472
R8691		9.1 k	2 w	Fixed	Comp.	5%		305-912

**Switches**

Wired Unwired

SW7600		Slide	AC-DC					Use 260-408
SW7602		Pushbutton	PUSH TO DISCONNECT SIGNAL					260-324
SW7610		Turret Atten. complete	VOLTS/CM "A"					*263-004
	X3564-up	Turret Body, wired†						*204-128
SW7611		Rotary	INPUT SELECTOR				Use *262-481	*260-344
SW7670		Lever	COMPARISON VOLTAGE (Polarity)					*260-345
SW7680		Lever	COMPARISON VOLTAGE					*260-346
SW8600	101-1829	Slide	AC-DC					260-145
SW8600	1830-up	Slide	AC-DC					*260-408
SW8602		Pushbutton	PUSH TO DISCONNECT SIGNAL					260-324
SW8610		Turret Atten. complete	VOLTS/CM "B"					*263-005
	X3564-up	Turret Body, wired†						*204-128

**Transformer**

T8695		Power						*120-177
-------	--	-------	--	--	--	--	--	----------

**Transistors**

Q7618	101-2509	2N1302						151-040
Q7618	2510-up	RT5204						151-058
Q7644		2N1517						151-031
Q7672		2N1102						151-026
Q7674	101-2509	2N1303						151-041
Q7674	2510-up	J3138						151-087
Q8618	101-2509	2N1302						151-040
Q8618	2510-up	RT5204						151-058
Q8638	101-2509	2N1302						151-040
Q8638	2510-up	RT5204						151-058

† Below S/N 3564 order for wired turret body \*263-004 or \*263-005.

**Transistors (continued)**

			Tektronix Part Number
Q8644		2N1517	151-031
Q8672		2N1102	151-026
Q8674	101-2509	2N1302	151-040
Q8674	2510-up	RT5204	151-058

**Electron Tubes**

V7613†		6AK5	Selected	*157-063
V7618		6DJ8		154-187
V7623		12AT7		154-039
V7634‡		12AU6	Selected	use *157-038
V7663		12AT7		154-039
V7689		OG3	Selected	*157-064
V8613†		6AK5	Selected	*157-063
V8623		12AT7		154-039
V8634‡		12AU6	Selected	use *157-038
V8638		6DJ8		154-187

† V7613 & V8613. Furnished as a unit.

‡ V7634 and V8634. Furnished as a unit.

NOTE: Four ferrite beads (ferramic suppressors) are found in the Type Z Unit, two ahead of each turret attenuator. If replacement of these becomes necessary, order by the Tektronix Part Number 276-507.

# PARTS LIST

## "Z" Turret Attenuators

Values are fixed unless marked Variable.

### Capacitors

Tolerance  $\pm 20\%$  unless otherwise indicated.

Ckt. No.	S/N Range	Description				Tektronix Part Number
C407				Adjusting Slug		214-084
C408A	Selected	Nominal Value	1.5 pf			281-529
C408B				Adjusting Slug		214-084
C408C				Adjusting Slug		214-084
C408D	5.6 pf		Cer.	500 v		281-544
C409A	Selected	Nominal Value	3.3 pf			281-534
C409B				Adjusting Slug		214-084
C409C				Adjusting Slug		214-084
C410A	Selected	Nominal Value	3.3 pf			281-534
C410B				Adjusting Slug		214-084
C410C				Adjusting Slug		214-084
C410E	12 pf		Cer.	500 v		281-508
C411A	Selected	Nominal Value	3.3 pf			281-534
C411B				Adjusting Slug		214-084
C411C				Adjusting Slug		214-084
C411E	47 pf		Cer.	500 v		281-519
C412A	Selected	Nominal Value	3.3 pf			281-534
C412B				Adjusting Slug		214-084
C412C				Adjusting Slug		214-084
C412E	100 pf		Cer.	500 v		281-530
C413A	Selected	Nominal Value	3.3 pf			281-534
C413B				Adjusting Slug		214-084
C413C				Adjusting Slug		214-084
C413E	200 pf		Mica	500 v	10%	†283-557
C414A	Selected	Nominal Value	3.3 pf			281-534
C414B				Adjusting Slug		214-084
C414C				Adjusting Slug		214-084
C414E	400 pf		Mica	500 v	10%	†283-556
C415A	Selected	Nominal Value		4.7 pf		281-501
C415B				Adjusting Slug		214-084
C415C				Adjusting Slug		214-084
C415E	625 pf		Mica	500 v	10%	†283-547

### Resistors

Resistors are fixed, composition,  $\pm 10\%$  unless otherwise indicated.

R407C	X261-up	47 $\Omega$	$\frac{1}{4}$ w		10%	316-470
R408C		500 k	$\frac{1}{2}$ w	Prec.	1%	309-140
R408E		1 meg	$\frac{1}{8}$ w	Prec.	1%	318-004
R409C		800 k	$\frac{1}{2}$ w	Prec.	1%	309-288
R409E		250 k	$\frac{1}{8}$ w	Prec.	1%	318-032

**Resistors (continued)**

					Tektronix Part Number
R410C	900 k	1/2 w	Prec.	1%	309-142
R410E	111 k	1/8 w	Prec.	1%	318-006
R411C	950 k	1/2 w	Prec.	1%	309-143
R411E	52.6 k	1/8 w	Prec.	1%	318-007
R412C	980 k	1/2 w	Prec.	1%	309-277
R412E	20.4 k	1/8 w	Prec.	1%	318-033
R413C	990 k	1/2 w	Prec.	1%	309-145
R413E	10.1 k	1/8 w	Prec.	1%	318-009
R414C	995 k	1/2 w	Prec.	1%	309-146
R414E	5.03 k	1/8 w	Prec.	1%	318-010
R415C	998 k	1/2 w	Prec.	1%	309-278
R415E	2 k	1/8 w	Prec.	1%	318-034

**Turret Assemblies**

SW7610	VOLTS/CM "A"	Turret Attenuator Complete	*263-004
		Turret Body, Wired	*204-128
SW8610	VOLTS/CM "B"	Turret Attenuator Complete	*263-005
		Turret Body, Wired	*204-128

**Miscellaneous Hardware**

QUANTITY	DESCRIPTION	PART NO.
17	Teflon Tubing-Shrink-on	162-027
2	End Caps	200-191
18	Capacitor Barrels	Use 204-127
1	Body Rear	204-025
1	Body Front	204-026
18	Hair Pin Cotter	214-085
1	Ground Ring	354-080

†Button capacitors part numbers 283-547, 283-556 and 283-557 are installed at the factory by a special process. If replacement is necessary, order a wired turret body, part number 204-128 (S/N 3564-up). Below S/N 3564 order 263-004 or 263-005 for wired turret body.

# Type Z Mechanical Parts List

	Part Number
BODY, CAP. BARREL FOR TURRET ATTEN. SN 101-3563	Tektronix 204-024
BODY, CAP. BARREL FOR TURRET ATTEN. SN 3564-up	204-127
BRACKET, ALUM., POT, .064 x 1 <sup>1</sup> / <sub>8</sub> x 2 <sup>5</sup> / <sub>8</sub> x 1 <sup>1</sup> / <sub>2</sub>	406-584
BRACKET, ALUM., TRANSISOR MTG., .050 x 7 <sup>1</sup> / <sub>16</sub> x 1 <sup>3</sup> / <sub>8</sub>	406-585
BRACKET, ALUM., SWITCH, .040 x 2 <sup>7</sup> / <sub>8</sub> x 1 <sup>1</sup> / <sub>2</sub>	406-586
BRACKET, RESISTOR MTG., .063 x 1 <sup>7</sup> / <sub>8</sub> x 1 <sup>5</sup> / <sub>16</sub> x 9 <sup>1</sup> / <sub>16</sub>	406-593
BUSHING, ALUM., 3 <sup>1</sup> / <sub>8</sub> -32 x 9 <sup>1</sup> / <sub>16</sub> x .412	358-010
BUSHING, BRASS, HEX 3 <sup>1</sup> / <sub>8</sub> -32 x 1 <sup>3</sup> / <sub>32</sub> x .252	358-029
BUSHING, BANANA JACK, 1 <sup>1</sup> / <sub>4</sub> -32 x 1 <sup>3</sup> / <sub>32</sub> x .159 x .375	358-054
CABLE, HARNESS SN 101-260	179-429
CABLE, HARNESS SN 261-up	179-505
CAP, BLACK PUSH BUTTON	200-114
CAP POT, POLY., 1" dia.	200-247
CHASSIS	441-321
CONNECTOR, CHASSIS MT., 16 contact, male	131-017
CONNECTOR, CHASSIS MT., 1 contact, female SN 101-3709	131-081
CONNECTOR, CHASSIS MT., 1 contact, BNC SN 3710-up	131-126
DIAL, DUODIAL FOR HELIPOT	331-003
GROMMET, RUBBER 1 <sup>1</sup> / <sub>4</sub>	348-002
GROMMET, RUBBER 3 <sup>1</sup> / <sub>8</sub>	348-004
KNOB, LARGE BLACK	366-029
KNOB, SMALL RED	366-031
KNOB, SMALL BLACK .780 x .591, 1 <sup>1</sup> / <sub>4</sub> hole part way	366-044
KNOB, ASS'Y of 366-239 & 366-240	use 366-244
KNOB, INNER (101-3175)	use 366-244
KNOB, INNER (3176-up)	366-240
KNOB, OUTER	use 366-239
KNOB, PLUG-IN SECURING	366-125
LOCKWASHER, STEEL INT. #2	210-001
LOCKWASHER, STEEL INT. #4	210-004
LOCKWASHER, STEEL INT. #6	210-006
LOCKWASHER, STEEL INT. 1 <sup>1</sup> / <sub>4</sub>	210-011
LOCKWASHER, STEEL INT. POT, 3 <sup>1</sup> / <sub>8</sub> x 1 <sup>1</sup> / <sub>2</sub>	210-012
LOCKWASHER, STEEL INT. 3 <sup>1</sup> / <sub>8</sub> x 1 <sup>1</sup> / <sub>16</sub>	210-013
LOCKWASHER, INT. 1 <sup>1</sup> / <sub>4</sub>	210-046
LUG, SOLDER SE4	210-201
LUG, SOLDER SE6, long	210-203
LUG, SOLDER POT, plain, 3 <sup>1</sup> / <sub>8</sub>	210-207
LUG, GROUND .025 x 1 <sup>5</sup> / <sub>16</sub>	210-241
NUT, HEX 2-56 x 3 <sup>1</sup> / <sub>16</sub>	210-405

**Mechanical Parts List** (continued)

	Tektronix Part Number
NUT, HEX 4-40 x 3/16	210-406
NUT, HEX 6-32 x 1/4	210-407
NUT, HEX 3/8-32 x 1/2	210-413
NUT, HEX 1/4-28 x 3/8 x 3/32	210-455
NUT, HEX 6-32 x 5/16	210-457
PANEL, FRONT	333-575
PLATE, SUB PANEL	387-225
PLATE, FRAME BACK	387-226
POST, BINDING	129-051
RING, RETAINING	354-025
ROD, EXTENSION 2 3/16 x .210	384-194
ROD, FRAME 3/8 x 8 7/8	384-508
ROD, SECURING 3/16 x 10 1/2	384-510
ROD, SPACING 3/8 x 3 9/16	384-559
ROD, HEX, ALUM., 1/2 x 1 1/4, TAP 3/8-32 (replaced by 385-158)	385-148
ROD, HEX, ALUM., 1/2 x 1 5/16, TAP 3/8-32 (see 385-148)	385-158
SCREW 4-40 x 3/16 BHS	211-007
SCREW 4-40 x 1/4 BHS	211-008
SCREW 4-40 x 3/4 RHS	211-017
SCREW 2-56 x 1 5/8 PHS	211-059
SCREW 6-32 x 1/4 BHS	211-504
SCREW 6-32 x 5/16 BHS	211-507
SCREW 6-32 x 3/8 FHS, 100°, Phillips	211-559
SCREW 8-32 x 1/2 FHS, 100°, Phillips	212-043
SCREW 8-32 x 1/2 RHS, Phillips	212-044
SCREW, THREAD CUTTING, 4-40 x 1/4 PHS, Phillips	213-035
SCREW, THREAD CUTTING, 5-32 x 3/16 PAN H STEEL, Phillips	213-044
SCREW, 2-32 x 5/16 RHS, Phillips	213-113
SHIELD, ATTENUATOR, BRASS	337-374
SOCKET, STM9G	136-015
SOCKET, 7 PIN UHF MIN.	136-071
SOCKET, 9 PIN UHF MIN.	136-072
SOCKET, 4 PIN, TRANSISTOR	136-095
SOCKET, TIP, JACK, BLACK NYLON	136-098
SPACER, NYLON 1/16 (for ceramic strip)	361-007
SPACER, NYLON 5/16 (for ceramic strip)	361-009

**Mechanical Parts List** (continued)

	Tektronix Part Number
STRIP, CERAMIC $\frac{7}{16} \times 5$ notches, clip mounted	124-093
STRIP, CERAMIC $\frac{7}{16} \times 7$ notches, clip mounted	124-094
STRIP, CERAMIC $\frac{7}{16} \times 9$ notches, clip mounted	124-095
STRIP, CERAMIC $\frac{7}{16} \times 11$ notches, clip mounted	124-106
TAG, SERIAL NO. INSERT	334-679
TUBING, PLASTIC INSUL., #20 black (skein)	162-504
WASHER, STEEL, .390 x $\frac{9}{16}$ x .020	210-840
WASHER, STEEL, .093 x $\frac{9}{32}$ x .020	210-850
WASHER, POLY	210-894



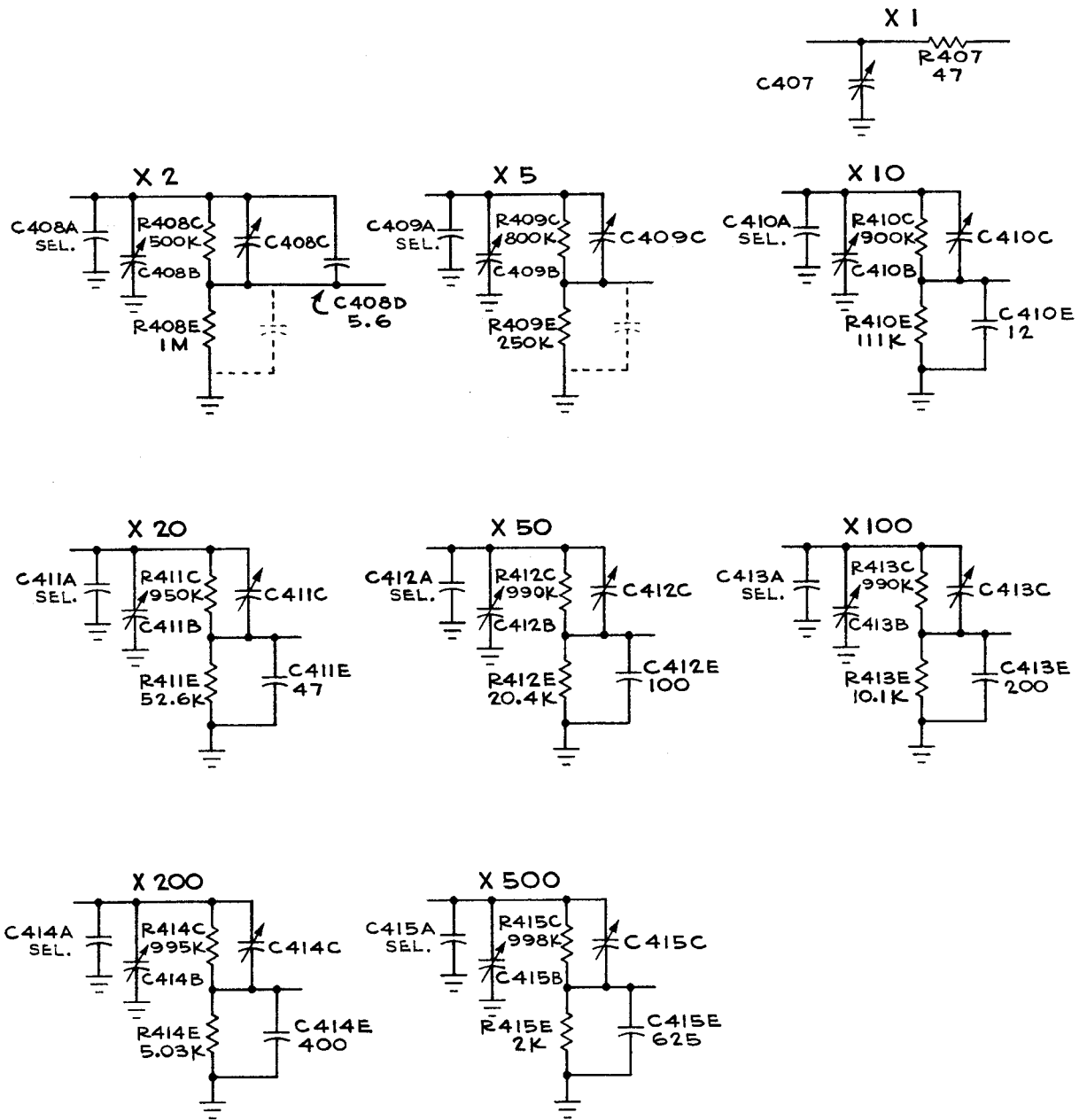

## Z TURRET ATTENUATOR

NOTE:-  
ALL VARIABLE CAPACITORS ARE APPROX. .3 - 20  $\mu$ F.

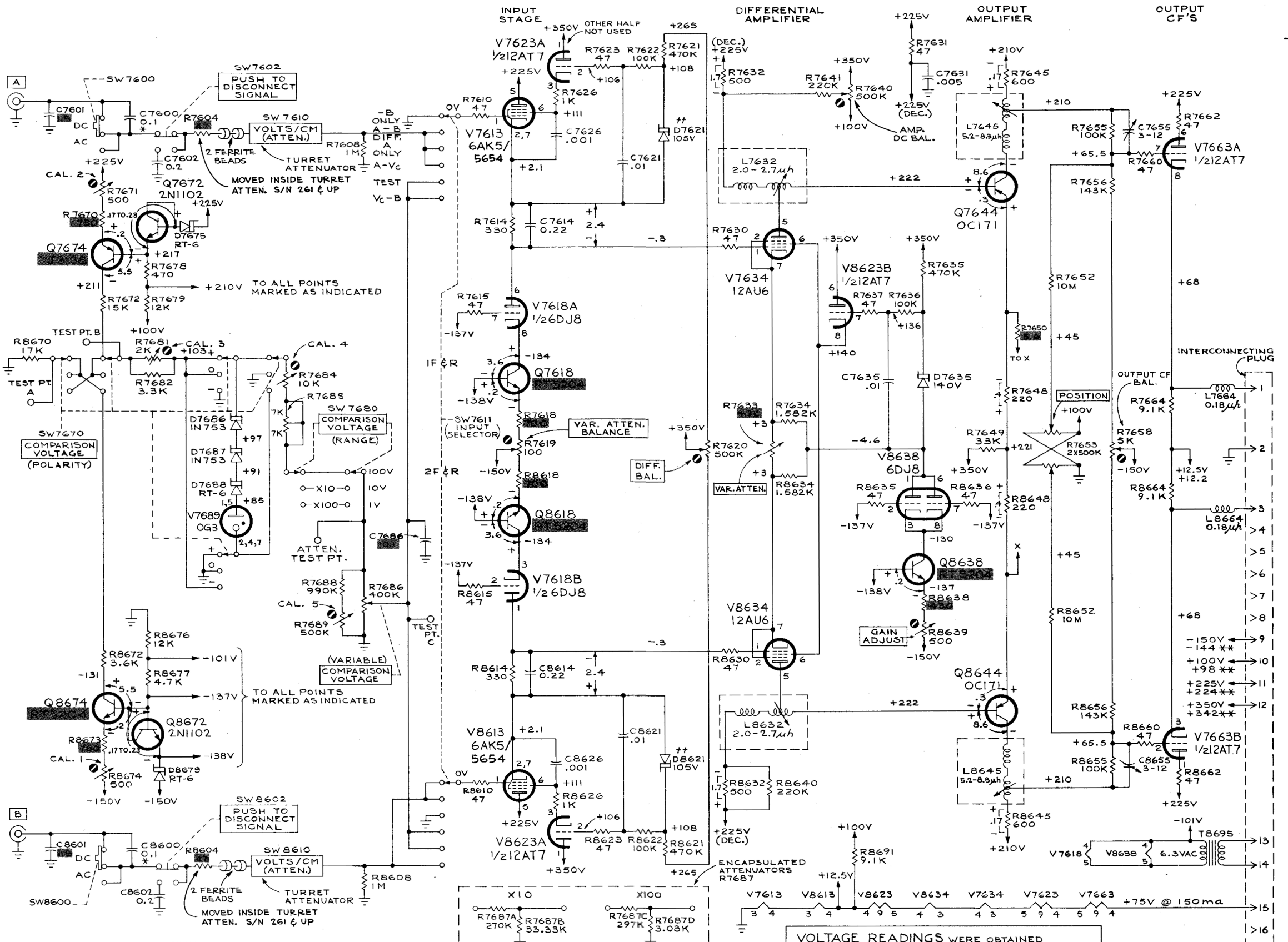

\* MATCHED TO 1%  
 \*\* MATCHED TO WITHIN 2V OVER RANGE OF 95V TO 115V

SEE PARTS LIST FOR EARLIER VALUES AND S/N CHANGES OF PARTS MARKED WITH RED TINT BLOCKS

VOLTAGE READINGS WERE OBTAINED WITH Z UNIT IN OSCILLOSCOPE HAVING DECOUPLED REGULATED SUPPLY VOLTAGES TEST MODE POLARITY VAR. ATTEN. O CLOCKWISE

\*\* DECOUPLED REGULATED SUPPLY VOLTAGES

TYPE Z PLUG-IN UNIT A CALIB. DIFF. COMP. MRH 9-21-61

CALIBRATED DIFFERENTIAL COMPARATOR

## **MANUAL CHANGE INFORMATION**

At Tektronix, we continually strive to keep up with latest electronic developments by adding circuit and component improvements to our instruments as soon as they are developed and tested.

Sometimes, due to printing and shipping requirements, we can't get these changes immediately into printed manuals. Hence, your manual may contain new change information on following pages. If it does not, your manual is correct as printed.