

9822 PROGRAMMABLE

MULTI-FUNCTION

CALIBRATOR



TECHNICAL MANUAL

9822 MULTI-FUNCTION AC/DC CALIBRATOR

All Time Electronics' instruments are subject to continuous development and improvement and in consequence may incorporate minor detail changes from the information contained herein.

9822 PROGRAMMABLE MULTI-FUNCTION CALIBRATOR TECHNICAL MANUAL

**TIME ELECTRONICS LTD
BOTANY INDUSTRIAL ESTATE
TONBRIDGE
KENT, TN9 1RH, ENGLAND**

Tel: 01732 355993 Fax: 01732 770312
Email: time-electronics@dial.pipex.com
Web Page: www.time-electronics.co.uk

TECHNICAL MANUAL CONTENTS

1)	INTRODUCTION	3
2)	SPECIFICATION	5
3)	FRONT PANEL CONTROLS	9
4)	LOCAL OPERATION	14
5)	REMOTE OPERATION	22
6)	FAULT DIAGNOSIS	33
7)	TECHNICAL DESCRIPTION	36
8)	CALIBRATION TECHNIQUES	40
9)	CALIBRATION	43
10)	SPARE PARTS	48
11)	GUARANTEE AND SERVICE FACILITIES	49
12)	DIAGRAMS AND LAYOUTS	50
13)	INDEX	51

SECTION 1. INTRODUCTION

1.1 DESCRIPTION

This calibrator provides, in one instrument, calibration facilities for AC/DC Volts, AC/DC Current and Resistance.

Simple controls and a clear, 8 digit LED display make operation straight forward. Remote operation via the IEEE (GPIB) bus is a standard feature and allows the instrument to be used for automatic calibration. All logic functions are controlled by a microprocessor, which also monitors the output. On overload, the output is automatically switched off and an error message is displayed. Safety features are incorporated for high voltage outputs. The instrument is supplied in a high quality 19" Eurocard frame and is suitable for either bench use or mounting in a 19" rack system.

Ranges:-

D.C. Voltages 20 mV to 1 KV (1.1 KV in over-range)

A.C. Voltages (RMS) . 20 mV to 1 KV

D.C. Current 200 μ A to 10 A (11 A in over-range)

A.C. Current 200 μ A to 10 A

Resistance 7 Decade values from 10 Ohms to 10 M Ohms

The D.C. Voltage and Current ranges allow a 4% over-range on the lower ranges, with 10 % over-range on the 10 Amp and 1 KV ranges, giving a maximum output of 1100 V or 11 Amps D.C.

The Deviation function allows the output to be adjusted in percentage terms by +/- 10%.

The Zero Offset allows the use of zero to be offset by a preset value.

The combination of Deviation and Zero Offset is particularly useful for linearity checking.

'User' function allows operating modes to be changed by the user.

See section 4 for details.

A self-test program is available and can be run at any time to check that all digital functions are operating correctly.

NOTE: If an output error is detected during normal operation 'OP ERROR' is displayed.

The autocal facility enables calibration from the front panel or via the IEEE bus. To prevent calibration by unauthorised personnel, this function can only be selected by insertion of a plug into the socket on the rear panel.

A Multical Automatic Calibration System can be configured by adding an IEEE bus controller, display monitor, floppy disk and printer.

1.2 SAFETY

Emphasis has been placed on safety features. The 200 V, 1 KV and 10 Amp ranges have separate output terminals.

EEC safety regulations require that an additional operation must be performed before voltages greater than 40 V can be generated.

Additionally there is a 3 second delay and an audible warning before the voltage appears on the output terminals. This important feature ensures that high voltages cannot be accidentally selected, prevents damage to the equipment being calibrated and minimises the chance of an electric shock to the operator.

As a further warning, an indicator on the left side of the display flashes at all times when a high voltage is present at the output terminals.

SECTION 2. SPECIFICATIONS

MAINS OPERATING VOLTAGE

240 V SELECTED : 200 - 260 V A.C. 50 / 60 Hz

110 V SELECTED : 100 - 120 V A.C. 50 / 60 Hz

MAINS CONNECTOR

I.E.C. PLUG.

IEEE CONNECTOR

24 Pin Connector in accordance with IEEE STD. 488, 1978

IEEE ADDRESS SECTION

8 Way DIL switch on rear panel.

POWER CONSUMPTION

(No Output) 30 Watts.

OPERATING TEMPERATURE RANGE

10°C to 30°C

STANDARD CALIBRATION TEMPERATURE

20°C +/- 1°C

WARM - UP TIME

3 Hours.

DIMENSIONS

520 mm x 160 mm x 320 mm incl. feet. (IN CASE)

Standard 3U 19" Rack Mounting.

WEIGHT

15 Kilos (IN CASE) 10 Kilos (RACK MOUNTED)

OUTPUT CONNECTORS

200 V / 1 KV / 10 A - 4 mm Sockets.

20 mV to 20 V / 200 uA to 2 A / 10 Ohms to 10 M Ohms - Low Thermal EMF Terminals.

MAX. COMMON MODE VOLTAGE.

60 V.D.C., 40 V.A.C.

NOTES : After a range change, Thermal Equilibrium may take some time to be restored, especially after use of the 10 Amp range. An allowance for this must be made.

Compliance Voltages and Output Currents are Peak values, NOT R.M.S., unless otherwise stated.

2.1 9822 SPECIFICATIONS

The accuracy specifications given below only apply at a temperature of 20°C +/-1°C., after a minimum warm-up time of 1 Hour, for 1 year. All specifications apply from 10% to full scale. Specifications are stated as Output + Range and are relative to Calibration Standards.

D.C. VOLTAGE

RANGE	STABILITY 24 HOURS	ACCURACY PPM			T.C. PPM/°C	OUTPUT RESISTANCE	DRIVE CURRENT
		90 DAY	180 DAY	1 YEAR			
20 mV	10 +5	20 +5	25 +5	30 +5	5	10 Ohms	S/C
200 mV	7 +5	20 +5	25 +5	30 +5	4	10 Ohms	S/C
2 V	3 +2	20 +5	25 +5	30 +5	3	0.1 Ohms	100 mA
20 V	3 +2	20 +5	25 +5	30 +5	3	0.1 Ohms	100 mA
200 V	15 +10	35 +10	40 +10	50 +10	5	10 Ohms	10 mA
1 KV	15 +10	35 +20	40 +20	50 +20	5	10 Ohms	10 mA

Note - All specifications +/- 4uV for thermal effects.

A.C. VOLTAGE (SINE WAVE)

RANGE	FREQUENCY	STABILITY 24 HOURS	ACCURACY %			T.C. PPM/°C	OUTPUT RESISTANCE
			90 DAY	180 DAY	1 YEAR		
20 mV	40 Hz-1 KHz	0.01+0.005	0.03+0.008	0.04+0.008	0.05+0.008	15	10 Ohms
200 mV	1-2 KHz	0.03+0.02	0.07+0.05	0.08+0.05	0.1+0.05	15	10 Ohms
2 V	2-20 KHz	0.05+0.03	0.35+0.1	0.4+0.1	0.5+0.1	15	0.1 Ohms
20 V	40 Hz-1KHz	0.02+0.005	0.045+0.01	0.05+0.01	0.06+0.01	15	10 Ohms
200 V	40 Hz-1KHz	0.02+0.005	0.045+0.01	0.05+0.01	0.06+0.01	15	10 Ohms
1 KV	40 Hz-1KHz	0.02+0.005	0.045+0.01	0.05+0.01	0.06+0.01	15	10 Ohms

Note - All specifications +/- 30 uV.

D.C. CURRENT

RANGE	STABILITY 24 HOURS	ACCURACY PPM			T.C. PPM/°C	OUTPUT RESISTANCE	COMPLIANCE VOLTS(TYP)
		90 DAY	180 DAY	1 YEAR			
200 uA	30 +10	50 +30	70 +30	100 +30	10	10 G Ohms	15 V
2 mA	25 +10	50 +30	70 +30	100 +30	10	1 G Ohms	15 V
20 mA	20 +10	50 +30	70 +30	100 +30	10	100 M Ohms	15 V
200 mA	20 +10	50 +30	70 +30	100 +30	10	10 M Ohms	15 V
2 A	20 +10	100 +60	140 +60	200 +60	15	1 M Ohms	5 V
10 A	300 +200	700 +300	800 +300	1000 +300	30	100 K Ohms	1.2 V

Note - All Specifications +/- 30 nA.

A.C. CURRENT (20 Hz TO 1 KHz SINE WAVE)

RANGE	STABILITY 24 HOURS	ACCURACY PPM			T.C. PPM/°C	OUTPUT RESISTANCE	COMPLIANCE VOLTS(TYP)
		90 DAY	180 DAY	1 YEAR			
200 uA	100 +80	400 +100	450 +100	500 +100	20	10 G Ohms	15 V
2 mA	100 +80	400 +100	450 +100	500 +100	20	1 G Ohms	15 V
20 mA	100 +80	400 +100	450 +100	500 +100	20	100 M Ohms	15 V
200 mA	100 +80	400 +100	450 +100	500 +100	20	10 M Ohms	15 V
2 A	200 +80	500 +100	600 +100	700 +100	30	1 M Ohms	5 V
10 A	400 +200	700 +300	800 +300	1000 +300	50	100 K Ohms	1.2 V

Note - All specifications +/- 50 nA. Also 2 and 10 Amp Range specifications to 500 Hz.

RESISTANCE

VALUE OHMS	STABILITY 24 HOURS	ACCURACY PPM			T.C. PPM/°C
		90 DAY	180 DAY	1 YEAR	
10	200	700	750	800	10
100	25	50	60	70	5
1 K	10	25	40	50	5
10 K	8	25	40	50	5
100 K	8	25	40	50	5
1 M	15	60	70	80	5
10 M	60	200	250	300	10

NOTES -

- 1) Frequency - Accuracy +/- 0.01%, Temp Coeff. 20 PPM/°C
Resolution 5Hz, Range 15 Hz To 20 KHz.
- 2) Waveforms - Sine, Square, Ramp Up, Ramp Down, Trapezoidal, Triangular And Half Wave.
- 3) Output Drive - 20 mV And 200 mV = S/C
2 V And 20 V = 100 mA
200 V And 1KV = 10 mA
} A.C. and D.C. VOLTAGE ONLY.
- 4) Noise - 10 mV to 10 V Ranges - 1 ppm of range. (0.1 Hz to 1 Hz RMS)
100 V and 1 KV Ranges - 5 ppm of range. (0.1 Hz to 1 Hz RMS)

A.C. Specifications include effects of distortion and noise in the 10 Hz to 20 KHz frequency range.

2.2 EXPLANATION

The following examples are given as an aid to interpretation of the tables which form the 9822 specification.

(1) D.C. Volts Measurement.

The error in 0.5 V.D.C. output on the 2 V range, 2 months after calibration at the same temperature as the initial calibration, the accuracy will be + / - 24 uV calculated as follows :

OF SETTING TERM :

$$(a) + / - 20 \text{ ppm of } 0.5 \text{ Volts} \quad + / - 10 \text{ uV}$$

OF RANGE TERM :

$$(b) + / - 5 \text{ ppm of } 2 \text{ Volts} \quad + / - 10 \text{ uV}$$

ZERO TERM :

$$(c) + / - 4 \text{ uV} \quad \frac{+ / - 4 \text{ uV}}{24 \text{ uV}}$$

(NOTE : 100 PPM = 0.01%)

(2) A.C. Current Measurement.

The error for a 200 mA output on the 200 mA range, 9 months after calibration at a temperature 5 °C different from the original calibration temperature.

OF SETTING TERM :

$$(a) + / - 400 \text{ ppm of } 200 \text{ mA} \quad + / - 80 \text{ uA}$$

OF RANGE TERM :

$$(b) + / - 100 \text{ ppm of } 200 \text{ mA Range} \quad + / - 20 \text{ uA}$$

TEMPERATURE STABILITY TERM :

$$(d) 20 \text{ ppm/deg} * 5 = 100 \text{ ppm of } 200 \text{ mA} \quad \frac{+ / - 20 \text{ uA}}{120 \text{ uA}}$$

(NOTE : The 'ZERO' term can be missed out as it is very small.)

SECTION 3. FRONT PANEL CONTROLS

3.1 FRONT PANEL (SEE FIG. 3.1)

A) Power Switch

This rocking action switch controls the mains power. The Mains ON/OFF function is by manual operation only and cannot be controlled via the IEEE bus.

B) On Indicator

Indicates the instrument is switched on.

C) Local / Remote Switch

This rocking action switch selects LOCAL operation, which allows manual operation, via the front panel controls (IEEE bus control disabled), or REMOTE operation, which allows control via the IEEE bus (Front panel locked out).

D) Local Indicator

Indicates the instrument is under manual operation via the front panel controls.

E) Remote

Indicates the instrument is being controlled via the IEEE bus.

F) Control Switches

There are 20 switches arranged in two rows. These are located in the centre section of the front panel. Each switch has an LED indicator. The switches have a dual function which are shown on the front panel in RED and BROWN. To obtain the RED function it is necessary to first press the select switch.

In the following descriptions the switches are numbered -

Top Row, left to right : Nos 1 --> 10.

Bottom Row, left to right : Nos 11 --> 20.

The function of the LED indicators on each switch is also explained.

SWITCH 1

DEV% (BROWN) -

Operates in a toggle action to change between deviation display and normal output. See section 4 for operation in Deviation mode.

USR FNC (RED) -

Allows the user to select various operating modes. See section 4 for details.

INDICATOR - ON : Indicates deviation is being displayed.

OFF : No deviation applied.

FLASHING : Nominal output displayed but actual output has deviation applied.

SWITCH 2

'+' (BROWN) - Sets output polarity positive.

'D.C.' (RED) - Selected voltages and current output will be D.C.

INDICATOR - ON : Indicates D.C. selected.

SWITCHES 3 to 8

'▲' (BROWN) - These six switches increment the adjacent digit of the display.

1 KV to 20 mV (RED) - These 6 switches select the voltage ranges.

INDICATOR - ON : Indicates range selected.

SWITCH 9

'▲' (BROWN) - Increments the least significant digit of the output display.

Res (K Ohm) (RED) - Selects the Resistance function.

INDICATOR - ON : Indicates Resistance function selected.

SWITCH 10

'FS' (BROWN) - Automatically selects full scale output.

'HV ON' (RED) - The safety interlock key for selection of outputs greater than 40 V. See Section 4.

INDICATOR - Not used.

SWITCH 11

'SELECT' (RED) - This single function switch selects the red identified functions. This switch should be pressed and released before pressing another switch.

INDICATOR - ON : Indicates that the next switch pressed will select a 'RED' function..

OFF : Indicates that the next switch pressed will select a BROWN function.

SWITCH 12

' - ' (BROWN) - Sets output polarity negative.

'A.C.' (RED) - Selected Voltage and Current outputs will be A.C.

INDICATOR - ON : Indicates A.C. is selected.

SWITCHES 13 to 18

'▼' (BROWN) . These six switches decrement the adjacent digit of the output display.

'10 A' to '200 uA' (RED) - These switches select the current ranges.

INDICATOR - ON : Indicates range selected.

SWITCH 19

'▼' (BROWN) - Decrements the least significant digit of the output display.

'FREQ / WAVE' (RED) - Allows frequency and waveform to be selected. See Section 4 for operation.

INDICATOR - ON : Indicates frequency and waveform can be selected.

SWITCH 20

'ZERO' (BROWN) - Sets output to zero.

'OFFSET STORE' (RED) - Allows an offset to be applied to the output. See Section 4 for operation.

INDICATOR - Not used.

G) 8 Digit LED Display

Displays the set output, deviation and USR Functions.

H) V Indicator

Indicates the output is 'VOLTAGE'.

I) I Indicator

Indicates the output is 'CURRENT'.

J) R Indicator

Indicates the output is 'RESISTANCE'.

K) Data Light

Flashes when data transfer is taking place on the IEEE Bus. (Remote operation). It also flashes during manual operations.

L) 10 Amp Indicator

Indicates the 10 Amp sockets are active.

M) H.V. Indicator

Indicates the H.V. (High Voltage) sockets are active.

N) H.V. Output Sockets

3 x 4 mm sockets (Red, Black, Green) for the 200 V and 1 KV output.

Red is Positive.

Black is Negative.

Green is Mains Earth.

O) 10 Amp Output Sockets

3 x 4 mm (Red, Black, Green) sockets for 10 Amp output.

P) V/I/R Output Terminals

3 x 4 mm (Red, Black, Green) low thermal EMF terminals for the 20 mV to 20V, 200 μ A to 2 A and Resistance ranges.

3.2 REAR PANEL (SEE FIG 3.2)

- A. AUTO-CAL SECURITY SOCKET
- B. IEEE ADDRESS SELECTION SWITCH
- C. IEEE CONNECTOR
- D. MAINS POWER CONNECTOR
- E. MAINS VOLTAGE SELECTOR
- F. MAINS FUSES

FIGURE 3.1 FRONT PANEL

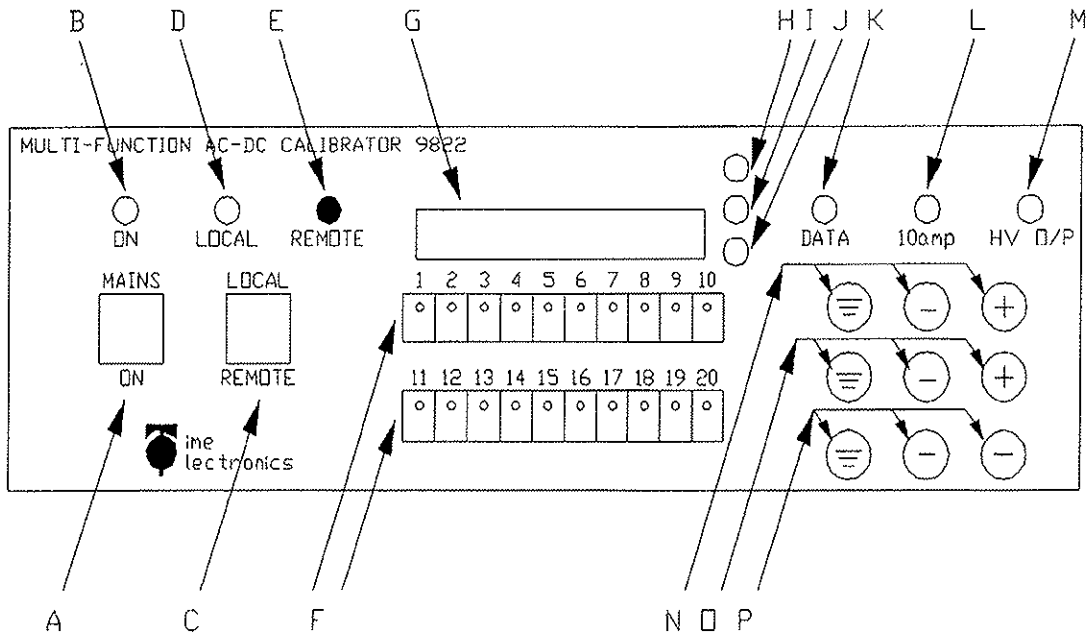
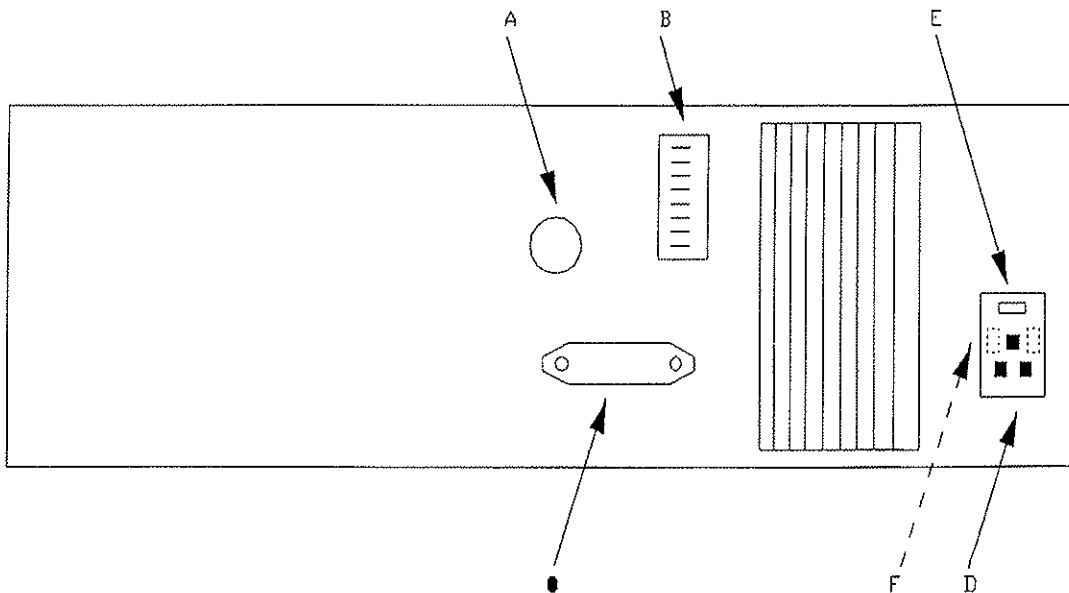

FIGURE 3.2 REAR PANEL



SECTION 4. LOCAL OPERATION

4.1 MAINS VOLTAGE SELECTION

Situated at the rear of the instrument, on the power module, are the mains inlet socket, two fuses and the voltage selector. The mains voltage is displayed in a small window. Access to the fuses and mains selector is via a lever down flap. To change the mains voltage, switch off the mains, remove the lead, open the flap and replace the selector in the required position. Replace the selector and close the flap.

4.2 SWITCHING ON

At power on, the instrument will display the PROM version number and then switch to the 20 mV D.C. range and select zero output.

If 'ERROR 6' is displayed, the calibration factors have been lost and the unit will need to be re-calibrated. See section 9.

IMPORTANT NOTE : This instrument should not normally be operated with the IEEE address 0 or 16 set, or with the the calibration key in. These addresses are reserved for autocal recalibration. Operation in this condition may result in the loss of the calibration factors.

4.3 OPERATION

Manual operation of the instrument is enabled by setting the instrument into LOCAL mode and selecting the required function.

4.4 SELECTING A.D.C. RANGE AND OUTPUT VALUE

- 1.) Press SELECT
- 2.) Press a VOLTAGE or CURRENT range key.
- 3.) Press the + or - switch to select output polarity.
- 4.) Press switches marked with upward or downward arrows to increment or decrement the output.
- 5.) Full scale or Zero output can be selected directly by pressing the F.S. or Zero keys.
- 6.) A) OFFSET - Set up the offset required as an output as described above. Then press SELECT followed by OFFSET STORE. This value will then be stored, and added to or subtracted from (if a negative offset was set) any output value subsequently selected.

During the period when the offset is in use, the left hand digit of the display will show a flashing horizontal bar.

To cancel offset, press SELECT and reselect a range.

- B) Percentage Deviation - This can be applied to the output as follows :
Press DEV%. The display will change to a 5 - Digit format indicating percent age deviation. This can be set in the range of -9.9999% to +9.9999% by pressing the arrowed increment or decrement switches. To return to the normal output display, press DEV% again. When a deviation has been set, the LED on the DEV% switch will flash as a reminder that a deviation is being applied to the output.

To cancel deviation mode press SELECT and reselect a range, or zero the deviation and press 'DEV%' to return to the output display.

4.5 SELECTING A HIGH VOLTAGE OUTPUT

The 200 V and 1 KV ranges use the HIGH VOLTAGE output terminals. The H.V. OUTPUT LED will also light and a bleep will be heard every seven seconds.

Present EEC regulations require additional safety features to be incorporated when output voltages in excess of 40 V can be selected. If the total value of the selected output plus any deviation and zero offset is greater than 40 V, an operation additional to a normal selection is required to obtain an output. Note that this operation can be modified by User Function 4. (See paragraph 4.8)

- 1.) Select the required output on the display.
- 2.) Press SELECT followed by HV ON. The SELECT LED will flash.
- 3.) A buzzer will sound and within 3 seconds the output will ramp up to the selected value.
- 4.) When the output reaches the selected value, the SELECT LED will stop flashing, but the dot at the left hand end of the display will continually flash all the time a high voltage is present at the output terminals.

NOTES :

- A) There will also be a delay in obtaining an output if the polarity of a high voltage is reversed. This is carried out as follows -

Select Polarity
Press SELECT
Press HV ON

- B) When a high voltage range is selected, the instrument cannot be switched from A.C. to D.C. or vice versa. To do this, a low voltage range must first be selected.
- C) Only D.C. and 40 Hz - 400 Hz Sine Wave outputs are allowed on the H.V. ranges.
- D) See Section 8.7 for Earthing of the High Voltage output.

4.6. SELECTING AN A.C. RANGE, FREQUENCY/WAVEFORM & OUTPUT

1.) The selection of A.C. range and output is identical to the D.C. selection procedure described in the previous paragraphs. Deviation and offset values are available, but it should be noted that any offset is an A.C. offset, not D.C.

2.) To select a 60 Hz sinewave after power on, press SELECT followed by A.C. The A.C. LED will light.

3.) If a change of frequency or waveform is required the selection procedure is as follows :-

A) Press SELECT

B) Press FREQ. The display will show :-

1_00060

The left hand digit indicates the type of waveform (see table 4.1 and Fig 4.1 on page 22). The right hand 5 digits represent the frequency in Hz. The example above shows that a 60Hz sine wave has been selected.

C) To change the output waveform, increment or decrement the waveform digit using the arrowed switches beneath the waveform number.

D) The frequency may be incremented or decremented by pressing the keys below the displayed frequency value. Any frequency between 15Hz and 20KHz in 5Hz steps may be selected.

4.) Full wave rectified outputs of waveforms 1, 5 and 6 are available by selecting the negative polarity (-) switch. The display will show the selected A.C. output preceded by a minus sign. Note that the frequency of all the waveforms will double and the R.M.S. values of the sine wave will remain the same.

5.) Some examples of uses of the different waveforms follows.

A) Square wave - Checking the performance of true RMS meters. The meter reading should hardly alter when changing from sine to square wave.

B) Ramp up / Ramp down - Checking the linearity of chart recorders.

C) Triangular - Stiction test for analogue meters.

D) Trapezoidal - Checking oscilloscope amplitude and trigger calibration.

E) Full wave - Checking the DC coupled performance of a true RMS DVM.

TABLE 4.1 TYPES OF WAVEFORM

DIGIT	WAVEFORM	CALIBRATED IN
1	SINE	RMS
2	SQUARE	PK/PKx2
3	RAMP UP	PK/PK
4	RAMP DOWN	PK/PK
5	TRIANGULAR	PK/PKx2
6	TRAPEZOIDAL	PK/PKx2
7	D.C.	-

NOTE : Only Sine Wave and D.C. available on H.V. ranges.

4.7 SELECTING A RESISTANCE

- 1.) Press SELECT and RES (K) . The display will show 0.01K (i.e. 10 Ohms).
- 2.) Press the top row arrowed switches to select a resistance value between 10 Ohms and 10 M Ohms. Values can be set in decades only.
- 3.) Note that Deviation and Offset are not available on the resistance ranges.

4.8 SELECTING A USER FUNCTION

User Functions can be displayed by pressing 'SELECT' followed by 'USR FNC'. The 3 user functions can be changed by pressing the keys immediately below the digit.

Display shows :-

0	0	301
DIGIT No. 1	-	8

Table 4.2 lists the functions controlled by each digit.

TABLE 4.2 USER FUNCTIONS

DIGIT	FUNCTION
1	No Function
2	No Function
3	No Function
4	HIGH VOLTAGE SET-UP CONTROL - See table 4.3
5	No Function
6	SET KEYBOARD OPERATING MODE - See table 4.4
7	No Function
8	SET OUTPUT ERROR MODE

DIGIT 4 : HIGH VOLTAGE SET-UP CONTROLS**TABLE 4.3 HIGH VOLTAGE SET-UP CONTROL**

MODE	ALARM	RAMP	SAFETY INTERLOCK KEY
0	Y	Y	Y
1	N	Y	Y
2	Y	N	Y
3	N	N	Y
4	Y	Y	N
5	N	Y	N
6	Y	N	N
7	N	N	N

NOTE : The safety interlock key in this table is an additional feature incorporated to prevent the inadvertent application of dangerous voltages to the output terminals. Selection of modes 4 - 7 of this user function however, overcome this safety feature and users must be aware of the dangers especially in Mode 7 in which the voltage is applied to the terminals without warning.

DIGIT 6 : KEYBOARD OPERATING MODES

This function allows four different modes of carry-over with or without auto-repeat as shown in table 4.4. Selection of the carry-over function enables a 9 to 10 carry-over. Without it, the carry-over will be 9 to 0.

TABLE 4.4 KEYBOARD OPERATING MODES

MODE	CARRY OVER	AUTO REPEAT
0	N	N
1	Y	N
2	N	Y
3	Y	Y

The auto-repeat facility, available in modes 2 or 3, gives continuous repetition of the held down key.

DIGIT 8 : OUTPUT ERROR MODES

Output Errors are detected when the calibrator is unable to drive the load with the selected output, e.g. a short circuit on a voltage range or an open circuit on a current range.

NOTE : Output errors are not detected on the 20mV, 200mV and Resistance ranges.

The user can select one of four ways in which the unit will respond to an output error.

Mode 1. The output will be set to zero immediately and 'OP ERROR' displayed. To continue using the instrument, the fault must be rectified and the output re-selected. The display will then show the re-selected value.

Mode 2. The output will be set to zero immediately and 'OP ERROR' displayed. The output will be reinstated if the overload disappears and the previous output value displayed.

Mode 3. Upon detection of an error, the instrument will wait for 0.5 seconds before setting the output to zero and displaying 'OP ERROR'. The fault must be rectified and the output re-selected.

Mode 4. The instrument will continue to drive the output and 'OP ERROR' will be displayed after 0.5 seconds.

4.9 SELF TEST MODE

To select self test mode, set all 8 IEEE switches (on rear of unit) to the ON position before switching on the instrument.

When switched on, the instrument will carry out an internal test sequence as follows. Each segment of the 8 digit display will light in turn, followed by all the front panel LEDs (with the exception of the F.S., ZERO, + & - LEDs which are not tested). If no errors are detected, the word 'PASS' will appear on the display.

If an error is detected, the word ERROR followed with a number from 1 to 6 will be displayed. The meaning of these numbers is explained in table 4.5

TABLE 4.5 FAULT DISPLAYS

<u>NUMBER</u>	<u>FAULT</u>	<u>REPLACE</u>
1	RAM	Processor board
2	GPIO	IEEE board
4	PIA	Processor board. (IC1 6821)
5	PIA	Processor board. (IC2 6821)
6	CAL RAM	Calibration RAM (X2816)
8	CAL RAM	Calibration RAM (X2816)

See section 6 for details of board replacement.

*** ERROR 6**

This test is carried out every time the unit is switched on regardless of the IEEE address. If the calibration factors are corrupted ERROR 6 will be displayed. To clear this condition, run the self test with the calibration key plugged in. This exercise leaves the calibration RAM empty so re-calibration is required. (See Section 9).

If ERROR 6 persists, then change the non-volatile RAM.

NOTE: Running self test with the calibration key plugged in will result in the loss of calibration data.

To exit from self test mode, turn the instrument off, set the unit address on the IEEE switches and switch on again.

4.10 STICTION TEST.

This test enables the movement of an analogue meter needle to be checked if the user suspects that it is sticking at certain points. To carry out this test, proceed as follows.-

- A) Press SELECT.
- B) Press **FREQ/WAVE**.
- C) Select waveform 5.
- D) Press Zero key to select 0.025Hz frequency output. Display shows *5 00000*.
- E) Select a full range suitable for the meter under test.
- F) The meter needle will move smoothly up and down if the scale is stiction free.

FIG.4.1 - A.C. WAVEFORMS

Waveform 1:
1V R.M.S. Sine wave.

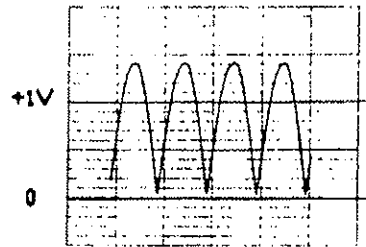
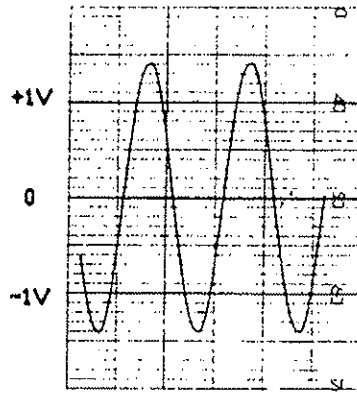

FULL WAVE RECTIFIED
[Obtained by selecting
negative polarity]

Waveform 2:
1V R.M.S. Square wave.

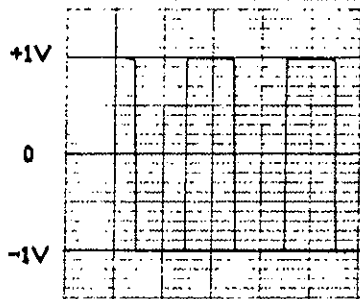

Waveform 3:
Sawtooth (Ramp up)

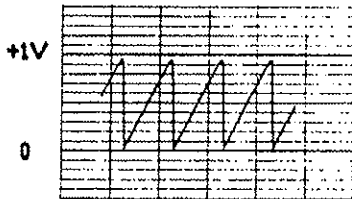

Waveform 4:
Sawtooth (Ramp down)

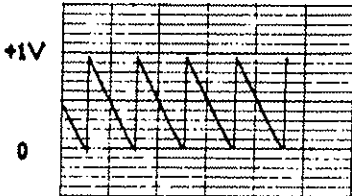

Waveform 5:

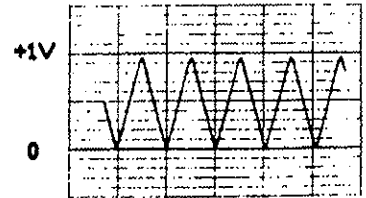
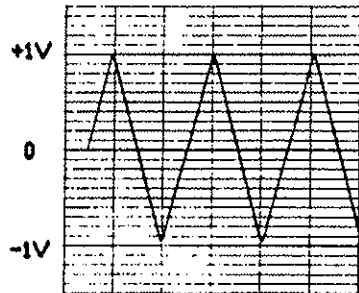

1/2 WAVE TRIANGULAR
[Obtained by selecting
negative polarity]

Waveform 6:

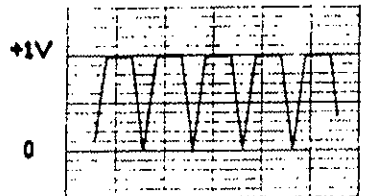
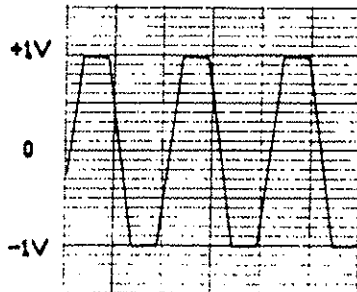

1/2 WAVE TRAPEZOIDAL
[Obtained by selecting
negative polarity]

SECTION 5. REMOTE OPERATION

5.1 INTRODUCTION

The IEEE-488 interface sometimes called GPIB (General Purpose Interface Bus) or HPIB (Hewlett Packard Interface Bus) allows remote control of the instrument by a suitable computer. Repetitive calibration work can be speedily and accurately carried out, giving printed results if required.

The IEEE-488 defines a complete interface system for the interconnecting of instruments and computers using a bit parallel, byte serial bi-direction bus. Protocols, connections and cables are also defined, enabling computer controlled systems to be quickly realised.

The main limitations of the IEEE are :-

- 1.) A maximum of 15 devices on the bus.
- 2.) The maximum bus length should not be greater than 20m or number of devices x 2, which ever is the shorter.

5.2 DATA TRANSFER AND DEVICE ADDRESSING

Before a controller can send data it has to identify the recipient. Each device on the IEEE is given an address to which it will respond when called by the controller, in this way data can be transferred between selected devices in an orderly manner. The rate at which it is transferred is controlled by hand shake signals, the speed being governed by the slowest device active on the bus. Set baud rates are unnecessary with the system.

Further information on the IEEE-488 can be found in the condensed description of the Hewlett Packard Interface Bus.

5.3 IEEE CABLES/CONNECTORS

The IEEE-488 cable contains 24 wires terminated at both ends with identical plug/sockets which allow for daisy - chaining of additional cables to extend the bus. See Table 5.1 for details of connections.

Cables used on IEEE systems are available in various lengths to suit different layouts. The following are recommended types:-

<u>Manufacturer/Supplier</u>	<u>Part No.</u>	<u>Length</u>
Belden	9642	1m
Belden	9643	2m
Belden	9644	4m
Belden	9645	8m
Time Electronics	9596	1m
Time Electronics	9597	2m

5.4 IEC BUS CONNECTIONS

A user requiring to connect the calibrator to a European standard bus (IEC), must be aware of the differences in connector pin assignments from the IEEE bus and provide a suitable interface. Table 5.1 compares the pin designations for each standard.

5.5 IEEE CONNECTOR

The pin connections and dimensions of the IEEE connector are illustrated below and in table 5.1.

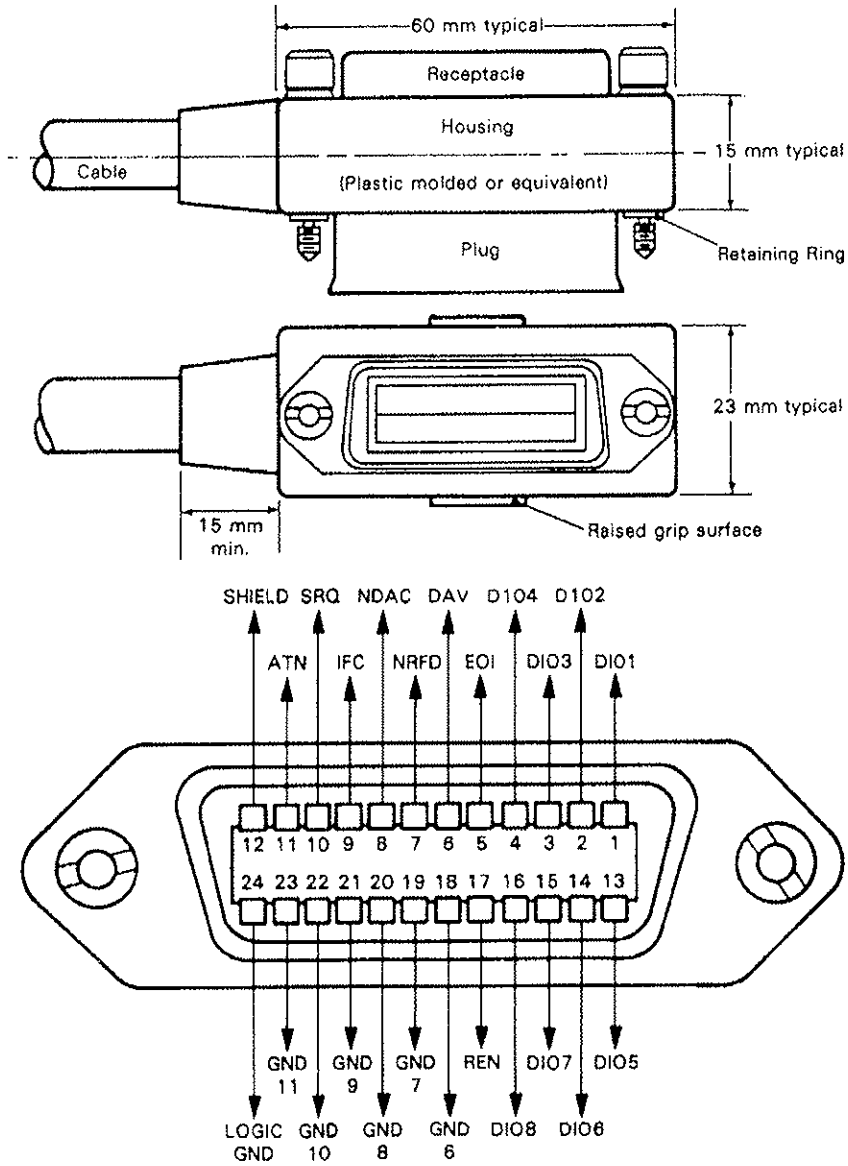

Fig. 5.1 I.E.E.E. CONNECTOR

TABLE 5.1 COMPARISON OF PIN DESIGNATIONS IEEE/IEC

IEEE STANDARD		IEC STANDARD	
PIN		PIN	
1	D101	1	D101
2	D102	2	D102
3	D103	3	D103
4	D104	4	D104
5	EOI	5	REN
6	DAV	6	EOI
7	NRFD	7	DAV
8	NDAC	8	NRFD
9	IFC	9	NDAC
10	SRQ	10	IFC
11	ATN	11	SRQ
12	SHIELD	12	ATN
13	D105	13	SHIELD
14	D106	14	D105
15	D107	15	D106
16	D108	16	D107
17	REN	17	D108
18	GND 6	18	GND 5
19	GND 7	19	GND 6
20	GND 8	20	GND 7
21	GND 9	21	GND 8
22	GND 10	22	GND 9
23	GND 11	23	GND 10
24	LOGIC GND	24	GND 11

5.6 IEEE ADDRESS SELECTION

Before operating the calibrator over the IEEE bus, set the address on the rear of the unit to the required address and operating mode.

Addresses 0 and 16 are reserved for recalibration in AUTO-CAL mode and should not be used unless recalibrating the instrument. Address 31 is used to select self test mode.

The eight switches are read only when the instrument is first switched 'ON'. Therefore it is necessary to turn the unit 'OFF' if a new IEEE address is required. See table 5.2

TABLE 5.2 IEEE ADDRESS SELECTION

SWITCH SETTING	DECIMAL ADDRESS	SWITCH SETTING	DECIMAL ADDRESS
0 0 0 0 0	0	1 0 0 0 0	16
0 0 0 0 1	1	1 0 0 0 1	17
0 0 0 1 0	2	1 0 0 1 0	18
0 0 0 1 1	3	1 0 0 1 1	19
0 0 1 0 0	4	1 0 1 0 0	20
0 0 1 0 1	5	1 0 1 0 1	21
0 0 1 1 0	6	1 0 1 1 0	22
0 0 1 1 1	7	1 0 1 1 1	23
0 1 0 0 0	8	1 1 0 0 0	24
0 1 0 0 1	9	1 1 0 0 1	25
0 1 0 1 0	10	1 1 0 1 0	26
0 1 0 1 1	11	1 1 0 1 1	27
0 1 1 0 0	12	1 1 1 0 0	28
0 1 1 0 1	13	1 1 1 0 1	29
0 1 1 1 0	14	1 1 1 1 0	30
0 1 1 1 1	15		

A '1' in the table corresponds to the left (on) position of the switch. Switch 1 (top) selects the least significant bit. The lower three switches, which are normally set to the 'off' position, are used to select the instruments operating modes as follows:

Switch 6 - IEEE talk (transmit) mode.

Switch 7 - IEEE listen (receive) mode.

Switch 8 - Dual Primary Addressing mode. In this mode, the unit will respond to two primary addresses differing only in the least significant bit. For example, if the unit address selection switches are set for an address of 8, the unit will also respond to address 9.

NOTE: The instrument only looks at the address switch at power up.

5.7 IEEE COMMANDS

LOCAL LOCKOUT

The front LOCAL/REMOTE switch must be in the remote position for IEEE operation. The instrument will not respond to any IEEE commands when set to local.

INTERFACE CLEAR COMMAND IFC

This command initiates a complete reset of the unit, which is then unable to respond to any further IEEE commands for 1 second.

IEEE COMMAND FORMAT

IEEE commands are comprised of characters from the ASCII set. A series of commands can be used to simulate the manual operation of the unit.

The commands must be in one of the following formats:

- 1.) A single upper case character (A to Z).
- 2.) Upper case character followed by a number.
- 3.) A signed decimal number (8 digits maximum).

Commands may be sent individually or built into a string separated with a 'slash character' (/). For the command string to execute it must be terminated with either a line feed or carriage return character.

IEEE COMMAND EXECUTION

Before an IEEE command can be executed 4 conditions must be met.

- 1.) The unit must be switched to 'remote' on the front panel.
- 2.) IEEE cable and controller connected. The IEEE address and the talk/listen switches set correctly on the rear panel switch.
- 3.) The command must be a valid command (invalid commands are ignored).
- 4.) The command must be followed by a valid terminator.

TABLE 5.3 IEEE COMMAND LIST

D	Transmit display to bus controller.
E1 to E4	Select unit action upon output error detection.
F15 to F20000	Select output frequency.
G1 or G2	Set / Cancel Group execute trigger response.
H	Set output to full scale.
I	Select serial poll operation.
K1 or K2	Enable/Disable Front panel controls.
L	Set output to zero.
O1 to O7	Output resistance between 10 Ohms and 10 M Ohms. O1 - 10 Ohms O5 - 100 K Ohms O2 - 100 Ohms O6 - 1 M Ohms O3 - 1 K Ohms O7 - 10 M Ohms O4 - 10 K Ohms
Pn	Change output by 'n' percent.
R1 to R12	Select range from 20 mV to 1 KV and 200 uA to 10 Amps. R1 - 20 mV R7 - 200 uA R3 - 200 mV R5 - 2 mA R3 - 2 V R9 - 20 mA R4 - 20 V R10 - 200 mA R5 - 200 V R11 - 2 A R6 - 1 KV R12 - 10 A RA - AUTORANGE
T1 or T2	Set terminator character appended to a transmission.
W1 to W7	Select waveform. W1 - Sine W2 - Square W3 - Ramp up W4 - Ramp down W5 - Triangle W6 - Trapezoidal W7 - D.C.
Z	Take present output as Zero Offset.
/	Command separator.

5.8 SINGLE LETTER COMMANDS

Command D

It is important to understand the sequence of operation on the IEEE bus when a data read-back command is executed. When the 'D' Command is sent it prepares the instrument to transmit (ie. act as a talker). The controller program must then execute an 'INPUT' statement to actually initiate the data transfer. The data must be terminated with the correct character to complete the transfer.

Invalid terminating characters cause the IEEE bus to hang.

The terminator is controller dependent and the instrument allows either CR or LF to be used, as determined by the Command T1 or T2. Note that the T1 or T2 command (terminating setting) must be done before the 'D' command is executed.

When the unit is in the over-range condition the front panel display shows 1..... but this is not transmitted on read-back. The character string 'OVERRNG' is sent. In all other cases the read-back is exactly as seen on the display.

EXAMPLE (HP BASIC)

```
10 REMOTE 708
20 OUTPUT 708,"T2"
30 OUTPUT 708,"D"
40 ENTER 708,A$
50 PRINT A$

      !SET TERMINATOR
      !TRANSMIT DISPLAY
      !READ RETURNED VALUE IN
      !PRINT IT
```

Command H

Sets output to full scale on the selected range. On the High Voltage ranges it will cause a three beep audio warning which lasts 3 seconds. The output will then appear on the terminals, this mode of operation is a safety feature.

EXAMPLE (CBM BASIC)

```
10 OPEN 1,7
20 PRINT #1,'H'
30 END

      : REM OPEN ADDRESS 7 TO INSTRUMENT
      : REM SET OUTPUT TO FULL SCALE
      : REM END
```

Command I

Sets the instrument to generate a serial poll request for service by the bus controller should an 'OP ERROR' arise.

EXAMPLE (HP BASIC)

<i>10 REMOTE 708</i>	<i>!OPEN IEEE ADDRESS 8</i>
<i>20 OUTPUT 708;"I"</i>	<i>!SETS UNIT TO GENERATE SERIAL POLL REQUEST ON OUTPUT ERROR</i>
<i>30 OUTPUT 708;"E4 R4 5"</i>	<i>!SET ERROR MODE, 20V RANGE WITH 5 VOLTS OUTPUT</i>
<i>40 ON INTR 7 GOSUB 1000</i>	<i>!DEFINE ACTION ON SERIAL POLL</i>
<i>50 V1=0 @ X=0</i>	
<i>60 X=X+1</i>	<i>!WAIT FOR ERROR LOOP</i>
<i>70 GOTO 60</i>	
<i>1000</i>	<i>!SUBROUTINE TO PRINT POLL RESPONSE</i>
<i>1010 STATUS ,1; A 1020 P=SPOLL (708)</i>	
<i>1030 PRINT P</i>	<i>!DISPLAY SERIAL POLL RESULT</i>
<i>1040 ENABLE INTR 7;8</i>	
<i>1050 RETURN</i>	<i>!RETURN TO WAIT LOOP</i>

Command L

Sets the output to 'zero' on the present range.

Command Z

Takes the present output value as an offset. The display indicates zero with the top segment of the display flashing. When a new output value is sent it will be added to the offset stored. The offset is cleared by:

- 1.) A new range command
- 2.) Selecting a resistance output
- 3.) Setting the offset to zero

In autocal mode, indicated by a flashing 'C' on the display, the offset is stored in the non volatile memory and is used as a calibration factor.

5.9 LETTER & NUMBER COMMAND**E1 To E4 Output Error Mode**

Selects one of four possible error modes which determine the action taken by the unit on detection of an output error.

E1 : (default) Displays 'OP ERROR' and turns off output immediately on detection of an output error, remains in this condition until reset by another command.

E2 : Displays 'OP ERROR' and turns off output immediately on detection of OP ERROR, will automatically restore output and display if the error is removed.

E3 : Waits for an error condition to last for 0.5 seconds before turning off output and displaying OP ERROR.

E4 : Waits for an error condition to last for 0.5 seconds before displaying OP ERROR and leaves output ON.

F15 to F20000 frequency setting commands

Commands F15 to F20000 select output frequency. Enter 'F' followed by the required frequency. Any frequency between 15Hz and 20KHz (in 5Hz steps) may be selected.

G1/G2 enable/disable group execute trigger

G1 - Enables Group Execute Trigger response.
G2 - Disables Group Execute Trigger response.

Group Execute Trigger (GET) is a command issued by the bus controller to make several devices respond simultaneously, the devices having been previously told how to respond when the GET command is received.

EXAMPLE (HP BASIC)

```

10 REMOTE 708                !OPEN IEEE ADDRESS 8
20 OUTPUT 708;"G1"          !SETS UNIT TO RESPOND TO GET
30 OUTPUT 708;"R2"          !COMMAND TO EXECUTE
40 TRIGGER 708              !EXECUTE COMMAND
50 OUTPUT 708;"G2"          !COMMAND TO EXECUTE
60 TRIGGER 708              !EXECUTE COMMAND TO EXIT GET MODE

```

K1/K2 enable/disable front panel control

K1 - Sets instrument to respond to front panel control.
K2 - Disables front panel controls.

P(n) set percentage deviation

Set deviation 'n' on present output where 'n' is in the range of +9.9999 and -9.9999.

EXAMPLE (CBM BASIC)

```

10 PRINT #1,"P3.456"        REM SET output 3.456% high
20 PRINT #1,"P-0.02"       REM SET output 0.02% low

```

R1 To R12 Range Setting Commands

Selects a voltage or current range from IEEE command table.

COMMAND SELECTED	RANGE	PROGRAM IN
R1	20 mV	mV
R2	200 mV	mV
R3	2 V	Volts
R4	20 V	Volts
R5	200 V	Volts
R6	1 KV	Volts
R7	200 μ A	μ A
R8	2 mA	mA
R9	20 mA	mA
R10	200 mA	mA
R11	2 A	Amps
R12	10 A	Amps

RA: Automatically selects the range for the output required. Default: R1.

T1/T2 select transmission terminator

Sets the last character appended to a transmission from the instrument.

T1 (default) : carriage return.

T2 : line feed.

W1 to W7 waveform setting commands

Select waveform or D.C. see IEEE command table in Table 5.3.

NOTE : On the high voltage ranges (R5 & R6) only Sine Wave and DC (W1 & W7) are permitted, it is not possible to change the Waveform without first going to a lower range.

Default is W7 (DC).

5.10 SETTING AN OUTPUT VALUE

Transmit the voltage or current required as an ASCII string.

EXAMPLES (HP BASIC) on the 2 Volt range (R3)

OUTPUT 708;"-0.3765" !SET OUTPUT TO -0.3765 VOLTS

OUTPUT 708;"2.9" !SETS OUTPUT TO OVER-RANGE DISPLAY SHOWS
1..... , OUTPUT SET TO APPROX 2.08 VOLTS.

OUTPUT 708;"0.00000007" !SETS OUTPUT TO ZERO, TOO MANY DECIMAL PLACES

NOTES :

- 1.) The 7th digit is always rounded to 0, 2, 4, 6, or 8.
- 2.) On D.C. (W7) or sine wave A.C. (W1) the output limit of any range is 208000 or 1100v on the 1 KV ranges.
- 3.) On the 10 Amp ranges, output limit is 11 Amp.

5.11 SETTING VOLTAGES ABOVE 40 VOLTS

When a voltage above 40 V is selected, (except when using certain output error mode), an alarm sounds 3 times before the voltage is applied to the output terminals. To avoid damaging circuitry by applying large rates of voltage change, the output ramps up to the set value. It takes about approx. 5 seconds to reach 1 KV output.

On the 200 V and 1 KV ranges, only Sine wave and D.C. are permitted. Changing the waveform on these ranges is disabled by the software in the instrument. Frequencies above 400 Hz will give large amplitude errors.

Changing range to the 200 V or 1KV ranges where the output would be set to more than 40 V causes the output to be set to zero.

The left hand decimal point on the display flashes when an output of 40 V or greater is on the terminals.

5.12 CALIBRATION OVER THE IEEE BUS

The automatic calibration (auto-cal) feature enables independent calibration of the zero, positive and negative outputs of all D.C ranges and full scale of all A.C. ranges either via the IEEE bus or manually.

- 1.) Switch off and select IEEE address 0 or 16. Calibration can only be performed using one of these addresses which are specifically designed for this purpose.
- 2.) Switch on and insert CAL key. The front panel display will show a flashing 'C'.
- 3.) Work through the ranges setting Zero and Full Scale alternately.

EXAMPLE (HP BASIC)

<i>OUTPUT 708;"R4"</i>	<i>! SELECT RANGE TO CALIBRATE</i>
<i>OUTPUT 708;"0"</i>	<i>! SET OUTPUT TO ZERO, MEASURE ZERO</i>
	<i>OUTPUT n.nnn VOLTS</i>
<i>OUTPUT 708;"Z-n.nnnn"</i>	<i>! CHANGE SIGN AND STORE IN CALIBRATOR</i>
	<i>AS ZERO OFFSET</i>
<i>OUTPUT 708;"20"</i>	<i>! SET OUTPUT TO 20 VOLTS, MEASURE</i>
	<i>OUTPUT AND CALCULATE THE</i>
	<i>PERCENTAGE ERROR m.mmm</i>
<i>OUTPUT 708;"Pm.mmm"</i>	<i>! STORE CAL FACTOR IN INSTRUMENT</i>

Repeat the last two steps for negative full scale and A.C. When the measuring instrument is programmable the complete process can be performed automatically. Note that the Resistance cannot be calibrated with the autocal.

See Section 9 for more details on calibration.

SECTION 6. FAULT DIAGNOSIS

6.1 FAULT DIAGNOSIS INTRODUCTION

This section gives details of some possible problems, and how to correct them, together with information about board replacement. Faulty items may be returned for repair or new spares obtained (See Section 10 Spare Parts List) from Time Electronics (or their authorised dealer), quoting type and serial number, and giving details of the fault where possible.

Time Electronics offer an exchange service for all printed circuit boards and the power module.

6.2 FAULT CHECK LIST

- 1) If the unit is completely dead with no front panel lights, check the following:
 - A) Mains supply.
 - B) Mains fuse blown in plug.
 - C) Mains fuse blown in combination appliance inlet.
 - D) Internal fuses blown (see fuse replacement).
- 2) If instrument responds to manual control but not to IEEE control and the data light does not flash, check the following:
 - A) Defective IEEE cable.
 - B) Unit is incorrectly addressed.
 - C) Incorrect terminating characters.
 - D) Processor board not correctly plugged in.
- 3) If unit responds to manual control but not to IEEE control and the data light flashes, the probable fault is an incorrect command.
- 4) Unit powers up but not working correctly.
 - A) Run Self Test. See table 4.5 for error codes.
- 5) Unit displays ERROR 6.
 - A) Cal RAM corrupted.
- 6) Unit occasionally resets to power on (20mV range) condition and makes a short bleep.
 - A) Mains interference is causing the microprocessor to stop, tripping the watch-dog circuitry to give an automatic restart. Additional mains filtering required.

6.3 FUSE REPLACEMENT

Four types of fuses are used in this instrument.

- 1) 2 Amp, 20mm quick blow - 5V supply.
- 2) 800 mA for 240 V/1.6 Amp for 110 V, 20mm anti-surge - Mains input.
- 3) 2.5 Amp, 20mm A/S - 18V supply.
- 4) 250 mA, 5/8 inch quick blow - V/I/R output fuse.

Replacement fuses are available from Time Electronics and R.S. Components. See SECTION 10 (Spare Parts) for order details.

6.4 FUSE LOCATION AND REPLACEMENT PROCEDURE

- 1) Mains fuse :- This fuse is located in the mains inlet filter. To replace, disconnect equipment from mains and lever down hinged cover to reveal fuse holders. This fuse should be 800 mA for 240 V operation, or 1.6 Amp for 110 V operation.
- 2) 5V supply :- The 5V supply fuse is mounted on the left-hand printed circuit board of the power unit.
- 3) +/- 18V fuses :- These fuses are mounted on the right hand printed circuit board of the power unit.
- 4) V/I/R fuse :- This fuse is mounted on the reference board underneath the module.

6.5 MAINFRAME

The calibrator is constructed on a 19 inch Eurocard frame. Cards and modules plug into the frame from the rear of the unit.

All modules and printed circuit boards connect to the 64-way data bus via a DIN 41612 type connector.

The front panel is removed by unscrewing the four captive screws at each corner. Then lift away from the frame .

6.6 FAN REPLACEMENT

The fan is situated at the left hand side of the instrument, behind the front panel and it cools the 10 Amp board. Should the fan fail, it is replaced as follows :

1. ENSURE MAINS SUPPLY IS DISCONNECTED BEFORE ATTEMPTING TO DISMANTLE THIS INSTRUMENT.
2. Remove the instrument from the free standing case.
3. Remove the two cross head screws situated at each end of the top front cross member.
4. Release the cross member and lay it back on top of the unit.
5. Take off the four fan retaining nuts and washers.

6. Remove the fan supply plug from the power module.
7. The fan can now be lifted out of the mainframe.
8. Fit replacement fan using reverse procedure.

6.7 10 AMP BOARD REPLACEMENT

Should the 10 Amp board fail, it is replaced as follows :

1. ENSURE MAINS SUPPLY IS DISCONNECTED BEFORE ATTEMPTING TO DISMANTLE INSTRUMENT.
2. Remove the unit from the free standing case.
3. Remove the front panel and the cross member (screws at each end).
4. Remove the plug connecting the 10 Amp board to the power module.
5. Remove the plug connecting the 10 Amp board to the current module.
6. Disconnect the wires to the output terminals.
7. The 10 Amp board can now be removed from the mainframe.
8. Fit replacement board using the reverse procedure.

6.8 POWER MODULE REPLACEMENT

To remove the power unit module which is located on the right hand side of the frame viewed from the rear, first unscrew the four captive screws in the corners of the power unit rear panel. The power unit can then be pushed out of the rear of the frame. **DO NOT PULL ON THE MAINS LEAD.**

Replacement is in the reverse order.

6.9 REPLACEMENT OF IEEE AND PROCESSOR BOARDS

The IEEE and processor boards are located behind the IEEE rear panel. Remove the panel by unscrewing the four captive screws at each of its corners. Disconnect the multipin plug that connects the rear panel to the IEEE panel. Before the boards can be removed, the black retaining clips located at the bottom of the frame must be depressed.

NOTE : The IEEE multipin connector is NOT polarized and can be accidentally reversed during replacement. To avoid this, ensure that the embossed arrow heads on the plug and socket are aligned. Care must also be taken to ensure the correct alignment of the IEEE address switch in the rear panel cut out.

6.10 ANALOGUE BOARD REPLACEMENT

All analogue boards are located behind the rear panel on the left of the frame when viewed from the rear. To replace a board, remove this panel locate the board to replace, depress card retaining clip and pull board back. On all boards additional connectors need to be disconnected as the board is removed.

NOTE : To remove the H.V. board it is also necessary to remove the IEEE panel.

SECTION 7. TECHNICAL DESCRIPTION

7.1 INTRODUCTION

This section contains a brief technical description, starting with the mainframe and associated modules, followed by the plug-in boards.

The technical description is divided into the following parts:

1. The Mainframe
2. The Front Panel Electronics Board
3. 10 Amp Output board
4. The Power Module
5. Microprocessor Board
6. The IEEE Interface Board
7. H.V. Board
8. A.C. Board
9. Reference Board
10. Current Convertor Board
11. Digital to Analogue Board and Module
12. The Resistance Board

7.2 MAINFRAME

A 19" Eurocard frame houses all boards and modules which plug into a 64 way bus via DIN 41612 type connectors.

7.3 THE FRONT PANEL ELECTRONICS BOARD

The microprocessor reads the keypad and drives the display through a 74C923 keypad encoder and a ICN 7218 8 digit display driver respectively. Two 8 bit latches on the data bus drive the L.E.D.s above the switches.

Address decoding for these I.C's is performed by a 74LS138 and a 7400 also on the P.C.B.

7.4 THE 10 AMP BOARD

This board generates an unregulated low voltage + / - 4 Volts at 10 Amps from the unregulated supplies. The low voltage is then regulated by a push pull output stage to give the 10 Amp output.

The output current is sensed by a 0.01 Ohm 4 terminal shunt resistor. The voltage generated (0.1 Volts for 10 Amps) is amplified to 1 Volt by a differential amplifier and fed back to the Reference Module sense I/P to control the output.

7.5 THE POWER MODULE

The power module contains a 100VA rated mains transformer, D.C. regulated supplies and select circuitry for the LOCAL/REMOTE switch and indicators.

The mains transformer has two 120V RMS primary windings and 9V, 11V and two 22V RMS secondary windings.

The 9V winding connects, via a 2A fuse, to a full wave bridge rectifier and smoothing capacitor. It supplies a regulated 5V D.C. at 1A for the microprocessor board, the IEEE board, the front panel display and the A.C. board.

This supply is additionally full wave rectified to supply an unregulated 14V D.C. supply at 1A. An unregulated 5V D.C. supply derived from this line drives the circuit relays and can be pulled up on command for latching the relays.

The two 22V RMS windings are rectified and supply an unregulated output of +/- 28V D.C. These supplies are also regulated to +/- 18V D.C. for the analogue circuitry.

The 11V winding is cascaded with the 22V winding to give an unregulated +/- 50V D.C. supply.

7.6 THE MICROPROCESSOR BOARD

Mounted on the microprocessor board are the microprocessor, its clock, a PROM, the power-on-reset circuitry, address decoding and 32 lines of parallel input/output (I/O).

The microprocessor used is the Motorola MC 6802. A 3.2768MHz crystal divided down internally by the 6802 supplies the 8192 kHz clock.

Parallel I/O is provided by two MC6821 peripheral interface adaptors (PIA). Each of the 32 I/O lines is provided with a pull-up resistor.

An on board link provides for the installation of either a 16K (2516), 32K (2532) or 64K (2764) PROM.

The power-on circuitry is a low frequency oscillator held off by the microprocessor stop, the oscillator does not receive a pulse and automatically resets.

Auto-cal models are fitted with a non-volatile RAM (type X2816).

7.7 THE IEEE INTERFACE BOARD

The IEEE interface board is constructed around the Motorola MC68488 general purpose interface adaptor (GPIA). The I/O lines of the 68488 are driven through MC3448 drivers. The address select switches are mounted directly on the board and their condition is gated onto the 6802 bus via a 74LS244 tristate buffer.

7.8 THE H.V. AMPLIFIER BOARD

This board amplifies the 0 - 10 Volt output from the reference board up to 0 - 1000 Volts. A potential divider made up of a 9M9 and 100 K wirewound, hermetically sealed resistors, divides the 0 - 1000 V down for a 0 - 10 V sense voltage. Also mounted on this board is the audio bleep circuitry.

7.9 THE A.C. CONVERTOR BOARD

The reference voltage from the reference board is fed into a digital to analogue convertor (D/A) mounted on this board. The control codes for the D/A are held in an EPROM, the sequence of which is controlled by an 8-digit binary counter, driven from a frequency synthesizer circuit. The D/A control codes determine the shape of the A.C. output onto the 6802 bus.

7.10 THE REFERENCE BOARD

The encapsulated reference circuitry consists of two precision, aged zener diodes running at their optimum current. The output from these diodes is averaged and amplified supply the master reference voltage of +10.48576V. This voltage is inverted by a precision inverter to give -10.48576V. Either the positive or negative reference voltage is applied to the output by a low thermal FET switch controlled by a logic input.

The reference voltage is split to drive two D/A convertors :

A) The 14 bit monolithic convertor (AD 7534) mounted on this board via a buffer, an inverter and a calibrator. This convertor makes up the least significant bits and hence is termed the LS bits D/A. A trimmer (LS bits gain) adjusts the magnitude of reference fed to this convertor, while another trimmer (balance) adjusts any offset between the positive and negative reference voltages.

B) The precision 6-bit D/A convertor on the D/A board

7.11 THE CURRENT CONVERTOR BOARD

Mounted on this board are 5 current shunt resistors for the 200 μ A to 2A current ranges and the associated four terminal switching circuitry. The three lower current ranges are switched by a FET analogue switch, while the 200 mA and 2 A ranges are switched with relays.

This board also supplies the control signals for the 10 A output board. These signals are :

- A) 10 A select.
- B) Sense return which routes the output current through one of five shunt resistors on the current convertor board which then generates the 0 - 1 V sensing voltage.
- C) Drive to the high voltage output stage.
- D) Output from the high voltage output stage.

7.12 D/A CONVERTOR BOARD

This board consists of an encapsulated module and a R-2R resistor ladder network.

The encapsulated module contains logic, buffer amplifiers and switching.

The R-2R resistor ladder consists of high quality low temperature coefficient resistors which have been carefully chosen, both in value and type, to give optimum stability. The value of each resistor can be adjusted by a multi-turn trimmer to give very high linearity. The output from the ladder is buffered and returned to the reference board.

7.13 THE RESISTANCE BOARD

Mounted on this board are 7 Wirewound, hermetically sealed resistors together with their associated trimming circuitry covering the range 10 Ohms to 10 M Ohms, trimmed to better than 10 PPM.

Also mounted on this board are 8 relays which select 1 of the 7 resistors or the voltage / current output.

SECTION 8. CALIBRATION TECHNIQUES

8.1 INTRODUCTION TO CALIBRATION TECHNIQUES

This section indicates some of the common errors made when using the calibrator.

8.2 OUTPUT RESISTANCE

Output resistance causes a drop in output voltage when a load is applied. The percentage error depends on the ratio of load resistance to output resistance

Ratio of Load Resistance to Output Resistance	Percent Error in Selected Output Voltage
100,000 : 1	0.001
10,000 : 1	0.01
1,000 : 1	0.1
100 : 1	1.0
10 : 1	9.0
1 : 1	50.0

This table applies to D.C. and A.C. For A.C., capacitive loading must also be added to resistive load. The table below gives reactance of capacitors (in ohms).

CAPACITOR	REACTANCE @ 50 HZ	REACTANCE @ 10 KHZ
100 pF	32 M Ohms	160 K Ohms
1000 pF	3.2 M Ohms	16 K Ohms
0.1 μF	32 K Ohms	160 Ohms

For most applications the ratio is very high and the error can be ignored. One important exception is the Thermal Transfer where the ratio can be 1000 : 1 or less. This will give errors in excess of 0.1% unless compensated for.

Another exception is the calibration of a 60 mV analogue meter. It is often better to use the 2 Volt range as the output resistance is much lower than the 200 mV range and the accuracy at 1/20 full is still sufficiently high for analogue meters.

8.3 USING SHUNTS TO MEASURE SMALL A.C. CURRENTS

Using a shunt and a digital voltmeter (DVM) to measure the 2 mA and 200 μA ranges gives rise to two possible errors :-

1.) Low Shunt Value.

Low value shunts give very small voltages which are very difficult to measure on

DVM's, the non-linear A.C. to D.C. conversion techniques used, often give large zero errors which cannot be corrected by simply taking off the zero reading.

2.) 1 K Ohm shunts and above.

The input impedance on most high performance DVM's is usually 1 M Ohm. This causes a 0.1% error when reading across a 1 K Ohm. It is therefore necessary to correct this or use a buffer amplifier to isolate the DVM from loading the shunt.

8.4 OUTPUT CURRENT LIMITATIONS ON VOLTAGE RANGES

The instrument warns when the maximum output current is exceeded for more than 10 milli seconds by displaying 'OP ERROR' (O/P Mode 1).

Two important exceptions to output error detection should be noted.

1.) No error is detected on the 200 mV and 20 mV ranges as the output current is limited by the output resistance of 10 Ohms.

2.) As output errors lasting less than 10 mS are not detected, a slightly clipped peak of an A.C. waveform may not cause an output error.

8.5 OUTPUT VOLTAGE LIMITATIONS ON CURRENT RANGES

Output errors are generated when there is insufficient terminal voltage to drive the set current through the load. Error condition must last for more than 10 mS to be detected. Note that some meters and transducers have a large inductance and may need 20 or 30 Volts A.C. to drive them although their D.C. resistance is very low.

8.6 INTERFERENCE REJECTION

As none of the output terminals has a path to mains earth at voltages less than 80 Volts, it is good practice to earth the instrument by taking one of the terminals to earth or by ensuring that the instrument being calibrated is properly earthed. However, care should be taken that an earth loop is not created by inadvertently earthing the calibrators terminal when it is already earthed via the instrument under calibration.

On current ranges with very high output impedance, series mode noise can be induced onto the output but may be suppressed by the use of screened leads.

In addition to inherent electrical noise from internal circuitry, the output can contain fluctuations which originate externally and often cover a wide spectrum of frequencies. The most effective solution is to locate the source and provide suitable filtering eg. capacitor suppression on arcing contacts.

8.7 EARTHING THE HIGH VOLTAGE OUTPUT

The V/I/R and 10 Amp terminals are true bi - polar outputs, but the HV output terminals are not. Therefore, when using a positive HV output the negative terminal should be earthed as normal, but when a negative HV output is required, it is recommended that the earth be transferred from the negative terminal to the positive terminal. Alternatively the low voltage negative terminal may be earthed, this automatically earths the correct side of the HV output.

8.8 THERMAL EMF

Thermal EMF's are significant when low level DC Voltage measurements are being made. Thermal EMF errors are unpredictable and arise when dissimilar metal junctions are at different temperatures. To minimise them, the same metal should be used throughout the measuring circuit, avoiding the use of steel probes, nickel plated terminals and tinned copper wire where possible. If the use of dissimilar metal junctions in the measuring circuit is unavoidable, it should be ensured that they are offset by other junctions of the same metals at the same temperature. Allowance for thermal EMF's should then be made by making a measurement twice with reversed polarities. Time Electronics can supply Low Thermal EMF leads, (see Spare Parts List).

8.9 RESISTANCE MEASUREMENTS

Three types of errors in resistance measurement are listed below -

- 1.) Thermal EMF's can effect the accuracy of resistance measurement if not zeroed out properly.
- 2.) Self heating of the resistor being measured. Use of a lower current will minimize this but the resulting lower voltage is more difficult to measure.
- 3.) Noise and pick-up on the higher value resistors. The use of screened leads may help but may not remove noise completely.

Errors caused from 1 and 2 can usually be completely removed, but errors from noise pick-up on the high values will always be present.

SECTION 9. CALIBRATION

9.1 INTRODUCTION

The automatic calibration (auto-cal) feature enables independent calibration of the zero, positive and negative outputs of all DC ranges and full scale of all A.C. ranges either from the front panel or via the IEEE bus. The calibration factors are stored twice in memory and when switched on the factors are compared to check for any corruption. Should an error be found the message 'ERROR 6' will be displayed on the front panel.

When using auto-cal, all calibration factors may be zeroed and the operation of the calibration memory verified by inserting the CAL key and selecting self test (ie. all IEEE address switches to the left and switch on). Self test can be run without inserting the CAL key which leaves the calibration factors unchanged.

If the CAL key is inserted when the unit is not addressed for auto-cal, the display will flash 'ERROR 7'.

Calibration comes in two parts, Range and Linearity, of which it is normally necessary to perform the range calibration, and then check the linearity.

Should an unacceptable linearity error be found, it will then be necessary to perform the linearity adjustments and repeat the range calibration procedure.

To adjust the linearity, it is necessary to disconnect all circuitry associated with the resistor ladder, then measure and adjust the resistance values of the R and 2R components such that the R (approx. 20 K) is 2 x R (approx. 10 K).

9.2 EQUIPMENT REQUIRED FOR CALIBRATION

1.) Range Calibration.

All range calibration is performed by the measurement of voltages and currents to accuracies at least four times the specifications.

The recommended technique is with a Potential Divider / Null / Standard Cell, or alternatively, a good digital voltmeter of known performance recently certified may be used.

Recommended D.V.M.'s are Solartron 7081/7071, Datron 1071/1081.

2.) Linearity Calibration.

To set up the R-2R ladder an instrument for measuring 10 K Ohms and 20 K Ohms resistance with 1 Ohm resolution is needed. The absolute accuracy is unimportant providing that the linearity error is within +/- 0.01%, which is usually the case with a D.V.M. if the range is not changed.

9.3 SETTING UP PROCEDURE

Ensure that the instrument under calibration and the Standards are allowed a warm up period of 2 hours at a constant temperature of $20^{\circ}\text{C} \pm 1^{\circ}\text{C}$. This temperature should remain constant during the calibration procedure. Refer to figure 9.1 for potentiometer positions.

9.4 SETTING INTO AUTO-CAL MODE

The instrument is set into auto-cal mode as follows:

- 1.) Switch off and select IEEE address 0 or 16.
- 2.) Switch on and insert CAL key. The front panel display will show a flashing C.

9.5 RECALIBRATING RANGES FROM THE FRONT PANEL

All ranges can be calibrated independently or in any sequence, it is necessary to set the zero before adjusting full scales.

- 1.) Select the range to be calibrated.
- 2.) For ZERO calibration, (D.C. only) set a value on the display which makes the output zero, then press SELECT followed by ZERO which will set the output to zero. Press ZERO again and the display will zero. There is no adjustment for A.C. zero, should an A.C. zero need adjusting, there is fault condition.
- 3.) For FULL SCALE calibration, set the display to full scale or to the value required as the point to check against a standard (eg. checking the 2V range against a standard cell). Press DEV, adjust the output to the correct value and press DEV again. This saves the calibration factor. The negative and A.C. full scales are adjusted in the same way.

9.6 RECALIBRATING OVER THE IEEE BUS.

- 1.) Select the range to be calibrated.
- 2.) Set the output to zero by setting a value to cancel the zero error, then send command 'Z' to store this value. Note there is no adjustment for A.C. zero.
- 3.) Set the output to full scale and select deviation required to adjust output to correct value with command 'PX.XXX'. When another command is received the value is saved.

After calibration, carry out the following operations STRICTLY in the order given:

- A) Remove the CAL key.
- B) Switch off.
- C) Reselect the unit address.

NOTES :

- 1.) Addresses 0 and 16 only should be used for calibration.
- 2.) If the unit is operated in auto-cal mode with the CAL key not inserted, the devia-

tion and offset functions will not work.

3.) The IEEE address is only read when the instrument is first switched on.

9.7 REFERENCE CIRCUITRY

The reference circuitry is in the encapsulated module and consists of 2 precision aged zeners running at their optimum current. The output from these is averaged and amplified to give a +10.48576 V master reference. This reference is then inverted by a precision inverter to give -10.48576 V. A low thermal FET switch controlled by a logic input on pin 9, switches either the +Ve or -Ve reference out to pin 12.

At this point the reference voltage is split to drive two D/A convertors - A 14 bit monolithic convertor (AD 7534) on the reference board and the precision 6 bit D/A convertor on the D/A board. The 14 bit convertor makes up the least significant bits and is referred to as the LS Bits D/A convertor.

9.8 LS BITS D/A CONVERTOR

The reference voltage is buffered, inverted and calibrated before it is fed into the LS Bits D/A.

The LS Bits gain trimmer is used to adjust the magnitude of the reference voltage feed into the 14 bit D/A and a balance trimmer is used to offset any difference between the +Ve and -Ve voltage.

9.9 PRECISION 6 BIT D/A CONVERTOR ASSEMBLY

This convertor is made in two parts :- An encapsulated module contains logic, buffer amps, switching and the D/A board with the R-2R wire wound resistor ladder.

The value of each resistor in the ladder can be individually adjusted with its associated multiturn trimmer to give a very high linearity. The high quality, low temperature coefficient resistors in this chain have been carefully chosen, in both value and type, to give optimum stability and should only be replaced by a similar type.

The output from the LS Bits is brought in as the 7 bit in the 6 bit convertor - hence making up the full compliment of 20 bits.

The output of the ladder network is buffered and then returned to the reference board.

9.10 LS BITS BALANCE

The first adjustment to make is the LS Bits balance. Measurements should be taken from the output terminals with a resolution down to 10 uV and 0.01% accuracy. The calibrator should be on the 10 Volt range and set to +0.3000 V. Adjust the 'LS BALANCE' trimmer to obtain an equal, but opposite polarity reading on the meter

when selecting + or - on the calibrator. The absolute value at this point is unimportant.

9.11 LS BITS CALIBRATION

Measuring from the output terminals with the calibrator set to +0.3000 V on the 10 V range, adjust the LS Bits Cal pot. to read 0.3000 V, +/- 20 uV

9.12 LINEARITY CALIBRATION

NOTE : Before proceeding with the linearity adjustment, first check linearity of the top decade down to 0.4 V to ascertain whether or not adjustment is required. Only the top decade can be adjusted. If the lower decades are non-linear then a fault exists in the 14 LS Bits, the linearity of which is governed by the 14 bit DAC on the Reference Board. After linearity adjustment is made it is necessary to recalibrate this instrument.

See diagram in Section 12 for measurement points. The equipment required is an Ohm Meter with a F.S. reading of 20 K Ohms and a resolution of 1 Ohm. To set up the R-2R ladder correctly all that is required is to set one resistance value to twice the resistance value of R, to within 0.01%. The absolute value is unimportant.

Unplug the D/A Board. Remove the module and unplug IC4, (OP27 located between the module connector and the edge connector). Measure the resistance across the points marked X and Y in the diagram and adjust the resistance to 9.967K Ohms using the associated trimmer also shown in the diagram. (See Section 12). Similarly, adjust the resistance across the points marked Y to 19.934 K Ohms with the associated trimmer without changing the meters range. Continue until all decades are correct. Refit the module and the OP27 op-amp and replace the board.

The instrument will now require complete calibration. Full scales and zeroes must be calibrated and also the LS Bits balance should be checked.

FIGURE 9.1

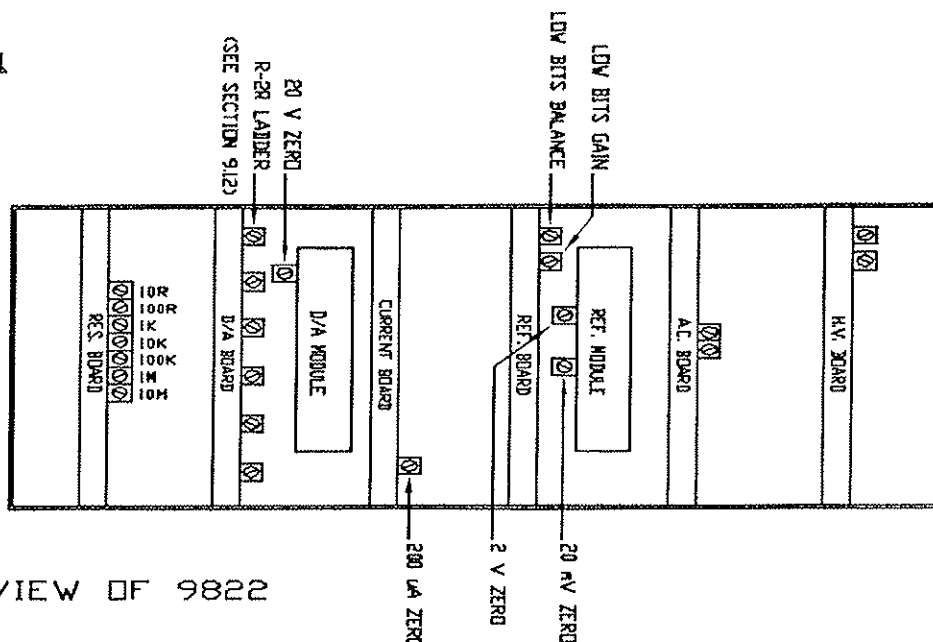

REAR VIEW OF 9822

9.13 RESISTANCE CALIBRATION

Adjustment of each decade is done by its own adjustment potentiometer. The trimmers must set each decade to within the accuracy specified for each range, as shown in the table below.

<u>RANGE</u>	<u>POINT</u>	<u>MEASUREMENT</u>	<u>ADJUSTMENT</u>
10 Ohm	V/I/R	10 Ohm +/- 2.5 mOhm	Adjust R4
100 Ohm	V/I/R	100 Ohm +/- 2.5 mOhm	Adjust R7
1 K Ohm	V/I/R	1 K Ohm +/- 12.5 mOhm	Adjust R10
10 K Ohm	V/I/R	10 K Ohm +/- 125 mOhm	Adjust R13
100 K Ohm	V/I/R	100 K Ohm +/- 1.25 Ohm	Adjust R17
1 M Ohm	V/I/R	1 M Ohm +/- 30 Ohm	Adjust R19
10 M Ohm	V/I/R	10 M Ohm +/- 1 K Ohm	Adjust R21

SECTION 10. SPARE PARTS

<u>ITEM</u>	<u>ORDER CODE</u>
12V Relay (S2)	6314
12V Relay (S4)	6312
8 way D.I.L. switch	6306
IEEE Connector	6420
Mains Fuse 800 mA	6128
Mains Fuse 1.6 A	6130
Fuse 5/8" 250 mA	6102
Fuse 20mm 2 A	6111
Fuse 20mm 2.5 A	6122
IEEE Driver (3448)	4555
IEEE Interface (68488)	4556
Crystal (3.2768 MHz)	4559
Microprocessor (6802)	4583
PIA (68A21)	4585
12 Bit timer (14040)	4590
Press switch with LED	6452
7 Seg LED	4631
Display Driver ICM7218A	4592
LED Driver 74LS273	4594
K/B Encoder 74C923	4595
Non Volatile RAM	4566
Terminal Red	6224
Terminal Black	6225
Fan	7504
A.C. Convertor Board	9418
Current Convertor Board	9421
D to A Convertor Board	9403
H.V. Board	9415
IEEE Board	9573
uP Board	9574
Power Module	9429
Reference Board	9404
Resistance Board	9414
10 Amp Board	9428

NOTE : When ordering spare parts it is necessary to state the serial number of the instrument. Please note that in some cases if a design has been superseded, the latest version will be supplied.

SECTION 11. GUARANTEE AND SERVICE FACILITIES

The unit is guaranteed for a period of one year from its delivery to the purchaser.

We maintain comprehensive after sales facilities and the unit can, if necessary, be returned to us (or our authorised dealer) for servicing. The type and serial number should always be quoted, together with details of any fault, and the service required.

Time Electronics can re-calibrate your instrument and issue a 5 page calibration certificate, traceable to N.P.L. or alternatively obtain a NAMAS certificate.

Equipment returned to us for servicing must be adequately packed, preferably in the special box supplied, and shipped with transportation charges prepaid. WE CAN ACCEPT NO RESPONSIBILITY FOR INSTRUMENTS ARRIVING DAMAGED. Should the cause of failure during the guarantee period be due to misuse or abuse of the unit, or if the guarantee period has expired, the repair will be put in hand without delay, and charged unless other instructions are received. Please note that if you require a new NAMAS certificate during the warranty period, this will be charged at the current rate on our price list.

TIME ELECTRONICS LIMITED
BOTANY INDUSTRIAL ESTATE
TONBRIDGE
KENT
TN9 1RH

TEL : TONBRIDGE (01732) 355993
FAX : 01732 770312