

MODEL 1080/1081
POWER SUPPLY/MARKER BOARD
AND R.P. ASSY.

REV. _____

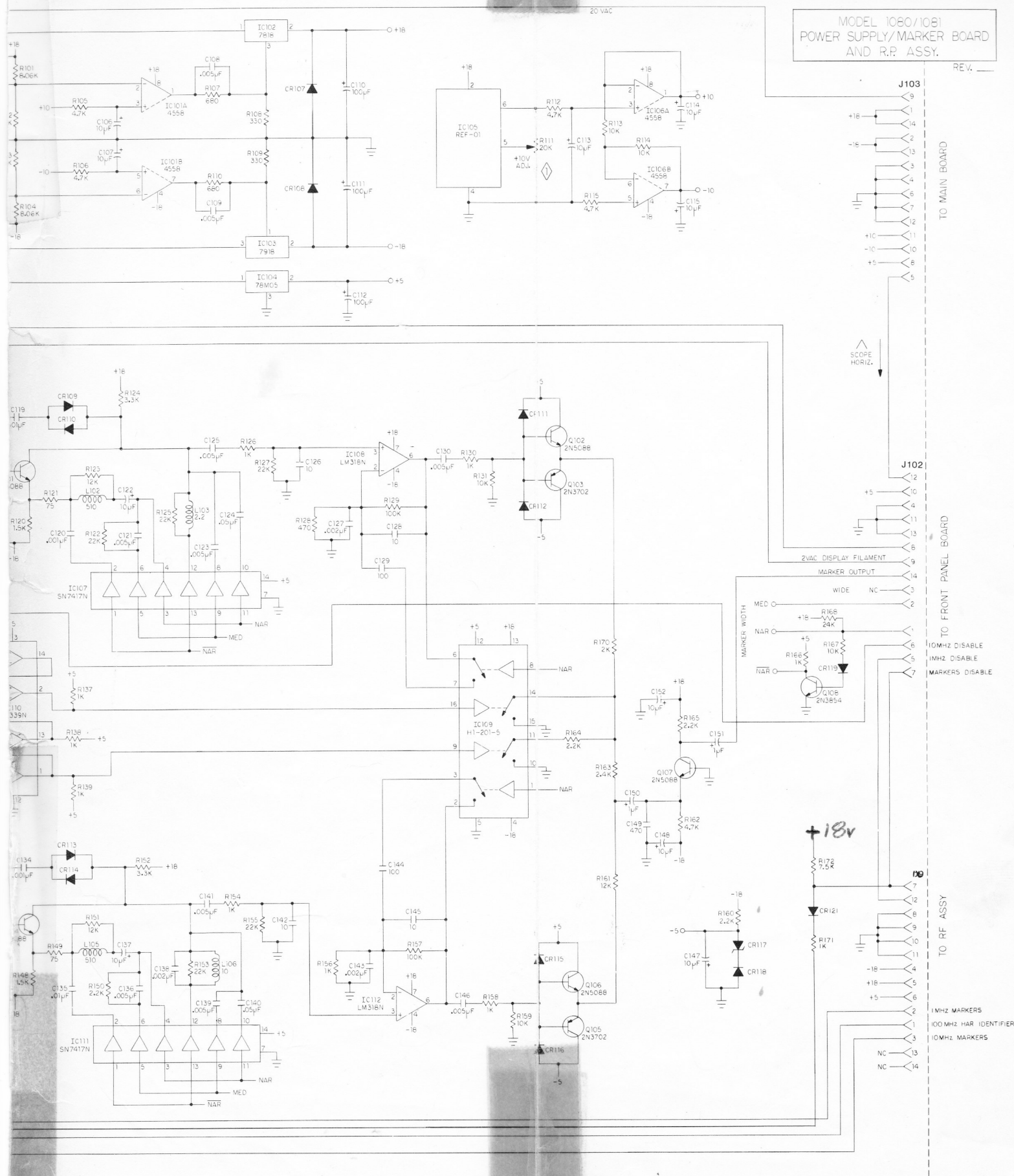

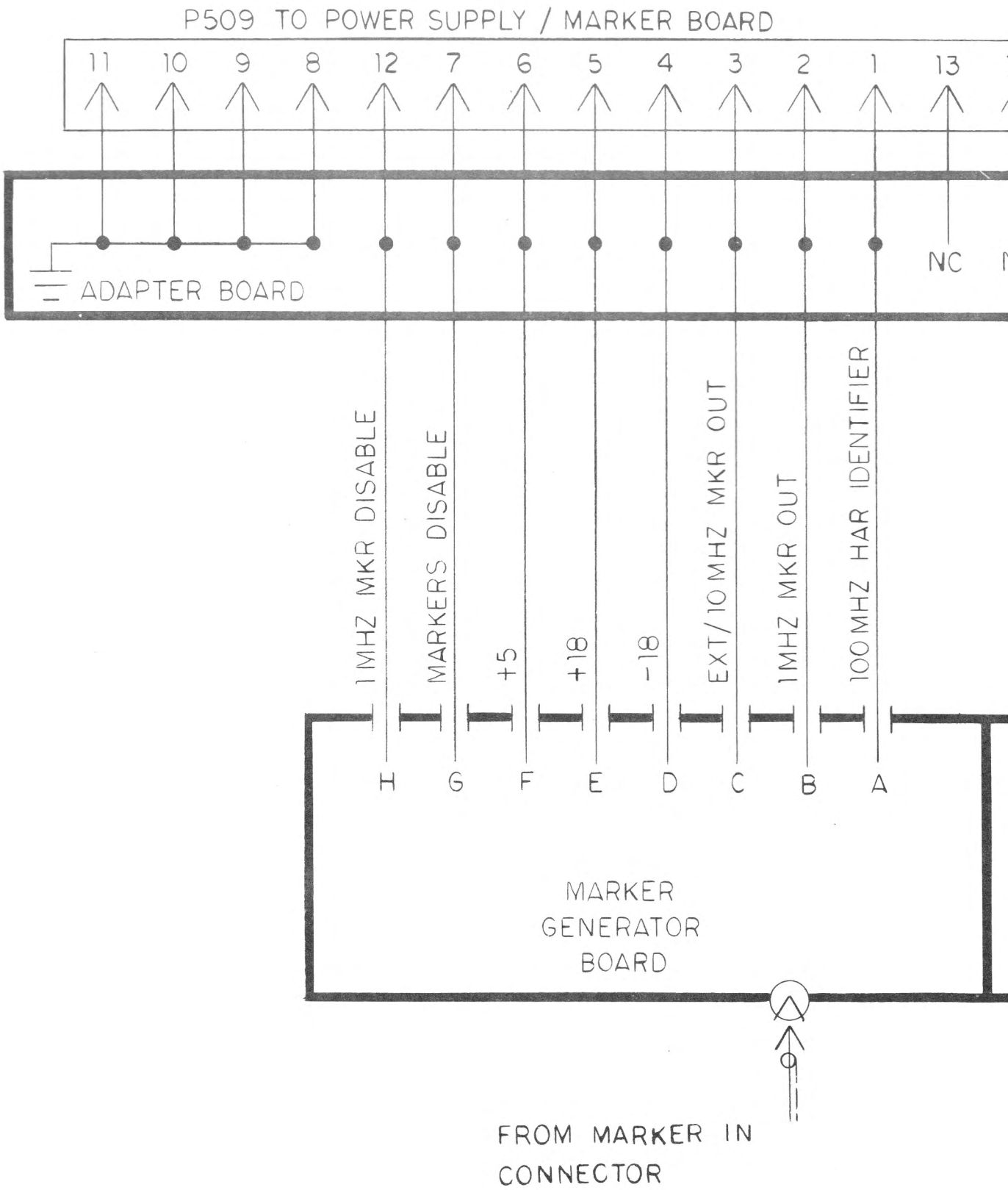

MA175/175-1
RF ASSY.

REV. A

P508 TO MAIN PC BOARD

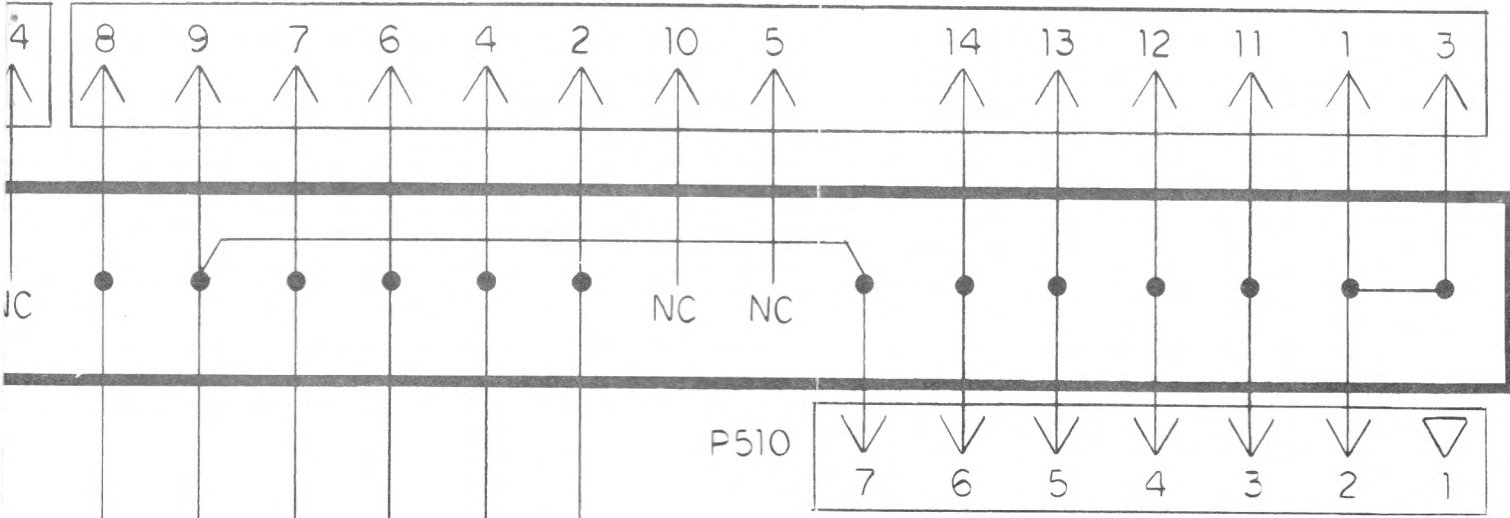

TO J10 ON STEP ATTEN
PROGRAMMING SWITCH

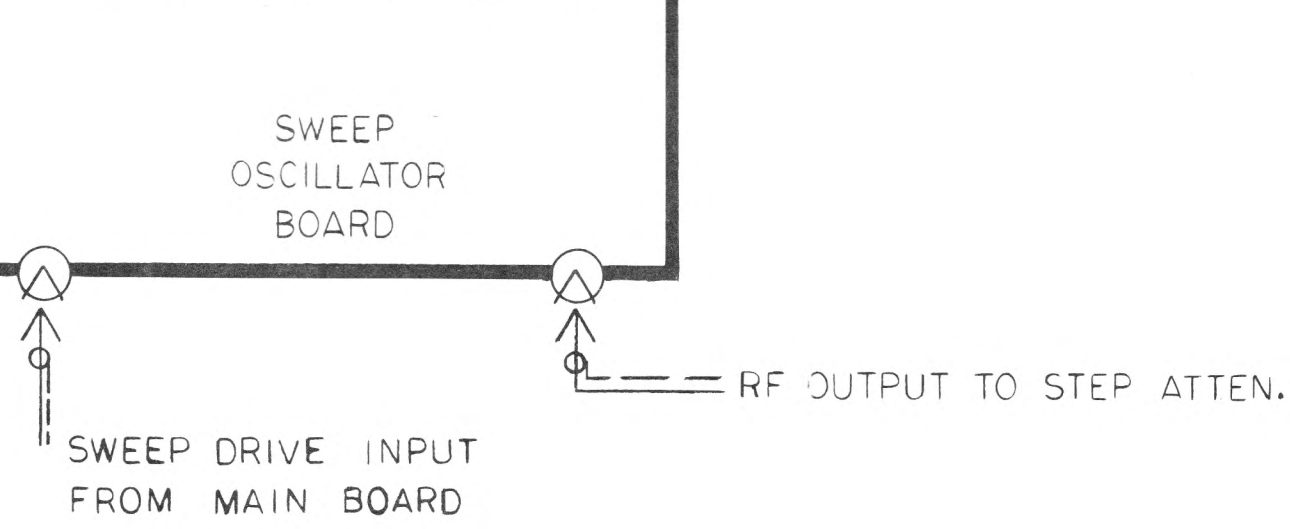
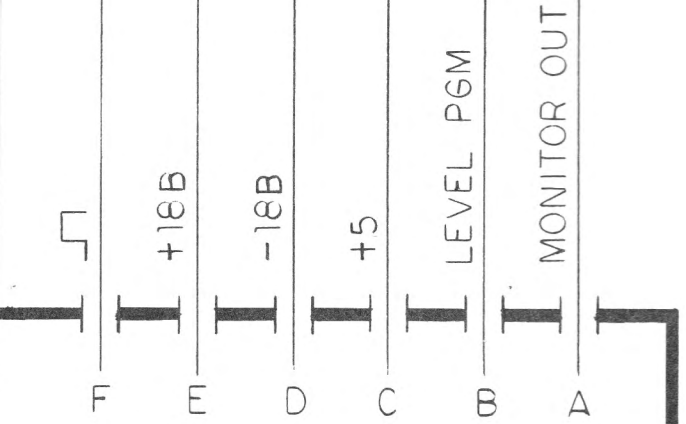

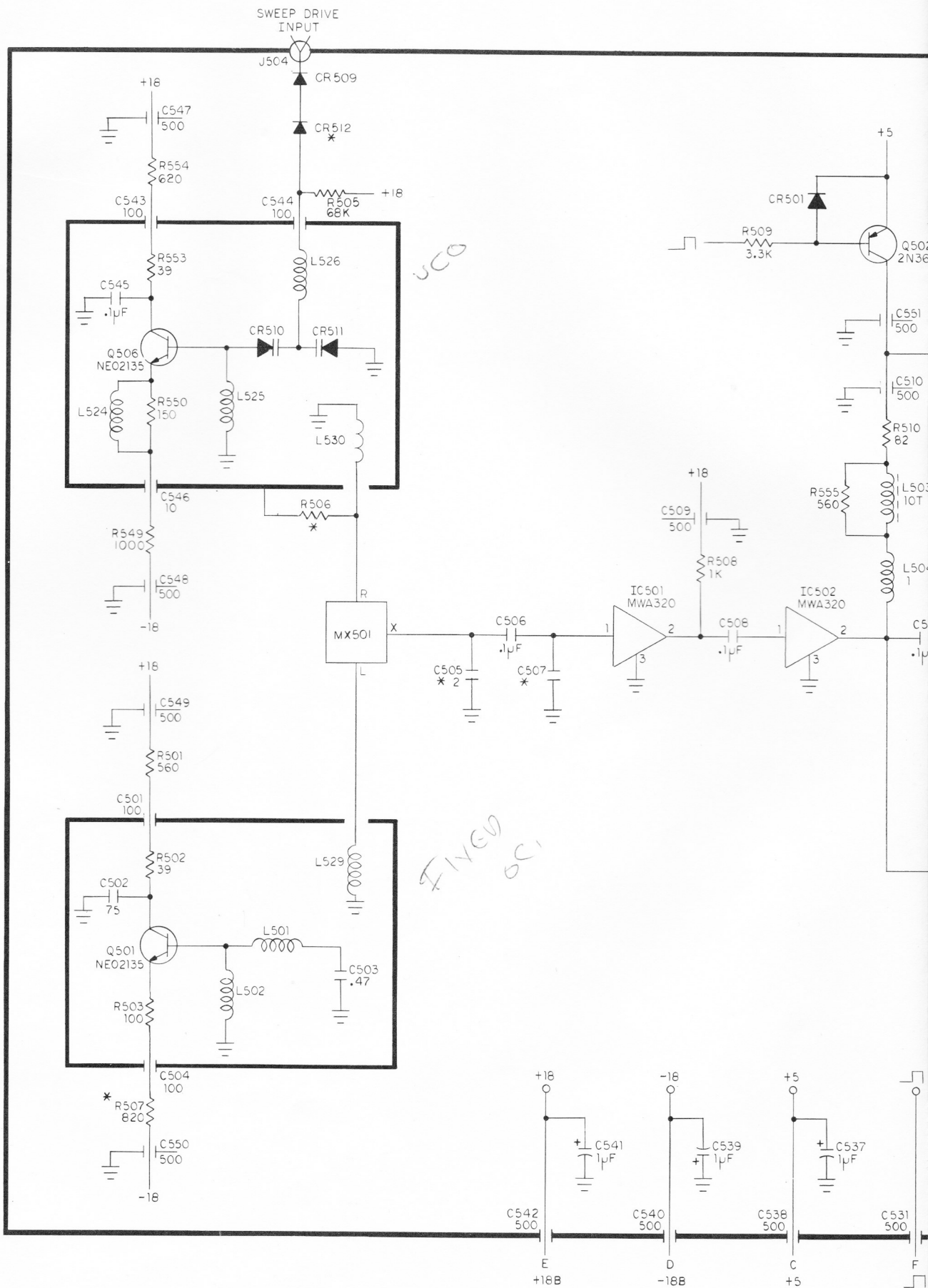

VCO

FIXED DC

MODEL 1080/1081
SWEEP OSCILLATOR
BOARD

REV. D

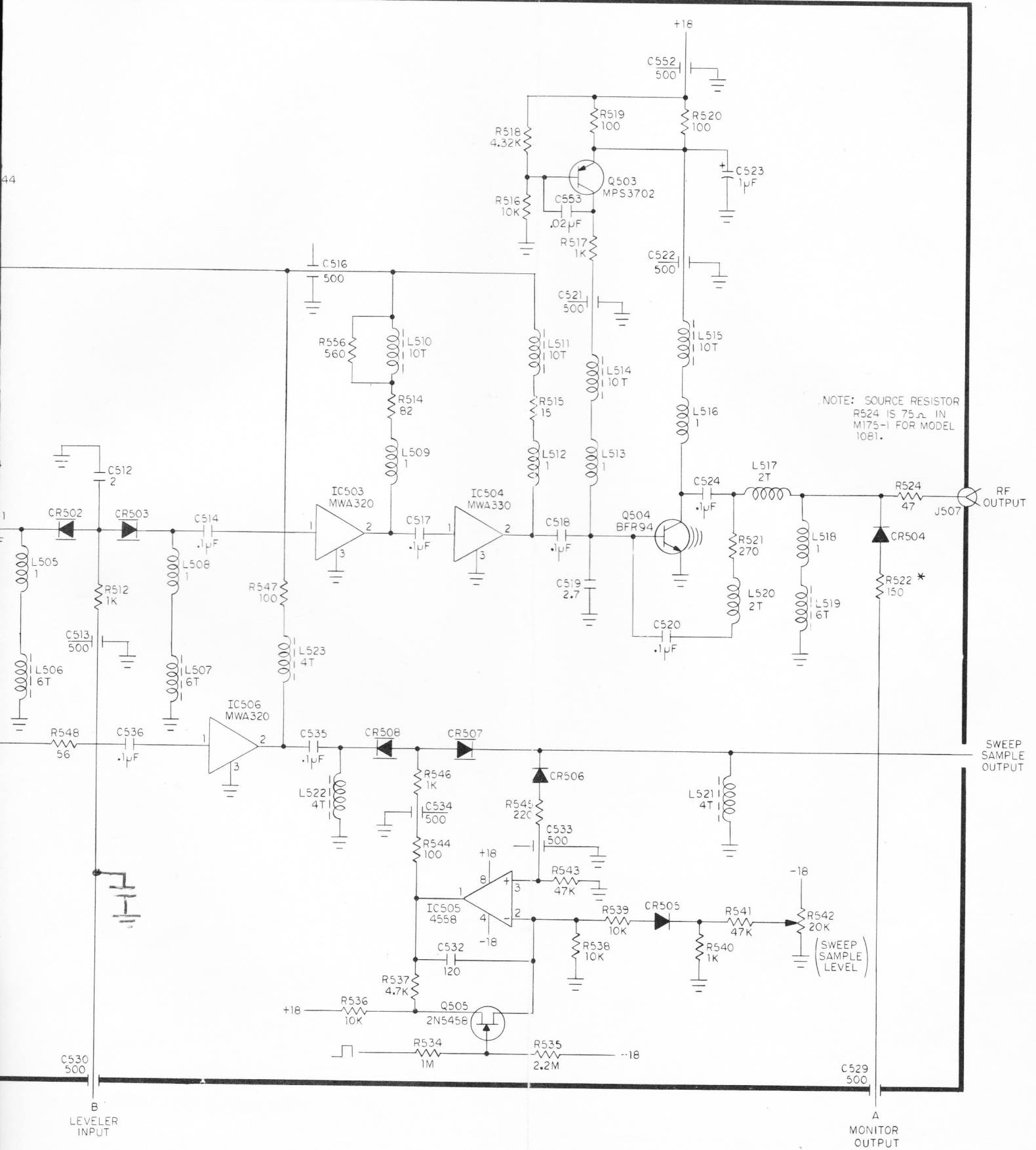

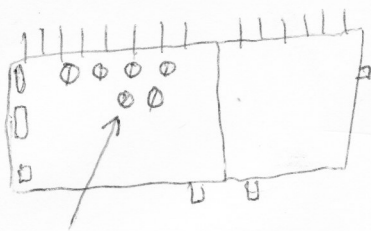

IF EVERY TENTH 1MHz MARKER IS
 Low in amplitude. Adjust
 this VARICAP if saturation
 pots. on MARKER BOARD
 don't fix the problem.

EXT.

SWEEP
 SAMPLE
 INPUT

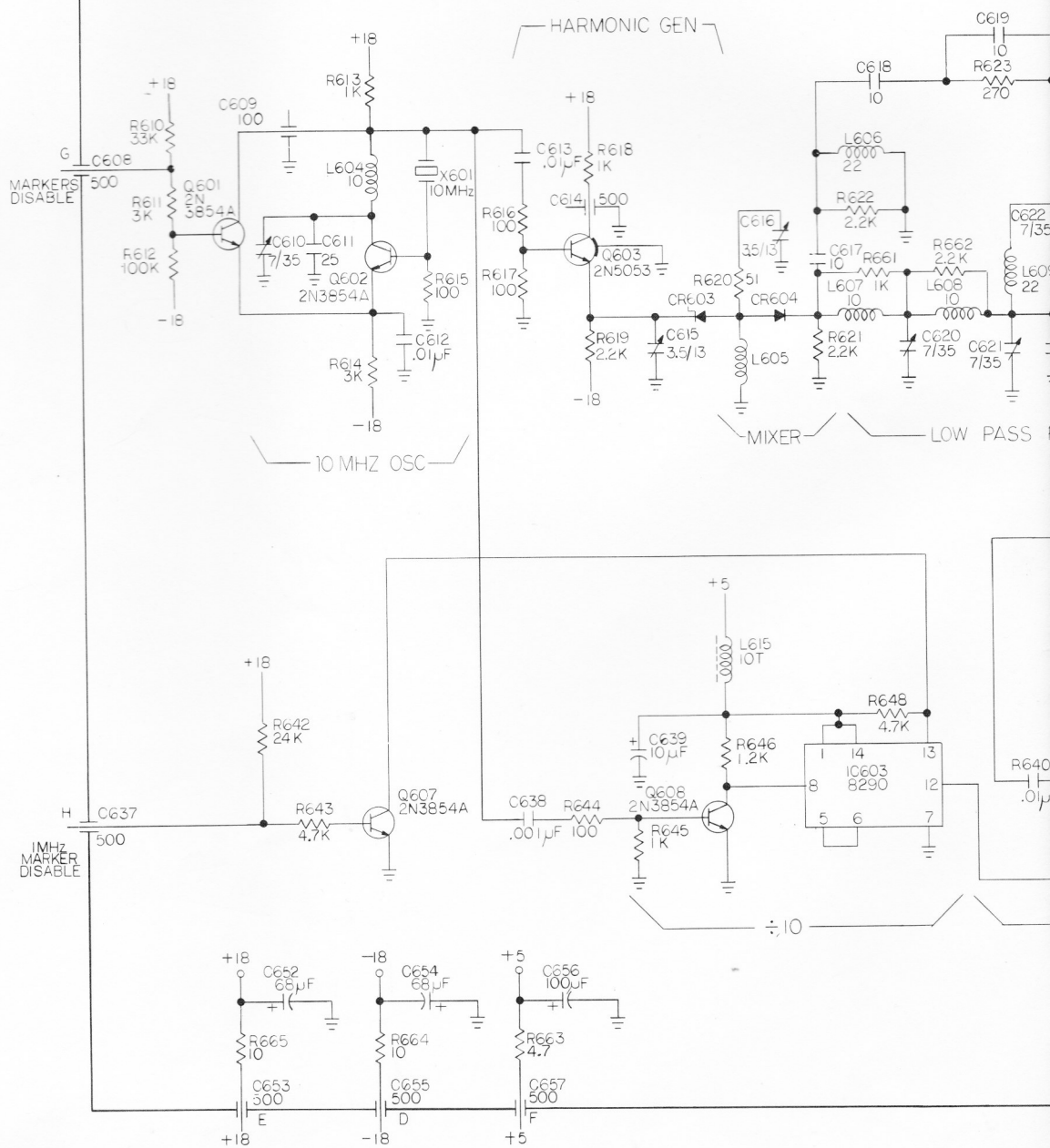

MODEL 1080/1081
MARKER GENERATOR
BOARD

REV. C

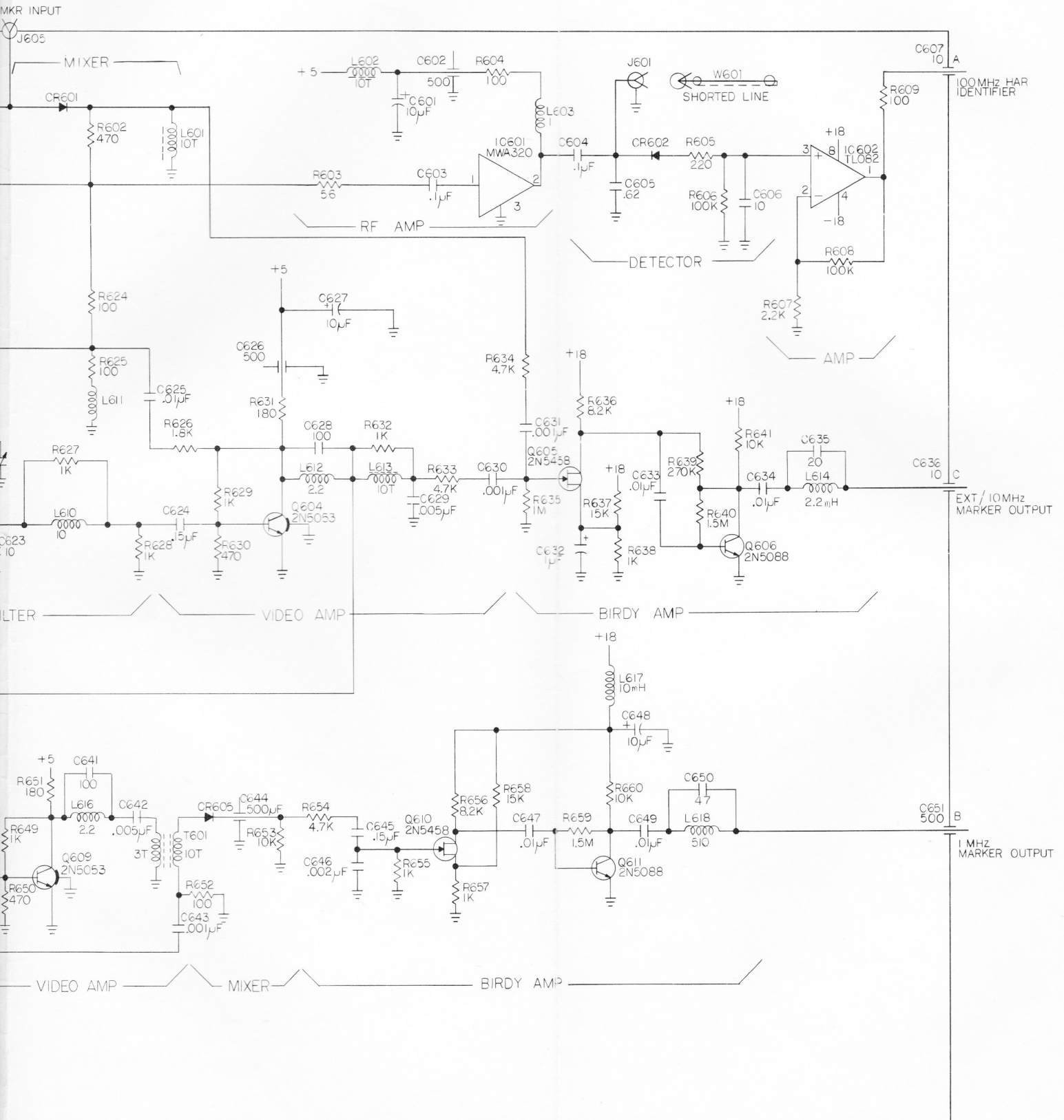

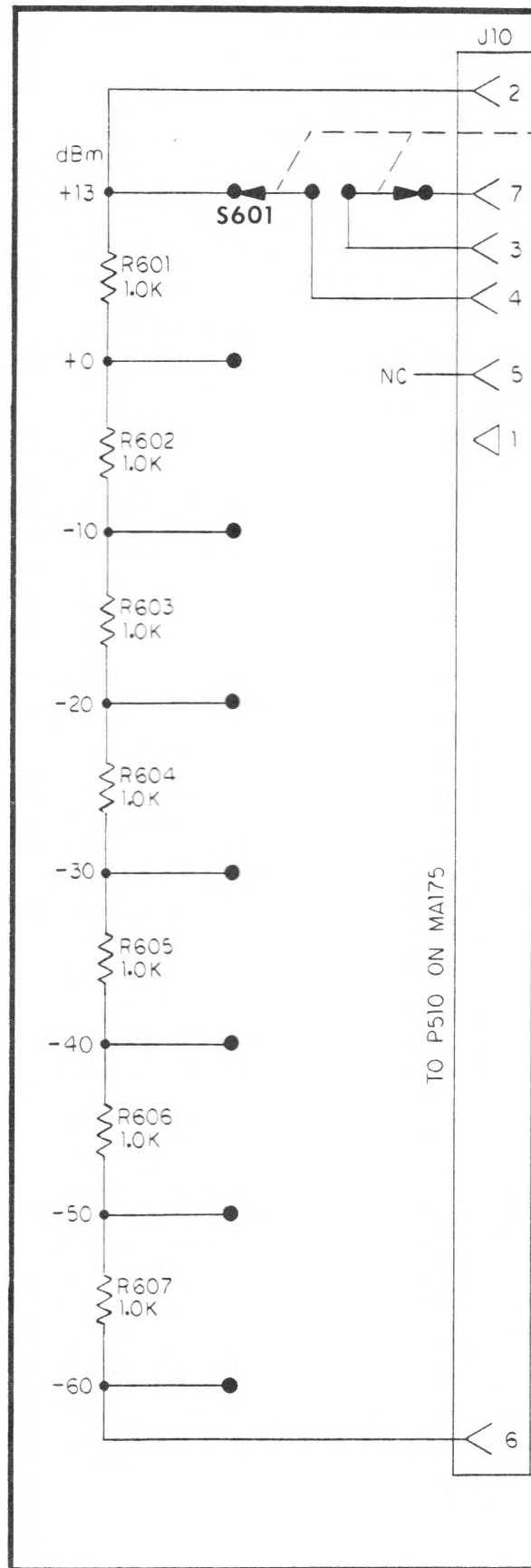

5070-11
STEP ATTENUATOR/
PROGRAMMING SWITCH REV. A

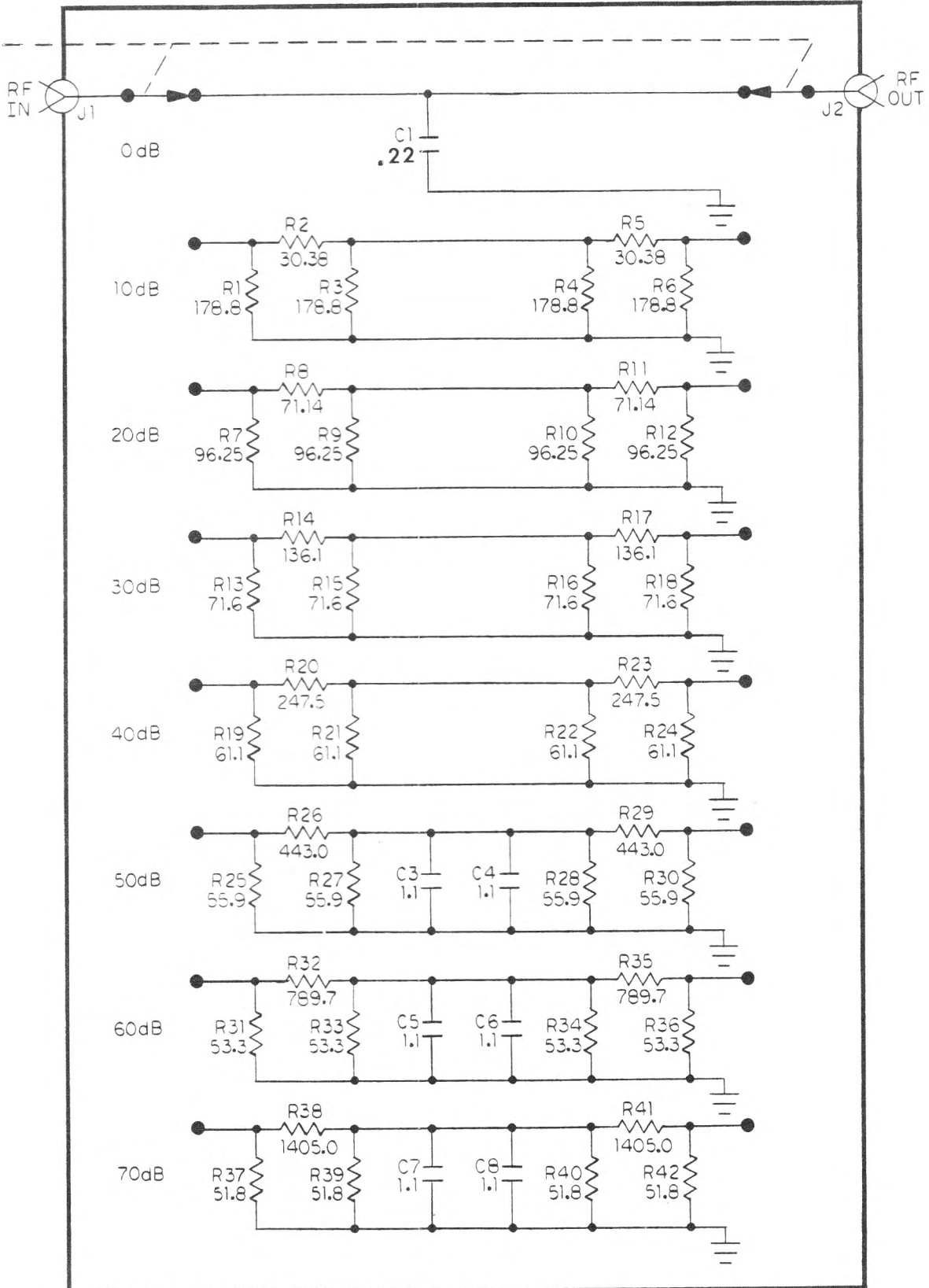

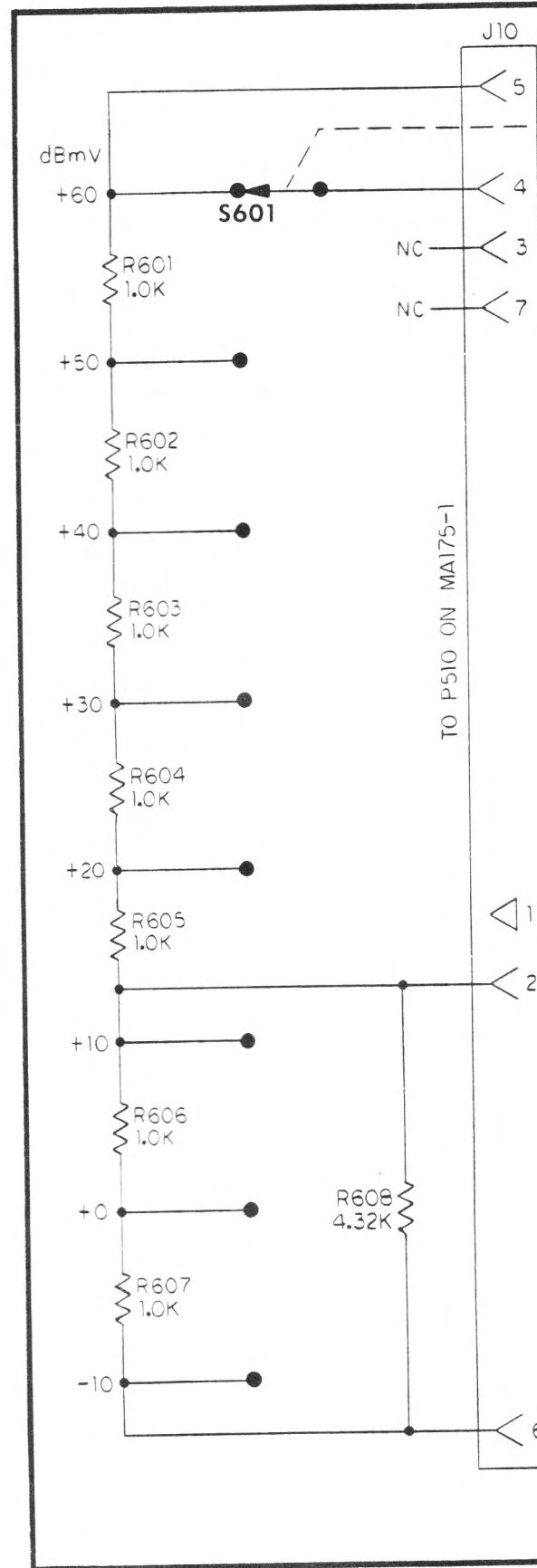

7570-04
STEP ATTENUATOR/
PROGRAMMING SWITCH

REV. _____

