

# MODEL 183 5 MHz XCG / SWEEP GENERATOR

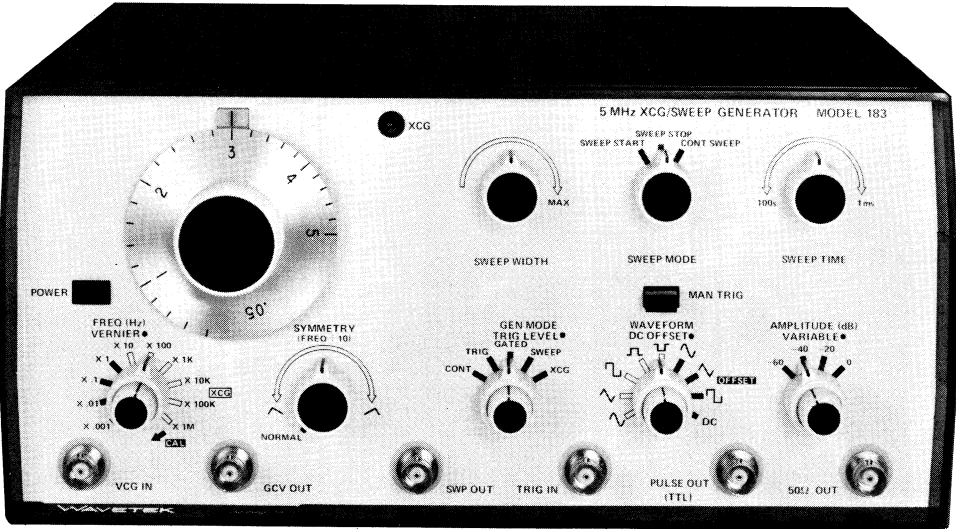

# WAVETEK

# WARRANTY

All Wavetek instruments are warranted against defects in material and workmanship for a period of one year after date of manufacture. Wavetek agrees to repair or replace any assembly or component (except batteries) found to be defective, under normal use, during this period. Wavetek's obligation under this warranty is limited solely to repairing any such instrument which in Wavetek's sole opinion proves to be defective within the scope of the warranty when returned to the factory or to an authorized service center. Transportation to the factory or service center is to be prepaid by purchaser. Shipment should not be made without prior authorization by Wavetek.

This warranty does not apply to any products repaired or altered by persons not authorized by Wavetek, or not in accordance with instructions furnished by Wavetek. If the instrument is defective as a result of misuse, improper repair, or abnormal conditions or operations, repairs will be billed at cost.

Wavetek assumes no responsibility for its product being used in a hazardous or dangerous manner either alone or in conjunction with other equipment. High voltage used in some instruments may be dangerous if misused. Special disclaimers apply to these instruments. Wavetek assumes no liability for secondary charges or consequential damages and, in any event, Wavetek's liability for breach of warranty under any contract or otherwise, shall not exceed the purchase price of the specific instrument shipped and against which a claim is made.

Any recommendations made by Wavetek for use of its products are based upon tests believed to be reliable, but Wavetek makes no warranty of the results to be obtained. This warranty is in lieu of all other warranties, expressed or implied, and no representative or person is authorized to represent or assume for Wavetek any liability in connection with the sale of our products other than set forth herein.

**MODEL 183  
5 MHz XCG / SWEEP  
GENERATOR**

**WAVETEK**

Box 651, San Diego, Calif., 714-279-2200

# CONTENTS

<b>SECTION 1</b>	<b>GENERAL DESCRIPTION</b>	
	1.1 THE MODEL 183 . . . . .	1-1
	1.2 SPECIFICATIONS . . . . .	1-1
<b>SECTION 2</b>	<b>INITIAL PREPARATION</b>	
	2.1 UNPACKING INSPECTION . . . . .	2-1
	2.2 PREPARATION FOR USE . . . . .	2-1
	2.3 ELECTRICAL ACCEPTANCE CHECK . . . . .	2-1
<b>SECTION 3</b>	<b>OPERATION</b>	
	3.1 CONTROLS AND CONNECTORS . . . . .	3-1
	3.2 OPERATION . . . . .	3-5
	3.2.1 Signal Termination . . . . .	3-5
	3.2.2 Continuous Operation . . . . .	3-5
	3.2.3 Trigger Mode . . . . .	3-6
	3.2.4 Triggering . . . . .	3-6
	3.2.5 GATED (or Tone Burst) Mode . . . . .	3-6
	3.2.6 SWEEP Mode . . . . .	3-6
	3.2.7 XCG Mode . . . . .	3-7
	3.2.8 Voltage Control – VCG . . . . .	3-7
<b>SECTION 4</b>	<b>CIRCUIT DESCRIPTION</b>	
	4.1 VOLTAGE CONTROLLED GENERATOR . . . . .	4-1
	4.2 SWEEP GENERATOR . . . . .	4-2
	4.3 CRYSTAL CONTROL . . . . .	4-2
<b>SECTION 5</b>	<b>CALIBRATION</b>	
	5.1 FACTORY REPAIR . . . . .	5-1
	5.2 REQUIRED TEST EQUIPMENT . . . . .	5-1
	5.3 REMOVING GENERATOR COVER . . . . .	5-1
	5.4 CALIBRATION . . . . .	5-1
<b>SECTION 6</b>	<b>TROUBLESHOOTING</b>	
	6.1 INTRODUCTION . . . . .	6-1
	6.2 CIRCUIT BOARD ACCESS . . . . .	6-1
	6.3 BASIC TECHNIQUES . . . . .	6-1
	6.4 TROUBLESHOOTING INDIVIDUAL COMPONENTS . . . . .	6-1
	6.5 TROUBLESHOOTING GUIDE . . . . .	6-2
<b>SECTION 7</b>	<b>PARTS AND SCHEMATICS</b>	
	7.1 DRAWINGS . . . . .	7-1
	7.2 ORDERING PARTS . . . . .	7-1
	7.3 ADDENDA . . . . .	7-1

# SECTION 1

## GENERAL DESCRIPTION

### 1.1 THE MODEL 183

Wavetek Model 183, the 5 MHz XCG/Sweep Generator, is a precision source of sine, triangle, square, positive pulse and negative pulse waveforms plus dc voltage. Frequency of the waveforms is manually and remotely variable from 100  $\mu$ Hz to 5 MHz. Select frequencies from 2 Hz to 5 MHz can be locked to a crystal oscillator for maximum frequency accuracy.

The generator can repetitively sweep between two individually set frequencies and at a particular sweep rate. The amplitude of waveforms is continuously variable from 20V p-p, open circuit maximum, to -80 dB.

DC reference of the waveforms can be offset positively and negatively.

The symmetry of the waveforms is continuously adjustable from approximately 1:19 to 19:1. Varying symmetry provides variable duty cycle pulses, sawtooth and asymmetrical sine waveforms.





A voltage representing generator frequency, a fixed-amplitude pulse train of that frequency, and a voltage ramp representing frequency sweep rate are provided as front panel outputs.

### 1.2 SPECIFICATIONS

Specifications (waveform, frequency, and amplitude selection), operating modes, precision (accuracy), and waveform purity (quality) are listed in the following paragraphs.

#### 1.2.1 Versatility

##### Waveforms

Five selectable waveforms, sine , triangle , square , positive pulse , negative pulse , plus variable DC output. Symmetry of all waveform outputs is continuously adjustable from approximately 1:19 to 19:1. Varying symmetry provides variable duty cycle pulses, sawtooth, or asymmetrical sine waveforms. Separate sync output is included.

#### Control

Frequency can be controlled manually, with external voltage (VCG) or with internally generated ramp voltage. XCG (Crystal Controlled Generator), when selected, crystal locks on every frequency corresponding to the calibration marks on the dial.

#### Operating Frequency Range

Frequency selectable from 0.0001 Hz to 5 MHz in the following linear ranges:



X 0.001 . . . . .	0.0001 Hz to 0.005 Hz
X 0.01 . . . . .	0.001 Hz to 0.05 Hz
X 0.1 . . . . .	0.005 Hz to 0.5 Hz
X 1 . . . . .	0.05 Hz to 5 Hz
X 10 . . . . .	0.5 Hz to 50 Hz
X 100 . . . . .	0.5 Hz to 500 Hz
X 1K . . . . .	5 Hz to 5 kHz
X 10K . . . . .	50 Hz to 50 kHz
X 100K . . . . .	500 Hz to 500 kHz
X 1M . . . . .	5 kHz to 5 MHz



#### NOTE

*When SYMMETRY control is used, the output frequency is different from the dial indicated frequency. The maximum symmetry ratio obtainable is also dependent on the frequency dial setting. Symmetry must be normal for XCG operation.*

*There are 25 XCG frequencies in each of the X 10 thru X 1M ranges.*

#### Main Output

, , ; variable to 20V p-p into open circuit and 10V p-p into 50 $\Omega$  load. DC offset of waveform (or DC if selected) is adjustable to  $\pm$ 10 volts open circuit and  $\pm$ 5 volts into 50 $\Omega$  load.

, ; DC: 0 to +10 or -10 volts into open circuit and 0 to +5 or -5 volts into 50 $\Omega$  load.

Output dc voltage is limited to approximately  $\pm$ 10 volt open circuit and output current is limited to approximately 130 mA.

Output can be attenuated from 0 dB to -80 dB: -60 dB in 20 dB steps, plus a 20 dB vernier for continuous variation (20 dB vernier does not affect offset or DC).

Source Impedance: 50Ω.

#### Pulse Output

Output voltage is TTL compatible. Rise and fall times are typically 15 ns. Sync is normally a symmetrical square waveform; with SYMMETRY control ON, it is rectangular.

#### Sweep Output

SWEEP OUT connector provides an open circuit 0 to +5 volt (approximately) ramp from a 600Ω impedance source.

#### DC Offset

DC offset of  $\sim$ ,  $\sphericalangle$ , or  $\sqcap$  waveform, or DC if selected, is adjustable to ±10 volts open circuit and ±5 volts into a 50Ω load. Output current is limited to approximately 130 mA. Waveform + offset is limited to ±10V into an open circuit.

#### GCV Output

A dc voltage proportional to the instantaneous frequency of the generator output. 0 to +5V, open circuit, 1 kΩ source impedance.

### 1.2.2 Operating Modes

#### Continuous

XCG Off: Operating as a standard VCG (voltage controlled generator), frequency output is determined by front panel control settings in conjunction with external control voltage at VCG IN.

XCG On: Operates as a standard VCG, except output of main generator determined by dial and VCG input voltage is in 25 harmonic-related frequencies with crystal accuracy on X 10 range and above. Crystal lock indicated by lighted XCG lamp. Lock occurs at every mark on dial (from 0.2 to 5 in 0.2 increments) and for the equivalent VCG voltages plus dial.

#### Triggered

Only one complete cycle of output appears at 50Ω OUT connector for each pulse applied to TRIG IN connector (or press of MAN TRIG switch).

#### Gated

Same as triggered mode except that output oscillations continue for duration of gating signal applied to TRIG IN connector (or as the MAN TRIG switch is depressed).

#### Sweep

The internal ramp generator can sweep the main generator up in frequency with a linear ramp. The end frequency points may be individually set and the time for each sweep ramp can be varied from 100s to 1 ms.

#### XCG

GEN MODE switch to XCG gives XCG mode. When dial is rotated to a calibration mark, XCG lamp lights; generator is locked to crystal. There are 25 XCG frequencies in each of 6 ranges (XCG frequency ranges from 2 Hz to 5 MHz). XCG frequencies available with VCG voltages as well as dial.

### 1.2.3 Voltage Controlled Generator

VCG Control Range: Up to 1000:1 frequency change with external voltage input.

Input Impedance: 5 kΩ.

VCG Voltage: 0 to 5V.

VCG Slew Rate: 2% of range per μs.

VCG Linearity: ±0.5% for 0.0001 Hz to 50 kHz.

### 1.2.4 Triggered Generator

Trigger pulse is 1V p-p to ±10V; input impedance is 10 kΩ, 33 pF; minimum pulse width is 50 ns; maximum repetition rate is 5 MHz.

### 1.2.5 Horizontal Precision

#### Dial Accuracy (Symmetrical Waveform)

XCG Off: ±2% of full scale for 0.005 Hz to 5 MHz  
±4% of reading and ±2% of full scale for 0.0005 to 0.005 Hz

XCG On: ±0.01% of XCG setting (when XCG lamp is on).  
(X 10 range accuracy must be measured over a 10s period.)

#### Frequency Vernier

Approximately 1% of range. Vernier affects calibration of frequency dial.

#### Time Symmetry

±1% for 0.005 to 500 kHz.

#### XCG Locking Time

Less than 500 ms for X 1K thru X 1M.  
Less than 5s for X 100.  
Less than 50s for X 10.

### 1.2.6 Vertical Precision

#### Amplitude Change With Frequency (Sine)

Less than 0.1 dB to 100 kHz.

Less than 0.2 dB to 1 MHz.

Less than 1 dB to 5 MHz.

#### Step Attenuator Accuracy

±0.3 dB per 20 dB step.

#### Stability

Short Term: ±0.05% for 10 minutes.

Long Term: ±0.25% for 24 hours.

Percentages apply to amplitude, dc offset and main generator frequency in the linear mode.

#### Amplitude Symmetry

±1% of amplitude range to 1 MHz for all symmetrical waveforms.

### 1.2.7 Purity

#### Sine Distortion

Less than 0.5% for 10 Hz to 100 kHz.

Less than 1% for 0.005 to 1 MHz.

All harmonics at least 30 dB down for 1 to 5 MHz.

#### Triangle Linearity

Greater than 99% for 0.0005 Hz to 100 kHz.

### Square Wave Rise and Fall Time

Less than 25 ns terminated into 50Ω load.

### Square Wave Total Aberrations

Less than 5%.

### 1.2.8 Environmental

All specifications listed are for 25°C ±5°C. For operation from 0°C to 55°C, specifications including horizontal precision, amplitude symmetry, and sine wave distortion are derated by a factor of 2.

### 1.2.9 Mechanical

#### Dimensions

11¼ in./28.6 cm wide; 5¾ in./14.5 cm high; 10¼ in./27.3 cm deep.

#### Weight

8.5 lb/3.8 kg net; 12 lb/5.5 shipping.

### 1.2.10 Power

90 to 110V, 105 to 125V, 180 to 220V or 210 to 250V;  
50 to 400 Hz. Less than 25 watts.

#### NOTE

*Specifications apply from 10 to 100% of a selected frequency range with SYMMETRY control OFF.*

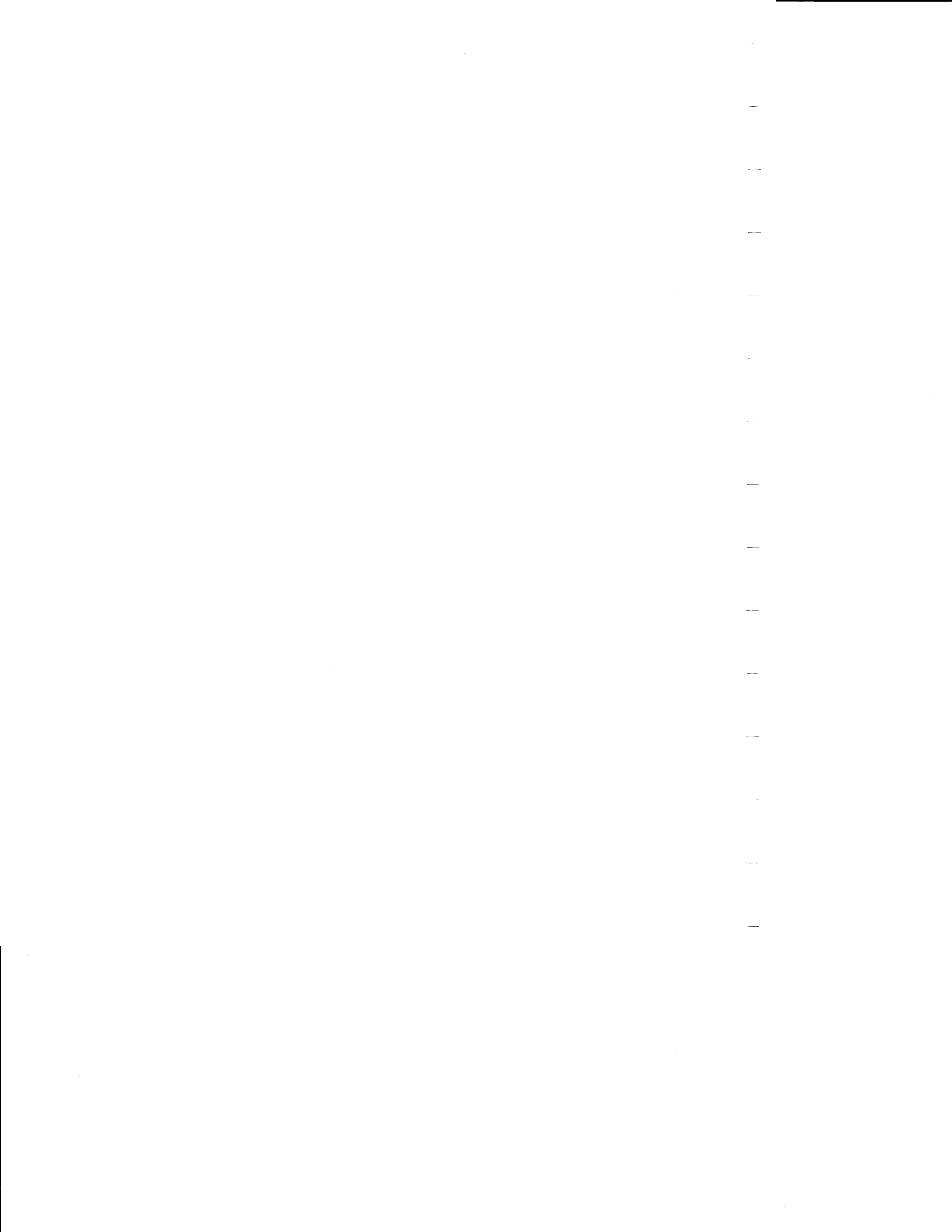



# SECTION 2

## INITIAL PREPARATION

### 2.1 UNPACKING INSPECTION

After carefully unpacking the instrument, inspect the external parts for damage to knobs, dials, indicators, surface areas, etc. If there is damage, file a claim with the carrier who transported the instrument. Retain the shipping container and packing material for use in case reshipment is required.

### 2.2 PREPARATION FOR USE

Before connecting the instrument to line power, be sure the rear panel 115/230V and HI/LO switches are set to the value nearest the line voltage and that the fuse is correct for the switch setting. Be sure that the plug on the power cord is the proper mate for the line receptacle.

AC Line Voltage	Switch A	Switch B	Fuse (SB)
90 - 110	115	LO	1/4 amp
105 - 125	115	HI	1/4 amp
180 - 220	230	LO	1/8 amp
210 - 250	230	HI	1/8 amp

### 2.3 ELECTRICAL ACCEPTANCE CHECK

This checkout procedure verifies the generator operation. If a malfunction is found, refer to the Warranty in the front of this manual. An oscilloscope, frequency counter, 50Ω coax cables and 50Ω feedthru are needed for this procedure (see figure 2-1).

Preset the generator front panel controls as follows:

Control	Position
GEN MODE . . . . .	CONT
WAVEFORM . . . . .	∩
SYMMETRY . . . . .	NORMAL
FREQ Range . . . . .	X 1K
FREQ VERNIER . . . . .	CAL
Frequency Dial . . . . .	1
AMPLITUDE . . . . .	0 dB
AMPLITUDE VARIABLE . . . . .	Full clockwise
DC OFFSET . . . . .	12 o'clock
TRIG LEVEL . . . . .	Full counterclockwise
SWEEP MODE . . . . .	CONT SWEEP
SWEEP WIDTH . . . . .	MAX
SWEEP TIME . . . . .	12 o'clock

Perform the steps in table 2-1. Where tolerances are not given, only approximated values are required to verify operation.

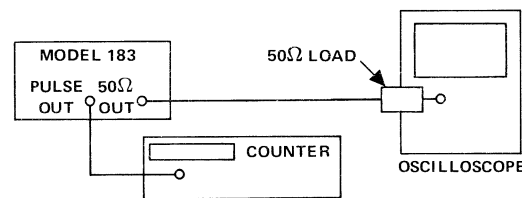

Figure 2-1. Acceptance Test Setup

Table 2-1. Performance Checkout

Step	Control	Position/Operation	Observe at 50Ω OUT
	<b>Function</b>		
1	POWER	Push on	Sine wave, 1 kHz, 10V p-p
2	WAVEFORM	∩	Triangle wave
3	WAVEFORM	⌋	Square wave
4	WAVEFORM	⌌	Positive pulse

Table 2-1. Performance Checkout (Continued)





Step	Control	Position/Operation	Observe at 50Ω OUT
5	WAVEFORM		Negative pulse
6	SYMMETRY	cw	Frequency ÷ 10, decreasing negative pulse width
7	SYMMETRY	ccw	Decreasing positive pulse width
8	SYMMETRY	NORMAL	---
9	WAVEFORM	 (OFFSET)	Sine wave, 1 kHz
<b>Frequency</b>			
10	GEN MODE	XCG	10 ±0.001 Hz (XCG lamp lighted)
11	FREQ Range	X 100, --- X 1M	Frequency increases by a decade for every change of switch position. Respective tolerances are: ±0.01 Hz, ±0.1 Hz, ±1 Hz, ±10 Hz, and ±100 Hz.
12	GEN MODE	CONT	1 MHz
13	FREQ Range	X 1	1 Hz
14	FREQ Range	X .1, --- X .001	Detect generator running
15	FREQ Range	X 1K	---
16	FREQ VERNIER	ccw	Frequency decreases by at least 50 Hz
17	FREQ VERNIER	CAL	---
18	Frequency Dial	5	Frequency = 5 kHz
19	Frequency Dial	.05	Frequency = 50 Hz
20	Frequency Dial	1	---
<b>Amplitude</b>			
21	AMPLITUDE Range	-60 dB	10 mV p-p
22	AMPLITUDE VARIABLE	ccw	1 mV p-p
23	AMPLITUDE Range	0	1V p-p
24	DC OFFSET	cw	Positive slew; about +5V positive peak
25	DC OFFSET	ccw	Negative slew; about -5V negative peak
26	WAVEFORM	 (No OFFSET)	Triangle wave

Table 2-1. Performance Checkout (Continued)

Step	Control	Position/Operation	Observe at 50Ω OUT
<b>Trigger &amp; Gate</b>			
27	GEN MODE	TRIG	0 Vdc
28	MAN TRIG	Push	Generate one cycle
29	GEN MODE	GATED	0 Vdc
30	MAN TRIG	Push and hold	Continuous  waveform
31	MAN TRIG	Release	0 Vdc
<b>Sweep</b>			
32	GEN MODE	SWEEP	Frequency sweeps
33	SWEEP TIME	cw	Sweep rate increases
34	SWEEP TIME	ccw	Sweep rate decreases

Disconnect the cable at 50Ω OUT and connect it to SWP  
 OUT: observe a 5 V ramp waveform. Connect it to GCV

OUT: observe a ramp plus dc. Connect it to PULSE OUT:  
 observe a 2.4 V positive pulse.



# SECTION 3

## OPERATION

### 3.1 CONTROLS AND CONNECTORS

The generator front panel controls and connectors are shown in figure 3-1 and keyed to the following descriptions:

① **POWER Switch**

Power is turned on and off with the POWER push-button. The frequency dial index ①A lights when power is turned on.

② **Frequency Dial**

Frequency settings of the dial multiplied by frequency range ①9 determine output frequency. In frequency sweep operation, this dial determines the frequency from which sweep is started.

③ **XCG Lamp**

The XCG lamp indicates that the selected frequency is locked or locking to the crystal circuit.

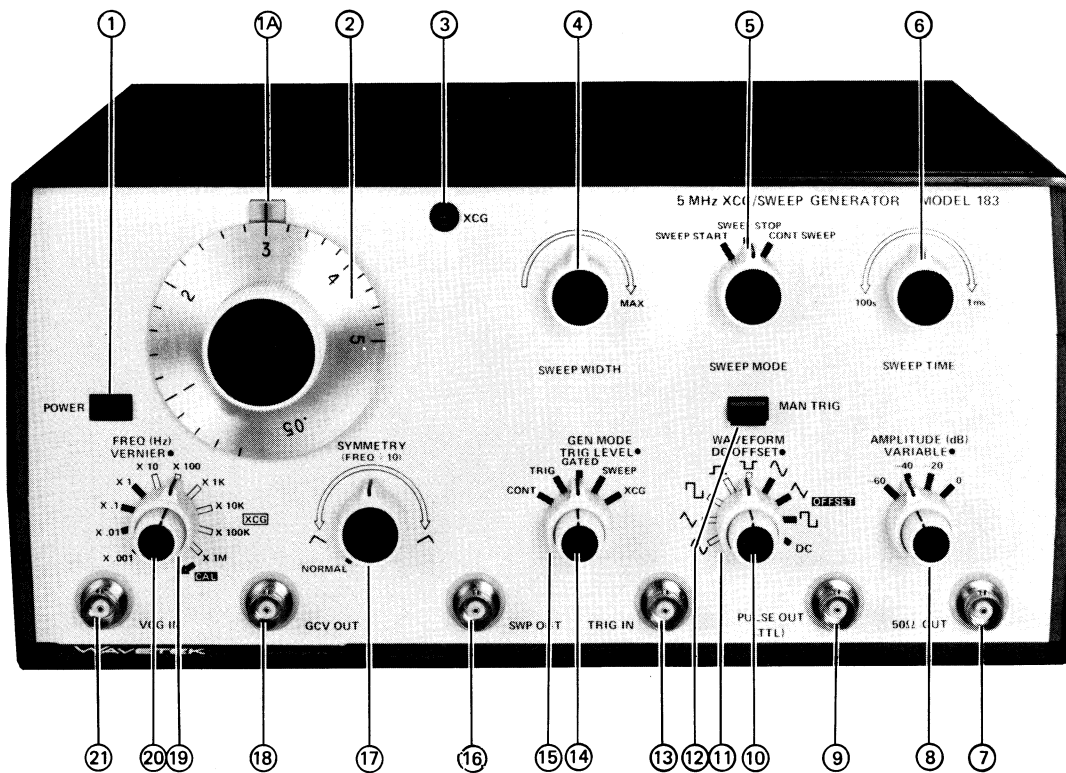

Figure 3-1. Front Panel Controls and Connectors

④ **SWEEP WIDTH Control**

The SWEEP WIDTH control determines the amount of frequency change that will occur in sweep mode. After the sweep start frequency is set by the frequency dial, SWEEP WIDTH determines the sweep stop frequency (see figure 3-2).

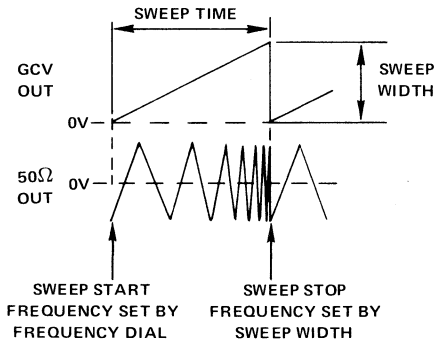

Figure 3-2. Effect of Sweep Time and Width on Output Frequency

⑤ **SWEEP MODE Selector**

The SWEEP MODE selector is enabled by the GEN MODE selector ⑮ set to SWEEP. After the start frequency of the generator is determined by the frequency dial ②, the stop frequency is determined by the SWEEP WIDTH control ④. The SWEEP START and SWEEP STOP settings will hold the output signal at the start and stop frequencies, respectively, while the frequency dial ② and SWEEP WIDTH control ④ are adjusted. CONT SWEEP allows frequency sweeping between the two set limits.

⑥ **SWEEP TIME Control**

Frequency of the internal sweep ramp, and thus, the sweep repetition rate, is governed by the SWEEP TIME control (see figure 3-2).

⑦ **Main Output Connector**

Maximum output of 10V p-p signals into a 50Ω load (20V p-p open circuit) is provided at the 50Ω OUT connector; all generator mode signals are delivered at this connector. See ⑧ for amplitude of output.

⑧ **AMPLITUDE Control**

The AMPLITUDE switch affects waveforms, dc output and waveform dc offset. The VARIABLE control affects waveforms only. Maximum waveform amplitude is with the 0 dB setting of the AMPLITUDE control and with the VARIABLE control fully cw (see the following table). Amplitude is decreased 20 dB with VARIABLE control fully ccw.

Function	Maximum Voltage at 0 dB	
	Open Circuit	50Ω Termination
~ , ~ , □	20V p-p	10V p-p
□	0 to +10V	0 to +5V
□	0 to -10V	0 to -5V
DC	±10V	±5V

⑨ **Synchronizing Pulse Output Connector**

A fixed amplitude (0 to about 5V) TTL compatible square wave of the generator frequency is provided at the PULSE OUT connector. This output can be used as a synchronizing reference for the main output ⑦. Phase of the waveforms relative to the sync output is shown in figure 3-3.

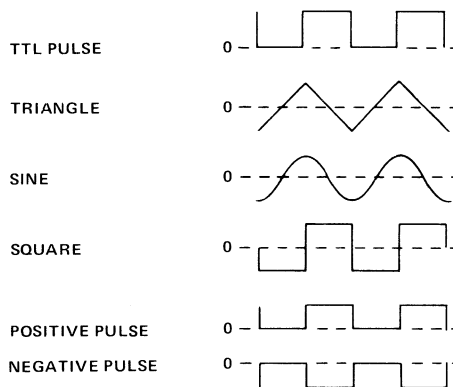

Figure 3-3. Pulse/Waveform Phase Relationship and Waveform Reference Lines

### ⑩ DC OFFSET Control

Offset of waveforms and dc voltage are controlled by the DC OFFSET control. The WAVEFORM switch ⑪ must be in one of the four right-hand settings. Center of the waveform reference (figure 3-3) is skewed positive with clockwise rotation, negative with counterclockwise rotation. Offset and dc voltage maximums are  $\pm 5V$  ( $50\Omega$  terminated).

### ⑪ WAVEFORM Selector

Sine  $\sim$ , triangle  $\wedge$ , and square  $\square$  waveforms, and positive and negative square pulse trains  $\square$ ,  $\square$  are selected for output by the WAVEFORM selector, with or without dc offset. When set for dc offset, the inner knob ⑩ controls the  $\pm 5V$  ( $50\Omega$  terminated) offset. DC is selected for dc output with voltage controlled by the inner knob ⑩.

### ⑫ Manual Trigger Control

In TRIG mode ⑮, the MAN TRIG pushbutton is used to trigger a single cycle of waveform output and, in the GATED mode, to gate the output of waveforms until released.

#### NOTE

The TRIG LEVEL control ⑭ must be fully CCW.

### ⑬ Remote Trigger Input Connector

The TRIG IN connector accepts voltage level inputs that trigger and gate the generator in TRIG and GATED modes ⑮, respectively. The trigger level control ⑭ determines the level at which the TRIG IN input is accepted for triggering or gating. A positive-going excursion through a voltage level, which can be set in the range of  $-7.5V$  to  $+7.5V$  by the TRIG LEVEL control triggers or gates the generator operation.

A negative-going dc excursion through the trigger level ends gated operation. Figure 3-4 shows triggering and gating of the generator waveforms at time  $t_1$ . Once triggered or gated, a full cycle of the selected waveform is output to its completion: when gating is removed at time  $t_2$ , for example, the last full cycle of waveform completes itself at time  $t_3$ .

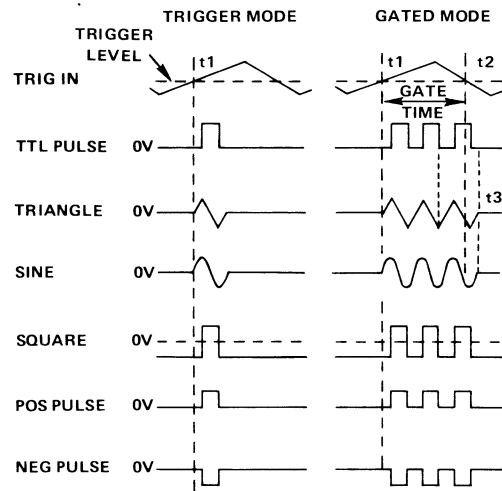

Figure 3-4. Generator Trigger and Gated Control

### ⑭ Trigger Level Control

The TRIG LEVEL control determines the level at which the input at the TRIG IN connector ⑬ is accepted as a trigger in the generator trigger and gated modes ⑮. The trigger level can be varied from fully clockwise, where a positive-going excursion thru  $-7.5V$  is a trigger, to fully counterclockwise, where a positive-going excursion thru  $+7.5V$  is a trigger.

### ⑮ Generator Mode Selector

Generator modes are:



1. Continuous – An uninterrupted output of the selected waveform at the selected frequency and amplitude.
2. Triggered – One cycle of the selected waveform at the selected frequency and amplitude when the trigger signal is detected at TRIG IN ⑬ or when manually triggered at ⑫.
3. Gated – A burst of the selected waveform at the selected frequency and amplitude, which starts when the gate signal is detected at TRIG IN ⑬ and lasts through the completion of the last cycle started before the removal of the gate signal, or starts and stops when manually gated at ⑫.

4. Automatically Swept Frequency — Sweep as determined by the SWEEP MODE control (5).
5. Crystal Controlled Generator — XCG frequencies, which are associated with each dial mark, are locked to a crystal oscillator. Lock is indicated by the XCG lamp (3) on.

**(16) Sweep Ramp Output Connector**

The internal sweep generator ramp is available at the SWP OUT connector. Ramp frequency is varied by the SWEEP TIME control. Output is a 0 to +5V ramp, 600Ω source impedance.

**(17) Waveform SYMMETRY Control**



Normal symmetrical output results when SYMMETRY is set to NORMAL; an asymmetrical, or unbalanced, waveform results when SYMMETRY is set between  and . (Asymmetric operation reduces generator frequency to approximately 1/10th the normal output.) Figure 3-5 shows the effect of SYMMETRY control on the waveforms.

**NOTE**

*When SYMMETRY control is used, the output frequency is different from the dial indicated frequency. The maximum symmetry ratio obtainable also depends on the frequency dial setting. A typical example is shown in table 3-1.*

**(18) GCV Output Connector**

GCV OUT provides dc excursions of 0 to about +5V which represent the output frequency in the selected range. Source impedance is 1 kΩ.

ASYMMETRY  SYMMETRY (NORM) ASYMMETRY 

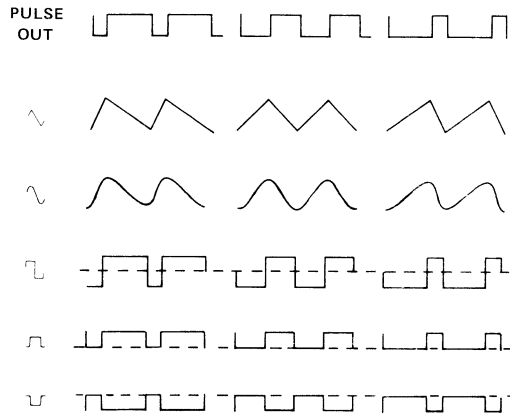

Figure 3-5. Effect of SYMMETRY Control

**(19) Frequency Range Control**

The selected range settings of the FREQ selector, multiplied with the frequency dial (2) setting determine output frequency.

**(20) Frequency VERNIER Control**

The frequency is as labeled on (19) and (2), when the VERNIER control is set fully clockwise to CAL (calibrated). Rotating the VERNIER control counterclockwise decreases output frequency. The range is approximately 1% of the selected frequency range.

Table 3-1. Dial Setting

Frequency Range	X 100K						
	Dial Setting	5	4	3	2	1	0.5
Indicated Frequency		500 kHz	400 kHz	300 kHz	200 kHz	100 kHz	50 kHz
Output Frequency		54 kHz	44 kHz	33 kHz	23 kHz	12 kHz	6.5 kHz
Maximum Symmetry Ratio		18:1	18:1	18:1	17:1	16:1	15:1



21 VCG Input Connector

DC voltage excursions of 0 to  $\pm 5$  volts at the VCG IN connector control frequency within the selected range. Positive inputs increase frequencies set by the frequency dial (2) and range control (19), and negative inputs decrease the frequencies. Input impedance is 5 k $\Omega$ . Frequency excursions of 1000:1 are possible.

3.2 OPERATION

Operation is discussed in terms of the five generator modes: continuous, triggered, gated, sweep and XCG (crystal controlled) plus VCG (voltage controlled).

3.2.1 Signal Termination

Proper signal termination, or loading, of the generator connectors is necessary for its specified operation. For example, the proper termination of the main output is shown in figure 3-6. Placing the 50 $\Omega$  terminator, or 50 $\Omega$  resistance, in parallel with a higher impedance matches the receiving instrument input impedance to the generator output impedance, thereby minimizing signal reflection or power loss on the line due to phase angle mismatch.

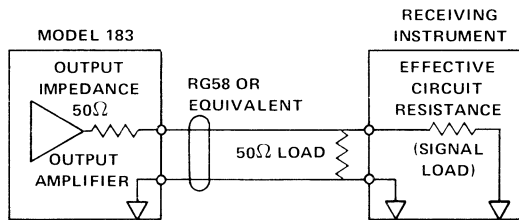

Figure 3-6. Signal Termination

The input and output impedance of the generator connectors are listed below:

Connector	Impedance
50 $\Omega$ OUT	50 $\Omega$
TRIG IN	10 k $\Omega$
PULSE OUT (TTL)	*
SWP OUT	600 $\Omega$
VCG IN	5 k $\Omega$
GCV OUT	1 k $\Omega$

\*The PULSE OUT connector can drive up to 20 Transistor-Transistor Logic (TTL) loads (low level between 0V and 0.4V, and high level between 2.4V and 5V).

3.2.2 Continuous Operation

Basic, or continuous, operation of the generator involves turning on power, selecting a continuous output mode, selecting a waveform, and setting the output signal frequency and amplitude. When operation is critical, allow a one-half hour warm-up period. The following steps demonstrate use as a basic function generator:

Step	Control/Connector	Setting
1	50 $\Omega$ OUT	Connect circuit (refer to paragraph 3.2.1).
2	PULSE OUT	Use for external synchronization, if required.
3	GEN MODE	CONT.
4	WAVEFORM	Choose one of the left-hand set of waveforms. If dc or dc offset is desired, use right-hand set.
5	SYMMETRY	NORMAL or desired asymmetry. (Affects frequency calibration.)
6	FREQ	As desired for frequency range.
7	Frequency Dial	As desired for exact frequency.
8	FREQ VERNIER	CAL, unless higher than normal frequency accuracy is required at a non-XCG frequency, in which case, monitor with a frequency counter.
9	AMPLITUDE	As desired.
10	AMPLITUDE VARIABLE	As desired (20 dB range).
11	DC OFFSET	As desired (step 4, right-hand set of waveforms must be chosen). CW positive offset, CCW negative offset. See figure 3-7 for restrictions.

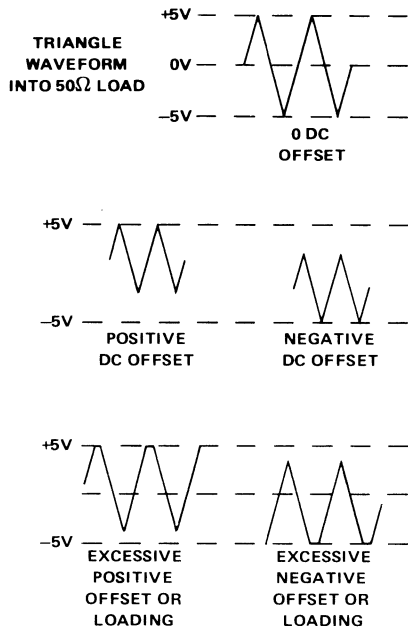

Figure 3-7. DC OFFSET Control

Remote trigger as follows:

Step	Control/Connector	Setting
1	TRIG LEVEL	Rotate the TRIG LEVEL control cw to set negative thresholds as low as -7.5V through which a positive-going TRIG IN connector input can pass to provide triggering. Ccw set positive thresholds of up to +7.5V through which a positive-going TRIG IN level can pass to provide triggering.
2	TRIG IN	Apply a positive-going voltage (through the threshold set in the preceding step) to the TRIG IN connector to provide remote triggering.

**CAUTION**

Avoid voltages greater than ±50V at TRIG IN to prevent damage to the generator.

**3.2.5 GATED (or Tone Burst) Mode**

Operation as a gated or tone burst generator is as for a triggered generator, only the operating mode is GATED, and releasing the MAN TRIG or removing the remote trigger voltage ends the burst of output waveform. Perform the steps of paragraph 3.2.2, only set the GEN MODE control to GATED. Refer to paragraph 3.2.4 for triggering.

**3.2.6 SWEEP Mode**

The generator can be set for a repetitive sweep of output frequencies within a given range. Operation is like continuous mode, only a separately controlled, internal ramp generator provides an additional VCG input to control frequency. (This internally-generated ramp is also available at the SWP OUT connector.) Perform the steps given in paragraph 3.2.2, only set the GEN MODE control in step 3 to SWEEP and include the following steps:

Step	Control/Connector	Setting
1	SWEEP MODE	SWEEP START.
2	Frequency Dial	Desired start sweep frequency.

**3.2.3 Trigger Mode**

Operation as a triggered one cycle generator is as for a basic function generator, only the operating mode is triggered (TRIG) instead of continuous (CONT), and a manual or remote trigger (MAN TRIG, TRIG IN) is used to start the single cycle of waveform. Perform the steps given in paragraph 3.2.2, only set the GEN MODE control in step 3 to TRIG. Refer to paragraph 3.2.4 for triggering.

**NOTE**

The signal at SWP OUT can be used as source of repetitive trigger inputs.

**3.2.4 Triggering**

Manual trigger as follows:

Step	Control/Connector	Setting
1	TRIG LEVEL	Full ccw.
2	MAN TRIG	Press for each cycle desired.

Step	Control/Connector	Setting
3	SWEEP MODE	SWEEP STOP.
4	SWEEP WIDTH	Desired stop sweep frequency.
5	SWEEP MODE	CONT SWEEP.
6	SWEEP TIME	As desired.

**NOTE**

To monitor the ramp generator, use the SWEEP OUT connector. To monitor the frequency of the main generator, use the GCV OUT connector, which is a voltage proportional to the generator frequency.

Crystal control and sweep control may be used simultaneously, but it is not recommended. However, discrete frequency stepping does occur for XCG frequencies within the sweep range, provided the sweep time between each frequency is much longer than the lock time of the XCG circuit.

**3.2.7 XCG Mode**

XCG (crystal controlled generator) operation allows selected XCG frequencies to be locked to a crystal oscillator for greater accuracy. XCG frequencies correspond to each of the 25 dial marks in the X 10 thru X 1M ranges. Follow the steps in paragraph 3.2.2, except in step 3 set GEN MODE to XCG. In step 7, frequency selection, the XCG lamp will light when frequency locking occurs.

**3.2.8 Voltage Control – VCG**

Operation with voltage control can be done in any mode but is usually done in continuous mode; the frequency within a particular range is additionally controlled with dc levels within ±5V, injected at the VCG IN connector. Perform the steps given in paragraph 3.2.2, only set the frequency dial to determine a reference from which the frequency is to be voltage controlled.

1. For frequency control with positive dc inputs at VCG IN, set the dial for a lower limit from which frequency is to be increased.
2. For frequency control with negative dc inputs at VCG IN, set the dial for an upper limit from which frequency is to be decreased.

3. For modulation with an ac input at VCG IN, set the dial at the desired center frequency. Do not exceed the maximum dynamic range of the selected frequency range.

**NOTE**

Crystal control and voltage control may be used simultaneously; however, ac excursions in this mode are not recommended.

Figure 3-8 is a nomograph with examples of the frequency dial effect as a reference for VCG IN voltages. Example 1 shows that with 0V VCG input (2nd column), frequency (3rd column) is as determined by the frequency dial setting of 2 (1st column). Example 2 shows that with a positive VCG input, output frequency is increased. Example 3 shows that with a negative VCG input, output frequency is decreased. (Note that the Factor of 50Ω OUT Frequency column must be multiplied by the frequency range in order to give the actual 50Ω OUT frequency.) For full 1000:1 VCG sweep of the generator frequencies, set the FREQ VERNIER full ccw.

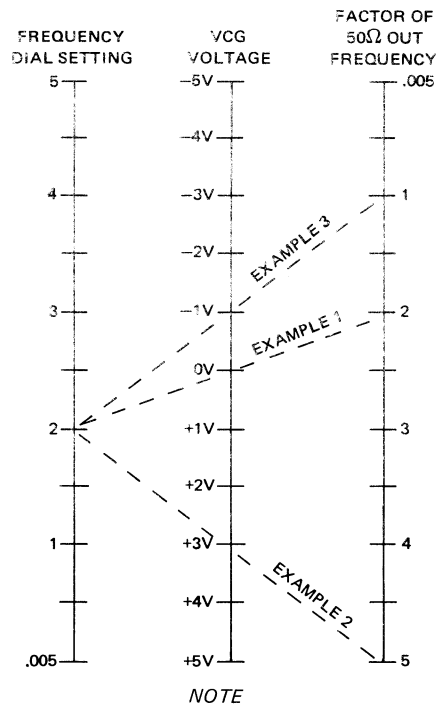

**NOTE**

The FREQ VERNIER must be rotated full ccw for 1000:1 range.

**Figure 3-8. VCG Voltage-to-Frequency Nomograph**

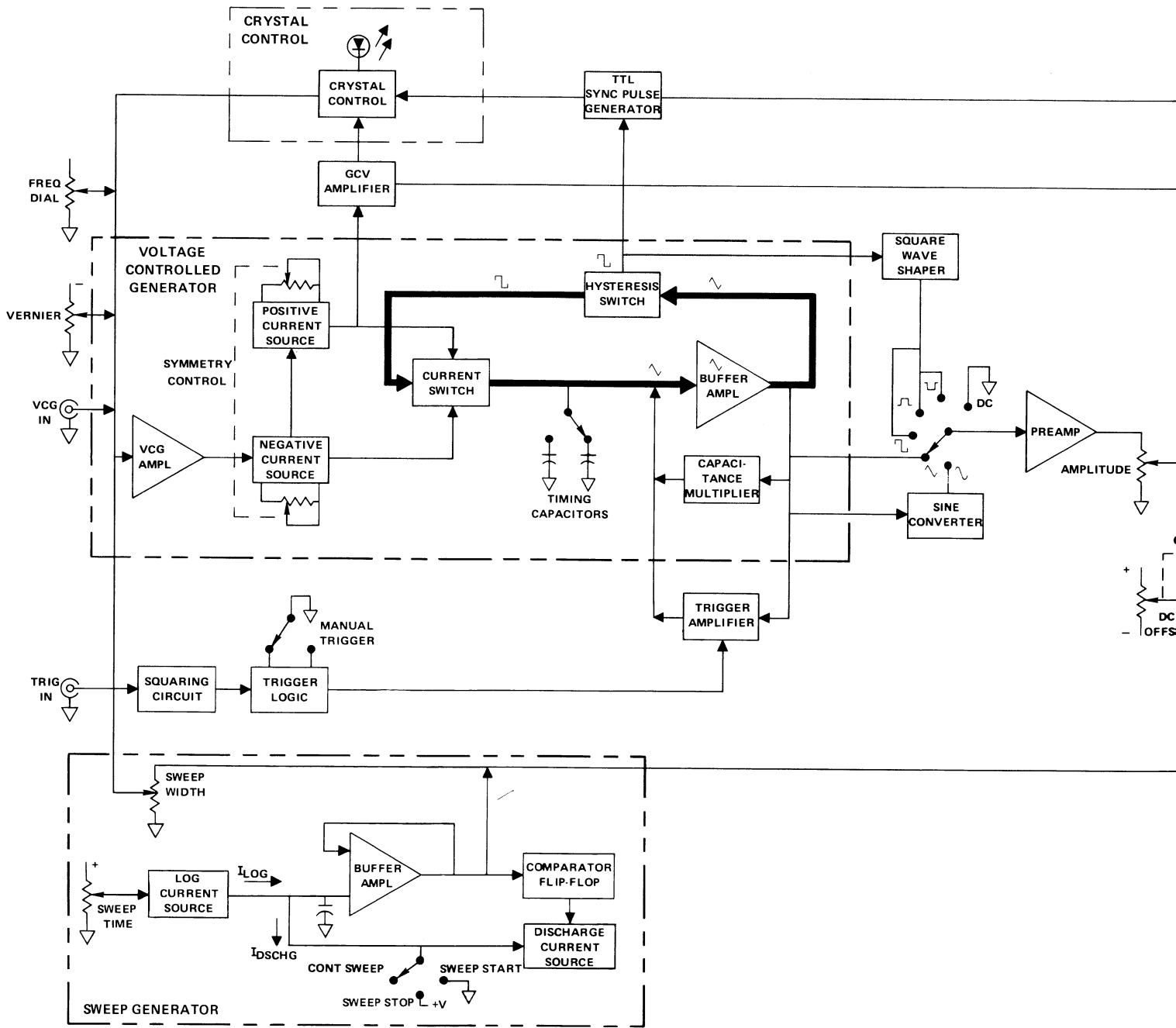
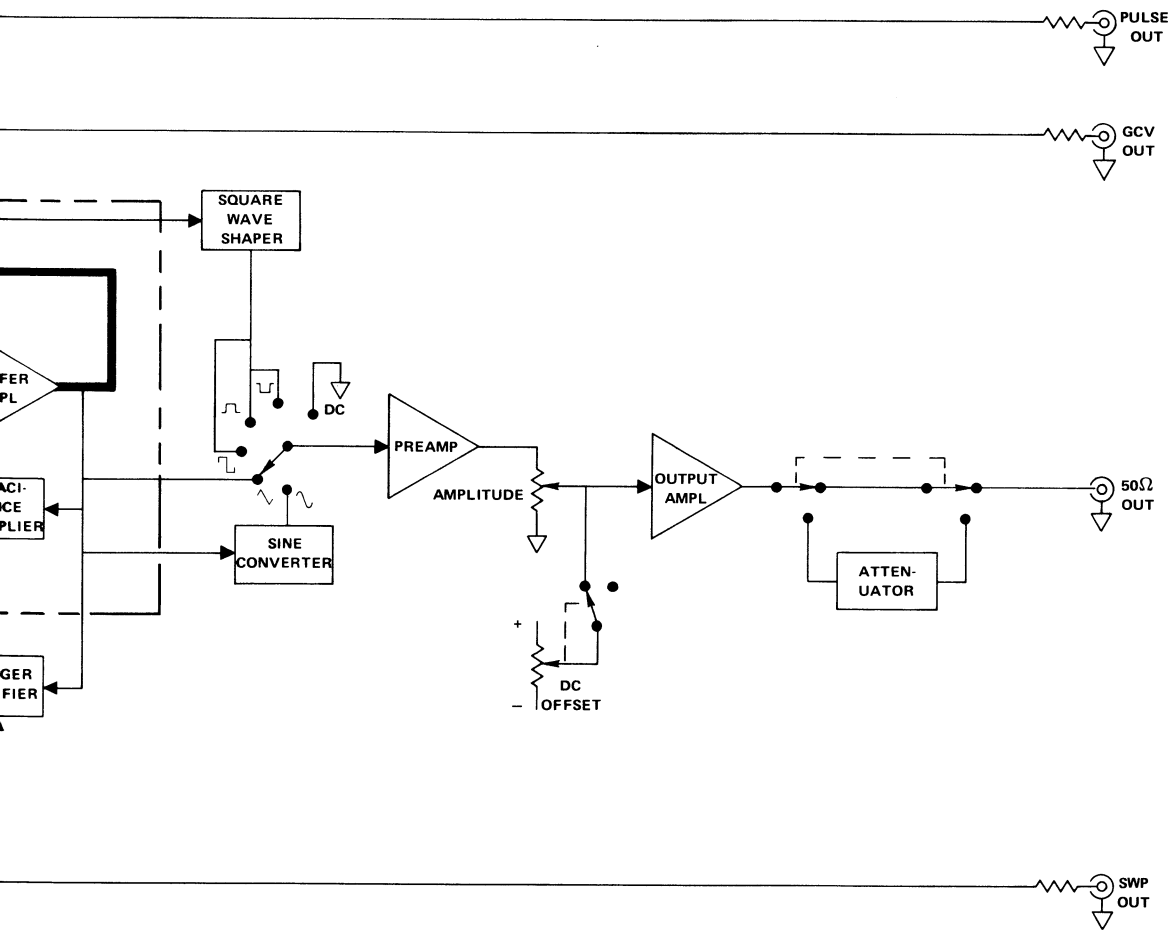

Figure 4-1. Simplified Block Diagram



# SECTION 4

## CIRCUIT DESCRIPTION

### 4.1 VOLTAGE CONTROLLED GENERATOR

The heart of the generator consists of the positive and negative current sources, the current switch, timing capacitors, triangle amplifier, and hysteresis switch (figure 4-1).

The positive and negative current sources generate equal but opposite polarity currents which charge and discharge the timing capacitor selected by the range selector. The current switch, which is controlled by the hysteresis switch, selects either the positive or the negative current as the input to the capacitor. Since the capacitor is being charged by a current source which changes polarity periodically, the voltage across the capacitor forms a triangle waveform. This waveform is fed through the triangle buffer amplifier to the hysteresis switch. The hysteresis switch determines when the triangle waveform reaches predetermined positive and negative peak values. When this occurs, the output of the hysteresis changes state and causes the current switch to select the opposite polarity current. The output of the hysteresis switch is a square wave whose edges correspond to the triangle peak values.

The magnitude of the current produced by the current sources is dependent upon the output of the VCG amplifier. By varying the output of the VCG amplifier, the frequency of the triangle and square waveforms may be controlled.

In order to generate sine waves, the triangle waveform is sine shaped in the sine converter circuit with nonlinear elements. The waveform switch selects the waveform of interest and a portion of the signal is selected by the amplitude potentiometer and applied to the output amplifier. The output amplifier is capable of driving a  $50\Omega$  load and may be dc offset. The amplifier output is routed to a  $50\Omega$  attenuator which can provide 60 dB of attenuation in 20 dB steps. An additional 20 dB of attenuation can be obtained from the amplitude control.

The square wave from the hysteresis switch is also applied to the TTL sync pulse generator, whose square wave output is TTL compatible.

To change frequency ranges, different timing capacitors may be selected by the frequency range switch. On the very slow frequencies the capacitance multiplier becomes active.

This circuit senses the capacitor charging current and then subtracts a certain percentage of it from the capacitor. As a result, the capacitor does not charge as fast, and the frequency, as a result, is lower.

Several things can affect the frequency of the generator by varying the output of the VCG amplifier. One is the frequency dial of the function generator which feeds a voltage to the VCG amplifier. In addition to the frequency dial, the frequency vernier feeds in a voltage to the VCG amplifier. The range of the vernier is approximately 1% of the full scale frequency. Finally, an external voltage applied to the VCG input can control the frequency of the generator loop. The VCG input allows frequency modulation of the generator by an external signal.

Under normal conditions the generator loop runs with the positive and negative current sources balanced. This results in symmetrical sine, triangle and square waveforms, or in the case of the square waveform, a duty cycle of 50%. By varying the symmetry control, the current sources may be unbalanced which results in the generation of asymmetrical waveforms. This allows the generation of pulses, ramps, and other waveshapes.

In the trigger mode, the generator is stopped by the trigger amplifier. This amplifier compares the output of the triangle amplifier to ground. Its output draws just the right amount of current away from the capacitor to keep it at zero volts. This level is known as the trigger baseline. When an external signal is applied to the trigger input, it is shaped into a fast rise time pulse by the squaring circuit and is applied to the trigger logic circuit. This circuit in turn shuts off the trigger amplifier for one cycle of the output waveform. Trigger input may also be made manually by the manual trigger switch.

The trigger logic circuit also allows the generator to run in the gated mode. In this mode the generator will run as long as the trigger input signal is positive. When it goes negative, the generator will continue to run until the last cycle is complete and then remain at the trigger baseline level.

The GCV output is an analog output voltage proportional to the instantaneous output frequency of the generator.

This is from the GCV amplifier which senses the positive current source output and generates a voltage proportional to the current.

#### 4.2 SWEEP GENERATOR

The linear sweep ramp is obtained by charging the capacitor with a constant current from the log current source. When the positive peak of the ramp reaches a predetermined value, the comparator turns on the discharge current source and quickly discharges the capacitor to zero volts. When this point is reached, the comparator resets and turns off the discharge current source. A new ramp cycle now begins.

The buffer amplifier provides a high input impedance to the capacitor, thus assuring a highly linear ramp. It also provides the power required to drive the main generator VCG circuit.

The log current source has a built-in log converter circuit which allows a single sweep rate control to provide sweep rates of 1 ms to 100s: a  $10^5$  control range.

A sweep output signal can drive X-Y recorders or other devices.

#### 4.3 CRYSTAL CONTROL

In the crystal control circuit, the phase of the TTL sync pulse is compared to a crystal controlled oscillator and a frequency error correction signal is generated. The error correction signal is an input to the VCG amplifier and causes the main generator to lock to the nearest harmonic of the basic XCG frequency of the range (all ranges except X 1). The basic XCG frequency corresponds to 0.2 on the dial. The harmonics correspond to the remaining major marks on the dial in 0.2 increments. In portions between major marks (harmonics), the capture bandwidth is exceeded, and no locking occurs. The XCG lamp lights whenever frequency lock occurs.

# SECTION 5 CALIBRATION

## 5.1 FACTORY REPAIR

Wavetek maintains a factory repair department for those customers not possessing the necessary personnel or test equipment to maintain the instrument. If an instrument is returned to the factory for calibration or repair, a detailed description of the specific problem should be attached to minimize turnaround time.

## 5.2 REQUIRED TEST EQUIPMENT

Spectrum Analyzer . . . . . 600 kHz to 5 MHz  
 Voltmeter . . . . . Microvolt dc measurement (0.01% accuracy)  
 Oscilloscope, Dual Channel . . . . . 150 MHz bandwidth  
 Distortion Analyzer . . . . . To 600 kHz  
 Counter . . . . . To 10 MHz (0.1% accuracy)  
 50Ω Load . . . . . ±0.1% accuracy

## 5.3 REMOVING GENERATOR COVER

### CAUTION

**Be aware that a circuit board and short cable are attached to the top cover. Lifting the top cover too far can damage the instrument.**

For main circuit board access, invert the instrument, remove the four screws in the cover, and lift off the bottom cover.

## 5.4 CALIBRATION

After referring to the following preliminary data, perform calibration, as necessary, per table 5-1. If performing partial

calibration, check previous settings and adjustments for applicability.

1. Unless otherwise noted, all measurements made at the 50Ω OUT connector should be terminated into a 50Ω (±0.1%) load.
2. Test Points (TPs) and adjustments are on the main board unless noted otherwise.
3. Before connecting the unit to an ac source, check the ac line circuit to make sure the 115/230 and HI/LO switches are set at the correct position (see paragraph 2.2).
4. Start the calibration by setting the front panel switches as follows:
 

FREQ Range . . . . .	X 10K
Frequency Dial . . . . .	5
FREQ VERNIER . . . . .	CAL
SYMMETRY . . . . .	NORMAL
GEN MODE . . . . .	CONT
WAVEFORM . . . . .	⏏ (No Offset)
AMPLITUDE . . . . .	0
AMPLITUDE VARIABLE . . . . .	Max cw
SWEEP MODE . . . . .	SWEEP START
SWEEP TIME . . . . .	100s
5. Allow the unit to warm up at least 30 minutes for final calibration.

Table 5-1. Calibration Chart

Step	Check	Tester	Cal Points	Control Settings	Adjust	Desired Results	Remarks
1	Power Supply Regulators	Voltmeter	C84 (+)	—	R206	+15 Vdc ±50 mV	Ground is C84 (—).
2			C88 (—)			—15 Vdc ±150 mV	
3			C80 (+)			+5V ±250 mV	

Cover the instrument and allow a 30 minute warm-up. Keep covered as much as possible during calibration.



Table 5-1. Calibration Chart (Continued)

Step	Check	Tester	Cal Points	Control Settings	Adjust	Desired Results	Remarks
4	Amplifier Offset	Voltmeter	Q19 emitter	GEN MODE: TRIG WAVEFORM: $\sim$	R192	0V $\pm$ 5 mV	$\sim$ amplifier output.
5			50 $\Omega$ OUT		R124	0V $\pm$ 10mV	
6				AMPLITUDE VARIABLE: max ccw	R156		Repeat steps 5 and 6
7	Time Symmetry			Dual channel scope	GEN MODE: CONT WAVEFORM: $\sqcap$ FREQ: X 1K Dial: 5 Scope time base: 20 $\mu$ s/div	R32	Time symmetry < 0.1%
8				FREQ: X 100K Dial: .05	R35		Follow procedure in figure 5-1.
9							Repeat steps 6 and 7
10	VCG Zero			Same as for step 7	R13	Minimum frequency shift while shorting and opening VCG IN BNC to ground	
11	Sine Distortion	Distortion analyzer (with 50 $\Omega$ termination)		FREQ: X 1K VERNIER: CAL Dial: 5 WAVEFORM: $\sim$	R68, R71	Distortion < 0.16%	If minimum distortion cannot be met, refer to table 6-1.
12			Dial: 1			Distortion < 0.2%	If adjustment was necessary, repeat step 10.
13			FREQ: X 10K				
14	High Freq Sine Distortion			FREQ: X 1M Dial: 1 WAVEFORM: $\sqcap$	C64	Minimum rise time with minimum overshoot	
15		Spectrum analyzer		WAVEFORM: $\sim$	None	All harmonics below -32 dB from 1 to 5 MHz	If not, refer to table 6-1.
16	Frequency	Counter		WAVEFORM: $\sqcap$ FREQ: X 10K Dial: 5	R21	50 kHz $\pm$ 100 Hz	

Table 5-1. Calibration Chart (Continued)

Step	Check	Tester	Cal Points	Control Settings	Adjust	Desired Results	Remarks	
17	Frequency	Counter	50Ω OUT	FREQ: X 1M	C22	5 MHz ±20 kHz	Repeat steps 15 and 16.	
18				FREQ: X 100K	C17	500 ±1 kHz		Change C16 if necessary
19				FREQ: X 100	None	500 ±10 Hz		
20				FREQ: X 1K		5 kHz ±100 Hz		
21				FREQ: X 10K		50 ±1 kHz		
22	Time Symmetry	Dual channel scope		FREQ: X 10 Scope time base: 0.1s/div	R92	Time symmetry < 0.1%	Follow procedure in figure 5-1.	
23	Frequency	Counter	50Ω OUT	Dial: 5	R88	50 ±0.1 Hz or 20 ms ±40 μs	Change R87 if necessary.	
24				FREQ: X .001	None	5 MHz ± 0.3 mHz 189s to 217s.		
25				FREQ: X .01		.05 Hz ± 1 mHz or 20s ± 400ms		
26				FREQ: X .1		0.5 Hz ± 10mHz or 2s ± 40ms		
27				FREQ: X 1		5 Hz ± 100mHz or 0.2s ± 4ms		
28				FREQ: X 1K Dial: 5, 4, 3, 2, 1, .5		Dialed Freq ±100 Hz		
29				FREQ: X 1M Dial: .5, 1, 2, 3, 4, 5		Dialed Freq ± 100kHz		

Remove the four screws attaching the main board to the long standoffs. Put the bottom cover on, but do not insert the screws. Place the instrument on its feet and carefully remove the top cover.

30	Sweep	Oscilloscope	SWP OUT	SWEEP MODE: CONT SWEEP			With SWEEP TIME, set SWP OUT to near 100 Hz. Alternate SWEEP MODE between CONT SWEEP and SWEEP STOP while performing step 31.
----	-------	--------------	---------	---------------------------	--	--	---

Table 5-1 Calibration Chart (Continued)

Step	Check	Tester	Cal Points	Control Settings	Adjust	Desired Results	Remarks
31	Sweep	Oscilloscope	SWP OUT	SWEEP MODE: CONT SWEEP	Sweep board R12	CONT SWEEP amplitude = SWEEP STOP amplitude $\pm 10$ mV	
32	XCG	Counter	50 $\Omega$ OUT	FREQ: X 100K Frequency dial: 4 GEN MODE: XCG	XCG board Variable capacitor	400 kHz $\pm 5$ Hz	XCG lamp must be on.
33						XCG lamp lights & frequency locks near every mark on dial	

1. ADJUST OSCILLOSCOPE.

TRIGGER: INTERNAL AND ALTERNATE  
CHANNEL A: NORMAL  
CHANNEL B: INVERTED

2. ADJUST FREQUENCY DIAL/VERNIER FOR ONE CYCLE ON SCOPE.

3. SWITCH X 10 SWEEP MAGNIFIER ON.

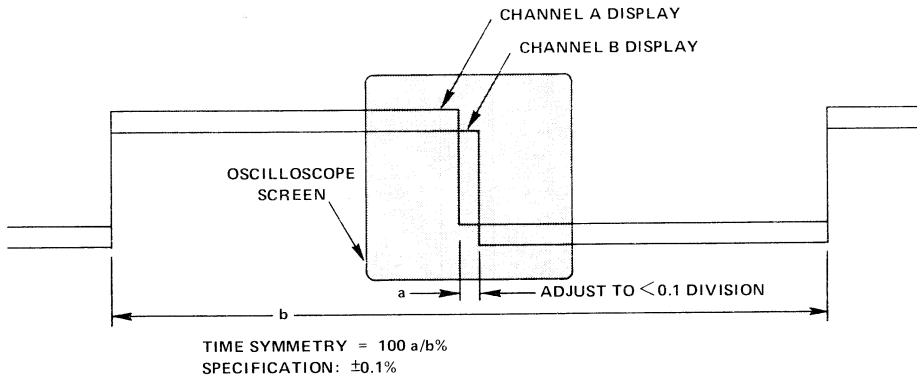
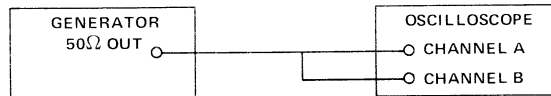

Figure 5-1. Time Symmetry Measurement

# SECTION 6

## TROUBLESHOOTING

### 6.1 INTRODUCTION

This section is organized as follows:

- Circuit Board Access
- Basic Techniques
- Troubleshooting Individual Components
- Troubleshooting Guide

(Refer to paragraph 5.2 for required test equipment.)

#### NOTE

*Wavetek maintains a factory repair department for those customers not possessing the necessary personnel or test equipment to maintain the instrument. If an instrument is returned to the factory for calibration or repair, a detailed description of the specific problem should be attached to minimize turnaround time.*

### 6.2 CIRCUIT BOARD ACCESS

Turn the instrument over, remove the four screws in the bottom cover and remove the bottom cover. For sweep board and XCG board access, remove the four screws holding the main board to its long standoffs, place the instrument right side up and carefully remove the top cover.

### 6.3 BASIC TECHNIQUES

Troubleshooting requires no special technique. Listed below are a few reminders of basic electronic fault isolation.

1. Check control settings carefully. Many times a seemingly malfunction is an incorrect control setting, or a knob that has loosened on its shaft.
2. Check associated equipment connections. Make sure that all connections are securely connected to the correct connector.
3. Perform the calibration procedure. Many out-of-specification indications can be corrected by performing specific calibration procedures.

4. Visually check the interior of the instrument. Look for such indications as broken wires, charred components, and loose leads.

### 6.4 TROUBLESHOOTING INDIVIDUAL COMPONENTS

#### 6.4.1 Transistor

A transistor is defective if more than one volt is measured across its base emitter junction in the forward direction.

A transistor when used as a switch may have a few volts reverse bias voltage.

If the collector and emitter voltages are the same, but the base emitter voltage is less than 500 mV forward voltage (or reversed bias), the transistor is defective.

A transistor is defective if its base current is larger than 10% of its emitter current (calculate currents from voltage across the base and emitter series resistors).

#### 6.4.2 Diode

A diode is defective if there is greater than 1 volt (typically 0.7 volt) forward voltage across it (except Zener and LED).

#### 6.4.3 Operational Amplifier

The "+" and "-" inputs of an operational amplifier will have less than 15 mV voltage difference when operating under normal conditions.

If the output voltage stays at maximum positive, its "+" input voltage should be more positive than its "-" input voltage, or vice versa; otherwise, the operational amplifier is defective.

#### 6.4.4 FET Transistor

No gate current should be drawn by the gate of an FET transistor. If so, the transistor is defective.

The gate-to-source voltage is always reverse biased under a normal operating condition; e.g., the source voltage is more positive than the gate voltage for 2N5485, and the source

voltage is more negative than gate voltage for a 2N5462. Otherwise, the FET is defective.

#### 6.4.5 Capacitor

Shorted capacitors have zero volts across their terminals.

Opened capacitor can be located (but not always) by using a good capacitor connected in parallel with the capacitor under test and observing the resulting effect.

## 6.5 TROUBLESHOOTING GUIDE

Table 6-1 provides a list of possible malfunction symptoms, their probable causes, and the prescribed remedies. Localize the fault to a specific stage by checking the parameters given for the test points. Then check the dc operating voltages at the pins of solid-state devices. Check associated passive elements with a high input impedance ohmmeter (power off) before replacing a suspected semiconductor element.

Table 6-1. Troubleshooting Guide

Symptom	Corrective Procedures
<b>POWER SUPPLY PROBLEM</b>	
Blown fuse	<ol style="list-style-type: none"> <li>1. Check that the HI/LO and 115/230 switches at the rear panel are set correctly. (Refer to paragraph 2.2.)</li> <li>2. Replace fuse; if fuse blows again, refer to the following steps.</li> <li>3. Examine circuit boards and wiring for source of short circuit.</li> <li>4. Use an ohmmeter to detect possible short circuits between power supply and ground and between individual power supplies.</li> <li>5. Isolate each part of the circuit by unplugging the sweep board and unsoldering the jumpers along the power supply path. Plug in the sweep board and replace the jumpers one-by-one to isolate the overloading circuit. Frequently, a shorted capacitor is the problem.</li> </ol>
±15V supply voltage below normal	Isolate the power supply from most of the generator circuits by unsoldering the two jumpers near the "+" end of C81 on the main circuit board. If supply voltage returns to normal, there is an extra loading current from a generator circuit; otherwise, troubleshoot the power supply circuitry.
±15V supply voltage above normal	Power supply circuit malfunction.
+5V regulator voltage abnormal	Isolate the regulator from generator circuits by unsoldering any leads at E15, E16 and E17. If regulator voltage returns to normal, there is an extra loading current from a generator circuit; otherwise, the trouble is in the regulator. Replace IC10.
Index (lighted indicator) on front panel abnormally bright or dim	HI/LO switch at the rear panel is not set correctly. (Refer to paragraph 2.2.)
<b>OUTPUT WAVEFORM PROBLEM</b>	
No output waveform at 50Ω OUT and PULSE OUT (GEN MODE at CONT)	<ol style="list-style-type: none"> <li>1. Ensure power supply voltages are normal.</li> <li>2. Temporarily remove Q44 on main board. If generator runs, problem is in the trigger and gate logic circuit. Otherwise, trouble is in the generator loop.</li> </ol>

Table 6-1. Troubleshooting Guide (Continued)

Symptom	Corrective Procedures
No output waveform at 50Ω OUT, but PULSE OUT normal, or all waveforms greatly distorted	Set the AMPLITUDE VARIABLE full ccw and set WAVEFORM to DC. If the output voltage at 50Ω OUT can be adjusted to ±10V into open circuit with the DC OFFSET control, the problem is in the preamplifier; otherwise, check the output amplifier.
Both waveform amplitude and frequency jittering	<ol style="list-style-type: none"> <li>1. Power supply out of regulation due to ac line voltage being too low. Check line voltage. Make sure the HI/LO switch setting on rear panel is correct. (Refer to paragraph 2.2.)</li> <li>2. Power supply malfunction. (Refer to Power Supply Problem.)</li> </ol>
Distorted sine and square waveforms, but triangle waveform normal	<p>Sine converter and square shaper malfunction. Check for defective diode.</p> <p style="text-align: center;"><i>NOTE</i></p> <p style="text-align: center;"><i>If a diode is bad, the entire set of eight diodes should be replaced with a new matched set, or select a diode that gives minimum sine distortion at 1 kHz.</i></p>
Half of sine and square waveforms missing	<ol style="list-style-type: none"> <li>1. Defective diodes CR17 or CR21.</li> <li>2. Defective switch wafer or loose contact of SW3-A and SW3-B.</li> </ol>
Distorted triangle and sine waveforms at one particular frequency range	<ol style="list-style-type: none"> <li>1. Check for defective timing capacitor of the range (C15 thru C23).</li> <li>2. Check C8 thru C10, C13, C25 and C94, if distortion shown at X 1 MHz range.</li> </ol>
Distorted waveform or generator not running when X .001 Hz thru X 10 Hz selected	Capacitance multiplier malfunction.
Sine distortion out of specification at frequency below 500 kHz	<ol style="list-style-type: none"> <li>1. Square wave time symmetry is not calibrated correctly.</li> <li>2. Defective component in sine converter and square shaper.</li> </ol> <p style="text-align: center;"><i>NOTE</i></p> <p style="text-align: center;"><i>If a diode is bad, the entire set of eight diodes should be replaced with a new matched set, or select a diode that gives minimum sine distortion at 1 kHz.</i></p> <ol style="list-style-type: none"> <li>3. Resistor R109, R111, R112 or R114 is out of tolerance. Connect 10 kΩ trim potentiometers in locations marked R111 and R112. Adjust the two trim potentiometers and also R68 and R71 to obtain less than 0.16% distortion. Remove the potentiometers, measure the resistance and replace with standard 1/8W resistors. If 0.16% distortion still cannot be achieved, remove both R110 and R113 and connect a 500Ω trim potentiometer in each location. Adjust the two trim potentiometers R68 and R71 for less than 0.16% distortion. Replace potentiometers with standard 1/8W resistors.</li> <li>4. If sine distortion is OK at 1 kHz, but out of specification at 10 kHz, check for defective C31, C32, C38, Q6 and Q14.</li> </ol>

Table 6-1. Troubleshooting Guide (Continued)

Symptom	Corrective Procedures
Sine distortion out of specification at frequency greater than 500 kHz	<ol style="list-style-type: none"> <li>1. Check square wave for slow rise/fall time. If so, check for defective capacitor in the pre-amplifier and output amplifier.</li> <li>2. Frequency dial accuracy and sine distortion problems at X 1M range are due to the excess peaking or roll-off of the triangle waveform. Capacitors C28 and C35, also C29 and C34, need to be selected for maximum flatness of the triangle peak voltages at emitter of Q19. To check the flatness of the triangle peak voltage, a high frequency oscilloscope and a X 10 scope probe (&gt; 150 MHz bandwidth) should be used. The oscilloscope probe should be correctly compensated and its ground lead length should keep to minimum.</li> <li>3. If triangle is distorted, check for defective capacitors C8 thru C10, C13, C25 and C94.</li> <li>4. Check for defective diodes CR 10 or CR 11.</li> </ol>

TIME SYMMETRY PROBLEM

Positive slope of triangle remains constant when frequency dial varied	<ol style="list-style-type: none"> <li>1. Defective Q5, Q6, C9, IC3 and associated circuitry.</li> <li>2. Defective Q9 thru Q12 and CR6 thru CR9.</li> </ol>
Negative slope of triangle remains constant when frequency dial varied	<ol style="list-style-type: none"> <li>1. Defective IC3 and associated circuitry.</li> <li>2. Defective Q9 thru Q12 and CR6 thru CR9.</li> </ol>
Symmetry cannot be adjusted to specification	Defective Q6, Q14, R33, R34, R40 and R41.
Symmetry worse at low frequency end of dial	Check for high leakage components Q6, Q9 thru Q12 and Q14.
Symmetry out of specification at X 10 frequency range or below	Defective IC6 and associated circuitry.

FREQUENCY ACCURACY PROBLEM

Frequency accuracy out of specification at X 1 kHz range	<ol style="list-style-type: none"> <li>1. Mismatched dial and potentiometer, if frequency is out of specification at the same portion of the dial in every range. Ensure that the number on the back of the dial matches the number on the potentiometer.</li> <li>2. Defective dial potentiometer.</li> <li>3. VCG amplifier (IC2) or current source (IC3) is saturated when frequency dial is set to the top (5.0). Check for defective Q1, Q6, IC2 and associated circuitry.</li> </ol>
Frequency accuracy out of specification at X 10K and X 100 kHz ranges	Check for defective C30 thru C33, C38 and R61 thru R66.
Frequency accuracy out of specification at X 1 MHz range	Check for defective C25, C28, C29, C34, C35, R60, R67, CR 10 and CR 11.

Table 6-1. Troubleshooting Guide (Continued)

Symptom	Corrective Procedures
Frequency accuracy out of specification at X .001 to X 10 Hz ranges	<ol style="list-style-type: none"> <li>1. R90 and R94 thru R96 are mismatched. Defective R97.</li> <li>2. Defective IC5, IC6 and associated circuitry.</li> <li>3. If triangle is distorted when dial is set to the top (5.0), defective regulator Q22 and Q23.</li> </ol>
MODE OF OPERATION PROBLEM	
Output not in agreement with GEN MODE switch setting	Trigger and gate logic circuit or IC8 malfunction.
Generator running in trigger or gated mode	If voltage at pin 11 of IC8 is 0 to 0.4V (logic zero) when TRIG mode is selected, the problem is in the trigger amplifier (Q42 thru Q45). Otherwise, troubleshoot IC8, IC9 and associated circuitry.
Generator can be triggered by operating MAN TRIG switch, but not by external signal	Squaring circuit malfunction.
FREQUENCY SWEEP PROBLEM (All components on sweep board)	
Generator frequency not sweeping; no ramp signal at SWP OUT (GEN MODE at SWEEP, SWEEP MODE at CONT SWEEP)	<ol style="list-style-type: none"> <li>1. If IC1 pins 2 and 3 do not have same voltage level, the buffer amplifier (IC1 and Q6) is bad.</li> <li>2. Comparator flip-flop (Q7 thru Q10) is bad.</li> <li>3. Log current source (Q3 thru Q5) is bad.</li> </ol>



