



AO4609

Complementary Enhancement Mode Field Effect Transistor

General Description

The AO4609 uses advanced trench technology MOSFETs to provide excellent $R_{DS(ON)}$ and low gate charge. The complementary MOSFETs may be used to form a level shifted high side switch, and for a host of other applications.

Features

n-channel	p-channel
$V_{DS} (V) = 30V$	-30V
$I_D = 8.5A$	-3A
$R_{DS(ON)}$	$R_{DS(ON)}$
< 18m Ω ($V_{GS}=10V$)	< 130m Ω ($V_{GS} = 10V$)
< 28m Ω ($V_{GS}=4.5V$)	< 180m Ω ($V_{GS} = 4.5V$)
	< 260m Ω ($V_{GS} = 2.5V$)

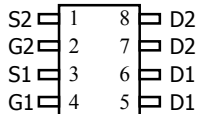

SOIC-8

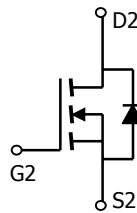

n-channel

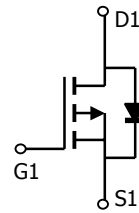

p-channel

Absolute Maximum Ratings $T_A=25^\circ C$ unless otherwise noted

Parameter	Symbol	Max n-channel	Max p-channel	Units
Drain-Source Voltage	V_{DS}	30	-30	V
Gate-Source Voltage	V_{GS}	± 20	± 12	V
Continuous Drain Current ^A	$T_A=25^\circ C$	8.5	-3	A
	$T_A=70^\circ C$	6.6	-2.4	
Pulsed Drain Current ^B	I_{DM}	40	-6	
Power Dissipation	$T_A=25^\circ C$	2	2	W
	$T_A=70^\circ C$	1.28	1.28	
Junction and Storage Temperature Range	T_J, T_{STG}	-55 to 150	-55 to 150	$^\circ C$

Thermal Characteristics: n-channel and p-channel

Parameter	Symbol	Device	Typ	Max	Units
Maximum Junction-to-Ambient ^A	$R_{\theta JA}$	n-ch	48	62.5	$^\circ C/W$
Maximum Junction-to-Ambient ^A		n-ch	74	110	$^\circ C/W$
Maximum Junction-to-Lead ^C	$R_{\theta JL}$	n-ch	35	40	$^\circ C/W$
Maximum Junction-to-Ambient ^A	$R_{\theta JA}$	p-ch	56	62.5	$^\circ C/W$
Maximum Junction-to-Ambient ^A		p-ch	81	110	$^\circ C/W$
Maximum Junction-to-Lead ^C	$R_{\theta JL}$	p-ch	40	48	$^\circ C/W$

N-Channel Electrical Characteristics ($T_J=25^\circ\text{C}$ unless otherwise noted)

Symbol	Parameter	Conditions	Min	Typ	Max	Units
STATIC PARAMETERS						
BV_{DSS}	Drain-Source Breakdown Voltage	$I_D=250\mu\text{A}$, $V_{GS}=0\text{V}$	30			V
I_{DSS}	Zero Gate Voltage Drain Current	$V_{DS}=24\text{V}$, $V_{GS}=0\text{V}$ $T_J=55^\circ\text{C}$			1	μA
					5	
I_{GSS}	Gate-Body leakage current	$V_{DS}=0\text{V}$, $V_{GS}=\pm 20\text{V}$			100	nA
$V_{GS(th)}$	Gate Threshold Voltage	$V_{DS}=V_{GS}$, $I_D=250\mu\text{A}$	1	1.8	3	V
$I_{D(ON)}$	On state drain current	$V_{GS}=10\text{V}$, $V_{DS}=5\text{V}$	30			A
$R_{DS(ON)}$	Static Drain-Source On-Resistance	$V_{GS}=10\text{V}$, $I_D=8.5\text{A}$ $T_J=125^\circ\text{C}$		15.5	18	m Ω
				22.3	27	
		$V_{GS}=4.5\text{V}$, $I_D=6\text{A}$		23	28	m Ω
g_{FS}	Forward Transconductance	$V_{DS}=5\text{V}$, $I_D=8.5\text{A}$		23		S
V_{SD}	Diode Forward Voltage	$I_S=1\text{A}$, $V_{GS}=0\text{V}$		0.75	1	V
I_S	Maximum Body-Diode Continuous Current				3	A
DYNAMIC PARAMETERS						
C_{iss}	Input Capacitance	$V_{GS}=0\text{V}$, $V_{DS}=15\text{V}$, $f=1\text{MHz}$		1040		pF
C_{oss}	Output Capacitance			180		pF
C_{rss}	Reverse Transfer Capacitance			110		pF
R_g	Gate resistance	$V_{GS}=0\text{V}$, $V_{DS}=0\text{V}$, $f=1\text{MHz}$		0.7		Ω
SWITCHING PARAMETERS						
$Q_g(10\text{V})$	Total Gate Charge	$V_{GS}=10\text{V}$, $V_{DS}=15\text{V}$, $I_D=8.5\text{A}$		19.2		nC
$Q_g(4.5\text{V})$	Total Gate Charge			9.36		nC
Q_{gs}	Gate Source Charge			2.6		nC
Q_{gd}	Gate Drain Charge			4.2		nC
$t_{D(on)}$	Turn-On DelayTime	$V_{GS}=10\text{V}$, $V_{DS}=15\text{V}$, $R_L=1.8\Omega$, $R_{GEN}=3\Omega$		5.2		ns
t_r	Turn-On Rise Time			4.4		ns
$t_{D(off)}$	Turn-Off DelayTime			17.3		ns
t_f	Turn-Off Fall Time			3.3		ns
t_{rr}	Body Diode Reverse Recovery Time	$I_F=8.5\text{A}$, $dI/dt=100\text{A}/\mu\text{s}$		16.7		ns
Q_{rr}	Body Diode Reverse Recovery Charge	$I_F=8.5\text{A}$, $dI/dt=100\text{A}/\mu\text{s}$		6.7		nC

A: The value of $R_{\theta JA}$ is measured with the device mounted on 1 in² FR-4 board with 2oz. Copper, in a still air environment with $T_A=25^\circ\text{C}$. The value in any a given application depends on the user's specific board design. The current rating is based on the $t \leq 10\text{s}$ thermal resistance rating.

B: Repetitive rating, pulse width limited by junction temperature.

C. The $R_{\theta JA}$ is the sum of the thermal impedance from junction to lead $R_{\theta JL}$ and lead to ambient.

D. The static characteristics in Figures 1 to 6 are obtained using 80 μs pulses, duty cycle 0.5% max.

E. These tests are performed with the device mounted on 1 in² FR-4 board with 2oz. Copper, in a still air environment with $T_A=25^\circ\text{C}$. The SOA curve provides a single pulse rating.

P-Channel Electrical Characteristics ($T_J=25^\circ\text{C}$ unless otherwise noted)

Symbol	Parameter	Conditions	Min	Typ	Max	Units
STATIC PARAMETERS						
BV_{DSS}	Drain-Source Breakdown Voltage	$I_D=-250\mu\text{A}$, $V_{GS}=0\text{V}$	-30			V
I_{DSS}	Zero Gate Voltage Drain Current	$V_{DS}=-24\text{V}$, $V_{GS}=0\text{V}$ $T_J=55^\circ\text{C}$			-1 -5	μA
I_{GSS}	Gate-Body leakage current	$V_{DS}=0\text{V}$, $V_{GS}=\pm 12\text{V}$			± 100	nA
$V_{GS(th)}$	Gate Threshold Voltage	$V_{DS}=V_{GS}$, $I_D=-250\mu\text{A}$	-0.6	-1	-1.4	V
$I_{D(ON)}$	On state drain current	$V_{GS}=-4.5\text{V}$, $V_{DS}=-5\text{V}$	-10			A
$R_{DS(ON)}$	Static Drain-Source On-Resistance	$V_{GS}=-10\text{V}$, $I_D=-3\text{A}$ $T_J=125^\circ\text{C}$		102 154	130 200	$\text{m}\Omega$
		$V_{GS}=-4.5\text{V}$, $I_D=-2\text{A}$		128	180	$\text{m}\Omega$
		$V_{GS}=-2.5\text{V}$, $I_D=-1\text{A}$		187	260	$\text{m}\Omega$
g_{FS}	Forward Transconductance	$V_{DS}=-5\text{V}$, $I_D=-3\text{A}$	3	4.5		S
V_{SD}	Diode Forward Voltage	$I_S=-1\text{A}$, $V_{GS}=0\text{V}$		-0.85	-1	V
I_S	Maximum Body-Diode Continuous Current				-2	A
DYNAMIC PARAMETERS						
C_{iss}	Input Capacitance	$V_{GS}=0\text{V}$, $V_{DS}=-15\text{V}$, $f=1\text{MHz}$		409		pF
C_{oss}	Output Capacitance			55		pF
C_{rSS}	Reverse Transfer Capacitance			42		pF
R_g	Gate resistance	$V_{GS}=0\text{V}$, $V_{DS}=0\text{V}$, $f=1\text{MHz}$		12		Ω
SWITCHING PARAMETERS						
Q_g	Total Gate Charge	$V_{GS}=-4.5\text{V}$, $V_{DS}=-15\text{V}$, $I_D=-3\text{A}$		4.4		nC
Q_{gs}	Gate Source Charge			0.8		nC
Q_{gd}	Gate Drain Charge			1.32		nC
$t_{D(on)}$	Turn-On Delay Time	$V_{GS}=-10\text{V}$, $V_{DS}=-15\text{V}$, $R_L=5\Omega$, $R_{GEN}=3\Omega$		5.3		ns
t_r	Turn-On Rise Time			4.4		ns
$t_{D(off)}$	Turn-Off Delay Time			31.5		ns
t_f	Turn-Off Fall Time			8		ns
t_{rr}	Body Diode Reverse Recovery Time	$I_F=-3\text{A}$, $dI/dt=100\text{A}/\mu\text{s}$		15.8		ns
Q_{rr}	Body Diode Reverse Recovery Charge	$I_F=-3\text{A}$, $dI/dt=100\text{A}/\mu\text{s}$		8		nC

A: The value of $R_{\theta JA}$ is measured with the device mounted on 1in² FR-4 board with 2oz. Copper, in a still air environment with $T_A=25^\circ\text{C}$. The value in any a given application depends on the user's specific board design. The current rating is based on the $t \leq 10\text{s}$ thermal resistance rating.

B: Repetitive rating, pulse width limited by junction temperature.

C: The $R_{\theta JA}$ is the sum of the thermal impedance from junction to lead $R_{\theta JL}$ and lead to ambient.

D: The static characteristics in Figures 1 to 6, 12, 14 are obtained using 80 μs pulses, duty cycle 0.5% max.

E: These tests are performed with the device mounted on 1 in² FR-4 board with 2oz. Copper, in a still air environment with $T_A=25^\circ\text{C}$. The SOA curve provides a single pulse rating.

N-CHANNEL: TYPICAL ELECTRICAL AND THERMAL CHARACTERISTICS

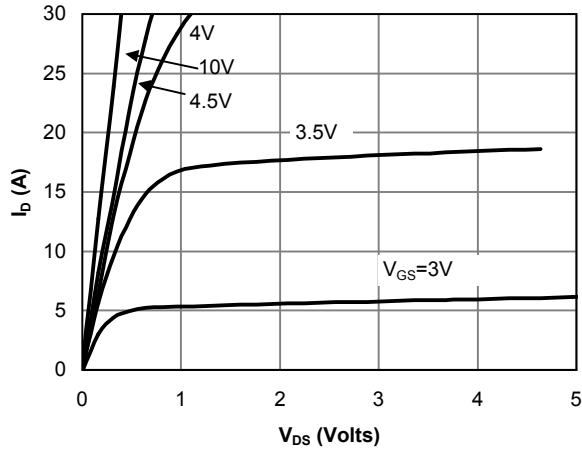

Fig 1: On-Region Characteristics

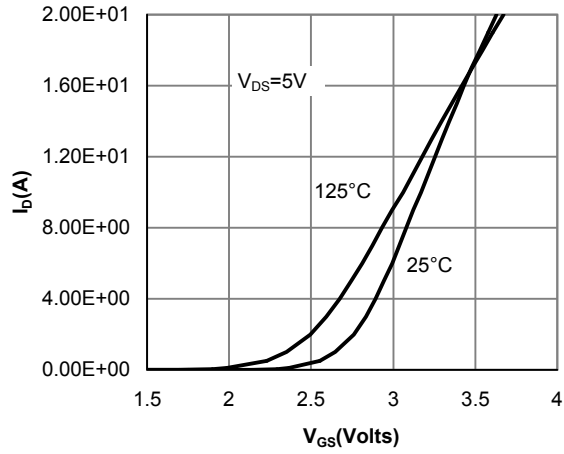

Figure 2: Transfer Characteristics

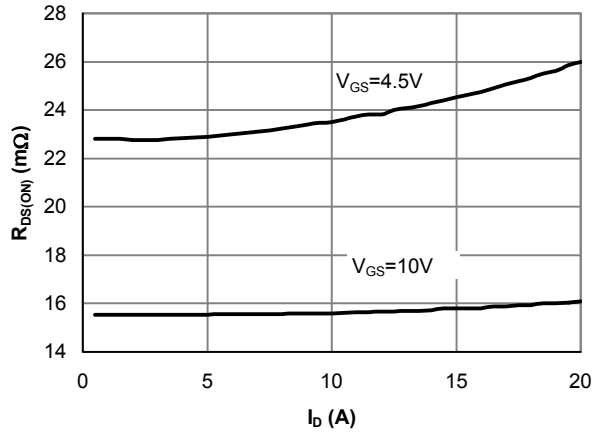

Figure 3: On-Resistance vs. Drain Current and Gate Voltage

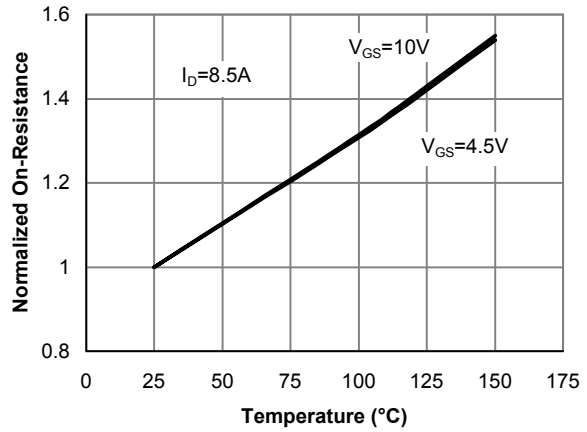

Figure 4: On-Resistance vs. Junction Temperature

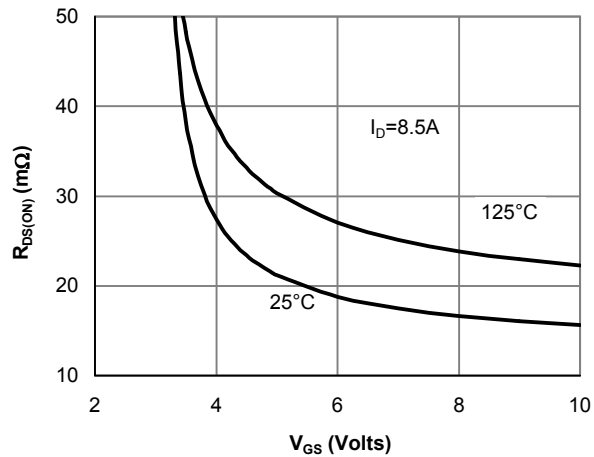

Figure 5: On-Resistance vs. Gate-Source Voltage

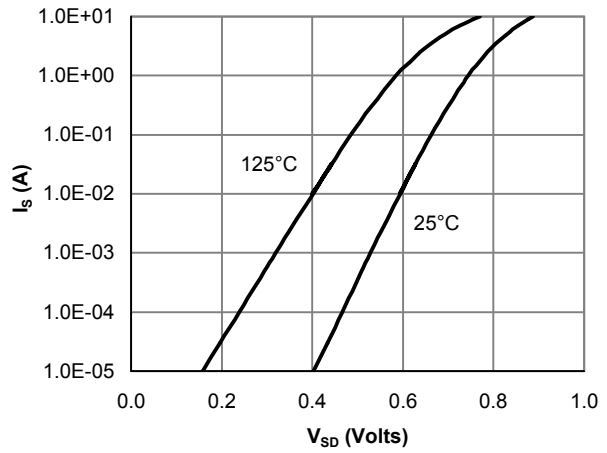

Figure 6: Body-Diode Characteristics

N-CHANNEL: TYPICAL ELECTRICAL AND THERMAL CHARACTERISTICS

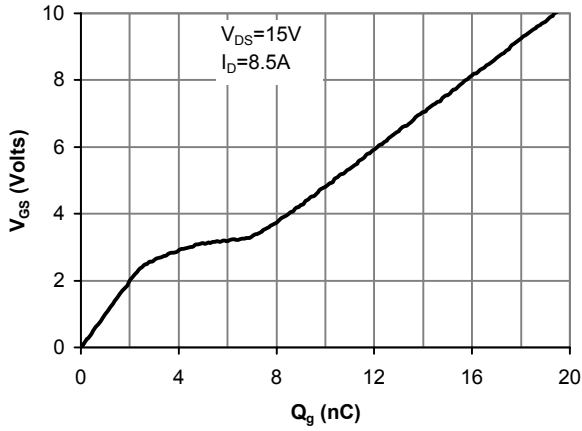

Figure 7: Gate-Charge Characteristics

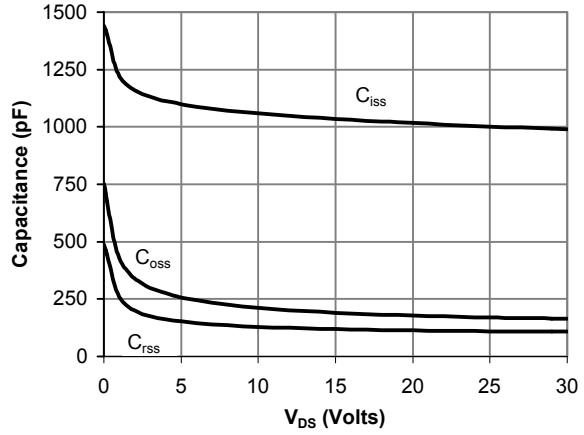

Figure 8: Capacitance Characteristics

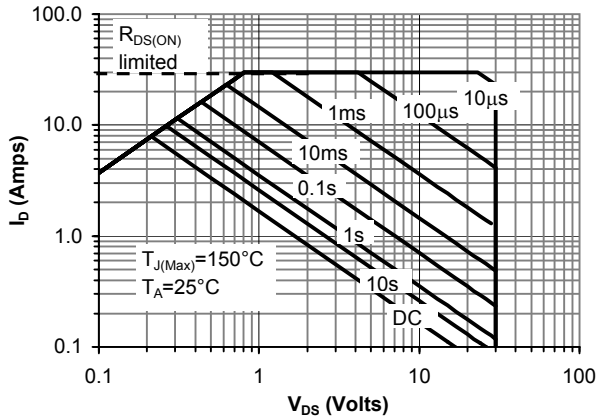

Figure 9: Maximum Forward Biased Safe Operating Area (Note E)

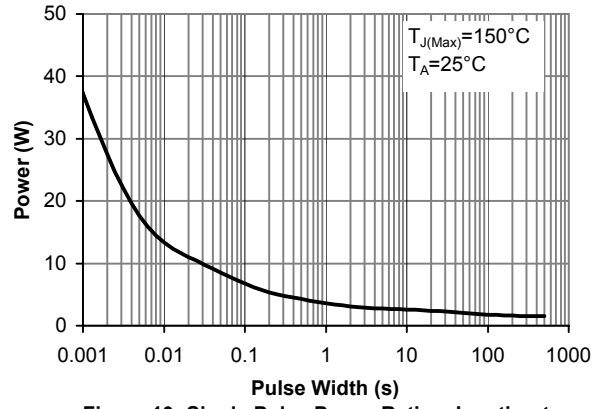

Figure 10: Single Pulse Power Rating Junction-to-Ambient (Note E)

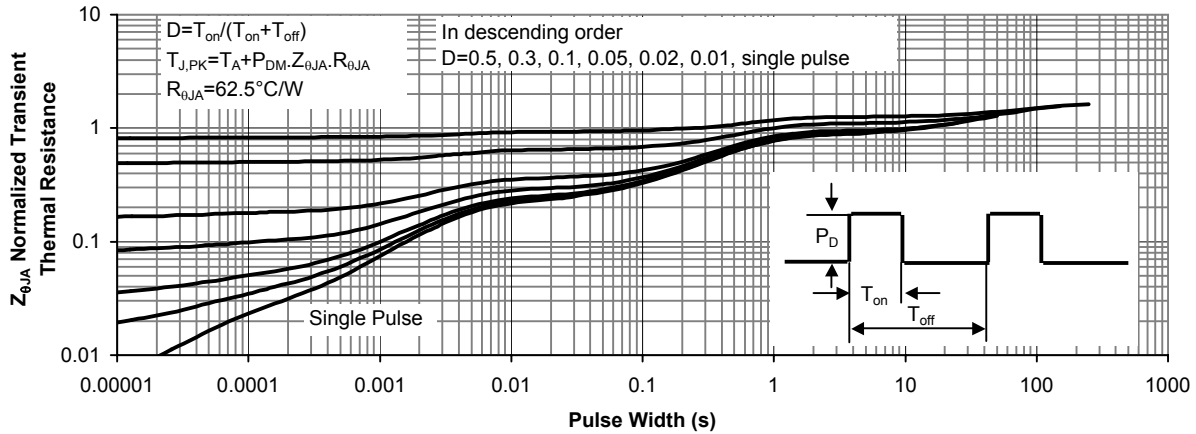

Figure 11: Normalized Maximum Transient Thermal Impedance

P-CHANNEL TYPICAL ELECTRICAL AND THERMAL CHARACTERISTICS

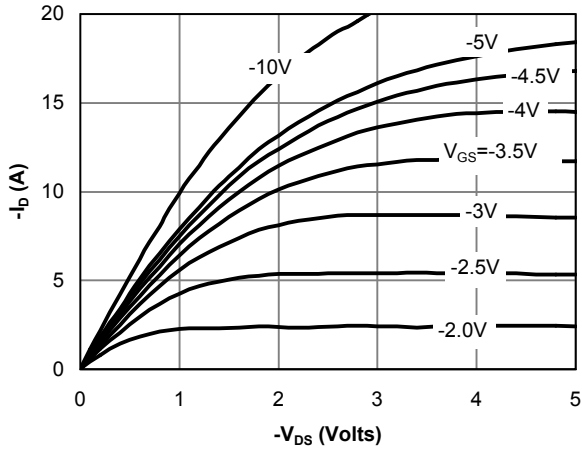

Fig 1: On-Region Characteristics

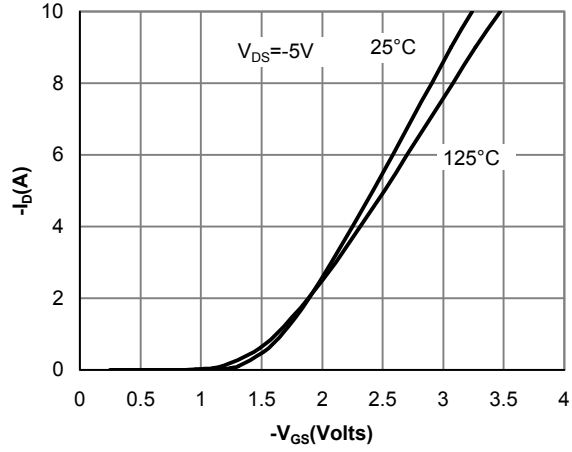

Figure 2: Transfer Characteristics

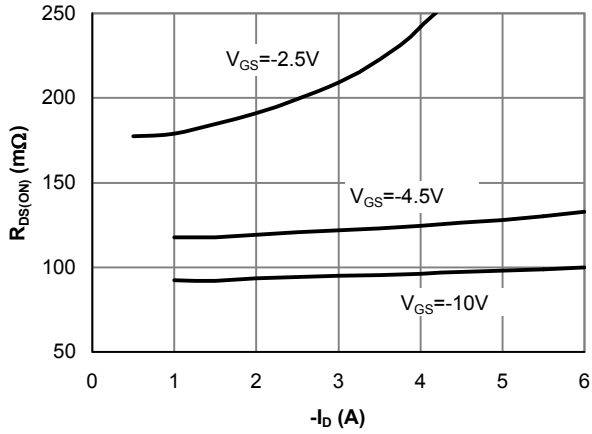

Figure 3: On-Resistance vs. Drain Current and Gate Voltage

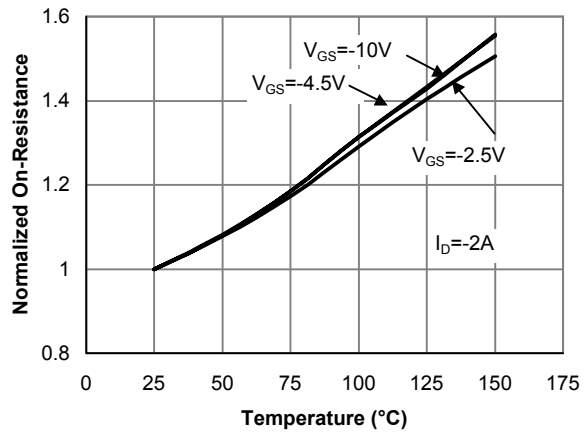

Figure 4: On-Resistance vs. Junction Temperature

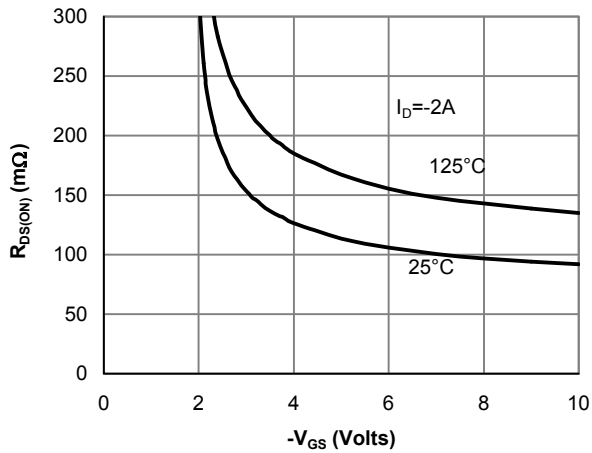

Figure 5: On-Resistance vs. Gate-Source Voltage

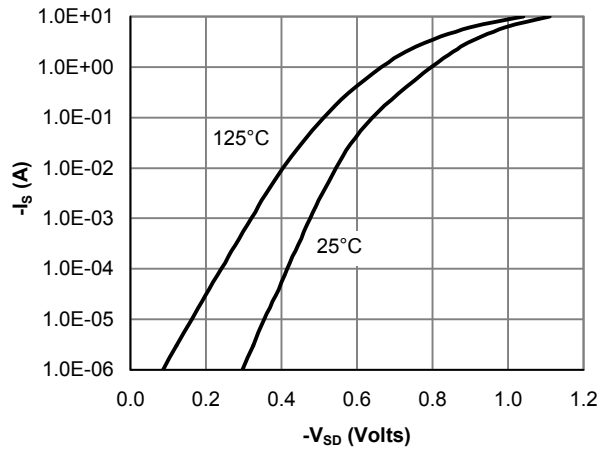

Figure 6: Body-Diode Characteristics

P-CHANNEL TYPICAL ELECTRICAL AND THERMAL CHARACTERISTICS

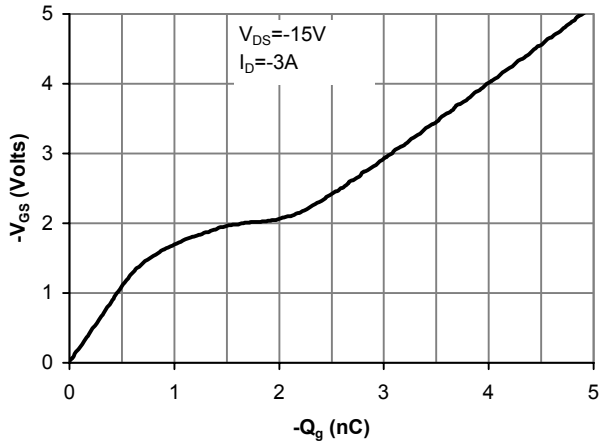

Figure 7: Gate-Charge Characteristics

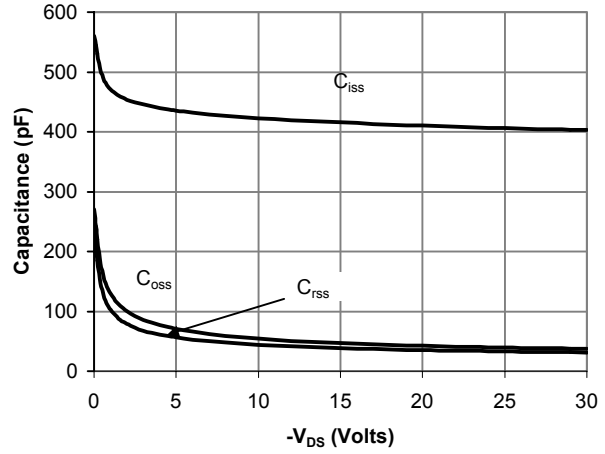

Figure 8: Capacitance Characteristics

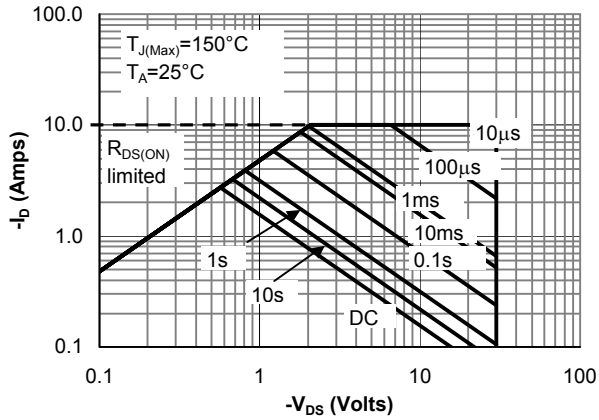

Figure 9: Maximum Forward Biased Safe Operating Area (Note E)

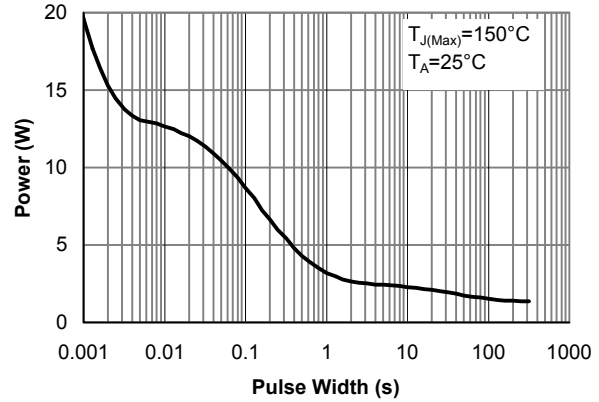

Figure 10: Single Pulse Power Rating Junction-to-Ambient (Note E)

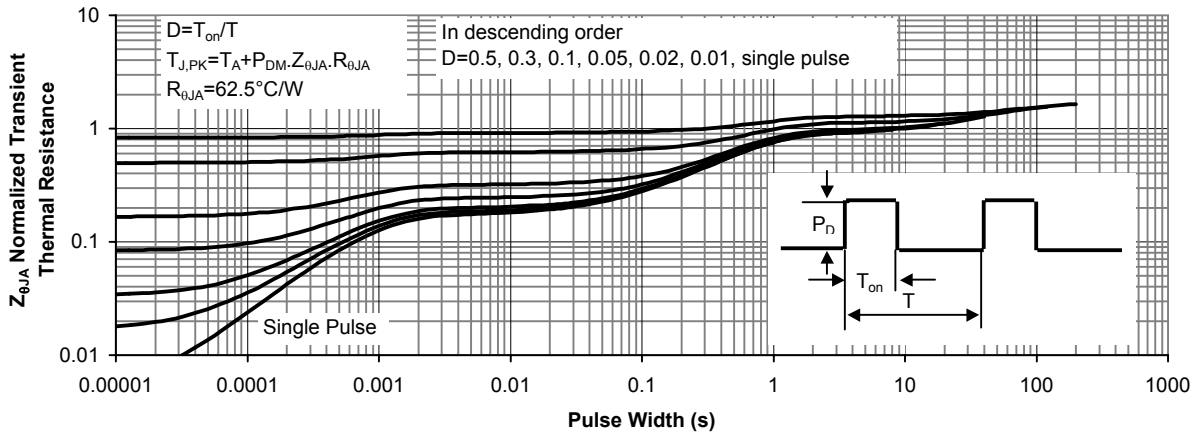
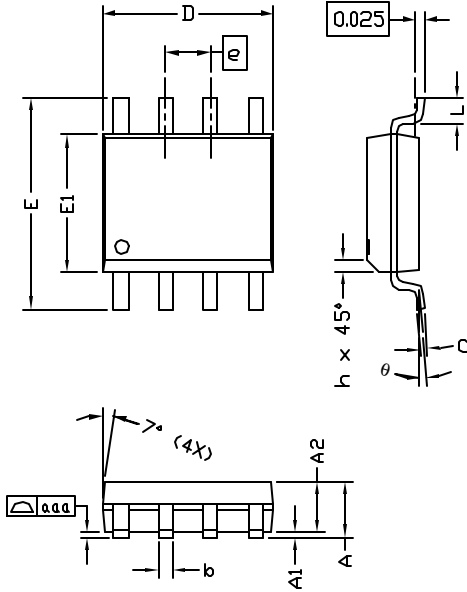

Figure 11: Normalized Maximum Transient Thermal Impedance



ALPHA & OMEGA
SEMICONDUCTOR, INC.

SO-8 Package Data



SYMBOLS	DIMENSIONS IN MILLIMETERS			DIMENSIONS IN INCHES		
	MIN	NOM	MAX	MIN	NOM	MAX
A	1.45	1.50	1.55	0.057	0.059	0.061
A1	0.00	—	0.10	0.000	—	0.004
A2	—	1.45	—	—	0.057	—
b	0.33	—	0.51	0.013	—	0.020
c	0.19	—	0.25	0.007	—	0.010
D	4.80	—	5.00	0.189	—	0.197
E1	3.80	—	4.00	0.150	—	0.157
e	1.27 BSC			0.050 BSC		
E	5.80	—	6.20	0.228	—	0.244
h	0.25	—	0.50	0.010	—	0.020
L	0.40	—	1.27	0.016	—	0.050
aaa	—	—	0.10	—	—	0.004
θ	0°	—	8°	0°	—	8°

- NOTE:
- LEAD FINISH: 150 MICRONS (3.8 μm) MIN. THICKNESS OF Tin/Lead (SOLDER) PLATED ON LEAD
 - TOLERANCE ±0.10 mm (4 mil) UNLESS OTHERWISE SPECIFIED
 - COPLANARITY : 0.10 mm
 - DIMENSION L IS MEASURED IN GAGE PLANE

PACKAGE MARKING DESCRIPTION



- NOTE:
- LOGO - AOS LOGO
 - 4609 - PART NUMBER CODE.
 - F - FAB LOCATION
 - A - ASSEMBLY LOCATION
 - Y - YEAR CODE
 - W - WEEK CODE.
 - L C - ASSEMBLY LOT CODE

SO-8 PART NO. CODE

PART NO.	CODE
AO4609	4609

RECOMMENDED LAND PATTERN

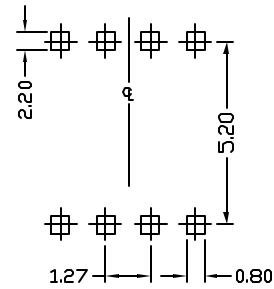

UNIT: mm



SO-8 Carrier Tape

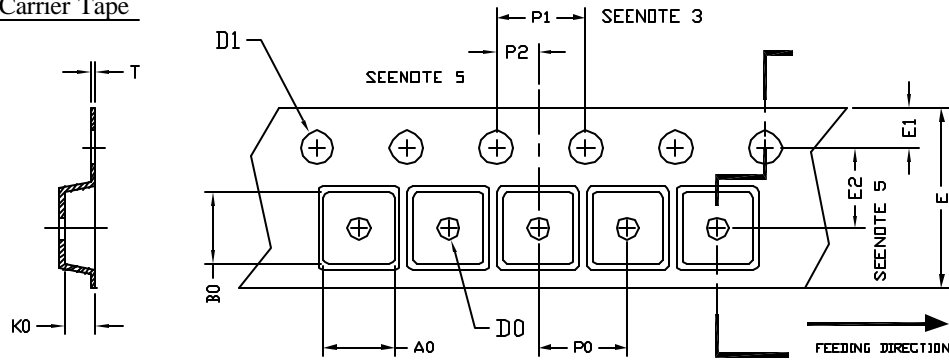

UNIT: MM

PACKAGE	A0	B0	K0	D0	D1	E	E1	E2	P0	P1	P2	T
SO-8 (12 mm)	6.40 ±0.10	5.20 ±0.10	2.10 ±0.10	1.60 ±0.10	1.30 +0.10	12.00 ±0.30	1.75 ±0.10	5.50 ±0.05	8.00 ±0.10	4.00 ±0.10	2.00 ±0.05	0.25 ±0.05

SO-8 Reel

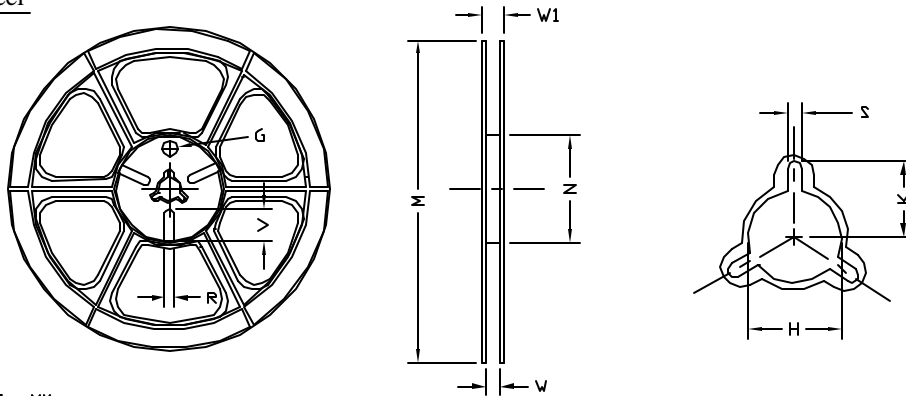

UNIT: MM

TAPE SIZE	REEL SIZE	M	N	W	W1	H	K	S	G	R	V
12 mm	φ330	φ330.00 ±0.50	φ97.00 ±0.10	13.00 ±0.30	17.40 ±1.00	φ13.00 +0.50 -0.20	10.60	2.00 ±0.50	---	---	---

SO-8 Tape

Leader / Trailer
& Orientation

