



AO4802

Dual N-Channel Enhancement Mode Field Effect Transistor

General Description

The AO4802 uses advanced trench technology to provide excellent $R_{DS(ON)}$ and low gate charge. They offer operation over a wide gate drive range from 1.8V to 12V. The two devices may be used individually, in parallel or to form a bidirectional blocking switch.

Features

- V_{DS} (V) = 30V
- I_D = 7A
- $R_{DS(ON)} < 26m\Omega$ ($V_{GS} = 10V$)
- $R_{DS(ON)} < 30m\Omega$ ($V_{GS} = 4.5V$)
- $R_{DS(ON)} < 40m\Omega$ ($V_{GS} = 2.5V$)
- $R_{DS(ON)} < 70m\Omega$ ($V_{GS} = 1.8V$)

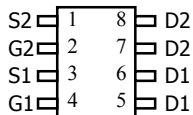

SOIC-8

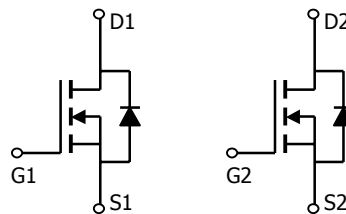

Absolute Maximum Ratings $T_A=25^\circ C$ unless otherwise noted

Parameter	Symbol	Maximum	Units
Drain-Source Voltage	V_{DS}	30	V
Gate-Source Voltage	V_{GS}	± 12	V
Continuous Drain Current ^A	$T_A=25^\circ C$	7	A
	$T_A=70^\circ C$	6	
Pulsed Drain Current ^B	I_{DM}	40	
Power Dissipation	$T_A=25^\circ C$	2	W
	$T_A=70^\circ C$	1.44	
Junction and Storage Temperature Range	T_J, T_{STG}	-55 to 150	$^\circ C$

Thermal Characteristics

Parameter	Symbol	Typ	Max	Units
Maximum Junction-to-Ambient ^A	$R_{\theta JA}$	48	62.5	$^\circ C/W$
Maximum Junction-to-Ambient ^A		Steady-State	74	110
Maximum Junction-to-Lead ^C	$R_{\theta JL}$	35	40	$^\circ C/W$

Electrical Characteristics ($T_J=25^\circ\text{C}$ unless otherwise noted)

Symbol	Parameter	Conditions	Min	Typ	Max	Units
STATIC PARAMETERS						
BV_{DSS}	Drain-Source Breakdown Voltage	$I_D=250\mu\text{A}$, $V_{GS}=0\text{V}$	30			V
I_{DSS}	Zero Gate Voltage Drain Current	$V_{DS}=24\text{V}$, $V_{GS}=0\text{V}$ $T_J=55^\circ\text{C}$			1	μA
					5	
I_{GSS}	Gate-Body leakage current	$V_{DS}=0\text{V}$, $V_{GS}=\pm 12\text{V}$			100	nA
$V_{GS(th)}$	Gate Threshold Voltage	$V_{DS}=V_{GS}$, $I_D=250\mu\text{A}$	0.6	0.8	1	V
$I_{D(ON)}$	On state drain current	$V_{GS}=4.5\text{V}$, $V_{DS}=5\text{V}$	30			A
$R_{DS(ON)}$	Static Drain-Source On-Resistance	$V_{GS}=10\text{V}$, $I_D=7\text{A}$ $T_J=125^\circ\text{C}$		22	26	m Ω
				28	36	
		$V_{GS}=4.5\text{V}$, $I_D=6\text{A}$ $V_{GS}=2.5\text{V}$, $I_D=4\text{A}$ $V_{GS}=1.8\text{V}$, $I_D=2\text{A}$		25	30	m Ω
				34	40	m Ω
g_{FS}	Forward Transconductance	$V_{DS}=5\text{V}$, $I_D=5\text{A}$	12	17		S
V_{SD}	Diode Forward Voltage	$I_S=1\text{A}$		0.66	1	V
I_S	Maximum Body-Diode Continuous Current				3	A
DYNAMIC PARAMETERS						
C_{iss}	Input Capacitance	$V_{GS}=0\text{V}$, $V_{DS}=15\text{V}$, $f=1\text{MHz}$		767		pF
C_{oss}	Output Capacitance			111		pF
C_{riss}	Reverse Transfer Capacitance			82		pF
R_g	Gate resistance	$V_{GS}=0\text{V}$, $V_{DS}=0\text{V}$, $f=1\text{MHz}$		1.3		Ω
SWITCHING PARAMETERS						
Q_g	Total Gate Charge	$V_{GS}=4.5\text{V}$, $V_{DS}=15\text{V}$, $I_D=7\text{A}$		10		nC
Q_{gs}	Gate Source Charge			1.2		nC
Q_{gd}	Gate Drain Charge			3.1		nC
$t_{D(on)}$	Turn-On DelayTime	$V_{GS}=10\text{V}$, $V_{DS}=15\text{V}$, $R_L=2.2\Omega$, $R_{GEN}=6\Omega$		5		ns
t_r	Turn-On Rise Time			5.5		ns
$t_{D(off)}$	Turn-Off DelayTime			39		ns
t_f	Turn-Off Fall Time			4.7		ns
t_{rr}	Body Diode Reverse Recovery time	$I_F=5\text{A}$, $dI/dt=100\text{A}/\mu\text{s}$		15		ns
Q_{rr}	Body Diode Reverse Recovery charge	$I_F=5\text{A}$, $dI/dt=100\text{A}/\mu\text{s}$		7.1		nC

A: The value of $R_{\theta JA}$ is measured with the device mounted on 1in² FR-4 board with 2oz. Copper, in a still air environment with $T_A=25^\circ\text{C}$. The value in any a given application depends on the user's specific board design. The current rating is based on the $t \leq 10\text{s}$ thermal resistance rating.

B: Repetitive rating, pulse width limited by junction temperature.

C: The $R_{\theta JA}$ is the sum of the thermal impedance from junction to lead $R_{\theta JL}$ and lead to ambient.

D: The static characteristics in Figures 1 to 6 are obtained using 80 μs pulses, duty cycle 0.5% max.

E: These tests are performed with the device mounted on 1 in² FR-4 board with 2oz. Copper, in a still air environment with $T_A=25^\circ\text{C}$. The SOA curve provides a single pulse rating.

TYPICAL ELECTRICAL AND THERMAL CHARACTERISTICS

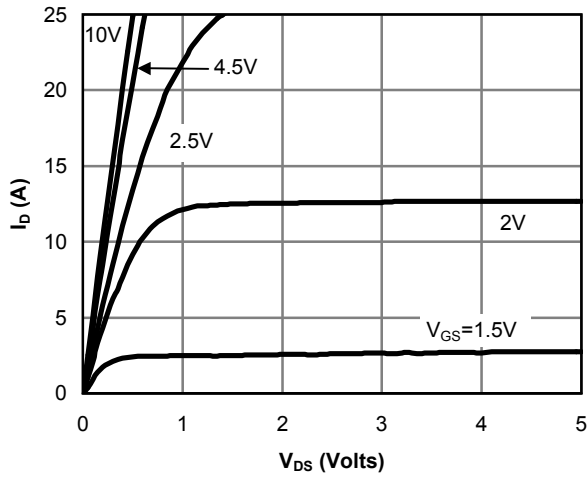

Fig 1: On-Region Characteristics

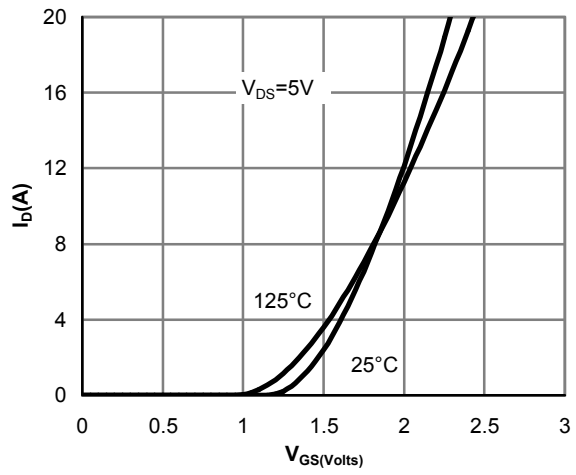

Figure 2: Transfer Characteristics

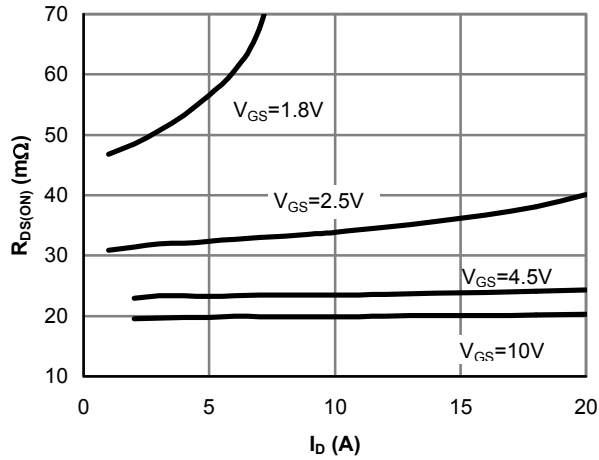

Figure 3: On-Resistance vs. Drain Current and Gate Voltage

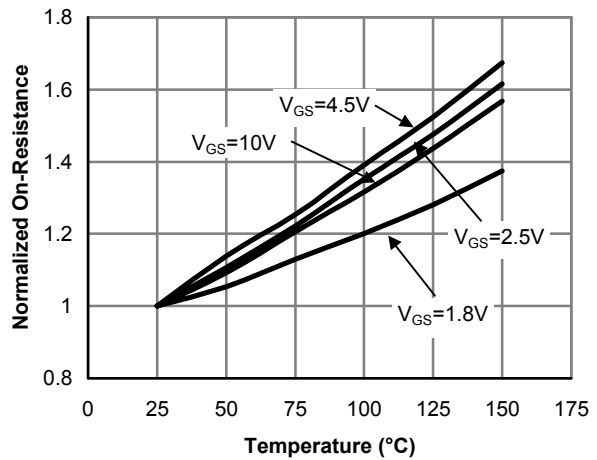

Figure 4: On-Resistance vs. Junction Temperature

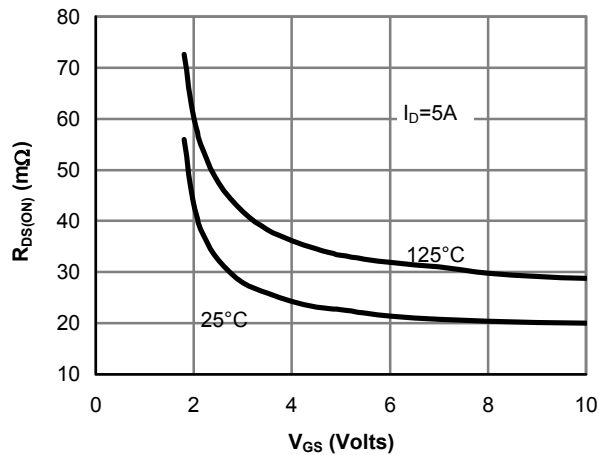

Figure 5: On-Resistance vs. Gate-Source Voltage

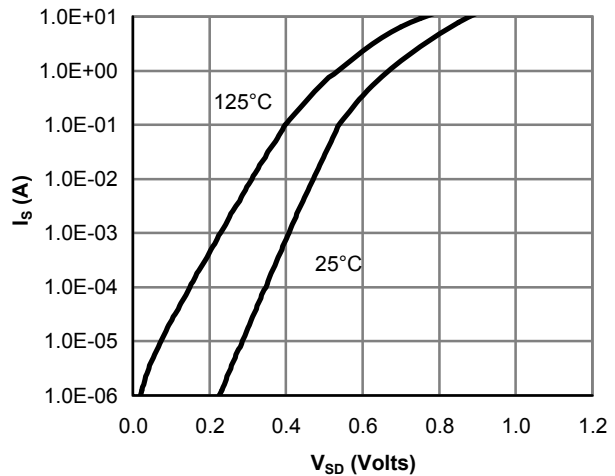

Figure 6: Body-Diode Characteristics

TYPICAL ELECTRICAL AND THERMAL CHARACTERISTICS

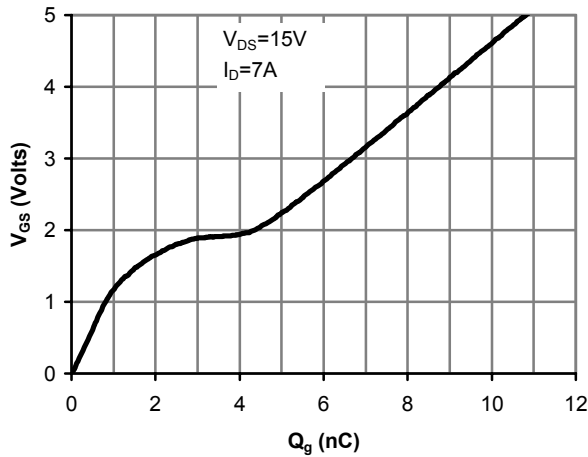

Figure 7: Gate-Charge Characteristics

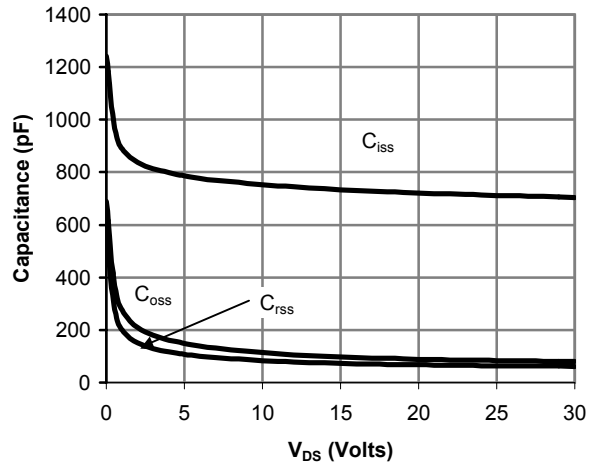

Figure 8: Capacitance Characteristics

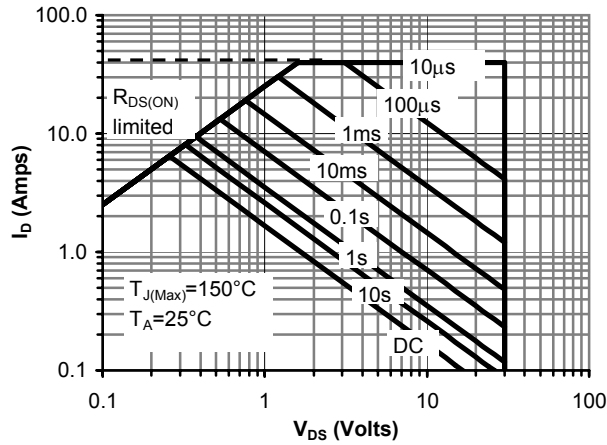

Figure 9: Maximum Forward Biased Safe Operating Area (Note E)

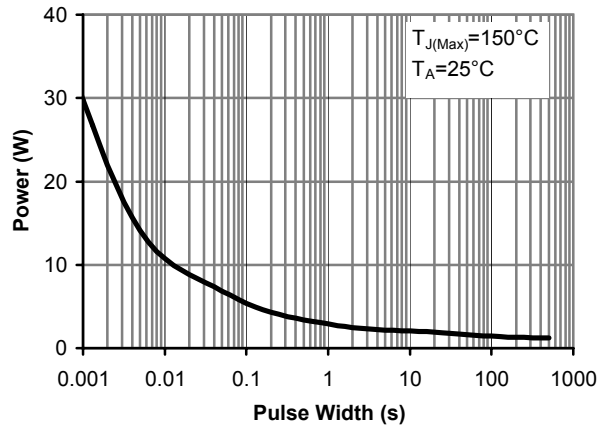

Figure 10: Single Pulse Power Rating Junction-to-Ambient (Note E)

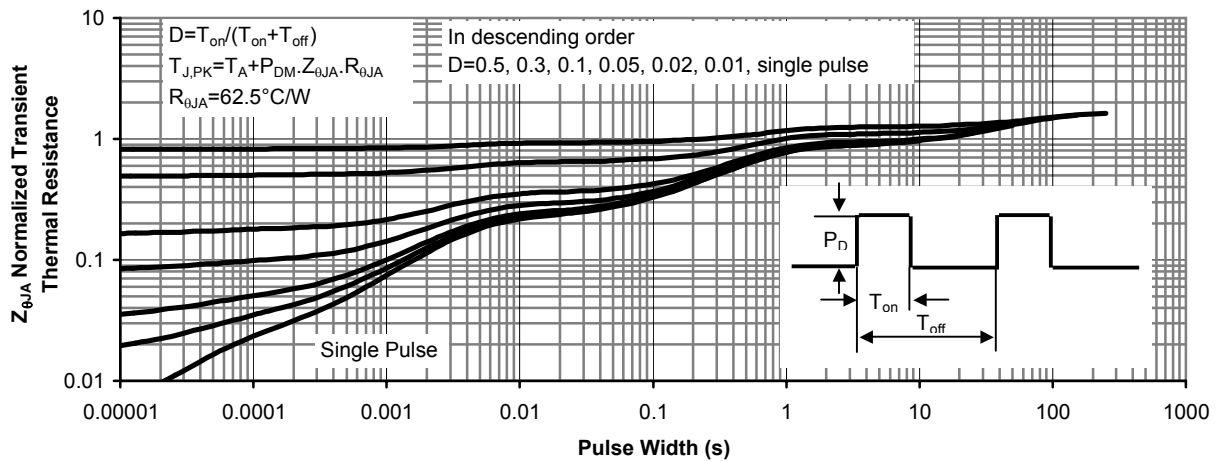
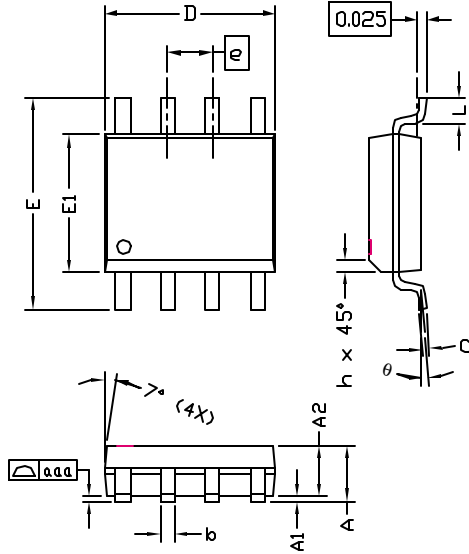

Figure 11: Normalized Maximum Transient Thermal Impedance



ALPHA & OMEGA
SEMICONDUCTOR, INC.

SO-8 Package Data



SYMBOLS	DIMENSIONS IN MILLIMETERS			DIMENSIONS IN INCHES		
	MIN	NOM	MAX	MIN	NOM	MAX
A	1.45	1.50	1.55	0.057	0.059	0.061
A1	0.00	—	0.10	0.000	—	0.004
A2	—	1.45	—	—	0.057	—
b	0.33	—	0.51	0.013	—	0.020
c	0.19	—	0.25	0.007	—	0.010
D	4.80	—	5.00	0.189	—	0.197
E1	3.80	—	4.00	0.150	—	0.157
e	1.27 BSC			0.050 BSC		
E	5.80	—	6.20	0.228	—	0.244
h	0.25	—	0.50	0.010	—	0.020
L	0.40	—	1.27	0.016	—	0.050
aaa	—	—	0.10	—	—	0.004
θ	0°	—	8°	0°	—	8°

- NOTE:
 1. LEAD FINISH: 150 MICRONS (3.8 um) MIN.
 THICKNESS OF Tin/Lead (SOLDER) PLATED ON LEAD
 2. TOLERANCE ±0.100 mm (4 mil) UNLESS OTHERWISE SPECIFIED
 3. COPLANARITY : 0.1000 mm
 4. DIMENSION L IS MEASURED IN GAGE PLANE

PACKAGE MARKING DESCRIPTION

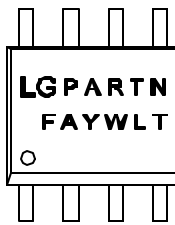

- NOTE:
 LG - AOS LOGO
 PARTN - PART NUMBER CODE
 F - FAB LOCATION
 A - ASSEMBLY LOCATION
 Y - YEAR CODE
 W - WEEK CODE
 L N - ASSEMBLY LOT CODE

SO-8 PART NO. CODE

PART NO.	CODE	PART NO.	CODE	PART NO.	CODE
AO4400	4400	AO4800	4800	AO4700	4700
AO4401	4401	AO4801	4801	AO4701	4701

RECOMMENDED LAND PATTERN

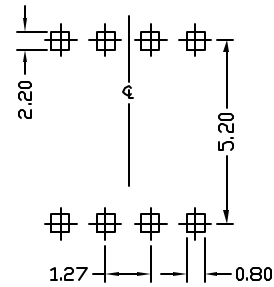

UNIT: mm



SO-8 Carrier Tape

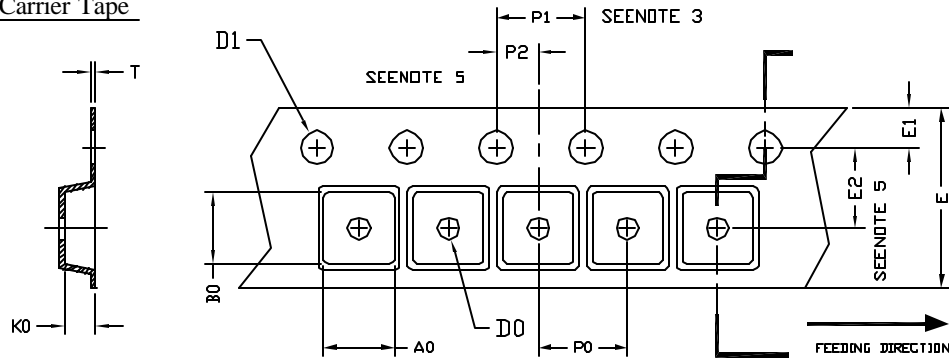

UNIT: MM

PACKAGE	A0	B0	K0	D0	D1	E	E1	E2	P0	P1	P2	T
SO-8 (12 mm)	6.40 ±0.10	5.20 ±0.10	2.10 ±0.10	1.60 ±0.10	1.30 +0.10	12.00 ±0.30	1.75 ±0.10	5.50 ±0.05	8.00 ±0.10	4.00 ±0.10	2.00 ±0.05	0.25 ±0.05

SO-8 Reel

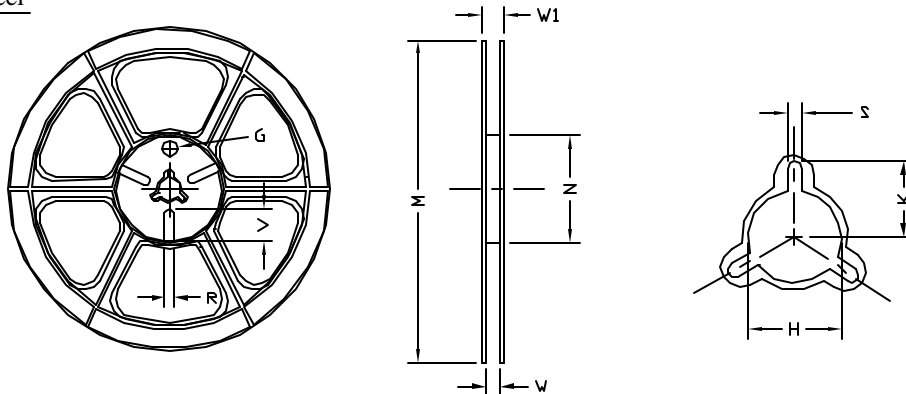

UNIT: MM

TAPE SIZE	REEL SIZE	M	N	W	W1	H	K	S	G	R	V
12 mm	φ330	φ330.00 ±0.50	φ97.00 ±0.10	13.00 ±0.30	17.40 ±1.00	φ13.00 +0.50 -0.20	10.60	2.00 ±0.50	---	---	---

SO-8 Tape

Leader / Trailer
& Orientation

