



AO7404

N-Channel Enhancement Mode Field Effect Transistor

General Description

The AO7404 uses advanced trench technology to provide excellent $R_{DS(ON)}$, low gate charge and operation with gate voltages as low as 1.8V, in the small SOT323 footprint. It can be used for a wide variety of applications, including load switching, low current inverters and low current DC-DC converters. It is ESD protected to 1KV HBM.

Features

- V_{DS} (V) = 20V
- I_D = 1 A
- $R_{DS(ON)} < 225m\Omega$ ($V_{GS} = 4.5V$)
- $R_{DS(ON)} < 290m\Omega$ ($V_{GS} = 2.5V$)
- $R_{DS(ON)} < 425m\Omega$ ($V_{GS} = 1.8V$)

**SC-70
(SOT-323)
Top View**

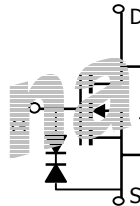
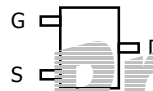

Absolute Maximum Ratings $T_A=25^\circ C$ unless otherwise noted

Parameter	Symbol	Maximum	Units
Drain-Source Voltage	V_{DS}	20	V
Gate-Source Voltage	V_{GS}	± 8	V
Continuous Drain Current ^A	I_D	1	A
$T_A=25^\circ C$		0.75	
Pulsed Drain Current ^B	I_{DM}	5	
Power Dissipation ^A	P_D	0.35	W
		$T_A=70^\circ C$	
Junction and Storage Temperature Range	T_J, T_{STG}	-55 to 150	$^\circ C$

Thermal Characteristics

Parameter	Symbol	Typ	Max	Units
Maximum Junction-to-Ambient ^A	$R_{\theta JA}$	300	360	$^\circ C/W$
$t \leq 10s$		340	425	
Maximum Junction-to-Lead ^C	$R_{\theta JL}$	280	320	$^\circ C/W$

Electrical Characteristics ($T_J=25^\circ\text{C}$ unless otherwise noted)

Symbol	Parameter	Conditions	Min	Typ	Max	Units
STATIC PARAMETERS						
BV_{DSS}	Drain-Source Breakdown Voltage	$I_D=250\mu\text{A}$, $V_{GS}=0\text{V}$	20			V
I_{DSS}	Zero Gate Voltage Drain Current	$V_{DS}=16\text{V}$, $V_{GS}=0\text{V}$ $T_J=55^\circ\text{C}$			1 5	μA
I_{GSS}	Gate-Body leakage current	$V_{DS}=0\text{V}$, $V_{GS}=\pm 8\text{V}$			25	μA
$V_{GS(th)}$	Gate Threshold Voltage	$V_{DS}=V_{GS}$, $I_D=250\mu\text{A}$	0.4	0.55	0.8	V
$I_{D(ON)}$	On state drain current	$V_{GS}=4.5\text{V}$, $V_{DS}=5\text{V}$	5			A
$R_{DS(ON)}$	Static Drain-Source On-Resistance	$V_{GS}=4.5\text{V}$, $I_D=1\text{A}$ $T_J=125^\circ\text{C}$		186 262	225 315	$\text{m}\Omega$
		$V_{GS}=2.5\text{V}$, $I_D=0.85\text{A}$		241	290	$\text{m}\Omega$
		$V_{GS}=1.8\text{V}$, $I_D=0.7\text{A}$		326	425	$\text{m}\Omega$
g_{FS}	Forward Transconductance	$V_{DS}=5\text{V}$, $I_D=1\text{A}$		2.6		S
V_{SD}	Diode Forward Voltage	$I_S=1\text{A}$, $V_{GS}=0\text{V}$		0.69	1	V
I_S	Maximum Body-Diode Continuous Current				0.4	A
DYNAMIC PARAMETERS						
C_{iss}	Input Capacitance	$V_{GS}=0\text{V}$, $V_{DS}=10\text{V}$, $f=1\text{MHz}$		101		pF
C_{oss}	Output Capacitance			17		pF
C_{rSS}	Reverse Transfer Capacitance			14		pF
R_g	Gate resistance	$V_{GS}=0\text{V}$, $V_{DS}=0\text{V}$, $f=1\text{MHz}$		3		Ω
SWITCHING PARAMETERS						
Q_g	Total Gate Charge	$V_{GS}=4.5\text{V}$, $V_{DS}=10\text{V}$, $I_D=1\text{A}$		1.57		nC
Q_{gs}	Gate Source Charge			0.13		nC
Q_{gd}	Gate Drain Charge			0.36		nC
$t_{D(on)}$	Turn-On DelayTime	$V_{GS}=5\text{V}$, $V_{DS}=10\text{V}$, $R_L=10\Omega$, $R_{GEN}=6\Omega$		3.2		ns
t_r	Turn-On Rise Time			4		ns
$t_{D(off)}$	Turn-Off DelayTime			15.5		ns
t_f	Turn-Off Fall Time			2.4		ns
t_{rr}	Body Diode Reverse Recovery Time	$I_F=1\text{A}$, $dI/dt=100\text{A}/\mu\text{s}$		6.7		ns
Q_{rr}	Body Diode Reverse Recovery Charge	$I_F=1\text{A}$, $dI/dt=100\text{A}/\mu\text{s}$		1.6		nC

A: The value of $R_{\theta JA}$ is measured with the device mounted on 1in² FR-4 board with 2oz. Copper, in a still air environment with $T_A=25^\circ\text{C}$. The value in any a given application depends on the user's specific board design. The current rating is based on the $t \leq 10\text{s}$ thermal resistance rating.

B: Repetitive rating, pulse width limited by junction temperature.

C: The $R_{\theta JA}$ is the sum of the thermal impedance from junction to lead $R_{\theta JL}$ and lead to ambient.

D: The static characteristics in Figures 1 to 6, 12, 14 are obtained using 80 μs pulses, duty cycle 0.5% max.

E: These tests are performed with the device mounted on 1 in² FR-4 board with 2oz. Copper, in a still air environment with $T_A=25^\circ\text{C}$. The SOA curve provides a single pulse rating.

TYPICAL ELECTRICAL AND THERMAL CHARACTERISTICS

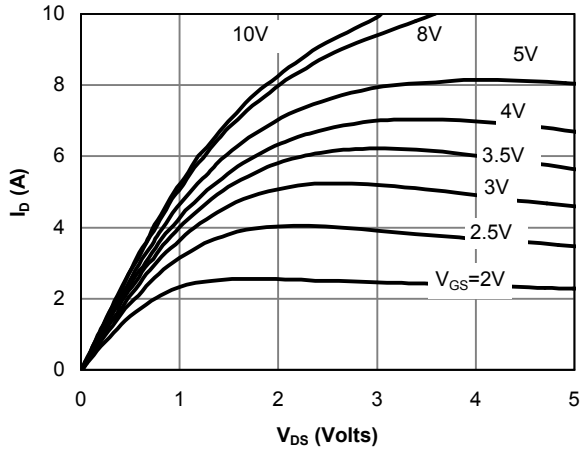

Fig 1: On-Region Characteristics

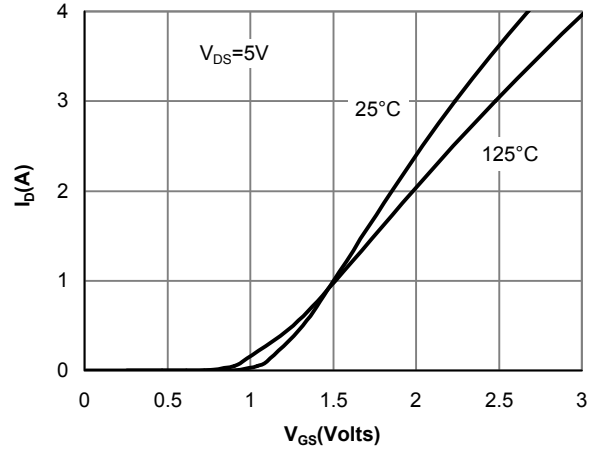

Figure 2: Transfer Characteristics

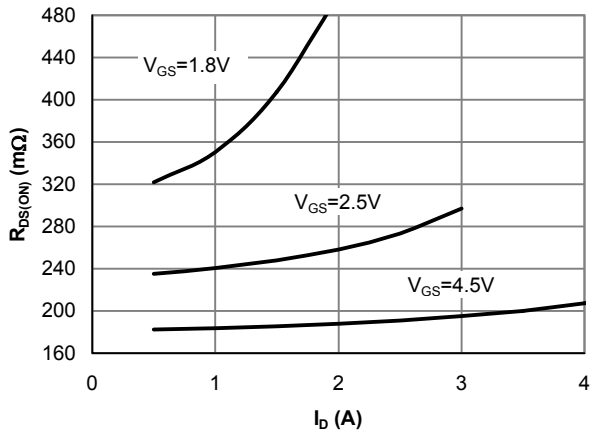

Figure 3: On-Resistance vs. Drain Current and Gate Voltage

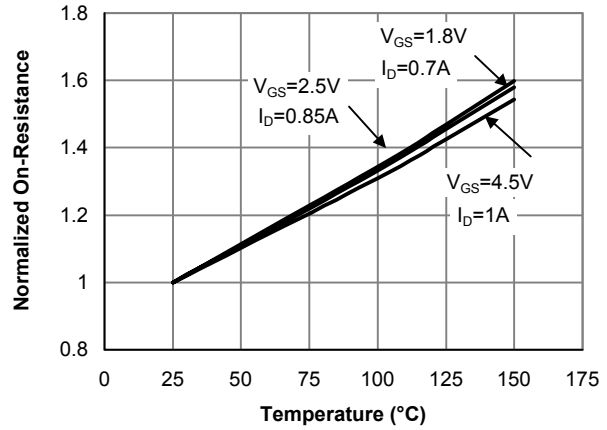

Figure 4: On-Resistance vs. Junction Temperature

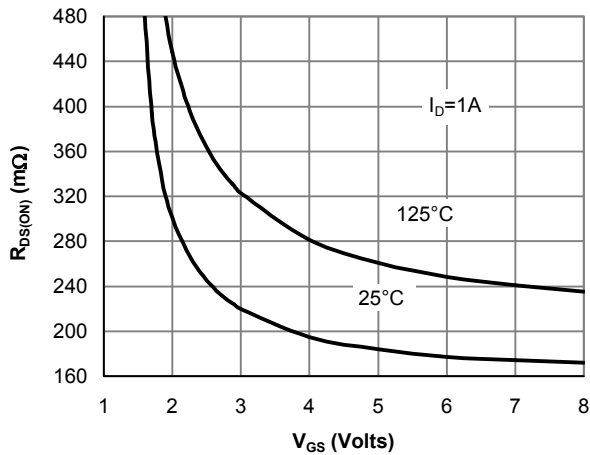

Figure 5: On-Resistance vs. Gate-Source Voltage

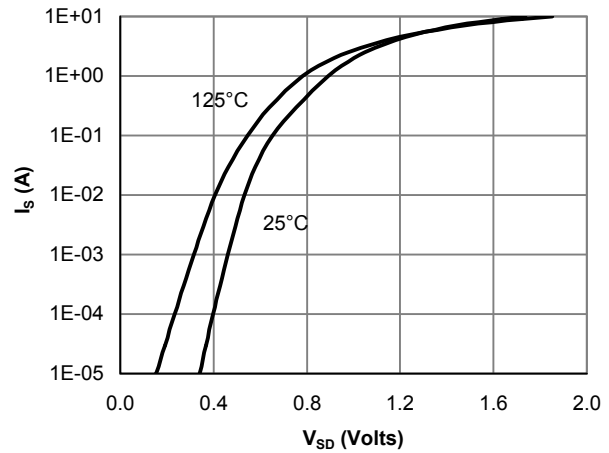

Figure 6: Body-Diode Characteristics

TYPICAL ELECTRICAL AND THERMAL CHARACTERISTICS

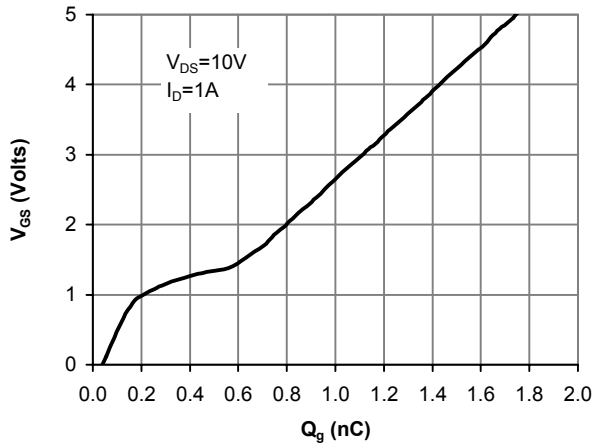

Figure 7: Gate-Charge Characteristics

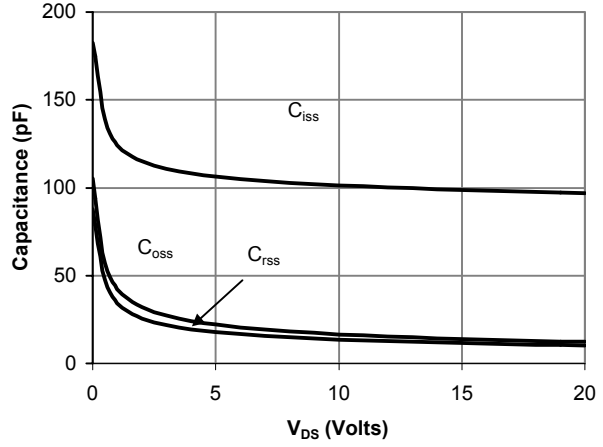

Figure 8: Capacitance Characteristics

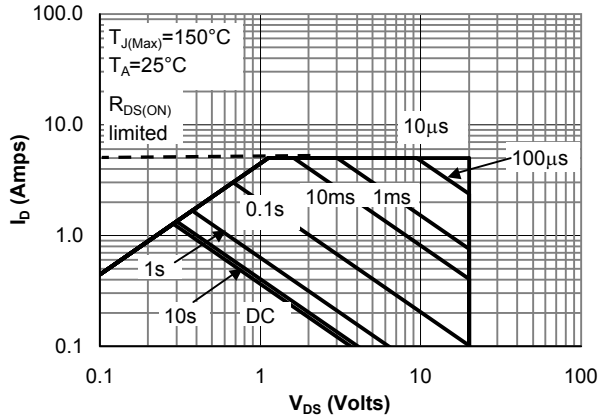

Figure 9: Maximum Forward Biased Safe Operating Area (Note E)

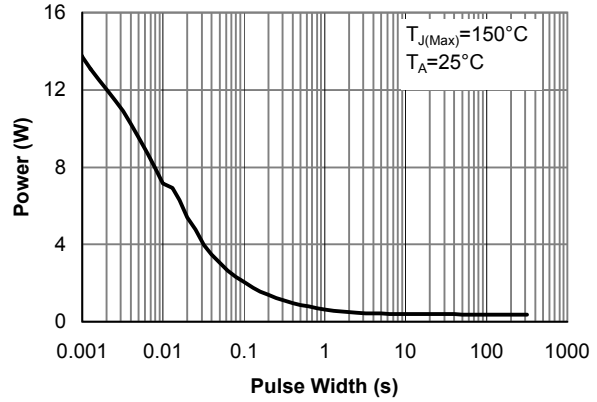

Figure 10: Single Pulse Power Rating Junction-to-Ambient (Note E)

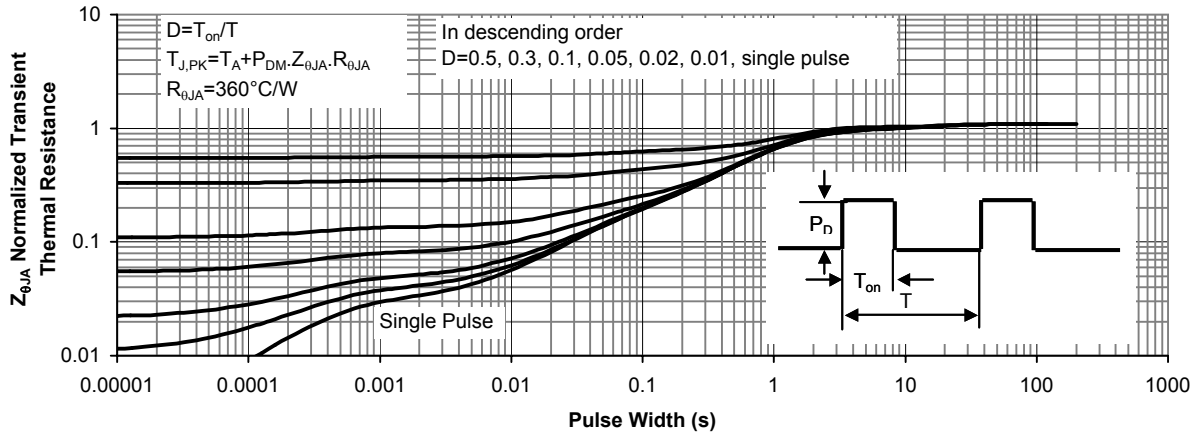
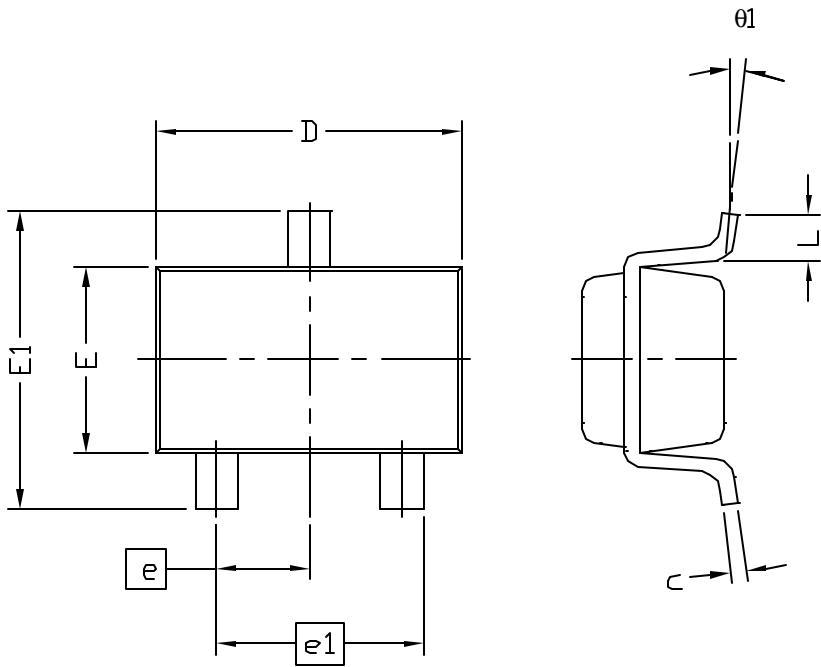

Figure 11: Normalized Maximum Transient Thermal Impedance



ALPHA & OMEGA
SEMICONDUCTOR, INC.

Document No.	PD-00132
Version	rev A
Title	AO7404 Package Data Sheet



SYMBOLS	DIMENSIONS IN MILLIMETERS	
	MIN	MAX
A	0.90	1.10
A1	0.00	0.10
A2	0.90	1.00
b	0.25	0.40
C	0.10	0.20
D	1.80	2.20
E	1.15	1.35
E1	2.00	2.20
F	0.30	0.40
e	0.65 BSC	
e1	1.30 BSC	
L	0.10	0.30
$\theta 1$	1°	8°

- NOTE:
- LEAD FINISH: 150 MICRONS (3.8 μ m) MIN.
THICKNESS OF Tin/Lead (SOLDER) PLATED ON LEAD
 - TOLERANCE ± 0.10 mm (4 mil) UNLESS OTHERWISE SPECIFIED
 - COPLANARITY : 0.10 mm
 - OTHER NAME OF THIS PACKAGE IS CALLED SOT-323

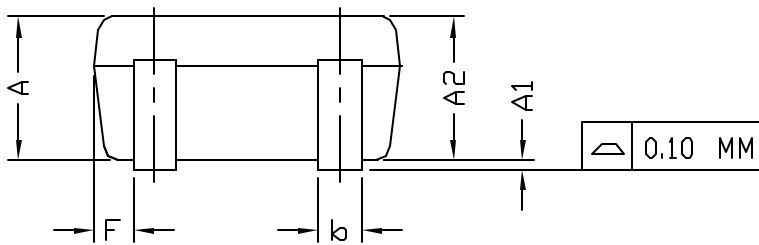

PACKAGE MARKING DESCRIPTION

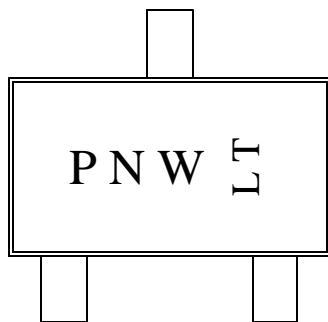

SC-70 3L PART NO. CODE

PART NO.	CODE
AO7404	4

- NOTE:
- P - PART NUMBER CODE.
 - N - FOUNDRY AND ASSEMBLY LOCATION CODE
 - W - YAER AND WEEK CODE.
 - L T - ASSEMBLY LOT CODE.

RECOMMENDATION OF LAND PATTERN

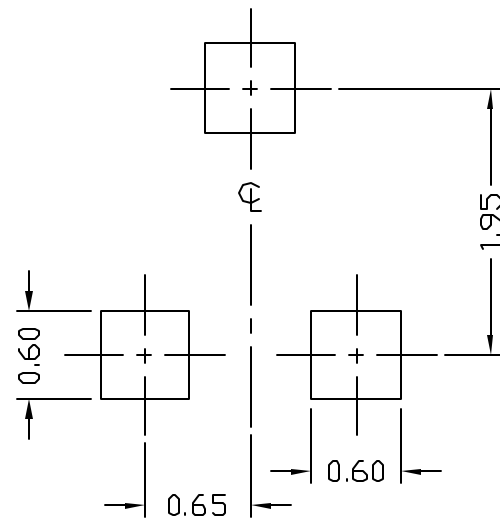



SC-70 3L Carrier Tape

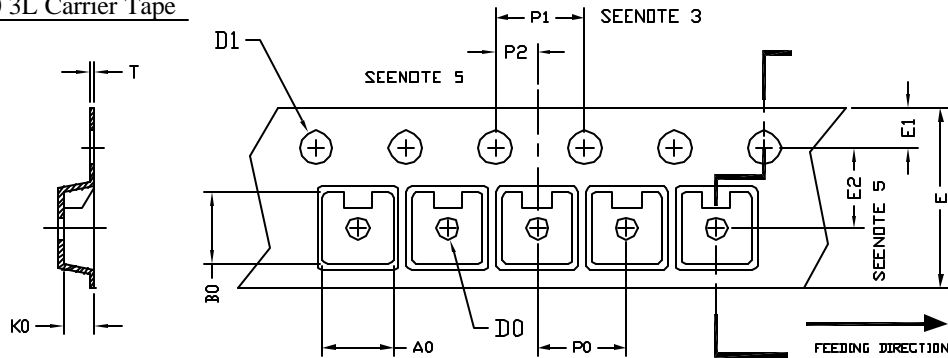

UNIT: MM

PACKAGE	A0	B0	K0	D0	D1	E	E1	E2	P0	P1	P2	T
SC-70, 3L (B mm)	2.40 ±0.10	2.40 ±0.10	1.19 ±0.10	1.00 MIN	1.55 ±0.05	8.00 ±0.30	1.75 ±0.10	3.50 ±0.05	4.00 ±0.10	4.00 ±0.10	2.00 ±0.05	0.25 ±0.05

SC-70 3L Reel

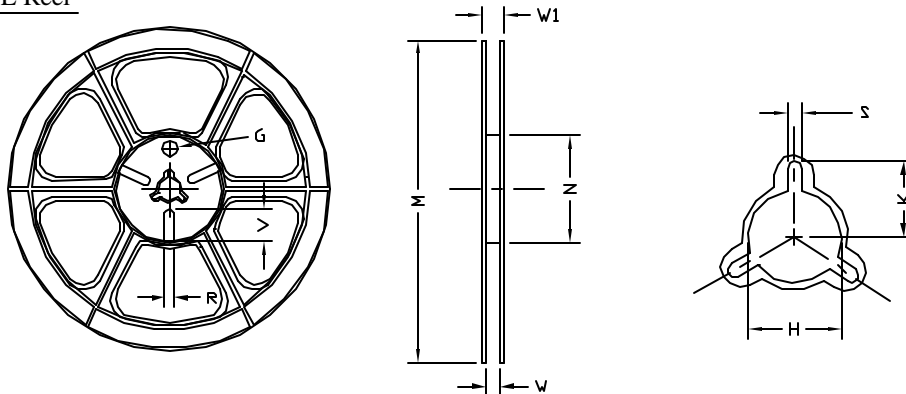

UNIT: MM

TAPE SIZE	REEL SIZE	M	N	W	W1	H	K	S	G	R	V
8 mm	φ180	φ180.00 ±0.50	φ60.50	9.00 ±0.30	11.40 ±1.00	φ13.00 +0.50 -0.20	10.60	2.00 ±0.50	φ9.00	5.00	18.00

SC-70 3L Tape

Leader / Trailer
& Orientation

