



AOB414

N-Channel Enhancement Mode Field Effect Transistor

General Description

The AOB414 uses advanced trench technology to provide excellent $R_{DS(ON)}$, shoot-through immunity and body diode characteristics. This device is ideally suited for use as a low side switch in CPU core power conversion.

Features

- V_{DS} (V) = 30V
- I_D = 110A
- $R_{DS(ON)} < 4.2m\Omega$ ($V_{GS} = 10V$)
- $R_{DS(ON)} < 4.8m\Omega$ ($V_{GS} = 4.5V$)

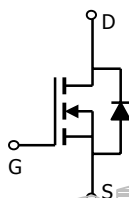
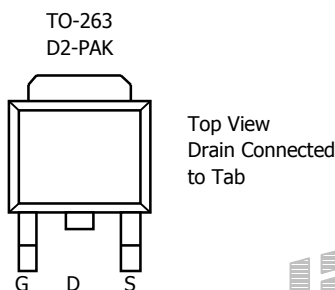

Absolute Maximum Ratings $T_A = 25^\circ C$ unless otherwise noted

Parameter	Symbol	Maximum	Units
Drain-Source Voltage	V_{DS}	30	V
Gate-Source Voltage	V_{GS}	± 12	V
Continuous Drain Current ^{B,G}	I_D	$T_A = 25^\circ C^G$	A
		$T_A = 100^\circ C^B$	
Pulsed Drain Current	I_{DM}	200	
Avalanche Current ^C	I_{AR}	30	A
Repetitive avalanche energy $L=0.1mH^C$	E_{AR}	140	mJ
Power Dissipation ^B	P_D	$T_C = 25^\circ C$	W
		$T_A = 100^\circ C$	
Power Dissipation ^A	P_{DSM}	$T_C = 25^\circ C$	W
		$T_A = 70^\circ C$	
Junction and Storage Temperature Range	T_J, T_{STG}	-55 to 150	$^\circ C$

Thermal Characteristics

Parameter	Symbol	Typ	Max	Units
Maximum Junction-to-Ambient ^A	$R_{\theta JA}$	8.1	12	$^\circ C/W$
Maximum Junction-to-Ambient ^A		Steady-State	33	40
Maximum Junction-to-Lead ^C	$R_{\theta JL}$	0.84	1.5	$^\circ C/W$

Electrical Characteristics ($T_J=25^\circ\text{C}$ unless otherwise noted)

Symbol	Parameter	Conditions	Min	Typ	Max	Units
STATIC PARAMETERS						
BV_{DSS}	Drain-Source Breakdown Voltage	$I_D=250\mu\text{A}$, $V_{GS}=0\text{V}$	30			V
I_{DSS}	Zero Gate Voltage Drain Current	$V_{DS}=24\text{V}$, $V_{GS}=0\text{V}$ $T_J=55^\circ\text{C}$			1 5	μA
I_{GSS}	Gate-Body leakage current	$V_{DS}=0\text{V}$, $V_{GS}=\pm 12\text{V}$			100	nA
$V_{GS(th)}$	Gate Threshold Voltage	$V_{DS}=V_{GS}$, $I_D=250\mu\text{A}$	0.8	1.1	1.5	V
$I_{D(ON)}$	On state drain current	$V_{GS}=4.5\text{V}$, $V_{DS}=5\text{V}$	110			A
$R_{DS(ON)}$	Static Drain-Source On-Resistance	$V_{GS}=10\text{V}$, $I_D=30\text{A}$ $T_J=125^\circ\text{C}$		3.2 5	4.2 6	$\text{m}\Omega$
		$V_{GS}=4.5\text{V}$, $I_D=30\text{A}$		3.8	4.8	$\text{m}\Omega$
g_{FS}	Forward Transconductance	$V_{DS}=5\text{V}$, $I_D=30\text{A}$		102		S
V_{SD}	Diode Forward Voltage	$I_S=1\text{A}$, $V_{GS}=0\text{V}$		0.64	1	V
I_S	Maximum Body-Diode Continuous Current				110	A
DYNAMIC PARAMETERS						
C_{iss}	Input Capacitance	$V_{GS}=0\text{V}$, $V_{DS}=15\text{V}$, $f=1\text{MHz}$		9130		pF
C_{oss}	Output Capacitance			625		pF
C_{rss}	Reverse Transfer Capacitance			387		pF
R_g	Gate resistance	$V_{GS}=0\text{V}$, $V_{DS}=0\text{V}$, $f=1\text{MHz}$		0.4		Ω
SWITCHING PARAMETERS						
$Q_g(4.5\text{V})$	Total Gate Charge	$V_{GS}=4.5\text{V}$, $V_{DS}=15\text{V}$, $I_D=30\text{A}$		72.4		nC
Q_{gs}	Gate Source Charge			12.8		nC
Q_{gd}	Gate Drain Charge			18.4		nC
$t_{D(on)}$	Turn-On Delay Time	$V_{GS}=10\text{V}$, $V_{DS}=15\text{V}$, $R_L=0.5\Omega$, $R_{GEN}=3\Omega$		15		ns
t_r	Turn-On Rise Time			29.2		ns
$t_{D(off)}$	Turn-Off Delay Time			106.5		ns
t_f	Turn-Off Fall Time			52		ns
t_{rr}	Body Diode Reverse Recovery Time	$I_F=30\text{A}$, $dI/dt=100\text{A}/\mu\text{s}$		31.2		ns
Q_{rr}	Body Diode Reverse Recovery Charge	$I_F=30\text{A}$, $dI/dt=100\text{A}/\mu\text{s}$		20.3		nC

A: The value of $R_{\theta JA}$ is measured with the device mounted on 1in² FR-4 board with 2oz. Copper, in a still air environment with $T_A=25^\circ\text{C}$. The Power dissipation P_{DSM} is based on steady-state $R_{\theta JA}$ and the maximum allowed junction temperature of 150°C . The value in any a given application depends on the user's specific board design, and the maximum temperature for 175°C may be used if the PCB or heatsink allows it.

B: The power dissipation P_D is based on $T_{J(MAX)}=175^\circ\text{C}$, using junction-to-case thermal resistance, and is more useful in setting the upper dissipation limit for cases where additional heatsinking is used. It is used to determine the current rating, when this rating falls below the package limit.

C: Repetitive rating, pulse width limited by junction temperature $T_{J(MAX)}=175^\circ\text{C}$.

D: The $R_{\theta JA}$ is the sum of the thermal impedance from junction to case $R_{\theta JC}$ and case to ambient.

E: The static characteristics in Figures 1 to 6 are obtained using $<300\mu\text{s}$ pulses, duty cycle 0.5% max.

F: These tests are performed with the device mounted on 1 in² FR-4 board with 2oz. Copper, in a still air environment with $T_A=25^\circ\text{C}$. The SOA curve provides a single pulse rating.

G: The maximum current rating is limited by the package current capability.

TYPICAL ELECTRICAL AND THERMAL CHARACTERISTICS

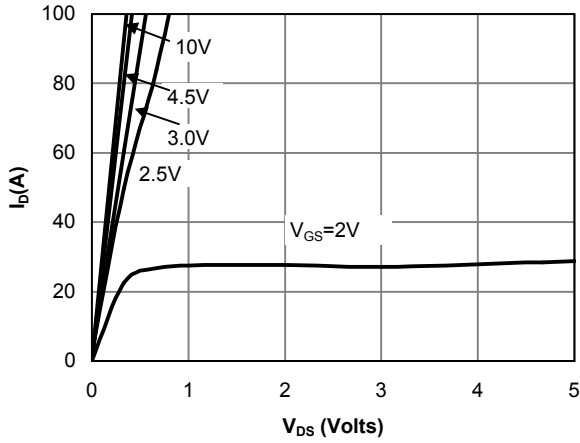

Figure 1: On-Region Characteristics

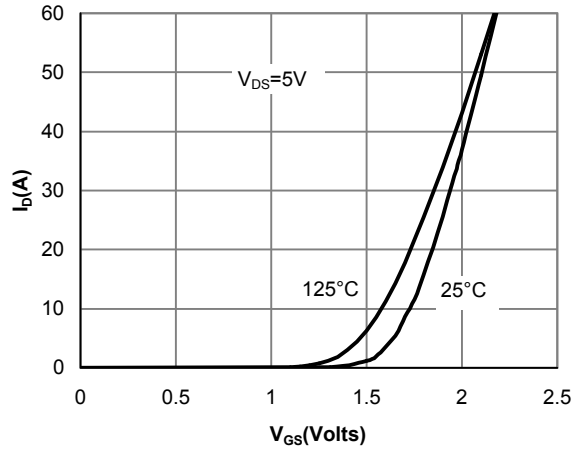

Figure 2: Transfer Characteristics

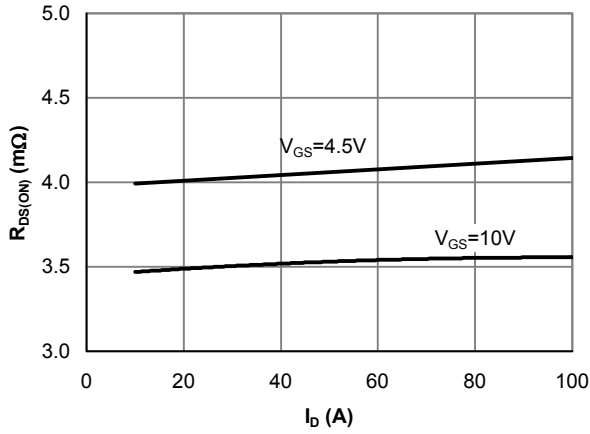

Figure 3: On-Resistance vs. Drain Current and Gate Voltage

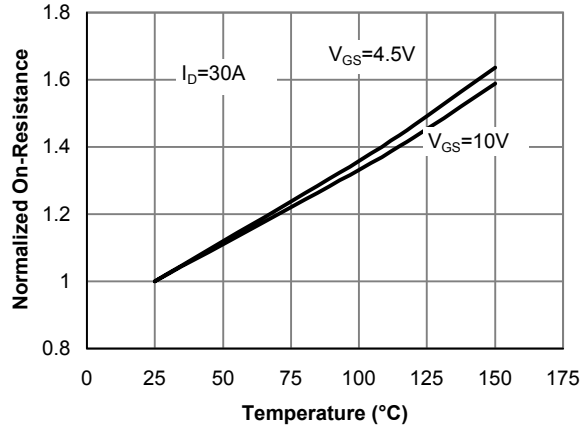

Figure 4: On-Resistance vs. Junction Temperature

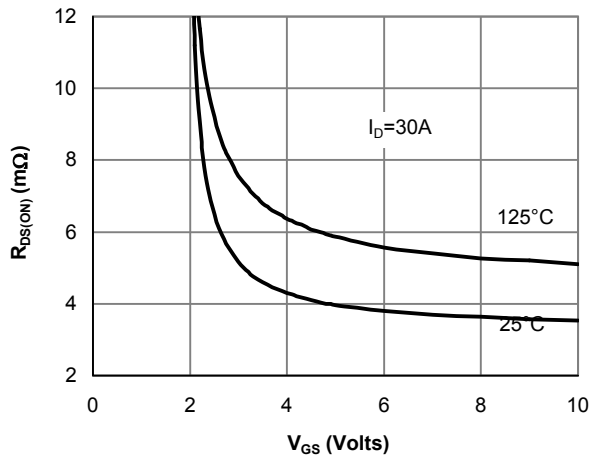

Figure 5: On-Resistance vs. Gate-Source Voltage

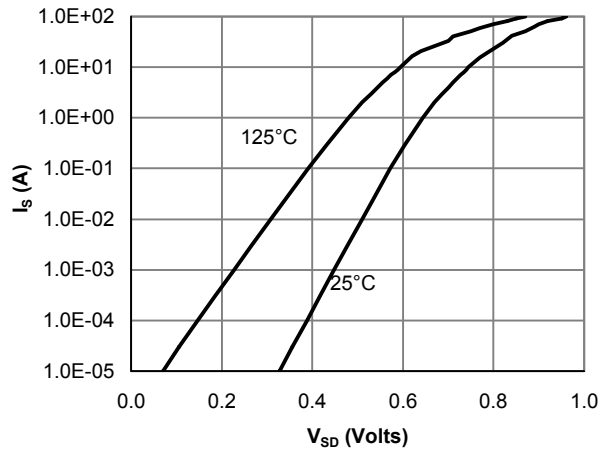

Figure 6: Body-Diode Characteristics

TYPICAL ELECTRICAL AND THERMAL CHARACTERISTICS

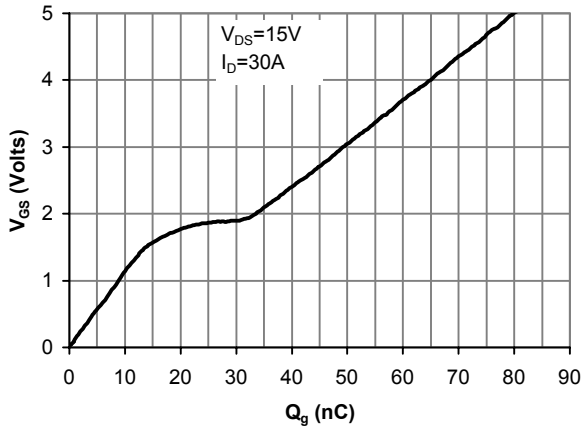

Figure 7: Gate-Charge Characteristics

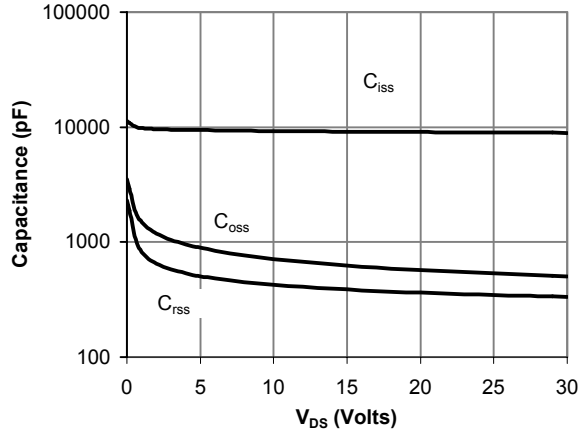

Figure 8: Capacitance Characteristics

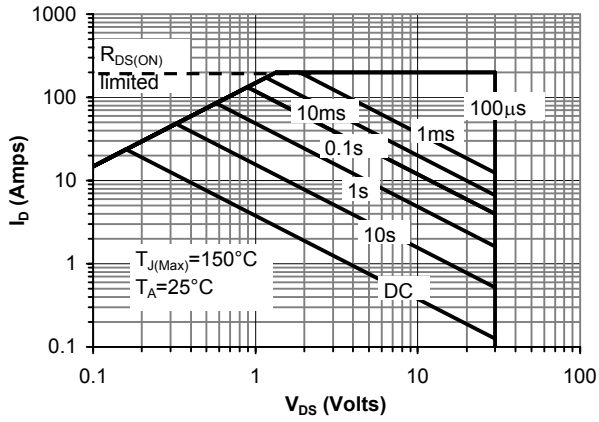

Figure 9: Maximum Forward Biased Safe Operating Area (Note F)

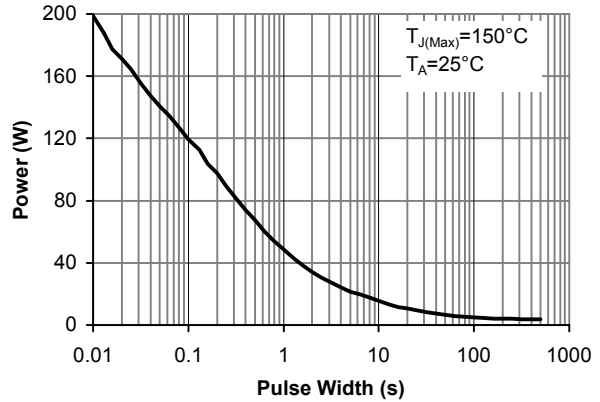

Figure 10: Single Pulse Power Rating Junction-to-Ambient (Note F)

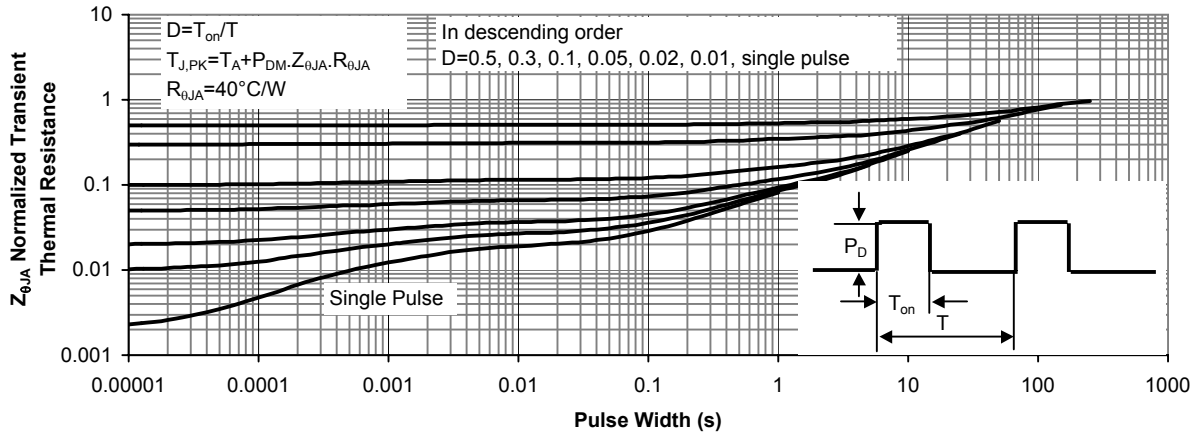
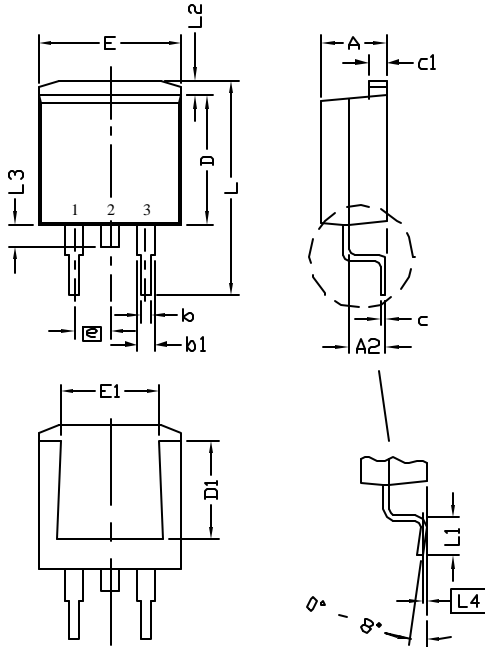

Figure 11: Normalized Maximum Transient Thermal Impedance (Note F)



ALPHA & OMEGA
SEMICONDUCTOR, INC.

D2PAK Package Data
(JEDEC TO-263)



SYMBOL	DIMENSION IN MILLIMETERS			DIMENSIONS IN INCHES		
	MIN.	NOM.	MAX.	MIN.	NOM.	MAX.
A	4.30	4.45	4.70	0.169	0.175	0.185
A2	2.64	-----	2.69	0.104	-----	0.106
b	0.69	0.81	0.94	0.027	0.032	0.037
b1	1.22	1.27	1.40	0.048	0.050	0.055
c	0.36	0.38	0.56	0.014	0.015	0.022
c1	1.22	1.27	1.32	0.048	0.050	0.055
D	8.64	9.14	9.65	0.340	0.360	0.380
D1	5.46	-----	-----	0.215	-----	-----
E	9.70	10.03	10.54	0.382	0.395	0.415
E1	6.22	-----	-----	0.245	-----	-----
e	2.54 BSC			0.100 BSC		
L	14.60	15.24	15.78	0.575	0.600	0.625
L1	2.29	2.54	2.79	0.090	0.100	0.110
L2	-----	-----	1.40	-----	-----	0.055
L3	1.27	1.52	1.78	0.050	0.060	0.070
L4	0.25 BSC			0.010 BSC		

- NOTE
1. PACKAGE BODY SIZES EXCLUDE MOLD FLASH AND GATE BURRS
 2. DIMENSION L IS MEASURED IN GAGE PLANE
 3. TOLERANCE 0.10 mm UNLESS OTHERWISE SPECIFIED
 4. CONTROLLING DIMENSION IS MILLIMETER. CONVERTED INCH DIMENSIONS ARE NOT NECESSARILY EXACT.
 5. FOLLOWED FROM JEDEC TO-263 (AB)

PACKAGE MARKING DESCRIPTION

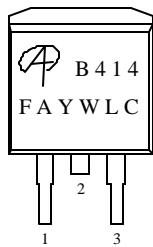

- NOTE:
- AOS LOGO
 - B414 - PART NUMBER CODE.
 - F - FAB LOCATION
 - A - ASSEMBLY LOCATION
 - Y - YEAR CODE
 - W - WEEK CODE
 - LC - ASSEMBLY LOT CODE

DPAK PART NO. CODE

PART NO.	CODE
AOB414	B414

RECOMMENDED LAND PATTERN

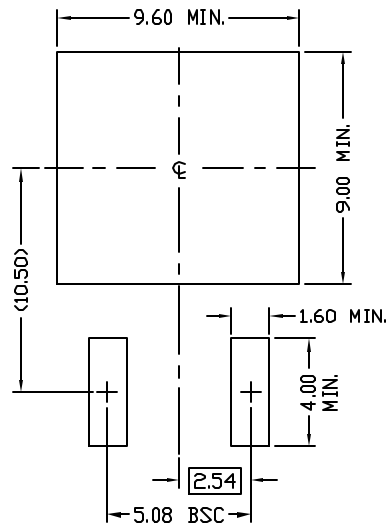

UNIT: mm