

### FEATURES

- Wide operating range:** 50  $\mu$ A to 10 mA
- Initial accuracy:**  $\pm 0.1\%$  maximum
- Temperature drift:**  $\pm 50$  ppm/ $^{\circ}$ C maximum
- Output impedance:** 0.5  $\Omega$  maximum
- Wideband noise (10 Hz to 10 kHz):** 20  $\mu$ V rms
- Operating temperature range:**  $-40^{\circ}$ C to  $+85^{\circ}$ C
- High ESD rating**
  - 4 kV human body model
  - 400 V machine model
- Compact, surface-mount SOT-23 and SC70 packages**

### APPLICATIONS

- Portable, battery-powered equipment**
  - Cellular phones, notebook computers, PDAs, GPSs, and DMMs
- Computer workstations**
  - Suitable for use with a wide range of video RAMDACs
- Smart industrial transmitters**
- PCMCIA cards**
- Automotive**
- 3 V/5 V, 8-bit to 12-bit data converters**

### GENERAL DESCRIPTION

The AD1580<sup>1</sup> is a low cost, 2-terminal (shunt), precision band gap reference. It provides an accurate 1.225 V output for input currents between 50  $\mu$ A and 10 mA.

The superior accuracy and stability of the AD1580 is made possible by the precise matching and thermal tracking of on-chip components. Proprietary curvature correction design techniques have been used to minimize the nonlinearities in the voltage output temperature characteristics. The AD1580 is stable with any value of capacitive load.

The low minimum operating current makes the AD1580 ideal for use in battery-powered 3 V or 5 V systems. However, the wide operating current range means that the AD1580 is extremely versatile and suitable for use in a wide variety of high current applications.

The AD1580 is available in two grades, A and B, both of which are provided in the SOT-23 and SC70 packages, the smallest surface-mount packages available. Both grades are specified over the industrial temperature range of  $-40^{\circ}$ C to  $+85^{\circ}$ C.

<sup>1</sup> Protected by U.S. Patent No. 5,969,657; other patents pending.

#### Rev. D

Information furnished by Analog Devices is believed to be accurate and reliable. However, no responsibility is assumed by Analog Devices for its use, nor for any infringements of patents or other rights of third parties that may result from its use. Specifications subject to change without notice. No license is granted by implication or otherwise under any patent or patent rights of Analog Devices. Trademarks and registered trademarks are the property of their respective owners.

### PIN CONFIGURATIONS

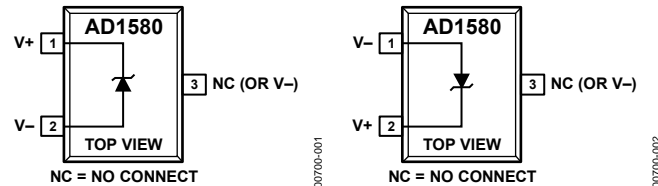

Figure 1. SOT-23

Figure 2. SC70

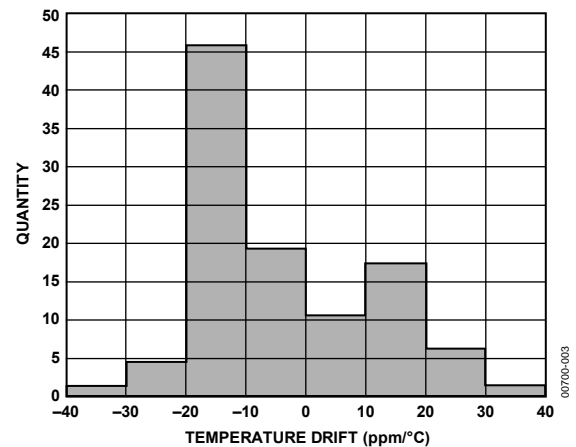

Figure 3. Reverse Voltage Temperature Drift Distribution

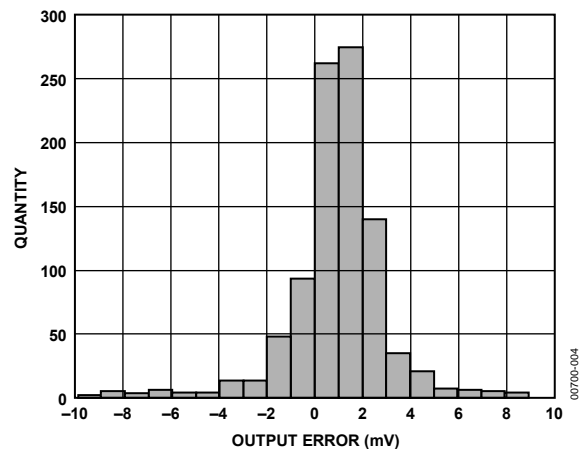

Figure 4. Reverse Voltage Error Distribution

## TABLE OF CONTENTS

|  |   |   |    |
|--|---|---|----|
| Features .....                           | 1 | Voltage Output Nonlinearity vs. Temperature ..... | 7  |
| Applications.....                        | 1 | Reverse Voltage Hysteresis.....                   | 7  |
| General Description.....                 | 1 | Output Impedance vs. Frequency.....               | 7  |
| Pin Configurations.....                  | 1 | Noise Performance and Reduction.....              | 8  |
| Revision History.....                    | 2 | Turn-On Time.....                                 | 8  |
| Specifications.....                      | 3 | Transient Response.....                           | 9  |
| Absolute Maximum Ratings.....            | 4 | Precision Micropower Low Dropout Reference.....   | 9  |
| ESD Caution.....                         | 4 | Using the AD1580 with 3 V Data Converters.....    | 9  |
| Typical Performance Characteristics..... | 5 | Outline Dimensions.....                           | 11 |
| Theory of Operation.....                 | 6 | Ordering Guide.....                               | 12 |
| Applying the AD1580.....                 | 6 | Package Branding Information.....                 | 12 |
| Temperature Performance.....             | 6 |   |    |

## REVISION HISTORY

### 1/08—Rev. C to Rev. D

|                                  |    |
|----------------------------------|----|
| Changes to Figure 5.....         | 5  |
| Changes to Figure 6 Caption..... | 5  |
| Changes to Ordering Guide.....   | 12 |

### 7/06—Rev. B to Rev. C

|                                 |           |
|---------------------------------|-----------|
| Updated Format.....             | Universal |
| Changes to Figure 13.....       | 7         |
| Changes to Figure 16.....       | 8         |
| Updated Outline Dimensions..... | 11        |
| Changes to Ordering Guide.....  | 12        |

### 7/04—Rev. A to Rev. B

|                                |   |
|--------------------------------|---|
| Changes to Ordering Guide..... | 2 |
|--------------------------------|---|

### 10/03—Rev. 0 to Rev. A

|                                   |           |
|-----------------------------------|-----------|
| Renumbered Figures and TPCs.....  | Universal |
| Edits to Features.....            | 1         |
| Edits to General Description..... | 1         |
| Edits to Ordering Guide.....      | 2         |
| Updated Figures 5 Through 7.....  | 4         |
| Updated Outline Dimensions.....   | 8         |

## SPECIFICATIONS

$T_A = 25^\circ\text{C}$ ,  $I_{IN} = 100\ \mu\text{A}$ , unless otherwise noted.

Table 1.

| Model   | AD1580A |       |       | AD1580B |       |        | Unit              |
|---|---------|-------|-------|---------|-------|--------|-------------------|
|   | Min     | Typ   | Max   | Min     | Typ   | Max    |                   |
| REVERSE VOLTAGE OUTPUT (SOT-23)   | 1.215   | 1.225 | 1.235 | 1.224   | 1.225 | 1.226  | V                 |
| REVERSE VOLTAGE OUTPUT (SC70)   |         |       |       | 1.2225  | 1.225 | 1.2275 | V                 |
| REVERSE VOLTAGE TEMPERATURE DRIFT<br>–40°C to +85°C   |         |       | 100   |         |       | 50     | ppm/°C            |
| MINIMUM OPERATING CURRENT, $T_{MIN}$ to $T_{MAX}$   |         |       | 50    |         |       | 50     | $\mu\text{A}$     |
| REVERSE VOLTAGE CHANGE WITH REVERSE CURRENT<br>50 $\mu\text{A} < I_{IN} < 10\ \text{mA}$ , $T_{MIN}$ to $T_{MAX}$             |         | 2.5   | 6     |         | 2.5   | 6      | mV                |
| 50 $\mu\text{A} < I_{IN} < 1\ \text{mA}$ , $T_{MIN}$ to $T_{MAX}$   |         | 0.5   |       |         | 0.5   |        | mV                |
| DYNAMIC OUTPUT IMPEDANCE ( $\Delta V_R/\Delta I_R$ )<br>$I_{IN} = 1\ \text{mA} \pm 100\ \mu\text{A}$ ( $f = 120\ \text{Hz}$ ) |         | 0.4   | 1     |         | 0.4   | 0.5    | $\Omega$          |
| OUTPUT NOISE<br>RMS Noise Voltage: 10 Hz to 10 kHz  |         | 20    |       |         | 20    |        | $\mu\text{V rms}$ |
| Low Frequency Noise Voltage: 0.1 Hz to 10 Hz  |         | 5     |       |         | 5     |        | $\mu\text{V p-p}$ |
| TURN-ON SETTLING TIME TO 0.1% <sup>1</sup>  |         | 5     |       |         | 5     |        | $\mu\text{s}$     |
| OUTPUT VOLTAGE HYSTERESIS <sup>2</sup>  |         | 80    |       |         | 80    |        | $\mu\text{V}$     |
| TEMPERATURE RANGE<br>Specified Performance, $T_{MIN}$ to $T_{MAX}$  | –40     |       | +85   | –40     |       | +85    | °C                |
| Operating Range <sup>3</sup>  | –55     |       | +125  | –55     |       | +125   | °C                |

<sup>1</sup> Measured with no load capacitor.

<sup>2</sup> Output hysteresis is defined as the change in the +25°C output voltage after a temperature excursion to +85°C and then to –40°C.

<sup>3</sup> The operating temperature range is defined as the temperature extremes at which the device continues to function. Parts may deviate from their specified performance.

## ABSOLUTE MAXIMUM RATINGS

Table 2.

| Parameter  | Rating          |
|--|-----------------|
| Reverse Current  | 25 mA           |
| Forward Current  | 20 mA           |
| Internal Power Dissipation <sup>1</sup><br>SOT-23 (RT) | 0.3 W           |
| Storage Temperature Range                              | -65°C to +150°C |
| Operating Temperature Range<br>AD1580/RT               | -55°C to +125°C |
| Lead Temperature, Soldering<br>Vapor Phase (60 sec)    | 215°C           |
| Infrared (15 sec)                                      | 220°C           |
| ESD Susceptibility <sup>2</sup><br>Human Body Model    | 4 kV            |
| Machine Model  | 400 V           |

<sup>1</sup> Specification is for device in free air at 25°C, SOT-23 package.  $\theta_{JA} = 300^\circ\text{C}/\text{W}$ .

<sup>2</sup> The human body model is a 100 pF capacitor discharged through 1.5 k $\Omega$ . For the machine model, a 200 pF capacitor is discharged directly into the device.

Stresses above those listed under Absolute Maximum Ratings may cause permanent damage to the device. This is a stress rating only; functional operation of the device at these or any other conditions above those indicated in the operational section of this specification is not implied. Exposure to absolute maximum rating conditions for extended periods may affect device reliability.

### ESD CAUTION



**ESD (electrostatic discharge) sensitive device.** Charged devices and circuit boards can discharge without detection. Although this product features patented or proprietary protection circuitry, damage may occur on devices subjected to high energy ESD. Therefore, proper ESD precautions should be taken to avoid performance degradation or loss of functionality.

# TYPICAL PERFORMANCE CHARACTERISTICS

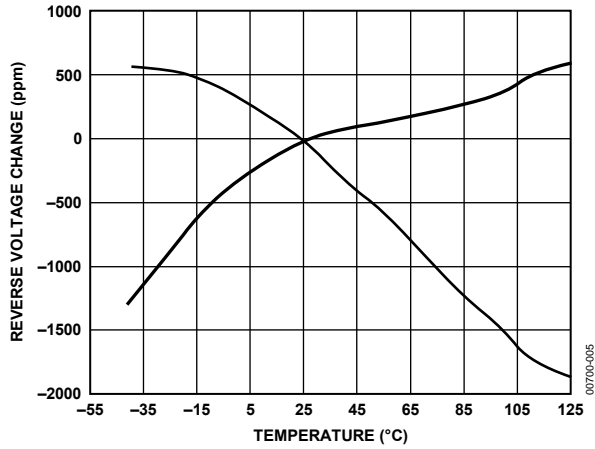

Figure 5. Output Drift for Different Temperature Characteristics

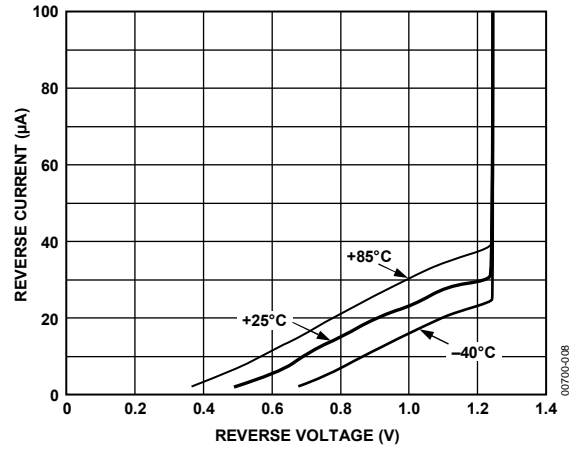

Figure 8. Reverse Current vs. Reverse Voltage

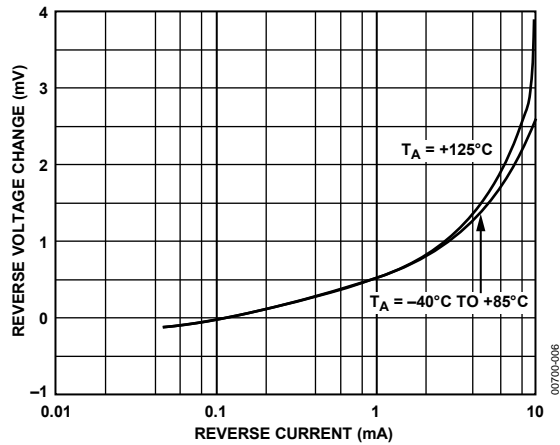

Figure 6. Reverse Voltage Change vs. Reverse Current

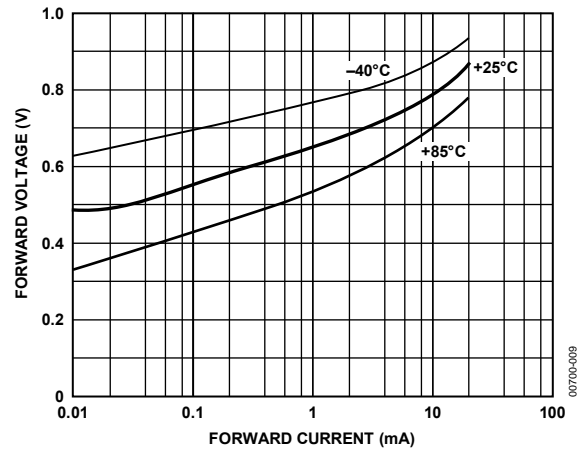

Figure 9. Forward Voltage vs. Forward Current

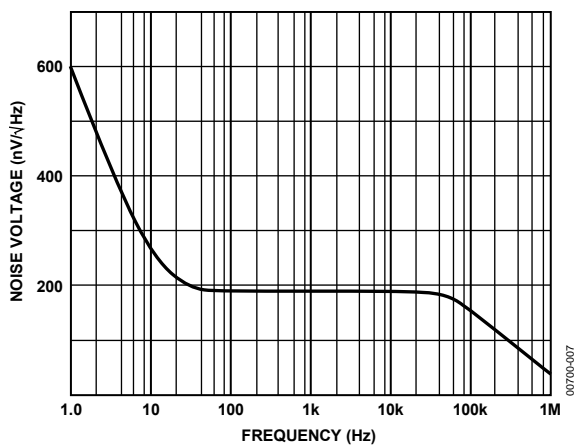

Figure 7. Noise Spectral Density

## THEORY OF OPERATION

The AD1580 uses the band gap concept to produce a stable, low temperature coefficient voltage reference suitable for high accuracy data acquisition components and systems. The device makes use of the underlying physical nature of a silicon transistor base emitter voltage in the forward biased operating region. All such transistors have an approximately  $-2 \text{ mV}/^\circ\text{C}$  temperature coefficient (TC), which is unsuitable for use directly as a low TC reference; however, extrapolation of the temperature characteristic of any one of these devices to absolute zero (with collector current proportional to absolute temperature) reveals that its  $V_{BE}$  goes to approximately the silicon band gap voltage. Thus, if a voltage could be developed with an opposing temperature coefficient to sum with  $V_{BE}$ , a zero TC reference would result. The AD1580 circuit in Figure 10 provides such a compensating voltage,  $V_1$ , by driving two transistors at different current densities and amplifying the resultant  $V_{BE}$  difference ( $\Delta V_{BE}$ , which has a positive TC). The sum of  $V_{BE}$  and  $V_1$  provides a stable voltage reference.

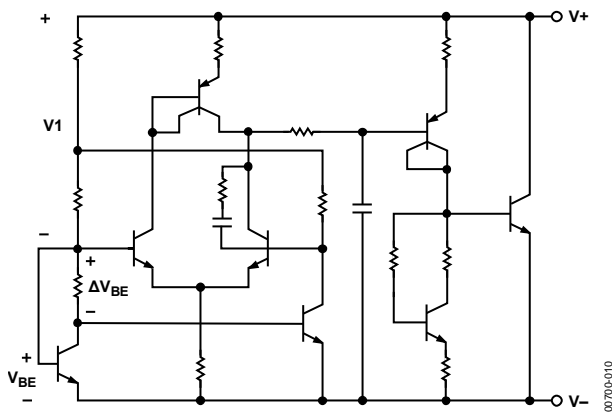

Figure 10. Schematic Diagram

### APPLYING THE AD1580

The AD1580 is simple to use in virtually all applications. To operate the AD1580 as a conventional shunt regulator (see Figure 11), an external series resistor is connected between the supply voltage and the AD1580. For a given supply voltage, the series resistor,  $R_S$ , determines the reverse current flowing through the AD1580. The value of  $R_S$  must be chosen to accommodate the expected variations of the supply voltage,  $V_S$ ; load current,  $I_L$ ; and the AD1580 reverse voltage,  $V_R$ ; while maintaining an acceptable reverse current,  $I_R$ , through the AD1580.

The minimum value for  $R_S$  should be chosen when  $V_S$  is at its minimum and  $I_L$  and  $V_R$  are at their maximum, while maintaining the minimum acceptable reverse current.

The value of  $R_S$  should be large enough to limit  $I_R$  to 10 mA when  $V_S$  is at its maximum and  $I_L$  and  $V_R$  are at their minimum.

The equation for selecting  $R_S$  is as follows:

$$R_S = (V_S - V_R)/(I_R + I_L)$$

Figure 12 shows a typical connection of the AD1580BRT operating at a minimum of 100  $\mu\text{A}$ . This connection can provide  $\pm 1 \text{ mA}$  to the load while accommodating  $\pm 10\%$  power supply variations.

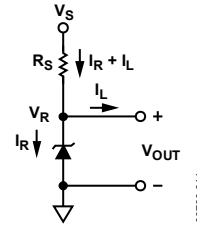

Figure 11. Typical Connection Diagram

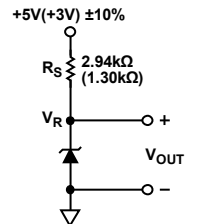

Figure 12. Typical Connection Diagram

### TEMPERATURE PERFORMANCE

The AD1580 is designed for reference applications where stable temperature performance is important. Extensive temperature testing and characterization ensure that the device's performance is maintained over the specified temperature range.

Some confusion exists in the area of defining and specifying reference voltage error over temperature. Historically, references have been characterized using a maximum deviation per degree Celsius, for example, 50 ppm/ $^\circ\text{C}$ . However, because of nonlinearities in temperature characteristics that originated in standard Zener references (such as S type characteristics), most manufacturers now use a maximum limit error band approach to specify devices. This technique involves the measurement of the output at three or more different temperatures to guarantee that the voltage falls within the given error band. The proprietary curvature correction design techniques used to minimize the AD1580 nonlinearities allow the temperature performance to be guaranteed using the maximum deviation method. This method is of more use to a designer than the one that simply guarantees the maximum error band over the entire temperature change.

Figure 13 shows a typical output voltage drift for the AD1580 and illustrates the methodology. The maximum slope of the two diagonals drawn from the initial output value at  $+25^\circ\text{C}$  to the output values at  $+85^\circ\text{C}$  and  $-40^\circ\text{C}$  determines the performance grade of the device. For a given grade of the AD1580, the designer can easily determine the maximum total error from the initial tolerance plus temperature variation.

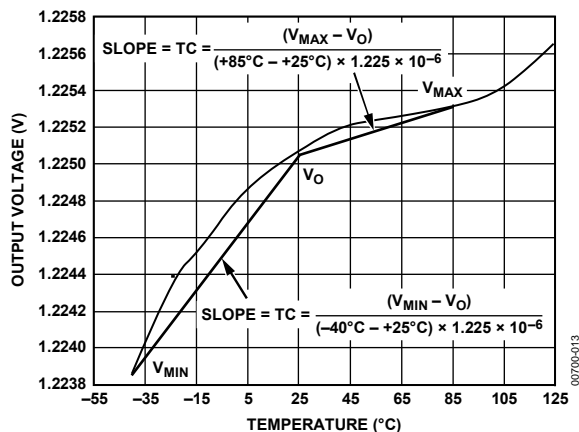

Figure 13. Output Voltage vs. Temperature

For example, the AD1580BRT initial tolerance is  $\pm 1$  mV; a  $\pm 50$  ppm/ $^{\circ}\text{C}$  temperature coefficient corresponds to an error band of  $\pm 4$  mV ( $50 \times 10^{-6} \times 1.225 \text{ V} \times 65^{\circ}\text{C}$ ). Thus, the unit is guaranteed to be  $1.225 \text{ V} \pm 5 \text{ mV}$  over the operating temperature range.

Duplication of these results requires a combination of high accuracy and stable temperature control in a test system. Evaluation of the AD1580 produces a curve similar to that in Figure 5 and Figure 13.

### VOLTAGE OUTPUT NONLINEARITY vs. TEMPERATURE

When a reference is used with data converters, it is important to understand how temperature drift affects the overall converter performance. The nonlinearity of the reference output drift represents an additional error that is not easily calibrated out of the system. This characteristic (see Figure 14) is generated by normalizing the measured drift characteristic to the end point average drift. The residual drift error of approximately 500 ppm shows that the AD1580 is compatible with systems that require 10-bit accurate temperature performance.

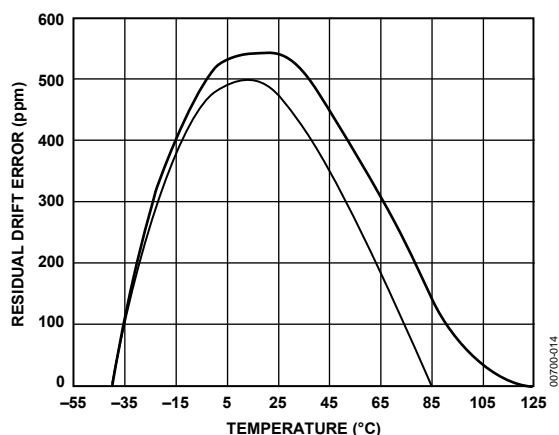

Figure 14. Residual Drift Error

### REVERSE VOLTAGE HYSTERESIS

A major requirement for high performance industrial equipment manufacturers is a consistent output voltage at nominal temperature following operation over the operating temperature range. This characteristic is generated by measuring the difference between the output voltage at  $+25^{\circ}\text{C}$  after operation at  $+85^{\circ}\text{C}$  and the output, at  $+25^{\circ}\text{C}$  after operation at  $-40^{\circ}\text{C}$ . Figure 15 displays the hysteresis associated with the AD1580. This characteristic exists in all references and has been minimized in the AD1580.

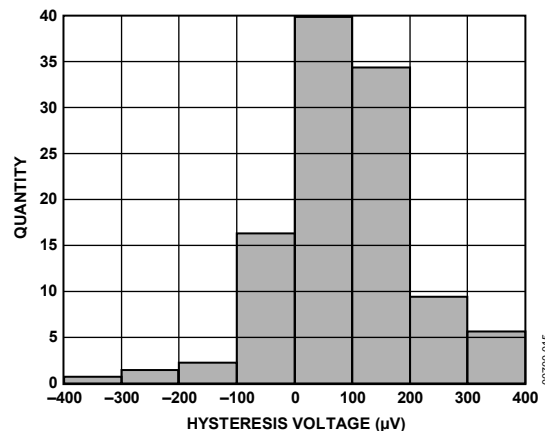

Figure 15. Reverse Voltage Hysteresis Distribution

### OUTPUT IMPEDANCE vs. FREQUENCY

Understanding the effect of the reverse dynamic output impedance in a practical application may be important to successfully apply the AD1580. A voltage divider is formed by the AD1580 output impedance and the external source impedance. When an external source resistor of about  $30 \text{ k}\Omega$  ( $I_R = 100 \mu\text{A}$ ) is used, 1% of the noise from a 100 kHz switching power supply is developed at the output of the AD1580. Figure 16 shows how a  $1 \mu\text{F}$  load capacitor connected directly across the AD1580 reduces the effect of power supply noise to less than 0.01%.

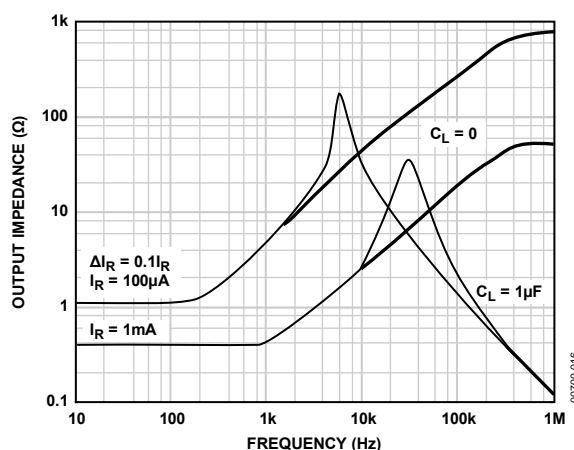

Figure 16. Output Impedance vs. Frequency

## NOISE PERFORMANCE AND REDUCTION

The noise generated by the AD1580 is typically less than  $5\ \mu\text{V}$  p-p over the 0.1 Hz to 10 Hz band. Figure 17 shows the 0.1 Hz to 10 Hz noise of a typical AD1580. Noise in a 10 Hz to 10 kHz bandwidth is approximately  $20\ \mu\text{V}$  rms (see Figure 18a). If further noise reduction is desired, a 1-pole low-pass filter can be added between the output pin and ground. A time constant of 0.2 ms has a  $-3\ \text{dB}$  point at about 800 Hz and reduces the high frequency noise to about  $6.5\ \mu\text{V}$  rms (see Figure 18b). A time constant of 960 ms has a  $-3\ \text{dB}$  point at 165 Hz and reduces the high frequency noise to about  $2.9\ \mu\text{V}$  rms (see Figure 18c).

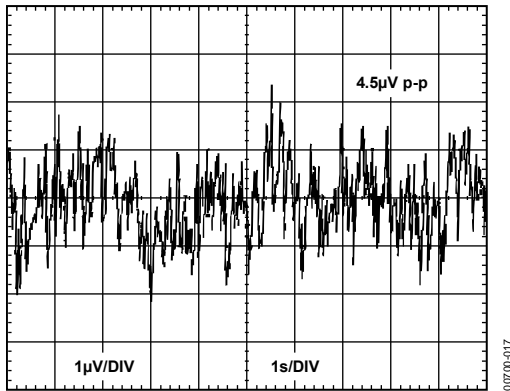

Figure 17. 0.1 Hz to 10 Hz Voltage Noise

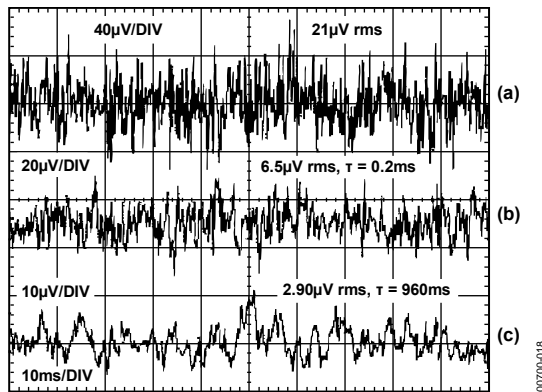

Figure 18. Total RMS Noise

## TURN-ON TIME

Many low power instrument manufacturers are becoming increasingly concerned with the turn-on characteristics of components being used in their systems. Fast turn-on components often enable the end user to keep power off when not needed, and yet those components respond quickly when the power is turned on for operation. Figure 19 displays the turn-on characteristic of the AD1580.

Upon application of power (cold start), the time required for the output voltage to reach its final value within a specified error is the turn-on settling time. Two components normally associated with this are time for active circuits to settle and time for thermal gradients on the chip to stabilize. This characteristic is generated from cold start operation and represents the true turn-on waveform after power-up. Figure 21 shows both the coarse and fine turn-on settling characteristics of the device; the total settling time to within 1.0 mV is about  $6\ \mu\text{s}$ , and there is no long thermal tail when the horizontal scale is expanded to 2 ms/div.

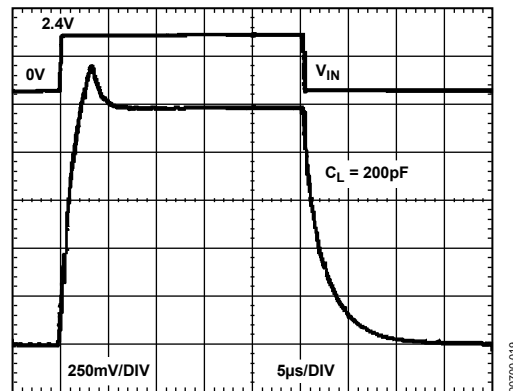

Figure 19. Turn-On Response Time

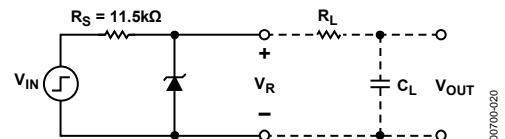

Figure 20. Turn-On, Settling, and Transient Test Circuit

Output turn-on time is modified when an external noise reduction filter is used. When present, the time constant of the filter dominates overall settling.

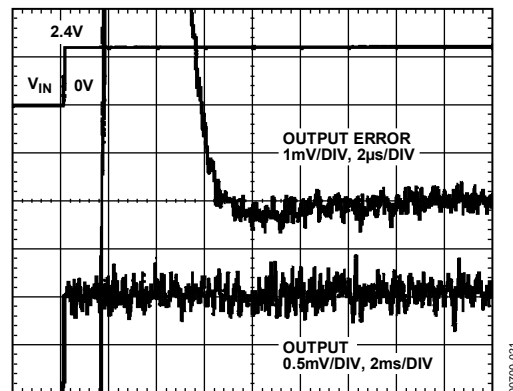

Figure 21. Turn-On Settling



### TRANSIENT RESPONSE

Many ADC and DAC converters present transient current loads to the reference. Poor reference response can degrade the converter's performance.

Figure 22 displays both the coarse and fine settling characteristics of the device to load transients of  $\pm 50 \mu\text{A}$ .

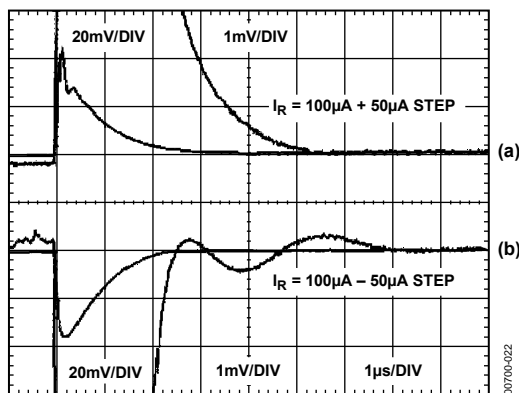

Figure 22. Transient Settling

Figure 22a shows the settling characteristics of the device for an increased reverse current of  $50 \mu\text{A}$ . Figure 22b shows the response when the reverse current is decreased by  $50 \mu\text{A}$ . The transients settle to  $1 \text{ mV}$  in about  $3 \mu\text{s}$ .

Attempts to drive a large capacitive load (in excess of  $1000 \text{ pF}$ ) may result in ringing, as shown in the step response (see Figure 23). This is due to the additional poles formed by the load capacitance and the output impedance of the reference. A recommended method of driving capacitive loads of this magnitude is shown in Figure 20. A resistor isolates the capacitive load from the output stage, while the capacitor provides a single-pole low-pass filter and lowers the output noise.

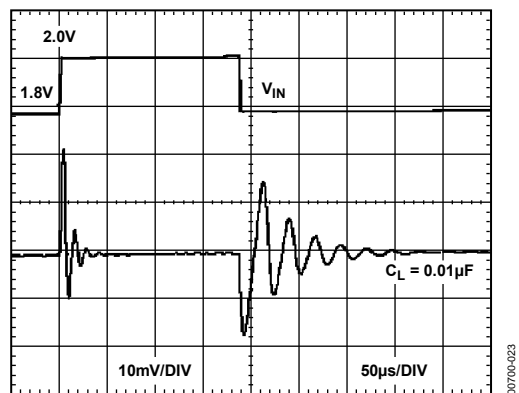

Figure 23. Transient Response with Capacitive Load

### PRECISION MICROPOWER LOW DROPOUT REFERENCE

The circuit in Figure 24 provides an ideal solution for making a stable voltage reference with low standby power consumption, low input/output dropout capability, and minimum noise output. The amplifier both buffers and optionally scales up the AD1580 output voltage,  $V_R$ . Output voltages as high as  $2.1 \text{ V}$  can supply  $1 \text{ mA}$  of load current. A one-pole filter connected between the AD1580 and the OP193 input can be used to achieve low output noise. The nominal quiescent power consumption is  $200 \mu\text{W}$ .

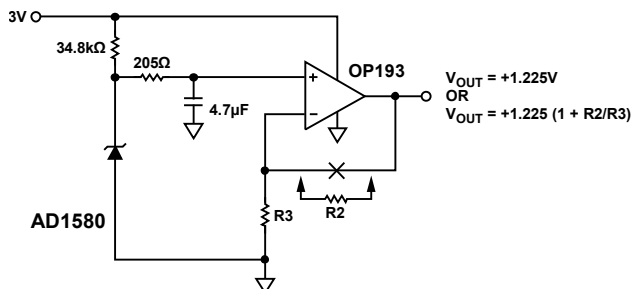

Figure 24. Micropower Buffered Reference

### USING THE AD1580 WITH 3 V DATA CONVERTERS

The AD1580 low output drift ( $50 \text{ ppm}/^\circ\text{C}$ ) and compact subminiature SOT-23 package make it ideally suited for today's high performance converters in space critical applications.

One family of ADCs for which the AD1580 is well suited is the AD7714-3 and AD7715-3. The AD7714/AD7715 are charge-balancing ( $\Sigma\text{-}\Delta$ ) ADCs with on-chip digital filtering intended for the measurement of wide dynamic range, low frequency signals such as those representing chemical, physical, or biological processes. Figure 25 shows the AD1580 connected to the AD7714-3/AD7715-3 for  $3 \text{ V}$  operation.

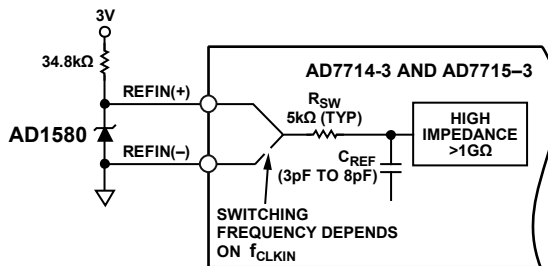
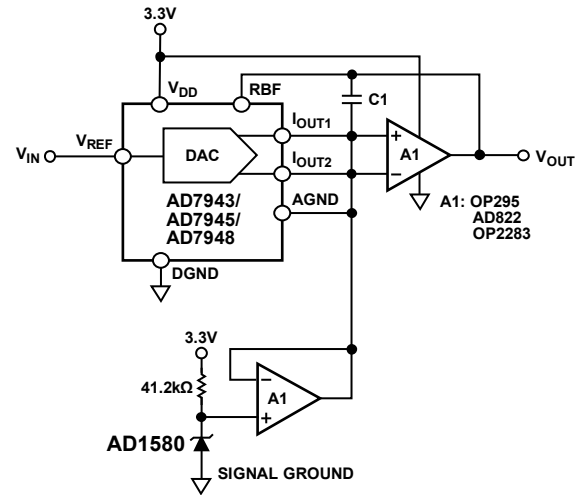

Figure 25. Reference Circuit for the AD7714-3 and AD7715-3

# AD1580

The AD1580 is ideal for creating the reference level to use with 12-bit multiplying DACs, such as the AD7943, AD7945, and AD7948. In the single-supply bias mode (see Figure 26), the impedance seen looking into the  $I_{OUT2}$  terminal changes with DAC code. If the AD1580 drives  $I_{OUT2}$  and AGND directly, less than 0.2 LSBs of additional linearity error results. The buffer amp eliminates any linearity degradation that could result from variations in the reference level.



00700-026



# AD1580

## ORDERING GUIDE

| Model                         | Temperature Range | Initial Output Error | Temperature Coefficient | Package Description | Package Option | Branding |
|-------------------------------|-------------------|----------------------|-------------------------|---------------------|----------------|----------|
| AD1580ART-R2                  | -40°C to +85°C    | 10 mV                | 100 ppm/°C              | 3-Lead SOT-23-3     | RT-3           | 0Axx     |
| AD1580ART-REEL                | -40°C to +85°C    | 10 mV                | 100 ppm/°C              | 3-Lead SOT-23-3     | RT-3           | 0Axx     |
| AD1580ART-REEL7               | -40°C to +85°C    | 10 mV                | 100 ppm/°C              | 3-Lead SOT-23-3     | RT-3           | 0Axx     |
| AD1580ARTZ-REEL <sup>1</sup>  | -40°C to +85°C    | 10 mV                | 100 ppm/°C              | 3-Lead SOT-23-3     | RT-3           | R0Y      |
| AD1580ARTZ-REEL7 <sup>1</sup> | -40°C to +85°C    | 10 mV                | 100 ppm/°C              | 3-Lead SOT-23-3     | RT-3           | R0Y      |
| AD1580BRT-R2                  | -40°C to +85°C    | 1 mV                 | 50 ppm/°C               | 3-Lead SOT-23-3     | RT-3           | 0Bxx     |
| AD1580BRT-REEL7               | -40°C to +85°C    | 1 mV                 | 50 ppm/°C               | 3-Lead SOT-23-3     | RT-3           | 0Bxx     |
| AD1580BRTZ-R2 <sup>1</sup>    | -40°C to +85°C    | 1 mV                 | 50 ppm/°C               | 3-Lead SOT-23-3     | RT-3           | 0Bxx     |
| AD1580BRTZ-REEL7 <sup>1</sup> | -40°C to +85°C    | 1 mV                 | 50 ppm/°C               | 3-Lead SOT-23-3     | RT-3           | R2E      |
| AD1580BKSZ-REEL <sup>1</sup>  | -40°C to +85°C    | 2.5 mV               | 50 ppm/°C               | 3-Lead SC70         | KS-3           | R2E      |
| AD1580BKSZ-REEL7 <sup>1</sup> | -40°C to +85°C    | 2.5 mV               | 50 ppm/°C               | 3-Lead SC70         | KS-3           | R2E      |

<sup>1</sup> Z = RoHS Compliant Part.

## PACKAGE BRANDING INFORMATION

In the SOT-23 package (RT), four marking fields identify the device generic, grade, and date of processing.

The first field is the product identifier. A 0 identifies the generic as the AD1580.

The second field indicates the device grade: A or B.

In the third field, a numeral or letter indicates a calendar year: 5 for 1995, A for 2001.

In the fourth field, letters A through Z represent a two-week window within the calendar year, starting with A for the first two weeks of January.