

MAXIM

DS26900 Demo Kit

General Description

The DS26900 design kit provides a convenient platform to evaluate the DS26900. Connectors are provided to access all of the master and secondary JTAG ports. Jumpers allow configuration of all the DS26900 operating modes, and LEDs provide visual indication of device states.

This document is intended to be used along with the DS26900 data sheet, available online at www.maxim-ic.com/DS26900.

Features

- ◆ Ribbon Cable Connectors for Master and Secondary JTAG Port Connections
- ◆ Jumpers for Device Configuration
- ◆ LEDs for Device State Outputs
- ◆ Simple Power Connections

Ordering Information

PART	DESCRIPTION
DS26900DK	Demo kit for DS26900

DS26900 Demo Kit Layout

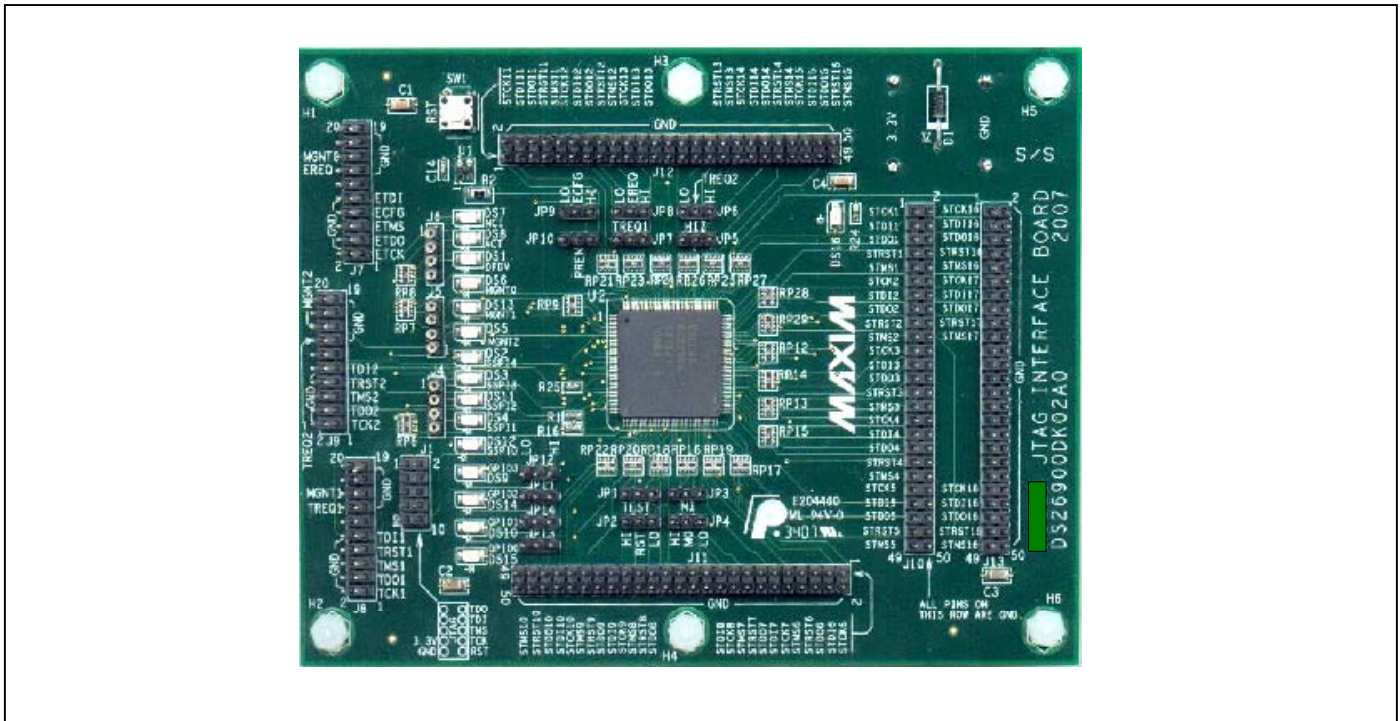

Table of Contents

1.	DS26900 DEMO KIT PCB LAYOUT	4
2.	OPERATION	5
3.	DS26900DK CONNECTORS, JUMPERS, AND INDICATORS.....	5
3.1	POWER	5
3.2	RESET	5
3.3	DEVICE STATUS OUTPUTS	5
3.3.1	Selected Secondary Port Indication	5
3.3.2	MGNT2–MGNT0	6
3.3.3	DPDV, \overline{MCI} , and \overline{ACT}	6
3.4	JTAG PORT CONNECTIONS.....	6
3.4.1	JTAG Master Connectors Pinouts	7
3.4.2	JTAG Secondary Port Connections	8
3.5	JUMPERS AND INDICATORS	9
4.	SAMPLE SETUP	10
4.1	CONFIGURE DEVICE	10
4.2	SELECT MASTER PORT.....	10
5.	ADDITIONAL INFORMATION/RESOURCES.....	11
5.1	DS26900 INFORMATION.....	11
5.2	DS26900DK INFORMATION.....	11
5.3	TECHNICAL SUPPORT	11
6.	SCHEMATICS	11
7.	DOCUMENT REVISION HISTORY	12

List of Figures

Figure 1-1. DS26900 Demo Kit Board Floorplan.....	4
---	---

List of Tables

Table 3-1. Power Connections	5
Table 3-2. $\overline{\text{SSPI4}}$ – $\overline{\text{SSPI0}}$ Connections	6
Table 3-3. $\overline{\text{MGNT0}}$ – $\overline{\text{MGNT2}}$ Connections	6
Table 3-4. $\overline{\text{DPDV}}$, $\overline{\text{MCI}}$, and $\overline{\text{ACT}}$ Connections.....	6
Table 3-5. JTAG Master Port Connectors	6
Table 3-6. J7, J8, and J9 Master Port Connector Pinouts.....	7
Table 3-7. Secondary Port Connections.....	8
Table 3-8. Jumpers.....	9
Table 3-9. LED Indicators	9
Table 4-1. Jumper Settings for Single Package Mode of Operation	10
Table 4-2. Using External Test Master as the Master Port	10
Table 4-3. Using Test Master 1 as the master port	10
Table 4-4. Using Test Master 2 as the Master Port.....	10

1. DS26900 Demo Kit PCB Layout

Figure 1-1 shows the location of the master and secondary JTAG ports, jumpers, power connectors, and reset switch.

Figure 1-1. DS26900 Demo Kit Board Floorplan

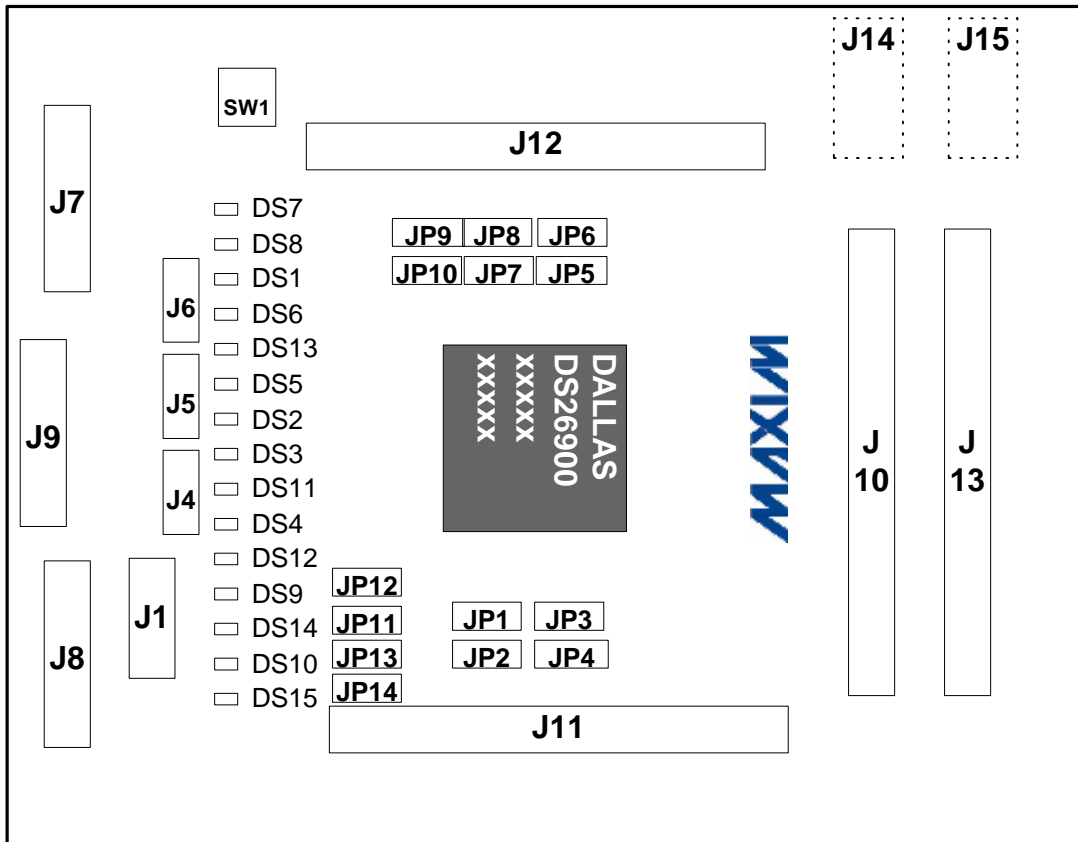

2. Operation

The simplest configuration to test for communication with the DS26900 demo kit is to connect a JTAG source to master port 1, connect power, and, using JTAG sequences, manipulate some of the device state output LEDs on the board. The SSPIx LEDs can be used to verify that the desired secondary port is being selected. The GPIOx LEDs can be observed to verify that the GPIO pins are being correctly selected. See Section 4 for the basic setup.

3. DS26900DK Connectors, Jumpers, and Indicators

See Figure 1-1 for location of connectors, switches, jumpers, and LED indicators described in this section. Refer to the DS26900 data sheet for a complete explanation of these device functions.

3.1 Power

The DS26900 demo kit is powered from a 3.3V supply. Two banana-type connectors are provided on the backside of the board, one for +3.3V and one for ground. See Table 3-3.

Table 3-1. Power Connections

CONNECTOR	FUNCTION
J14	+3.3V
J15	Ground

3.2 Reset

The reset pushbutton (SW1) controls the DS26900's \overline{RST} input. Pushing this button provides an asynchronous reset for all the global registers and logic in the DS26900.

3.3 Device Status Outputs

The status of the following signals can be observed through LEDs on the board. Additionally, connectors J4, J5, and J6 are provided to make electrical connection for driving off-board circuitry.

3.3.1 Selected Secondary Port Indication

$\overline{SSPI4}$ – $\overline{SSPI0}$ provide a binary indication as to which secondary port is currently selected in the manner described below.

```

4 3 2 1 0
1 1 1 1 1 = No secondary port selected
1 1 1 1 0 = Secondary port 1 selected
.
.
.
0 1 1 0 1 = Secondary port 18 selected

```

Table 3-2. $\overline{\text{SSPI4}}$ – $\overline{\text{SSPI0}}$ Connections

CONNECTOR	FUNCTION
J6 - 4	$\overline{\text{SSPI4}}$
J4 - 1	$\overline{\text{SSPI3}}$
J4 - 2	$\overline{\text{SSPI2}}$
J4 - 3	$\overline{\text{SSPI1}}$
J4 - 4	$\overline{\text{SSPI0}}$

3.3.2 $\overline{\text{MGNT2}}$ – $\overline{\text{MGNT0}}$

The $\overline{\text{MGNT2}}$ – $\overline{\text{MGNT0}}$ outputs provide an indication as to which master port currently has control of the device as shown in [Table 3-3](#).

Table 3-3. $\overline{\text{MGNT0}}$ – $\overline{\text{MGNT2}}$ Connections

CONNECTOR	FUNCTION
J5 - 3	$\overline{\text{MGNT2}}$
J5 - 2	$\overline{\text{MGNT1}}$
J5 - 1	$\overline{\text{MGNT0}}$

3.3.3 $\overline{\text{DPDV}}$, $\overline{\text{MCI}}$, and $\overline{\text{ACT}}$

The signals $\overline{\text{DPDV}}$, $\overline{\text{MCI}}$, and $\overline{\text{ACT}}$ provide indications of various device states as shown in [Table 3-4](#).

Table 3-4. $\overline{\text{DPDV}}$, $\overline{\text{MCI}}$, and $\overline{\text{ACT}}$ Connections

CONNECTOR	FUNCTION
J6 - 1	$\overline{\text{MCI}}$: LED ON when more than one of the $\overline{\text{EREQ}}$, $\overline{\text{TMREQ1}}$, or $\overline{\text{TMREQ2}}$ signals is asserted low.
J6 - 2	$\overline{\text{ACT}}$: LED ON when active. Active state is determined by the MSB of the instruction code and the state of the mode input pins M0 and M1, and the presence of an active master.
J6 - 3	$\overline{\text{DPDV}}$: LED ON when the $\overline{\text{DPDV}}$ bit in the Device Configuration register is set = 1.

3.4 JTAG Port Connections

Table 3-5. JTAG Master Port Connectors

CONNECTOR	FUNCTION (MicroTCA™ JSM NOMENCLATURE)
J7	MASTER 3 (Extended Test Master)
J8	MASTER 1 (Test Master 1)
J9	MASTER 2 (Test Master 2)
J10	SECONDARY PORTS 1–5
J11	SECONDARY PORTS 6–10
J12	SECONDARY PORTS 11–15
J13	SECONDARY PORTS 16–18

MicroTCA is a trademark of of PICMG-PCI Industrial Computer Manufacturers Group, Inc.

3.4.1 JTAG Master Connectors Pinouts

Connectors J7, J8, and J9 interface to the DS26900's three master ports. Some signals available at these connectors can be controlled dynamically from the connector or from jumpers. [Table 3-6](#) indicates which signals have alternate jumpers. When driving a signal from the master port connectors the jumper can be removed or placed in a pullup or pulldown position determined by the method of driving the signal.

Table 3-6. J7, J8, and J9 Master Port Connector Pinouts

PIN	J7 EXTENDED TEST MASTER		J8 TEST MASTER 1		J9 TEST MASTER 2	
	SIGNAL	I/O	SIGNAL	I/O	SIGNAL	I/O
1	ETCK	I	TCK1	I	TCK2	I
2	GND	—	GND	—	GND	—
3	ETDO	0	TDO1	0	TDO2	0
4	GND	—	GND	—	GND	—
5	ETMS	I	TMS1	I	TMS2	I
6	GND	—	GND	—	GND	—
7	$\overline{\text{ECFG}}$ *	I	$\overline{\text{TRST1}}$	I	$\overline{\text{TRST2}}$	I
8	GND	—	GND	—	GND	—
9	ETDI	I	TDI1	I	TDI2	I
10	GND	—	GND	—	GND	—
11	N.C.	—	N.C.	—	N.C.	—
12	N.C.	—	N.C.	—	N.C.	—
13	GND	—	GND	—	GND	—
14	$\overline{\text{EREQ}}$ *	I	$\overline{\text{TMREQ1}}$ *	I	$\overline{\text{TMREQ2}}$ *	I
15	GND	—	GND	—	GND	—
16	$\overline{\text{MGNT0}}$	0	$\overline{\text{MGNT1}}$	0	$\overline{\text{MGNT2}}$	0
17	GND	—	GND	—	GND	—
18	N.C.	—	N.C.	—	N.C.	—
19	GND	—	GND	—	GND	—
20	N.C.	—	N.C.	—	N.C.	—

* Indicates that a jumper option is available for this signal.

3.4.2 JTAG Secondary Port Connections

Table 3-7. Secondary Port Connections

PORT	CONNECTOR	SIGNALS	PIN	PORT	CONNECTOR	SIGNALS	PIN
1	J10	STCK1	1	10	J11	STCK10	41
		STDI1	3			STDI10	43
		STDO1	5			STDO10	45
		STRST1	7			STRST10	47
		STMS1	9			STMS10	49
2	J10	STCK2	11	11	J12	STCK11	1
		STDI2	13			STDI11	3
		STDO2	15			STDO11	5
		STRST2	17			STRST11	7
		STMS2	19			STMS11	9
3	J10	STCK3	21	12	J12	STCK12	11
		STDI3	23			STDI12	13
		STDO3	25			STDO12	15
		STRST3	27			STRST12	17
		STMS3	29			STMS12	19
4	J10	STCK4	31	13	J12	STCK13	21
		STDI4	33			STDI13	23
		STDO4	35			STDO13	25
		STRST4	37			STRST13	27
		STMS4	39			STMS13	29
5	J10	STCK5	41	14	J12	STCK14	31
		STDI5	43			STDI14	33
		STDO5	45			STDO14	35
		STRST5	47			STRST14	37
		STMS5	49			STMS14	39
6	J11	STCK6	1	15	J12	STCK15	41
		STDI6	3			STDI15	43
		STDO6	5			STDO15	45
		STRST6	7			STRST15	47
		STMS6	9			STMS15	49
7	J11	STCK7	11	16	J13	STCK16	1
		STDI7	13			STDI16	3
		STDO7	15			STDO16	5
		STRST7	17			STRST16	7
		STMS7	19			STMS16	9
8	J11	STCK8	21	17	J13	STCK17	11
		STDI8	23			STDI17	13
		STDO8	25			STDO17	15
		STRST8	27			STRST17	17
		STMS8	29			STMS17	19
9	J11	STCK9	31	18	J13	STCK18	41
		STDI9	33			STDI18	43
		STDO9	35			STDO18	45
		STRST9	37			STRST18	47
		STMS9	39			STMS18	49

3.5 Jumpers and Indicators

Table 3-8. Jumpers

JUMPER	DEVICE PIN
JP1	TEST
JP2	$\overline{\text{RST}}$
JP3	M[1]
JP4	M[0]
JP5	$\overline{\text{HIZ}}$
JP6	$\overline{\text{TMREQ2}}$
JP7	$\overline{\text{TMREQ1}}$
JP8	$\overline{\text{EREQ}}$
JP9	PREN
JP10	$\overline{\text{ECFG}}$
JP11	GPIO[2]
JP12	GPIO[3]
JP13	GPIO[0]
JP14	GPIO[1]

Table 3-9. LED Indicators

LED	FUNCTION
DS1	DPDV
DS2	$\overline{\text{SSPI4}}$
DS3	$\overline{\text{SSPI3}}$
DS4	$\overline{\text{SSPI1}}$
DS5	$\overline{\text{MGNT2}}$
DS6	MGNT0
DS7	MCI
DS8	ACT
DS9	GPIO[3]
DS10	GPIO[1]
DS11	$\overline{\text{SSPI2}}$
DS12	$\overline{\text{SSPI0}}$
DS13	$\overline{\text{MGNT1}}$
DS14	GPIO[2]
DS15	GPIO[0]
DS16	POWER

4. Sample Setup

4.1 Configure Device

Jumpers are used to configure the basic settings of the device.

Table 4-1. Jumper Settings for Single Package Mode of Operation

JUMPER	SETTING/FUNCTION
JP3, JP4	M[1:0] = 00: Configures device to single package mode
JP10	PREN = 1: Enables internal pull resistors
JP2	$\overline{\text{RST}}$ = 1: Enables switch SW1 to perform reset function
JP1	$\overline{\text{TEST}}$ = 1: Disable factory test mode
JP5	$\overline{\text{HIZ}}$ = 1: Disable output high-impedance mode

4.2 Select Master Port

The following signals can be controlled through jumper settings or from the J7, J8, and J9 master port connectors. If using the signals from the connectors, the jumpers may be removed or configured as pullup or pulldown resistors as needed.

Table 4-2. Using External Test Master as the Master Port

JUMPER	CONNECTOR PIN	SETTING/FUNCTION
JP8	J7 - 14	EREQ = 0: Selects external test master as the master port
JP10	J7 - 7	ECFG = 0: Enables Configuration Mode ECFG = 1: Enables Transparent (normal) Mode

Table 4-3. Using Test Master 1 as the master port

JUMPER	CONNECTOR PIN	SETTING/FUNCTION
JP8	J7 - 14	EREQ = 1: Deselects external test master as the master port
JP7	J8 - 14	TREQ1 = 0: Selects test master 1 as the master port
—	J8 - 7	TRST1 = 0: Enables Configuration Mode TRST1 = 1: Enables Transparent (normal) Mode

Table 4-4. Using Test Master 2 as the Master Port

JUMPER	CONNECTOR PIN	SETTING/FUNCTION
JP8	J7 - 14	EREQ = 1: Deselects external test master as the master port
JP7	J8 - 14	TREQ1 = 1: Deselects test master 1 as the master port
JP6	J9 - 14	TREQ2 = 0: Selects test master 2 as the master port
—	J9 - 7	TRST2 = 0: Enables Configuration Mode TRST2 = 1: Enables Transparent (normal) Mode

5. *Additional Information/Resources*

5.1 *DS26900 Information*

For more information about the DS26900, refer to the DS26900 data sheet at www.maxim-ic.com/DS26900.

5.2 *DS26900DK Information*

For more information about the DS26900DK including software downloads, refer to the DS26900DK Quick View page at www.maxim-ic.com/DS26900DK.

5.3 *Technical Support*

For additional technical support, e-mail your questions to telecom.support@dalsemi.com.

6. *Schematics*

The schematics are featured in the following 11 pages.

7. Document Revision History

REVISION DATE	DESCRIPTION
110107	Initial release.

Rev: 110107

12 of 23

Maxim cannot assume responsibility for use of any circuitry other than circuitry entirely embodied in a Maxim product. No circuit patent licenses are implied. Maxim reserves the right to change the circuitry and specifications without notice at any time.

Maxim Integrated Products, 120 San Gabriel Drive, Sunnyvale, CA 94086 408-737-7600

© 2007 Maxim Integrated Products

MAXIM is a registered trademark of Maxim Integrated Products.

DS26900DK02A0

DS26900 JTAG INTERFACE BOARD

TITLE:

DS26900DK02A2

DATE:

6/14/2007

ENGINEER:

R. SANDOVAL

PAGE:

1/11

8

7

6

5

4

3

2

1

D

C

B

A

D

C

B

A

8

7

6

5

4

3

2

1

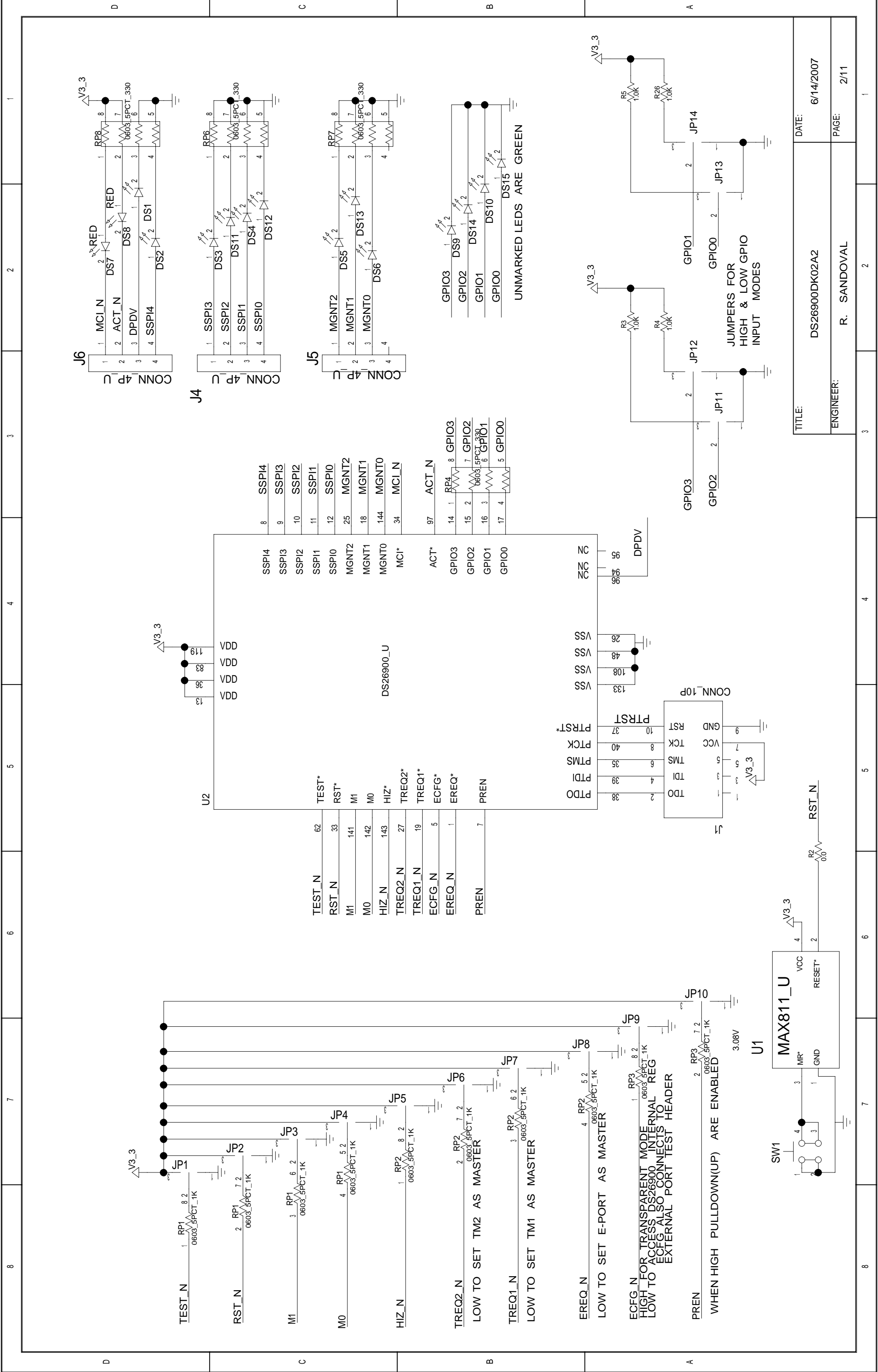

TITLE:	DS26900DK02A2	DATE:	6/14/2007
ENGINEER:	R. SANDOVAL	PAGE:	2/11

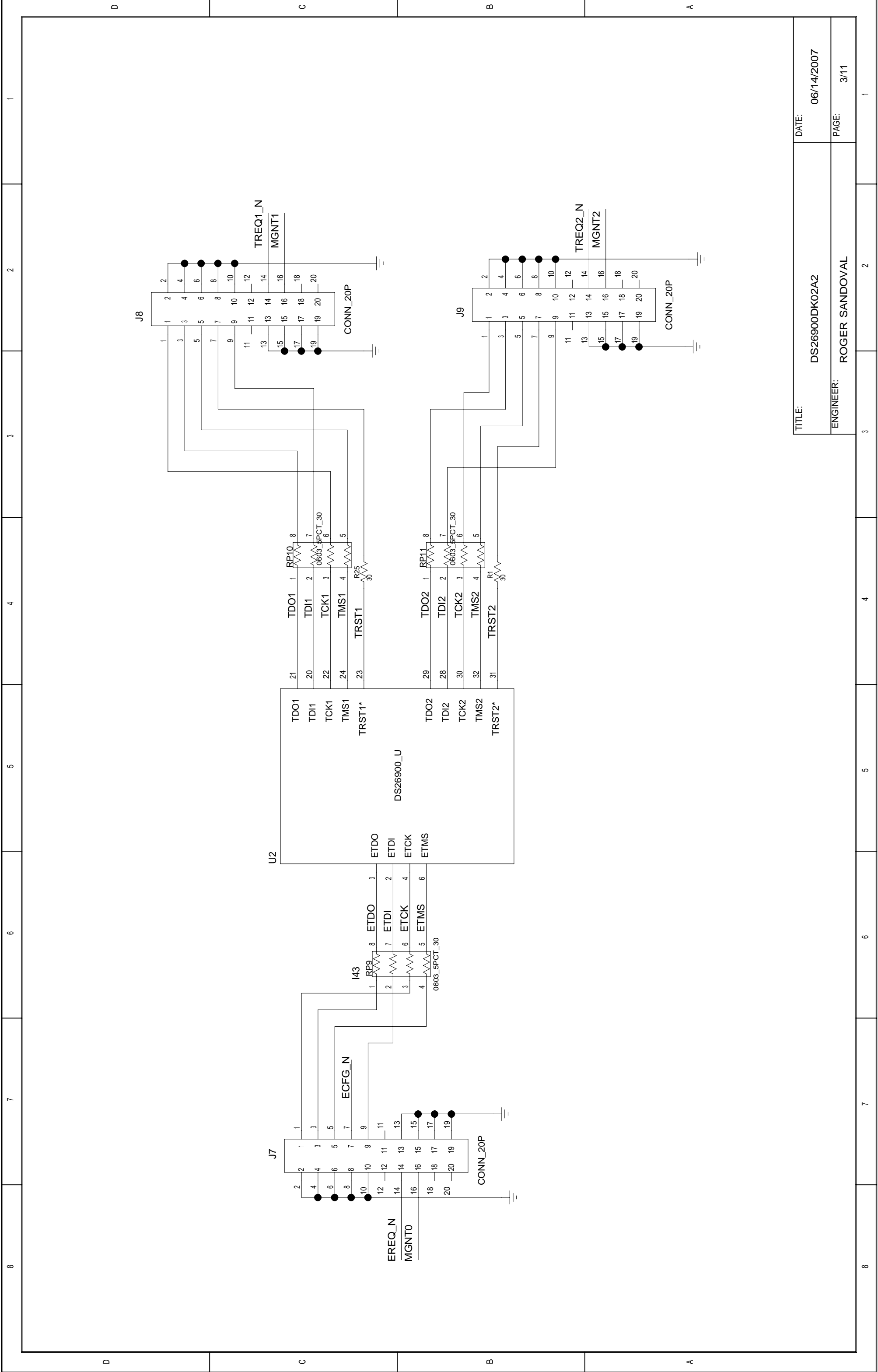

TITLE:	DS26900DK02A2	DATE:	06/14/2007
ENGINEER:	ROGER SANDOVAL	PAGE:	3/11

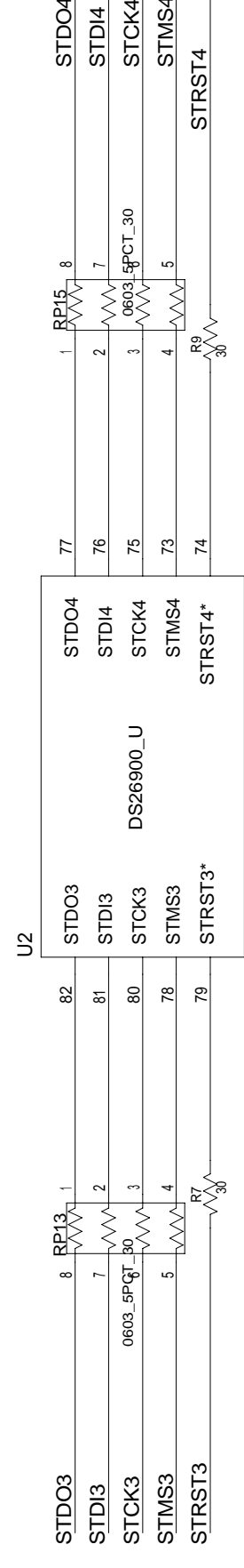
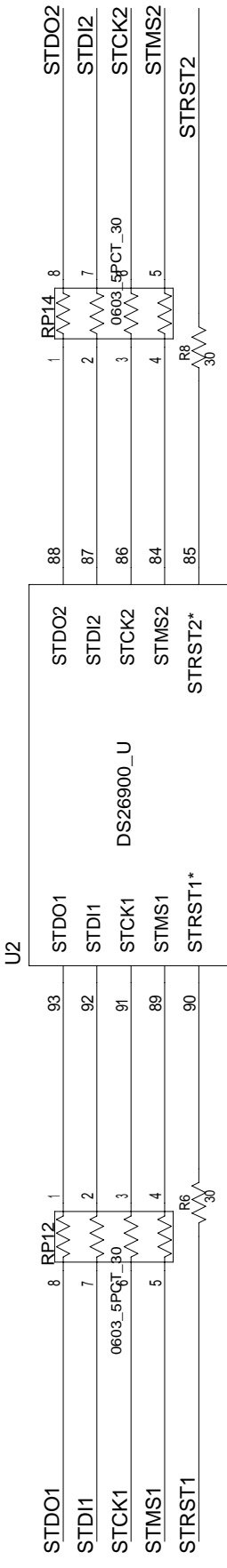

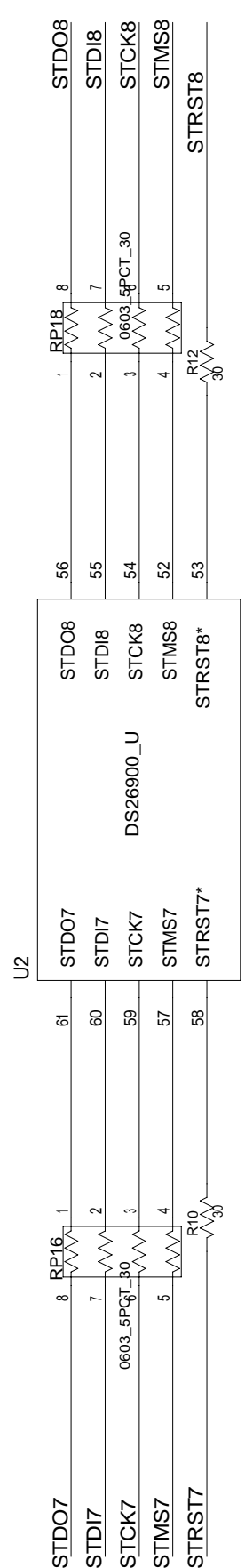
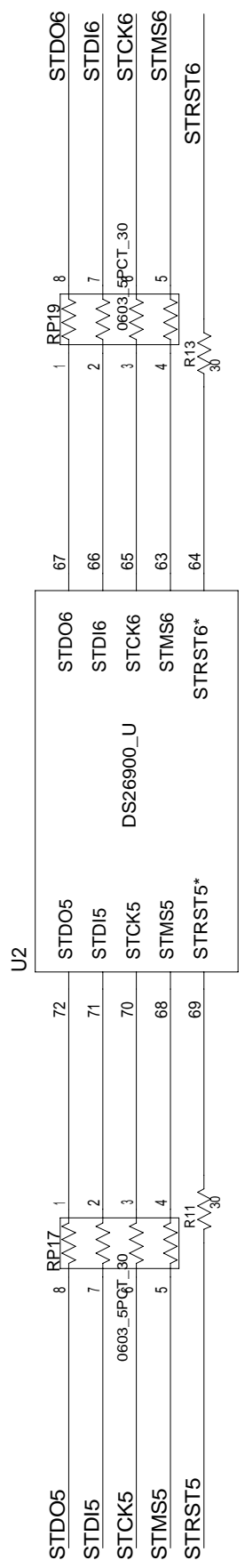
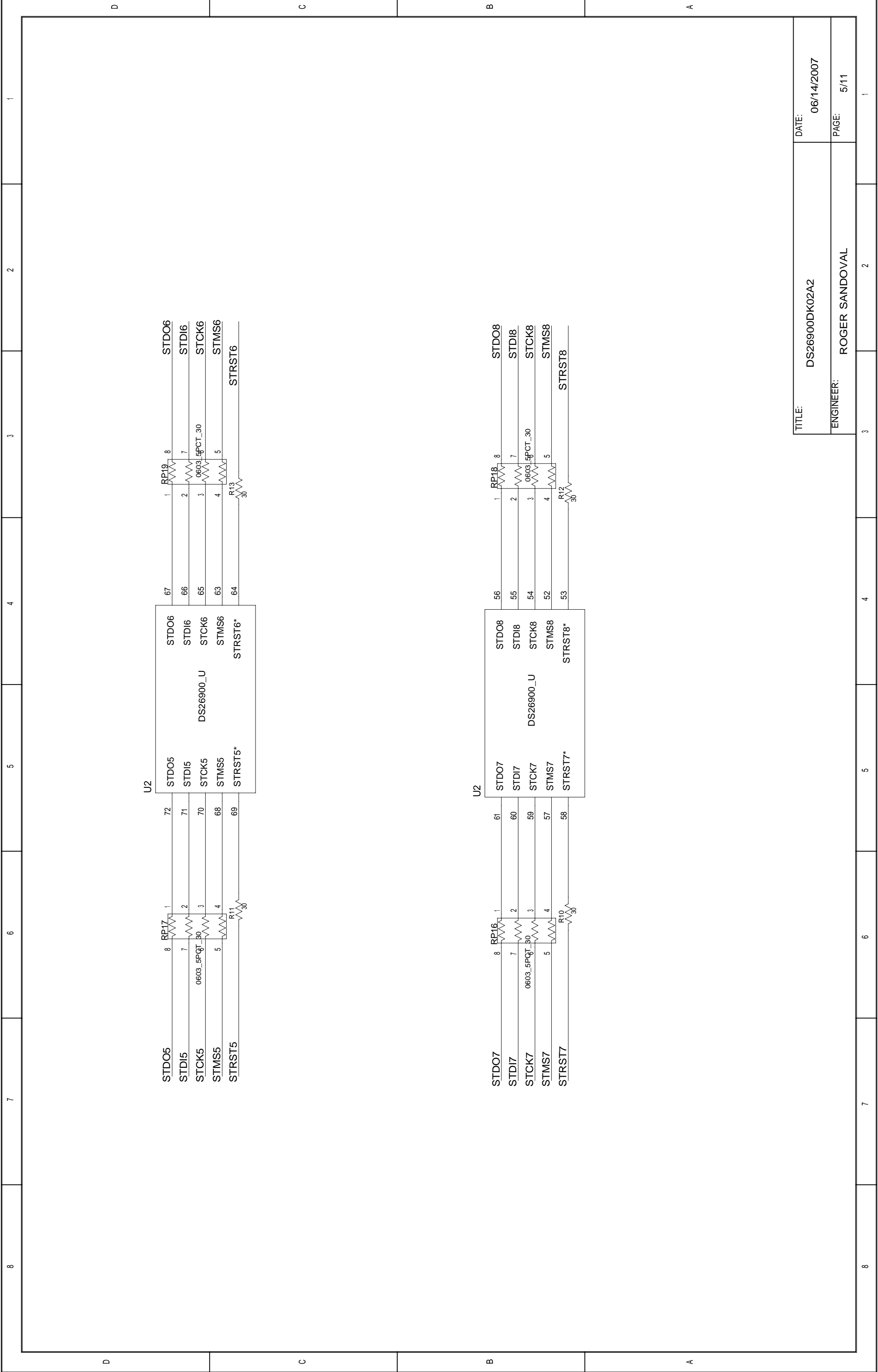

TITLE: DS26900DK02A2

ENGINEER: ROGER SANDOVAL

DATE: 06/14/2007

PAGE: 5/11

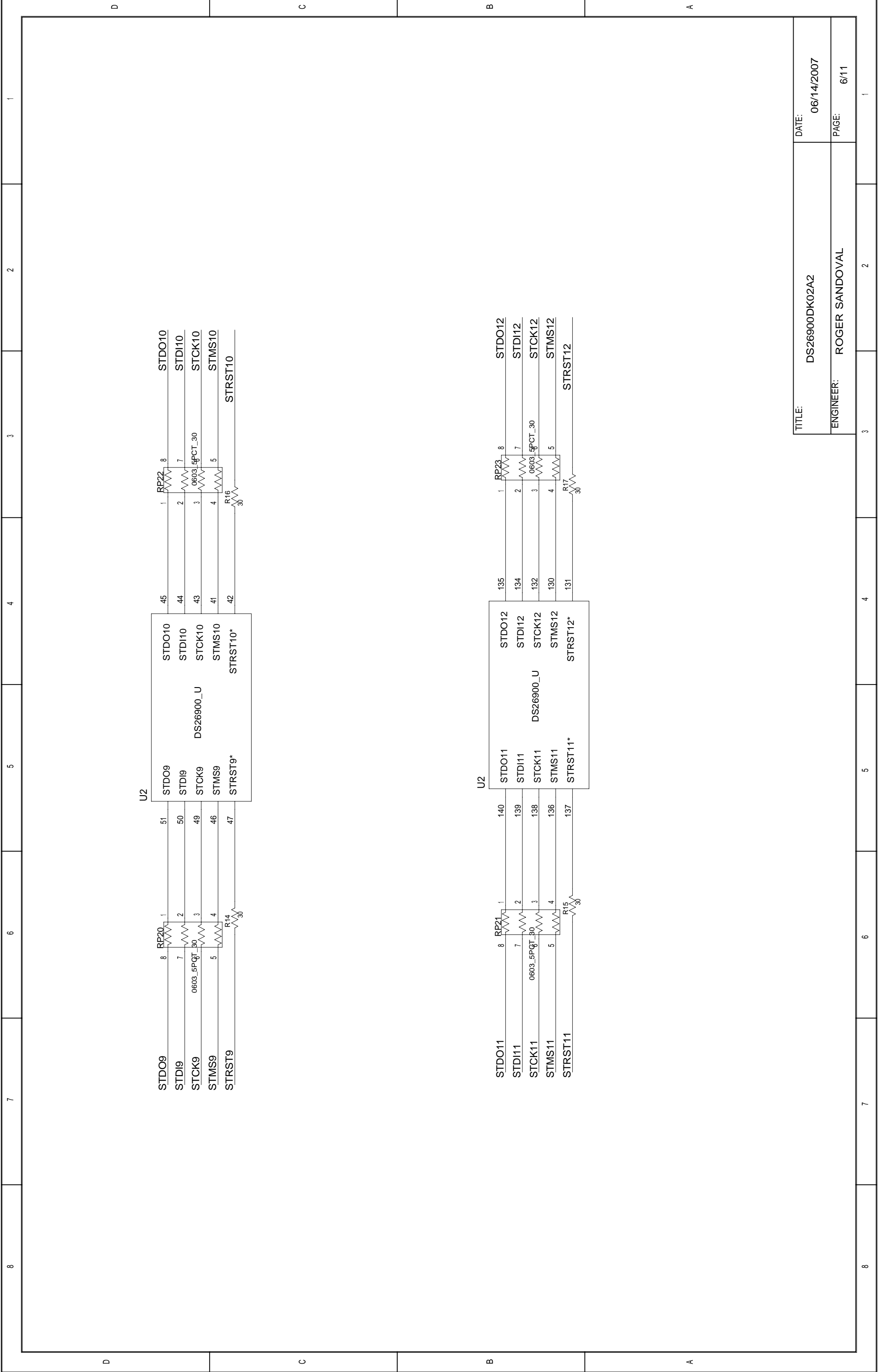

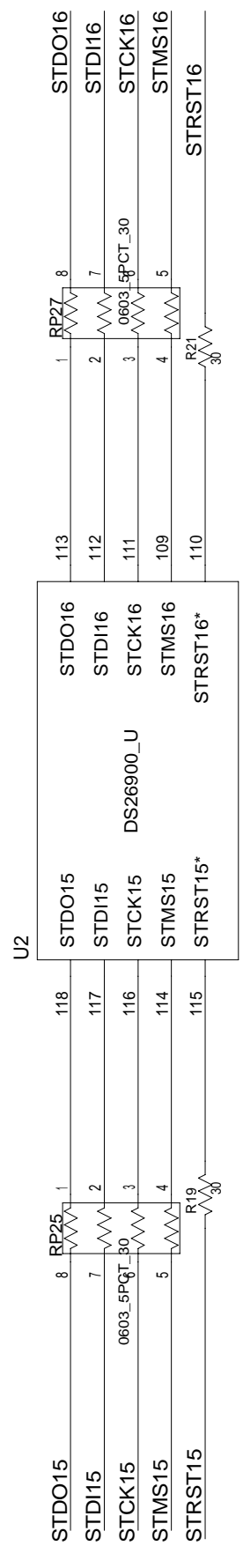
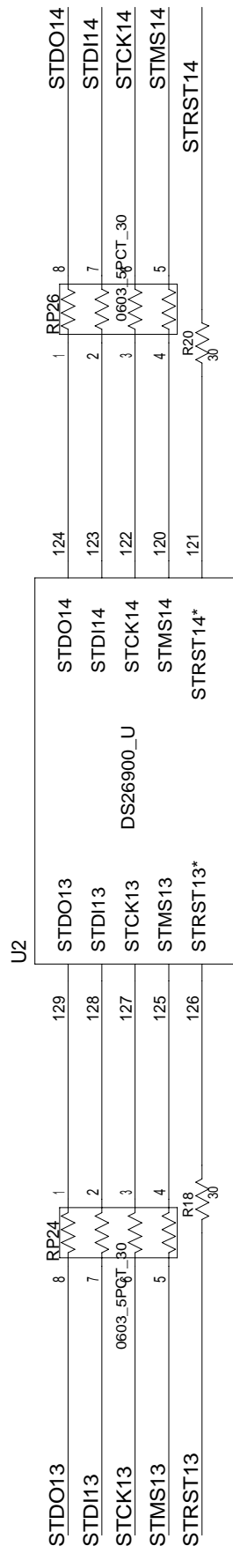
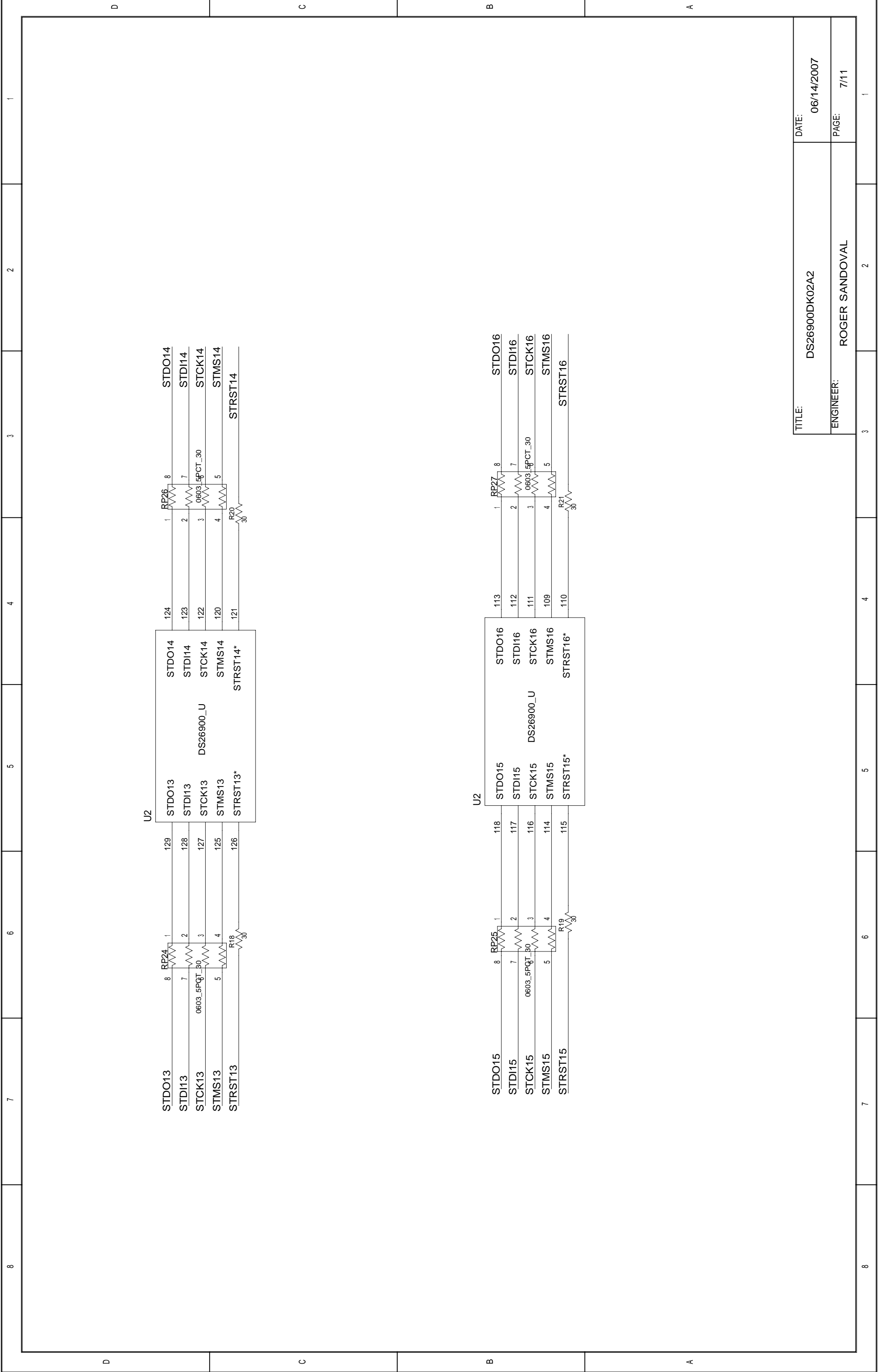

TITLE: DS26900DK02A2

ENGINEER: ROGER SANDOVAL

DATE: 06/14/2007

PAGE: 7/11

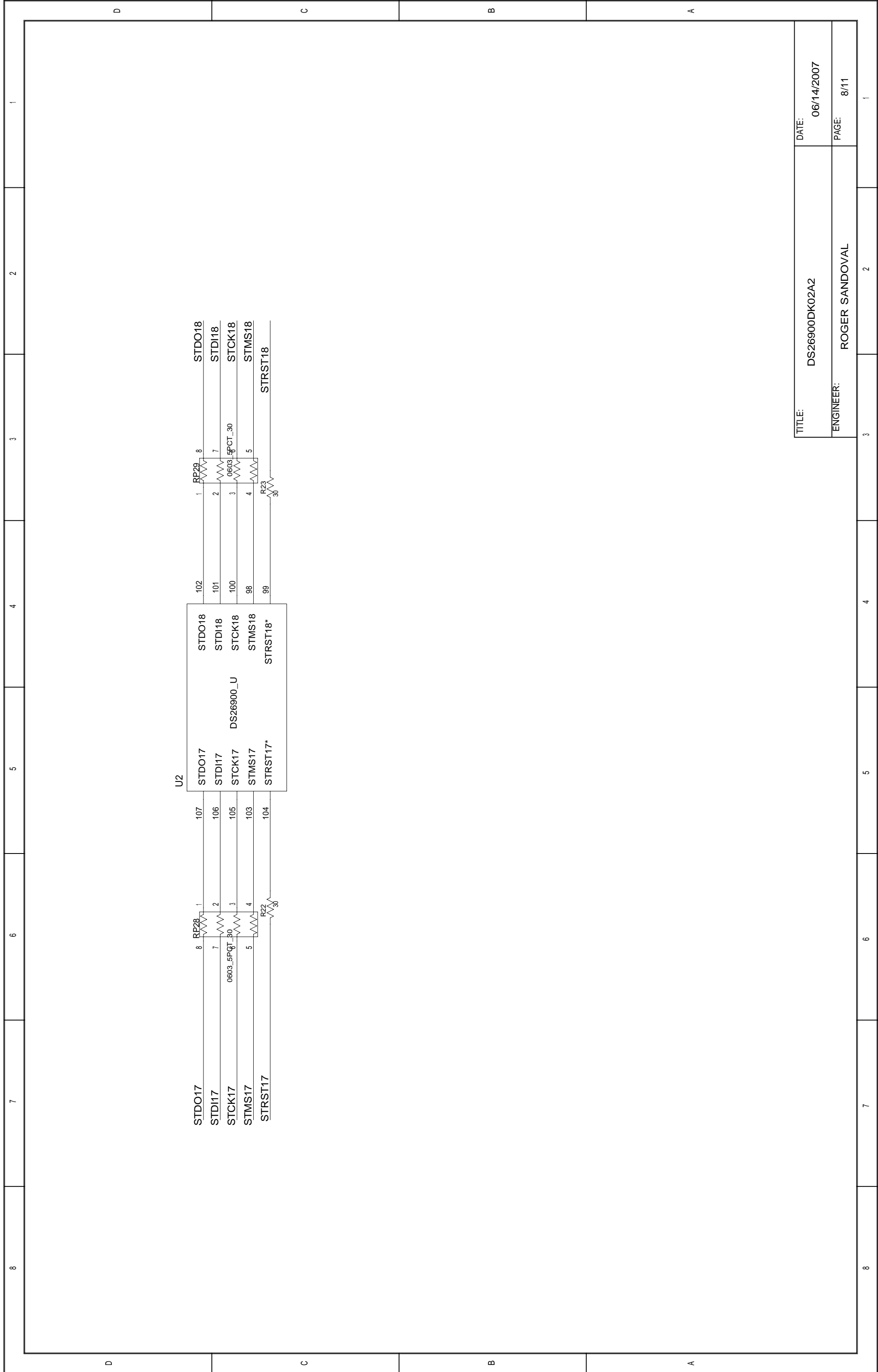

TITLE:	DS26900DK02A2	DATE:	06/14/2007
ENGINEER:	ROGER SANDOVAL	PAGE:	8/11

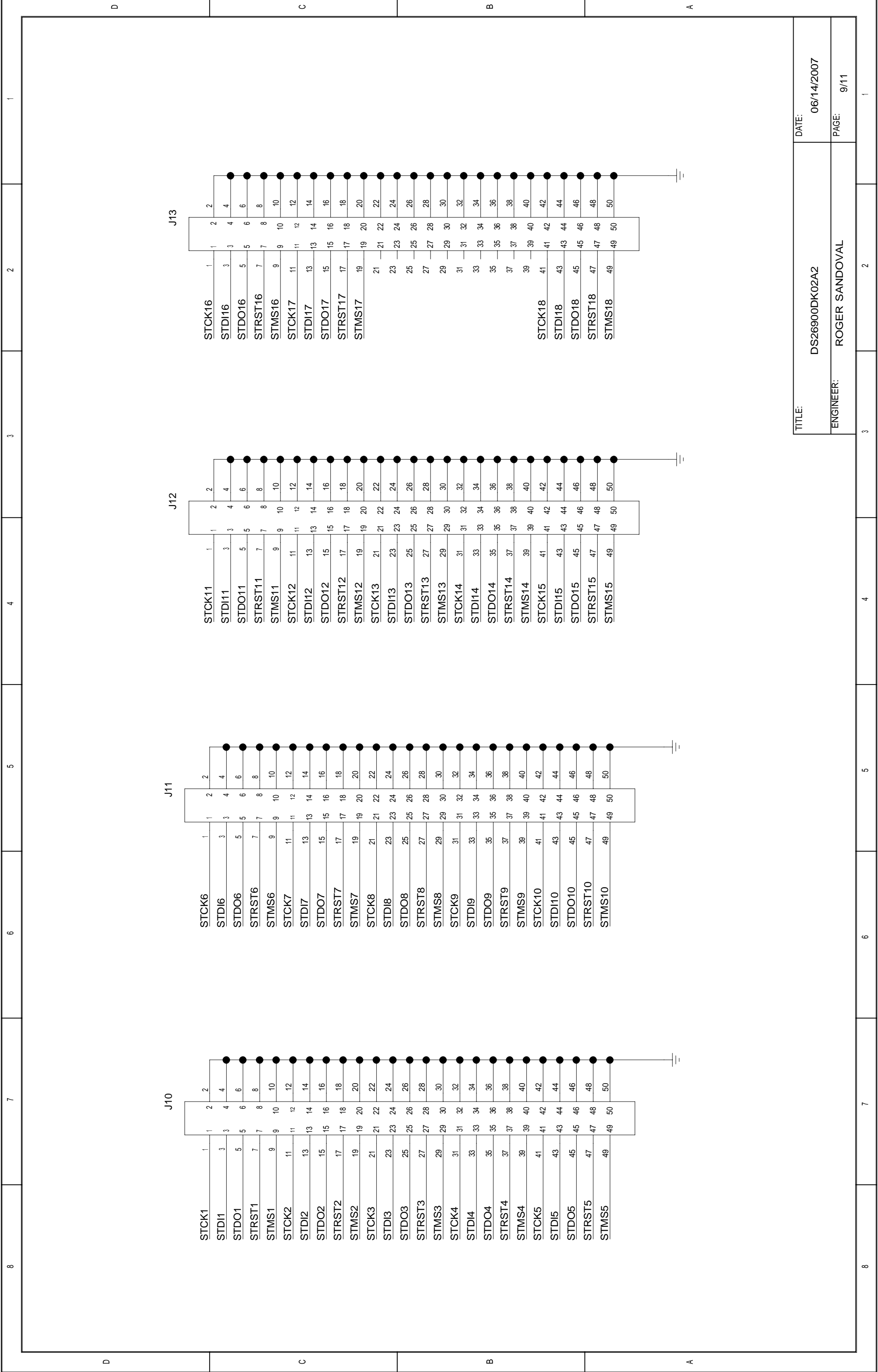

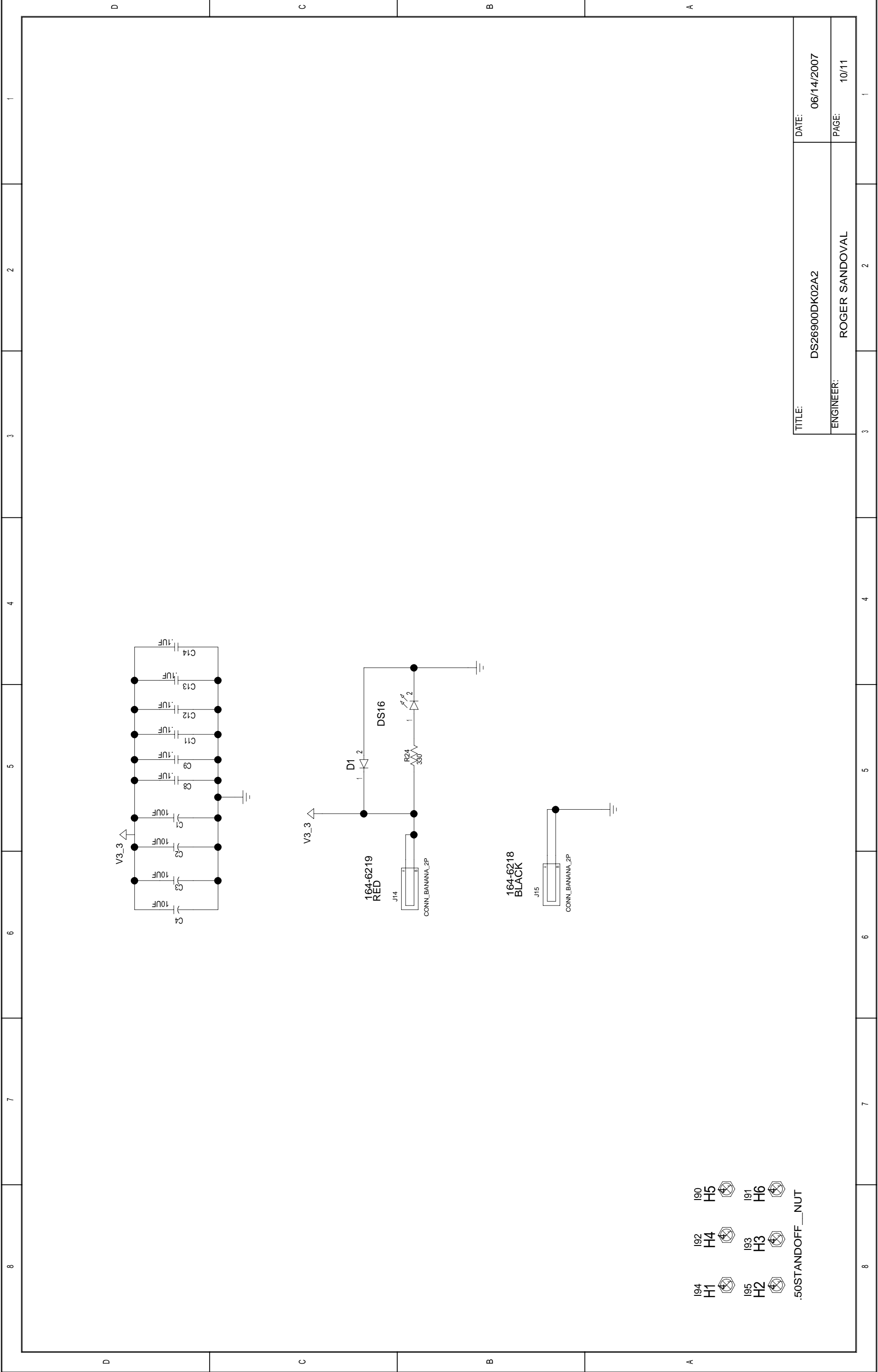

TITLE:	DS26900DK02A2	DATE:	06/14/2007
ENGINEER:	ROGER SANDOVAL	PAGE:	10/11

8	7	6	5	4	3	2	1
D	C	B	A				
D	C	B	A				

- 194 H1
 - 192 H4
 - 190 H5
 - 195 H2
 - 193 H3
 - 191 H6
- .50STANDOFF__NUT

REVISION HISTORY:

6/18/2007 - DISTRIBUTED 'A0' VERSION FOR REVIEW.

8/8/2007 - 'A1' - CORRECTED CONNECTION OF DS1 & DS2 - CATHODE TO GROUND. FIXED THE 'TREQ1' & 'TREQ2' NETS, WHICH WERE INCORRECT IN INITIAL SKETCH. ADDED HI/LO JUMPERS TO THE GPIO NETS SO THAT THE LED'S WILL LIGHT WHEN THE GPIO SIGNALS ARE HIGH IN BOTH THE INPUT AND THE OUTPUT MODES.

10/31/2007 - 'A2' - ADDED THE REVISION HISTORY PAGE. UPDATED PAGE NUMBERING.

TITLE: DS26900DK02A2
ENGINEER: ROGER SANDOVAL

DATE: 06/14/2007
PAGE: 11/11

8	7	6	5	4	3	2	1
D							
D							
C							
C							
B							
B							
A							
A							
8	7	6	5	4	3	2	1
D							
D							
C							
C							
B							
B							
A							
A							