

FEATURES

- Demonstrates the capabilities of the DS2751 Multichemistry Battery Fuel Gauge, Including:
 - Temperature Measurement
 - Voltage Measurement
 - Current Measurement
 - Current Accumulation
 - Information Storage
 - Identification
- Interfaces to the Serial Port of a PC Running Windows[®] 95 or Newer



PD010203*
DS2751K TSSOP

INDEX

- Evaluation Kit Contents
- Equipment Needed
- Introduction
- Setup and Installation
 - Board Connections
 - Software Installation
 - Selecting the COM Port
- Program Menus
 - Register Windows
- Program Tabs
 - Real Time Meters
 - Data Logging
 - User Memory
 - Pack Information
 - Fuel Gauging

EVALUATION KIT CONTENTS

- 1 pc. TSSOP Evaluation Board
- 1 pc. DS9123 Serial Port Adapter
- 1 pc. RJ-11 Phone Cable
- 1 pc. DS2751K CD Containing:
 - DS2751K Evaluation Software
 - DS2751 Related Data Sheets

EQUIPMENT NEEDED

1. A PC Running Windows 95 or Newer with a CD-ROM Drive and an Available Serial Port.
2. Cables with Mini-Grabber Style Clips or the Ability to Solder Directly to Connection Pads.
3. A Battery and a Power Supply and/or Load Circuit.

INTRODUCTION

The DS2751K evaluation kit makes performance evaluation, software development, and prototyping with the DS2751 multichemistry battery fuel gauge easy. The evaluation board interfaces to PC through a DS9123 serial port adapter and RJ-11 cable connection. The provided CD-ROM contains all related data sheets along with the evaluation software, which can be run under Windows 95, Windows 98, or Windows NT.

**Kit demonstration boards will vary as they are improved upon over time. For information on the demonstration board circuits refer to the documentation directory on the DS2751K CD-ROM.*

The DS2751K evaluation software gives the user complete control of all functions of the DS2751. Separate control tabs allow the user access to all EEPROM and RAM memory locations, all control registers, and real-time updates of all monitored parameters. The software also incorporates a data logging feature to monitor a cell over time and fuel-gauging algorithms to improve remaining capacity calculations based on specific cell characteristics.

The evaluation board circuit is designed to provide the DS2751 with accurate parameter measurements and protect the DS2751 from ESD damage. Kit demonstration boards will vary as they are improved upon over time. For information on the demonstration board circuits refer to the documentation directory on the DS2751K CD-ROM.

SETUP AND INSTALLATION

BOARD CONNECTIONS

Connections to the demonstration board are best made either by soldering directly to the pads or by using cables with mini-grabber clips. Communication to the board can be accomplished by connecting the RJ-11 jack to the DS9123 serial port adapter with the provided 2 conductor cable. Then the DQ and PAC- terminals on the RJ-11 jack can be wired directly to the DQ and PAC- pads on the demonstration board.

Figure 1 shows the recommended circuit for the DS2751K demonstration board. The Li+ cell or NiMH cell stack is connected between the BAT+ and BAT- pads. If a Li+ cell is used a protection circuit must be included between the battery and the demo board. The user system load circuit/charger is connected from BAT+ to PAC-. The evaluation software can be run with or without a load or charger as long as a cell is connected between the BAT+ and BAT- terminals providing a minimum of 2.7V to power the DS2751.

Figure 1. PD010203 Cell, Load, and Charger Connections

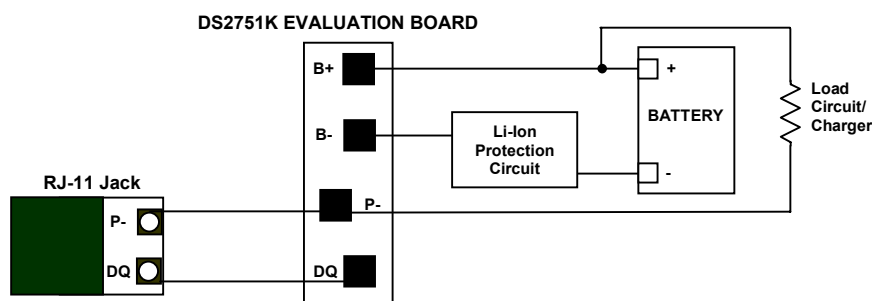

SOFTWARE INSTALLATION

To install the DS2751K software, exit all programs currently running and insert the DS2751K software CD into your computer's CD-ROM. The user can run SETUP.EXE from the setup directory and the installation process begins. Follow the prompts to complete the installation. The DS2751K software can be uninstalled in the *Add/Remove Programs* tool in the *Control Panel*. After the installation is complete, open the DS2751K folder and run DS2751K.EXE or select DS2751K from the program menu. A splash screen containing information about the evaluation kit appears as the program is being loaded.

The documentation directory also located on the CD contains all relevant data sheets and application notes on the DS2751 and DS2751K. They are stored in Adobe Acrobat format for easy viewing.

SELECTING THE COM PORT

The first time the software runs, the *Serial Port Settings* window appears. In this window, select the COM port to which the DS9123 is attached and the desired communication rate; then hit *OK*. The DS2751K software saves this COM port selection and automatically uses the selection each time the program starts. To change the COM port later, click the *Preferences* option on the menu bar, select *Serial Port Settings*, and then select the appropriate port. To attempt to automatically locate the DS9123, click the *Poll Serial Ports* button. Warning—automatically polling for the DS9123 can disrupt other devices connected to your computer's COM ports.

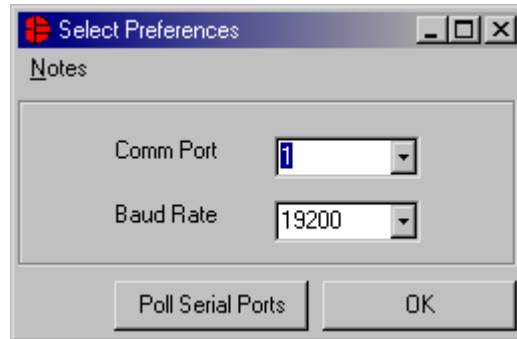

MENUS

Several pulldown menu options have been provided to simplify use of the DS2751K software for the user. Their functions are individually detailed below.

FILE MENU



The *File* menu allows the user to store information from a file directly into the *Device Setup*, *Battery Data*, and *Fuel-Gauging Data* sections under the *Pack Info* tab or take the same pack information and store to a file. These functions do not directly write or read the DS2751. It is still necessary for the user to store or recall this information to or from the device by issuing a *WRITE* or *READ* command under the *Pack Info* tab.

REGISTERS MENU



The *Registers* menu gives immediate access to all three status and function registers of the DS2751. Selecting any of the registers will open an individual control window giving the user a description of each register bit and the ability to read or write it. See the status register window example.

STATUS REGISTER

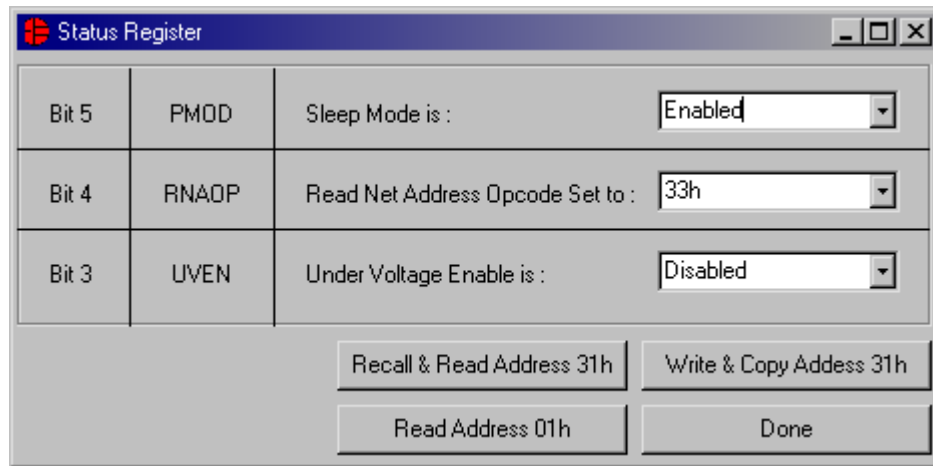

The present state of all register bits are displayed immediately upon opening the register window. R/W locations contain a selection field to allow the user to determine their state. Pressing either the *Apply* or *OK* button in the *EEPROM Register* or *Special Feature Register* windows will automatically update and read the corresponding register inside the DS2751. The *Status Register* has default values stored in user EEPROM addresses 0x31h. Their windows contain extra options to write or read these locations independently of their registers.

PREFERENCES MENU



The *Preferences* menu allows the user to change COM port settings at any time. *Edit Preferences* opens the *Select Preferences* window. See *Selecting the COM Port* above.

HELP MENU



Selecting the *About* topic from the *Help* menu will open a window containing information about this program and Dallas Semiconductor.

PROGRAM TABS

All functions of the program are divided under five tabs in the main program window. Left click on the appropriate tab to move to the desired function page. Located under the *Meters* tab is all information on real-time updates measured by the DS2751: voltage, current, accumulated charge, temperature, and the status of the PIO and POR bits of the Special Feature Register. The *Data Log* tab allows the user to store all real time information to a file. The *Memory* tab displays the contents of every register and memory location inside the DS2751 and allows the user to alter the data. The *Pack Information* tab gives the user the ability to assign a default device configuration and store that information to the DS2751 and/or a file. The *Fuel Gauging* tab uses the cell characterization information stored under *Pack Info* to maintain a high accuracy remaining capacity indicator.

METERS TAB

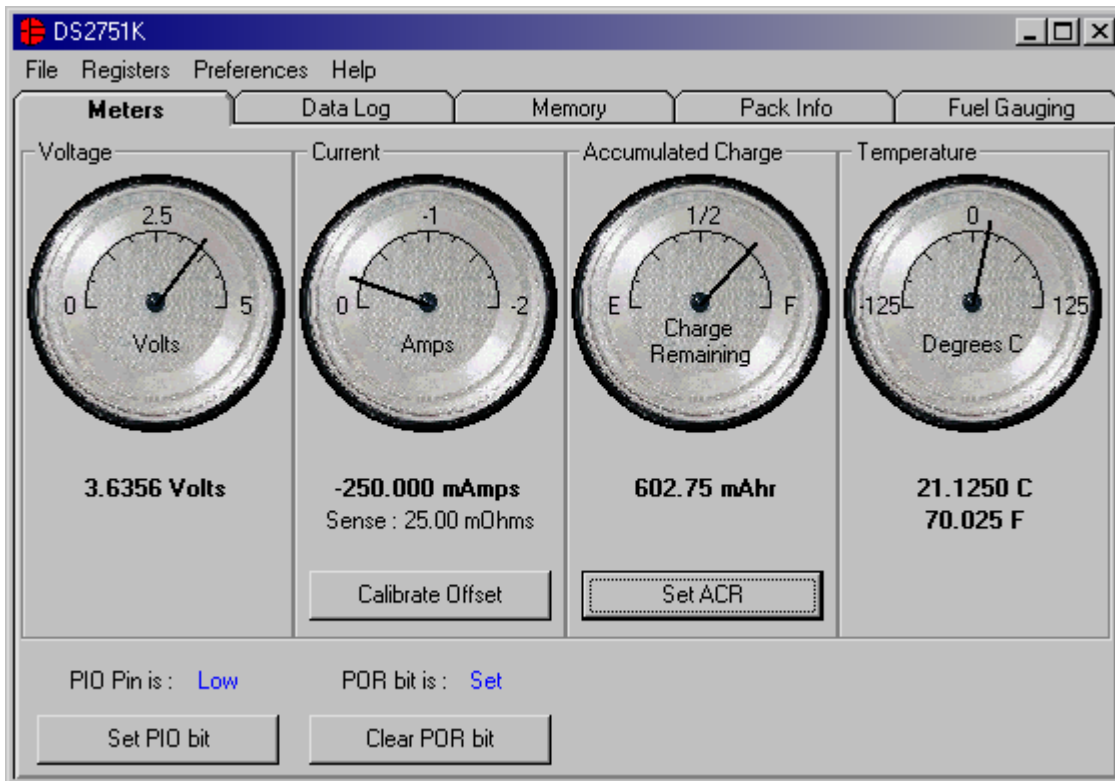

The *Meters* screen displays the latest real-time measurements of cell voltage, temperature, current and accumulated charge with both analog meter readouts and digital values. The sense resistor value used to calculate the current reading is shown in the current section. Left click on it or go to the sense resistor sub-tab under *Pack Info* to change this value. The *Calibrate Offset* button in the current section allows the user to zero the current measurements under the conditions of their circuit. Left clicking this button will begin the automatic calibration procedure. Calibration should be performed while the pack is disconnected and there is no current flow. The next 32 readings will be averaged and the offset eliminated by adjusting the Current Offset Register (location 0x33h) automatically. The process takes approximately 20 seconds.

The user can bring up the *Update Current Accumulator* window by left clicking the *Set ACR* button. This window allows the user to enter values for the Current Accumulator Register and Rated Battery Capacity in mA. Rated Battery Capacity is used to determine full scale range on the Accumulated Charge Meter. This value is stored in software only. Changing this value from the *Update Current Accumulator* window will adjust the Charge Remaining.

The present states of the PIO bit and the POR bit of the Special Feature Register are shown at the bottom of the window. The user can toggle the value of the bits by left clicking on the associated button.

DATALOG TAB

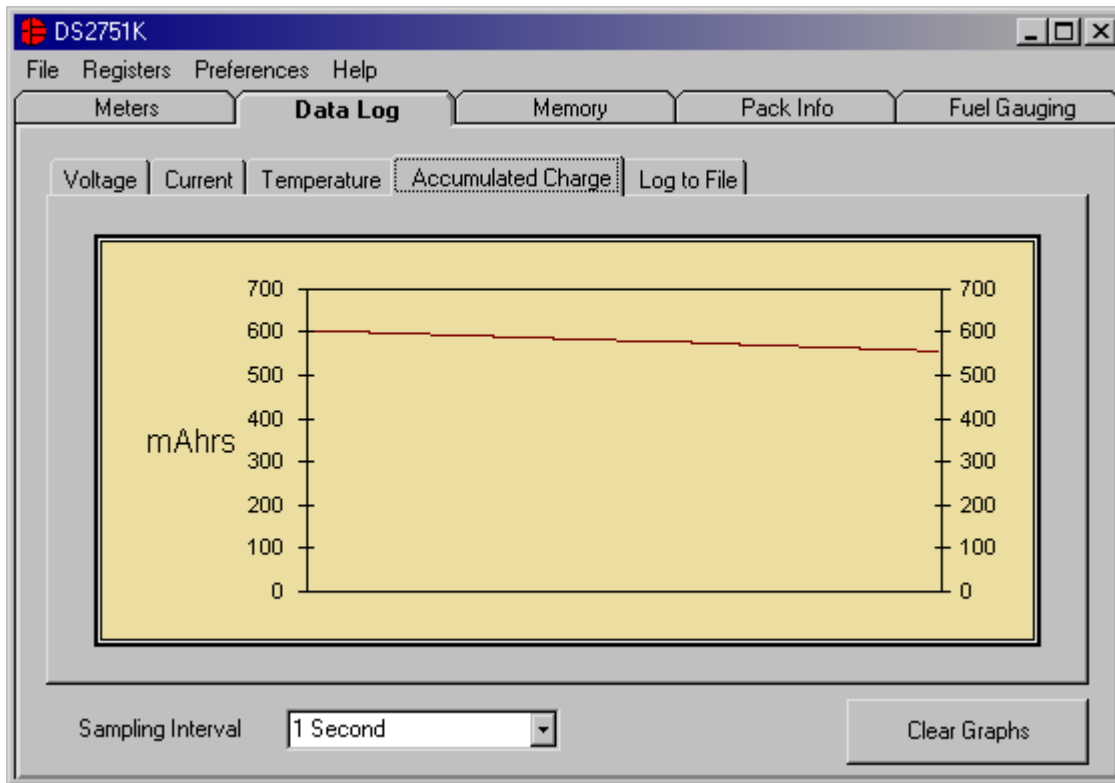

The *Datalog* tab allows the user to see the DS2751's parameter measurements graphed over time. There are separate sub-tabs for voltage, current, temperature, and accumulated charge. Each graph displays the last 500 data points collected by the DS2751K software. The sampling interval can be adjusted from 1 second to 15 minutes and can be adjusted from the *Sampling Interval* menu at the bottom of the window. The *Clear Graphs* button will clear all data from all four graphs, but does not reset the log to file function.

The *Log to File* sub-tab contains control information for storing all log data to an ASCII file. The default filename is `c:\DS2751K_datalog.txt`, but can be modified in the filename text field. The *Log Data* button toggles data logging off and on. Data will be stored at the same interval selected for updating the graphs in the tab delimited format of

“Time<tab>Voltage<tab>Current<tab>Temperature<tab>ACR”

for easy import into a spreadsheet. The most recent 50 samples are displayed in the window for observation. Warning—the *Log Data* function overwrites previous file information. Data previously stored in the file will be lost.

MEMORY TAB

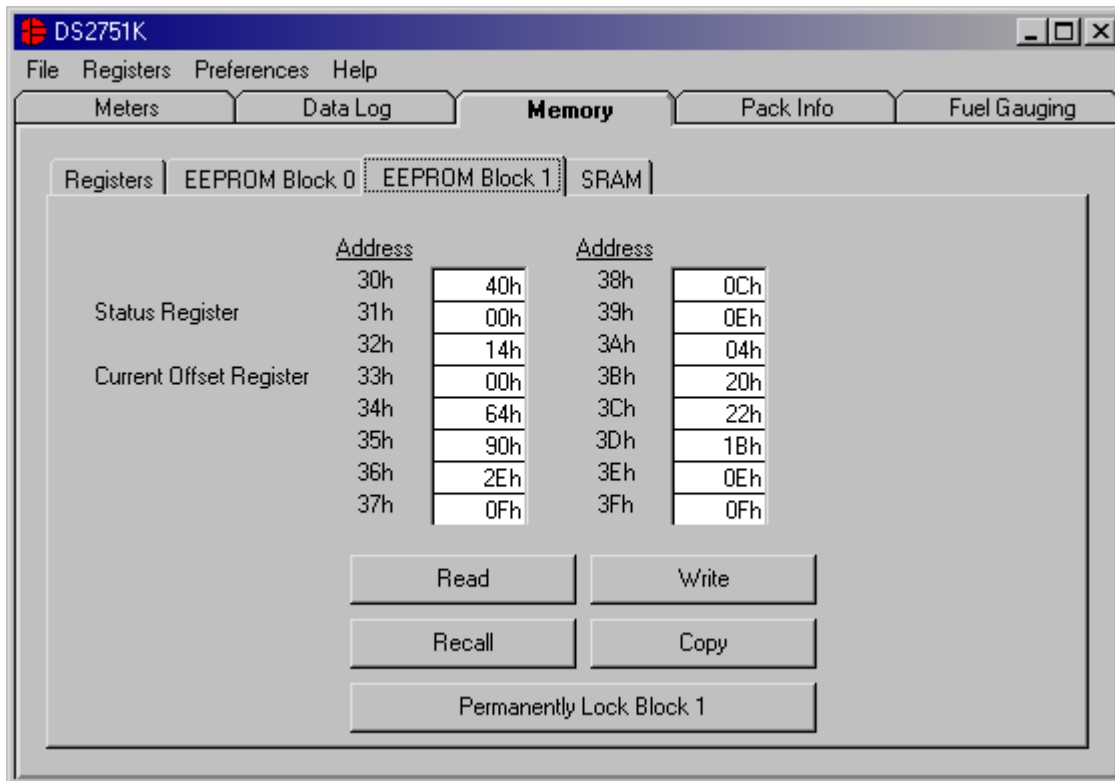

The *Memory* tab gives the user access to all 11 register, 32 EEPROM, and 16 SRAM bytes inside the DS2751. They are separated into four sub-tabs for convenience. Any value can be modified by clicking in that address' text box and typing a new value in hexadecimal format. The *Write* button will copy the entire block of data to the corresponding location inside the DS2751 (scratchpad RAM on the EEPROM blocks). The *Read* button will update the entire block's text boxes with data from the DS2751 (scratchpad RAM on the EEPROM blocks). Sub-tabs displaying any EEPROM data will also have *Copy* and *Recall* buttons to allow the user to transfer the data between scratchpad and EEPROM memory internal to the DS2751. The *Permanently Lock Block 0/1* buttons will permanently store the data currently located in that block's EEPROM if the LOCK bit in the EEPROM register is set. Otherwise this button will do nothing. Warning—this data can never be changed once locked. Verify your data first by issuing a *Recall* and a *Read*.

PACK INFORMATION TAB

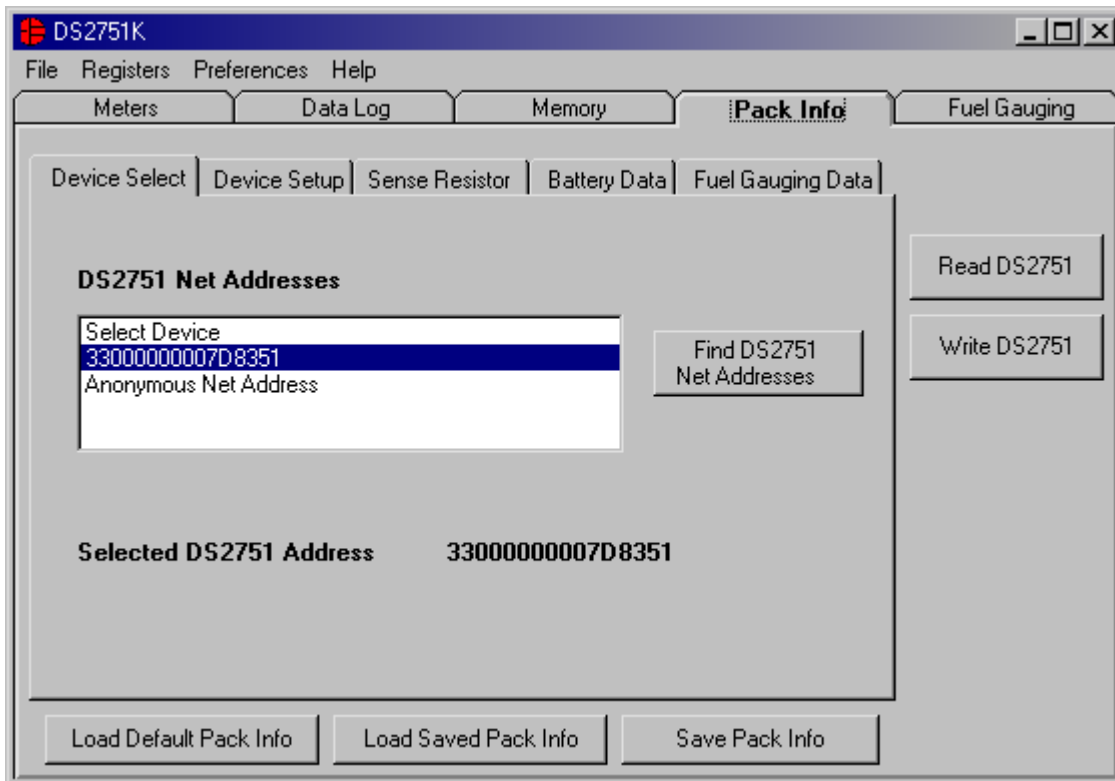

The *Pack Information* tab gives the pack manufacturer the ability to assign default register settings, device and sense resistor selection, and recommended manufacturer data and fuel gauging information.

The *Device Select* sub-tab allows the user to choose which device on the 1-Wire bus to communicate with. Clicking on the *Find DS2751 Net Addresses* button will begin a SEARCH NET ADDRESS operation on the 1-Wire bus. All DS2751s found on the bus will be listed in the *Net Addresses* field. To communicate to any device on the bus, click on its address inside the *Net Addresses* field to select it. The program will now use this device for all operations until a different DS2751 is chosen.

The *Device Setup* sub-tab shows the current state of all major features of the DS2751. All status indicators shown here directly mirror their corresponding bits in the Status and Special Feature registers. Clicking on any of the status indicators will open the corresponding register window to allow editing. See *Registers* menu above. The selection fields on the right hand side of the sub-tab set how the EEPROM backup bits (locations 0x31h) will be programmed when the DS2751 is programmed with the pack information.

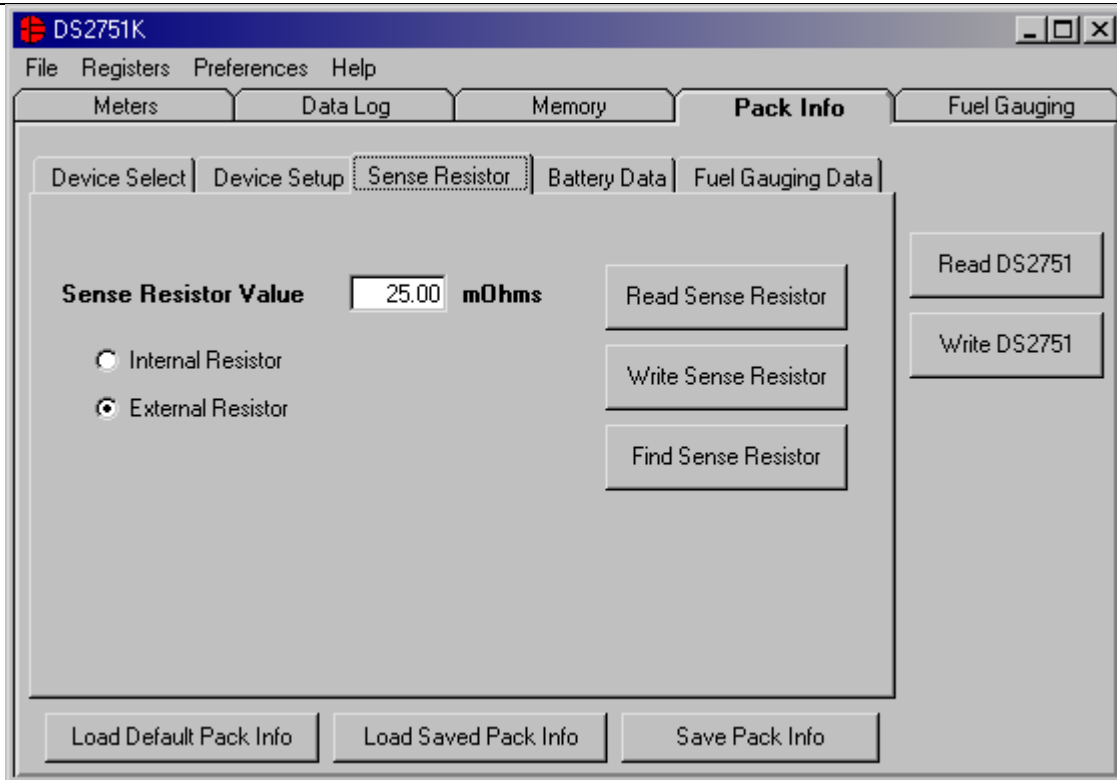

The *Sense Resistor Select* sub-tab allows the user to correct the current measurements if a different value of sense resistor is used. All DS2751s with an integrated sense resistor use 25mΩs. If the sense resistor is located externally, the user should select the external resistor radio button on this tab, then enter the value of the resistor in mΩs in the *Sense Resistor Value* field and then click the *Write Sense Resistor* button. The *Find Sense Resistor* button opens the *Find Sense Resistor* window. The user can then determine the resistance by forcing a known current and measuring the voltage drop with the DS2751. The resistance value is stored with $\frac{1}{4}$ mΩ resolution into the user EEPROM of the device. The program uses this value to convert the voltage difference from the VSENS+ and VSENS- pins into milliamps. If this value does not match the value of the external resistor, current measurements will be inaccurate.

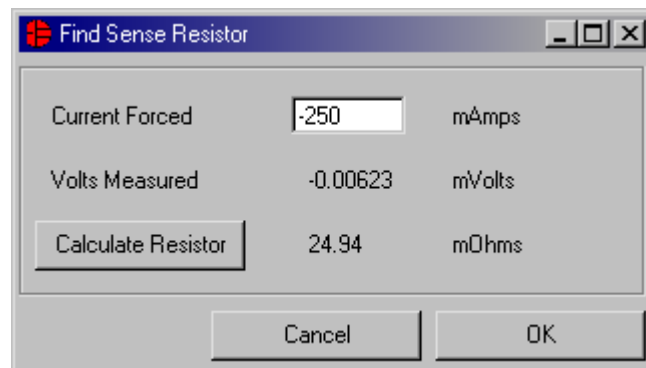

The *Battery Data* and *Fuel Gauging Data* sub-tabs demonstrate how the pack manufacturer can use the DS2751s EEPROM fields to store relevant pack information such as manufacturer, chemistry, etc. The fuel gauging characterization data is used by the fuel gauging algorithms in the software. See the *Fuel Gauging* tab description below. Clicking on the *Load Default Pack Info* button will enter example data into the information fields of the *Device Setup*, *Battery Data*, and *Fuel Gauging Data* sub-tabs. To

change any of this information, simply click on the desired text field and enter the new value. Once all data is in the desired format, click on the Write DS2751 button to copy it to the EEPROM of the DS2751. This information can also be stored to a file and recalled later using the *Load/Save Pack Info* buttons.

MEMORY MAP OF PACK INFORMATION DATA

Addresses	0x20	Fuel Gauging – Full Point at 0°C			
	0x21	Fuel Gauging – Full Point at 0°C			
	0x22	Fuel Gauging – Full Point difference from 10°C to 0°C			
	0x23	Fuel Gauging – Full Point difference from 20°C to 10°C			
	0x24	Fuel Gauging – Full Point difference from 30°C to 20°C			
	0x25	Fuel Gauging – Full Point difference from 40°C to 30°C			
	0x26	Total Accumulated Discharge – Divided by 20 to store in 2 bytes			
	0x27	Total Accumulated Discharge – Divided by 20 to store in 2 bytes			
	0x28	Scalar – Stored in 2 bytes with 100% equal to 1000h			
	0x29	Scalar – Stored in 2 bytes with 100% equal to 1000h			
	0x2A	Fuel Gauging – Time from Break Point to Full at 0°C			
	0x2B	Fuel Gauging – Time from Break Point to Full at 20°C			
	0x2C	Fuel Gauging – Time from Break Point to Full at 40°C			
	0x2D	Fuel Gauging – Time from Empty to Full at 0°C			
	0x2E	Fuel Gauging – Time from Empty to Full at 20°C			
	0x2F	Fuel Gauging – Time from Empty to Full at 40°C			
	0x30	Reserved			
	0x31	PMOD	RNAOP	UVEN	
	0x32	Fuel Gauging – Charge Time Estimation Break Point			
	0x33	Current Offset – Do not overwrite			
	0x34	Sense Resistor (1/4mΩ resolution)			
	0x35	Date Code – 2 bytes			
	0x36	Date Code – 2 bytes			
	0x37	Fuel Gauging – Standby Empty Point difference from 0°C to 10°C			
	0x38	Fuel Gauging – Standby Empty Point difference from 10°C to 20°C			
	0x39	Fuel Gauging – Standby Empty Point difference from 20°C to 30°C			
	0x3A	Fuel Gauging – Standby Empty Point difference from 30°C to 40°C			
	0x3B	Fuel Gauging – Active Empty Point difference from 0°C to 10°C			
	0x3C	Fuel Gauging – Active Empty Point difference from 10°C to 20°C			
	0x3D	Fuel Gauging – Active Empty Point difference from 20°C to 30°C			
	0x3E	Fuel Gauging – Active Empty Point difference from 30°C to 40°C			
0x3F	Fuel Gauging – Active Empty Point at 40°C				

The memory map above shows the format in which the data is stored within the device. All static data is stored in Block 1 while data which might need to be updated is in Block 0. The pack manufacturer can now permanently lock Block 1 to maintain data integrity while leaving Block 0 open for access by the host processor.

FUEL GAUGING TAB

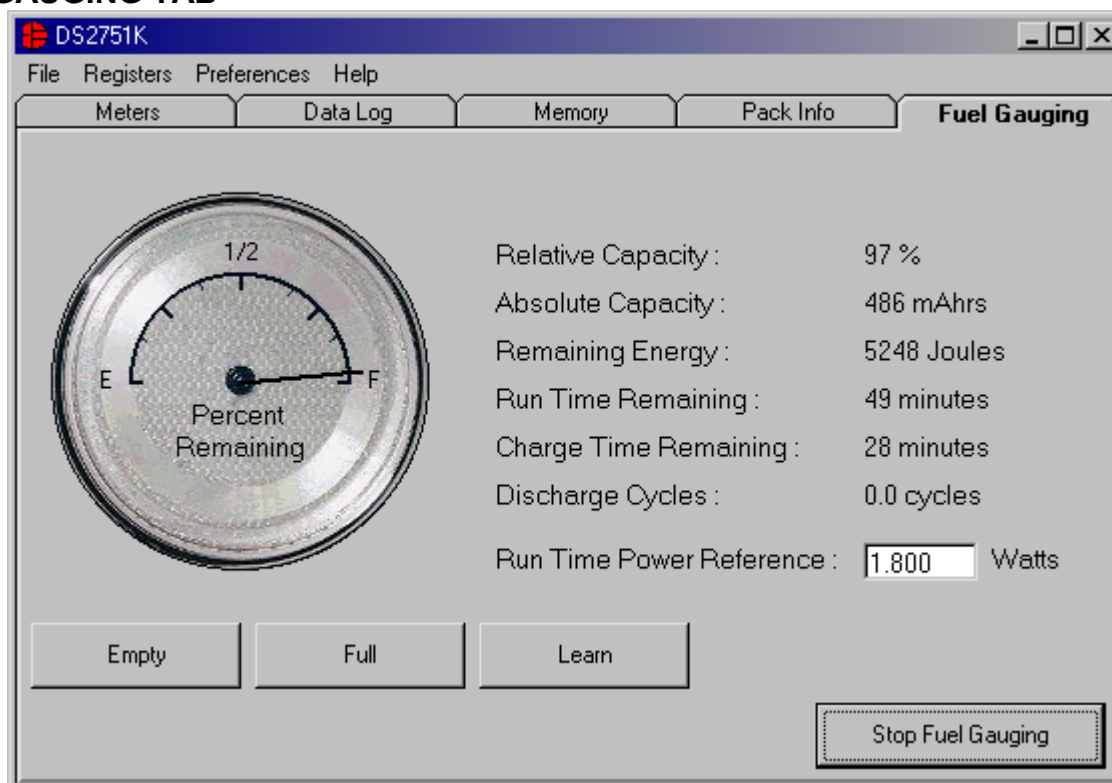

The final program tab performs a high accuracy calculation of remaining cell capacity using Dallas Semiconductor's fuel gauging algorithms. For this feature to function properly, cell characterization data must be stored in the DS2751's user EEPROM. See the *Pack Information* section above. If characterization data cannot be found, the fuel gauge will not start and an error message will be displayed. The *Relative Capacity* number represents what percentage of cell capacity is remaining based on present algorithm inputs such as temperature, discharge rate, etc. This value is also reflected in the analog meter. The remaining cell capacity is also displayed in terms of milliamp-hours and Joules under *Absolute Capacity* and *Remaining Energy* respectively.

The remaining run time is calculated using the *Run Time Power Reference* input from the user. Instantaneous current measurements in the user's application can vary greatly. By using a reference scalar instead of actual current and voltage measurements, the program produces a stable estimation of remaining run time. The user should enter the largest expected power draw from the device into the *Run Time Power Reference* field for the most accurate estimation.

If this example were part of a fully integrated fuel gauging system, the algorithms would need to be updated by the host each time the cell was fully charged or discharged in order to maintain long term accuracy. To simulate this, the user should click the *Empty* or *Full* buttons each time the monitored pack is completely charged or discharged. The *Empty* button will reset the Current Accumulator to the expected empty point based on present conditions. The *Full* button will set the Current Accumulator the expected full point based on present conditions. The *Learn* button will reset the expected full point to the present Current Accumulator value and update the fuel gauging information in the DS2751's user EEPROM. In doing this, the algorithms "learn" from previous results and are more accurate in the future. This tab gives an example only of fuel gauging. For more information on the process of high-accuracy fuel gauging consult Dallas Semiconductor's fuel gauging application notes.