

MAXIM

MAX1541 Evaluation Kit

Evaluates: MAX1541

General Description

The MAX1541 evaluation kit (EV kit) demonstrates the MAX1541's standard 4A application circuit. This DC-DC converter steps down high-voltage batteries and/or AC adapters, generating precision low-voltage GPU, DPR, and chipset power supplies for notebook computers.

The MAX1541 EV kit provides a dynamically adjustable 1.0V/1.5V output voltage (OUT1), a fixed 2.5V output voltage (OUT2), and a fixed 5V, 100mA linear regulator (LDOOUT) from the 7V to 24V battery input range. It delivers up to 4A output current for each output voltage with greater than 90% efficiency. The EV kit operates at 355kHz/485kHz switching frequency (OUT2/OUT1, respectively) and has superior line- and load-transient response.

This EV kit is a fully assembled and tested circuit board. It also allows the evaluation of other dynamically adjustable output voltages in the 0.7V to 5.5V range by changing resistors R9, R10, and R11 (OUT1) and other fixed output voltages in the 0.7V to 5.5V range by changing resistors R18 and R19 (OUT2).

Features

- ◆ 7V to 24V Input Voltage Range
- ◆ Dynamically Selectable Output Voltages 1.0V/1.5V (OUT1, Adjustable from 0.7V to 5.5V)
- ◆ Fixed 2.5V/1.8V Output Voltage (OUT2, Adjustable from 0.7V to 5.5V)
- ◆ Fixed 5V or Adjustable 100mA Linear Regulator
- ◆ 4A Output Current for Each Output
- ◆ 355kHz/485kHz Switching Frequency (OUT2/OUT1, Respectively)
- ◆ Selectable Inductor Saturation Protection
- ◆ Separate Power-Good Outputs
- ◆ Selectable Overvoltage/Undervoltage Protection
- ◆ Low-Profile Components
- ◆ Fully Assembled and Tested

Ordering Information

PART	TEMP RANGE	IC PACKAGE
MAX1541EVKIT	0°C to +70°C	40 Thin QFN 6mm x 6mm

Component List

DESIGNATION	QTY	DESCRIPTION
C1, C2	2	10 μ F, 25V ceramic capacitors (1812) Taiyo Yuden TMK432BJ106KM or TDK C4532X5R1E106M
C3	1	470 μ F, 4V, 10m Ω low-ESR capacitor Sanyo 4TPD470M
C4	1	220 μ F, 4V, 15m Ω low-ESR capacitor Sanyo 4TPE220MF
C5, C6	2	1 μ F \pm 20%, 10V X5R ceramic capacitors (0805) Taiyo Yuden LMK212BJ105KG or TDK C2012X5R1A105M
C7, C8, C14	3	0.1 μ F \pm 10%, 25V X7R ceramic capacitors (0603) Murata GRM188R71E104K or TDK C1608X7R1E104K
C9	1	47pF \pm 5%, 50V C0G ceramic capacitor (0603) Murata GRM1885C1H470J

DESIGNATION	QTY	DESCRIPTION
C10	1	0.22 μ F, 25V X5R ceramic capacitor (0805) Murata GRM219R71E224KC01D or Taiyo Yuden EMK212BJ224KG
C11	1	1000pF \pm 10%, 50V C0G ceramic capacitor (0603) TDK1608X7R1H102K or Murata GRM188R71H102K
C12, C13	2	470pF \pm 10%, 50V X7R ceramic capacitors (0603) Murata GRM188R71H471K
C15	1	10 μ F, 10V tantalum capacitor (case B) AVX TAJB10M010R
C16	1	3.3 μ F, 35V tantalum capacitor (case B) AVX TAJB335M035R
C17–C22	0	Not installed (0603)
D1, D2	2	100mA, 30V Schottky diodes Central Semiconductor CMPSH-3

MAX1541 Evaluation Kit

Component List (continued)

DESIGNATION	QTY	DESCRIPTION
D3, D4	2	1A, 30V Schottky diodes Nihon EP10QY03 or Toshiba CRS02
JU1, JU2, JU8, JU9	4	3-pin headers, 0.1 centers
JU3, JU6, JU7	3	4-pin headers, 0.1 centers
L1	1	1.8 μ H, 5.4A power inductor Sumida CDEP105(L)-1R8
L2	1	4.3 μ H, 6.8A power inductor Sumida CDEP105(L)-4R3
N1A, N1B, N2A, N2B	2	Dual N-channel MOSFETs Fairchild FDS6982A
R1	1	20 Ω \pm 5% resistor (0805)
R2, R3	2	0.015 Ω \pm 1%, 1/2W resistors (2010) IRC LR2010-01-R015-F or Dale WSL-2010-R015F
R4, R6, R7, R8, R19, R23, R27, R28, R34	9	0 Ω resistors (0603)

DESIGNATION	QTY	DESCRIPTION
R5, R16, R17, R18, R22, R24, R25, R31, R32, R33, R35–R38	0	Not installed (0603)
R9, R10	2	75k Ω \pm 1% resistors (0603)
R11	1	150k Ω \pm 1% resistor (0603)
R12, R14	2	100k Ω \pm 1% resistors (0603)
R13, R15	2	49.9k Ω \pm 1% resistors (0603)
R20, R21	2	100k Ω \pm 5% resistors (0603)
R26	1	10 Ω \pm 5% resistor (0805)
R29, R30	0	Not installed (short PC trace) (0603)
U1	1	MAX1541ETL (40-pin QFN 6mm x 6mm)
None	4	Rubber bumpers
None	7	Shunts, 0.1 centers
None	1	MAX1541 PC board

Component Suppliers

SUPPLIER	PHONE	FAX	WEBSITE
AVX	843-946-0238	843-626-3123	www.avxcorp.com
Central Semiconductor	516-435-1110	516-435-1824	www.centalsemi.com
Dale-Vishay	402-564-3131	402-63-6296	www.vishay.com
Fairchild	408-721-2181	408-721-1635	www.fairchildsemi.com
IRC	361-992-7900	361-992-3377	www.ircct.com
Murata	770-436-1300	770-436-3636	www.murata.com
Nihon	847-843-7500	847-843-2798	www.niec.co.jp
Sanyo	619-661-6835	619-661-1055	www.sanyodevice.com
Sumida	708-956-0666	708-956-0702	www.sumida.com
Taiyo Yuden	800-348-2496	847-925-0899	www.t-yuden.com
TDK	847-390-4373	847-390-4428	www.component.tdk.com

Note: Please indicate that you are using the MAX1541 when contacting these component suppliers.

MAX1541 Evaluation Kit

Evaluates: MAX1541

Quick Start

Equipment Needed

- 7V to 24V power supply, battery, or notebook AC adapter
 - Dummy loads capable of sinking 4A
 - Digital multimeters (DMMs)
 - 100MHz dual-trace oscilloscope
- 1) Ensure that the circuit is connected correctly to the supplies and dummy load prior to applying any power.
 - 2) Verify that the shunts are across:
 - a) JU1 pins 1 and 2 (ON1 high), JU2 pins 1 and 2 (ON2 high).
 - b) JU3 pins 1 and 2 (SKIP/high, forced PWM), JU6 pins 1 and 2 (OVP/UVLP enabled).
 - c) JU7 pins 1 and 3 (TON = REF, 450kHz switching frequency), JU8 pins 1 and 2 (GATE low, VOUT1 = 1.5V).
 - d) JU9 pins 1 and 2 (linear regulator enabled)
 - 3) Turn on VIN, input/battery power supply.
 - 4) Verify that the output voltages are VOUT1 = 1.5V, VOUT2 = 2.5V, and VLDOOUT = 5V.

Detailed Description

Jumper Settings

Table 1. Jumper JU1 Functions (Output Voltage OUT1 Control)

JU1	ON1 PIN	OUT1
1 & 2 (default)	Connected to VCC.	OUT1 enabled, VOUT1 = 1.5V.
2 & 3	Connected to GND.	OUT1 shutdown mode.
Not installed	ON1 must be driven by an external signal connected to ON1 pad.	OUT1 operation depends on the external ON1 signal levels.

Table 2. Jumper JU2 Functions (Output Voltage OUT2 Control)

JU2	ON2 PIN	OUT2
1 & 2 (default)	Connected to VCC.	OUT2 enabled, VOUT2 = 2.5V.
2 & 3	Connected to GND.	OUT2 shutdown mode.
Not installed	ON2 must be driven by an external signal connected to ON1 pad.	OUT2 operation depends on the external ON2 signal levels.

Table 3. Jumper JU3 Functions (Low-Noise Mode)

JU3	SKIP PIN	OPERATIONAL MODE
1 & 2 (default)	Connected to VCC.	Low-noise mode, OUT1 and OUT2 are in forced-PWM mode.
1 & 3	Connected to REF.	OUT1 is in pulse-skipping mode; OUT2 is in forced-PWM mode.
1 & 4	Connected to GND.	OUT1 and OUT2 are in pulse-skipping mode.
Not installed	Open.	OUT1 is in forced-PWM mode; OUT2 is in pulse-skipping mode.

MAX1541 Evaluation Kit

Table 4. Jumper JU6 Functions (Overvoltage/Undervoltage Protection Selection)

JU6	OVP/UVP PIN	UVP	OVP/DISCHARGE MODE
1 & 2 (default)	Connected to V _{CC} .	UVP is enabled; UVP threshold is 70% of nominal.	OVP and discharge mode are enabled; OVP threshold is 116% of nominal.
1 & 3	Connected to REF.	UVP is enabled.	OVP and discharge mode are disabled.
1 & 4	Connected to GND.	UVP is disabled.	OVP and discharge mode are disabled.
Not installed	Floating.	UVP is disabled.	OVP and discharge mode are enabled.

Note: The MAX1541 detects and latches the discharge-mode state set by OVP/UVP on startup.

Table 5. Jumper JU7 Functions (Switching-Frequency Selection)

JU7	TON PIN	FREQUENCY (OUT1/OUT2) (kHz)
1 & 2	Connected to V _{CC} .	235/170
1 & 3 (default)	Connected to REF.	485/355 (as shipped)
1 & 4	Connected to GND.	620/460
Not installed	Floating.	345/255

Note: Do not change the operating frequency without first recalculating component values because the frequency has a significant effect on preferred inductor value, peak current-limit level, MOSFET heating, PFM/PWM switchover point, output noise, efficiency, and other critical parameters.

Table 6. Jumper JU8 Functions (GATE)

JU8	GATE PIN	OUT1
1 & 2 (default)	Connected to GND.	A logic low on GATE turns off the internal MOSFET so that OD appears as high impedance, V_{OUT1} = 1.5V .
2 & 3	Connected to V _{CC} .	A logic high on GATE turns on the internal MOSFET, pulling OD to ground, V_{OUT1} = 1.0V .
Not installed	GATE must be driven by an external signal connected to GATE pad.	OUT1 voltage depends on the external GATE signal levels.

Table 7. Jumper JU9 Functions (Linear Regulator LDOOUT Control)

JU9	LDOON PIN	LDOOUT
1 & 2 (default)	Connected to LDOIN through JU5.	LDOOUT enabled, V_{LDOOUT} = 5V .
2 & 3	Connected to GND.	Shutdown mode.
Not installed	LDOON connected to voltage-divider R24/R25.	R24 and R25 set the LDOIN undervoltage lockout threshold.

Evaluating Other Dynamic Output Voltages (OUT1)

The EV kit output is preset to 1.0V/1.5V (OUT1), 2.5V (OUT2), and 5V (LDOOUT). However, OUT1 can also be adjusted between 0.7V and 2V (FB1 = OUT1) by selecting R9, R10, and R11 values. The MAX1541 regulates FB1 to the voltage set at REFIN1. By changing the voltage at REFIN1, the MAX1541 can be used in applications that require dynamic output-voltage changes between two set points. Using the GATE signal and open-drain output (OD), a resistor can be switched in and out of the REFIN1 resistor-divider, changing the voltage at REFIN1. A logic high on GATE turns on the internal N-channel MOSFET, forcing OD to a low-impedance state. A logic low on GATE disables the N-channel MOSFET, so OD is high impedance. The two output voltages (FB1 = OUT1) are determined by the following equations:

$$V_{OUT1(LOW)} = V_{REF}(R10 / (R9 + R10))$$

$$V_{OUT1(HIGH)} = V_{REF}(R10 + R11) / (R9 + R10 + R11)$$

where $V_{REF} = 2.0V$.

Refer to the MAX1540/MAX1541 data sheet for selection of output capacitor and inductor values for output voltages greater than 2V.

MAX1541 Evaluation Kit

Evaluates: MAX1541

Evaluating Other Fixed-Output Voltages (OUT2)

The MAX1541 provides a fixed 2.5V output (OUT2) when FB2 is connected to GND (R18 = open, R19 = 0, R38 = open) or fixed 1.8V output when FB2 is connected to V_{CC} (R18 = open, R19 = open, R38 = 0).

OUT2 can also be adjusted from 0.7V to 5.5V by using a resistive voltage-divider formed by R18 and R19 (R38 = open). The MAX1541 regulates FB2 to a fixed reference voltage (0.7V).

The adjusted output voltage is:

$$V_{OUT2} = V_{FB2}(1 + R18 / R19)$$

where $V_{FB2} = 0.7V$.

Refer to the MAX1540/MAX1541 data sheet for selection of output capacitor and inductor values for different output voltages.

Evaluating Other Linear-Regulator Output Voltages (LDOOUT)

The MAX1541 provides a fixed 5V linear-regulator output (LDOOUT) when LDOON is connected to VIN. However, the linear output voltage can be adjusted between 1.25V and 24V by selecting R22 and R23 values.

The adjusted linear output voltage is:

$$V_{LDOOUT} = V_{FBLDO}(1 + R22 / R23)$$

where $V_{FBLDO} = 1.25V$.

Note: When LDOOUT is set to a voltage other than +5V, cut the trace short across JU4 and connect a separate 5V source to VBIAS.

Note: Make sure LDOOUT capacitors C14 and C15 have the correct voltage rating to match the LDOOUT voltage.

MAX1541 Evaluation Kit

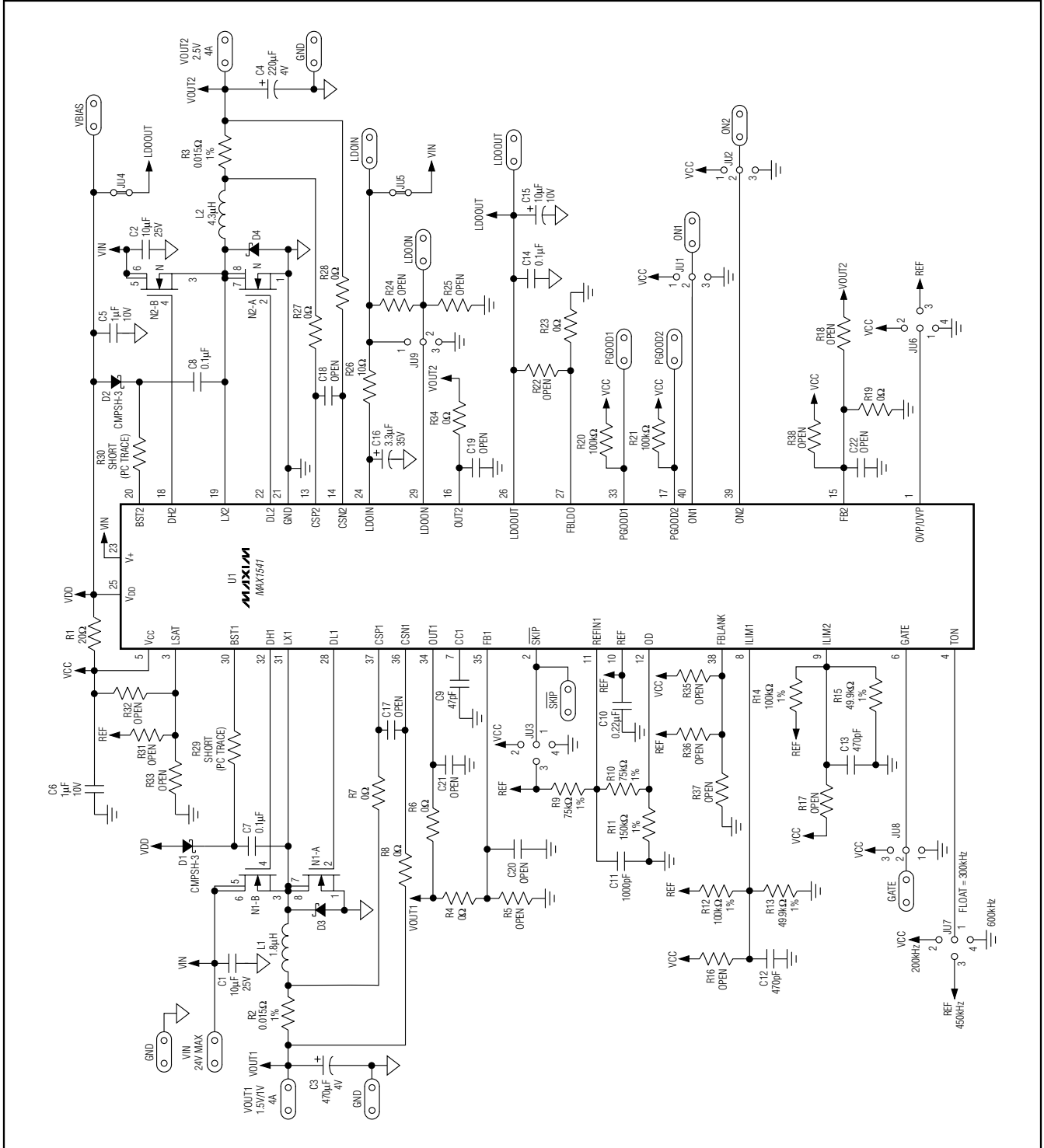

Figure 1. MAX1541 EV Kit Schematic

MAX1541 Evaluation Kit

Evaluates: MAX1541

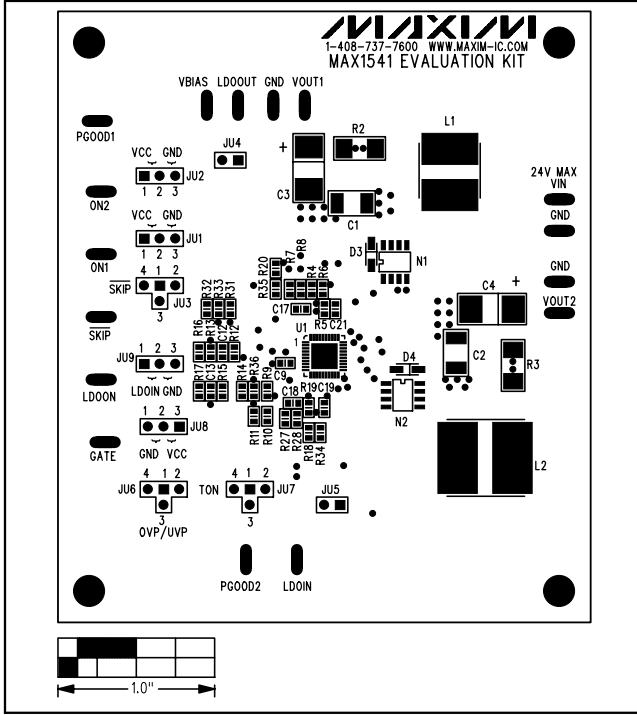

Figure 2. MAX1541EV Kit Component Placement Guide—Top Silkscreen

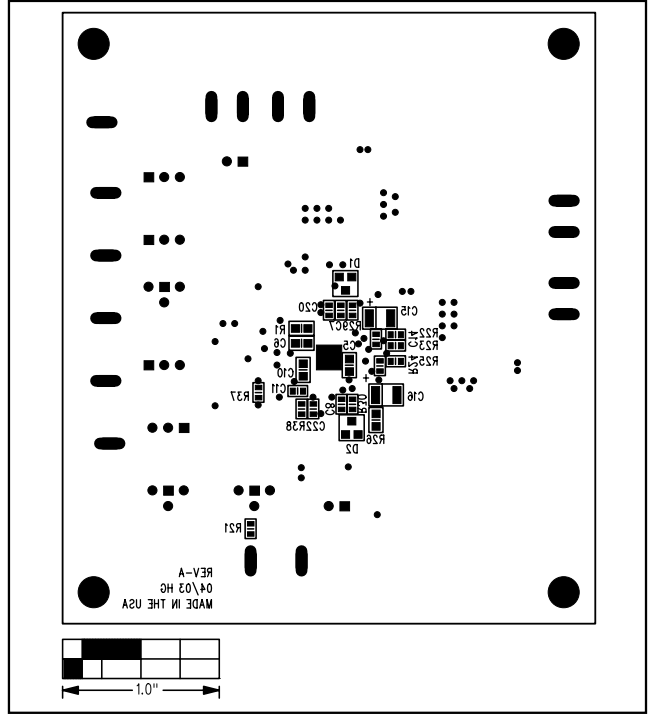

Figure 3. MAX1541 EV Kit Component Placement Guide—Bottom Silkscreen

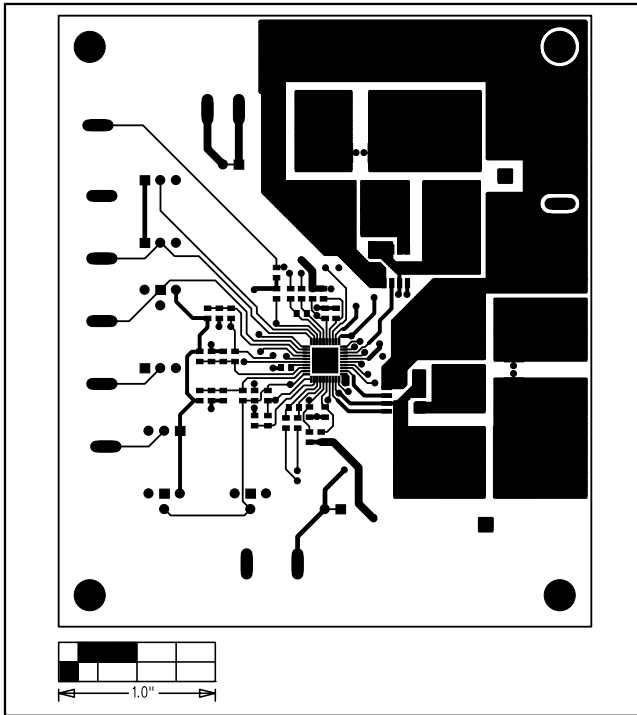

Figure 4. MAX1541 EV Kit PC Board Layout—Component Side

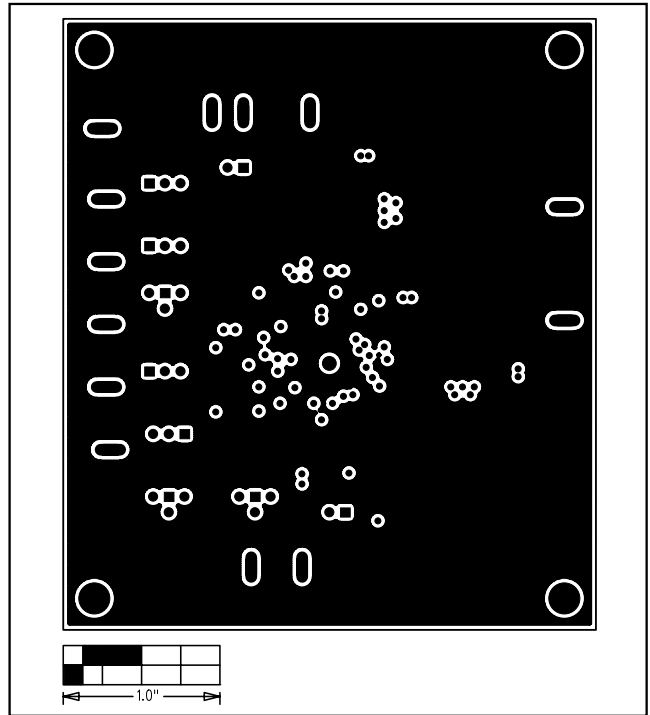

Figure 5. MAX1541 EV Kit PC Board Layout—Ground Layer 2

MAX1541 Evaluation Kit

Evaluates: MAX1541

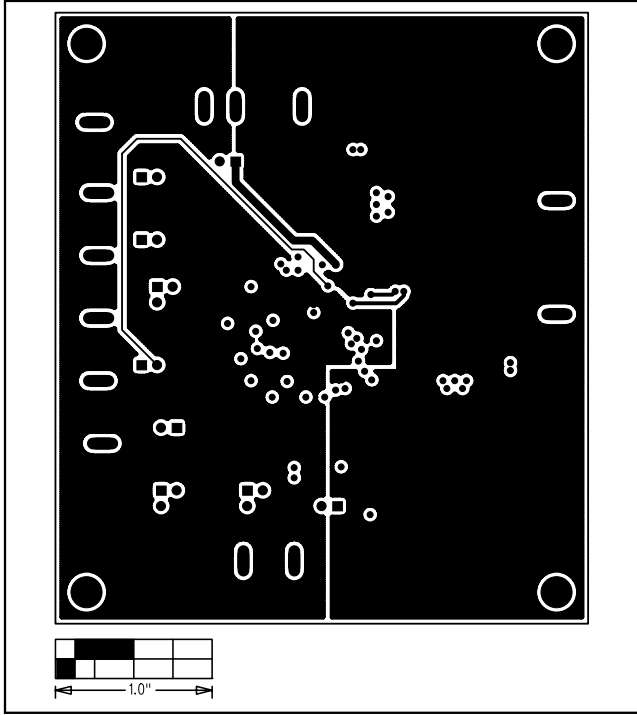

Figure 6. MAX1541 EV Kit PC Board Layout—Ground Layer 3

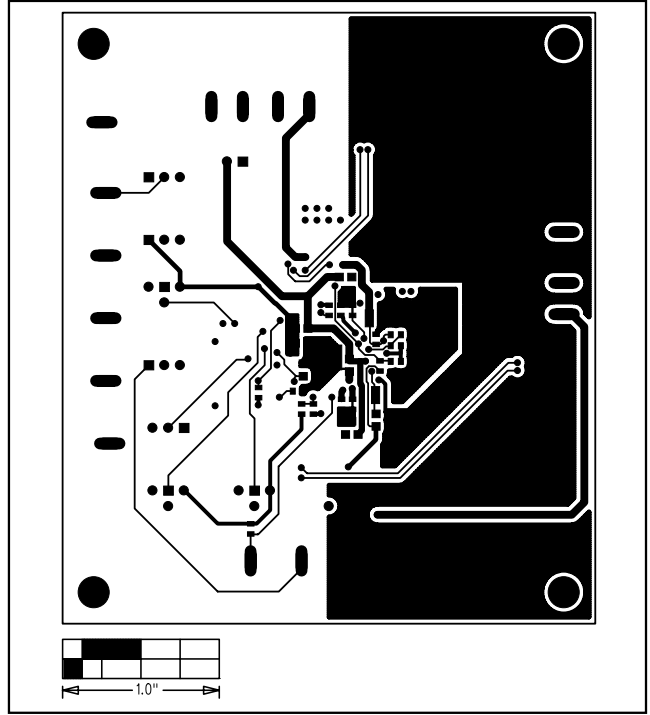

Figure 7. MAX1541 EV Kit PC Board Layout—Solder Side

Maxim cannot assume responsibility for use of any circuitry other than circuitry entirely embodied in a Maxim product. No circuit patent licenses are implied. Maxim reserves the right to change the circuitry and specifications without notice at any time.

8 **Maxim Integrated Products, 120 San Gabriel Drive, Sunnyvale, CA 94086 408-737-7600**