



MAX17005B Evaluation Kit

General Description

The MAX17005B evaluation kit (EV kit) is a complete and fully assembled and tested surface-mount PCB that features the MAX17005B highly integrated, multi-chemistry battery charger control IC. The MAX17005B EV kit utilizes two single-package n-channel MOSFETs for high-side and low-side switching for the MAX17005B internal synchronous step-down converter, and two n-channel MOSFETs and one p-channel MOSFET for the main power-source selection.

The MAX17005B EV kit is capable of supplying power to a system load while simultaneously charging 3- or 4-cell Li+ battery packs. During normal operation, the EV kit circuit automatically selects the ADAPTER input or the battery as the main power source for supplying power to the system load. If the ADAPTER input is selected as the main source and the EV kit's input-current limit is exceeded, the charge current is reduced automatically to give priority to the system load.

The EV kit's input-source-current limit is set to 4A while the maximum battery-charge voltage and charge-current thresholds can be configured up to 17.4V and 3.5A, respectively. The thresholds can be adjusted by using on-board circuitry or by connecting analog signals to the respective test points on the EV kit. A digital output signal (ACOK) indicates the presence of a valid AC adapter voltage at the ADAPTER input source. The MAX17005B EV kit PCB is rated for 0°C to +70°C; however, the MAX17005B IC is rated for -40°C to +85°C.

Features

- ◆ Analog/PWM Input Charge-Current Setting
- ◆ Up to 1.2MHz Switching Frequency
- ◆ Programmable Charge Current Up to 3.5A
- ◆ Monitors Input/Outputs
 - Analog Input Charge-Current-Setting Voltage
 - AC Adapter Input Current
 - AC Adapter Presence
- ◆ Automatic System Power-Source Selection
- ◆ Up to 17.4V (max) Battery Voltage
- ◆ 10V to 25V Adapter-Input Operation
- ◆ Demonstrates the MAX17005B IC Internal Boost Diode
- ◆ Cycle-by-Cycle Current Limit
- ◆ Multichemistry Battery Charger
- ◆ Fully Assembled and Tested

Ordering Information

PART	TYPE
MAX17005BEVKIT+	EV Kit

+Denotes lead(Pb)-free and RoHS compliant.

Component List

DESIGNATION	QTY	DESCRIPTION
ACOK, IINP, ISET, TP1-TP4	7	PC mini red test points
ADAPTER, BATT+, SYS_LOAD	3	PC large red test points
AGND	1	PC black test point
BATT-, PGND (2)	3	PC large black test points
C1	1	1 μ F \pm 10%, 25V X5R ceramic capacitor (0805) Murata GRM21BR61E105K
C2, C5, C6	3	4.7 μ F \pm 10%, 25V X5R ceramic capacitors (0805) Murata GRM21BR61E475K

DESIGNATION	QTY	DESCRIPTION
C3, C11	2	0.1 μ F \pm 10%, 25V X5R ceramic capacitors (0603) Murata GRM188R61E104K
C4	1	0.68 μ F \pm 10%, 10V X5R ceramic capacitor (0603) Murata GRM188R61A684K
C7	1	1 μ F \pm 10%, 10V X5R ceramic capacitor (0603) Murata GRM188R61A105K
C8	1	0.01 μ F \pm 10%, 16V X5R ceramic capacitor (0603) Murata GRM188R61C103K
C9	1	4.7 μ F \pm 10%, 25V X5R ceramic capacitor (1206) Murata GRM319R61E475K

Evaluates: MAX17005B

MAX17005B Evaluation Kit

Component List (continued)

DESIGNATION	QTY	DESCRIPTION
C10	0	Not installed, ceramic capacitor (1206)
C12	0	Not installed, ceramic capacitor (0603)
C13	1	1000pF $\pm 5\%$, 50V COG ceramic capacitor (0603) Murata GRM1885C1H102T
D1	1	200mA, 30V diode (SOD323) Diodes, Inc. BAT54WS (Top Mark: L9)
D2	0	Not installed, diode (SOD323)
JU1, JU2, JU3	3	2-pin headers
L1	1	2 μ H, 4.3A inductor Sumida CDR7D28MN-2R0NC
N1	1	30V, 5.8A n-channel MOSFET (8 SO) International Rectifier IRF9410PBF
N2	1	60V, 115mA n-channel MOSFET (3 SOT23) Vishay 2N7002K (Top Mark: 7K---)
N3	1	30V, 8.5A n-channel MOSFET (8 SO) Fairchild Semi FDS8884
N4	1	30V, 10A n-channel MOSFET (8 SO) Fairchild Semi FDS6690AS
Q1	1	30V, 6.5A/-4.9A dual n/p-channel MOSFET (8 SO) International Rectifier IRF7319PBF
R1	1	0.015 Ω $\pm 1\%$, 1/2W resistor (1206) IRC, Inc. LRC-LRF1206-LF-01-R015-F

DESIGNATION	QTY	DESCRIPTION
R2, R10, R17, R18, R22, R23	0	Not installed, resistors (0603) R2, R10, and R18 are open; R17, R22, and R23 are short (PC trace)
R3	1	1k Ω $\pm 1\%$ resistor (0603)
R4, R13	1	100k Ω $\pm 1\%$ resistors (0603)
R5	1	49.9k Ω $\pm 1\%$ resistor (0603)
R6	1	22.6k Ω $\pm 1\%$ resistor (0603)
R7	1	113k Ω $\pm 1\%$ resistor (0603)
R8	1	2M Ω $\pm 5\%$ resistor (0603)
R9	1	50k Ω single-turn potentiometer Murata PVG3A503C01
R11, R14	2	150k Ω $\pm 1\%$ resistors (0603)
R12	1	56.2k Ω $\pm 1\%$ resistor (0603)
R15	1	0 Ω $\pm 5\%$ resistor (0603)
R16	1	0.02 Ω $\pm 1\%$, 1/2W resistor (1206) IRC, Inc. LRC-LRF1206-LF-01-R020-F
R19	1	169k Ω $\pm 1\%$ resistor (0603)
R20	1	20k Ω $\pm 1\%$ resistor (0603)
R21	1	10k Ω $\pm 5\%$ resistor (0603)
U1	1	Multichemistry battery charger (20 TQFN-EP*) Maxim MAX17005BETP+
U2	1	Schmitt trigger logic inverter (5 SC70) Fairchild Semi NC7SZ14P5X (Top Mark: Z14)
—	3	Shunts (JU1, JU2, JU3)
—	1	PCB: MAX17005B EVALUATION KIT+

*EP = Exposed pad.

Component Suppliers

SUPPLIER	PHONE	WEBSITE
Diodes, Inc.	805-446-4800	www.diodes.com
Fairchild Semiconductor	888-522-5372	www.fairchildsemi.com
International Rectifier	310-322-3331	www.irf.com
IRC, Inc.	361-992-7900	www.ircct.com
Murata Electronics North America, Inc.	770-436-1300	www.murata-northamerica.com
Sumida Corp.	847-545-6700	www.sumida.com
Vishay	402-563-6866	www.vishay.com

Note: Indicate that you are using the MAX17005B when contacting these component suppliers.

MAX17005B Evaluation Kit

Quick Start

Required Equipment

- MAX17005B EV kit
- One 10V to 25V, 5A variable power supply
- Four voltmeters

Procedures

The MAX17005B EV kit is a fully assembled and tested surface-mount PCB. Follow the steps below to verify board operation. **Caution: Do not turn on the power supply until all connections are completed.**

- 1) Verify that a shunt is not installed across jumper JU1 (3 cells charging).
- 2) Verify that shunts are installed across jumpers JU2 (cell-charge voltage configured to 4.2V/cell) and JU3 (battery charging disabled).
- 3) Connect the power supply across the ADAPTER and PGND test points.
- 4) Connect a voltmeter across the BATT+ and BATT-PCB test points.
- 5) Connect a voltmeter across the SYS_LOAD and PGND test points.
- 6) Connect a voltmeter across the ISET and AGND test points.
- 7) Connect a voltmeter across the \overline{ACOK} and AGND test points.
- 8) Turn on the power supply.
- 9) Set the power-supply voltage to 20V.
- 10) Remove the shunt at jumper JU3 (battery charging enabled).
- 11) Adjust potentiometer R9 until the voltmeter connected to the ISET pad measures approximately 1.03V. This sets the charge current to 3A.
- 12) Verify the following:
- 13) The EV kit is ready for additional testing.

PARAMETER	MEASURED OUTPUT (V)
BATT+ to BATT-	12.6
SYS_LOAD	20
ISET	1.03
\overline{ACOK}	0

Detailed Description of Hardware

The MAX17005B is an evaluation kit for the MAX17005B that utilizes two single-package MOSFETs for the MAX17005B internal synchronous step-down converter.

The MAX17005B EV kit is a complete and fully assembled and tested surface-mount PCB that demonstrates the MAX17005B highly integrated, multichemistry battery charger controller. The MAX17005B integrates a high-efficiency, synchronous-rectified step-down DC-DC converter to implement a precision constant-current and constant-voltage charger. The MAX17005B thermally optimized high-frequency architecture adjusts the EV kit's typical switching frequency to 1.2MHz to control the power dissipation in the high-side MOSFET, reducing output capacitance and inductance.

The MAX17005B EV kit utilizes two single-package n-channel MOSFETs for high-side and low-side switching for the MAX17005B synchronous converter, and two n-channel MOSFETs and one p-channel MOSFET for main power-source selection. The EV kit is designed to operate from a single DC power supply that provides 10V to 25V and 5A of current.

The MAX17005B EV kit circuit is capable of supplying power to a load connected to the SYS_LOAD output, while simultaneously charging the battery pack connected between BATT+ and BATT-. During normal operation, the EV kit circuit selects the ADAPTER or the BATT+ input, through MOSFET Q1, as the main power source for the load connected at SYS_LOAD. Once the main AC adapter is selected as the power source, the EV kit circuit monitors the input current through the IINP connector. The input current is defined as the combined system-load current and battery-charge current when the ADAPTER input is the main power source. When the input current exceeds the EV kit input-current-limit threshold, the battery-charge current is reduced to give priority to the system load.

The EV kit's input-current-limit threshold is configured to 4A with resistor R1. The EV kit's cell count and maximum battery-charge-current thresholds are programmable with user-adjusted analog signals. The EV kit features on-board circuitry that allows the user to adjust or set the voltage thresholds at each of these inputs. Jumper JU1 selects the MAX17005B EV kit for 3- or 4-cell charging operation. Jumper JU2 sets the battery-charge-voltage threshold to 4.2V or 4.35V per cell. The charge current can be configured from 0.14A to 4A by adjusting the analog DC voltage at the ISET test point connector using potentiometer R9, or by applying a PWM signal at ISET. The EV kit also features an \overline{ACOK} output test point to monitor the presence of a valid input source connected at ADAPTER. See the *Setting Charge*

MAX17005B Evaluation Kit

Current section for additional information when using a PWM signal at ISET.

Power-Source Selection for System Load

To provide power at SYS_LOAD, the MAX17005B EV kit requires a 10V to 25V power source connected to the ADAPTER and PGND test points, or a power source with a 6V to 17.4V output-voltage range connected to the BATT+ and BATT- test points.

In a typical battery-charging application, the battery pack is connected between the BATT+ and BATT- terminals and an AC adapter power supply is connected between the ADAPTER and PGND terminals. When the voltage at the MAX17005B DCIN pin is greater than BATT+ by 420mV, the MAX17005B BST output drives the gates of n-channel MOSFETs N1 and Q1-A approximately 4.5V above the ADAPTER voltage, selecting ADAPTER as the main power source for supplying the load at SYS_LOAD. As long as the ADAPTER power source is present, though the charger is off, there are forced BST refresh pulses at a 5ms (min) period at the MAX17005B BST pin to properly conduct the system-load current through N1 and Q1-A.

The MAX17005B EV kit charges the batteries connected between the BATT+ and BATT- terminals when the following conditions are met:

- 1) ADAPTER > (BATT+) + 420mV (300mV falling hysteresis).
- 2) SYS_LOAD current is less than the input-current limit.
- 3) Jumper JU3 is not installed and a DC analog voltage > 26mV or a PWM signal is present at the ISET test point.

When the ADAPTER power source is removed, the MAX17005B stops generating BST refresh pulses and N2 forces N1 off. BATT+ is then selected as the SYS_LOAD power source by conducting the system-load current through the p-channel MOSFET, Q1-B.

ACOK Output Logic Signal

The EV kit features the ACOK output-logic signal that indicates the presence of a valid source connected to the ADAPTER terminal. ACOK is pulled low when the voltage at ADAPTER is > 20V; otherwise, ACOK is pulled to the MAX17005B reference output voltage VAA (4.2V).

Input-Current Limit

The EV kit input-source-current limit is set at 4A using resistor R1. The input current is the sum of the system-load current and battery-charge current when the ADAPTER input is the main power source. When the input current exceeds the input-current limit, the charging

current is reduced to provide priority to the SYS_LOAD current. As the SYS_LOAD current approaches the current-limit threshold, the charge current drops linearly to zero.

The maximum input-source-current limit can be set by replacing sense resistor R1. Use the following equation to select a new sense-resistor value:

$$R1(m\Omega) = \frac{60mV}{I_{LIMIT}}$$

where I_{LIMIT} is the input-source-current limit in amperes and R1 is the value of the sense resistor in milliohms.

Refer to the *Setting Input-Current Limit* section in the MAX17005B/MAX17006B/MAX17015B IC data sheet for additional information on setting the input-current limit if populating resistors at the R2 and R3 PCB pads.

Battery Charging

Battery Cell-Count Setting

The MAX17005B EV kit supports 3- or 4-cell Li+ battery charging. Jumper JU1 configures the MAX17005B for 3- or 4-series-cell charging operation. Remove the shunt at jumper JU1 for 3-cell charging operation. Install a shunt at jumper JU1 for 4-cell charging operation.

See Table 1 for proper jumper JU1 configuration when evaluating the MAX17005B.

Setting Charge Voltage

The EV kit's battery-charge voltage can be configured between 4.2V to 4.4V per cell for the MAX17005B using on-board circuitry resistor R12 and U2. Jumper JU2 sets the EV kit's battery-cell voltage to 4.2V or 4.35V. Install the shunt at jumper JU2 to set the EV kit battery-cell voltage to 4.2V. Remove the shunt at jumper JU2 to set the battery-cell voltage to 4.35V.

See Table 2 for proper jumper JU2 configuration when setting the battery cell voltage for the MAX17005B.

The MAX17005B battery-cell voltage can be configured from 4.2V/cell to 4.4V/cell by replacing resistor R12, which adjusts the voltage at the VCTL pin.

Use the following equations to first calculate the VCTL voltage for the desired cell voltage:

$$V_{VCTL} = 29.4V - 6 \times V_{CELL}$$

Table 1. Charge Cell Count (Jumper JU1)

SHUNT POSITION	NUMBER OF SERIES CELLS CHARGED
Not installed	3
Installed	4

MAX17005B Evaluation Kit

Table 2. Battery-Voltage Cell Charge (Jumper JU2)

SHUNT POSITIONS	BATTERY-VOLTAGE/CELL OPERATION
Not installed	4.35V/cell or adjusted battery-cell voltage
Installed	4.2V/cell

1) For 3-cell selection of MAX17005B, $4.2V > V_{VCTL} > 2.4V$.

OR

$$V_{VCTL} = 6 \times V_{CELL} - 25.2V$$

2) For 4-cell selection of MAX17005B, $0V < V_{VCTL} < 1.8V$.

Using the V_{VCTL} voltage calculated above in equations 1 and 2, use the respective equations below to calculate the total high- or low-side resistance (R_T) needed at the V_{CTL} parallel-resistor network, where R_T is R11||R12 or R14||R12:

$$R_T = 150k\Omega \times \left(\frac{4.2V}{V_{VCTL}} - 1 \right)$$

3) For 3-cell selection of MAX17005B:

$$R_T = \frac{150k\Omega}{\left(\frac{4.2V}{V_{VCTL}} - 1 \right)}$$

4) For 4-cell selection of MAX17005B.

Upon calculating R_T , and using the EV kit's R11 or R14 default $150k\Omega$ value, determine the new R12 resistor value.

The total BATT+ to BATT- battery regulation voltage can be calculated using the following equation:

$$V_{BATT+} = N_{CELLS} \times V_{CELL}$$

where V_{BATT+} is the battery regulation voltage, N_{CELLS} is the total number of cells, and V_{CELL} is the cell voltage setting.

Setting Charge Current

The MAX17005B EV kit charge current can be set up to 3.5A or 3A when applying an analog DC voltage or PWM signal, respectively, at the ISET terminal.

Potentiometer R9 adjusts the battery-charge current by applying the proper analog DC voltage at the ISET pin. While monitoring the ISET voltage through the EV kit's

Table 3. Battery Charger Control (Jumper JU3)

SHUNT POSITIONS	EV KIT CHARGE MODE
Not installed	Charger enabled and charge current set by R9 or PWM signal at ISET
Installed	Charger disabled

ISET test point, use the following equation to adjust the maximum battery-charge current to the desired value:

$$V_{ISET} = \frac{I_{CHARGE} \times R16 \times 4.2}{0.24}$$

where V_{ISET} is the voltage at the ISET test point, R16 is the $20m\Omega$ battery current-sense resistor, and I_{CHARGE} is the desired battery-charge current.

A digital PWM signal with a 128Hz to 500kHz frequency range can be applied at the ISET terminal to control the battery charging current. Refer to the *Setting Charge Current* section in the MAX17005B/MAX17006B/MAX17015B IC data sheet for proper logic levels and charge-current setting when using a PWM signal at ISET. As the duty cycle increases/decreases, the charge current linearly increases/decreases.

The EV kit's actual battery-charge current depends on the input-source-current limit and the load connected at SYS_LOAD. As the battery and SYS_LOAD current exceeds the input-source-current limit, the charging current is reduced to provide priority to the SYS_LOAD current.

Charger Shutdown

Jumper JU3 places the charger in shutdown mode. To place the charger in shutdown mode, install a shunt across jumper JU3. To enable the charger, remove the shunt at jumper JU3 and apply the appropriate analog DC voltage or PWM signal at ISET. See Table 3 for proper jumper configuration to place the charger in shutdown mode.

IINP Output Signal

The MAX17005B EV kit features an analog output test point (IINP) to monitor the adapter current through sense resistor R1. The measured current is the sum of the current applied at SYS_LOAD and the battery-charge current. The system current can be estimated using the following equation:

$$I_{INPUT} = \frac{V_{IINP}}{R1 \times R6 \times 2.8mA/V}$$

MAX17005B Evaluation Kit

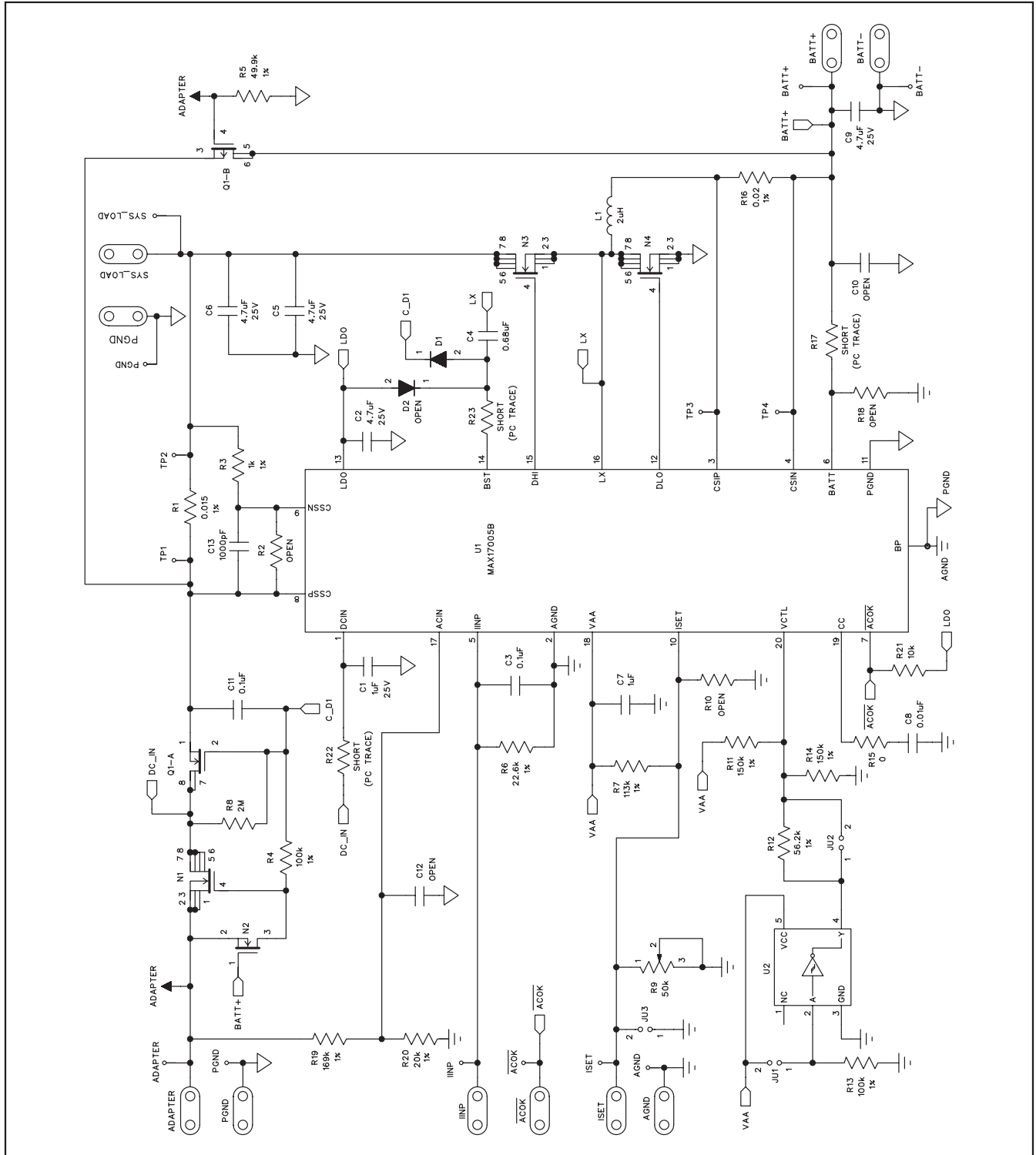

Figure 1. MAX17005B EV Kit Schematic

MAX17005B Evaluation Kit

Evaluates: MAX17005B

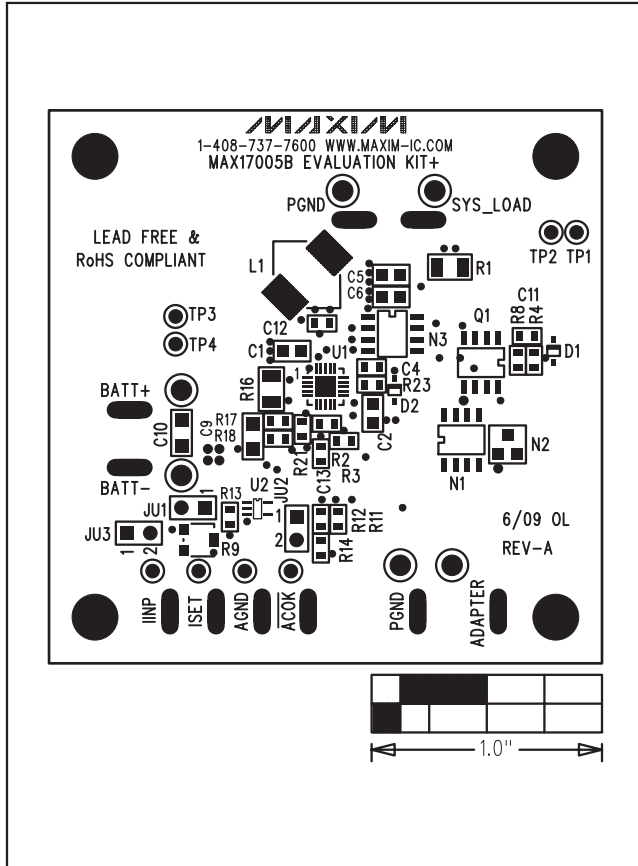

Figure 2. MAX17005B EV Kit Component Placement Guide—Component Side

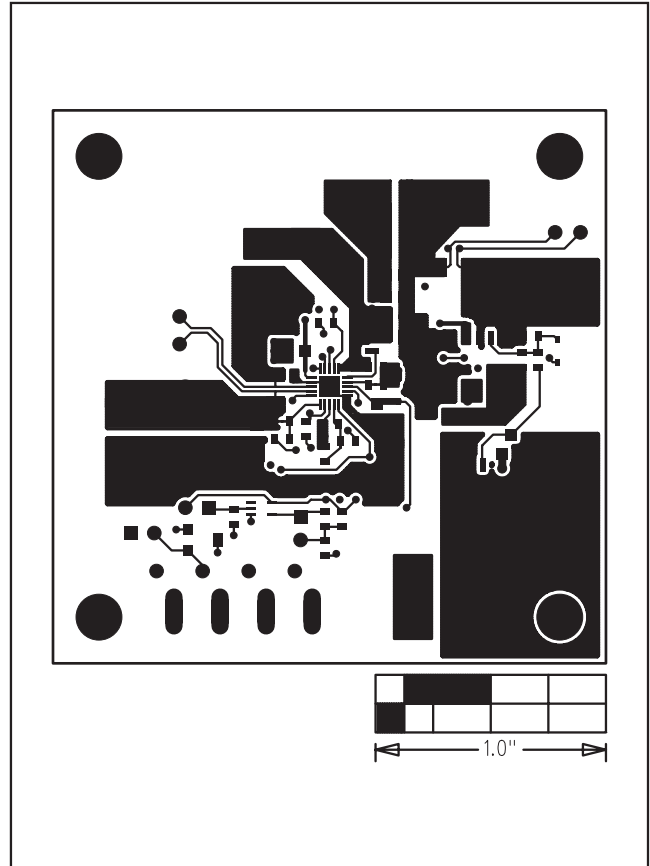

Figure 3. MAX17005B EV Kit PCB Layout—Component Side

MAX17005B Evaluation Kit

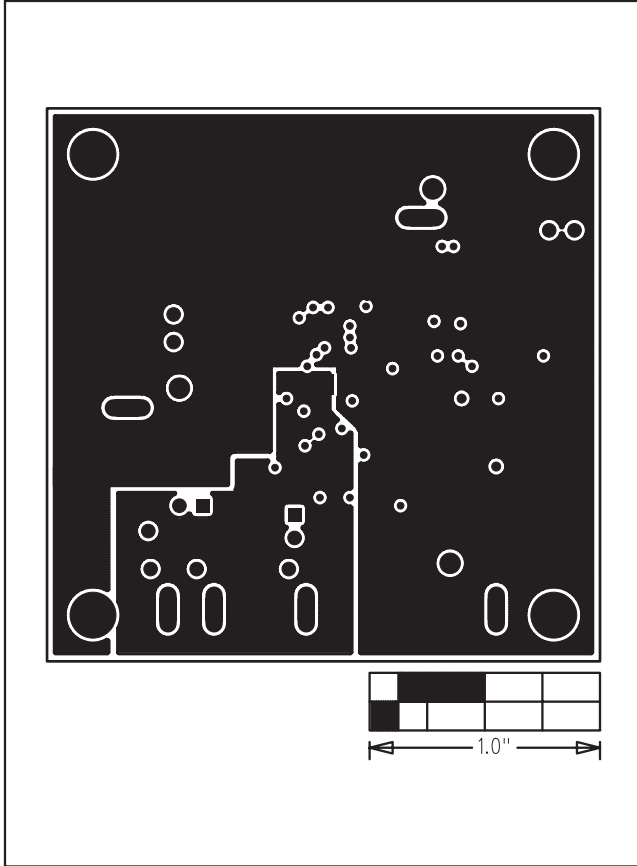

Figure 4. MAX17005B EV Kit PCB Layout—Ground Layer

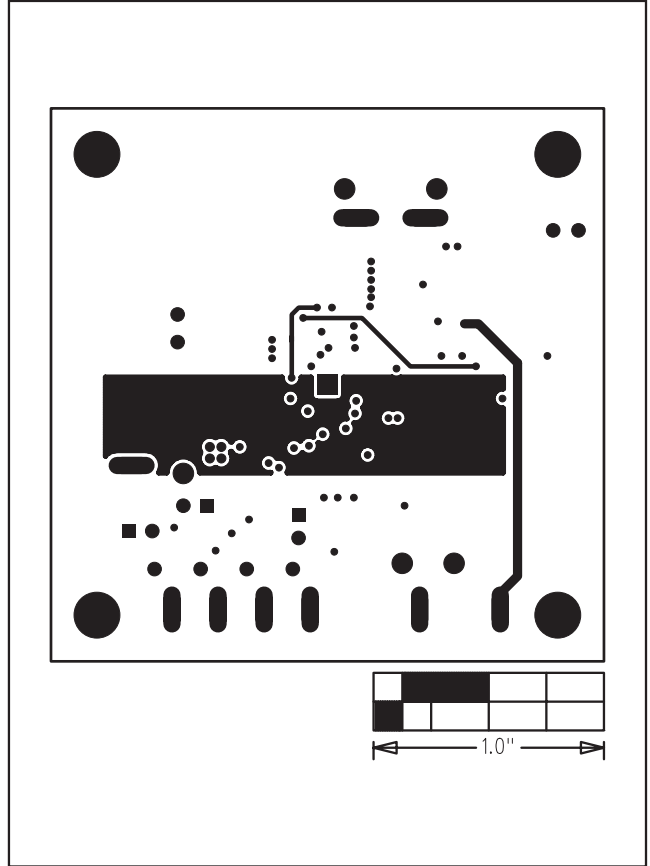

Figure 5. MAX17005B EV Kit PCB Layout—Power Layer

MAX17005B Evaluation Kit

Evaluates: MAX17005B

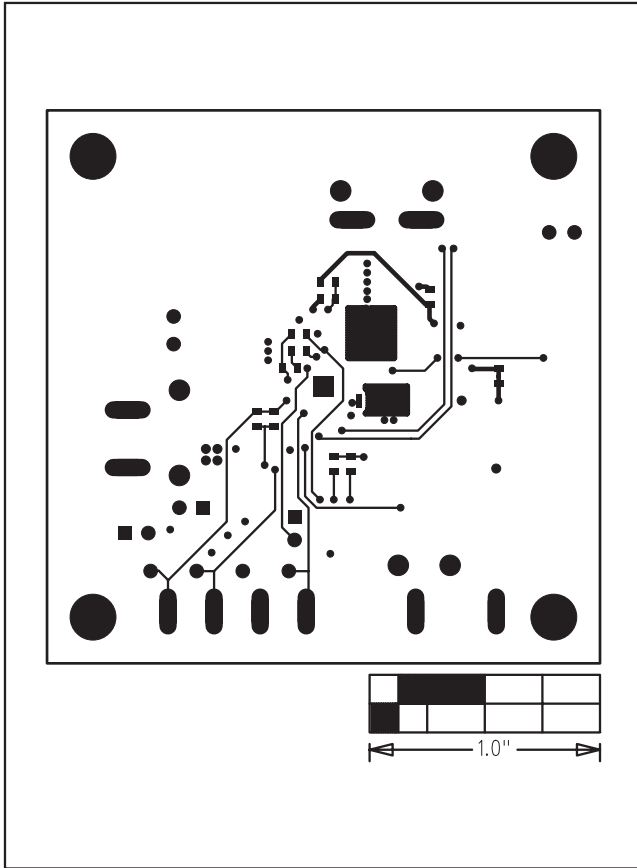

Figure 6. MAX17005B EV Kit PCB Layout—Solder Side

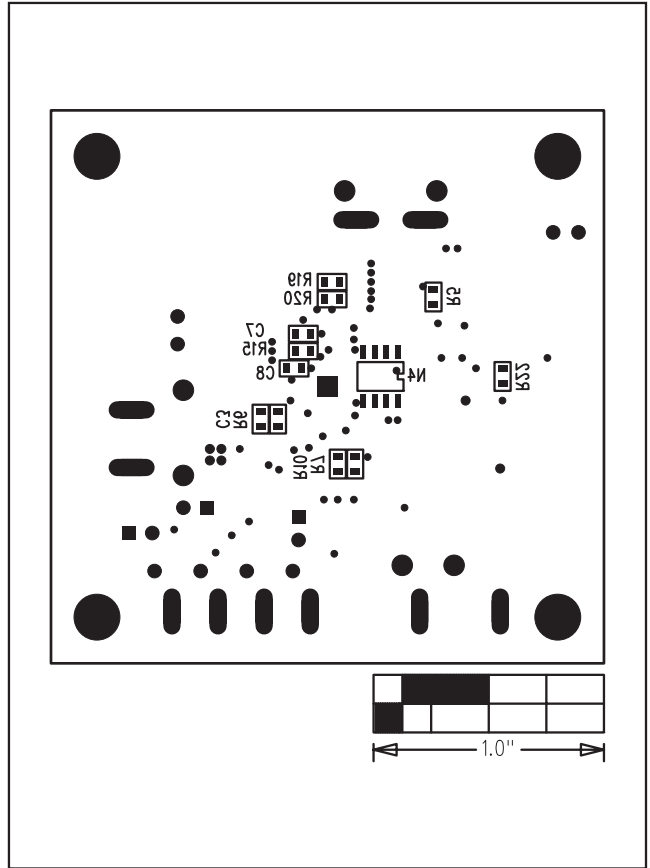

Figure 7. MAX17005B EV Kit Component Placement Guide—Solder Side

MAX17005B Evaluation Kit

Revision History

REVISION NUMBER	REVISION DATE	DESCRIPTION	PAGES CHANGED
0	5/08	Initial release	—
1	12/08	Updated <i>Component List</i> , schematic, and PCB layout diagrams	2, 7–10
2	7/09	Changed part number and updated <i>Component List</i> , schematic, and PCB layout diagrams	1–10

Maxim cannot assume responsibility for use of any circuitry other than circuitry entirely embodied in a Maxim product. No circuit patent licenses are implied. Maxim reserves the right to change the circuitry and specifications without notice at any time.

10 _____ **Maxim Integrated Products, 120 San Gabriel Drive, Sunnyvale, CA 94086 408-737-7600**