

General Description

The MAX20446 evaluation kit (EV kit) demonstrates the MAX20446 integrated 6-channel high-brightness (HB) LED backlight driver with boost/SEPIC controller and I²C interface for automotive displays.

The EV kit operates from a DC supply voltage between 4.5V and 36V and the switching frequency can be set either at 2.2MHz or at 400kHz. The EV kit operates in I²C mode only. Spread-spectrum mode (SSM) is enabled by default for EMI improvement, but can be disabled by acting on a register bit. The EV kit demonstrates phase-shifted pulse-width modulation (PWM) dimming. Dimming can be performed externally using a PWM signal applied to the DIM PCB pad, or internally by programming the desired dimming frequency and individual duty cycle through I²C. The hybrid dimming feature can be enabled through a register bit to reduce EMI. The EV kit also demonstrates short-LED, open-LED, boost output undervoltage, as well as overvoltage- and overtemperature-fault protection.

For operation at switching frequencies other than 2.2MHz or 400kHz, the external components should be chosen according to the calculations in the MAX20446 IC data sheet.

The EV kit provides an I²C interface that can operate in conjunction with the Maxim command module (MINIUSB+) or a third-party I²C master. The EV kit also includes, Windows®-compatible software that provides a simple graphical user interface (GUI) for exercising the features of the IC.

Features

- Demonstrates Robustness of the MAX20446
- Wide 4.5V to 36V Input Operating Range (Up to 52V Load Dump)
- Powers HB LEDs (Up to Six Strings) for Medium-to-Large-Sized LCD Displays in Automotive and Display Backlight Applications
- 400kHz to 2.2MHz Resistor-Programmable Switching Frequency with Spread-Spectrum Option
- Phase-Shift Dimming Option
- Demonstrates Cycle-by-Cycle Current Limit and Thermal-Shutdown Features
- Demonstrates Wide Dimming Ratio
- Demonstrates Fail-Safe Operation
- I²C Programmability
- Dedicated GUI
- Proven PCB Layout and Thermal Design
- Fully Assembled and Tested

Ordering Information appears at end of data sheet.

Windows is a registered trademark and registered service mark of Microsoft Corporation.

MAX20446 EV Kit Files

FILE	DESCRIPTION
MAX20446GUISetupV01.exe	Windows GUI Installer

Quick Start

Required Equipment

- MAX20446 EV kit
- 5V to 36V, 4A DC power supply
- Two digital voltmeters (DVMs)
- Six series-connected HB LED strings (6 LEDs each) rated to no less than 120mA
- Current probe to measure the HB LED current
- MINIQUSB+ interface board with USB cable
- Windows-compatible PC with a spare USB port

Procedure

The EV kit is fully assembled and tested. Follow the steps below to verify board operation.

Caution: Do not turn on the power supply until all connections are completed.

- 1) Visit www.maximintegrated.com/evkitsoftware to download the latest version of the EV kit software, MAX20446GUISetupV01.exe.
- 2) Install the EV kit software (GUI) on your PC by running the MAX20446GUISetupV01.exe program. The EV kit software application is installed together with the required MINIQUSB+ drivers.
- 3) Verify that jumper J17 is closed and jumper J22 is open (2.2MHz switching frequency selected).
- 4) Verify that jumper J1 is closed (DS1 green LED connected).
- 5) Verify that jumper J23 is closed (FSEN function disabled).
- 6) Verify that jumper J20 is closed (FLTB signaling enabled).
- 7) Verify that a shunt is installed across pins 1-2 on jumper J2 (device enabled).
- 8) Verify that jumpers JMP1–JMP3, JMP6–JMP7 and JMP9 have shunts installed across pins 1-2 (bleed resistors connected, all current sinks enabled).
- 9) Connect the MINIQUSB+ interface board's P3 header to the J24 header on the EV kit.
- 10) Connect the positive terminal of the power supply to the IN PCB pad. Connect the negative terminal of the power supply to a PGND PCB pad.
- 11) Connect a DVM across the OUT1 and GND PCB pads.
- 12) Connect the six LED strings from VOUT to the OUT1, OUT2, OUT3, OUT4, OUT5, and OUT6 PCB pads.
- 13) Clip the current probe across the channel 1 HB LED+ wire to measure the LED current.
- 14) Turn on the power supply and set to 12V. The green LED (DS1) should be on at this point.
- 15) Launch the EV kit software application.
- 16) From the EV kit software toolbar, select **Device** → **Scan for Address**. The GUI scans the I²C bus for available slave addresses on the bus and selects the first one (in this case, the MAX20446 I²C address). Press **OK** once the MAX20446 I²C address has been found.
- 17) Verify that the status bar in the bottom-right corner of the GUI displays **EV Kit: Connected**, as shown in [Figure 1](#).
- 18) Select the desired OUT_ current value (45mA to 120mA in 5mA steps) in the **0x02 ISET** register group box by acting on the **ISET** slider bar, then click the **Refresh** button.
- 19) Check **ENA** to activate the driver in the **0x02 ISET** register group box.
- 20) Measure the voltage from each of the OUT_ PCB pads to PGND and verify the lowest voltage is ≈1V.
- 21) Measure the LED current using the current probe and verify all channels.
- 22) For more details on how to use the GUI and all the features available, click on the GUI **Help** menu item.

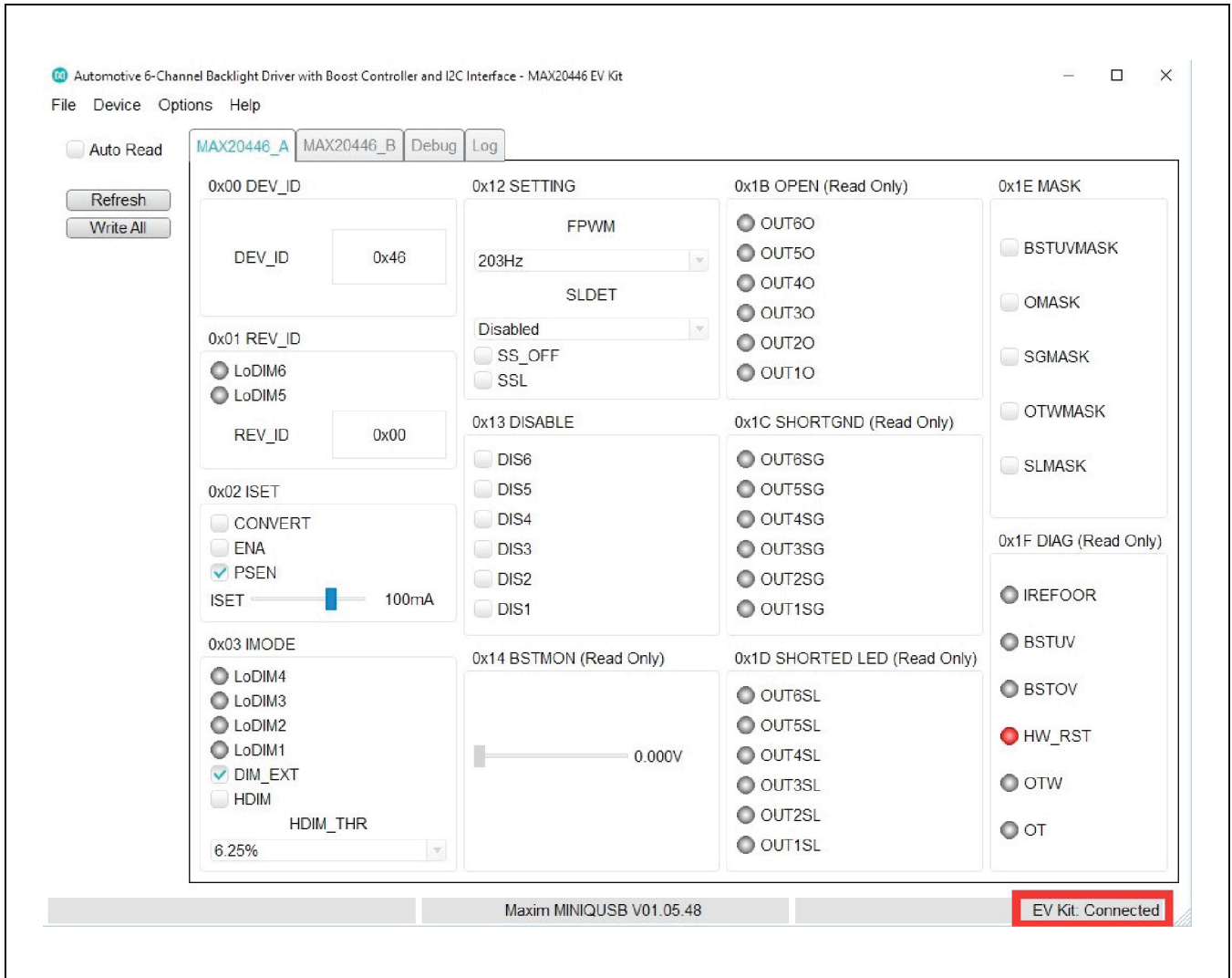

Figure 1. MAX20446 Evaluation Kit Software (GUI)

Detailed Description of Hardware

The MAX20446 EV kit demonstrates the MAX20446 HB LED backlight driver with an integrated step-up DC-DC preregulator, followed by six linear current sinks to drive up to six strings of LEDs. The preregulator switches at 2.2MHz (or at 400kHz) and operates as a current-mode-controlled regulator, providing up to 720mA for the linear current sinks as well as overvoltage protection. The cycle-by-cycle current limit is set by resistor R27, while resistors R4 and R5 set the overvoltage-protection voltage to 29V. The preregulator power section consists of inductor L2, power-sense resistor R27, MOSFET Q4, and switching-diode D1. The EV kit circuit operates from a 4.5V DC supply voltage up to the HB LED forward string voltage. The circuit handles load-dump conditions up to 50V.

The EV kit circuit demonstrates ultra-low shutdown current when the device’s EN pin is pulled to ground by shorting the EN PCB pad to ground. Each of the six linear current sinks (OUT1–OUT6) is capable of operating up to 48V, sinking up to 120mA per channel.

Each of the six channels’ linear current sinks is I²C-configurable for 45mA to 120mA in 5mA steps, or can be disabled independently by acting on the **0x13 DISABLE** register group box, or on jumpers JMP1–JMP3, JMP6–JMP7, and JMP9, which are used to disable outputs selectively when the HB LED string is not connected. The EV kit features PCB pads to facilitate connecting HB LED strings for evaluation. The VOUT PCB pads provide connections for connecting each HB LED string’s anode to the DC-DC preregulator output. The OUT1–OUT6 PCB pads provide connections for connecting each HB LED string’s cathode to the respective current sink. Capacitors C11, C14, C18, C23, C24, and C25 are included on the design to prevent oscillations and provide stability when using long, untwisted HB LED connecting cables during lab evaluation. These capacitors are not required if the connection between the LED driver and HB LEDs is a low-inductance connection.

A DIM PCB pad is provided for using a digital PWM signal to control the brightness of the HB LEDs. Test points are also provided for easy access to the device’s V_{CC} regulator output, as well as the COMP pin and the switching node of the preregulator (LX).

SDA and SCL Voltages (J18, J19, and J21)

SDA and SCL voltage supplies can be selected between the V_{CC} voltage and the fixed 3.3V provided by the MINIQUSB+. Alternatively, the user can force an external voltage as digital reference (Table 1).

Power LED Enable (J1)

A green LED (DS1) is used to indicate that the EV kit is powered on. The LED can be disconnected from the power supply, allowing precise current-consumption evaluation. See Table 2 for shunt positions.

Enable (EN)

The EV kit features an enable input that can be used to enable/disable the device and place it in shutdown mode. To enable the EV kit whenever power is applied to IN, place the jumper across pins 1-2 on jumper J2. To enable the EV kit using an external enable signal, place the jumper across pins 2-3 on J2 and apply a logic signal on the EN PCB input pad on the EV kit. A 1MΩ pulldown resistor on the EV kit pulls the EN input to ground in the event that JU15 is left open or the EN signal is high impedance. Refer to the *Enable* section in the MAX20446 IC data sheet for additional information. See Table 3 for jumper settings.

Table 1. SDA and SCL Supply (J18, J19, and J21)

SHUNT POSITION			SDA AND SCL SUPPLY
J18	J19	J21	
Open*	Open*	Open*	3.3V (with the MINIQUSB+ connected)
Closed	Closed	Open	V _{CC}
Open	Open	1-2	Externally provided

*Default position.

Table 2. DS1 Enable (J1)

SHUNT POSITION	DS1 POWER LED
Closed*	Connected
Open	Disconnected

*Default position.

Table 3. Enable (J2)

SHUNT POSITION	EN PIN	EV KIT OPERATION
1-2*	Connected to IN	Enabled when IN is powered
2-3	Connected to the EN PCB pad	Enabled/disabled by signal on EN PCB pad

*Default position.

Switching Frequency

Jumpers J17 and J22 are used to set the switching frequency of the device to 2.2MHz or 400kHz. When J17 is closed and J22 is open, the switching frequency is set to 2.2MHz. When J17 is open and J22 is closed, the switching frequency is nominally 400kHz. See [Table 4](#) for shunt positions.

The EV kit is optimized for 2.2MHz switching operation by default. When selecting a switching frequency of 400kHz, L2 should be changed to 22µH to maintain acceptable efficiency. Other component-value adjustments may be needed.

The spread-spectrum feature can be enabled/disabled by checking/unchecking **SS_OFF** in the **0x12 SETTING** register group box. With spread spectrum enabled, it is also possible to select the amount of spread by checking ($\pm 3\%$)/unchecking ($\pm 6\%$) **SSL** in the **0x12 SETTING** register group box.

Refer to the *Oscillator Frequency/External Synchronization* and *Spread-Spectrum Mode* sections in the MAX20446 IC data sheet for more information.

HB LED Current

The device’s current sinks’ current on all six channels is fully configurable through I²C (**ISET** slider bar in the **0x02 ISET** register group box). No direct action on the EV kit is needed.

Channel 1–Channel 6 Current-Sink Disabling

The EV kit features jumpers JMP1–JMP3, JMP6, JMP7, and JMP9 that can be used to put each OUT_ current sink in one of three operating states:

1. Normal operation: OUT_ connected to the corresponding ring on the board edge, with LEDs connected from there to the preregulator output (VOUT).
2. OUT_ connected through a 12kΩ resistor to GND and thus disabled.
3. OUT_ shorted to GND, used to test fault detection.

To disable a channel, install a shunt in the channel’s respective jumper across pins 1-3, connecting OUT_ to ground through a 12kΩ resistor. The dimming algorithm in the device requires higher numbered OUT_ current sinks be disabled first (e.g., if only two strings are needed, OUT1/OUT2 should be used, with OUT3–OUT6 disabled). See [Table 5](#) for jumper settings. The 100kΩ bleed resistors are installed to prevent the OUT_ leakage current from dimly turning on large LED strings even when the DIM signal is low. Note that each channel can be alternatively disabled through I²C by acting on **0x13 DISABLE** register group box.

HB LED Digital Dimming Control

The EV kit features a DIM PCB input pad for connecting an external digital PWM signal. Apply a digital PWM signal with a $\leq 0.8V$ logic-low level and $\geq 2.1V$ logic-high level. The DIM signal frequency should be at least 100Hz. If the DIM frequency is changed during operation, the device must be powered off and on again to register the change. To adjust the HB LED brightness, vary the signal duty cycle from 0% to 100% and maintain a minimum pulse width of 500ns. Apply the digital PWM signal to the DIM PCB pad. The DIM input of the device is pulled up internally with a 5µA (typ) current source.

Dimming can also be performed by programming the desired dimming level through I²C. External dimming is enabled by default at each device’s power-up. To disable it, first uncheck **DIM_EXT** in the **0x03 IMODE** register group box, and select one of the available dimming frequencies in the **FPWM** section in the **0x12 SETTING** register group box. Individual channel brightness levels can finally be selected by acting on the **TON1–TON6** slider bars.

Note: To ensure that correct brightness levels are selected in internal dimming mode, each **TON_** slider bar must be zeroed at each device’s power-up.

For additional information on the device’s digital dimming feature, refer to the *Dimming* section in the MAX20446 IC data sheet.

Table 4. Switching Frequency (J17 and J22)

SHUNT POSITION		RT PIN	EV KIT OPERATION
J17	J22		
Closed*	Open*	RT connected to GND through a 13.3kΩ resistor	2.2MHz switching frequency
Open	Closed	RT connected to GND through a 76.8kΩ resistor	400kHz switching frequency

*Default position.

Table 5. Selecting OUT_ Channel Operating State (JMP1–JMP3, JMP6, JMP7, and JMP9)

OUT_	JUMPER	SHUNT POSITION	CHANNEL OPERATION
OUT1	JMP9	1-2*	Channel 1 operational. Connect an HB LED string** between VOUT and OUT1. Bleed resistor connected.
		1-3	Channel 1 not used. OUT1 current sink disabled.
		1-4	Channel 1 shorted to GND to simulate a fault.
OUT2	JMP7	1-2*	Channel 2 operational. Connect an HB LED string** between VOUT and OUT2. Bleed resistor connected.
		1-3	Channel 2 not used. OUT2 current sink disabled.
		1-4	Channel 2 shorted to GND to simulate a fault.
OUT3	JMP6	1-2*	Channel 3 operational. Connect an HB LED string** between VOUT and OUT3. Bleed resistor connected.
		1-3	Channel 3 not used. OUT3 current sink disabled.
		1-4	Channel 3 shorted to GND to simulate a fault.
OUT4	JMP3	1-2*	Channel 4 operational. Connect an HB LED string** between VOUT and OUT4. Bleed resistor connected.
		1-3	Channel 4 not used. OUT4 current sink disabled.
		1-4	Channel 4 shorted to GND to simulate a fault.
OUT5	JMP2	1-2*	Channel 5 operational. Connect an HB LED string** between VOUT and OUT5. Bleed resistor connected.
		1-3	Channel 5 not used. OUT5 current sink disabled.
		1-4	Channel 5 shorted to GND to simulate a fault.
OUT6	JMP1	1-2*	Channel 6 operational. Connect an HB LED string** between VOUT and OUT6. Bleed resistor connected.
		1-3	Channel 6 not used. OUT6 current sink disabled.
		1-4	Channel 6 shorted to GND to simulate a fault.

*Default position.

**Series-connected HB LED string must be rated to no less than 120mA.

Hybrid Dimming Operation

The hybrid dimming feature can be used with both external and internal dimming. The device determines whether the LED current must be dimmed by reducing the LED current, or chopping the LED current (depending on the hybrid dimming threshold set in the **HDIM_THR** section in the **0x03 IMODE** register group box). To enable the hybrid dimming feature, check **HDIM** in the **0x03 IMODE** register group box.

For additional information on the device's hybrid dimming feature, refer to the *Hybrid Dimming* section in the MAX20446 IC data sheet.

Phase-Shift Operation

The EV kit demonstrates the phase-shifting feature of the device. Phase shift is enabled by default at each device's power-up. To disable it, uncheck **PSEN** in the **0x02 ISET** register group box. This operation must always be performed before enabling any LED string.

When phase shifting is enabled, each current sink's turn-on is separated by $360^\circ/n$, where n is the number of enabled strings. When phase shifting is disabled, the dimming of each string is controlled by the DIM input (or by the FPWM and TON_ settings, if internal dimming is enabled), and all current sinks turn on and off at the same time.

Fail-Safe Operation

The EV kit demonstrates the fail-safe feature of the device. One of the jumpers (J3–J6, J8, J10, J12, J14) can be closed before powering up the device to select, through a resistor to ground, the current level to which the current sinks are enabled in case the FSEN PCB pad is connected to V_{CC}. If jumper J23 is closed, FSEN is shorted to ground and its function disabled. Only one jumper at a time must be closed. See Table 6 for jumper settings.

For additional information on the device’s fail-safe operation, refer to the *MAX20446 FSEN Pin Function* section in the MAX20446 IC data sheet.

Fault-Indicator Output (FLTB)

The EV kit features the device’s open-drain FLTB output. The FLTB signal is pulled up to V_{CC} by resistor R48. FLTB goes low when an open-LED or shorted-LED string is detected during thermal warning/shutdown, or during boost undervoltage/overvoltage events. Keep jumper J20 closed to allow the DS2 red LED enabling in case FLTB goes low. Refer to the *Fault Protection* section in the MAX20446 IC data sheet for additional information on the FLTB signal.

Shorted-LED Detection and Protection

The short-LED threshold is set through I²C in the SLDET section in the **0x12 SETTING** register group box. A

shorted-LED is detected when the following condition is satisfied:

$$V_{OUT} > V_{SLDET}$$

When the short-LED threshold is reached, the affected current sink is disabled to reduce excess power dissipation and the FLTB indicator asserts low.

Overvoltage Detection and Protection

The resistors (R4 and R5) connected to BSTMON are configured for a VOUT_OVP of 29V. This sets the maximum converter output (VOUT) voltage at 29V. During an open-LED string condition, the converter output ramps up to the output overvoltage threshold. Capacitor C3 can be added to provide noise filtering to the overvoltage signal. To reconfigure the circuit for a different voltage, replace resistor R4 with a different value using the following equation:

$$R4 = [(V_{OUT_OVP}/1.23) - 1] \times R5$$

where R5 is 10kΩ, VOUT_OVP is the desired overvoltage-protection threshold, and R4 is the new resistor value for obtaining the overvoltage protection. MOSFET Q1 is an optional overvoltage-protection resistor-divider disconnect switch for ultra-low shutdown current. Refer to the *Open-LED Management and Overvoltage Protection* section in the MAX20446 IC data sheet for additional information.

Table 6. Selecting FSEN Resistor (J3–J6, J8, J10, J12, J14, J23)

FSEN RESISTOR VALUE (kΩ)	JUMPER	SHUNT POSITION	OUT_ CURRENT (mA)
0 (FSEN shorted to GND)*	J23	Closed	Fail-safe disabled
3.48	J14	Closed	25
7.15	J12	Closed	25
12	J10	Closed	50
18.7	J8	Closed	50
27.4	J6	Closed	75
39	J5	Closed	75
59	J4	Closed	100
84.5	J3	Closed	100

*Default position

Ordering Information

PART	TYPE
MAX20446EVKIT#	EV Kit

#Denotes RoHS compliant.

MAX20446 EV Kit Bill of Materials

REF DESIGNATOR	QTY	VALUE	DESCRIPTION	MFG PART #	MANUFACTURER
C1, C19, C3	0	OPEN	DNP: CAPACITOR; SMT (0603); OPEN; FORMFACTOR	N/A	N/A
C2, C6, C16	3	1UF	CAPACITOR; SMT (0603); CERAMIC CHIP; 1UF; 50V; TOL=10%; MODEL=_MK SERIES; TG=-55 DEGC TO +85 DEGC	UMK107BJ105KA-T; C1608X5R1H105K080AB; CL10A105KB8NNN; GRM188R61H105KAAL	TAIYO YUDEN; TDK; SAMSUNG; MURATA
C4	1	0.1UF	CAPACITOR; SMT (0603); CERAMIC CHIP; 0.1UF; 100V; TOL=10%; TG=-55 DEGC TO +125 DEGC; TC=X7S	CGA3E3X7S2A104K080A B	TDK
C5, C26, C31	3	4.7UF	CAPACITOR; SMT (1210); CERAMIC CHIP; 4.7UF; 50V; TOL=10%; TG=-55 DEGC TO +125 DEGC; TC=X7R	C1210C475K5RAC; GRM32ER71H475KA88; GRM32ER71H475KA88	KEMET; MURATA; MURATA
C7, C8	0	4.7UF	DNP: CAPACITOR; SMT (1210); CERAMIC CHIP; 4.7UF; 50V; TOL=10%; TG=-55 DEGC TO +125 DEGC; TC=X7R	C1210C475K5RAC; GRM32ER71H475KA88; GRM32ER71H475KA88	KEMET; MURATA; MURATA
C9, C10	2	47UF	CAPACITOR; SMT (CASE_F); ALUMINUM-ELECTROLYTIC; 47UF; 50V; TOL=20%; MODEL=TG SERIES; TG=-40 DEGC TO +125 DEGC	EEE-TG1H470UP	PANASONIC
C11, C12, C14, C18, C23-C25	7	1000PF	CAPACITOR; SMT (0603); CERAMIC CHIP; 1000PF; 50V; TOL=5%; TG=-55 DEGC TO +125 DEGC	GRM1885C1H102JA01; C1608C0G1H102J080	MURATA;TDK
C13	1	0.047UF	CAPACITOR; SMT (0603); CERAMIC CHIP; 0.047UF; 50V; TOL=10%; MODEL=X7R; TG=-55 DEGC TO +125 DEGC; TC=	C0603C473K5RAC; GCM188R71H473K; GRM188R71H473K	KEMET; MURATA; MURATA
C15, C30, C32	0	2.2UF	DNP: CAPACITOR; SMT (0805); CERAMIC CHIP; 2.2UF; 50V; TOL=10%; MODEL=; TG=-55 DEGC TO +125 DEGC; TC=X7R	C2012X7R1H225K	TDK
C17	1	10PF	CAPACITOR; SMT (0603); CERAMIC CHIP; 10PF; 50V; TOL=+-5PF; MODEL=COG; TG=-55 DEGC TO +85 DEGC; TC=+/-	ECJ-1VC1H100D	PANASONIC
C20	1	2.2UF	CAPACITOR; SMT (0603); CERAMIC CHIP; 2.2UF; 10V; TOL=10%; TG=-55 DEGC TO +125 DEGC; TC=X7R	GRM188R71A225KE15;CL10B225KP8NNN;C1608X7R1A225K080AC	MURATA; SAMSUNG; TDK
C21	1	2200PF	CAPACITOR; SMT (0603); CERAMIC; 2200PF; 50V; TOL=5%; TG=-55 DEGC TO +125 DEGC; TC=COG	GRM1885C1H222JA01	MURATA

MAX20446 EV Kit Bill of Materials (continued)

REF DESIGNATOR	QTY	VALUE	DESCRIPTION	MFG PART #	MANUFACTURER
C22	1	0.068UF	CAPACITOR; SMT; 0603; CERAMIC; 0.068uF; 50V; 5%; X7R; -55degC to + 125degC; 0 +/- 15% degC MAX.	C0603C683J5RAC	KEMET
C27	1	100PF	CAPACITOR; SMT (0603); CERAMIC CHIP; 100PF; 50V; TOL=5%; TG=-55 DEGC TO +125 DEGC; TC=X7R	06035C101JAT	AVX
C28	1	22PF	CAPACITOR; SMT (0603); CERAMIC CHIP; 22PF; 50V; TOL=5%; TG=-55 DEGC TO +125 DEGC; TC=X7R	06035C220JAT	AVX
C29	0	OPEN	EVKIT USE ONLY;DUAL PACKAGE OUTLINE 0603 AND 0805 NON-POLAR CAPACITOR	N/A	N/A
C226	1	2.2UF	CAPACITOR; SMT (0805); CERAMIC CHIP; 2.2UF; 50V; TOL=10%; MODEL=; TG=-55 DEGC TO +125 DEGC; TC=X7R	C2012X7R1H225K	TDK
COMP, LX, TP1, TP2, VCC	5	5011	TEST POINT; PIN DIA=0.125IN; TOTAL LENGTH=0.445IN; BOARD HOLE=0.063IN; BLACK; PHOSPHOR BRONZE WIRE SILVER PLATE FINISH;	5011	N/A
D1	1	NRVBS260T3G	DIODE; SCH; SURFACE MOUNT SCHOTTKY POWER RECTIFIER; SMB; PIV=60V; IF=2A	NRVBS260T3G	ON SEMICONDUCTOR
D2, D3	2	18V	DIODE; ZNR; SMT (DO-214AC); VZ=18V; IZM=0.025A	BZG03C18	VISHAY SEMICONDUCTORS
D4	1	B160B-13-F	DIODE; SCH; SMB (DO-214AA); PIV=60V; IF=1A	B160B-13-F	DIODES INCORPORATED
D5	1	CMPD914E	DIODE; SWT; SMT (SOT23-3); PIV=150V; IF=0.1A	CMPD914E	CENTRAL SEMICONDUCTOR
DIM, EN, FLT, FSEN, GND, GND1, GND2, IN, OUT1-OUT6, PGND, PGND1, PGND2, SCL, SDA, SYNC, VOUT, VOUT1-VOUT3	24	MAXIMPAD	EVK KIT PARTS; MAXIM PAD; WIRE; NATURAL; SOLID; WEICO WIRE; SOFT DRAWN BUS TYPE- S; 20AWG	9020 BUSS	WEICO WIRE
DS1	1	LGL29K-F2J1-24-Z	DIODE; LED; SMARTLED; GREEN; SMT; PIV=1.7V; IF=0.02A	LGL29K-F2J1-24-Z	OSRAM
DS2	1	LS L29K-G1J2-1-Z	DIODE; LED; SMART; RED; SMT (0603); PIV=1.8V; IF=0.02A; -40 DEGC TO +100 DEGC	LS L29K-G1J2-1-Z	OSRAM
J1, J3-J6, J8, J10, J12, J14, J17-J20, J22, J23	15	PBC02SAAN	CONNECTOR; MALE; THROUGH HOLE; BREAKAWAY; STRAIGHT; 2PINS	PBC02SAAN	SULLINS ELECTRONICS CORP.

MAX20446 EV Kit Bill of Materials (continued)

REF DESIGNATOR	QTY	VALUE	DESCRIPTION	MFG PART #	MANUFACTURER
J2, J21	2	PEC03SAAN	EVKIT PART-CONNECTOR; MALE; THROUGH HOLE; BREAKAWAY; STRAIGHT; 3PINS; -65 DEGC TO +125 DEGC;	PEC03SAAN	SULLINS ELECTRONICS CORP.
J24	1	803-87-020-20- 001101	EVKIT PART-CONNECTOR; FEMALE; TH; DOUBLE ROW; 2.54MM; RIGHT ANGLE SOLDER TAIL; MATING PIN DIA 0.76MM; RIGHT ANGLE; 20PINS;	803-87-020-20-001101	PRECI-DIP SA
J25	1	HTSW-112-11-G-S- RA	CONNECTOR; MALE; THROUGH HOLE; SQUARE POST HEADER; RIGHT ANGLE; 12PINS ;	HTSW-112-11-G-S-RA	SAMTEC
JMP1-JMP3, JMP6, JMP7, JMP9	6	PEC04SAAN	CONNECTOR; MALE; THROUGH HOLE; BREAKAWAY; STRAIGHT; 4PINS	PEC04SAAN	SULLINS ELECTRONICS CORP.
L1	1	0.60UH	INDUCTOR; SMT; CORE MATERIAL= COMPOSITE; 0.60UH; TOL=+/-20%; 11.7A	XAL4020-601ME	COILCRAFT
L2	1	4.7UH	INDUCTOR; SMT; FERRITE CORE; 4.7UH; TOL=+/-20%; 9.70A	MSS1246T-472ML	COILCRAFT
L3	0	10UH	DNP: INDUCTOR; SMT; COMPOSITE CORE; 10UH; TOL=+/-20%; 4.9A	XAL5050-103ME	COILCRAFT
Q1	1	NDS351AN	TRAN; N-CHANNEL LOGIC LEVEL ENHANCEMENT MODE FIELD EFFECT TRANSISTOR; NCH; SUPERSOT-3; PD-(0.5W); I- (1.4A); V-(30V)	NDS351AN	FAIRCHILD SEMICONDUCTOR
Q2	1	MMBT3906-7-F	TRAN; 40V PNP SMALL SIGNAL TRANSISTOR; PNP; SOT-23; PD- (0.31W); I-(-0.2A); V-(-40V)	MMBT3906-7-F	DIODES INCORPORATED
Q3	1	SUM55P06-19L-E3	TRAN; P-CHANNEL 60V D-S ENHANCEMENT MODE MOSFET; PCH; TO-263-3; PD- (3.75W); I-(-55A); V-(-60V)	SUM55P06-19L-E3	VISHAY SILICONIX
Q4	1	NVMFS5826NLT1 G	TRAN; POWER MOSFET; SINGLE N-CHANNEL; NCH; SO- 8FL; PD-(39W); I-(26A); V-(60V)	NVMFS5826NLT1G	ON SEMICONDUCTOR
Q5	1	SI1317DL-T1-GE3	TRAN; P-CHANNEL 20V (D-S) MOSFET; PCH; SOT-323; PD- (0.5W); I-(-1.4A); V-(-20V)	SI1317DL-T1-GE3	VISHAY SILICONIX
R1, R33	0	OPEN	DNP: RESISTOR; 0603; OPEN; FORMFACTOR	N/A	N/A
R2	1	3K	RESISTOR; 0603; 3K OHM; 1%; 100PPM; 0.10W; THICK FILM	CRCW06033K00FK	VISHAY DALE

MAX20446 EV Kit Bill of Materials (continued)

REF DESIGNATOR	QTY	VALUE	DESCRIPTION	MFG PART #	MANUFACTURER
R3, R7	2	0	RESISTOR; 0805; 0 OHM; JUMPER; 0.125W; THICK FILM	CRCW08050000ZS; ERJ- 6GEY0R00V; RC2012J000; RMCF0805ZT0R00	DIGI-KEY
R4	1	226K	RESISTOR; 0805; 226K OHM; 1%; 100PPM; 0.125W; THICK FILM	CRCW0805226KFK	VISHAY DALE
R5	1	10K	RESISTOR; 0805; 10K OHM; 0.1%; 25PPM; 0.125W; THIN FILM	TNPW080510K0BE;ERA- 6YEB103V	VISHAY DALE;PANASONIC
R6	1	10K	RESISTOR, 0603, 10K OHM, 5%, 200PPM, 1/16W, THICK FILM	301-10K-RC	XICON
R8	1	0	RESISTOR; 1206; 0 OHM; 0%; JUMPER; 0.25W; THICK FILM	CRCW12060000ZS;ERJ- 8GEY0R00V	VISHAY DALE; PANASONIC
R9	1	1M	RESISTOR, 0603, 1M OHM, 1%, 100PPM, 0.10W, THICK FILM	CRCW06031M00FK; MCR03EZPFX1004	VISHAY DALE; ROHM
R10, R17, R23, R34, R37, R43	6	100K	RESISTOR; 0603; 100K; 1%; 100PPM; 0.10W; THICK FILM	CRCW0603100KFK	VISHAY DALE
R11	1	18K	RESISTOR, 0603, 18K OHM, 1%, 100PPM, 0.10W, THICK FILM	CRCW060318K0FK	VISHAY DALE
R12, R19, R22, R29, R36, R38, R45	7	12K	RESISTOR, 0603, 12K OHM, 1%, 100PPM, 0.10W, THICK FILM	CRCW060312K0FK	VISHAY DALE
R13	1	84.5K	RESISTOR; 0603; 84.5K OHM; 1%; 100PPM; 0.10W; THICK FILM	RC0603FR-0784K5L	YAGEO PHYCOMP
R14	1	0.05	RESISTOR; 1206; 0.05 OHM; 1%; 75PPM; 1W; THICK FILM	ERJ-8CWFR050	PANASONIC
R15, R49	2	1K	RESISTOR; 0603; 1K OHM; 0.1%; 10PPM; 0.10W; THICK FILM	RG1608N-102-B-T1	SUSUMU CO LTD.
R16	1	59K	RESISTOR; 0603; 59K OHM; 1%; 100PPM; 0.1W; THICK FILM	ERJ-3EKF5902	PANASONIC
R18	1	27.4K	RESISTOR; 0603; 27.4K OHM; 1%; 100PPM; 0.1W; THICK FILM	ERJ-3EKF2742	PANASONIC
R20	1	18.7K	RESISTOR; 0603; 18.7K OHM; 1%; 100PPM; 0.1W; THICK FILM	CRCW060318K7FK	VISHAY DALE
R24	1	3.74K	RESISTOR, 0603, 3.74KOHMS, 1%, 100PPM, 0.1W, THICK FILM	CRCW06033K74FK	VISHAY DALE
R26	1	22	RESISTOR; 0603; 22 OHM; 5%; 200PPM; 0.10W; THICK FILM	CRCW060322R0JN	VISHAY DALE
R27	1	0.04	RESISTOR; 1206; 0.04 OHM; 1%; 75PPM; 0.25W; THICK FILM	WSL1206R0400F	VISHAY DALE

MAX20446 EV Kit Bill of Materials (continued)

REF DESIGNATOR	QTY	VALUE	DESCRIPTION	MFG PART #	MANUFACTURER
R28	1	7.15K	RESISTOR; 0603; 7.15K OHM; 1%; 100PPM; 0.10W; THICK FILM	ERJ-3EKF7151V	PANASONIC
R31	0	OPEN	RESISTOR; 1206; OPEN; FORMFACTOR	N/A	N/A
R32	1	39K	RESISTOR, 0603, 39K OHM, 1%, 100PPM, 0.10W, THICK FILM	CRCW060339K0FK	VISHAY DALE
R35	1	8.06K	RESISTOR; 0603; 8.06K OHM; 1%; 100PPM; 0.1W; THICK FILM	CRCW06038K06FK;ERJ-3EKF8061V	VISHAY DALE; PANASONIC
R39	1	76.8K	RESISTOR; 0603; 76.8K OHM; 1%; 100PPM; 0.10W; THICK FILM	CRCW060376K8FK	VISHAY DALE
R42, R48, R55	3	10K	RESISTOR; 0603; 10K OHM; 1%; 100PPM; 0.0125W; THICK FILM	CHPHT0603K1002FGT	VISHAY SFERNICE
R44	1	49.9K	RESISTOR; 0603; 49.9K OHM; 1%; 100PPM; 0.10W; THICK FILM	CRCW060349K9FK;ERJ-3EKF4992V	VISHAY DALE;PANASONIC
R46, R47	2	4.7K	RESISTOR; 0603; 4.7K; 1%; 100PPM; 0.10W; THICK FILM	CRCW06034K70FK	VISHAY DALE
R50	1	1.4K	RESISTOR; 0603; 1.4K OHM; 1%; 100PPM; 0.1W; THICK FILM	CRCW06031K40FK	VISHAY DALE
R51	1	10	RESISTOR; 0603; 10 OHM; 0.1%; 10PPM; 0.063W; THICK FILM	RN73C1J10RBTG; 1614350-2	TE CONNECTIVITY; TE CONNECTIVITY
R52	1	13.3K	RESISTOR; 0603; 13.3K OHM; 1%; 100PPM; 0.1W; THICK FILM	CRCW060313K3FK;ERJ-3EKF1332V	VISHAY DALE;PANASONIC
R54	1	3.48K	RESISTOR; 0603; 3.48K OHM; 1%; 100PPM; 0.1W; THICK FILM	ERJ-3EKF3481	PANASONIC
R56	0	0	RESISTOR; 1206; 0 OHM; 0%; JUMPER; 0.25W; THICK FILM	CRCW12060000ZS;ERJ-8GEY0R00V	VISHAY DALE; PANASONIC
U1	1	MAX20446ATG/V+	EVKIT PART - IC; AUTOMOTIVE 6-CHANNEL BACKLIGHT DRIVER WITH BOOST/SEPIC CONTROLLER AND I2C INTERFACE; PACKAGE OUTLINE DRAWING NUMBER: 21-0139; LAND PATTERN NUMBER: 90-0022; PACKAGE CODE: T24444+4C	MAX20446ATG/V+	MAXIM
—	1	—	PCB: MAX20446 EVKIT_A	MAX20446EVKIT#	MAXIM

MAX20446 EV Kit Schematic

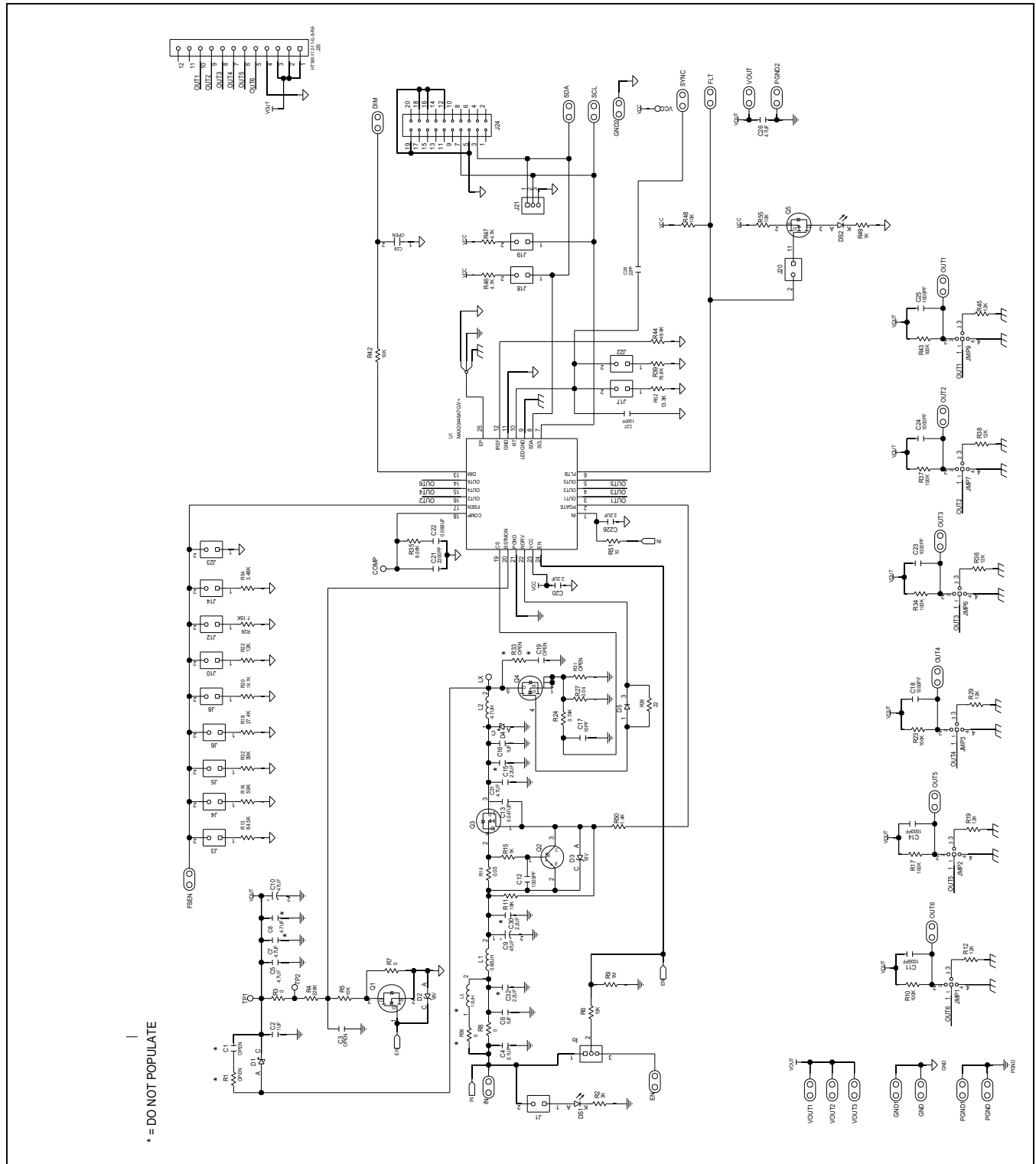

MAX20446 EV PCB Layouts

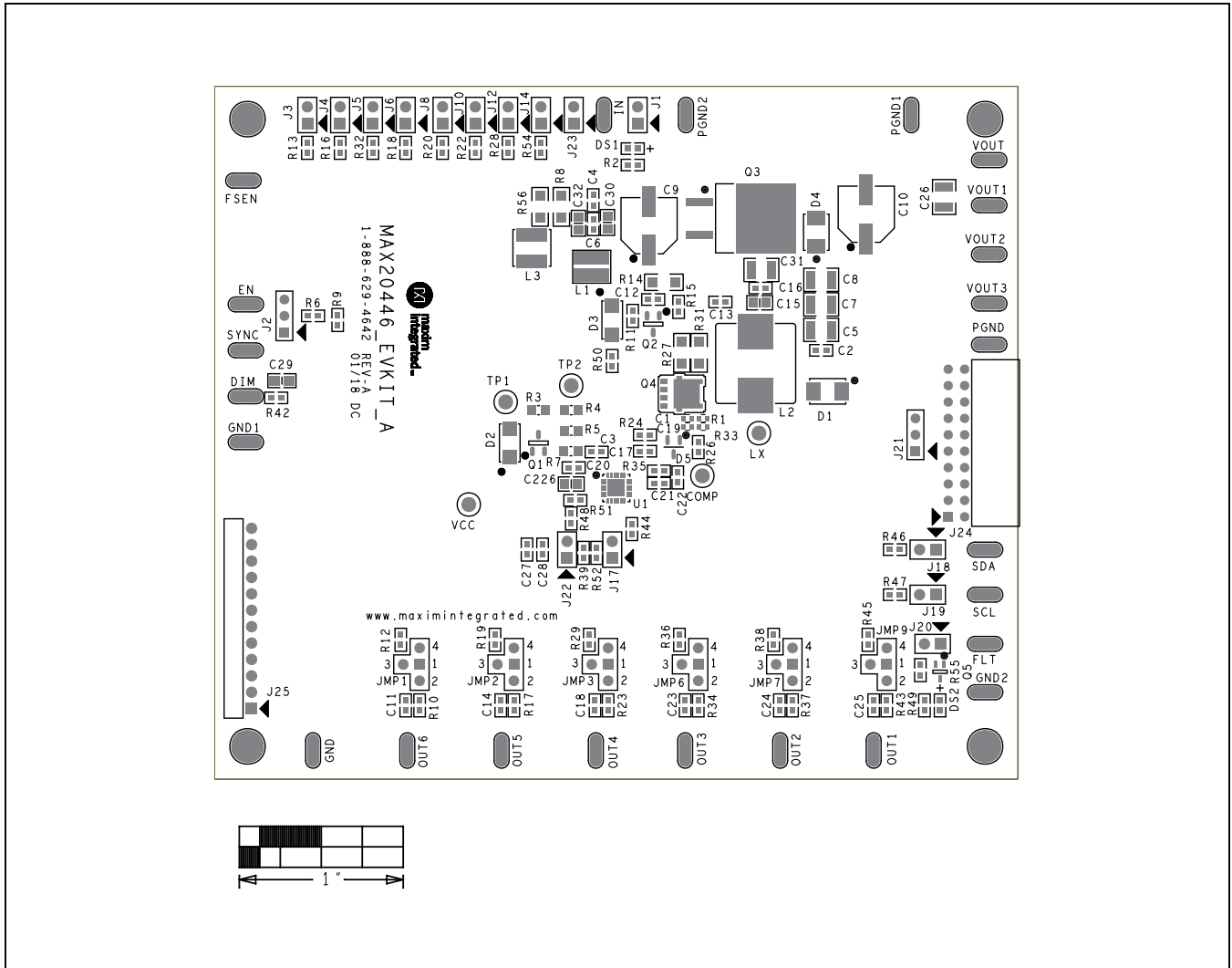

MAX20446 EV Kit Component Placement Guide—Top Silkscreen

MAX20446 EV PCB Layouts (continued)

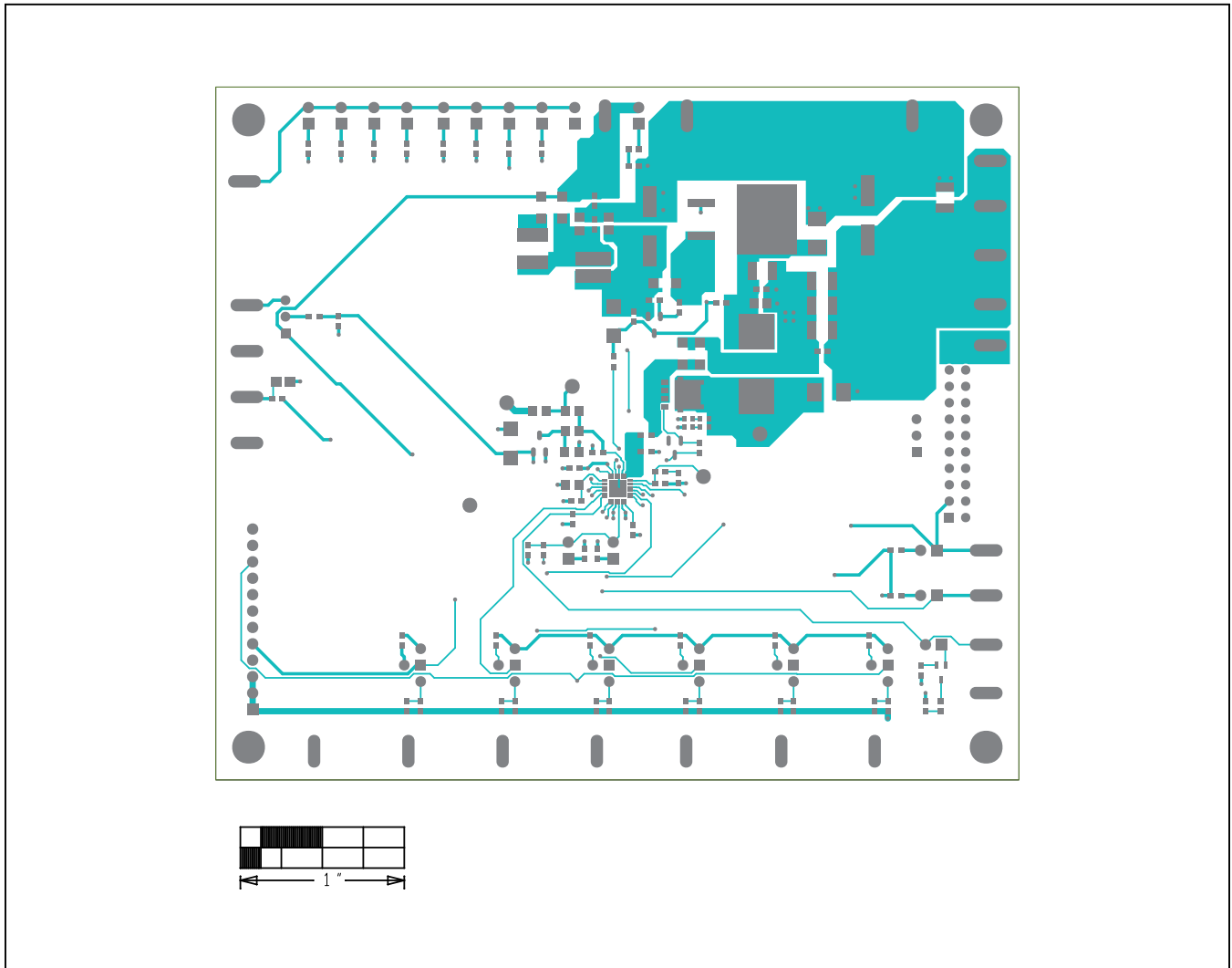

MAX20446 EV Kit PCB Layout—Top Layer

MAX20446 EV PCB Layouts (continued)

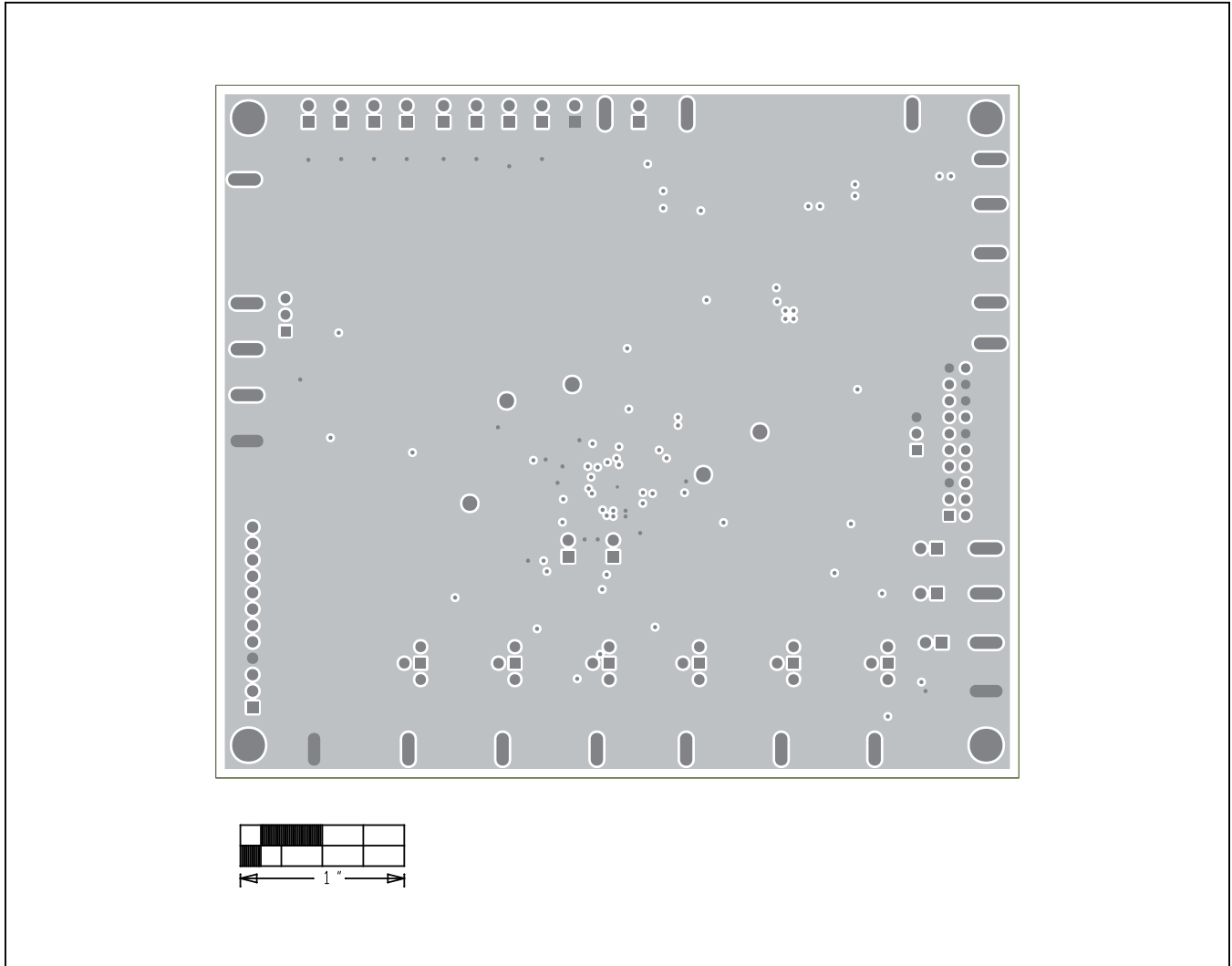

MAX20446 EV Kit PCB Layout—Bottom Layer

MAX20446 EV PCB Layouts (continued)

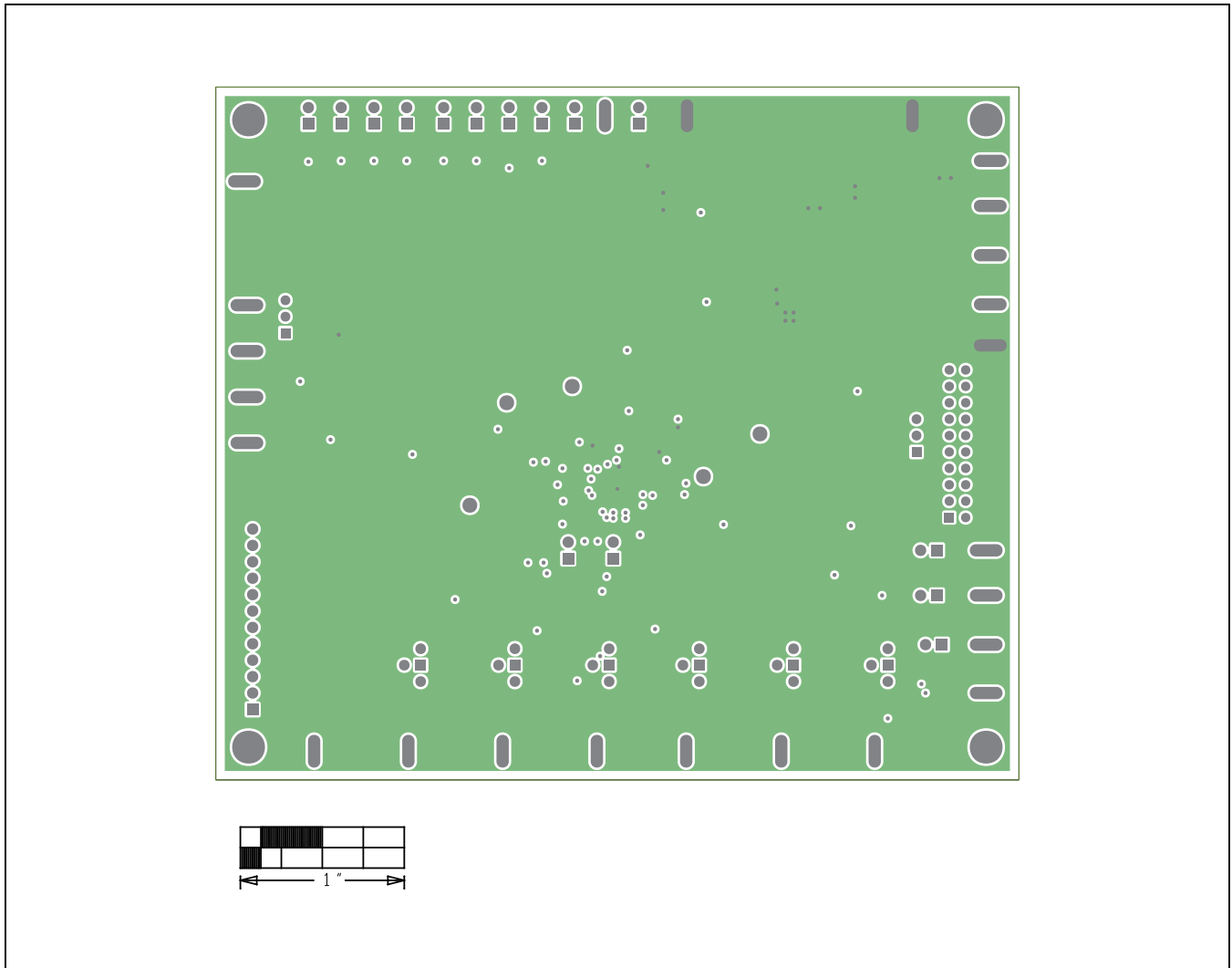

MAX20446 EV Kit PCB Layout—Layer 2

MAX20446 EV PCB Layouts (continued)

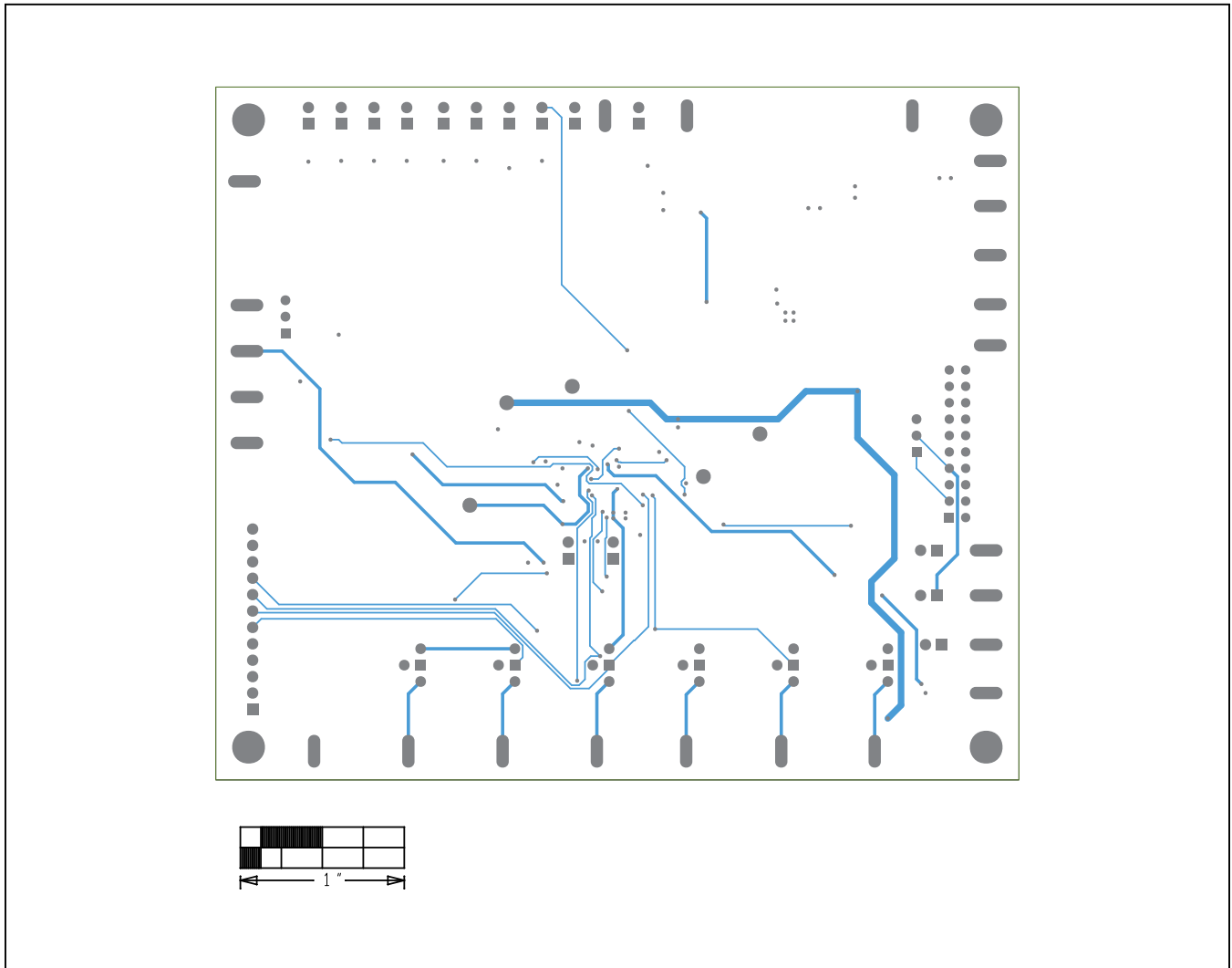

MAX20446 EV Kit PCB Layout—Layer 3

Revision History

REVISION NUMBER	REVISION DATE	DESCRIPTION	PAGES CHANGED
0	3/18	Initial release	—

For pricing, delivery, and ordering information, please contact Maxim Direct at 1-888-629-4642, or visit Maxim's website at www.maximintegrated.com.

Maxim Integrated cannot assume responsibility for use of any circuitry other than circuitry entirely embodied in a Maxim Integrated product. No circuit patent licenses are implied. Maxim Integrated reserves the right to change the circuitry and specifications without notice at any time. The parametric values (min and max limits) shown in the Electrical Characteristics table are guaranteed. Other parametric values quoted in this data sheet are provided for guidance.